

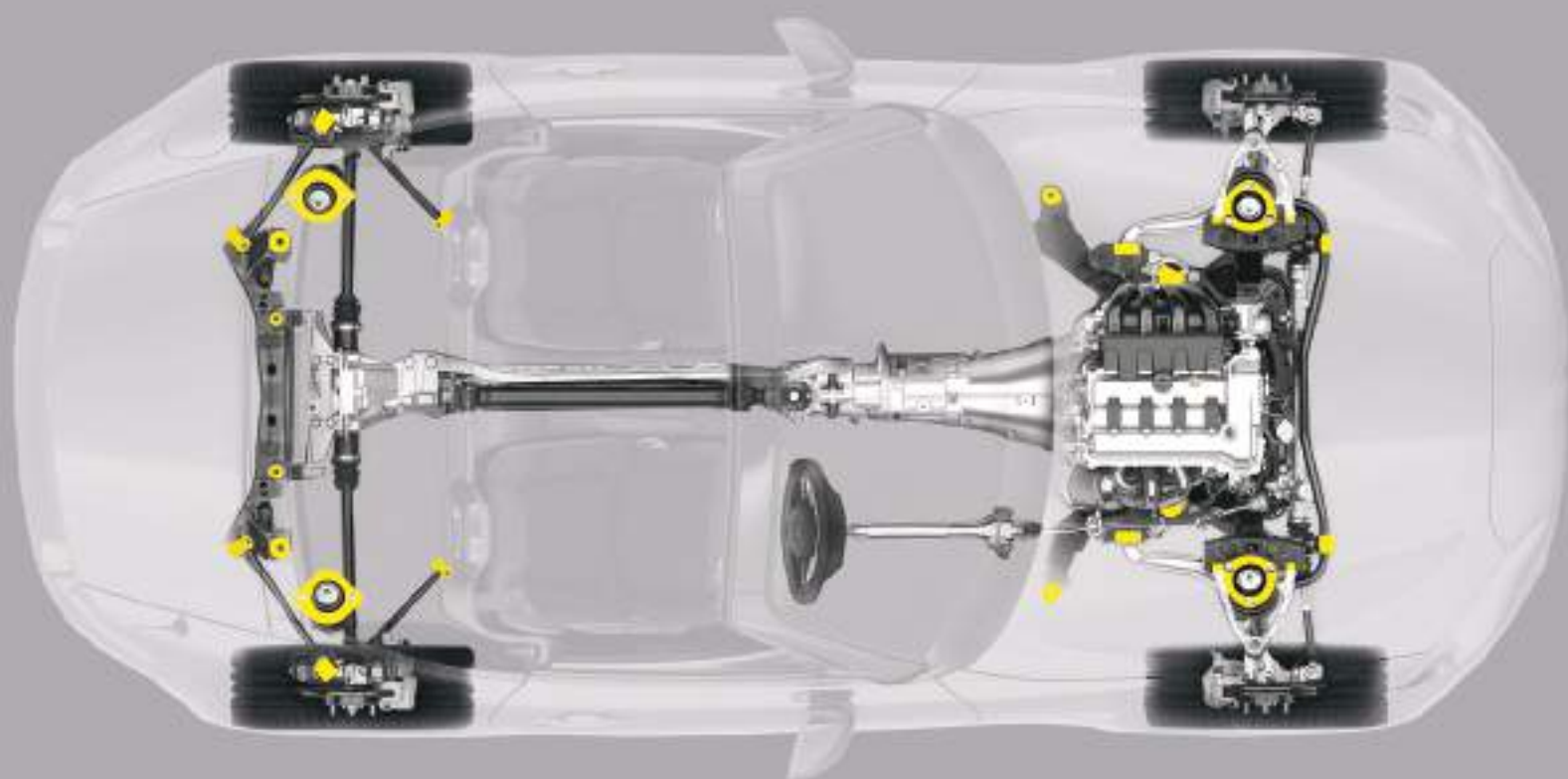

PARTQUIP
QUALITY GUARANTEED AUTO PARTS



2022



MOUNTINGS & RUBBER CATALOGUE

COPYRIGHT RESERVED



Important

The information listed here in is correct to the best of the Company's knowledge and belief, having been compiled from reliable and official sources of information.

However we cannot assume any responsibility for possible errors.

Please refer to your Partquip price list for parts currently available.

Notes:

This catalogue replaces all previous issues. For older vehicles not covered in this issue, please refer to previous issues or contact your nearest Partquip branch. While every effort has been made to ensure that the information in this catalogue is correct at the time of printing, Partquip cannot accept any responsibility for errors, which may occur.

Quality:

The manufacturing standards of all parts are very high and ensure the maximum degree of safety under all climatic conditions. It is necessary sometimes to manufacture parts that differ slightly in appearance from the old parts removed from a vehicle. In many cases these will be of improved, modern design and in all cases they will function as well as the parts replaced.

Guarantee:

All goods are guaranteed for 12 months from date of purchase against defects arising from faulty material or manufacture/workmanship. This guarantee does not extend to defects caused by wear and tear, neglect or accidental damage. All goods are sold with the understanding that we cannot accept liability for consequential personal injury, damage or loss as a result of the misuse or incorrect fitment of our products.

General:

All parts listed, sold or supplied are offered and sold as parts for replacement only. Vehicle or manufacturer names, descriptions, symbols and numbers listed in this catalogue are used for reference purposes only.

The contents of this catalogue are protected by copyright.

Unlawful use of the contents will result in prosecution.

© COPYRIGHT 2022

All rights reserved. No part of this book may be reproduced or transmitted in any form or by any means, electronic or mechanical, including photocopying, or by any information storage or retrieval system, without permission from the copyright holder.



Engine Mounting & Rubber Catalogue 2022

INDEX PAGE

HELPFUL INFORMATION

Rubber Bush Identification Chart	I
Typical Engine Mounting & Shackle Bush Layouts	II
3D View of a FWD Engine Mounting Layout	III
Typical Front Suspension Rubber Layouts	IV
Rear Suspension Layouts	V - VI
Ford Cortina Front & Rear Suspension Layout	VII

APPLICATION SECTION

VEHICLE MANUFACTURERS	PAGE NUMBERS
Miscellaneous	1 - 2
Audi	3 - 8
BMW	9 - 26
C.A.M & Chana	27
Chery, Chevrolet & Chrysler	28 - 31
Citroen	32 - 35
Daewoo, Daihatsu, Dodge	36 - 39
Fiat	40 - 42
Ford	43 - 53
Foton, GoNow, GWM	54 - 55
Honda	56 - 60
Hyundai	61 - 70
Isuzu, Jinbei	71 - 73
Jeep	74 - 75
Kia	76 - 80
Land Rover, Mahindra	82 - 89
Mazda	90 - 91
Mercedes-Benz	92 - 99
Mitsubishi	100 - 103
Nissan	104 - 117
Opel	118 - 123
Peugeot	124 - 128
Renault	129 - 136
Seat, Suzuki	137 - 139
TATA	140
Toyota	141 - 169
Volkswagen	170 - 182
Volvo	183 - 186

BUYERS GUIDE

AR1000 - AR4999	187 - 208
AR5000 - AR5999	209 - 243
AR6000 - AR6999	244 - 286
AR7000 - AR7999	287 - 321
AR8000 - AR8999	322 - 363
AR9000 - AR9999	364 - 399

Rubber Bush Identification Chart

The pictures shown are representative of the parts required and are not necessarily a true resemblance of the actual part you are looking for.

The dimensions are shown to indicate where measurements are taken.

Since bushes have different shapes and sizes, the area where measurements are taken will differ from part to part.

ID = Inner Diameter

OD = Outer Diameter

L = Length

H = Height

W = Width

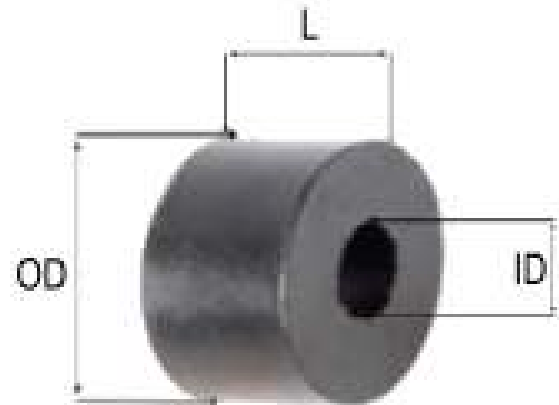

Typical Engine Mounting & Shackle Bush Layouts

Key to Engine Mounting Positions

1. Front Engine Mounting
2. Rear Engine Mounting
3. Left Engine Mounting

4. Right Engine Mounting
5. Transmission Mounting

Inline Engine

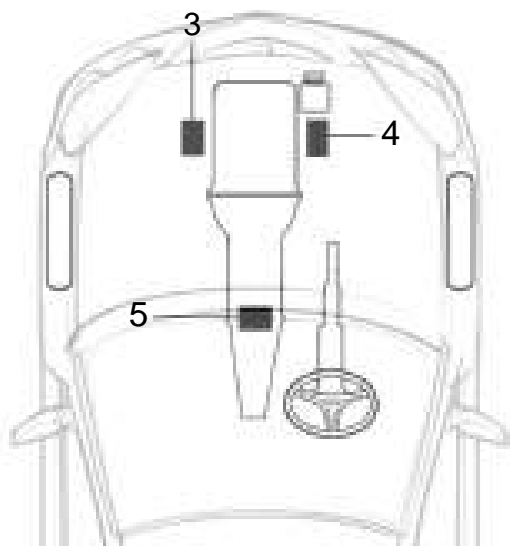

Transverse Engine

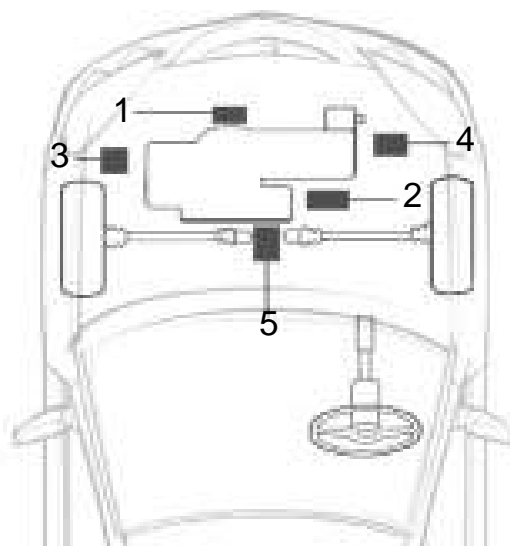

Key to Shackle Pin Bush Positions

1. Front Upper Shackle Pin Bush
2. Front Lower Shackle Pin Bush

3. Rear Upper Shackle Pin Bush
4. Rear Lower Shackle Pin Bush

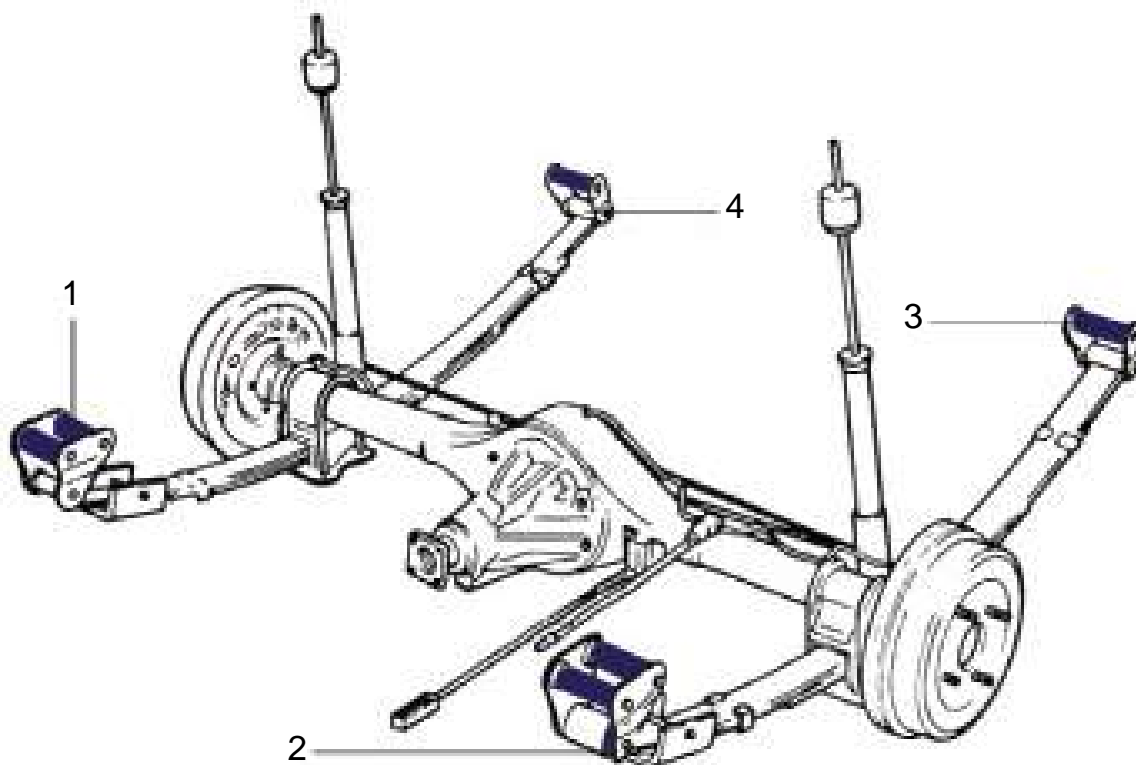

3D View of a FWD Engine Mounting Layout

- 1. Front Engine Mounting
- 2. Rear Engine Mounting
- 3. Right Engine Mounting

- 4. Left Engine Mounting
- 5. Transmission Mounting

Transverse Engine

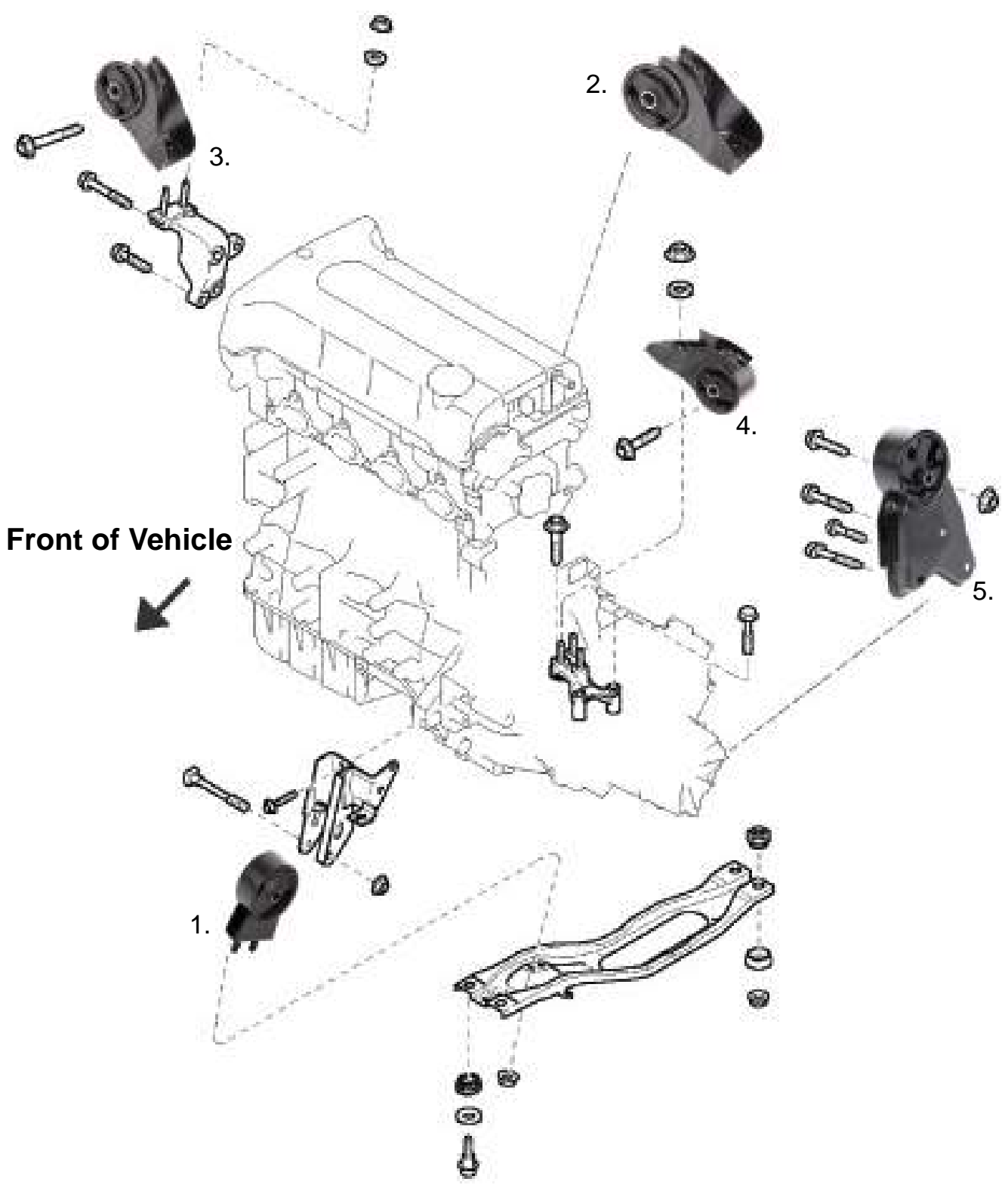

Typical Front Suspension Rubber Layouts

Key to Suspension Bush Positions

1. Shock Absorber Bush
2. Upper Control Arm Bush
3. Lower Control Arm Bush

4. Tension Rod Bush
5. Stabilizer Bar Bush
6. Stabilizer Link Grommet
7. Strut Mounting

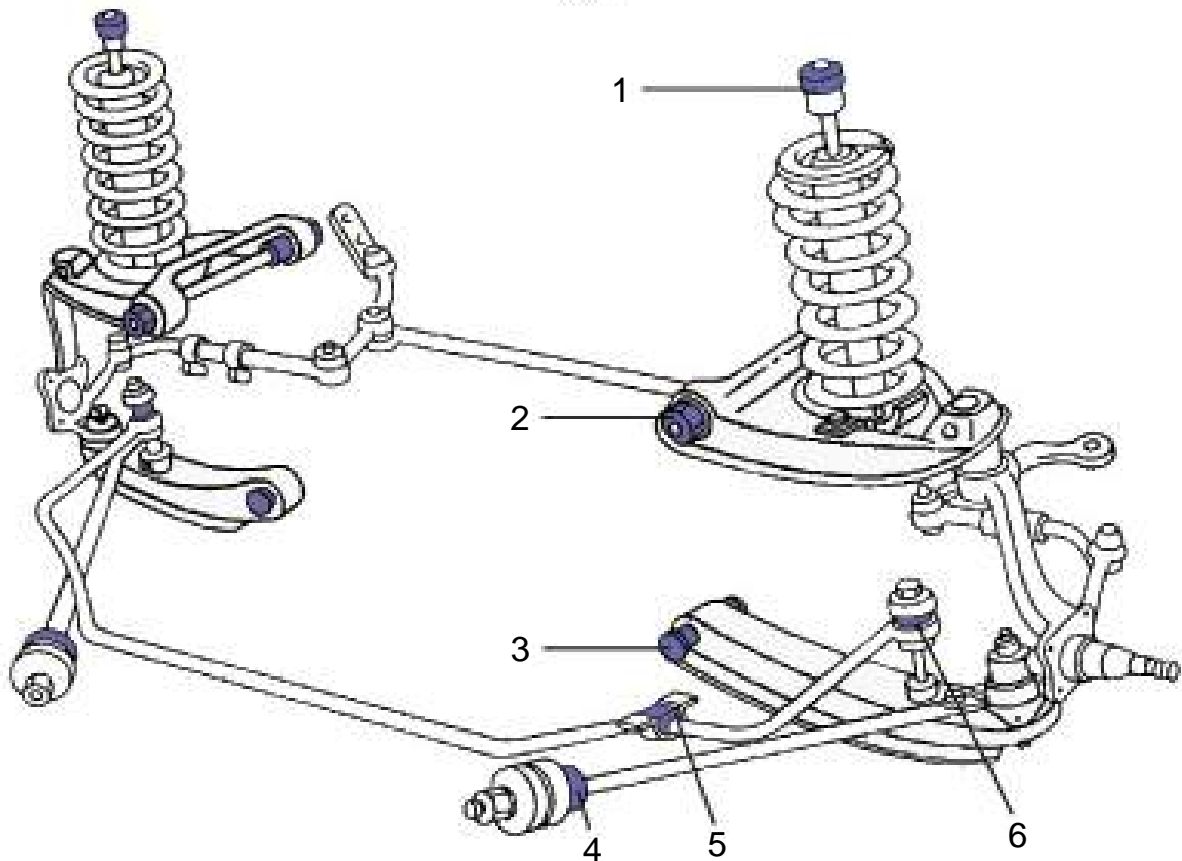
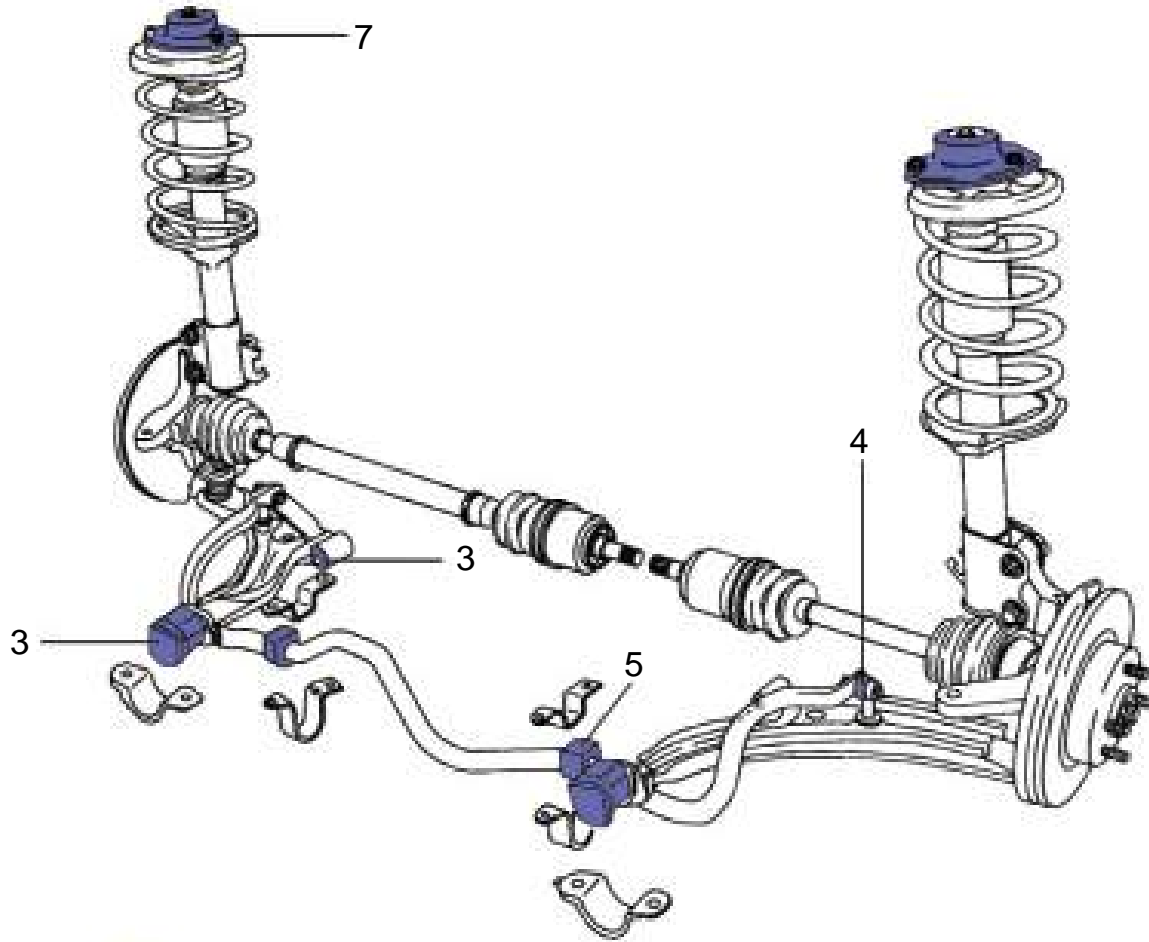

Rear Suspension Layouts

**Ford Laser, Meteor,
Mazda 323
Early models**

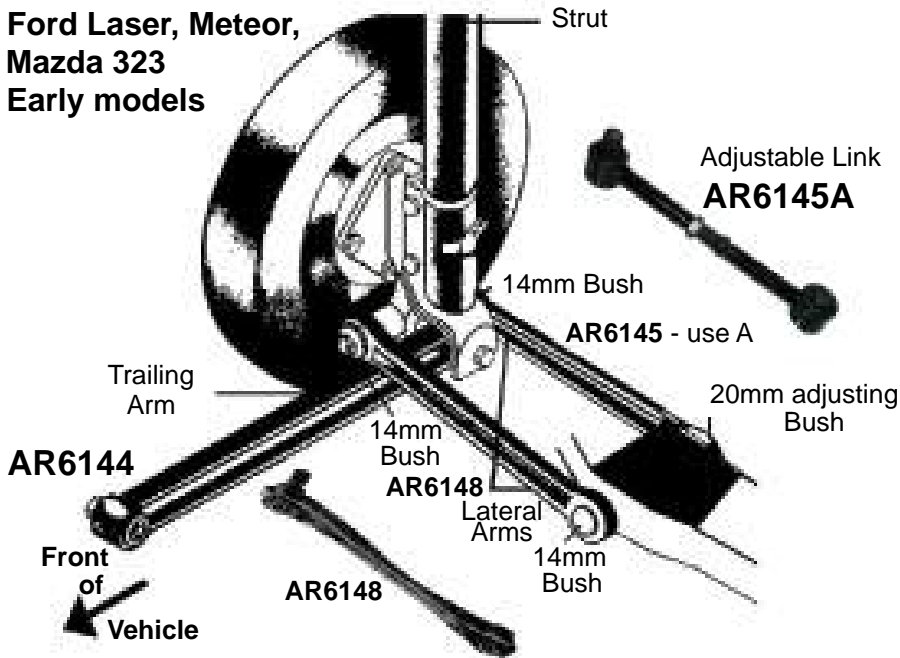

**Ford Laser/ Meteor,
Mazda 323, 626 (83-92)
Rear suspension layouts**

**Mazda 323
Late models**

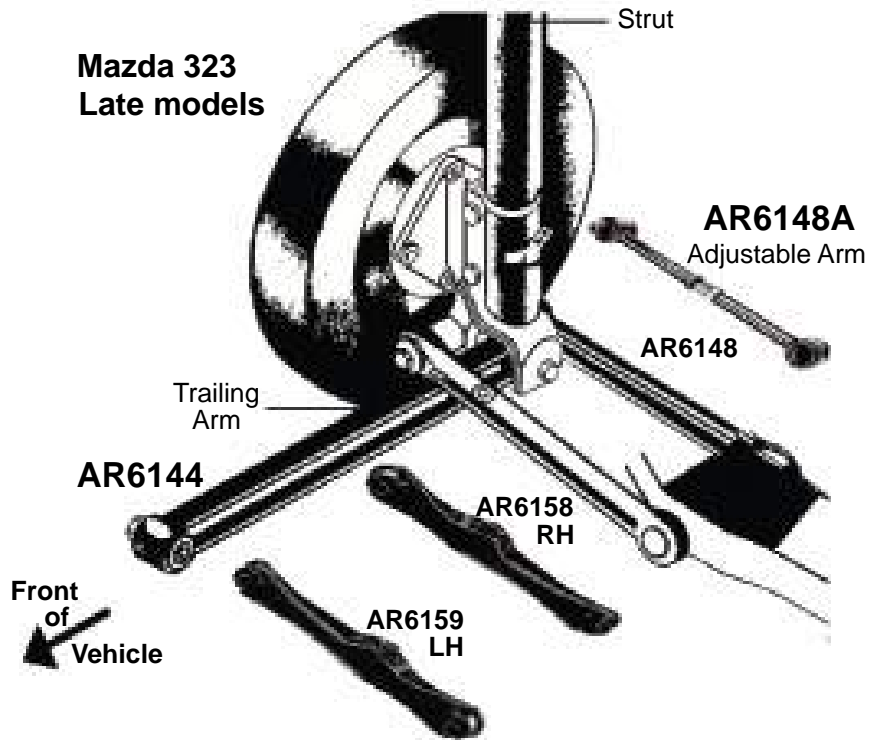

**Mazda 626
-92**

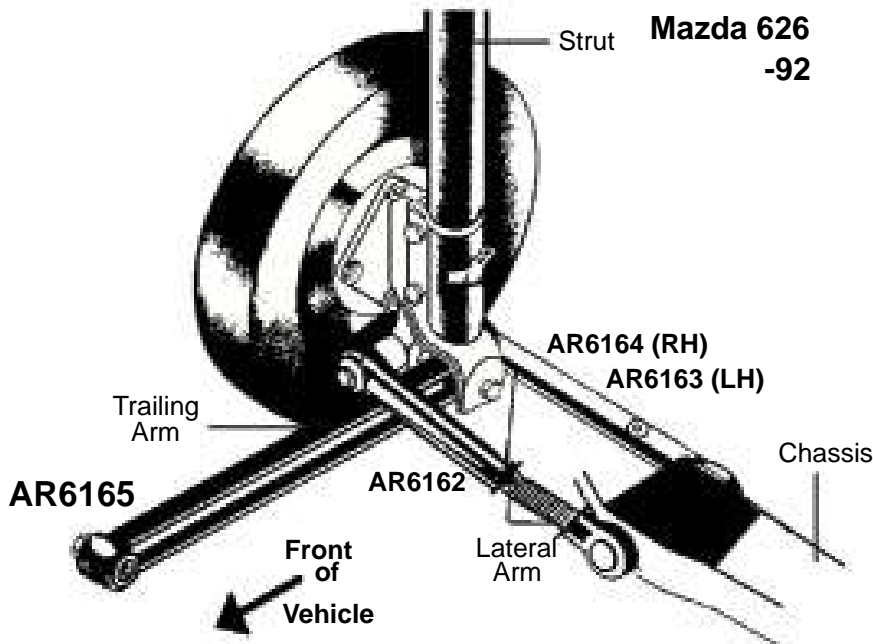

Rear Suspension Layouts

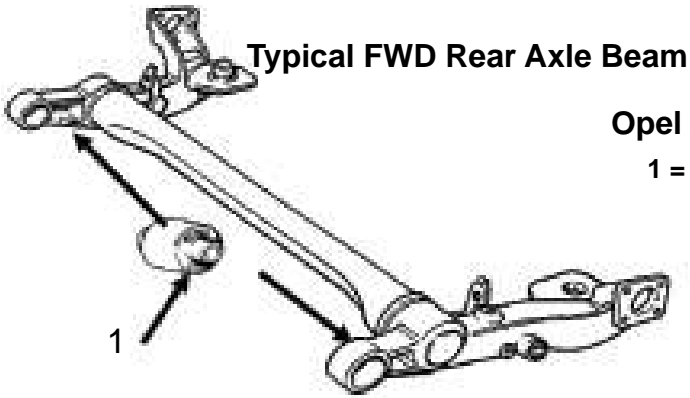

Opel Astra, VW Golf/ Jetta

BMW E23, E28

- 1 = Rear Carrier Bush
- 2 = Rear Carrier Bush

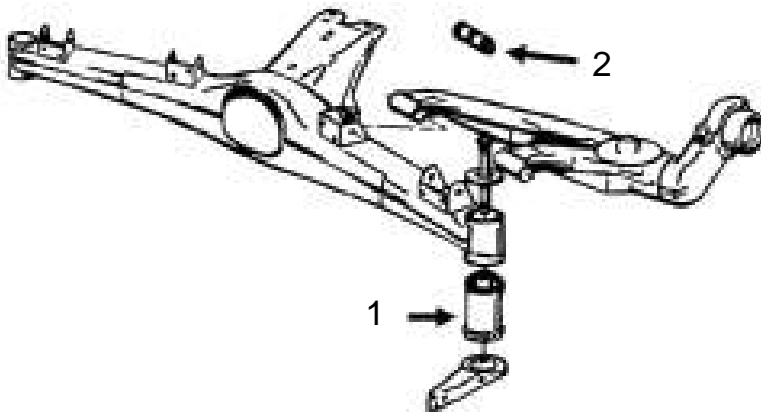
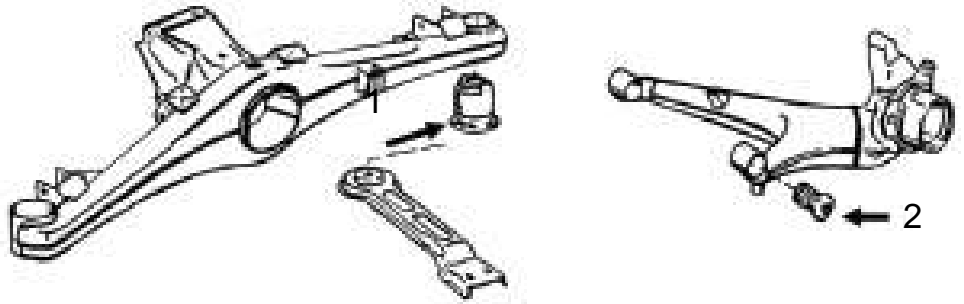

BMW E30

- 1 = Rear Carrier Bush
- 2 = Trailing Arm Bush

BMW E32, E34

- 1/2 = Trailing Arm Bushes
- 3 = Rear Carrier Rear Bush
- 4 = Rear Carrier Front Bush

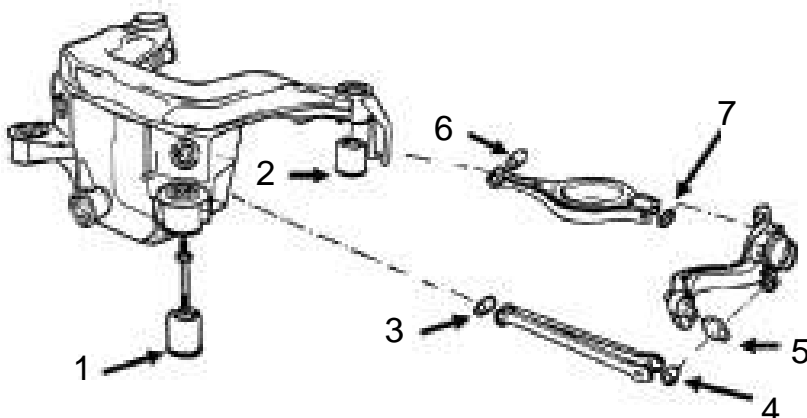
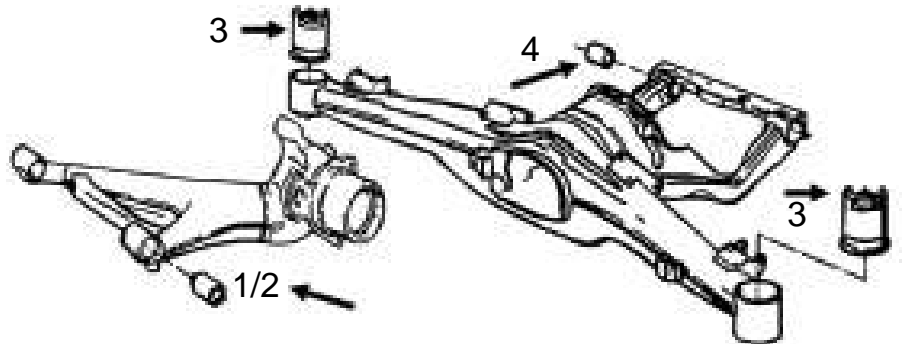

BMW E36

- 1 = Rear Carrier Front Bush
- 2 = Rear Carrier Rear Bush
- 3 = Lower Lateral Link Inner Bush
- 4 = Lower Lateral Link Outer Bush
- 5 = Trailing Arm Bush
- 6 = Upper Lateral Link Inner Bush
- 7 = Upper Lateral Link Outer Bush

Ford Cortina Front & Rear Suspension Layout

Ford Cortina MK III & IV - Front

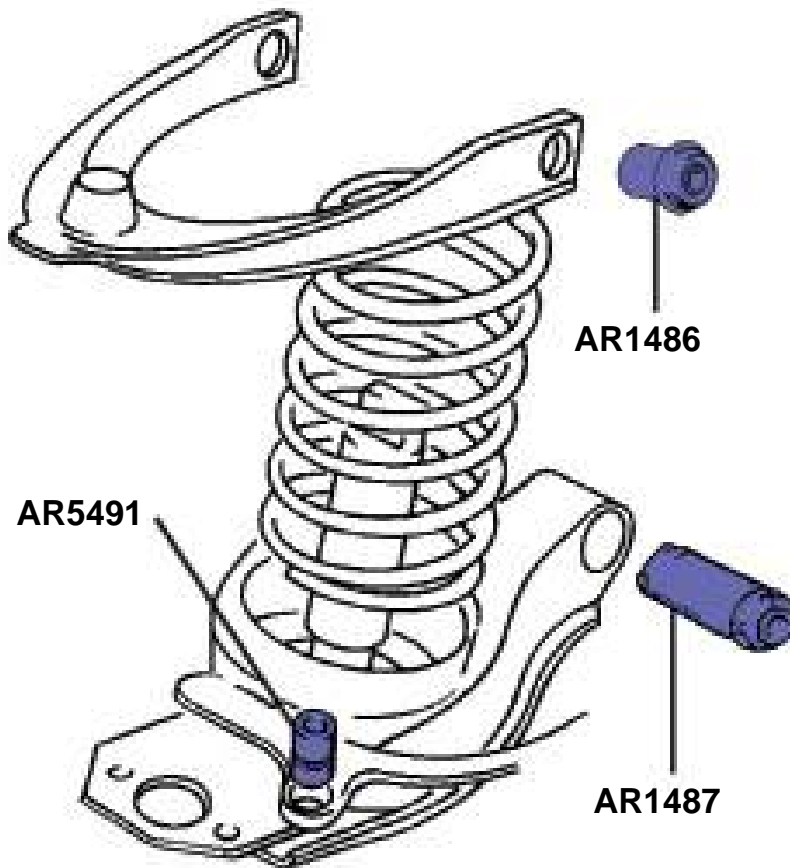

Ford Cortina MK III & IV - Rear

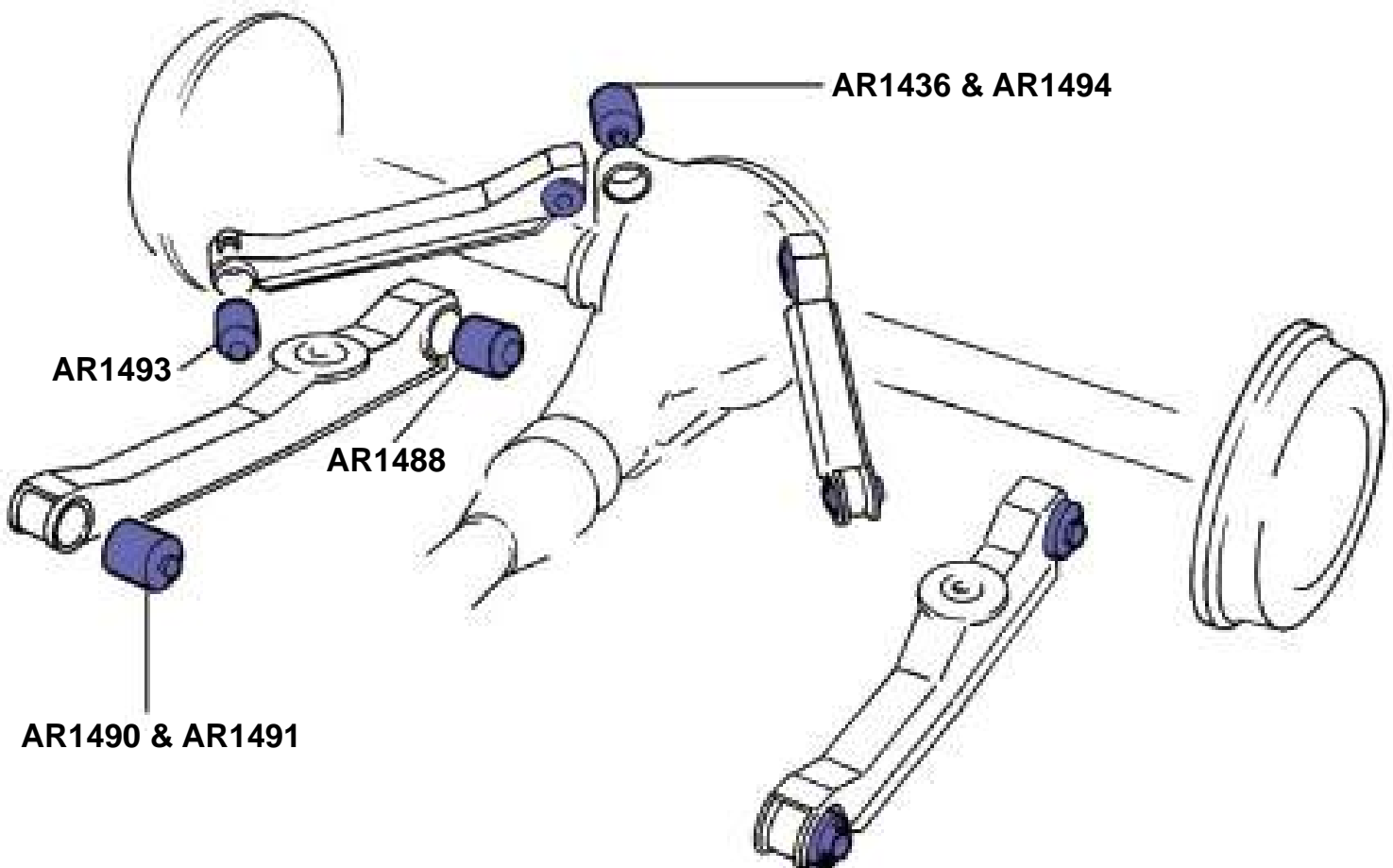

MISCELLANEOUS

OLD & UNIVERSAL PARTQUIP NUMBERS

PART NUMBER	PART DESCRIPTION	VEHICLE APPLICATION
AR1001	Engine Mounting - Front	Volkswagen Beetle - All Modesl (61-79)
AR1024	Steering Coupling	Peugeot 404 (63-80), 504 (71-85), 505 (80-85)
AR120	Engine Stabilizer Rubber	Leyland Mini (65-84)
AR122	Exhaust Hanger - Rear	Leyland Mini (66-84)
AR1391	Engine Mounting - RHS	Renault R5 (75-85)
AR1419	Engine Mounting - RHS	Mazda 323 1.3, 1.4 (77-81)
AR2011	Exhaust Hanger - Middle & Rear	Ford Cortina MkI, MkII (62-71), Escort (68-80)
AR2039	Universal Mounting	Various Makes & Models
AR3032	Engine Mounting - L/RHS	Audi 80 1.5 GL, 1.6 (75-78); Volkswagen Passat 1.3, 1.5, 1.6, 1.8, 1.9, 2.2 (74-87)
AR32	Stabilizer Bar Bush / Grommet	Various Makes & Models
AR351	Engine Mounting - L/RHS	Leyland Mini - All Models (59-84)
AR49	Distributor Caps	Various Makes & Models
AR5001	Bonnet Clips	Various Makes & Models
AR5055	Exhaust Hanger - Front	Renault R5 1.3,1.4 (68-85)
AR5060	Shacke Bush - Rear Upper	Mazda B-Series B1600, B1800 (75-79)
AR5063	Shackle Bush - Rear	Toyota Land Cruiser 3.6, 3.9, 4.2 P/up (69-80)
AR5064	Shackle Bush - Rear Lower	Toyota Land Cruiser 3.6, 3.9, 4.2 P/up (69-80)
AR5080	Shackle Bush	Various Makes & Models
AR5088	Tension Rod Bush	Nissan 1200, 1400 (71-80)
AR5089	Tension Rod Bush	Nissan 1600, 160U, 160Y, 160Z (69-78), 1800, 1800J, 180U (69-80), Pulsar 1.3 (69-86)
AR5133	Exhaust Hanger	Opel Kadett 1.2, 1.3, 1.6, 1.8 (80-85)
AR5207	Enigne Mounting - L/RHS	Mazda 323 1.6 (79-81)
AR5245	Exhaust Hanger	Opel Kadett 1.2 L, 1.3 GL, GLS, 1.6 (80-85)
AR5303	Engine Mounting - RHS	Nissan Langley 1.3, 1.5, Exa Turbo (85-88), Pulsar 1.3, 1.5 (83-85)
AR5304	Engine Mounting - Rear	Nissan Langley 1.3, 1.5, Exa Turbo (85-88), Pulsar 1.3, 1.5 Man. (83-85)
AR5310	Centre Bearing Rubber	Toyota Hilux 1.5, 1.6, 2.0, 2.2 (69-86)
AR5324	Steering Rack Mounting	Ford Cortina MkV 1 Tonner 1.6, 2.4D, 3.0 (80-86)
AR5334	Transmission Mounting	Toyota HiAce 1.5, 1.6, 2.0 (69-84), Hilux 1.5, 1.6 (69-72)
AR5336	Engine Mounting - LHS	Toyota HiAce 1.5 Bus, P/van, 1.6 P/van, Bus, Super10 (69-76), Hilux 1.5, 1.6 (69-72)
AR5345	Front Lower Control Arm Bush - Inner & Outer	Mazda B-Series B1600, B2000, B2200 (83-86)
AR5346	Front Stabilizer Bar Bush	Mazda 323 1.3 GLC, 1.4, 1.6 (77-81), B-Series B1600, B1800, B2000, B2200 (77-86)
AR5360	Engine Mounting - L/RHS	Toyota Land Cruiser 3.9, 4.2 (69-79)
AR5361	Engine Mounting - L/RHS	Toyota Land Cruiser 4.2 (80-87)
AR5365	Transmission Mounting	Toyota Cressida 2.0 (81-83)
AR5385	Front Lower Control Arm Bush - Inner	Nissan Langley 1.3, 1.5, Exa Turbo (85-88), Pulsar 1.3, 1.5 (83-85)
AR5395	Engine Mounting - LHS	Volkswagen Beetle 1.2, 1.3, 1.5, 1.6 (61-79)
AR5396	Engine Mounting - RHS	Volkswagen Beetle 1.2, 1.3, 1.5, 1.6 (61-79)
AR5793	Upper Control Arm Bush - Front	Renault R5 1.3, 1.4 (75-85), R9 1.4, 1.7 (83-86)

MISCELLANEOUS OLD & UNIVERSAL PARTQUIP NUMBERS

AR5890	Lower Control Arm Bush - Front	Nissan Langley 1.3, 1.5 Exa, Trebon (85-88), Pulsar 1.3, 1.5 (83-85)
AR5893	Lower Control Arm Bush - Rear	Nissan Langley 1.3, 1.5 Exa (85-88), Pulsar 1.3, 1.5 (83-85)
AR5911	Tension Rod Bush	Nissan 200 (78-80), 280 (79-80), Laurel 2.0, 2.8 (78-85), Skyline 1.8, 2.0, 2.8 (82-86)
AR6032	Front Stabilizer Bar Bush	Toyota Cressida 1.8, 2.0 (77-81)
AR6365	Tension Rod Bush	Toyota Cressida (TX62, YX70) 1.8 L, LS, (RX60, RX62) 2.0 GL, S/W, GLE, GX60 GLi6, GLX, (MX63) 2.8i (81-89)
AR6376	Front Strut Mounting - RHS	Toyota Cressida 1.8 L, LS, 2.0 GL, S/W, GLE, GLi6, 2.8i (83-86)
AR6377	Front Strut Mounting - LHS	Toyota Cressida 1.8 L, LS, 2.0 GL, S/W, GLE, GLi6, 2.8i (83-86)
AR6505	Centre Bearing Rubber	Mercedes-Benz (W123) E-Class 200, 230E, 230S, 240D, 250, 280E, 300D (77-86), (C107) S-Class 450 SL, SL (76-80)
AR6525	Front Lower Control Arm Bush - Inner	Mazda 323 1.3, 1.4, 1.6 (79-81)
AR6528	Front Lower Control Arm Bush - Outer	Mazda 323 1.3, 1.4, 1.6 (79-81)
AR6625	Engine Mounting - RHS	Mercedes-Benz (W123) E-Class 230S, 250, 280E, 300D (77-86)
AR6626	Engine Mounting - LHS	Mercedes-Benz (W123) E-Class 230S, 250, 280E, 300D (77-86)
AR6630	Upper Control Arm Bush - Front	Mercedes-Benz (W123) E-Class 200, 230E, 230S, 240D, 250, 280E, 300D (77-86)
AR672	Engine Mounting - L/RHS	Ford Capri - All Models (69-73)
AR7048	Engine Mounting - L/RHS	Volkswagen Passat 1.5, 1.6 Auto. (74-85)
AR93	Shock Rubber	Audi 100 2.1 5E, 5S (78-84), 500 2.1 e, 2.2, SE, Turbo (83-93)

APPLICATIONS	AUDI	AUDI A1	AUDI A3	AUDI A3	AUDI A3
		1.0 TFSi 70kw 5-Spd. Man., 6-Spd. Auto. - CHZB 1.2 TFSi 63kw 5-Spd. Man. - CBZA 1.4 TFSi 90kw 6-Spd. Man., 7-Spd. S-Tronic - CAXA 1.4 TFSi 92kw 5-Spd. Man. - CZCA, CZDD 1.4 TFSi 136kw 7-Spd. S-Tronic - CAVG 1.6 TDi - CAYC 1.8 TFSi 141kw 7-Spd. S-Tronic - DAJB	1.8 - AGN 1.8T - AGU, BFU	2.0 FSi - BVZ 2.0 TDi - BMM, CLJA	2.0 TFSi - CBFA, CCZA 3.2 Quattro - BUB
YEARS		11-18	98-04	03-13	04-13
Engine Configuration		INLINE	TRANSVERSE	TRANSVERSE	TRANSVERSE
Engine Mounting - Front					
Engine Mounting - Rear		AR7066 (1.4 - 90kw, 136kw) AR8255 (1.4 - 92kw) AR9899 (1.0 Man.) AR9900 (1.0 Auto., 1.6) AR9969 (1.2)	AR7044	AR6896 (Man.) AR6898 (Auto.)	AR6896 (Man.) AR6898 (Auto.)
Engine Mounting - Left					
Engine Mounting - Right		AR7014 (1.0 Auto., 1.4, 1.8) AR9901 (1.0 Man., 1.6)	AR7019	AR6929 (TDi) AR8042 (FSi)	AR8042
Engine Mounting - Other				AR6908 Upper Subframe Bush AR6909 Lower Subframe Bush	AR6908 Upper Subframe Bush AR6909 Lower Subframe Bush
Transmission Mounting		AR6916	AR7021	AR7010 - LHS (TDi) AR7222 - LHS (FSi)	AR7010 - LHS (3.2) AR7222 - LHS
		FRONT SUSPENSION			
Upper Control Arm Bush - Inner					
Upper Control Arm Bush - Outer					
Lower Control Arm Bush - Inner		AR5413 - Front	AR5413 - Front	AR6899 - Front	AR6899 - Front
Lower Control Arm Bush - Outer		AR6417 - Rear	AR6417 - Rear	AR6883 - Rear LHS AR6884 - Rear RHS	AR6883 - Rear LHS AR6884 - Rear RHS
Stabilizer Bar Bush		AR7009 (ID: 18mm)	AR7022 (ID: 17mm) to 8L-W-001 701 AR7023 (ID: 20mm) from 8L-W-001 702		
Stabilizer Link Grommet					
Steering Rack Mounting			AR7024	AR8250	AR8250
Strut Mounting		AR7025	AR7025	AR7129 (Excluding Bearing) AR7129B (Including Bearing)	AR7129 (Excluding Bearing) AR7129B (Including Bearing)
Miscellaneous		AR8920 Stabilizer Link - L/RHS	AR7029 X-Member Bush AR8920 Stabilizer Link - L/RHS		
		REAR SUSPENSION			
Exhaust Hanger - Middle				AR9690	AR9690
Exhaust Hanger - Rear			AR7005	AR9690	AR9690
Lower Control Arm Bush - Inner				AR6873	AR6873
Lower Control Arm Bush - Outer				AR6901	AR6901
Stabilizer Bar Bush			AR7028	AR8252	AR8252
Strut Mounting		AR7026	AR7027	AR8041	AR8041
Miscellaneous		AR6930 Rear Axle Upper Inner Bush - L/RHS AR6931 Rear Axle Upper Outer Bush - L/RHS AR6957 Rear Axle Lateral Link Bush - Outer AR6958 Rear Axle Lateral Link Bush - Inner AR6962 Rear Axle Trailing Link Bush - L/RHS	AR7102 Rear Axle Beam Bush	AR6930 Rear Axle Upper Inner Bush - L/RHS AR6931 Rear Axle Upper Outer Bush - L/RHS AR6957 Rear Axle Lateral Link Bush - Outer AR6958 Rear Axle Lateral Link Bush - Inner AR6962 Rear Axle Trailing Link Bush - L/RHS	AR6930 Rear Axle Upper Inner Bush - L/RHS AR6931 Rear Axle Upper Outer Bush - L/RHS AR6957 Rear Axle Lateral Link Bush - Outer AR6958 Rear Axle Lateral Link Bush - Inner AR6962 Rear Axle Trailing Link Bush - L/RHS

APPLICATIONS	AUDI A3 1.4 TFSi - CMSA 1.6 TDi - CAYC 1.8 TFSi - CDAA 1.9 TDi - BXE 2.0 TDi - CLJA	AUDI A3 1.2 TFSi - CJZA, CCJZ 1.4 TFSi - CXSA 1.6 TDi - CLHA 1.8 TFSi - CJSA, CJSB 2.0 TDi - DAGA	AUDI A3 1.4 TFSi - CZCA, CZEA 2.0 TDi - CRFC	AUDI A4 (8D2, B5) 1.8T Avant, Multitronic, SW - APU
YEARS	08-13	12-17	13-17	95-01
Engine Configuration	TRANSVERSE	TRANSVERSE	TRANSVERSE	INLINE
Engine Mounting - Front	AR7020 Buffer			AR7020 Buffer
Engine Mounting - Rear	AR6898 (1.6, 1.8) AR9743 (1.4)	AR6896 (1.2, 1.4) AR6898 (1.8) AR9897 (1.6)	AR6896 AR8912 - Alt.	
Engine Mounting - Left	AR7060			AR7060
Engine Mounting - Right	AR6929 (1.4) AR7060 AR8042 (1.6, 1.8)	AR8042 (1.8) AR8911 (1.6) AR9633 (1.2, 1.4)	AR6929 AR8911 (1.4)	AR7060
Engine Mounting - Other	AR6908 Upper Subframe Bush AR6909 Lower Subframe Bush	AR6908 Upper Subframe Bush AR6909 Lower Subframe Bush AR9635 (1.4, 1.6) Upper & Lower Subframe Bush	AR6908 Upper Subframe Bush AR6909 Lower Subframe Bush AR9635 (2016-) Upper & Lower Subframe Bush	
Transmission Mounting	AR7010 - LHS (1.8) AR7058 - LHS (Man.) AR7065 - LHS (Auto.) AR7065 - RHS (Man./Auto.) AR7222 (1.4, 1.6)	AR7010 (1.8) AR8910 (1.6) AR9634 (1.2, 1.4)	AR7222 AR8910 (2016-) AR9748 (2.0)	AR7058 - LHS (Man.) AR7065 - LHS (Auto.) AR7065 - RHS (Man./Auto.)
FRONT SUSPENSION				
Upper Control Arm Bush - Inner	AR7072 - Front & Rear			AR7072 - Front & Rear
Upper Control Arm Bush - Outer				
Lower Control Arm Bush - Inner	AR6899 (1.4, 1.6) AR7068 - Front AR7069 - Rear	AR6899 - Front	AR6899	AR7068 - Front AR7069 - Rear
Lower Control Arm Bush - Outer	AR6883 (1.4, 1.6) AR6884 (1.4, 1.6) AR7177 - Front	AR9686	AR9686	AR7177 - Front
Stabilizer Bar Bush	AR7174			AR7174
Strut Mounting	AR7071 AR7129 (1.4, 1.6, 1.8)	AR8909	AR8909	AR7071
Miscellaneous	AR8250 (1.4, 1.6) Steering Rack Mounting	AR8250 Steering Rack Mounting		AR7188 Rear Subframe Bushes - Rear AR7189 Rear Subframe Bushes - Front AR7189 Engine Carrier Bush - Front AR8015 Engine Carrier Bush - Rear
REAR SUSPENSION				
Exhaust Hanger		AR9690 - Front & Centre AR9692 - Rear		
Lower Control Arm Bush - Inner				
Lower Control Arm Bush - Outer	AR6901			
Stabilizer Bar Bush	AR8252 (1.4, 1.6, 1.8)	AR8252		
Strut Mounting	AR8041	AR8041		
Miscellaneous	AR6957 Rear Axle Lateral Link Bush - Outer AR6958 Rear Axle Lateral Link Bus - Inner AR6962 Rear Axle Trailing Arm Bush - L/RHS AR7043 Rear Axle Beam Bush	AR6957 Rear Axle Lateral Link Bush - Outer AR6958 Rear Axle Lateral Link Bush - Inner AR6962 Rear Axle Trailing Arm Bush - L/RHS AR8905 Rear Axle Beam Bush	AR6957 Rear Upper Control Arm Bush - Outer AR6958 Rear Upper Control Arm Bush - Inner AR9749 Rear Axle Beam Bush - Front AR9750 Rear Axle Beam Bush - Rear AR9687 Rear Track Arm Bush - Outer AR9688 Rear Track Arm Bush - Inner	AR7043 Rear Axle Beam Bush

APPLICATIONS	AUDI A4 (8E2/5, B6) 1.8T Avant, Multitronic, SW - BFB 1.9 TDi Avant - AVF, AWX 2.0 Executive - ALT 2.0 TFSi - BGB 2.0 TDi - BLB 2.0 TDi - BLB	AUDI A4 1.8 TFSi - CABA/B, CDHA/B, CJEB 2.0 TDi - BRD, CAGA, CJCA, CMEA, CMFA 2.0 TFSi - CABE, CDNC, CGLC, CMGB 2.0 TFSi Quattro - CDNC, CPMA	AUDI A4 2.0 TFSi, Quattro - CAEB, CDNC, CGLC, CMGB 2.0 TFSi Multitronic, Quattro	AUDI A4 / A5 3.0 TDi Quattro S-Tronic, Tiptronic - CAPA, CCWA, CDUC, CKVB 3.0 TFSi Quattro S-Tronic CMUA [A5] 3.2 FSi Quattro S-Tronic CALA [A4 + A5]
YEARS	00-08	08-14	08-14	08-14
Engine Configuration	INLINE TRANSVERSE [1.9 TDi, 2.0]	INLINE	INLINE	INLINE
Engine Mounting - Front	AR8730 (1.9) AR8019 Buffer		AR7020 Buffer	
Engine Mounting - Rear				
Engine Mounting - Left	AR8027 AR8962 (2.0)	AR8735 (1.8) AR8963 (2.0)	AR8735 (Auto.) AR8737 (Man.)	AR8735
Engine Mounting - Right	AR8732 (1.9) AR8729 (2.0)	AR8736 (1.8) AR8964 (2.0)	AR8735 (Auto.) AR8736 (Man.)	AR8735
Engine Mounting - Other				
Transmission Mounting	AR7189 (2) - Front L/RHS (Excl. 1.9 TDi) AR8020 (2) - Front L/RHS AR8021 (2) Bush (1.9 TDi) AR8024 (2.5 TDi) AR8032 (Auto.) (Excl. 1.9 TDi) AR8731 (1.9 TDi)	AR8928		AR8928
FRONT SUSPENSION				
Upper Control Arm Bush - Inner	AR8007 - Front & Rear	AR8007 - Front & Rear		AR8001 - Front & Rear
Upper Control Arm Bush - Outer				
Lower Control Arm Bush - Inner	AR7068 - Front AR7069 - Rear	AR7068 - Front AR7069 - Rear		AR8734
Lower Control Arm Bush - Outer	AR8000 - Front	AR8000 - Front		AR8925
Stabilizer Bar Bush	AR8013	AR7174		AR7174
Stabilizer Link Grommet		AR8926 Stabilizer Link - L/RHS		AR8926 Stabilizer Link - L/RHS
Steering Coupling				
Steering Rack Mounting				
Strut Mounting	AR7996 (1.8) AR7997 (1.9, 2.0)	AR8739	AR8739	AR8739
Miscellaneous				
REAR SUSPENSION				
Exhaust Hanger - Middle				
Exhaust Hanger - Rear				
Lower Control Arm Bush - Inner	AR8002 - Front AR8003 - Rear	AR8002 - Front AR8003 - Rear		
Lower Control Arm Bush - Outer	AR8004	AR8004		
Stabilizer Bar Bush				AR8253
Strut Mounting				
Miscellaneous	AR8005 (2) Rear Axle Upper Bush AR8006 (2) Rear Axle Lower Bush AR8008 (2) Rear Radius Rod Bush - Inner L/RHS AR8009 (2) Rear Radius Rod Bush - Outer L/RHS AR8017 (2) Rear Axle Carrier Bush - Rear L/RHS AR8018 (2) Rear Axle Carrier Bush - Front L/RHS AR8031 (1) Transfer Gear Mounting 8E-4-293 001 on	AR8921 Axle Guide Beam Bush AR8923 Axle Beam Bush - Front AR8924 Axle Beam Bush - Rear		AR8921 Axle Guide Beam Bush AR8922 Upper Wishbone Bush AR8923 Axle Beam Bush - Front AR8924 Axle Beam Bush - Rear AR8927 Stabilizer Link - L/RHS

APPLICATIONS	AUDI A6 2.6 - ABC 2.8 - AAH	AUDI A6 2.4 - AGA, ALF, AMC, APS, ARJ, BDV, BDW 2.8 Avant Quattro - ACK 4.2 V8 Quattro, Tiptronic - ARS	AUDI A6 2.7T Quattro - AJK, ARE, BES 3.0 Multitronic, Quattro - ASN 3.0 TDi Quattro - ASB	AUDI A6 2.8 FSi 7-Spd. Auto. - BDJ, CCEA
YEARS	94-97	97-05	00-09	07-09
Engine Configuration	INLINE	INLINE	INLINE	INLINE
Engine Mounting - Front	AR7515 (2.6) AR7516 (2.8)	AR7020	AR9739 (3.0)	AR8019
Engine Mounting - Rear				
Engine Mounting - Left	AR7155	AR7080	AR7155 AR8998 (3.0)	AR8991
Engine Mounting - Right	AR7156	AR7080	AR7156 AR8999 (3.0)	AR8992
Engine Mounting - Other				
Transmission Mounting		AR7065 - L/RHS to 4B-X-100 000 AR7067 - L/RHS 4B-X-100 001 on	AR8024 (3.0)	
FRONT SUSPENSION				
Upper Control Arm Bush - Inner		AR8001 - Front & Rear	AR8001 - Front & Rear	AR8007 - Front & Rear
Upper Control Arm Bush - Outer				
Lower Control Arm Bush - Inner		AR7068 - Front AR7069 - Rear	AR7068 - Front AR7069 - Rear	AR7068 - Front AR7069 - Rear
Lower Control Arm Bush - Outer	AR7149	AR7177 - Front	AR7177 - Front	AR8925 - Front
Stabilizer Bar Bush	AR7181	AR7049	AR7049	AR8013
Stabilizer Link Grommet				
Steering Coupling				
Steering Rack Mounting				
Strut Mounting	AR9575	AR7071		AR8952
Miscellaneous	AR7163 Subframe Mounting Bush - Front L/RHS AR7164 Subframe Mounting Bush - Rear LHS AR7165 Subframe Mounting Bush - Rear RHS	AR7188 Subframe Bush - Front AR7189 Subframe Bush - Rear	AR7163 Subframe Mounting Bush - Front L/RHS AR7164 Subframe Mounting Bush - Rear LHS AR7165 Subframe Mounting Bush - Rear RHS	AR8950 Subframe Bush - Front AR8951 Subframe Bush - Rear
REAR SUSPENSION				
Exhaust Hanger - Middle				
Exhaust Hanger - Rear				
Lower Control Arm Bush - Inner				
Lower Control Arm Bush - Outer				
Stabilizer Bar Bush				AR8990
Strut Mounting				
Miscellaneous	AR7150 Rear Axle Beam Bush AR7152 Panhard Rod Bush	AR7150 Rear Axle Beam Bush AR7152 Panhard Rod Bush	AR7150 Rear Axle Beam Bush AR7152 Panhard Rod Bush	AR8948 Rear Axle Beam Bush - Front AR8949 Rear Axle Beam Bush - L/RHS

APPLICATIONS	AUDI A6 2.0 TFSi 7-Spd. Auto., Petrol - BPJ	AUDI A6 2.7 TDi 7-Spd. Auto. - BPP, CANA 2.8 FSi 7-Spd. Auto. - CCEA	AUDI A6 2.0 TDi 8-Spd. Diesel Auto. - CGLC, CMGM 2.0 FSi 8-Spd. Petrol Auto. - CDNB	AUDI A8 3.7 Tiptronic - AQQ 4.2 V8 Quattro - AQF, AUW, AUX
YEARS	09-11	09-11	11-15	95-02
Engine Configuration	INLINE	INLINE	INLINE	INLINE
Engine Mounting - Front	AR9739	AR8019 (2.8 FSi) AR9739	AR9740	
Engine Mounting - Rear	AR8953			
Engine Mounting - Left		AR8991	AR8956 AR8959 (2.0 FSi Only)	
Engine Mounting - Right	AR8954	AR8992	AR8957 AR8960 (2.0 FSi Only)	
Engine Mounting - Other				
Transmission Mounting	AR8955		AR8958 AR8961 (2.0 FSi Only)	
FRONT SUSPENSION				
Upper Control Arm Bush - Inner	AR8007 - Front & Rear	AR8007 - Front & Rear	AR9741 - Front & Rear	AR7070 - Front AR7072 - Rear
Upper Control Arm Bush - Outer				
Lower Control Arm Bush - Inner	AR7068 - Front AR7069 - Rear	AR7068 - Front AR7069 - Rear	AR8734 - Front	AR7068 - Front AR7069 - Rear
Lower Control Arm Bush - Outer	AR8925 - Front	AR8925 - Front	AR8925 - Rear	AR7177 - Front
Stabilizer Bar Bush	AR8013	AR8013	AR7174	
Stabilizer Link Grommet			AR8926 Stabilizer Link - L/RHS	
Steering Coupling				
Steering Rack Mounting				
Strut Mounting	AR8952	AR8952	AR7996	AR7071
Miscellaneous	AR8950 Subframe Bush - Front AR8951 Subframe Bush - Rear	AR8950 Subframe Bush - Front AR8951 Subframe Bush - Rear		AR7188 Subframe Bush - Front AR7189 Subframe Bush - Rear
REAR SUSPENSION				
Exhaust Hanger - Middle				
Exhaust Hanger - Rear				
Lower Control Arm Bush - Inner				
Lower Control Arm Bush - Outer				
Stabilizer Bar Bush	AR8990	AR8990		
Strut Mounting				
Miscellaneous	AR8948 Rear Axle Beam Bush - Front AR8949 Rear Axle Beam Bush - L/RHS	AR8948 Rear Axle Beam Bush - Front AR8949 Rear Axle Beam Bush - L/RHS	AR8923 Rear Axle Beam Bush - Front AR8924 Rear Axle Beam Bush - L/RHS	AR7150 Rear Axle Beam Bush AR7152 Panhard Rod Bush

APPLICATIONS	AUDI Q7 4.2 FSi Quattro - BAR	AUDI S3 2.0 TFSi - CDLC	AUDI S3 2.0 TFSi - CJXB	
YEARS	06-10	07-13	13-17	
Engine Configuration	TRANSVERSE	TRANSVERSE	TRANSVERSE	
Engine Mounting - Front				
Engine Mounting - Rear		AR6898	AR9743	
Engine Mounting - Left	AR9340			
Engine Mounting - Right	AR9340	AR8042	AR8911	
Engine Mounting - Other		AR6908 Upper Subframe Bush AR6909 Lower Subframe Bush	AR9635 Lower & Upper Subframe Bush	
Transmission Mounting	AR9338	AR7010	AR9748	
FRONT SUSPENSION				
Upper Control Arm Bush - Inner	AR9329			
Upper Control Arm Bush - Outer	AR9329			
Lower Control Arm Bush - Inner	AR9330 - Front Inner AR9331 - Front Outer	AR6899 - Front	AR6899	
Lower Control Arm Bush - Outer	AR9332 - Rear	AR6883 - Rear LHS AR6884 - Rear RHS	AR9686	
Stabilizer Bar Bush				
Stabilizer Link Grommet				
Steering Coupling				
Steering Rack Mounting		AR8250		
Strut Mounting		AR7129	AR8909	
Miscellaneous				
REAR SUSPENSION				
Exhaust Hanger - Middle				
Exhaust Hanger - Rear				
Lower Control Arm Bush - Inner				
Lower Control Arm Bush - Outer				
Stabilizer Bar Bush	AR8827	AR8252		
Strut Mounting		AR8041		
Miscellaneous		AR6957 Rear Upper Control Arm Bush - Outer AR6958 Rear Upper Control Arm Bush - Inner AR6958 Rear Upper Control Arm Bush - Inner AR6962 Rear Axle Link - L/RHS AR9320 Rear Axle Beam Bush - Front AR9321 Rear Axle Beam Bush - Rear	AR6957 Rear Upper Control Arm Bush - Outer AR6958 Rear Upper Control Arm Bush - Inner AR9749 Rear Axle Beam Bush - Front AR9750 Rear Axle Beam Bush - Rear AR9687 Rear Track Control Arm Bush - Outer AR9688 Rear Track Control Arm Bush - Inner	

APPLICATIONS	BMW	BMW 1-SERIES E81 / E87	BMW 1-SERIES E87	BMW 1-SERIES E82 / E88	BMW 1-SERIES E82
		116i 1.6 - N45 118i 2.0 - N46 120i 2.0 - N46 130i 3.0 - N52 E88 120i 2.0 - N46	118d 2.0 - M47 120d 2.0 - M47 E82 120d 2.0 - N47	120d 2.0 Coupe 125i 3.0 Convertible, Coupe - N52, N54, N55 135i 3.0 Turbo - N54, N55	M-Coupe 3.0 - N54T
YEARS		04-15	2005-	08-14	11-12
Engine Configuration		INLINE	INLINE	INLINE	INLINE
Engine Mounting - Left		AR7137 AR7142 (130i Only)	AR7138	AR7142	AR7142
Engine Mounting - Right		AR7136 AR7142 (130i Only)	AR7139	AR7142 (125i) AR9368 (135i)	AR9368
Engine Mounting - Other					
Transmission Mounting		AR5426 - L/RHS	AR5426 - L/RHS	AR5426 - L/RHS	AR5426 - L/RHS
FRONT SUSPENSION					
Lower Control Arm Bush - Front		AR8225	AR8225	AR8225	AR9370
Lower Control Arm Bush - Rear		AR8384	AR8384	AR8384	AR9371
Shock Rubber - Front					
Stabilizer Bar Bush		AR7146 (Std. Suspension) AR8224 (Sport Suspension)	AR7146 (Std. Suspension) AR8224 (Sport Suspension)	AR7146	AR9372
Steering Coupling					
Steering Rack Mounting					
Strut Mounting		AR7196	AR7196	AR7196	AR7196
Miscellaneous		AR7047 Gear Shift Bush			
REAR SUSPENSION					
Centre Bearing Rubber		AR7053 AR6315 - Alt.	AR7053	AR7053 (ID: 30mm) AR9366 (ID: 35mm) AR6315 - Alt.	AR9366
Exhaust Hanger - Middle		AR9359	AR9359	AR9359	AR9369
Exhaust Hanger - Rear					
Lower Control Arm Bush - Inner		AR7274 - Rear AR7275 - Front	AR7274 - Rear AR7275 - Front		
Lower Control Arm Bush - Outer		AR7270 - Outer AR7271 Track Strut - Rear	AR7270 - Outer AR7271 Track Strut - Rear		
Propshaft Coupling		AR2075 (78mm x 110mm) AR5367 (96mm x 135mm)	AR2075 (78mm x 110mm) AR5367 (96mm x 135mm)	AR5367 (125i) AR9365 (135i)	AR9365
Stabilizer Bar Bush				AR9367	AR9377
Stabilizer Link Grommet					
Strut Mounting					
Miscellaneous		AR7147 Rear Axle Carrier Bush - Front Outer L/RHS AR7261 Rear Axle Carrier Bush - Outer L/RHS AR7262 Rear Axle Push Rod - LHS AR7263 Rear Axle Push Rod - RHS AR7264 Rear Axle Carrier Roll-Over Strut - Rear Lower, Outer L/RHS AR7265 Lower Trailing Arm Bush - Inner & Outer L/RHS AR7266 Rear Axle Carrier Bush - Front, Centre L/RHS AR7267 Rear Axle Carrier Bush - Rear Inner LHS	AR7147 Rear Axle Carrier Bush - Front Outer L/RHS AR7261 Rear Axle Carrier Bush - Outer L/RHS AR7262 Rear Axle Push Rod - LHS AR7263 Rear Axle Push Rod - RHS AR7264 Rear Axle Carrier Roll-Over Strut - Rear Lower, Outer L/RHS AR7265 Lower Trailing Arm Bush - Inner & Outer L/RHS AR7266 Rear Axle Carrier Bush - Front, Centre L/RHS AR7267 Rear Axle Carrier Bush - Rear Inner LHS	AR7147 Rear Axle Carrier Bush - Front Outer L/RHS AR7261 Rear Axle Carrier Bush - Outer L/RHS AR7262 Rear Axle Push Rod - LHS AR7263 Rear Axle Push Rod - RHS AR7264 Rear Axle Carrier Roll-Over Strut - Rear Lower, Outer L/RHS AR7265 Lower Trailing Arm Bush - Inner & Outer L/RHS AR7266 Rear Axle Carrier Bush - Front, Centre L/RHS AR7267 Rear Axle Carrier Bush - Rear Inner LHS	AR9373 Rear Axle Carrier Bush - Front L/RHS AR9374 Rear Axle Carrier Bush - Front Centre AR9375 Rear Axle Carrier Bush - Rear L/RHS AR9376 Rear Axle Carrier Bush - Rear Centre

APPLICATIONS	BMW 1-SERIES F20 / F21 116i 1.6 - N13 118i 1.5 - B38, 1.6 - N13 120i 1.6 - N13	BMW 1-SERIES F20 / F21 120d 2.0 - B47 120i 2.0 - B48 125i 2.0 - B48, N20	BMW 1-SERIES F20 / F21 M135i 3.0 - N55	BMW 1-SERIES F40 118i 1.5 - B38	
	YEARS	11-19	11-19	11-19	2020-
	Engine Configuration	INLINE	INLINE	INLINE	TRANSVERSE
	Engine Mounting - Left	AR8967 (Excl. 118i - B38) AR1013 (118i - B38 Only)	AR1031 (120i) AR1037 (120d) AR9363 (125i)	AR9383	
	Engine Mounting - Right	AR8966 (Excl. 118i - B38) AR1014 (118i - B38 Only)	AR1032 (120i) AR1038 (120d) AR9364 (125i)	AR9384	AR1118 (6-Spd. Man.) AR1119 (7-Spd. Dual Clutch.)
Transmission Mounting	AR8968 (Excl. 118i - B38) AR1114 (118i - B38 Only)	AR8968	AR9385	AR1120 (6-Spd. Man.) AR1121 (7-Spd. Dual Clutch.)	
FRONT SUSPENSION					
Lower Control Arm Bush - Inner	AR8970 - Front	AR8970 - Front	AR8970 - Front	AR1122 - Front	
Lower Control Arm Bush - Outer	AR8971 - Rear	AR8971 - Rear	AR8971 - Rear	AR1123L - Rear LHS AR1123R - Rear RHS	
Stabilizer Bar Bush	AR9378	AR9378	AR9378		
Strut Mounting	AR9358	AR9358	AR9358	AR1125 Standard Suspension	
Miscellaneous	AR1019 - Brake Pedal (Man.) AR1020 - Brake Pedal (Auto.) AR1021 - Clutch Pedal Rubber	AR1019 - Brake Pedal (Man.) AR1020 - Brake Pedal (Auto.) AR1021 - Clutch Pedal Rubber	AR1019 - Brake Pedal (Man.) AR1020 - Brake Pedal (Auto.) AR1021 - Clutch Pedal Rubber		
REAR SUSPENSION					
Centre Bearing Rubber	AR6315 (116i, 118i) AR7053 (118i - B38 Only) AR8969 (Excl. 118i - B38)	AR6315 (120d) AR8969			
Exhaust Hanger	AR9357	AR9357 (120i, 125i) AR9362 (120d)	AR9357		
Propshaft Coupling	AR5367 - Fr. (78mm x 110mm) AR6192 - Front (Alt.) AR7143 - Rear	AR5367 - Fr. (78mm x 110mm) AR7143 - Rear	AR9365		
Stabilizer Bar Bush	AR8976 With Adaptive Suspension AR8977 Without Adaptive Suspension	AR8976 With Adaptive Suspension AR8977 Without Adaptive Suspension	AR8976 With Adaptive Suspension AR8977 Without Adaptive Suspension		
Strut Mounting	AR1115 Vehicles without Electronic Suspension Control AR1127 - Alt. Vehicles with Electronic Suspension Control	AR1115 Vehicles without Electronic Suspension Control AR1127 - Alt. Vehicles with Electronic Suspension Control	AR1115 Vehicles without Electronic Suspension Control AR1127 - Alt. Vehicles with Electronic Suspension Control	AR1127 Standard Suspension	
Miscellaneous	AR8972 Rear Axle Carrier Bush - Front Outer AR8973 Rear Axle Carrier Bush - Front Centre AR8974 Rear Axle Carrier Bush - Rear Outer AR8975 Rear Axle Carrier Bush - Rear Centre AR1025 Upper Trailing Arm - Front LHS AR1026 Upper Trailing Arm - Front RHS AR1027 Upper Trailing Arm - Rear LHS AR1028 Upper Trailing Arm - Rear LHS AR1029 Lower Trailing Arm - Front L/RHS AR1030 Lower Trailing Arm - Rear L/RHS	AR8972 Rear Axle Carrier Bush - Front Outer AR8973 Rear Axle Carrier Bush - Front Centre AR8974 Rear Axle Carrier Bush - Rear Outer AR8975 Rear Axle Carrier Bush - Rear Centre AR1025 Upper Trailing Arm - Front LHS AR1026 Upper Trailing Arm - Front RHS AR1027 Upper Trailing Arm - Rear LHS AR1028 Upper Trailing Arm - Rear LHS AR1029 Lower Trailing Arm - Front L/RHS AR1030 Lower Trailing Arm - Rear L/RHS	AR8972 Rear Axle Carrier Bush - Front Outer AR8973 Rear Axle Carrier Bush - Front Centre AR8974 Rear Axle Carrier Bush - Rear Outer AR8975 Rear Axle Carrier Bush - Rear Centre AR1025 Upper Trailing Arm - Front LHS AR1026 Upper Trailing Arm - Front RHS AR1027 Upper Trailing Arm - Rear LHS AR1028 Upper Trailing Arm - Rear LHS AR1029 Lower Trailing Arm - Front L/RHS AR1030 Lower Trailing Arm - Rear L/RHS	AR1131 Lateral Link - Upper L/RHS AR1132 Lateral Link - Lower L/RHS	

APPLICATIONS	BMW 2-SERIES F22 / F23 - COUPE 220d 2.0 - B47, N47 M235i 3.0 - N55 M240i 2.0 - B58	BMW 2-SERIES F22 / F23 - COUPE 220i 2.0 - B48, N20 228i 2.0 - N20, N26 230i 2.0 - B46, B48	BMW 2-SERIES F45 - ACTIVE TOURER 218i 1.5 - B38 220d 2.0 - B47 220i 2.0 - B48 225i 2.0 - B48	BMW 2-SERIES F46 - GRAN TOURER 218i 1.5, Steptronic - B38 220d 2.0 - B47 220i 2.0 - B48	
	YEARS	14-19	14-19	2015-	2015-
	Engine Configuration	INLINE	INLINE	TRANSVERSE	TRANSVERSE
	Engine Mounting - Left	AR1037 (220d - B47) AR9360 (220d - N47) AR9383 (M235i, M240i)	AR1031 (230i) AR9363 (220i, 228i)	AR1116 (Man.) AR1117 (Auto., Excl. 225i)	AR1116
	Engine Mounting - Right	AR1038 (220d - B47) AR9361 (220d - N47) AR9384 (M235i, M240i)	AR1032 (230i) AR9364 (220i, 228i)	AR1118 (218i, 220i Man.) AR1119 (218i, 220i Auto.) AR1129 (220d Auto.) AR1133 (225i)	AR1119 (218i Auto., Steptronic) AR1129 (220d) AR1133 (220i)
Transmission Mounting	AR8968 (220d) AR9385 (M235i, M240i)	AR8968	AR1120 (218i Man.) AR1121 (Auto., Twin Clutch) (Excl. 225i) AR1130 (Auto., Excl. 218i)	AR1120 (218i Man., 220i Steptronic) AR1121 (218i Auto.) AR1130 (220d, 220i Auto.)	
FRONT SUSPENSION					
Lower Control Arm Bush - Inner	AR8970 - Front	AR8970 - Front	AR1122 - Front	AR1122 - Front	
Lower Control Arm Bush - Outer	AR8971 - Rear	AR8971 - Rear	AR1123L - Rear LHS AR1123R - Rear RHS	AR1123L - Rear LHS AR1123R - Rear RHS	
Stabilizer Bar Bush	AR9378	AR9378	AR1124	AR1124 (220d)	
Strut Mounting	AR9358	AR9358	AR1125 Standard Suspension AR1126 Vehicles with Dynamic Damper Control	AR1125 Standard Suspension AR1126 Vehicles with Dynamic Damper Control	
Miscellaneous	AR1019 - Brake Pedal (Man.) AR1020 - Brake Pedal (Auto.) AR1021 - Clutch Pedal Rubber	AR1019 - Brake Pedal (Man.) AR1020 - Brake Pedal (Auto.) AR1021 - Clutch Pedal Rubber			
REAR SUSPENSION					
Centre Bearing Rubber	AR8969 (220d)	AR8969			
Exhaust Hanger	AR9362 (220d - N47)	AR9357	AR9357	AR9357	
Propshaft Coupling	AR5367 - Front AR9365 - Front (Alt.) AR7143 - Rear	AR5367 - Front AR6192 - Front (Alt. 220i) AR7143 - Rear			
Stabilizer Bar Bush	AR8976 (220d) With Adaptive Suspension AR8977 (220d) Without Adaptive Suspension	AR8976 (ID: 12mm) AR8977 (ID: 13mm)			
Strut Mounting	AR1115 (220d - N47) Vehicles without Electronic Suspension Control AR1127 (Excl. 220d - N47) Vehicles with Electronic Suspension Control	AR1115 (220i, 230i) AR1127 (228i)	AR1127 M-Sport Suspension AR1128 Standard Suspension	AR1127 M-Sport Suspension AR1128 Standard Suspension	
Miscellaneous	AR8972 Rear Axle Carrier Bush - Front Outer AR8973 Rear Axle Carrier Bush - Front Centre AR8974 Rear Axle Carrier Bush - Rear Outer AR8975 Rear Axle Carrier Bush - Rear Centre AR1025 Upper Trailing Arm - Front LHS AR1026 Upper Trailing Arm - Front RHS AR1027 Upper Trailing Arm - Rear LHS AR1028 Upper Trailing Arm - Rear LHS AR1029 Upper Trailing Arm - Rear LHS Lower Trailing Arm - Fr. L/RHS AR1030 Lower Trailing Arm - Rr. L/RHS	AR8972 Rear Axle Carrier Bush - Front Outer AR8973 Rear Axle Carrier Bush - Front Centre AR8974 Rear Axle Carrier Bush - Rear Outer AR8975 Rear Axle Carrier Bush - Rear Centre AR1025 Upper Trailing Arm - Front LHS AR1026 Upper Trailing Arm - Front RHS AR1027 Upper Trailing Arm - Rear LHS AR1028 Upper Trailing Arm - Rear LHS AR1029 Upper Trailing Arm - Rear LHS Lower Trailing Arm - Fr. L/RHS AR1030 Lower Trailing Arm - Rr. L/RHS	AR1131 Lateral Link - Upper L/RHS AR1132 Lateral Link - Lower L/RHS	AR1131 Lateral Link - Upper L/RHS AR1132 Lateral Link - Lower L/RHS	

APPLICATIONS	BMW 2-SERIES F44 - GRAN COUPE 218i 1.5 - B38 220d 2.0 - B47 M235i 2.0 - B48	BMW 3-SERIES E30 316 1.8 - M10 316i 1.6 - M40, 1.8 Cabriolet - M40 318i 1.8 Cabriolet - M40	BMW 3-SERIES E30 320i 2.0 - M20, M50 323i 2.3 - M20 325i 2.5 - M20B25, 2.7 Shadowline, iS Shadowline, Cabriolet - M20B27 333i 3.3 6-Cyl. - M30	BMW 3-SERIES E36 316i 1.8 Dolphin Shape - M40 318i 1.8 Motorsport I / II - M40, 1.9 S - M42 320i 2.0 - M50 323i 2.5 - M52
YEARS	2020-	83-92	83-92	92-00
Engine Configuration	TRANSVERSE	INLINE	INLINE	INLINE
Engine Mounting - Left	AR1116 (220d)	AR5419	AR5427	AR7202
Engine Mounting - Right	AR1133 (220d)	AR5419	AR5427	AR7202
Transmission Mounting	AR1130 (220d Auto.)	AR5420 Getrag 242 (89-93) (316 1.6, 1.8 M10) AR5426 - L/RHS (316i M40, 318i) AR5439 Getrag 240 (86-88) (316 1.6, 1.8 M10)	AR5421 (320i) AR5426 - L/RHS Getrag 260 (Auto.) (323i, 325i, 333i)	AR5426 - L/RHS
FRONT SUSPENSION				
Lower Control Arm Bush - Inner	AR1122 - Front	AR5422 - Rear	AR5422 - Rear	AR5422 - Rear
Lower Control Arm Bush - Outer	AR1123L - Rear LHS AR1123R - Rear RHS			
Stabilizer Bar Bush		AR5424	AR5424	AR7206 (316, 318) AR7208 (320, 323)
Strut Mounting	AR1125 Standard Suspension AR1126 Vehicles with Dynamic Damper Control	AR7220	AR7220	AR7221
Miscellaneous		AR123 Air Cleaner Mounting	AR123 Air Cleaner Mounting AR7047 Gear Shift Bush	AR123 Air Cleaner Mounting AR7047 Gear Shift Bush
REAR SUSPENSION				
Centre Bearing Rubber		AR6173 Chrome Bumper AR6174 Plastic Bumper	AR6173 Chrome Bumper AR6174 Plastic Bumper	AR6315
Exhaust Hanger		AR2014	AR2014	
Lower Control Arm Bush - Inner				AR7214 - L/RHS
Lower Control Arm Bush - Outer				
Propshaft Coupling		AR5367	AR5367	AR5367 (92-93) (19mm) AR6192 (93-99) (12mm)
Stabilizer Bar Bush				AR7216
Stabilizer Link Grommet				
Strut Mounting	AR1127 Standard Suspension	AR6188	AR6188	AR6188
Miscellaneous	AR1131 Lateral Link - Upper L/RHS AR1132 Lateral Link - Lower L/RHS	AR7212 Trailing Arm Bush - Front L/RHS AR7225 Rear Axle Carrier Bush	AR7212 Trailing Arm Bush - Front L/RHS AR7225 Rear Axle Carrier Bush	AR7145 Trailing Arm Bush - Upper L/RHS AR7168 Rear Axle Diff. Bush AR7209 Rear Axle Carrier Bush - Front AR7210 Rear Axle Carrier Bush - Rear AR7212 Trailing Arm Bush - Front L/RHS AR7213 Trailing Arm Bush - Lower L/RHS

APPLICATIONS	BMW 3-SERIES E36 325i 2.5 Dolphin Convertible - M50 325tds 2.5 6-Cyl. Dies. - M51 328i 2.8 - M52T	BMW 3-SERIES E36 / E37 M-Coupe 3.2 6-Cyl. - S50B32 E36 / E46 M3 3.0 - M54 3.2 Convertible - S50B32/4	BMW 3-SERIES E36 328i 2.8 Dolphin Convertible, Individual - M52TU	BMW 3-SERIES E36 / E37 Z3 2.8 Roadster - M52, 3.0 Roadster 6-Cyl. - M54
YEARS	92-99	93-05	95-00	97-03
Engine Configuration	INLINE	INLINE	INLINE	INLINE
Engine Mounting - Left	AR7202	AR7211	AR7227	AR7211
Engine Mounting - Right	AR7202	AR7211	AR7227	AR7211
Transmission Mounting	AR5426 - L/RHS	AR5426 - L/RHS	AR5426 - L/RHS	AR5426 - L/RHS
FRONT SUSPENSION				
Upper Control Arm Bush - Inner				
Upper Control Arm Bush - Outer				
Lower Control Arm Bush - Inner	AR5422 - Rear	AR5422 (E36 Only) AR7204 - LHS Control Arm Bracket (66mm) (E46 Only) AR7205 - RHS Control Arm Bracket (66mm) (E46 Only)	AR5422 - Rear	AR5422 - Rear
Lower Control Arm Bush - Outer				
Shock Rubber - Front				
Stabilizer Bar Bush	AR7208	AR7234 (M-Coupe, E46)	AR7206	
Strut Mounting	AR7221	AR7196 (M-Coupe) AR7221 (M3)	AR7221	AR7221
Miscellaneous	AR123 Air Cleaner Mounting AR7047 Gear Shift Bush	AR7047 Gear Shift Bush	AR123 Air Cleaner Mounting AR7047 Gear Shift Bush	
REAR SUSPENSION				
Centre Bearing Rubber	AR6315	AR6315 (E36 M3) AR7215 (M-Coupe, E46)	AR6315	
Upper Control Arm Bush - Inner	AR7217 - L/RHS	AR7217 - L/RHS		
Upper Control Arm Bush - Outer				
Lower Control Arm Bush - Inner	AR7214 - L/RHS	AR7214 - L/RHS	AR7214 - L/RHS	
Lower Control Arm Bush - Outer		AR7170 Front Control Arm - Outer (M3)	AR7170 Front Control Arm Bush - Outer	
Propshaft Coupling	AR5367 (92-93) (325) AR6192 (93-99) (325) AR2075 (328i)	AR7258	AR6192 (78mm x 110mm)	AR2075 (96mm x 135mm) AR6192 (78mm x 110mm)
Stabilizer Bar Bush		AR5438		
Stabilizer Link Grommet		AR5436		
Strut Mounting	AR6188	AR6188		AR6188
Miscellaneous	AR7145 Trailing Arm Bush - Upper L/RHS AR7168 Rear Axle Diff. Bush AR7209 Rear Axle Carrier Bush - Front AR7210 Rear Axle Carrier Bush - Rear AR7212 Trailing Arm Bush - Front L/RHS AR7213 Trailing Arm Bush - Lower L/RHS	AR5437 (M-Coupe) Trailing Arm Bush - Front & Rear AR7145 Trailing Arm Bush - Upper L/RHS AR7212 (M3) Trailing Arm Bush - Front L/RHS AR7213 Trailing Arm Bush - Lower L/RHS	AR7213 Trailing Arm Bush - Lower L/RHS	AR5437 Trailing Arm Bush - Front & Rear

APPLICATIONS	BMW 3-SERIES E46 318i 1.8 - M43, 2.0 Touring SW - M43, 2.0 - N42 318ti 2.0 Compact - M47B 320d 2.0 - M47D	BMW 3-SERIES E46 320i 2.0 - M52, 2.2 - M54 323Ci 2.5 Coupe - M52 323i 2.5 - M52 325Ci 2.5 Coupe - M54 325i 325ti 2.5 Touring SW, Compact - M50/54	BMW 3-SERIES E46 328i 2.8 Coupe - M52TU 330Ci 3.0 Convertible - M54 330d 3.0 Dies. - M57 330i 3.0 - M54	BMW 3-SERIES E90 320d 2.0 - M47 320i 2.0 - N46
YEARS	98-05	99-05	99-05	05-13
Engine Configuration	INLINE	INLINE	INLINE	INLINE
Engine Mounting - Left	AR7207	AR7202	AR9754 (330d)	AR7138 Diesel AR7137 Petrol
Engine Mounting - Right	AR7207	AR7202	AR9754 (330d)	AR7139 Diesel AR7136 Petrol
Engine Mounting - Other				
Transmission Mounting	AR5426 - L/RHS	AR5426 - L/RHS	AR5426 - L/RHS	AR5426 - L/RHS
FRONT SUSPENSION				
Lower Control Arm Bush - Front				AR8225
Lower Control Arm Bush - Rear	AR7204 - LHS Control Arm Bracket (66mm) AR7205 - RHS Control Arm Bracket (66mm)	AR7204 - LHS Control Arm Bracket (66mm) AR7205 - RHS Control Arm Bracket (66mm)	AR7204 - LHS Control Arm Bracket (66mm) AR7205 - RHS Control Arm Bracket (66mm)	AR8384
Stabilizer Bar Bush				AR7146
Strut Mounting	AR7196	AR7196	AR7196	AR7196
Miscellaneous	AR7047 Gear Shift Bush	AR7047 Gear Shift Bush	AR7047 Gear Shift Bush	
REAR SUSPENSION				
Centre Bearing Rubber	AR7215 AR8849 - Alt.	AR7215 AR8849 - Alt.	AR7215 AR8849 - Alt.	AR7053 AR6315 - Alt.
Upper Control Arm Bush - Inner	AR7217 - L/RHS	AR7217 - L/RHS	AR7217 - L/RHS	
Upper Control Arm Bush - Inner				
Lower Control Arm Bush - Inner	AR7214 - L/RHS	AR7214 - L/RHS	AR7214 - L/RHS	AR7274 - Rear AR7275 - Front
Lower Control Arm Bush - Outer				AR7270 - Outer AR7271 Track Strut - Rear
Propshaft Coupling	AR2075 (96mm x 135mm) AR5367 (78mm x 110mm) AR6192 - Alt. (78mm x 110mm)	AR2075 (96mm x 135mm) AR5367 (78mm x 110mm) AR6192 - Alt. (78mm x 110mm)	AR2075 (96mm x 135mm) AR5709 (105mm) (330d) AR5710 (110mm) (330d)	AR2075 - Fr. (96mm x 135mm) AR5367 - Fr. (78mm x 110mm) AR7143 - Rr. (96mm x 126mm)
Stabilizer Bar Bush				
Stabilizer Link Grommet	AR7182 Stabilizer Link	AR7182 Stabilizer Link	AR7182 Stabilizer Link	
Strut Mounting	AR6188	AR6188	AR6188	
Miscellaneous	AR7034 Rear Axle Carrier, Rear Inner Rubber Mounting - LHS AR7145 Trailing Arm Bush - Upper L/RHS AR7173 Rear Axle Carrier Bush - Front LHS AR7176 Rear Axle Carrier Bush - Front RHS AR7178 Rear Axle Carrier Diff. Bush - L/RHS AR7180 Rear Axle Carrier Bush - Rear L/RHS AR7212 Trailing Arm Bush - Front L/RHS AR7213 Trailing Arm Bush - Lower L/RHS	AR7034 Rear Axle Carrier Bush - Rear Inner LHS AR7145 Trailing Arm Bush - Upper L/RHS AR7212 Trailing Arm Bush - Front L/RHS AR7213 Trailing Arm Bush - Lower L/RHS	AR7034 Rear Axle Carrier Bush - Rear Inner LHS AR7145 Trailing Arm Bush - Upper L/RHS AR7212 Trailing Arm Bush - Front L/RHS AR7213 Trailing Arm Bush - Lower L/RHS	AR7147 Rear Axle Carrier Bush - Front Outer L/RHS AR7261 Rear Axle Carrier Bush - Outer L/RHS AR7262 Rear Axle Push Rod - LHS AR7263 Rear Axle Push Rod - RHS AR7264 Rear Axle Carrier Roll-Over Strut - Rr. Lower Outer L/RHS AR7265 Lower Trailing Arm Bush - Inner & Outer L/RHS AR7266 Rear Axle Carrier Bush - Front Centre L/RHS AR7267 Rear Axle Carrier Bush - Rear Inner LHS

APPLICATIONS	BMW 3-SERIES E90	BMW 3-SERIES E90	BMW 3-SERIES E92	BMW 3-SERIES E93
	323i 2.5 - N52N 325i 2.5 - N53 330i 3.0 - N52, N53 330d 3.0 - M57, N57	320d 2.0 - N47 330d 3.0 - N57 335i 3.0 - N55	320i 2.0 - N44 325i 2.5 - N53 335i 3.0 - N54, N55	330i 3.0 - N52 335i 3.0 - N54, N55
YEARS	05-13	2007-	02-15	05-14
Engine Configuration	INLINE	INLINE	INLINE	INLINE
Engine Mounting - Left	AR7142 AR8297 - Alt.	AR7138 (320d) AR7142 (330d) AR8297 (335i)	AR7137 (320i) AR7142 (335i) AR9380 (325i)	AR7142
Engine Mounting - Right	AR7142 AR8298 - Alt.	AR7139 (320d) AR8298 (330d) AR9368 (335i)	AR7136 (320i) AR9368 (335i) AR9380 (325i)	AR7142 (330i) AR9368 (335i)
Transmission Mounting	AR5426 - L/RHS	AR5426 - L/RHS	AR5426 - L/RHS	AR5426 - L/RHS
FRONT SUSPENSION				
Lower Control Arm Bush - Front	AR8225	AR8225	AR8225	AR8225
Lower Control Arm Bush - Rear	AR8384	AR8384	AR8384	AR8384
Stabilizer Bar Bush	AR7146	AR7146	AR7146	AR7146
Strut Mounting	AR7196	AR7196	AR7196	AR7196
Miscellaneous				
REAR SUSPENSION				
Centre Bearing Rubber	AR7053 AR6315 - Alt.	AR7053 AR9366 (335i) AR6315 - Alt.	AR7053 AR9366 (335i)	AR7053 AR9366 (335i)
Exhaust Hanger		AR9362 AR9381 (335i)	AR9362 (320i) AR9379 (325i) AR9381 (335i)	AR9381
Lower Control Arm Bush - Inner	AR7274 - Rear AR7275 - Front			
Lower Control Arm Bush - Outer	AR7270 - Outer AR7271 Track Strut - Rear			
Propshaft Coupling	AR2075 - Fr. (96mm x 135mm) AR5367 - Fr. (78mm x 110mm) AR7143 - Rr. (96mm x 126mm)	AR7143 - Rear AR9365 - Alt.	AR5367 - Front (78mm x 110mm) AR9365 (335i)	AR5367 - Fr. (78mm x 110mm) AR7143 - Rr. (96mm x 126mm) AR9365 (335i)
Stabilizer Bar Bush		AR7235	AR8228 (ID: 11mm) without M-Sport Suspension AR9367 (ID: 12mm) with M-Sport Suspension	AR7235 (ID: 13mm) AR9382 (ID: 15mm)
Stabilizer Link Grommet				
Strut Mounting				
Miscellaneous	AR7147 Rear Axle Carrier Bush - Front Outer L/RHS AR7261 Rear Axle Carrier Bush - Outer L/RHS AR7262 Rear Axle Push Rod - LHS AR7263 Rear Axle Push Rod - RHS AR7264 Rear Axle Carrier Roll-Over Strut - Rr. Lower Outer L/RHS AR7265 Lower Trailing Arm Bush - Inner & Outer L/RHS AR7266 Rear Axle Carrier Bush - Front Centre L/RHS AR7267 Rear Axle Carrier Bush - Rear Inner LHS	AR7147 Rear Axle Carrier Bush - Front Outer L/RHS AR7261 Rear Axle Carrier Bush - Outer L/RHS AR7262 Rear Axle Push Rod - LHS AR7263 Rear Axle Push Rod - RHS AR7264 Rear Axle Carrier Roll-Over Strut - Rr. Lower Outer L/RHS AR7265 Lower Trailing Arm Bush - Inner & Outer L/RHS AR7266 Rear Axle Carrier Bush - Front Centre L/RHS AR7267 Rear Axle Carrier Bush - Rear Inner LHS	AR7147 Rear Axle Carrier Bush - Front Outer L/RHS AR7261 Rear Axle Carrier Bush - Outer L/RHS AR7262 Rear Axle Push Rod - LHS AR7263 Rear Axle Push Rod - RHS AR7264 Rear Axle Carrier Roll-Over Strut - Rr. Lower Outer L/RHS AR7265 Lower Trailing Arm Bush - Inner & Outer L/RHS AR7266 Rear Axle Carrier Bush - Front Centre L/RHS AR7267 Rear Axle Carrier Bush - Rear Inner LHS	AR7147 Rear Axle Carrier Bush - Front Outer L/RHS AR7261 Rear Axle Carrier Bush - Outer L/RHS AR7262 Rear Axle Push Rod - LHS AR7263 Rear Axle Push Rod - RHS AR7264 Rear Axle Carrier Roll-Over Strut - Rr. Lower Outer L/RHS AR7265 Lower Trailing Arm Bush - Inner & Outer L/RHS AR7266 Rear Axle Carrier Bush - Front Centre L/RHS AR7267 Rear Axle Carrier Bush - Rear Inner LHS

APPLICATIONS	BMW 3-SERIES F30 / F31 316i 1.6 - N13 318i 1.5 - B38	BMW 3-SERIES F30 / F31 320d 2.0 - N47 328i 2.0 - N20	BMW 3-SERIES F30 / F31 320i 2.0 - B48, N20 330i 2.0 - B46, B48	BMW 3-SERIES F30 / F31 330d 3.0 - N57
YEARS	12-19	12-19	12-19	12-19
Engine Configuration	INLINE	INLINE	INLINE	INLINE
Engine Mounting - Left	AR8967 (316i) AR1013 (318i)	AR9360	AR9363 (320i - N20) AR1031 (320i - B48, 330i)	AR1039
Engine Mounting - Right	AR8966 (316i) AR1014 (318i)	AR9361	AR9364 (320i - N20) AR1032 (320i - B48, 330i)	AR1040
Transmission Mounting	AR8968 (316i) AR1114 (318i)	AR8968	AR8968	AR9385
FRONT SUSPENSION				
Lower Control Arm Bush - Inner	AR8970 - Front	AR8970 - Front	AR8970 - Front	AR8970 - Front
Lower Control Arm Bush - Outer	AR8971 - Rear	AR8971 - Rear	AR8971 - Rear	AR8971 - Rear
Stabilizer Bar Bush	AR9378	AR9378	AR9378	AR9378
Strut Mounting	AR9358	AR9358	AR9358	AR9358
Miscellaneous	AR1019 - Brake Pedal (Man.) AR1020 - Brake Pedal (Auto.) AR1021 - Clutch Pedal Rubber	AR1019 - Brake Pedal (Man.) AR1020 - Brake Pedal (Auto.) AR1021 - Clutch Pedal Rubber	AR1019 - Brake Pedal (Man.) AR1020 - Brake Pedal (Auto.) AR1021 - Clutch Pedal Rubber	AR1019 - Brake Pedal (Man.) AR1020 - Brake Pedal (Auto.) AR1021 - Clutch Pedal Rubber
REAR SUSPENSION				
Centre Bearing Rubber	AR7053	AR7053	AR7053	AR1035
Exhaust Hanger	AR9357 - Middle, Rear	AR9357 (328i) AR9362 (320d)	AR9357 - Middle, Rear	AR9357 - Middle, Rear
Lower Control Arm Bush - Inner				
Lower Control Arm Bush - Outer				
Propshaft Coupling	AR5367 - Fr. (78mm x 110mm) AR6192 - Front (Alt.) AR7143 - Rear	AR5367 - Fr. (78mm x 110mm) AR6192 - Front (Alt.) AR7143 - Rear AR9365 - Front & Rear (320d)	AR5367 - Fr. (78mm x 110mm) AR6192 - Front (Alt. - 320i) AR7143 - Rear	AR9365 - Front
Stabilizer Bar Bush	AR8976 (ID: 12mm) with Adaptive Suspension AR8977 (ID: 13mm) without Adaptive Suspension	AR8976 (ID: 12mm) with Adaptive Suspension AR8977 (ID: 13mm) without Adaptive Suspension	AR8976 (ID: 12mm) with Adaptive Suspension AR8977 (ID: 13mm) without Adaptive Suspension	AR8976 (ID: 12mm) with Adaptive Suspension AR8977 (ID: 13mm) without Adaptive Suspension
Strut Mounting	AR1127 Vehicles with Electronic Suspension Control	AR1127 Vehicles with Electronic Suspension Control	AR1127 Vehicles with Electronic Suspension Control	AR1127 Vehicles with Electronic Suspension Control
Miscellaneous	AR8972 Rear Axle Carrier Bush - Front Outer AR8973 Rear Axle Carrier Bush - Front Centre AR8974 Rear Axle Carrier Bush - Rear Outer AR8975 Rear Axle Carrier Bush - Rear Outer AR1025 Upper Trailing Arm - Front LHS AR1026 Upper Trailing Arm - Front RHS AR1027 Upper Trailing Arm - Rear LHS AR1028 Upper Trailing Arm - Rear LHS AR1029 Lower Trailing Arm - Front L/RHS AR1030 Lower Trailing Arm - Rear L/RHS	AR8972 Rear Axle Carrier Bush - Front Outer AR8973 Rear Axle Carrier Bush - Front Centre AR8974 Rear Axle Carrier Bush - Rear Outer AR8975 Rear Axle Carrier Bush - Rear Outer AR1025 Upper Trailing Arm - Front LHS AR1026 Upper Trailing Arm - Front RHS AR1027 Upper Trailing Arm - Rear LHS AR1028 Upper Trailing Arm - Rear LHS AR1029 Lower Trailing Arm - Front L/RHS AR1030 Lower Trailing Arm - Rear L/RHS	AR8972 Rear Axle Carrier Bush - Front Outer AR8973 Rear Axle Carrier Bush - Front Centre AR8974 Rear Axle Carrier Bush - Rear Outer AR8975 Rear Axle Carrier Bush - Rear Outer AR1025 Upper Trailing Arm - Front LHS AR1026 Upper Trailing Arm - Front RHS AR1027 Upper Trailing Arm - Rear LHS AR1028 Upper Trailing Arm - Rear LHS AR1029 Lower Trailing Arm - Front L/RHS AR1030 Lower Trailing Arm - Rear L/RHS	AR8972 Rear Axle Carrier Bush - Front Outer AR8973 Rear Axle Carrier Bush - Front Centre AR8974 Rear Axle Carrier Bush - Rear Outer AR8975 Rear Axle Carrier Bush - Rear Outer AR1025 Upper Trailing Arm - Front LHS AR1026 Upper Trailing Arm - Front RHS AR1027 Upper Trailing Arm - Rear LHS AR1028 Upper Trailing Arm - Rear LHS AR1029 Lower Trailing Arm - Front L/RHS AR1030 Lower Trailing Arm - Rear L/RHS

APPLICATIONS	BMW 3-SERIES F30 / F31 335i 3.0 - N55 340i 3.0 - B58	BMW 3-SERIES F34 GRAN TURISMO 320d 2.0 - B47, N47 328i, xDrive 3.0 - N20, N26	BMW 3-SERIES F34 GRAN TURISMO 320i, xDrive 2.0 - B48, N20 335i 3.0 Sport - N55 340i 3.0 Sport - B58	BMW 4-SERIES F32 - COUPE 420d 2.0 - B47 420i 2.0 - B48, N20 428i 2.0 - N20, N26 430i 2.0 - B46, B48	
	YEARS	12-19	2013-	2013-	2014-
	Engine Configuration	INLINE	INLINE	INLINE	INLINE
	Engine Mounting - Left	AR9383	AR1037 (320d - B47) AR9360 (320d - N47, 328i)	AR9363 (320i) AR9383 (335i)	AR1013 (420i) AR1031 (430i) AR1037 (420d) AR9363 (428i)
	Engine Mounting - Right	AR9384	AR1038 (320d - B47) AR9361 (320d - N47, 328i)	AR9364 (320i) AR9384 (335i)	AR1014 (420i) AR1032 (430i) AR1038 (420d) AR9364 (428i)
	Transmission Mounting	AR9385	AR8968	AR8968 (320i) AR9385 (335i, 340i)	AR8968
FRONT SUSPENSION					
Lower Control Arm Bush - Inner	AR8970 - Front	AR8970 - Front	AR8970 - Front	AR8970 - Front	
Lower Control Arm Bush - Outer	AR8971 - Rear	AR8971 - Rear	AR8971 - Rear	AR8971 - Rear	
Stabilizer Bar Bush	AR9378	AR9378	AR9378	AR9378	
Strut Mounting	AR9358	AR9358	AR9358	AR9358	
Miscellaneous	AR1019 - Brake Pedal (Man.) AR1020 - Brake Pedal (Auto.) AR1021 - Clutch Pedal Rubber	AR1019 - Brake Pedal (Man.) AR1020 - Brake Pedal (Auto.) AR1021 - Clutch Pedal Rubber	AR1019 - Brake Pedal (Man.) AR1020 - Brake Pedal (Auto.) AR1021 - Clutch Pedal Rubber	AR1019 - Brake Pedal (Man.) AR1020 - Brake Pedal (Auto.) AR1021 - Clutch Pedal Rubber	
REAR SUSPENSION					
Centre Bearing Rubber	AR7053 - Alt. (335i) AR9366 (335i, 340i)	AR1033 (320d - B47, 328i) AR7053 (320d - N47)	AR1033 (Excl. 340i)	AR7053	
Exhaust Hanger	AR9357 - Middle, Rear	AR9357 - Middle, Rear	AR9357 - Middle, Rear	AR9357 (Excl. 420d) AR9362 (420d)	
Lower Control Arm Bush - Inner					
Lower Control Arm Bush - Outer					
Propshaft Coupling	AR9365 - Front	AR5367 - Front AR9365 - Front (Alt.) (320d - N47) AR7143 - Rear	AR5367 - Front (320i) AR6192 - Front (Alt. 320i) AR9365 - Front (335i, 340i) AR7143 - Rear (320i)	AR5367 - Front AR7143 - Rear	
Stabilizer Bar Bush	AR8976 (ID: 12mm) with Adaptive Suspension AR8977 (ID: 13mm) without Adaptive Suspension	AR8976 (ID: 12mm) with Adaptive Suspension AR8977 (ID: 13mm) without Adaptive Suspension AR1022 (ID: 14mm)	AR8976 (ID: 12mm) with Adaptive Suspension AR8977 (ID: 13mm) without Adaptive Suspension AR1022 (ID: 14mm)	AR8976 (ID: 12mm) with Adaptive Suspension AR8977 (ID: 13mm) without Adaptive Suspension AR1022 (ID: 14mm)	
Strut Mounting	AR1127 Vehicles with Electronic Suspension Control	AR1127 Vehicles with Electronic Suspension Control	AR1127 Vehicles with Electronic Suspension Control	AR1127 Vehicles with Electronic Suspension Control	
Miscellaneous	AR8972 Rear Axle Carrier Bush - Front Outer AR8973 Rear Axle Carrier Bush - Front Centre AR8974 Rear Axle Carrier Bush - Rear Outer AR8975 Rear Axle Carrier Bush - Rear Outer AR1025 Upper Trailing Arm - Front LHS AR1026 Upper Trailing Arm - Front RHS AR1027 Upper Trailing Arm - Rear LHS AR1028 Upper Trailing Arm - Rear LHS AR1029 Lower Trailing Arm - Front L/RHS AR1030 Lower Trailing Arm - Rear L/RHS	AR8972 Rear Axle Carrier Bush - Front Outer AR8973 Rear Axle Carrier Bush - Front Centre AR8974 Rear Axle Carrier Bush - Rear Outer AR8975 Rear Axle Carrier Bush - Rear Outer AR1025 Upper Trailing Arm - Front LHS AR1026 Upper Trailing Arm - Front RHS AR1027 Upper Trailing Arm - Rear LHS AR1028 Upper Trailing Arm - Rear LHS AR1029 Lower Trailing Arm - Front L/RHS AR1030 Lower Trailing Arm - Rear L/RHS	AR8972 Rear Axle Carrier Bush - Front Outer AR8973 Rear Axle Carrier Bush - Front Centre AR8974 Rear Axle Carrier Bush - Rear Outer AR8975 Rear Axle Carrier Bush - Rear Outer AR1025 Upper Trailing Arm - Front LHS AR1026 Upper Trailing Arm - Front RHS AR1027 Upper Trailing Arm - Rear LHS AR1028 Upper Trailing Arm - Rear LHS AR1029 Lower Trailing Arm - Front L/RHS AR1030 Lower Trailing Arm - Rear L/RHS	AR8972 Rear Axle Carrier Bush - Front Outer AR8973 Rear Axle Carrier Bush - Front Centre AR8974 Rear Axle Carrier Bush - Rear Outer AR8975 Rear Axle Carrier Bush - Rear Outer AR1025 Upper Trailing Arm - Front LHS AR1026 Upper Trailing Arm - Front RHS AR1027 Upper Trailing Arm - Rear LHS AR1028 Upper Trailing Arm - Rear LHS AR1029 Lower Trailing Arm - Front L/RHS AR1030 Lower Trailing Arm - Rear L/RHS	

APPLICATIONS	BMW 4-SERIES F32 - COUPE 420d 2.0 - N47 435i 3.0 - N55 440i 3.0 - B58	BMW 4-SERIES F33 - CABRIOLET 420i 2.0 - B48, N20 428i 2.0 - N20, N26 430i 2.0 - B48	BMW 4-SERIES F33 - CABRIOLET 435i 2.0 - N55 440i 3.0 - B58	BMW 4-SERIES F36 - GRAN COUPE 420d 2.0 - B47, N47 420i 2.0 - B48, N20 428i 2.0 - N26, N26 430i 2.0 - B48 435i 3.0 - N55 440i 3.0 - B58
YEARS	2014-	2014-	2014-	2014-
Engine Configuration	INLINE	INLINE	INLINE	INLINE
Engine Mounting - Left	AR9360 (420d) AR9383 (435i, 440i)	AR9383 (420i) AR1031 (430i)	AR9383	AR1031 (430i) AR1037 (420d - B47) AR9360 (420d - N47) AR9363 (420i) AR9383 (435i, 440i)
Engine Mounting - Right	AR9361 (420d) AR9384 (435i, 440i)	AR9384 (420i, 428i) AR1032 (430i)	AR9384	AR1032 (430i) AR1038 (420d - B47) AR9361 (420d - N47) AR9364 (420i, 428i) AR9384 (435i, 440i)
Transmission Mounting	AR8968 (420d) AR9385 (435i, 440i)	AR8968	AR9385	AR8968 (Excl. 435i, 440i) AR9385 (435i, 440i)
FRONT SUSPENSION				
Lower Control Arm Bush - Inner	AR8970 - Front	AR8970 - Front	AR8970 - Front	AR8970 - Front
Lower Control Arm Bush - Outer	AR8971 - Rear	AR8971 - Rear	AR8971 - Rear	AR8971 - Rear
Stabilizer Bar Bush	AR9378	AR9378	AR9378	AR9378
Steering Coupling				
Strut Mounting	AR9358	AR9358	AR9358	AR9358
Miscellaneous	AR1019 - Brake Pedal (Man.) AR1020 - Brake Pedal (Auto.) AR1021 - Clutch Pedal Rubber	AR1019 - Brake Pedal (Man.) AR1020 - Brake Pedal (Auto.) AR1021 - Clutch Pedal Rubber	AR1019 - Brake Pedal (Man.) AR1020 - Brake Pedal (Auto.) AR1021 - Clutch Pedal Rubber	AR1019 - Brake Pedal (Man.) AR1020 - Brake Pedal (Auto.) AR1021 - Clutch Pedal Rubber
REAR SUSPENSION				
Centre Bearing Rubber	AR7053 (Excl. 435i, 440i) AR9366 - Alt. (420d, 435i, 440i)	AR7053	AR7053 (Auto.) AR9366 - Alt. (Auto.)	AR7053 (Excl. 440i) AR9366 (440i)
Exhaust Hanger	AR9357 (Excl. 420d)	AR9357	AR9357	AR9357
Propshaft Coupling	AR5367 - Front (420d) AR9365 - Front (Alt.) AR7143 - Rear (420d)	AR5367 - Front AR6192 - Front (Alt.) (420i) AR7143 - Rear	AR9365 - Front	AR5367 - Front AR9365 - Front (Alt.) (420d, 435i, 440i) AR7143 - Rear (Excl. 435i, 440i)
Stabilizer Bar Bush	AR8976 (ID: 12mm) with Adaptive Suspension AR8977 (ID: 13mm) without Adaptive Suspension AR1022 (ID: 14mm)	AR8976 (ID: 12mm) with Adaptive Suspension AR8977 (ID: 13mm) without Adaptive Suspension AR1022 (ID: 14mm)	AR8976 (ID: 12mm) with Adaptive Suspension AR8977 (ID: 13mm) without Adaptive Suspension AR1022 (ID: 14mm)	AR8976 (ID: 12mm) with Adaptive Suspension AR8977 (ID: 13mm) without Adaptive Suspension AR1022 (ID: 14mm)
Strut Mounting	AR1127 Vehicles with Electronic Suspension Control	AR1127 M-Sport Suspension Vehicles with Electronic Suspension Control	AR1127 M-Sport Suspension Vehicles with Electronic Suspension Control	AR1127 M-Sport Suspension Vehicles with Electronic Suspension Control
Miscellaneous	AR8972 Rear Axle Carrier Bush - Front Outer AR8973 Rear Axle Carrier Bush - Front Centre AR8974 Rear Axle Carrier Bush - Rear Outer AR8975 Rear Axle Carrier Bush - Rear Outer AR1025 Upper Trailing Arm - Front LHS AR1026 Upper Trailing Arm - Front RHS AR1027 Upper Trailing Arm - Rear LHS AR1028 Upper Trailing Arm - Rear LHS AR1029 Lower Trailing Arm - Fr. L/RHS AR1030 Lower Trailing Arm - Rr. L/RHS	AR8972 Rear Axle Carrier Bush - Front Outer AR8973 Rear Axle Carrier Bush - Front Centre AR8974 Rear Axle Carrier Bush - Rear Outer AR8975 Rear Axle Carrier Bush - Rear Outer AR1025 Upper Trailing Arm - Front LHS AR1026 Upper Trailing Arm - Front RHS AR1027 Upper Trailing Arm - Rear LHS AR1028 Upper Trailing Arm - Rear LHS AR1029 Lower Trailing Arm - Fr. L/RHS AR1030 Lower Trailing Arm - Rr. L/RHS	AR8972 Rear Axle Carrier Bush - Front Outer AR8973 Rear Axle Carrier Bush - Front Centre AR8974 Rear Axle Carrier Bush - Rear Outer AR8975 Rear Axle Carrier Bush - Rear Outer AR1025 Upper Trailing Arm - Front LHS AR1026 Upper Trailing Arm - Front RHS AR1027 Upper Trailing Arm - Rear LHS AR1028 Upper Trailing Arm - Rear LHS AR1029 Lower Trailing Arm - Fr. L/RHS AR1030 Lower Trailing Arm - Rr. L/RHS	AR8972 Rear Axle Carrier Bush - Front Outer AR8973 Rear Axle Carrier Bush - Front Centre AR8974 Rear Axle Carrier Bush - Rear Outer AR8975 Rear Axle Carrier Bush - Rear Outer AR1025 Upper Trailing Arm - Front LHS AR1026 Upper Trailing Arm - Front RHS AR1027 Upper Trailing Arm - Rear LHS AR1028 Upper Trailing Arm - Rear LHS AR1029 Lower Trailing Arm - Fr. L/RHS AR1030 Lower Trailing Arm - Rr. L/RHS

APPLICATIONS	BMW 5-SERIES E28 520i 2.0 - M20B20 525e 2.5 - M30B27 528i 2.8 - M30B28 535i 3.5 - M30B35 M535i 3.5 6-Cyl. - M90	BMW 5-SERIES E28 M5 3.5 - MX30	BMW 5-SERIES E34 520i 2.0 - M50B20 525i 2.5 - M50B25	BMW 5-SERIES E34 M5 3.5 6-Cyl. - M50B35
YEARS	85-89	86-89	89-96	92-94
Engine Configuration	INLINE	INLINE	INLINE	INLINE
Engine Mounting - Left	AR5427 (520i) AR7260 (525e, 528i, 535i)	AR7260	AR7227 (520i) AR7228 (525i)	AR7229
Engine Mounting - Right	AR5427 (520i) AR7260 (525e, 528i, 535i)	AR7260	AR7227 (520i) AR7228 (525i)	AR7229
Transmission Mounting	AR5431 (520i, 525e) AR5421 (Man.) (528i, 535i) AR5439 (Auto.) (528i, 535i)	AR5421 (Man. Only)	AR5426 - Front L/RHS AR5508 - Rear RHS	AR5426 - L/RHS
FRONT SUSPENSION				
Upper Control Arm Bush - Inner	AR7190	AR7190	AR6177 - Rear	AR6177 - Rear
Upper Control Arm Bush - Outer				
Lower Control Arm Bush - Inner	AR7236	AR7236	AR7236	AR7236
Lower Control Arm Bush - Outer				
Stabilizer Bar Bush	AR5435	AR5435	AR7234	AR7234
Steering Coupling	AR7257	AR7257	AR7257	AR7257
Steering Rack Mounting				
Strut Mounting	AR7220	AR7220	AR7220	AR7251
Miscellaneous	AR7047 (Man.) Gear Shift Bush	AR123 Air Cleaner Mounting AR7047 (Man.) Gear Shift Bush	AR123 Air Cleaner Mounting	AR123 Air Cleaner Mounting AR7047 (Man.) Gear Shift Bush
REAR SUSPENSION				
Centre Bearing Rubber	AR6149 (Man.) AR7283 (Auto.)	AR6149 (Man.) AR7283 (Auto.)	AR6174	AR7201
Exhaust Hanger - Middle				
Exhaust Hanger - Rear				
Lower Control Arm Bush - Inner	AR5437 Semi Trailing Arm Bush Normal	AR5437 Semi Trailing Arm Bush Normal		
Lower Control Arm Bush - Outer	AR5437 Semi Trailing Arm Bush Normal	AR5437 Semi Trailing Arm Bush Normal		
Propshaft Coupling	AR5367 (520i Only)	AR5367	AR6192 (520i) AR2075 (525i)	AR2075
Stabilizer Bar Bush	AR5438			
Stabilizer Link Grommet	AR5436		AR7185	
Strut Mounting				
Miscellaneous			AR7232 Stabilizer Link & Trailing Arm Bush - Inner AR7240 Rear Axle Carrier Bush - Front AR7241 Rear Axle Carrier Bush - Rear	AR7194 Diff. Mounting AR7240 Rear Axle Carrier - Front AR7241 Rear Axle Carrier - Rear

APPLICATIONS	BMW 5-SERIES E34 530i 3.0 V8 - M60B30 535i 3.5 6-Cyl. - M30B35 540i 4.0 Edition V8 - M60B40	BMW 5-SERIES E39 523i 2.5 - M52 525i 2.5 - M54 528i 2.8 - M52 530d 3.0 Dies. - M57 530i 3.0 - M54	BMW 5-SERIES E39 540i 4.4 - M62 M5 3.6 - S38	BMW 5-SERIES E39 M5 4.9 V8 - S62	
	YEARS	95-96	96-04	98-04	99-04
	Engine Configuration	INLINE	INLINE	INLINE	INLINE
	Engine Mounting - Left	AR5509 (530i, 540i) AR7229 (535i)	AR7259 Petrol AR7304 Diesel	AR7272	AR7272
	Engine Mounting - Right	AR5511 (530i, 540i) AR7229 (535i)	AR7259 Petrol AR7305 Diesel	AR7273	AR7273
	Transmission Mounting	AR5426 - Front L/RHS	AR5426 - L/RHS	AR5426 - L/RHS	AR5426 - L/RHS
FRONT SUSPENSION					
Upper Control Arm Bush - Inner	AR6177 - Rear	AR7289		AR7191	
Upper Control Arm Bush - Outer					
Lower Control Arm Bush - Inner	AR7236				
Lower Control Arm Bush - Outer					
Shock Rubber - Front					
Stabilizer Bar Bush	AR7234				
Stabilizer Link Grommet					
Steering Coupling	AR7257				
Steering Rack Mounting					
Strut Mounting	AR7251	AR7196	AR7224	AR7224	
Miscellaneous	AR123 Air Cleaner Mounting AR7047 (Man.) Gear Shift Bush	AR7047 (Man.) Gear Shift Bush			
REAR SUSPENSION					
Centre Bearing Rubber	AR6174 (530i, 535i) AR7201 (540i)	AR6315		AR6315	
Exhaust Hanger - Middle	AR9357	AR5069 (2) (530d)			
Exhaust Hanger - Rear		AR5707 (2)	AR5707 (2)		
Lower Control Arm Bush - Inner					
Lower Control Arm Bush - Outer		AR7170 Wheel Carrier Bush Bottom	AR7170 Wheel Carrier Bush Bottom	AR7170 Wheel Carrier Bush Bottom	
Propshaft Coupling	AR2075	AR6192 (78mm x 110mm) AR5709 (105mm) (530d) AR5710 (110mm) (530d) AR2075 (530i)	AR5709 (105mm)	AR5709 (105mm)	
Stabilizer Bar Bush		AR1022 (ID: 14mm)	AR1022 (ID: 14mm)		
Stabilizer Link Grommet	AR7185				
Strut Mounting					
Miscellaneous	AR7194 Diff. Mounting AR7232 Stabilizer Link AR7240 Rear Axle Carrier - Front AR7241 Rear Axle Carrier - Rear	AR5179 Subframe Rear Axle Bush - Rear L/RHS AR7281 Rear Axle Carrier Bush - Front L/RHS AR7282 Rear Axle Carrier Bush - Front Centre AR7308 Rear Axle Carrier Bush - Rear Centre	AR5179 Subframe Rear Axle Bush - Rear L/RHS AR7281 Rear Axle Carrier Bush - Front L/RHS AR7282 Rear Axle Carrier Bush - Front Centre AR7308 Rear Axle Carrier Bush - Rear Centre	AR5179 Subframe Rear Axle Bush - Rear L/RHS AR7281 Rear Axle Carrier Bush - Front L/RHS AR7282 Rear Axle Carrier Bush - Front Centre AR7308 Rear Axle Carrier Bush - Rear Centre	

APPLICATIONS	BMW 5-SERIES E60 523i 2.5 - M52, M53 525i 2.5 - M54, N52 530d 3.0 - M57 530i 3.0 - M54, N52 545i 4.4 V8 - N62B44A	BMW 6-SERIES E63 / E64 645Ci 4.4	BMW 7-SERIES E23 728 2.8 - M30B28 728i 2.8 - M30B28 730 3.0 - M30B28 733i 3.2 - M30B32 735i 3.5 - M30 745i 3.5 6-Cyl. - S38	BMW 7-SERIES E32 730i 3.0 - M30, M60 735i 3.5 6-Cyl. - M30
YEARS	04-10	04-08	78-89	87-96
Engine Configuration	INLINE	INLINE	INLINE	INLINE
Engine Mounting - Left	AR7567 (Excl. 530d, 545i) AR7543 (530d) AR8154 (545i)	AR8154		AR5509 (M60) (V8) AR7229 (M30)
Engine Mounting - Right	AR7568 (Excl. 530d, 545i) AR7545 (530d) AR8155 (545i)	AR8155		AR5511 (M60) (V8) AR7229 (M30)
Transmission Mounting			AR5426 - L/RHS (728i) (1983) AR7291 (728, 735i, 745i) AR7292 (730, 733i) AR7295 (728i) (83-87)	AR7192 - Front L/RHS
FRONT SUSPENSION				
Upper Control Arm Bush - Inner	AR7562	AR7562	AR7300	AR6177 - Rear
Upper Control Arm Bush - Outer				
Lower Control Arm Bush - Inner			AR7298	AR7236
Lower Control Arm Bush - Outer				
Shock Rubber - Front				
Stabilizer Bar Bush		AR8156	AR7296	AR7296
Stabilizer Link Grommet			AR7303	
Steering Coupling			AR7257	AR7257
Steering Rack Mounting				
Strut Mounting	AR7196	AR7196	AR7306	AR7203
Miscellaneous			AR123 Air Cleaner Mounting AR7047 (Man.) Gear Shift Bush	AR123 Air Cleaner Mounting AR7047 (Man.) Gear Shift Bush
REAR SUSPENSION				
Centre Bearing Rubber			AR6149	AR6174
Exhaust Hanger - Middle				
Exhaust Hanger - Rear				
Lower Control Arm Bush - Inner				
Lower Control Arm Bush - Outer	AR7170 Wheel Carrier Bush Bottom	AR7170 Wheel Carrier Bush Bottom		
Propshaft Coupling	AR6182 (ID: 96mm) (12mm Thick, 6 Holes) AR6333 (ID: 110mm) (12mm Thick, 6 Holes) (530d)	AR8153	AR2075	AR2075
Stabilizer Bar Bush				
Stabilizer Link Grommet				AR7185 Link
Strut Mounting				
Miscellaneous			AR5437 Trailing Arm Bush AR7322 Diff. Mounting	AR7194 Diff. Mounting AR7239 Rear Axle Carrier - Centre AR7240 Rear Axle Carrier - Front AR7241 Rear Axle Carrier - Rear

APPLICATIONS	BMW 7-SERIES E32 740i 4.0 - M60, M62 750iL 5.0 V12 - M70	BMW 7-SERIES E38 740i 4.0 V8 - M60, 4.4 V8 - M62 750iL 5.4 V12 - M73	BMW 8-SERIES E31 850Ci 5.0 V12 - M70	BMW MINI COOPER R50 Cooper 1.6 - W10B16A R52 Cooper 1.6 Convertible - W10B16A, W11B16A R53 Cooper S 1.6 - W11B16A
YEARS	88-95	96-03	91-94	02-09
Engine Configuration	INLINE	INLINE	INLINE	TRANSVERSE
Engine Mounting - Front				
Engine Mounting - Rear				AR7054
Engine Mounting - Left	AR5509	AR7272	AR5509	AR6978
Engine Mounting - Right	AR5511	AR7273	AR5511	AR6976
Engine Mounting - Other				AR6914 Engine Support Bracket Bush
Transmission Mounting	AR5426 - Front L/RHS		AR7192	AR6953 (Auto.) AR6970 (Man.) AR7081 (Man. & Auto.) (R53) AR7083 (Man.) (R53) AR8202 - Alt. (Man.) (R53)
FRONT SUSPENSION				
Upper Control Arm Bush - Inner	AR6177 - Rear	AR7191	AR6177 - Rear	
Upper Control Arm Bush - Outer				
Lower Control Arm Bush - Inner	AR7236		AR7236	AR7169 - Rear
Lower Control Arm Bush - Outer				
Shock Rubber - Front				
Stabilizer Bar Bush	AR7296		AR7296	AR7347 (ID: 24mm) Sport Suspension AR8199 (ID: 16mm) Std. Suspension AR8200 (ID: 22.5mm) Std. Suspension
Stabilizer Link Grommet				
Steering Coupling	AR7257		AR7257	
Steering Rack Mounting				
Strut Mounting	AR7203	AR7167		AR7280 - L/RHS AR8201 - Alt. (R53)
Miscellaneous	AR123 Air Cleaner Mounting			
REAR SUSPENSION				
Centre Bearing Rubber	AR7201		AR7201	
Exhaust Hanger - Middle		AR5707		
Exhaust Hanger - Rear				
Lower Control Arm Bush - Inner				
Lower Control Arm Bush - Outer		AR7170 Wheel Carrier Bush Bottom		
Propshaft Coupling	AR5709	AR5709		
Stabilizer Bar Bush				
Stabilizer Link Grommet	AR7185 Link			
Strut Mounting				
Miscellaneous	AR7194 Diff. Mounting AR7239 Rear Axle Carrier - Centre AR7240 Rear Axle Carrier - Front AR7241 Rear Axle Carrier - Rear	AR5178 (2) Rear Axle Carrier Bush - Rear AR7282 (1) Rear Axle Carrier Bush - Front		AR5716 Trailing Arm AR5717 Trailing Arm Bush for AR5716

APPLICATIONS	BMW MINI COOPER R55 1.6 Clubman - N12B16A, N16B16A R56 1.6 Hatch - N12B16A, N16B16A R57 1.6 Convertible - N12B16A, N16B16A R58 1.6 Coupe - N16B16A R59 1.6 Roadster - N16B16A R60 1.6 Countryman - N16B16A R61 1.6 Paceman - N16B16A	BMW MINI COOPER S R55 1.6 Clubman - N14B16A, N18B16A R56 1.6 Hatch - N14B16A, N18B16A R57 1.6 Convertible - N14B16A, N18B16A R58 1.6 Coupe - N18B16A R59 1.6 Roadster - N18B16A R60 1.6 Countryman - N18B16A R61 1.6 Paceman - N18B16A	BMW MINI COOPER S 4X4 R60 1.6 Countryman - N18B16A R61 1.6 Paceman - N18B16A	BMW MINI COOPER JOHN R55 1.6 Clubman - N14B16C R56 1.6 Hatch - N14B16C, N18B16C R57 1.6 Convertible - N14B16C, N18B16C R58 1.6 Coupe - N14B16C, N18B16C R59 1.6 Roadster - N14B16C, N18B16C
	YEARS	2007-	2007-	2010-
Engine Configuration	TRANSVERSE	TRANSVERSE	TRANSVERSE	TRANSVERSE
Engine Mounting - Front				
Engine Mounting - Rear	AR8714	AR8714	AR8714	AR8714
Engine Mounting - Left				
Engine Mounting - Right	AR8715	AR8713	AR8713	AR8713
Engine Mounting - Other				
Transmission Mounting	AR5053 (N16B16A) (Man.) AR8716 (Auto.) AR8717 (N12B16A) (Man.)	AR5053 (Man.) AR8716 (Auto.)	AR5053 (Man.) AR8716 (Auto.)	AR5053 (Man.) AR8716 (Auto.)
FRONT SUSPENSION				
Upper Control Arm Bush - Inner				
Upper Control Arm Bush - Outer				
Lower Control Arm Bush - Inner	AR7169 - Rear	AR7169 - Rear	AR7169 - Rear	AR7169 - Rear
Lower Control Arm Bush - Outer				
Shock Rubber - Front				
Stabilizer Bar Bush	AR9641 (ID: 21.5mm) AR9642 (ID: 23.5mm) AR8200 (ID: 22.5mm) for Models with Sport Suspension	AR9641 (ID: 21.5mm) AR9642 (ID: 23.5mm)	AR9641 (ID: 21.5mm) AR9642 (ID: 23.5mm)	AR9641 (ID: 21.5mm) AR9642 (ID: 23.5mm)
Steering Coupling				
Steering Rack Mounting				
Strut Mounting	AR8718	AR8718	AR8718	AR8718
Miscellaneous				
REAR SUSPENSION				
Centre Bearing Rubber				
Exhaust Hanger - Middle				
Exhaust Hanger - Rear				
Lower Control Arm Bush - Inner				
Lower Control Arm Bush - Outer				
Propshaft Coupling				
Stabilizer Bar Bush	AR5027 (ID: 16mm) Std. Suspension AR7428 (ID: 16mm) Sport Suspension	AR5027 (ID: 16mm) Std. Suspension AR7428 (ID: 16mm) Sport Suspension	AR5027 Std. Suspension (ID: 16mm) AR7428 Sport Suspension (ID: 16mm)	AR5027 Std. Suspension (ID: 16mm) AR7428 Sport Suspension (ID: 16mm)
Stabilizer Link Grommet				
Strut Mounting	AR5718	AR5718	AR5718	AR5718
Miscellaneous	AR5716 Trailing Arm AR5717 Trailing Arm Bush for AR5716	AR5716 Trailing Arm AR5717 Trailing Arm Bush for AR5716	AR5716 Trailing Arm AR5717 Trailing Arm Bush for AR5716	AR5716 Trailing Arm AR5717 Trailing Arm Bush for AR5716

APPLICATIONS	BMW MINI COUNTRYMAN JCW R56 1.6 Hatch - N18B16C R60 1.6 Countryman - N18B16A	BMW MINI ONE R56 1.6 Hatch - N16B16A R57 1.6 Convertible - N16B16A	BMW MINI COOPER F54 1.5 Clubman 6-Spd. Man./Auto., 7-Spd. Dual Clutch - B36, B38 F55 1.5 Hatch 6-Spd. Man./Auto. - B36, B38 F56 1.5 Hatch 6-Spd. Man./Auto., 7-Spd. Dual Clutch - B36, B38 F57 1.5 Cabriolet 6-Spd. Man./Auto., 7-Spd. Dual Clutch - B36, B38 F60 1.5 Hatch 6-Spd. Man./Auto., 7-Spd. Dual Clutch - B36, B38	BMW MINI COOPER D F60 2.0 Countryman 6-Spd. Man. - B47
YEARS	2007-	2007-	2013-	2013-
Engine Configuration	TRANSVERSE	TRANSVERSE	TRANSVERSE	TRANSVERSE
Engine Mounting - Front				
Engine Mounting - Rear	AR8714	AR8714		
Engine Mounting - Left			AR1116 (Man.) AR1117 (Auto.)	AR1116
Engine Mounting - Right	AR8713	AR8715	AR1118 (Man.) AR1119 (Auto.) AR1133	AR1129
Engine Mounting - Other				
Transmission Mounting	AR5053 (Man.) AR8716 (Auto.)	AR5053 (Man.) AR8716 (Auto.)	AR1120 (Man.) AR1121 - Alt. AR1130 (Auto.)	AR1121 AR1130 - Alt.
FRONT SUSPENSION				
Upper Control Arm Bush - Inner				
Upper Control Arm Bush - Outer				
Lower Control Arm Bush - Inner	AR7169 - Rear	AR7169 - Rear	AR1122 - Front	AR1122 - Front
Lower Control Arm Bush - Outer			AR1123L - Rear LHS AR1123R - Rear RHS	AR1123L - Rear LHS AR1123R - Rear RHS
Shock Rubber - Front				
Stabilizer Bar Bush	AR9641 (ID: 21.5mm) AR9642 (ID: 23.5mm)	AR9641 (ID: 21.5mm) AR9642 (ID: 23.5mm)		
Steering Coupling				
Steering Rack Mounting				
Strut Mounting	AR8718	AR8718	AR1125 Standard Suspension AR1126 Vehicles with Electronic Suspension Control	AR1126 Vehicles with Electronic Suspension Control
Miscellaneous				
REAR SUSPENSION				
Centre Bearing Rubber				
Exhaust Hanger				
Lower Control Arm Bush - Inner				
Lower Control Arm Bush - Outer				
Propshaft Coupling				
Stabilizer Bar Bush	AR5027 Std. Suspension (ID: 16mm) AR7428 Sport Suspension (ID: 16mm)	AR5027 Std. Suspension (ID: 16mm) AR7428 Sport Suspension (ID: 16mm)		
Stabilizer Link Grommet				
Strut Mounting	AR5718	AR5718	AR1127 Standard Suspension	AR1127 Standard Suspension
Miscellaneous	AR5716 Trailing Arm AR5717 Trailing Arm Bush for AR5716	AR5716 Trailing Arm AR5717 Trailing Arm Bush for AR5716	AR1131 Lateral Link - Upper L/RHS AR1132 Lateral Link - Lower L/RHS	AR1131 Lateral Link - Upper L/RHS AR1132 Lateral Link - Lower L/RHS

APPLICATIONS	BMW MINI COOPER S F54 2.0 Clubman 6-Spd. Man. - B46, B48 F55 2.0 Hatch 6-Spd. Man. - B46, B48 F56 2.0 Hatch 6-Spd. Man. - B46, B48 F57 2.0 Cabriolet 6-Spd. Man. - B46, B48 F60 2.0 Countryman 6-Spd. Man. - B46, B48	BMW MINI JCW ALL4 F54 2.0 Clubman 6-Spd. Man. AWD - B48 F56 2.0 Hatch 6-Spd. Man. AWD - B46, B48 F60 2.0 Countryman 6-Spd. Man. AWD - B48	BMW MINI ONE F55 1.2 6-Spd. Man./Auto. - B38 F56 1.2 6-Spd. Man./Auto. - B38, 1.5 6-Spd. Man. - B38	BMW X1 4X2 F48 sDrive18i 1.5 - B38 sDrive20d 2.0 - B47, B47 sDrive20i 2.0 - B48 xDrive20d 2.0 - B47 xDrive20i 2.0 - B48 xDrive25i 2.0 - B42, B46, B48
YEARS	2013-	2013-	2013-	2015-
Engine Configuration	TRANSVERSE	TRANSVERSE	TRANSVERSE	TRANSVERSE
Engine Mounting - Front				
Engine Mounting - Rear				
Engine Mounting - Left	AR1116	AR1116	AR1116 (Man.) AR1117 (Auto.)	AR1116 (Man.) (sDrives Only) AR1117 (Auto.) (sDrive18i, 20d)
Engine Mounting - Right	AR1133	AR1133	AR1118 (Man.) AR1119 (Auto.)	AR1118 (18i Man.) AR1119 (18i Auto.) AR1129 (sDrive20d Auto.) AR1133 (20d, 20i, 25i)
Engine Mounting - Other				
Transmission Mounting	AR1121 AR1130 - Alt.	AR1121 AR1130 - Alt.	AR1120 (Man.) AR1121 - Alt. AR1130 (Auto.)	AR1120 (18i Man.) AR1121 (18i, 20d, 20i) AR1130 (20d, 20i, 25i)
FRONT SUSPENSION				
Upper Control Arm Bush - Inner				
Upper Control Arm Bush - Outer				
Lower Control Arm Bush - Inner	AR1122 - Front	AR1122 - Front	AR1122 - Front	AR1122 - Front
Lower Control Arm Bush - Outer	AR1123L - Rear LHS AR1123R - Rear RHS	AR1123L - Rear LHS AR1123R - Rear RHS	AR1123L - Rear LHS AR1123R - Rear RHS	AR1123L - Rear LHS AR1123R - Rear RHS
Shock Rubber - Front				
Stabilizer Bar Bush				AR1124
Steering Coupling				
Steering Rack Mounting				
Strut Mounting	AR1125 Standard Suspension AR1126 Vehicles with Electronic Suspension Control	AR1125 Standard Suspension AR1126 Vehicles with Electronic Suspension Control		AR1125 Standard Suspension AR1126 Vehicles with Electronic Suspension Control
Miscellaneous				
REAR SUSPENSION				
Centre Bearing Rubber				
Exhaust Hanger				AR9357
Lower Control Arm Bush - Inner				
Lower Control Arm Bush - Outer				
Propshaft Coupling				AR6192 (xDrive20d, 20i)
Stabilizer Bar Bush				
Stabilizer Link Grommet				
Strut Mounting	AR1127 Standard Suspension	AR1127 Standard Suspension	AR1127 Standard Suspension	AR1127 M-Sport Suspension AR1128 Standard Suspension
Miscellaneous	AR1131 Lateral Link - Upper L/RHS AR1132 Lateral Link - Lower L/RHS	AR1131 Lateral Link - Upper L/RHS AR1132 Lateral Link - Lower L/RHS	AR1131 Lateral Link - Upper L/RHS AR1132 Lateral Link - Lower L/RHS	AR1131 Lateral Link - Upper L/RHS AR1132 Lateral Link - Lower L/RHS

APPLICATIONS	BMW X2 4X2 F39 sDrive18i 1.5 M-Sport - B38 sDrive20i 2.0 M-Sport - B42, B48 xDrive20d 2.0 M-Sport - B47	BMW X3 4X4 E83 2.5i SUV M54, LCi SUV - N52N 3.0d SUV - M57N2 3.0si - N52N	BMW X3 4X4 E83 2.0d Steptronic SUV Dies. - M47N2 2.0i - N46	BMW X5 4X4 E53 3.0d Steptronic SUV Dies. - M57N 3.0i Steptronic SUV 6-Cyl. Pet. - M54 4.4i Steptronic SUV Pet. - M62 4.8iS Steptronic SUV V8 Pet. - N62
YEARS	2018-	04-07	04-10	01-10
Engine Configuration	TRANSVERSE	INLINE	INLINE	INLINE
Engine Mounting - Left	AR1116 (sDrives Only)	AR8166 (2.5i, 3.0si) AR8168 (3.0d)	AR8162 (2.0d) AR8164 (2.0i)	AR8177 (3.0d, 3.0i) AR8182 (4.4i, 4.4is)
Engine Mounting - Right	AR1118 (18i) AR1119 (18i 6-Spd. Man.) AR1133 (20d, 20i)	AR8167 (2.5i, 3.0si)	AR8163 (2.0d) AR8165 (2.0i)	AR8177 (3.0d, 3.0i) AR8182 (4.4i, 4.4is)
Transmission Mounting	AR1120 (18i Man.) AR1121 (18i 7-Spd. Dual Clutch) AR1130 (20i, 20d)	AR8171 (3.0d) AR8172 (2.5i, 3.0si)	AR8170 (2006-)	AR8178 (3.0d, 3.0i) AR8183 (4.4i, 4.8is)
FRONT SUSPENSION				
Upper Control Arm Bush - Inner			AR7243 - Front	
Upper Control Arm Bush - Outer				
Lower Control Arm Bush - Inner	AR1122 - Front		AR7236	AR7236 - Rear AR7245 - Front
Lower Control Arm Bush - Outer	AR1123L - Rear LHS AR1123R - Rear RHS			
Shock Rubber - Front				
Stabilizer Bar Bush		AR8173	AR7250 (ID: 29mm)	AR7250 (ID: 29mm)
Steering Coupling				
Steering Rack Mounting				
Strut Mounting	AR1125 Standard Suspension AR1126 Vehicles with Dynamic Damper Control	AR7196	AR7196	AR7254
Miscellaneous				
REAR SUSPENSION				
Centre Bearing Rubber				AR7256 - Rear
Exhaust Hanger - Middle	AR9357			AR5715 (3.0)
Exhaust Hanger - Rear	AR9357			AR5714 Silencer
Lower Control Arm Bush - Inner				
Lower Control Arm Bush - Outer				AR7170 Wheel Carrier Bottom
Propshaft Coupling	AR6192 (xDrive20d)	AR2075 - Rear (96mm) AR7255 - Front (78mm)	AR2075 - Rear (96mm) AR7255 - Front (78mm)	AR2075 - Rear (96mm) AR7255 - Front (78mm)
Stabilizer Bar Bush		AR8176		
Stabilizer Link Grommet				
Strut Mounting	AR1127 M-Sport Suspension AR1128 Standard Suspension	AR8174		
Miscellaneous	AR1131 Lateral Link - Upper L/RHS AR1132 Lateral Link - Lower L/RHS	AR7244 Rear Trailing Arm Bush		AR7277 (4) Rear Axle Carrier Bush AR7278 (2) Rear Axle Carrier Bush - Front, Centre AR7279 (1) Rear Axle Carrier Bush - Rear LHS

APPLICATIONS	C.A.M	C.A.M INYATHI	C.A.M RHINO	CHANA	CHANA STAR
		2.2i Bus, P/van - SF491QE	2.2i - JM491QME		1.0 Club Cab 1.3 Single Cab
YEARS		2006-	2007-		06-12
Engine Configuration		INLINE	INLINE		INLINE
Engine Mounting - Front					
Engine Mounting - Rear					
Engine Mounting - Left		AR5337	AR5337		AR8326 (1.0) AR8386 (1.3)
Engine Mounting - Right		AR5337	AR5337		AR8327 (1.0) AR8387 (1.3)
Engine Mounting - Other					
Transmission Mounting		AR5363	AR5363		AR8317 (1.0) AR8388 (1.3)
		FRONT SUSPENSION			
Upper Control Arm Bush - Inner		AR6051 - Front			
Upper Control Arm Bush - Outer		AR6052 - Rear			
Lower Control Arm Bush - Inner		AR6425 AR6053 - Alt.	AR5546		AR8306
Lower Control Arm Bush - Outer			AR5546		
Shock Rubber - Front					
Stabilizer Bar Bush		AR6419			
Steering Coupling					
Steering Rack Mounting					
Strut Mounting					
Miscellaneous					
		REAR SUSPENSION			
Exhaust Hanger - Middle					
Exhaust Hanger - Rear					
Lower Control Arm Bush - Inner					
Lower Control Arm Bush - Outer					
Shackle Bush - Front		AR5370 (2)			
Shackle Bush - Rear Upper		AR5376 (2)			
Shackle Bush - Rear Lower		AR5370 (2)			
Stabilizer Bar Bush					
Strut Mounting					
Miscellaneous					

APPLICATIONS	CHERY	CHERY	CHEVROLET	CHEVROLET AVEO T200	CHEVROLET CAPTIVA	CHEVROLET CAPTIVA
		2008-		1.5 L, LS, LT - F15S, LX6 1.6 LT - A16DMS, LXV	2.0D LT AWD 5-Spd. Man. - Z20S1 2.4 LT 4x2 5-Spd. Man. - Z20S1 2.4 LT AWD 5-Spd. Man. - Z20SED 3.2 LTZ AWD 5-Spd. Auto. - 10HM	2.2D LTZ 4x2, AWD 6-Spd. Auto. - Z22D1 2.4 LT AWD 5-Spd. Man. - Z24SED 2.4 LT 4x2 6-Spd. Auto. - LE5, 6-Spd. Man. - LE9 3.0 LTZ AWD 6-Spd. Auto. - LF1, LFW
YEARS		2008-		03-15	07-11	2011-
Engine Configuration				TRANSVERSE	TRANSVERSE	TRANSVERSE
Engine Mounting - Front					AR8836 (2.0) AR8723 (2.4)	AR1052 (2.2D AWD & 4x2) AR1056 (2.4) AR1060 (3.0)
Engine Mounting - Rear				AR8372	AR9393 (2.0, 2.4)	AR1053 (2.2D AWD & 4x2) AR1057 (2.4) AR1061 (3.0)
Engine Mounting - Left				AR8371		
Engine Mounting - Right				AR8370	AR8835 (2.0) AR8722 (2.4)	AR1054 (2.2D AWD & 4x2) AR1058 (2.4) AR1062 (3.0)
Engine Mounting - Other						
Transmission Mounting					AR8724 (Man.)	
				FRONT SUSPENSION		
Upper Control Arm Bush - Inner						
Upper Control Arm Bush - Outer						
Lower Control Arm Bush - Inner				AR8314 AR9923 (2011-)	AR8831 - Front	AR8831 - Front
Lower Control Arm Bush - Outer				AR8315 AR9924 (2011-)	AR8832 - Rear AR8832I Insert Only	AR8832 - Rear AR8832I Insert Only
Shock Rubber - Front						
Stabilizer Bar Bush		AR9691 (J1) Stabilizer Link Pin Bush		AR9389 (ID: 16mm)	AR8830	AR8830
Steering Coupling						
Steering Rack Mounting						
Strut Mounting				AR8316 AR9853 - Alt.	AR8834	AR8834
Miscellaneous				AR9387 Front Axle Beam Bush - Front AR9388 Front Axle Beam Bush - Rear		
				REAR SUSPENSION		
Centre Bearing Rubber					AR9392	AR9392
Lower Control Arm Bush - Inner						
Lower Control Arm Bush - Outer						
Propshaft Coupling						
Shacke Bush - Front						
Shacke Bush - Rear Upper						
Shacke Bush - Rear Lower						
Stabilizer Bar Bush					AR8837	AR8837
Stabilizer Link Grommet						AR1065
Strut Mounting						
Miscellaneous				AR9386 Rear Axle Beam Bush	AR8833 Rear Axle Diff. Bush - Centre AR9390 Front Axle Beam Bush AR9391 Rear Axle Beam Bush AR9391 Rear Axle Beam Bush	AR8833 Rear Axle Diff. Bush - Centre AR9390 Front Axle Beam Bush AR9391 Rear Axle Beam Bush AR1066 Lateral Link - Lower AR1067 Lateral Link - Upper

APPLICATIONS	CHEVROLET CORSA	CHEVROLET CRUZE	CHEVROLET OPTRA	CHEVROLET ORLANDO
	1.4 AC, Club, Sport 1.7 DTi, Club, Sport, 1.8 Club, Sport UTILITY 1.3D AC, Club, Sport 1.4 AC, Club, Sport 1.8 AC, Club, Sport	1.4T LS 6-Spd. Man. - A14NET, 6-Spd. Auto. - B14NET 1.6 L, LS 5-Spd. Man. - F16D4 1.8 LS 5-Spd. Man., 6-Spd. Auto. - F18D4 2.0D LT 5-Spd. Man - Z20S1, 6-Spd. Man. - Z20D12, 6-Spd. Auto. - Z20D13	1.6 - F16D3 1.8 - T18SED	1.8 5-Spd. Man. - F18D4
YEARS	2010-	09-15	04-11	2011-
Engine Configuration	TRANSVERSE	TRANSVERSE	TRANSVERSE	TRANSVERSE
Engine Mounting - Front	AR8236	AR1074 (A14NET) AR1079 (2.0D 6-Spd. Auto.) AR1080 (2.0D 5-Spd. Man.) AR1135 (B14NET) AR1139 (1.6, 1.8 Man.) AR1164 (1.8 Auto.) AR9396 (2.0D 6-Spd. Man.)		AR1139
Engine Mounting - Rear	AR6260	AR9394	AR8745 (1.8) Lower Torque Rod AR9030 (1.6)	AR9394
Engine Mounting - Left	AR6258 AR8061 - Alt.			
Engine Mounting - Right	AR6259	AR1077 (Z20D1) AR1078 (Z20S1) AR9395 (1.4, 1.6, 1.8)	AR8743 AR8744 Torque Rod	AR9395
Engine Mounting - Other				
Transmission Mounting	AR8779	AR1069 (2.0D 6-Spd. Man.) AR1070 (B14NET) AR1071 (A14NET) AR1076 (1.6, 1.8 Man.) AR1081 (2.0D 6-Spd. Auto) AR1082 (2.0D 5-Spd. Man.) AR1165 (1.8 Auto.)	AR8746	AR1076
FRONT SUSPENSION				
Upper Control Arm Bush - Inner				
Upper Control Arm Bush - Outer				
Lower Control Arm Bush - Inner	AR6855	AR8485 - Front	AR9024 - Front	AR8485 - Front
Lower Control Arm Bush - Outer	AR6855	AR8486 - Rear	AR9023 - Rear	AR8486 - Rear
Shock Rubber - Front				
Stabilizer Bar Bush	AR9883	AR8487	AR9027 (ID: 17mm) AR9028 (ID: 18mm)	AR8487
Steering Coupling				
Steering Rack Mounting				
Strut Mounting		AR8845	AR9025	AR8845
Tension Rod Bush	Utility: AR1083L - with Bracket AR1083R - with Bracket			
Miscellaneous				
REAR SUSPENSION				
Centre Bearing Rubber				
Exhaust Hanger - Front		AR1075		
Exhaust Hanger - Middle				
Exhaust Hanger - Rear				
Lower Control Arm Bush - Inner				
Lower Control Arm Bush - Outer				
Propshaft Coupling				
Stabilizer Bar Bush	AR1171 Utility		AR9029	
Stabilizer Link Grommet				
Strut Mounting		AR8846	AR9026	AR8846
Miscellaneous	AR9860 Rear Axle Beam Bush	AR8847 Rear Axle Beam Bush		AR8847 Rear Axle Beam Bush

APPLICATIONS	CHEVROLET SONIC 1.3D - LSF 1.4 - A14XER 1.6 - F16D4	CHEVROLET SPARK M150 0.8 L, LS - F8CV 1.0 LS, LT - B10S1	CHEVROLET SPARK M200, M250 SPARK LITE 0.8 - F8CV 1.0 - B10S1	CHEVROLET SPARK M300 1.2 Campus, Curved, Pronto - B12D1
YEARS	11-16	03-05	2005-	2010-
Engine Configuration	TRANSVERSE	TRANSVERSE	TRANSVERSE	TRANSVERSE
Engine Mounting - Front		AR7329		
Engine Mounting - Rear	AR8372 AR9818 AR9919 - Alt.		AR9397	
Engine Mounting - Left	AR8371 AR8812 - Alt. (Auto.)			
Engine Mounting - Right	AR8370 AR9918 - Alt. (Man.) AR9815 - Alt.	AR7326	AR8805	AR1096
Engine Mounting - Other				
Transmission Mounting		AR7327 (1.0)	AR1095	AR1097 Rear AR9968 Support Rod
FRONT SUSPENSION				
Upper Control Arm Bush - Inner				
Upper Control Arm Bush - Outer				
Lower Control Arm Bush - Inner	AR8314 AR9923 - Alt.	AR1041	AR1041	AR9887 - Front
Lower Control Arm Bush - Outer	AR8315 AR9924 - Alt.	AR9398	AR9398	AR9888 - Rear
Shock Rubber - Front				
Stabilizer Bar Bush	AR9389 (ID: 16mm)	AR5140	AR5140	AR5140
Steering Coupling				
Steering Rack Mounting				
Strut Mounting	AR8316 AR9742 - Alt.		AR8316 AR9853 - Alt.	AR9742
Tension Rod Bush				
Miscellaneous	AR9387 Front Axle Beam Bush - Front AR9388 Front Axle Beam Bush - Rear			
REAR SUSPENSION				
Centre Bearing Rubber				
Exhaust Hanger - Middle				
Exhaust Hanger - Rear				
Lower Control Arm Bush - Inner				
Lower Control Arm Bush - Outer				
Propshaft Coupling				
Stabilizer Bar Bush				
Stabilizer Link Grommet				
Strut Mounting				
Miscellaneous	AR9386 Rear Axle Beam Bush	AR9386 Rear Axle Beam Bush	AR9386 Rear Axle Beam Bush	

APPLICATIONS	CHEVROLET TRAILBLAZER 2.5D - XLD25 2.8D 4x2, 4x4 - LWH 3.6 4x4 - LY7	CHRYSLER	CHRYSLER NEON 1.6 SE - EDJ 2.0 LX, RT	CHRYSLER VOYAGER 2.4 SE 3.3 SE		
YEARS	2012-		00-06	97-04		
Engine Configuration			TRANSVERSE	TRANSVERSE		
Engine Mounting - Front				AR8699		
Engine Mounting - Rear						
Engine Mounting - Left	AR9877 (2.5, 2.8) AR9879 (3.6)		AR8843			
Engine Mounting - Right	AR9877 (2.5, 2.8) AR9879 (3.6)		AR8850 - Front AR8851 - Middle AR8852 - Rear			
Engine Mounting - Other						
Transmission Mounting	AR9878			AR8698		
FRONT SUSPENSION			FRONT SUSPENSION			
Upper Control Arm Bush - Inner	AR9880 - Front					
Upper Control Arm Bush - Outer	AR9880 - Rear					
Lower Control Arm Bush - Inner	AR9881 - Front		AR8854 - Front			
Lower Control Arm Bush - Outer	AR9881 - Rear		AR8853 - Rear			
Shock Rubber - Front						
Stabilizer Bar Bush	AR9883					
Stabilizer Link Grommet						
Steering Coupling						
Steering Rack Mounting						
Strut Mounting	AR9876		AR8855			
Tension Rod Bush						
Miscellaneous						
REAR SUSPENSION			REAR SUSPENSION			
Centre Bearing Rubber						
Exhaust Hanger - Middle						
Exhaust Hanger - Rear						
Lower Control Arm Bush - Inner						
Lower Control Arm Bush - Outer						
Propshaft Coupling						
Stabilizer Bar Bush	AR1084					
Stabilizer Link Grommet						
Strut Mounting		AR8856				
Miscellaneous	AR1085 Upper Trailing Link AR1086 Lower Trailing Link AR1087 Lateral Link					

APPLICATIONS	CITROEN	CITROEN BERLINGO	CITROEN BERLINGO	CITROEN C1	CITROEN C2
		1.4i Multispace, Multispace Executive MPV, P/van - TU3JP 1.9D P/van Dies. - XUD9A	1.6 - TU5JP4B 1.6 HDi 90 16V - DV6TED4BU, DV6AUTED4	1.0 - 1KR-FE 1.0i - 1KR-FE	1.4i VTR - TU3JP 1.4 HDi - DV4TD 1.6 VTS - TU5J4S
YEARS		03-10	2011-	2007-	02-10
Engine Configuration		TRANSVERSE	TRANSVERSE	TRANSVERSE	TRANSVERSE
Engine Mounting - Front					
Engine Mounting - Rear		AR7332 - RHS (1.4) AR5872 - RHS (1.9)	AR8516 Bush	AR8503	AR8511
Engine Mounting - Left		AR7334 (1.4) AR5797 (1.9)	AR7334	AR8504	AR8512
Engine Mounting - Right		AR7331 Buffer Bracket AR7333 (1.4) AR7337 (1.9)	AR5800	AR8502	AR9407 (1.4, 1.4i)
Engine Mounting - Other					
Transmission Mounting					
		FRONT SUSPENSION			
Upper Control Arm Bush - Inner					
Upper Control Arm Bush - Outer					
Lower Control Arm Bush - Inner		AR5181 - Front (2)	AR5884 - Front	AR8497 - Rear	AR7338 - Front
Lower Control Arm Bush - Outer		AR5180 - Rear	AR5789 - Rear	AR8498 - Front	AR7339 - Rear
Shock Rubber - Front					
Stabilizer Bar Bush			AR9401 (ID: 24.5mm) AR9402 (ID: 21mm) AR9403 (ID: 23mm)	AR8499	AR9406
Stabilizer Link Grommet				AR9404 Stabilizer Link Pin Kit	
Steering Coupling					
Steering Rack Mounting					
Strut Mounting		AR5171	AR5885	AR8500	AR8428 Locating Pin Middle AR8981 Locating Pin Off Centre
Miscellaneous					
		REAR SUSPENSION			
Centre Bearing Rubber					
Exhaust Hanger - Middle					
Exhaust Hanger - Rear					
Lower Control Arm Bush - Inner					
Lower Control Arm Bush - Outer					
Propshaft Coupling					
Shacke Bush - Front					
Shacke Bush - Rear Upper					
Shacke Bush - Rear Lower					
Stabilizer Bar Bush					
Strut Mounting					
Miscellaneous			AR9399 Rear Axle Beam Bush Standard Suspension AR9400 Rear Axle Beam Bush Heavy Duty Suspension	AR8501 Rear Axle Beam Bush	AR9405 Rear Axle Beam Bush

APPLICATIONS	CITROEN C3	CITROEN C3 PICASSO	CITROEN C4	CITROEN C4 - B7
	1.0i VTi 68, Attraction - ZMZ-EBO 1.2i VTi 82, Attraction, Seduction - HMZ-EB2/F 1.4i Attraction, Seduction - 8FP-EP3C, TU3A 1.6i Exclusive, Seduction - 5FS-EP6C, TU5JP4 1.6i e-HDi 90, Seduction - 9HJ/P-DV6DTED/M 1.6i HDi 90, Seduction - 9HX-DV6ATED4 1.6i VTi120, Exclusive, Seduction - 5FS-EP6C	1.6i VTi 120 Seduction, Panoramic - 5FS-EP6C, 5FW-EP6	1.6 HDi - DV6TED4 1.6i VTi 120 - 5FW-EP6 2.0 VTS Coupe - EW10J4S	1.6i THP 150 - 5FX-EP6DT 1.6i VTi 120 - 5FS-EP6C, 5FW-EP6
YEARS	2010-	2010-	05-10	2010-
Engine Configuration	TRANSVERSE	TRANSVERSE	TRANSVERSE	TRANSVERSE
Engine Mounting - Front			AR8515 to fit "Eye" Joint Link	
Engine Mounting - Rear	AR1088 (1.0, 1.2) AR1112 (1.6 e-/HDI) AR8511 (1.4, 1.6 Auto.) AR8513 (1.6 Man)	AR1112	AR8516 Bush (1.6) AR8517 Bush (2.0)	
Engine Mounting - Left	AR8512		AR7334 (1.6) AR5797 (2.0)	AR1094
Engine Mounting - Right	AR1089 (1.4, 1.6) AR1111 - Alt. (1.6)	AR1113	AR8761 (1.6) AR9722 (2.0)	
Engine Mounting - Other				
Transmission Mounting				AR1092 (5FS-EP6C)
FRONT SUSPENSION				
Upper Control Arm Bush - Inner				
Upper Control Arm Bush - Outer				
Lower Control Arm Bush - Inner	AR1090 - Front AR8505 - Front		AR5884 - Front	
Lower Control Arm Bush - Outer	AR1091 - Rear AR8506 - Rear		AR5789 - Rear	
Shock Rubber - Front				
Stabilizer Bar Bush	AR8507 (ID: 20mm) AR8508 (ID: 21mm)		AR5755 (ID: 20mm)	
Steering Coupling				
Steering Rack Mounting				
Strut Mounting	AR8509 AR8428 - Alt. Locating Pin Centre AR8981 Locating Pin Off Centre AR1107 - Alt.	AR1107	AR8514	
Miscellaneous				
REAR SUSPENSION				
Centre Bearing Rubber				
Exhaust Hanger - Middle				
Exhaust Hanger - Rear				
Lower Control Arm Bush - Inner				
Lower Control Arm Bush - Outer				
Propshaft Coupling				
Stabilizer Bar Bush				
Stabilizer Link Grommet				
Strut Mounting				
Miscellaneous			AR1093 (1.6 VTi, 2.0) Rear Axle Beam Bush	

APPLICATIONS	CITROEN C4 AIRCROSS 1.6i HDi 115 - 9HD-DV6C 2.0i - 4B11	CITROEN C4 CACTUS 1.2i VTi 82, Attraction, Seduction - HMZ-EB2F 1.2i e-THP Puretech - HNP-EB2ADT, HNV- EB2DTM, HNZ-EB2DT	CITROEN C4 PICASSO 1.6i e-HDi Intensive, Seduction - 9HC-DV6C, BHX-DV6FC 1.6i e-THP Intensive - 5FS-EP6C 1.6i VTi 120 - 5FS-EP6C, 5GZ-EP6FDT GRAND PICASSO 1.6i VTi 120 Seduction - 5FW-EP6	CITROEN C5 2.0 SX - EW10J4S
	YEARS	2010-	2015-	2011-
Engine Configuration	TRANSVERSE	TRANSVERSE	TRANSVERSE	TRANSVERSE
Engine Mounting - Front				
Engine Mounting - Rear	AR9564	AR1088 AR1112 - Alt. (1.2 e-THP)	AR1108	
Engine Mounting - Left	AR5797 (1.6) AR9426 (2.0)			AR5797
Engine Mounting - Right	AR9418 (1.6)		AR1094 AR1109 - Alt.	AR7343
Engine Mounting - Other				
Transmission Mounting			AR1110	
FRONT SUSPENSION				
Upper Control Arm Bush - Inner				
Upper Control Arm Bush - Outer				
Lower Control Arm Bush - Inner	AR8765		AR1104 - Front	AR8037 - Front
Lower Control Arm Bush - Outer	AR8763		AR1105 - Rear	AR8038 - Rear
Shock Rubber - Front				
Stabilizer Bar Bush	AR9565			
Steering Coupling				
Steering Rack Mounting				
Strut Mounting	AR9558	AR1107	AR1106	
Miscellaneous				
REAR SUSPENSION				
Centre Bearing Rubber				
Exhaust Hanger - Middle				
Exhaust Hanger - Rear				
Lower Control Arm Bush - Inner				
Lower Control Arm Bush - Outer				
Propshaft Coupling				
Stabilizer Bar Bush	AR9560 (1.6)			
Stabilizer Link Grommet				
Strut Mounting				
Miscellaneous				

APPLICATIONS	CITROEN DS3 1.2i THP 110 - HNZ-EB2DT 1.2i VTi 82 - HMZ-EB2/F 1.6i e-HDi 90 - 9HP-DV6DTED 1.6i e-THP - 5FM-EP6DT 1.6i THP 155 - 5FR-EP6DT, 5FV-EP6CDT 1.6i VTi 120 - 5FS-EP6C, Racing - 5FD-EP6DTS	CITROEN DS4 1.6i VTi 120 - 5FS-EP6C	CITROEN XSARA 1.6 SX - TU5JP4 2.0 VTS, HDi - EW10J4, XU10J4RS, DW10ATED PICASSO 1.6 - TU5JP4 1.8 Exclusive - EW7J4, XU7JP4 2.0 Exclusive, HDi Exclusive - W10J4, DW10ATE	
	YEARS	2010-	2011-	01-06
Engine Configuration	TRANSVERSE	TRANSVERSE	TRANSVERSE	
Engine Mounting - Front				
Engine Mounting - Rear	AR1088 (1.2) AR1112 - Alt.		AR7332 - RHS	
Engine Mounting - Left			AR5797 (Xsara 2.0, Picasso)	
Engine Mounting - Right	AR1089 (1.6) AR1113 - Alt. (1.6)			
Engine Mounting - Other				
Transmission Mounting		AR1092		
FRONT SUSPENSION				
Upper Control Arm Bush - Inner				
Upper Control Arm Bush - Outer				
Lower Control Arm Bush - Inner	AR1090 - Front		AR5181 - Front (2)	
Lower Control Arm Bush - Outer	AR1091 - Rear		AR5180 - Rear	
Shock Rubber - Front				
Stabilizer Bar Bush				
Steering Coupling				
Steering Rack Mounting				
Strut Mounting	AR1107		AR5171	
Miscellaneous				
REAR SUSPENSION				
Centre Bearing Rubber				
Exhaust Hanger - Middle				
Exhaust Hanger - Rear				
Lower Control Arm Bush - Inner				
Lower Control Arm Bush - Outer				
Propshaft Coupling				
Stabilizer Bar Bush				
Stabilizer Link Grommet				
Strut Mounting				
Miscellaneous				

APPLICATIONS	DAEWOO	DAEWOO CIELO	DAEWOO ESPERO	DAEWOO LANOS	DAEWOO MATIZ
		1.5 GL, GLX - GTX 150i - L	1.8 CD - C18LE 2.0 CD - C20LE	1.3i S SOHC - C14L 1.6 SX DOHC - 616L, Y6 LANOS II 1.4 S SOHC, 1.6 SX DOHC	800cc S, SE - F8CV
YEARS		96-99	96-98	97-03	99-03
Engine Configuration		TRANSVERSE	TRANSVERSE	TRANSVERSE	TRANSVERSE
Engine Mounting - Front					AR7329
Engine Mounting - Rear		AR5737	AR5737 (Man.) AR7325 (Auto.)	AR5737	
Engine Mounting - Left		AR5737 (Man. / Auto.) 3-Speed AR5739 (Auto.) 4-Speed	AR5739 (Man.) AR7328 (Auto.)	AR5739	
Engine Mounting - Right		AR5738	AR5738 (Man.) AR7330 (Auto.)	AR5738 (Lanos I)	AR7326
Engine Mounting - Other					
Transmission Mounting					AR7327
FRONT SUSPENSION					
Exhaust Hanger - Front				AR7352	
Upper Control Arm Bush - Inner					
Upper Control Arm Bush - Outer					
Lower Control Arm Bush - Inner		AR5740 - Front	AR5740 - Front	AR5740 - Front	AR1041
Lower Control Arm Bush - Outer		AR5741 - Rear	AR5741 - Rear	AR5741 - Rear	AR5166
Shock Rubber - Front					
Stabilizer Bar Bush		AR7335	AR7335	AR5744	AR5140
Stabilizer Link Grommet		AR5742	AR7336		
Steering Coupling					
Steering Rack Mounting					
Strut Mounting		AR6268	AR6268	AR9663	AR8316
Miscellaneous					
REAR SUSPENSION					
Centre Bearing Rubber					
Exhaust Hanger - Middle			AR5153		
Exhaust Hanger - Rear			AR6267		
Lower Control Arm Bush - Inner					
Lower Control Arm Bush - Outer					
Propshaft Coupling					
Shacke Bush - Front					
Shacke Bush - Rear Upper					
Shacke Bush - Rear Lower					
Stabilizer Bar Bush					
Strut Mounting					
Miscellaneous		AR5743 (OD: 48mm) Rear Axle Beam Bush AR6834 (OD: 59mm) Rear Carrier Bush AR6874 Rear Offset Carrier Bush	AR5743 (OD: 48mm) Rear Axle Beam Bush AR6834 (OD: 59mm) Rear Carrier Bush AR6874 Rear Offset Carrier Bush	AR5743 (OD: 48mm) Rear Axle Beam Bush AR6834 (OD: 59mm) Rear Carrier Bush AR6874 Rear Offset Carrier Bush	

APPLICATIONS	DAEWOO NUBIRA 1.6 SX 616L - A16DM 2.0 CDX - C20SED, X20S NUBIRA II 1.6 SX, 2.0 CDX	DAIHATSU	DAIHATSU CHARADE 1.0 Celeb, Classic - 1KR-FE	DAIHATSU MATERIA 1.5i - 3S2-VE	DAIHATSU SIRION 1.3 CX - K3-VE 1.5i Sport - 3S2-VE
	YEARS		03-11	07-11	02-14
Engine Configuration	TRANSVERSE		TRANSVERSE	TRANSVERSE	TRANSVERSE
Engine Mounting - Front			AR1156		
Engine Mounting - Rear	AR7314				
Engine Mounting - Left	AR7324 (Man.) AR7341 (Auto.)		AR8293	AR8290	AR8290
Engine Mounting - Right	AR7311 (1.6) AR7312 (2.0)		AR8292	AR8289	AR8289
Engine Mounting - Other					
Transmission Mounting			AR8294	AR8291	AR8291
FRONT SUSPENSION			FRONT SUSPENSION		
Exhaust Hanger - Front					
Upper Control Arm Bush - Inner					
Upper Control Arm Bush - Outer					
Lower Control Arm Bush - Inner	AR5173			AR8295 - Front	AR8295 - Front
Lower Control Arm Bush - Outer	AR5174			AR8142 - Rear	AR8142 - Rear
Shock Rubber - Front					
Stabilizer Bar Bush	AR7318			AR9408	AR9408
Stabilizer Link Grommet					
Steering Coupling					
Steering Rack Mounting					
Strut Mounting	AR7315				AR7588
Miscellaneous					
REAR SUSPENSION			REAR SUSPENSION		
Centre Bearing Rubber					
Exhaust Hanger				AR9411	AR9411
Exhaust Hanger - Rear					
Lower Control Arm Bush - Inner					
Lower Control Arm Bush - Outer					
Propshaft Coupling					
Shacke Bush - Front					
Shacke Bush - Rear Upper					
Shacke Bush - Rear Lower					
Stabilizer Bar Bush				AR9409	AR9409
Strut Mounting					
Miscellaneous	Nubira I Only AR6568 (6) Lateral Link Bush AR6569 (2) Toe Adjustable Link Bush			AR9410 Rear Axle Beam Bush	AR9410 Rear Axle Beam Bush

APPLICATIONS	DAIHATSU TERIOS 4X2, 4X4 1.3 - K3-VE 1.5i - 3S2-VE	DATSUN	DATSUN GO / GO+ 1.2 - HR12DE			
	YEARS		02-15	2014-		
	Engine Configuration		TRANSVERSE	TRANSVERSE		
	Engine Mounting - Front					
	Engine Mounting - Rear			AR9668 AR1047 GO+		
	Engine Mounting - Left		AR8290	AR9669 AR1048 GO+		
	Engine Mounting - Right		AR8289	AR9670 AR10489 GO+		
	Engine Mounting - Other					
	Transmission Mounting		AR8291			
	FRONT SUSPENSION		FRONT SUSPENSION			
Exhaust Hanger - Front						
Upper Control Arm Bush - Inner						
Upper Control Arm Bush - Outer						
Lower Control Arm Bush - Inner	AR8295 - Front	AR9214 - Front				
Lower Control Arm Bush - Outer	AR8142 - Rear	AR9215 - Rear				
Shock Rubber - Front						
Stabilizer Bar Bush	AR9408					
Stabilizer Link Grommet						
Steering Coupling						
Steering Rack Mounting						
Strut Mounting		AR9673				
Miscellaneous						
REAR SUSPENSION		REAR SUSPENSION				
Centre Bearing Rubber						
Exhaust Hanger	AR9411					
Lower Control Arm Bush - Inner						
Lower Control Arm Bush - Outer						
Propshaft Coupling						
Shacke Bush - Front						
Shacke Bush - Rear Upper						
Shacke Bush - Rear Lower						
Stabilizer Bar Bush	AR9409					
Strut Mounting						
Miscellaneous	AR9410 Rear Axle Beam Bush					

APPLICATIONS	DODGE	DODGE CALIBER	DODGE JOURNEY	DODGE NITRO 4X4	
		1.8 - EBA 2.0 - ECN 2.0 CRD - ECE 2.4 - ED3	2.0 CRD - ECE 2.4 - ED3 2.7 V6 - EER 3.6 V6 - ERB	2.8 CRD - ENS 3.7 - EKG	
YEARS		06-12	2008-	07-10	
Engine Configuration		TRANSVERSE	TRANSVERSE	INLINE	
Engine Mounting - Front		AR9427			
Engine Mounting - Rear		AR9428			
Engine Mounting - Left		AR9429			
Engine Mounting - Right		AR9430			
Engine Mounting - Other					
Transmission Mounting					
		FRONT SUSPENSION			
Exhaust Hanger - Front					
Upper Control Arm Bush - Inner				AR9483 - Front & Rear	
Upper Control Arm Bush - Outer					
Lower Control Arm Bush - Inner		AR8765 - Front	AR9437 - Front	AR9484 - Front AR9485 - Rear	
Lower Control Arm Bush - Outer		AR8763 - Rear	AR9438 - Rear	AR9486 - Centre	
Shock Rubber - Front					
Stabilizer Bar Bush		AR9434		AR9487 (ID: 31mm)	
Steering Coupling					
Steering Rack Mounting					
Strut Mounting		AR9433	AR9439		
Miscellaneous				AR9482 Front Stabilizer Link	
		REAR SUSPENSION			
Centre Bearing Rubber		AR9436			
Exhaust Hanger - Middle					
Exhaust Hanger - Rear					
Lower Control Arm Bush - Inner					
Lower Control Arm Bush - Outer					
Propshaft Coupling					
Shacke Bush - Front					
Shacke Bush - Rear Upper					
Shacke Bush - Rear Lower					
Stabilizer Bar Bush		AR9435			
Strut Mounting					
Miscellaneous					

APPLICATIONS	FIAT	FIAT 500	FIAT PALIO I	FIAT PALIO I / II	FIAT PANDA 4X4
		1.2 - 169A4.000 1.4 - 169A3.000	1.2 ED, EL, Go!, Paint Ltd. M657.12T - 178B5.000 1.6 EL, ELX, HL, Weekend SW - 178B3.000 SIENA I 1.2 EL, EL+ M657.12T - 178B5.000 1.6 EL+, HL, ELX - 178B3.000	1.2 ED, EL, Go!, Paint Ltd. M657.12T - 178B5.000 1.6 EL, ELX, HL, Weekend SW - 178B3.000 SIENA I / II 1.2 EL, EL+ M657.12T - 178B5.000 1.6 EL+, HL, ELX - 178B3.000	1.1 - 187A1 1.2 - 169A4, 188A4 1.4 - 169A3
YEARS		08-15	00-02	02-10	2005-
Engine Configuration		TRANSVERSE	TRANSVERSE	TRANSVERSE	TRANSVERSE
Engine Mounting - Front					
Engine Mounting - Rear		AR9071 (1.2) AR9074 (1.4)	AR9723	AR9723	AR9071
Engine Mounting - Left		AR9072 (1.2) AR9075 (1.4)	AR9724	AR9724	
Engine Mounting - Right			AR9725	AR9725	
Engine Mounting - Other					
Transmission Mounting		AR9073 (1.2) AR9076 (1.4)			
		FRONT SUSPENSION			
Upper Control Arm Bush - Inner					
Upper Control Arm Bush - Outer					
Lower Control Arm Bush - Inner		AR9069 - Front	AR5536 - Front	AR5536 - Front	AR9069 - Front
Lower Control Arm Bush - Outer		AR9068 - Rear	AR8307L (P/S) AR8307R (P/S) AR8308L (M/S) AR8308R (M/S)	AR5539L (P/S) AR5539R (P/S) AR8308L (M/S) AR8308R (M/S)	AR9068 - Rear
Shock Rubber - Front					
Stabilizer Bar Bush					AR9098 (ID: 19.5mm) AR9099 (ID: 20.5mm)
Steering Coupling					
Steering Rack Mounting					
Strut Mounting		AR9070	AR9726L AR9726R	AR9726L AR9726R	AR9070
Miscellaneous					
		REAR SUSPENSION			
Centre Bearing Rubber					
Exhaust Hanger - Middle					
Exhaust Hanger - Rear					
Lower Control Arm Bush - Inner					
Lower Control Arm Bush - Outer					
Propshaft Coupling					
Shacke Bush - Front					
Shacke Bush - Rear Upper					
Shacke Bush - Rear Lower					
Stabilizer Bar Bush					
Strut Mounting					
Miscellaneous					

APPLICATIONS	FIAT PUNTO 1.2 Active, Dyna - 188A5.000 1.3 Dynamic, JTD MultiJet Active, Dyna - 188A9.000 GRAND PUNTO I / II 1.2 - 188A5, 199A4 1.3D MultiJet - 199A2/3 1.4 16V - 199A6, 198A4, 350A1 1.9 MultiJet - 939A1.000	FIAT SEICENTO 1.1 S, Sporting - 176B2000	FIAT STILO 1.6 Actual, Active, Multi Wagon, Active - 182B6000 1.9 JTD Dynamic, Actual, Multi Wagon JTD Dynamic - 192A1000, 937A7.000	FIAT ULYSSE 2.0 MPV - RFU, RFV
	YEARS	2005-	01-03	03-07
Engine Configuration	TRANSVERSE	TRANSVERSE	TRANSVERSE	TRANSVERSE
Engine Mounting - Front		AR9731	AR8747	
Engine Mounting - Rear	AR8494		AR8748	
Engine Mounting - Left	AR8496	AR9732		AR5797
Engine Mounting - Right	AR8495	AR9733	AR8749	AR7343
Engine Mounting - Other				
Transmission Mounting				
FRONT SUSPENSION				
Upper Control Arm Bush - Inner				
Upper Control Arm Bush - Outer				
Lower Control Arm Bush - Inner	AR8237 - Front	AR5823 - Front L/RHS	AR5641 - Front	
Lower Control Arm Bush - Outer	AR8238 - Rear	AR5824 - Rear L/RHS	AR5642 - Rear	
Shock Rubber - Front				
Stabilizer Bar Bush	AR8489 (ID: 19mm) (Grand Punto)	AR9734		
Steering Coupling				
Steering Rack Mounting				
Strut Mounting	AR9097 (Grand Punto)	AR8033		
Miscellaneous				
REAR SUSPENSION				
Centre Bearing Rubber				
Exhaust Hanger - Middle				
Exhaust Hanger - Rear				
Lower Control Arm Bush - Inner				
Lower Control Arm Bush - Outer				
Propshaft Coupling				
Stabilizer Bar Bush				
Stabilizer Link Grommet				
Strut Mounting				
Miscellaneous				

APPLICATIONS	FIAT UNO 1.0 Cento - 156A2 1.1 Fire, Mia, Rio, Tempo, Espresso P/van - 160A3	FIAT UNO 1.4 Beat, Mia, Pacer, Pacer SX, Tempo SX - 146C1 1.4 Turbo - 146A		
YEARS	90-05	90-98		
Engine Configuration	TRANSVERSE	TRANSVERSE		
Engine Mounting - Front	AR5811	AR5817		
Engine Mounting - Rear				
Engine Mounting - Left	AR5813	AR5818		
Engine Mounting - Right	AR5812	AR5816		
Engine Mounting - Other	AR7389 X-Member Bush	AR7389 X-Member Bush		
Transmission Mounting				
FRONT SUSPENSION				
Upper Control Arm Bush - Inner				
Upper Control Arm Bush - Outer				
Lower Control Arm Bush - Inner	AR5823 - Front	AR5823 - Front		
Lower Control Arm Bush - Outer	AR5824 - Rear	AR5824 - Rear		
Shock Rubber - Front	AR33	AR33		
Stabilizer Bar Bush	AR6247 - Outer AR7238 - Inner	AR6247 - Outer AR7238 - Inner		
Steering Coupling				
Steering Rack Mounting	AR7385 - LHS AR7386 - RHS	AR7385 - LHS AR7386 - RHS		
Strut Mounting	AR7390	AR7390		
Miscellaneous				
REAR SUSPENSION				
Centre Bearing Rubber				
Exhaust Hanger - Middle	AR121			
Exhaust Hanger - Rear				
Lower Control Arm Bush - Inner				
Lower Control Arm Bush - Outer				
Propshaft Coupling				
Stabilizer Bar Bush				
Stabilizer Link Grommet				
Strut Mounting	AR5809	AR5809 AR7393 (Turbo)		
Miscellaneous				

APPLICATIONS	FORD	FORD BANTAM	FORD BANTAM	FORD BANTAM	FORD BANTAM 'BOET'
		1.3 SWB P/up Kent 2V Pet. 1.6 Leisure SWB P/up Pet. - CVH	1.4 Leisure SWB P/up Pet. - CVH, FUA 1.6 Leisure, Nite SWB P/up Pet. - CVH	1.3 130 Explorer SWB P/up Pet. - B3 160i Explorer, Leisure, Sport SWB P/up Pet. - F6	1.3i XL, XLS SWB P/up Pet. - CLTA 1.6i XLE, XLT, SWB P/up Pet. - Zetec 1.8di XL SWB P/up Dies.
YEARS		83-86	86-94	94-03	02-12
Engine Configuration		TRANSVERSE	TRANSVERSE	TRANSVERSE	TRANSVERSE
Engine Mounting - Front		AR5484 (1.6 Only)	AR6161	AR5499 Carb - 4 Studs AR5503 Fuel Injection - 2 Studs AR5499W Insert for AR5503 & AR5499	AR8045 - LHS (1.3) AR8046 - LHS (1.6, 1.8)
Engine Mounting - Rear			AR6161		AR6487
Engine Mounting - Left		AR5484			
Engine Mounting - Right		AR5486	AR6179	AR5500 - Rear	
Engine Mounting - Other					
Transmission Mounting				AR5498	AR6476
FRONT SUSPENSION					
Exhaust Hanger - Front					AR8047
Upper Control Arm Bush - Inner					
Upper Control Arm Bush - Outer					
Lower Control Arm Bush - Inner		AR5168	AR5168	AR5375	AR7411 - Front
Lower Control Arm Bush - Outer		AR5175	AR5175	AR5502	AR6496 - Rear
Shock Rubber - Front					
Stabilizer Bar Bush		AR6194	AR6193	AR5504	AR6266 (ID: 16mm) AR6497 (ID: 15mm)
Steering Coupling			SK500		
Steering Rack Mounting		AR6530 - RHS (Thick) AR6531 - LHS (Thin)	AR6530 - RHS (Thick) AR6531 - LHS (Thin)	AR6530 - RHS (Thick) AR6531 - LHS (Thin)	
Strut Mounting			AR6602	AR6210	AR6498 (Excl. Bearing) AR6498C (Incl. Bearing)
Miscellaneous					
REAR SUSPENSION					
Centre Bearing Rubber					
Exhaust Hanger - Middle		AR5125	AR5125	AR5125	
Exhaust Hanger - Rear		AR5125	AR5125	AR5125	
Lower Control Arm Bush - Inner					
Lower Control Arm Bush - Outer					
Propshaft Coupling					
Shackle Bush - Front		AR5163 (2)	AR5163 (2)	AR5163 (4)	AR5163 (2)
Shackle Bush - Rear Upper		AR5488 (4)	AR5488 (4)	AR5163 (4)	AR5488 (4)
Shackle Bush - Rear Lower		AR5163 (2)	AR5163 (2)		AR5163 (2)
Stabilizer Bar Bush					
Strut Mounting					
Miscellaneous					AR6523 Rear Axle Carrier Bush

APPLICATIONS

FORD CORTINA MKIII 1.6 L SWB P/up Kent Pet. 2.0 V4 SWB P/up Kohn Pet. 2.5 V6 L SWB P/up Essex Pet. 3.0 GT, L, XL, XLE "Big Six" Essex - EV30	FORD CORTINA MKIV 1.3 L Kent 1.6 1-Tonner SWB P/up Kent Pet. 2.0 GL, GLE Kohn 3.0 V6 1-Tonner SWB P/up Essex Pet. CORTINA MKV 1.6 1-Tonner SWB P/up Kent Pet. 2.4D 1-Tonner SWB P/up York Pet. 3.0 V6 1-Tonner SWB, LWB P/up Essex Pet.	FORD COURIER 1.6 SWB P/up Pet. - F6 1.8 SWB, LWB P/up Ch. Cab, Std., XLT Pet. - F8 2.0 XLT LWB P/up Pet. - FE 2.2 D/cab, Explorer, Std., XLT, Leisure SWB, LWB P/up Pet. - F2, Dies. - R2 2.5D TD, Leisure LWB P/up Dies. - WL4	FORD COURIER 3.0 V6 D/cab, Std., L, Leisure, Explorer SWB, LWB P/up, Essex Pet. 3.4 V6 Leisure, D/cab SWB, LWB P/up Pet.
--	---	---	---

YEARS	71-77	77-86	86-00	86-00
Engine Configuration	INLINE	INLINE	INLINE	INLINE
Engine Mounting - Front				
Engine Mounting - Rear				
Engine Mounting - Left	AR2015	AR2015	AR5535	AR2015 (3.0 Only)
Engine Mounting - Right	AR2015	AR2015	AR5535	AR2015 (3.0 Only)
Engine Mounting - Other				
Transmission Mounting	AR5159	AR5159	AR1417 (1.6, 2.2) AR6622 (2.5)	AR5172 (3.0 Only)

FRONT SUSPENSION

Exhaust Hanger - Front				
Upper Control Arm Bush - Inner	AR1486 AR1493 - Alt. (Front)	AR1486A - Front AR1493 - Alt. (Front)		
Upper Control Arm Bush - Outer	AR1486 AR1494 - Alt. (Rear)	AR1486A - Rear AR1494 - Alt. (Rear)		
Lower Control Arm Bush - Inner	AR1457	AR1487	AR5541 (1.6, 1.8) (86-92) AR6059 (2.0, 2.2, 2.5)	AR6059
Lower Control Arm Bush - Outer	AR1490	AR1491		
Shock Rubber - Front			AR22	AR22
Stabilizer Bar Bush	AR5325	AR5326	AR6060	AR6060
Stabilizer Link Grommet	AR5491	AR5491	AR5092	AR5092
Steering Coupling	SK500	SK500		
Steering Rack Mounting	AR5327 - LHS Thin Rack, Thick End AR5328 - RHS Thin Rack, Thin End	AR5327 - LHS Thin Rack, Thick End AR5328 - RHS Thin Rack, Thin End AR5362 - LHS (81-86) Thick Rack, Thick End		
Strut Mounting				
Tension Rod Bush	AR2062	AR2062	AR6055	AR6055
Miscellaneous	AR5160 Subframe Insulator Upper AR5164 Subframe Insulator Lower	AR5160 Subframe Insulator Upper AR5164 Subframe Insulator Lower	AR5418 Brake & Clutch Pedal Rubber	AR5418 Brake & Clutch Pedal Rubber

REAR SUSPENSION

Centre Bearing Rubber	AR5089A Rubber Only AR5089AB Complete	AR5089A Rubber Only AR5089AB Complete	AR5538 (1.6, 2.2) AR6184 (2.5)	AR5538 (3.0) AR6184 (3.4)
Exhaust Hanger - Middle	AR2013	AR2013	AR5139	AR5139
Exhaust Hanger - Rear	AR2013	AR2013	AR5139	AR5139
Lower Control Arm Bush - Inner				
Lower Control Arm Bush - Outer				
Propshaft Coupling				
Shackle Bush - Front	AR5067 (2)	AR5163 (2)	AR5359 (4)	AR5359 (4)
Shackle Bush - Rear Upper	AR2042 (4)	AR2042 (4)	AR5394 (4)	AR5394 (4)
Shackle Bush - Rear Lower	AR5067 (2)		AR5543 (4)	AR5543 (4)
Shock Rubber - Rear			AR39	AR39
Stabilizer Bar Bush				
Stabilizer Link Grommet				
Strut Mounting				
Miscellaneous				

APPLICATIONS	FORD COURIER 4X4	FORD ECOSPORT	FORD ESCORT MKI / II	FORD ESCORT MKIII
	2.5D TD V6 D/cab, Leisure LWB P/up Dies. - WL4 3.0 V6 Std., XLT, D/cab, Leisure, Explorer, Exec. LWB P/up Essex Pet. 3.4 V6 Leisure D/cab LWB P/up Pet.	1.0i Ecoboost - M1JC 1.5 TDCi - UGJE 1.5i - UEJB	1.1 300 SWB P/van Kent Pet. 1.3 30/35/45 SWB P/van Kent Pet. 1.6 45 P/van SWB P/van Kent Pet.	1.3 GL, L Kent 1.6 GLE, L Sport, XR3, i - HL16CVH 1.8i GLi Pet. - Zetec, TD Dies. - Endura DE
YEARS	90-00	2013-	68-81	81-86
Engine Configuration	INLINE	TRANSVERSE	INLINE	TRANSVERSE
Engine Mounting - Front		AR9037		AR5484
Engine Mounting - Rear		AR8757		
Engine Mounting - Left	AR5535 (2.5) AR2015 (3.0, 3.4)		AR1046 AR1046A (1.6)	AR5484
Engine Mounting - Right	AR5535 (2.5) AR2015 (3.0, 3.4)		AR1046 AR1046A (1.6)	AR5486
Engine Mounting - Other				
Transmission Mounting	AR6622 (2.5) AR6619 (3.0, 3.4)	AR9038	AR663	
FRONT SUSPENSION				
Exhaust Hanger - Front				
Upper Control Arm Bush - Inner				
Upper Control Arm Bush - Outer				
Lower Control Arm Bush - Inner	AR6059 - Front	AR9046 - Front	AR5095	AR5168
Lower Control Arm Bush - Outer	AR5540 - Rear	AR9047 - Rear	AR5330	AR5175
Shock Rubber - Front				
Stabilizer Bar Bush	AR6060	AR9050 (ID: 22.5mm)	AR5326	AR5487
Stabilizer Link Grommet	AR5092			
Steering Coupling			SK500	SK500
Steering Rack Mounting			AR5329 - LHS (Small) AR5921 - RHS (Large)	
Strut Mounting		AR8753		
Tension Rod Bush	AR6055			
Miscellaneous	AR5418 Brake & Clutch Pedal Rubber			
REAR SUSPENSION				
Centre Bearing Rubber	AR5544		AR5089A Rubber Only AR5089AB Complete	
Exhaust Hanger - Middle	AR5139		AR2022	AR5125 AR5152 - Alt.
Exhaust Hanger - Rear	AR5139		AR2013	AR5125 AR5152 - Alt.
Lower Control Arm Bush - Inner				AR5167 - Rear
Lower Control Arm Bush - Outer				AR5167 - Front
Propshaft Coupling				
Shackle Bush - Front	AR5359 (4)		AR5163 (2)	
Shackle Bush - Rear Upper	AR5394 (4)			
Shackle Bush - Rear Lower	AR5543 (4)			
Shock Rubber - Rear	AR39			
Stabilizer Bar Bush				
Stabilizer Link Grommet				
Strut Mounting		AR9049		
Miscellaneous				

APPLICATIONS	FORD ESCORT MKVI FWD 1.4i Hatchback, Sedan - CVH-PTE 1.6i GL, GLE Hatchback, Sedan - Zetec 1.8i GLi Pet. - Zetec 1.8 TD Dies. - Endura DE	FORD EVEREST 4X2, 4X4 3.0 TDCi	FORD FALCON 4.0 Fairmont Futura S/W, 6-Cyl. MPi - XR6	FORD FIESTA I 1.3i Flair, Flite, Fun Play - Endura EM5 1.4i Flair, Flite, Fun - CVH, PTE 1.6i Flair, Forte, RSi, Sport - Rocam
YEARS	95-00	09-15	96-03	97-04
Engine Configuration	TRANSVERSE	TRANSVERSE	INLINE	TRANSVERSE
Engine Mounting - Front	AR7395 (1.4) AR7398 (1.6, 1.8)			AR6480 - RHS (1.3, 1.4) AR6489 - RHS (Alt.) AR8045 - RHS (1.6 Flair, Forte) AR8046 - LHS (1.6 RSi, Sport)
Engine Mounting - Rear	AR7396			AR6487
Engine Mounting - Left		AR8383	AR7412	
Engine Mounting - Right		AR8383	AR7413	AR7015
Engine Mounting - Other				
Transmission Mounting	AR7399 (1.8 TD) AR7400 (1.4, 1.6, 1.8 Petrol)	AR8728	AR7414	AR6476
FRONT SUSPENSION				
Exhaust Hanger - Front				AR8047
Upper Control Arm Bush - Inner		AR8367	AR7419 AR7420 (XR6 Only)	
Upper Control Arm Bush - Outer		AR8367	AR7416	
Lower Control Arm Bush - Inner	AR7410 - Front	AR8366	AR7417	AR7411 - Front
Lower Control Arm Bush - Outer	AR7436 - Rear			AR6496 - Rear
Shock Rubber - Front				
Stabilizer Bar Bush	AR6266	AR9675	AR7415	AR6497 (ID:15mm)
Stabilizer Link Grommet		AR22		
Steering Coupling				
Steering Rack Mounting				
Strut Mounting	AR7408		AR7430	AR6498 (Excl. Bearing) AR6498C (Incl. Bearing)
Tension Rod Bush				
Miscellaneous		AR9759 Stabilizer Link Pin Kit		
REAR SUSPENSION				
Centre Bearing Rubber		AR8430		
Exhaust Hanger - Middle				AR6499
Exhaust Hanger - Rear				AR6499
Lower Control Arm Bush - Inner			AR7423 (96-98) AR7424 (98-03)	
Lower Control Arm Bush - Outer				
Propshaft Coupling				
Shackle Bush - Front				
Shackle Bush - Rear Upper		AR5394		
Shackle Bush - Rear Lower		AR5543		
Shock Rubber - Rear				
Stabilizer Bar Bush				
Stabilizer Link Grommet				
Strut Mounting				
Miscellaneous	AR7403 Rear Axle Beam Bush - Front			AR6523 Rear Axle Carrier Bush

APPLICATIONS	FORD FIESTA II	FORD FIESTA III	FORD FIGO	FORD FOCUS I
	1.4i Trend - Zetec 1.6i Ambiente, Ghia, Trend - Rocam, Zetec 2.0i ST150, ST	1.0 Ecoboost, Titanium, Trend - M1JE 1.4i Ambiente, Trend, Titanium 1.6i Ambiente, Trend, Sport, Titanium, TDCi	1.4 TDCi Ambiente 1.4i Ambiente, Trend - FXJA, FXJB	1.6 Ambiente, Trend - ZH16MEFI 1.8 TDCi Trend - F9DA 2.0 RS, Trend, ST170 - ZH20MEFI
YEARS	04-09	2008-	10-16	00-05
Engine Configuration	TRANSVERSE	TRANSVERSE	TRANSVERSE	TRANSVERSE
Engine Mounting - Front		AR9037 (1.0)		
Engine Mounting - Rear	AR8757	AR8616 (TDCi) AR8757 (Man.) AR1306 (Auto.)	AR8616 (TDCi) AR8757	AR5186
Engine Mounting - Left				
Engine Mounting - Right	AR7015 AR9744 - Alt.	AR8758 (Auto.) AR8759	AR9040 AR9744 (TDCi)	AR7159 (1.6, 2.0) (00-03) AR5185 (1.6, 2.0) (03-05)
Engine Mounting - Other				
Transmission Mounting	AR7017	AR8760 AR9038 (1.0)	AR7017	AR5187
FRONT SUSPENSION				
Exhaust Hanger - Front		AR7082		
Upper Control Arm Bush - Inner				
Upper Control Arm Bush - Outer				
Lower Control Arm Bush - Inner	AR7012 - Front	AR8751 - Front	AR7012 - Front	AR5188 - Front
Lower Control Arm Bush - Outer	AR7013 - Rear	AR9047 - Rear	AR7013 - Rear	AR5189 - Rear
Shock Rubber - Front				
Stabilizer Bar Bush	AR7011	AR8750 AR9761 (1.0)	AR7011	AR5157
Stabilizer Link Grommet				
Steering Coupling				
Steering Rack Mounting				
Strut Mounting	AR7018 (Excl. Bearing) AR7018B (Incl. Bearing)	AR8753 (Man.) AR8754 (Auto.)	AR7018 (Excl. Bearing) AR7018B (Incl. Bearing)	AR5190
Tension Rod Bush				
Miscellaneous				
REAR SUSPENSION				
Centre Bearing Rubber				
Exhaust Hanger - Middle		AR7082		
Exhaust Hanger - Rear		AR7082		
Lower Control Arm Bush - Inner				
Lower Control Arm Bush - Outer				
Propshaft Coupling				
Shackle Bush - Front				
Shackle Bush - Rear Upper				
Shackle Bush - Rear Lower				
Shock Rubber - Rear				
Stabilizer Bar Bush				AR5191
Stabilizer Link Grommet				
Strut Mounting	AR9049	AR9049	AR9049	
Miscellaneous	AR9048 Rear Carrier Bush	AR8756 Rear Axle Beam Bush		AR8245 Rear Subframe Bush AR8246 Rear Lateral Link Bush

APPLICATIONS	FORD FOCUS II 1.6 Ambiente, Trend, Si - IQDB 1.8 - QQDB, Q7DA 2.0 - AODA, AODB, AODE 2.0 TDCi - G6DA, G6DB, G6DD 2.5 RS, ST - HYDA	FORD FOCUS III 1.6i - PNDA 2.0 TDCi, GDi, GTDi - MGDA ST1, ST3 - R9DA	FORD HUSKY 1.8 1-Ton SWB P/up, P/van, Bus Pet. - 4G62 2.0 1-Ton SWB P/up, P/van, Bus Pet., - 4G63	FORD IKON 1.3i LX, Low - CLTA 1.6i LX, CLX, High, Low - CLTA
YEARS	05-12	11-15	85-99	01-06
Engine Configuration	TRANSVERSE	TRANSVERSE	INLINE	TRANSVERSE
Engine Mounting - Front				AR8045 - LHS (1.3, 1.6) (03/01) AR8046 - LHS (1.6) (04/01-)
Engine Mounting - Rear	AR8187 Body Side AR8616 Engine Side	AR8187 Body Side AR8616 Engine Side		AR6487
Engine Mounting - Left			AR5194	
Engine Mounting - Right	AR8826 (1.8, 2.0) AR9124 (2.5) AR9598 (1.6) AR9600 (2.0 TDCi)	AR8826 - Alt. (1.6, 2.0) AR9600 AR9806 (ST R9DA) AR9995 (2.0 TDCi)	AR5194	
Engine Mounting - Other				
Transmission Mounting	AR8186	AR8186		AR6476
FRONT SUSPENSION				
Exhaust Hanger - Front				AR8047
Upper Control Arm Bush - Inner				
Upper Control Arm Bush - Outer				
Lower Control Arm Bush - Inner	AR8243	AR8243	AR6705	AR7411 - Front
Lower Control Arm Bush - Outer	AR8244	AR8244 AR9464L - Rear LHS (Alt.) AR9464R - Rear RHS (Alt.) (Bigger Bracket)	AR6705	AR6496 - Rear
Shock Rubber - Front				AR6266 (ID:16mm) AR6497 (ID:15mm)
Stabilizer Bar Bush	AR8221 (ID: 16mm) AR8615 (ID: 18mm) AR9051 (1.8)	AR8615 (ID: 18mm) AR9051	AR5549 (ID: 19mm) AR5550 (ID: 20mm)	
Stabilizer Link Grommet			AR22 AR5092	
Steering Coupling				
Steering Rack Mounting				
Strut Mounting	AR8193	AR8193		AR6498 (Excl. Bearing) AR6498C (Incl. Bearing)
Tension Rod Bush				
Miscellaneous				
REAR SUSPENSION				
Centre Bearing Rubber				
Exhaust Hanger - Middle				
Exhaust Hanger - Rear				
Lower Control Arm Bush - Inner				
Lower Control Arm Bush - Outer				
Propshaft Coupling				
Shackle Bush - Front			AR5553 (4)	
Shackle Bush - Rear Upper			AR5552 (4)	
Shackle Bush - Rear Lower			AR5553 (4)	
Shock Rubber - Rear				
Stabilizer Bar Bush	AR8221 (1.8)			
Stabilizer Link Grommet				
Strut Mounting				
Miscellaneous	AR8245 Rear Subframe Bush AR8246 Rear Lateral Link Bush	AR8245 Rear Subframe Bush AR8246 Rear Lateral Link Bush		AR6523 Rear Axle Carrier Bush

APPLICATIONS	FORD IKON	FORD KA	FORD KUGA 4X2, 4X4	FORD LASER [86-95]
	1.4 1.4 TDCi 1.6, i	1.3i Low, LX, Ambiente, Trend, Collection - A9A/B	1.6 Ecoboost, Ambiente - JQMB, JQMA 1.6 Ecoboost Titanium, Trend - JTMA 2.0 TDCi Titanium, Trend AWD Powershift - TXDA, TXMA 2.5 Turbo, Titanium, Trend AWD - TXDB	1.3 Dash, GL, L, Tracer H/B, Sedan, Tonic - B3, E3 METEOR [86-95] 1.3 GL, L - B3, E3 TRACER [95-02] 1.3 H/B, Sedan, Tonic, Plus - B3, E3
YEARS	07-11	05-09	2011-	86-02
Engine Configuration	TRANSVERSE	TRANSVERSE	TRANSVERSE	TRANSVERSE
Engine Mounting - Front				AR5503
Engine Mounting - Rear	AR8757	AR8720	AR8187 (1.6, 2.0, 2.5)	
Engine Mounting - Left			AR9599 - Alt.	
Engine Mounting - Right	AR7015	AR8719 AR9762 - Alt.	AR8185 (3 Holes) AR9124 (2.5) AR9600 (2.0) AR9640 (1.6) AR9806 - Alt. AR9995 (2.0 TDCi)	AR5500 - Rear
Engine Mounting - Other				
Transmission Mounting	AR7017	AR8721	AR8186 (1.6, 2.0, 2.5)	AR5498
FRONT SUSPENSION				
Exhaust Hanger - Front				AR5139 (86-91) (2) AR5149 (91-02) (2)
Upper Control Arm Bush - Inner				
Upper Control Arm Bush - Outer				
Lower Control Arm Bush - Inner	AR7012 - Front	AR7429	AR8243	AR5375 - Front
Lower Control Arm Bush - Outer	AR7013 - Rear	AR7436	AR8244 AR9464L - Rear LHS (Alt.) AR9464R - Rear RHS (Alt.) (Bigger Bracket)	AR5502 - Rear
Shock Rubber - Front				
Stabilizer Bar Bush	AR7011	AR6497 (ID: 15mm)	AR8615 (ID: 18mm)	AR5504
Stabilizer Link Grommet				AR5081
Steering Rack Mounting				AR6530 - RHS (91-02) AR6531 - LHS (91-02)
Strut Mounting	AR7018 (Excl. Bearing) AR7018B (Incl. Bearing)	AR6498 (Excl. Bearing) AR6498C (Incl. Bearing)	AR8193	AR6532 (86-91) AR6210 (91-02)
Tension Rod Bush				
Miscellaneous				AR6538 Accelerator Pedal Rubber AR6539 Brake & Clutch Pedal Rubber
REAR SUSPENSION				
Exhaust Hanger - Middle				AR5061
Exhaust Hanger - Rear				AR5139 (3)
Lower Control Arm Bush - Inner				
Lower Control Arm Bush - Outer				
Shackle Bush - Front				
Shackle Bush - Rear Upper				
Shackle Bush - Rear Lower				
Shock Rubber - Rear				
Stabilizer Bar Bush				AR5505 (86-95)
Stabilizer Link Grommet				AR5081
Strut Mounting	AR9049			AR6533
Miscellaneous	AR9048 Rear Carrier Bush		AR8245 Rear Subframe Bush	AR6144 Trail Link Arm AR6145A (86-89) Rear Lateral Link - Non-Adjustable AR6148A (90-02) Rear Lateral Link - Adjustable AR6158 - RHS Front Lateral Link AR6159 - LHS Front Lateral Link

APPLICATIONS	FORD LASER 1.4 L - CHV-FUA 1.5 GL, GLS, Sport - E5 METEOR 1.4 LX - CVH 1.5 GL, GLS - E5	FORD LASER [86-95] 1.6 i, 16, GL, Sport, Tracer H/B, Sedan, Plus, TX3 - B6, F6, CVH METEOR [86-95] 1.6 16, GL, GLE, GLi, Sport - B6, F6, CVH TRACER [95-02] 1.6i 16, Sedan, Hatchback, Plus, Sport, Tonic - B6, F6	FORD LASER 2.0i RS - FE METEOR 2.0 GLE, GLi - FE	FORD MONDEO 1.8 TDi LX - Endura D18TI 1.8i LX B-P Pet. - Zetec ZH18EFI 2.0i Aspen, CLX, B-P - Zetec ZH20EFI, ZH20HE 2.5i V6 Si - Duratec M5
YEARS	86-92	86-02	91-94	97-01
Engine Configuration	TRANSVERSE	TRANSVERSE	TRANSVERSE	TRANSVERSE
Engine Mounting - Front	AR5499 (1.4) (4 Studs) AR5503 (1.5) (2 Studs)	AR5499 Carb (4 Studs) AR5503 Fuel Injection (2 Studs)	AR5499W (4 Studs) Wide Mounting	
Engine Mounting - Rear				
Engine Mounting - Left				
Engine Mounting - Right	AR5500	AR5500	AR5500	
Engine Mounting - Other				
Transmission Mounting	AR5498	AR5498	AR5498	AR7407
FRONT SUSPENSION				
Exhaust Hanger - Front	AR5139 (86-91) (2) AR5149 (91-92) (2)	AR5139 (86-91) (2) AR5149 (91-92) (2)	AR5149 (2)	
Upper Control Arm Bush - Inner				
Upper Control Arm Bush - Outer				
Lower Control Arm Bush - Inner	AR5375 - Front	AR5375 - Front	AR5375 - Front	AR7410 - Front (97-01) (47mm) AR8048 - Front (99-01) (54mm)
Lower Control Arm Bush - Outer	AR5502 - Rear	AR5502 - Rear	AR5502 - Rear	AR8049 - Rear (97-99) (46mm) AR7421 - Rear (99-01) (60mm)
Stabilizer Bar Bush	AR5504	AR5504	AR5504	AR5702 (ID: 20mm)
Stabilizer Link Grommet	AR5081	AR5081	AR5081	
Steering Coupling				
Steering Rack Mounting	AR6530 - RHS (91-92) AR6531 - LHS (91-92)	AR6530 - RHS AR6531 - LHS	AR6530 - RHS AR6531 - LHS	
Strut Mounting	AR6532 (86-91) AR6210 (91-92)	AR6532 (86-91) AR6210 (91-02)	AR6210	AR5690
Miscellaneous	AR6538 Accelerator Pedal Rubber AR6539 Brake & Clutch Pedal Rubber	AR6538 Accelerator Pedal Rubber AR6539 Brake & Clutch Pedal Rubber	AR6538 Accelerator Pedal Rubber AR6539 Brake & Clutch Pedal Rubber	
REAR SUSPENSION				
Centre Bearing Rubber				
Exhaust Hanger - Middle	AR5061	AR5061 (86-91) AR5149 (91-02)	AR5061	
Exhaust Hanger - Rear	AR5139 (3)	AR5139 (86-91) (3) AR5149 (91-02)	AR5139 (3)	
Lower Control Arm Bush - Inner				
Lower Control Arm Bush - Outer				
Shackle Bush - Front				
Shackle Bush - Rear Upper				
Shackle Bush - Rear Lower				
Stabilizer Bar Bush	AR5505	AR5505 (86-95) AR6534 (95-02)	AR5505	
Stabilizer Link Grommet	AR5081	AR5081	AR5081	
Strut Mounting	AR6533	AR6533	AR6533	
Miscellaneous	AR6144 Trail Link Arm AR6145A (86-89) Rear Lateral Link - Non-Adjustable AR6148A (90-02) Rear Lateral Link - Adjustable AR6158 Front Lateral Link - RHS AR6159 Front Lateral Link - LHS	AR6144 Trail Link Arm AR6145A (86-89) Rear Lateral Link - Non-Adjustable AR6148A (90-02) Rear Lateral Link - Adjustable AR6158 Front Lateral Link - RHS AR6159 Front Lateral Link - LHS	AR6144 Trail Link Arm AR6148A (90-02) Rear Lateral Link - Adjustable AR6158 Front Lateral Link - RHS AR6159 Front Lateral Link - LHS	AR5698 Semi Trailing Arm Bush - Front L/RHS

APPLICATIONS	FORD MONDEO 2.0 Ghia - IS7G, CJBA, CJBB 3.0 ST220 - MEBA	FORD RANGER 1.8, XL SWB, LWB P/up Pet. 2.2, XL SWB, LWB P/up Pet. 2.5D, TD High Trail, High Trail XL, XL D/cab, XLT Hi Trail, Super Cab XLT Hi Trail SWB, LWB P/up Dies. - WL4 4.0 V6 SubCab XLT Hi Trail, Super Cab XLT, XLE D/C, Hi Trail SWB, LWB P/up Pet.	FORD RANGER 4X4 2.5D, TD V6 XL D/cab, XLT, SubCab, XLT Hi Trail, Super Cab XLT LWB P/up Dies. 4.0 V6 D/cab XLE, SubCab XLT Hi Trail, Super Cab XLT LWB P/up Pet.	FORD RANGER 2.5D TD XL D/cab, XLT, SubCab, XLT Hi Trail, Super Cab XLT LWB P/up Dies. 3.0 TDCi D/cab XLE, SubCab XLT, Hi Trail, Super Cab XLT LWB P/up Dies.
	YEARS	02-06	99-10	00-10
Engine Configuration	TRANSVERSE	INLINE	INLINE	INLINE
Engine Mounting - Front				
Engine Mounting - Rear	AR9061			
Engine Mounting - Left		AR5535	AR5535	AR5535 (2.5) AR8383 (3.0)
Engine Mounting - Right	AR9058	AR5535	AR5535	AR5535 (2.5) AR8383 (3.0)
Engine Mounting - Other				
Transmission Mounting	AR9057 - Upper	AR1417 (-01) AR6622 (01-)	AR6622	AR6622 (Man.) AR8726 (Auto.)
FRONT SUSPENSION				
Exhaust Hanger - Front				
Upper Control Arm Bush - Inner		AR6450 Rubber Bush for SK105 V-Arm shaft	AR6450 - Front	AR8367
Upper Control Arm Bush - Outer		AR6450 Rubber Bush for SK105 V-Arm shaft	AR6450 - Rear	AR8367
Lower Control Arm Bush - Inner		AR5540 - Front Hi Rider	AR5540 - Front	AR8366
Lower Control Arm Bush - Outer	AR5204 - Rear (2.0)	AR5546 - Rear Standard & Hi Rider	AR5546 - Rear	
Shock Rubber - Front		AR5574		AR8368
Stabilizer Bar Bush	AR9059 (2.0)	AR5551	AR5557	AR8369
Stabilizer Link Grommet				AR22
Steering Coupling				
Steering Rack Mounting				
Strut Mounting	AR9054			
Tension Rod Bush		AR5575		
Miscellaneous		AR5423 Brake & Clutch Pedal Rubber	AR5423 Brake & Clutch Pedal Rubber	AR9759 Stabilizer Link Pin Kit
REAR SUSPENSION				
Centre Bearing Rubber		AR5538 (1.8 Std.) AR5544 (1.8 Hi Rider) AR6184 (2.2, 2.5, 4.0)	AR5544	AR8429 (2.5) AR8430 (3.0)
Exhaust Hanger - Middle		AR5149 (1.8)		
Exhaust Hanger - Rear		AR5149 (1.8)		
Lower Control Arm Bush - Inner				
Lower Control Arm Bush - Outer				
Propshaft Coupling				
Shackle Bush - Front		AR5359 (4)	AR5359 (4)	
Shackle Bush - Rear Upper		AR5394 (4)	AR5394 (4)	AR5394 (4)
Shackle Bush - Rear Lower		AR5543 (4)	AR5543 (4)	AR5543 (4)
Shock Rubber - Rear			AR39	
Stabilizer Bar Bush	AR9060			
Stabilizer Link Grommet				
Strut Mounting	AR9055			
Miscellaneous	AR9056 Rear Axle Beam Bush			

APPLICATIONS	FORD RANGER 4X4 2.5D TD XL D/cab, XLT, SubCab, XLT Hi Trail, Super Cab XLT LWB P/up Dies. 3.0 TDCi D/cab XLE, SubCab XLT, Hi Trail, Super Cab XLT LWB P/up Dies.	FORD RANGER T6 4X2, 4X4 2.2D HP Double Cab - GBVAJQJ 2.2 TD MP Single Cab - GBVAJPF 2.5 - GBVAF, AK, AL 3.2D, TDCi, Wildtrack - SAFA	FORD SAPHIRE 1.6 L Kent 2.0 GL, GLE 2.0i GLi, GLi Exec., GLEA Koln 3.0 V6 Ghia, GLX Essex	FORD SIERRA 1.6 GL, L, SW Kent 2.0 GL, GL S/W, GLE, GLEA, GLi, LX Sedan, SW Koln
YEARS	07-12	2012-	89-93	83-93
Engine Configuration	INLINE	INLINE	INLINE	INLINE
Engine Mounting - Front				
Engine Mounting - Rear				
Engine Mounting - Left	AR5535 (2.5D) AR8383 (3.0)	AR9208 (All Man. Models) AR9089 (All Auto. Models)		AR5523 (1.6 GL, 2.0 GL)
Engine Mounting - Right	AR5535 (2.5D) AR8383 (3.0)	AR9209 (All Man. Models) AR9090 (All Auto. Models)		AR5523 (1.6 GL, 2.0 GL)
Engine Mounting - Other				
Transmission Mounting	AR8727 (Auto.) AR8728 (Man.)	AR9080 (4x2) (2.2 Man., 3.2 Man.) AR9094 (4x2) (2.2 Auto., 2.5 Man., 3.2 Auto.) AR9210 (4x4) (2.2, 3.2)	AR5172	AR5172
FRONT SUSPENSION				
Exhaust Hanger - Front				
Upper Control Arm Bush - Inner	AR6450	AR9062		
Upper Control Arm Bush - Outer	AR6450	AR9062		
Lower Control Arm Bush - Inner	AR5540 - Front	AR9063 - Front	AR5168	AR5168
Lower Control Arm Bush - Outer	AR5546 - Rear	AR9064 - Rear	SK211	SK211
Shock Rubber - Front	AR5574			
Stabilizer Bar Bush	AR5557	AR9065 (26mm) Std. Body AR9066 (29mm) Raised Body	AR5531	AR5512 (1.6 GL, 2.0 GL) AR5531 (1.6 L, 2.0 GLE, GLEA, GLi, LX)
Stabilizer Link Grommet				AR5081
Steering Coupling			SK500	SK500
Steering Rack Mounting				
Strut Mounting				
Tension Rod Bush	AR6055			
Miscellaneous	AR5423 Brake & Clutch Pedal Rubber		AR5442 X-Member Bar Insulator	AR5442 X-Member Bar Insulator
REAR SUSPENSION				
Centre Bearing Rubber	AR5544	AR8430		
Exhaust Hanger - Middle			AR5125	AR5125
Exhaust Hanger - Rear			AR5125	AR5125
Lower Control Arm Bush - Inner			AR5513	AR5513
Lower Control Arm Bush - Outer			AR5514	AR5514
Propshaft Coupling			AR5522	AR5522
Shackle Bush - Front		AR8780		
Shackle Bush - Rear Upper	AR5394 (4)	AR8781		
Shackle Bush - Rear Lower	AR5543 (4)	AR8782		
Shock Rubber - Rear	AR39			
Stabilizer Bar Bush				
Stabilizer Link Grommet				
Strut Mounting				
Miscellaneous				

APPLICATIONS	FORD SIERRA	FORD SPECTRON	FORD TELSTAR	FORD TERRITORY
	2.3 V6 GLE, SW - Cologne 3.0 V6 GLS, GLX, LX, RS XR6 3.0i V6 RS Essex	2.2 LWB Bus, P/van Pet. - F2	2.0 4-Cyl. GL, GLE - FS 2.0 V6 GLi, Mystique - KF 2.5i V6 Ghia, GLi - KL TX5 2.5 V6 RSi - KL	4X2, 4X4 4.0 Ghia, TX, ST
YEARS	83-93	91-04	92-99	05-10
Engine Configuration	INLINE	INLINE	TRANSVERSE	INLINE
Engine Mounting - Front				
Engine Mounting - Rear			AR6541 (2.0 Man. 4-Cyl.) AR6542 (2.0 Auto. 4-Cyl.) AR6553 (2.0, 2.5 Auto. V6) AR6554 (2.0, 2.5 Man. V6)	
Engine Mounting - Left	AR5523 (83-89)	AR5535	AR6543 (Man.) AR6544 (Auto.)	AR8985
Engine Mounting - Right	AR5523 (83-89)	AR5535	AR6545	AR8985
Engine Mounting - Other			AR6548 Damper (All 4-Cyl.)	
Transmission Mounting	AR5172	AR5798	AR6550	AR8986
FRONT SUSPENSION				
Exhaust Hanger - Front				
Upper Control Arm Bush - Inner				AR8982 - Front & Rear
Upper Control Arm Bush - Outer				
Lower Control Arm Bush - Inner	AR5168	AR5799	AR6558 - Front	AR8983
Lower Control Arm Bush - Outer	SK211	AR5799	AR6556 - Rear RHS AR6557 - Rear LHS	AR8984
Shock Rubber - Front		AR22		
Stabilizer Bar Bush	AR5512 (83-89) AR5531 (89-93)	AR5802	AR6555	AR9677 (AWD) AR9678 (RWD)
Stabilizer Link Grommet		AR5081		
Steering Coupling	SK500	AR5810	AR6566	
Steering Rack Mounting		AR6530 - LHS (Thick) AR6531 - RHS (Thin)		
Strut Mounting				
Tension Rod Bush				
Miscellaneous	AR5442 X-Member Bar Insulator	AR5407 Brake & Clutch Pedal Rubber AR5808 Accelerator Pedal Rubber	AR6546 (Man.) X-Member Mounting AR6547 (Auto.) X-Member Mounting	AR9683 Front Differential Bush
REAR SUSPENSION				
Centre Bearing Rubber				AR8987
Exhaust Hanger - Middle	AR5125	AR5139		AR9676
Exhaust Hanger - Rear	AR5125	AR5139		
Lower Control Arm Bush - Inner	AR5513			
Lower Control Arm Bush - Outer	AR5514			
Propshaft Coupling	AR5522			AR8988
Shackle Bush - Front		AR5543 (4)		
Shackle Bush - Rear Upper		AR5543 (4)		
Shackle Bush - Rear Lower		AR5543 (4)		
Shock Rubber - Rear		AR39		
Stabilizer Bar Bush			AR6560	AR9685
Strut Mounting			AR6574 - LHS (4-Cyl.) AR6575 - RHS (4-Cyl.)	
Miscellaneous			AR6561 Rear Trailing Link AR6562 Rear Lateral Link - RHS AR6563 Rear Lateral Link - LHS AR6564 Front Lateral Link - RHS AR6565 Front Lateral Link - LHS	AR9679 Centre Differential Bush (AWD) AR9680 Side Differential Bush (RWD) AR9681 Centre Differential Bush (RWD) AR9682 Side Differential Bush (AWD) AR9684 Trailing Arm Bush

APPLICATIONS	FOTON		GONOW	
	FOTON INKUNZI 2.2 Taxi - BJ491EQ1 VIEW 2.2 Taxi - BJ491EQ1	FOTON THUNDA 2.2i Taxi - 491EQ1 2.8D Taxi - 493ZQ	GONOW X-SPACE 2.2i DC, DCExt. 2.8 TDX DC.	GONOW X-SPACE 4X4 2.2 iL DC, XL DCExt. 2.8 TDX DCExt.
YEARS	07-09	2010-	07-10	07-10
Engine Configuration	INLINE	INLINE	INLINE	INLINE
Engine Mounting - Front				
Engine Mounting - Rear				
Engine Mounting - Left	AR5337	AR5369 (2.2) AR6384 (2.8)	AR5366 (2.2) AR5408 (2.8)	AR5366 (2.2) AR5408 (2.8)
Engine Mounting - Right	AR5337	AR5369 (2.2) AR6385 (2.8)	AR5366 (2.2) AR5408 (2.8)	AR5366 (2.2) AR5408 (2.8)
Engine Mounting - Other				
Transmission Mounting	AR5363	AR5363 (2.2) AR5613 (2.8)	AR5340	AR6007 (2.2) AR6008 (2.8)
FRONT SUSPENSION				
Upper Control Arm Bush - Inner				
Upper Control Arm Bush - Outer				
Lower Control Arm Bush - Inner	AR6053 AR6425 - Alt.	AR6053 AR6425 - Alt.	AR6059	AR6059
Lower Control Arm Bush - Outer				
Shock Rubber - Front				
Stabilizer Bar Bush			AR6066 AR6060 (2.2)	
Steering Coupling				
Steering Rack Mounting				
Strut Mounting				
Tension Rod Bush			AR6058 AR6055 (2.2)	
Miscellaneous				AR5065 (ID: 37mm) (4) Shackle Bush - Front Upper AR5065 (ID: 37mm) (4) Shackle Bush - Rear Lower AR5376 (ID: 56mm) (4) Shackle Bush - Rear Upper
REAR SUSPENSION				
Centre Bearing Rubber			AR5311	AR5313
Exhaust Hanger - Middle				
Exhaust Hanger - Rear				
Lower Control Arm Bush - Inner				
Lower Control Arm Bush - Outer				
Shackle Bush - Front				
Shackle Bush - Rear Upper			AR5065 (ID: 37mm) (4) AR5065 (4) (ID: 37mm) (2.2) AR6178 (4)	AR5065 (ID: 37mm) (4) AR6178 - Alt. (4)
Shackle Bush - Rear Lower			AR5065 (ID: 37mm) (4)	AR5065 (ID: 37mm) (4)
Shock Rubber - Rear			AR33	
Stabilizer Bar Bush				
Strut Mounting				
Miscellaneous				

APPLICATIONS	GWM	GWM STEED	GWM STEED 4X4		
		2.2i Double - Cab Lux, Multi - Wagon	2.2i Double - Cab Lux, Multi - Wagon		
YEARS		07-11	07-11		
Engine Configuration		INLINE	INLINE		
Engine Mounting - Front					
Engine Mounting - Rear					
Engine Mounting - Left		AR5366 AR8318 - Alt.	AR5366 AR8318 - Alt.		
Engine Mounting - Right		AR5366 AR8319 - Alt.	AR5366 AR8319 - Alt.		
Engine Mounting - Other					
Transmission Mounting		AR5340	AR6007		
		FRONT SUSPENSION			
Upper Control Arm Bush - Inner		AR8320	AR8320		
Upper Control Arm Bush - Outer					
Lower Control Arm Bush - Inner		AR6059	AR6059		
Lower Control Arm Bush - Outer					
Shock Rubber - Front					
Stabilizer Bar Bush		AR6060			
Steering Coupling					
Steering Rack Mounting					
Strut Mounting					
Tension Rod Bush		AR6055			
Miscellaneous					
		REAR SUSPENSION			
Centre Bearing Rubber		AR5311	AR5313		
Exhaust Hanger - Middle					
Exhaust Hanger - Rear					
Lower Control Arm Bush - Inner					
Lower Control Arm Bush - Outer					
Shackle Bush - Front		AR5065 (ID: 37mm) (4)	AR5065 (ID: 37mm) (4)		
Shackle Bush - Rear Upper		AR5065 (ID: 37mm) (4)	AR5065 (ID: 37mm) (4) AR5376 (ID: 56mm) AR6178 - Alt. (4)		
Shackle Bush - Rear Lower		AR5065 (ID: 37mm) (4)	AR5065 (ID: 37mm) (4)		
Shock Rubber - Rear		AR33			
Stabilizer Bar Bush					
Strut Mounting					
Miscellaneous					

APPLICATIONS	HONDA	HONDA ACCORD	HONDA ACCORD	HONDA BALLADE	HONDA BALLADE
		2.0i - K20A6 2.4i VTEC, Tourer, Exec. - K24A3	2.0i V-TEC - R20A3 2.2i D-TEC, Tourer, Exec. - N22B1 2.4i V-TEC, Tourer, Exec. - K24Z3	SA4 1300 - EN4	SC9 130 "Flip-Up Lights" - EV2 150 i "Flip-Up Lights" - EW 160i DOHC - ZC1
YEARS		03-08	08-15	82-89	84-89
Engine Configuration		TRANSVERSE	TRANSVERSE	TRANSVERSE	TRANSVERSE
Engine Mounting - Front		AR8633	AR1134 (R20A3)		
Engine Mounting - Rear		AR8190	AR9443	AR5391 (130) (84-89)	AR6155 (150, i - Man.), (150i - Auto.) AR5391 (130, 160) (Man.) AR5393 (160i) (Man.) AR6281 (150) (Auto.)
Engine Mounting - Left		AR9778 AR9779 - Alt.	AR9444	AR5556 (1300) (82-89)	AR6386 (130, 150, 160i - Man.), (150, i - Auto.) AR6387 (150i - Man.)
Engine Mounting - Right		AR8634	AR9445	AR5556 (1300) (82-89)	AR5224 (130 - Man.) AR5225 (Auto.)
Engine Mounting - Other					
Transmission Mounting					
		FRONT SUSPENSION			
Upper Control Arm Bush - Inner		AR8629	AR8629		
Upper Control Arm Bush - Outer		AR8629	AR8629		
Lower Control Arm Bush - Inner		AR8628 - Front Outer AR8209 - Front Inner	AR8628 - Front Outer AR8209 - Front Inner	AR5561 (1300) (82-89)	AR5572
Lower Control Arm Bush - Outer		AR8207 - Rear	AR8207 - Rear	AR5562 (1300) (82-89)	AR5572
Shock Rubber - Front					
Stabilizer Bar Bush		AR8630	AR9446		AR5571
Stabilizer Link Grommet					
Steering Coupling					
Steering Rack Mounting					
Strut Mounting		AR8632			
Miscellaneous					
		REAR SUSPENSION			
Centre Bearing Rubber					
Exhaust Hanger - Middle					
Exhaust Hanger - Rear					
Lower Control Arm Bush - Inner				AR5561 (1300) (82-89)	
Lower Control Arm Bush - Outer				AR5564 (1300) (82-89)	
Propshaft Coupling					
Shackle Bush - Front					
Shackle Bush - Rear Upper					
Shackle Bush - Rear Lower					
Stabilizer Bar Bush		AR8631	AR9447		
Stabilizer Link Grommet					AR5580
Strut Mounting		AR8632			
Miscellaneous		AR9440 Upper Subframe Bush - L/RHS AR9441 Front Lower Subframe Bush AR9442 Rear Lower Subframe Bush		AR6340 (130) (84-89) Stabilizer Link Assembly	AR6340 Stabilizer Link Assembly

APPLICATIONS	HONDA BALLADE SH4 150 16V SOHC - D15B3 160i 16V SOHC, DOHC - D16A9	HONDA BALLADE SR4 150 Encore, Luxline, Spreeline - D15B3 160E, i, Luxline, Spreeline - D16A7 180E, i Luxline, Spreeline - B18B3	HONDA BALLADE SO4 150i, Series, Encore, Luxline, Spreeline, Auto. - D15Z4 160i Luxline, Spreeline - D16Y9, 16Z 180i Luxline - B18B4	HONDA BALLADE 1.5 i-VTEC - L15A7
	YEARS	89-92	92-98	96-00
Engine Configuration	TRANSVERSE	TRANSVERSE	TRANSVERSE	TRANSVERSE
Engine Mounting - Front	AR6245 (Man.) AR6246 (Auto.)	AR6243 - LHS AR6244 - RHS	AR6243 - LHS AR6244 - RHS (Man.) (to 127600) AR6244 - RHS (Auto.) (to 127601) AR7504 - RHS (Auto.) (to 127600)	
Engine Mounting - Rear	AR7508 (Man.) AR6238 (Auto.)	AR7451	AR7451 - RHS AR7454 - Centre	AR9448 (Man.) AR9798 (Auto.)
Engine Mounting - Left	AR6239	AR6237 (150, 160i, 180i) AR6241 (160E, 180E)	AR6240	
Engine Mounting - Right	AR7507 (Man.) AR6242 (Auto.)	AR7450 (Man.) AR6236 (Auto.)		AR9449
Engine Mounting - Other				
Transmission Mounting				AR9450
FRONT SUSPENSION				
Upper Control Arm Bush - Inner	AR7441	AR7441 - Front	AR5567	
Upper Control Arm Bush - Outer	AR7441	AR7441 - Rear	AR5567	
Lower Control Arm Bush - Inner	AR5561	AR7433 - Front AR7438L/R - Rear L/RHS	AR5568 - Front AR7493 - Rear	AR9016
Lower Control Arm Bush - Outer	AR7434	AR7434	AR5569	AR9017L AR9017R AR9017I Insert Only
Shock Rubber - Front				
Stabilizer Bar Bush	AR5585	AR7435	AR6234 (ID: 22mm)	AR9018
Stabilizer Link Grommet	AR5081	AR7445		
Steering Coupling				
Steering Rack Mounting				
Strut Mounting	AR7505	AR7440	AR7492	AR8374 (Excl. Bearing) AR8374B (Incl. Bearing)
Tension Rod Bush	AR5134			
Miscellaneous				
REAR SUSPENSION				
Centre Bearing Rubber				
Exhaust Hanger - Middle				
Exhaust Hanger - Rear				
Lower Control Arm Bush - Inner	AR5596			
Lower Control Arm Bush - Outer	AR5596			
Propshaft Coupling				
Shackle Bush - Front				
Shackle Bush - Rear Upper				
Shackle Bush - Rear Lower				
Stabilizer Bar Bush		AR7446		
Stabilizer Link Grommet				
Strut Mounting				
Miscellaneous	AR5590 Upper Trailing Arm Bush - Outer	AR5590 Upper Trailing Arm Bush - Outer AR7448 Upper Trailing Arm Bush - Inner AR7453 Rear Upper Trailing Arm Bush - Inner L/RHS	AR7448 Upper Trailing Arm Bush - Inner AR7453 Rear Upper Trailing Arm Bush - Inner L/RHS	

APPLICATIONS	HONDA BRIO 1.2 - L12B1	HONDA CIVIC VI SO3 150i Luxline, Spreeline - D15Z4 160i Luxline - D16Y9 160i V-TEC - D16A6 SO4 160i V-TEC - D16Z 180i Luxline, Spreeline - B18B4	HONDA CIVIC VII 150i - D15Z4 170i - D17A5	HONDA CIVIC VIII 1.8i EXi, LXi 5-Spd. Man./ Auto. - R18A1 1.8i VXi 6-Spd. Man. - R18A2
YEARS	2012-	96-03	00-06	2006-
Engine Configuration	TRANSVERSE	TRANSVERSE	TRANSVERSE	TRANSVERSE
Engine Mounting - Front		AR7480 - RHS (Man.) (160i SO3/4, 180i) AR7481 - LHS (Man.) (160i SO3/4, 180i) AR6243 - LHS (Auto.) AR6244 - RHS (Auto.)	AR8191 (Man.) AR8192 (Auto.)	
Engine Mounting - Rear	AR9448 (Man.) AR9798 (Auto.)	AR7451 - RHS AR7454 - Centre	AR8188	AR9452 (R18A2) Lower Torque Rod AR1217 (R18A1 - Man.) Lower Torque Rod AR1220 (R18A1 - Auto.) Lower Torque Rod
Engine Mounting - Left		AR6240	AR8859	
Engine Mounting - Right	AR9449		AR8860	AR9451 (R18A2) AR9453 (R18A2) Upper Torque Rod AR1215 (R18A1) AR1216 (R18A1 - Man.) Upper Torque Rod AR1219 (R18A1 - Auto.) Upper Torque Rod
Engine Mounting - Other				
Transmission Mounting	AR9450			AR9454 (R18A2) AR1218 (R18A1)
FRONT SUSPENSION				
Upper Control Arm Bush - Inner		AR5567		
Upper Control Arm Bush - Outer		AR5567		
Lower Control Arm Bush - Inner	AR9016	AR5568 - Front AR7493 - Rear	AR8205	AR8286 (R18A2) AR1223 (R18A1)
Lower Control Arm Bush - Outer	AR9017L AR9017R AR9017I Insert Only	AR5569	AR8208	AR8638L (R18A2) AR8638R (R18A2)
Shock Rubber - Front				
Stabilizer Bar Bush	AR9018	AR6234 (ID: 22mm) AR6235 (ID: 26mm)	AR8635	AR8301 (R18A2)
Stabilizer Link Grommet				
Steering Coupling				
Steering Rack Mounting				
Strut Mounting	AR8374 (Excl. Bearing) AR8374B (Incl. Bearing)	AR7492	AR8636	AR1221 (R18A1) AR1222 (R18A2)
Tension Rod Bush				
Miscellaneous				
REAR SUSPENSION				
Lower Control Arm Bush - Inner				
Lower Control Arm Bush - Outer				
Shackle Bush - Front				
Shackle Bush - Rear Upper				
Shackle Bush - Rear Lower				
Stabilizer Bar Bush				
Stabilizer Link Grommet				
Strut Mounting			AR8637	
Miscellaneous		AR7448 Upper Trailing Arm Bush - Inner AR7453 Rear Upper Trailing Arm Bush - Inner L/RHS	AR8210 Rear Upper Trailing Arm Bush - Inner AR8211 Rear Upper Trailing Arm Bush - Outer	

APPLICATIONS	HONDA CIVIC IX 1.6 i-VTEC - N16A1 1.8 i-VTEC - R18Z4	HONDA CR-V 4X4 2.0 SWB SUV Pet. - B20B3, B20Z1	HONDA CR-V II 4X4 2.0i SWB SUV - K20A4 2.2 CTDi SWB SUV - N22A2 2.4i V-TEC SWB SUV - K24Z1, K24Z4	HONDA CR-V III 4X4 2.0i SWB SUV - R20A1 2.2 i-CTDi SWB SUV - N22A2 2.2 i-DTEC - N22B3 2.4i V-TEC SWB SUV - K24Z1, K24Z4
YEARS	2012-	97-05	05-09	09-12
Engine Configuration	TRANSVERSE	TRANSVERSE	TRANSVERSE	TRANSVERSE
Engine Mounting - Front		AR7480 - RHS AR7481 - LHS	AR8825 (2.0 Auto.) AR1015 (2.0 Man.)	AR1234 (2.4 Man.)
Engine Mounting - Rear		AR7451 - LHS	AR8824 (2.0 Auto.) AR1016 (2.0 Man.)	AR9461 (2.0 Auto., 2.4 Auto.) Lower Torque Rod AR1226 (2.0 Man., 2.4 Man.) Lower Torque Rod AR1230 (2.2) Lower Torque Rod
Engine Mounting - Left		AR9805		AR9462 (2.0 Auto., 2.4 Auto.) AR1227 (2.0 Man.)
Engine Mounting - Right			AR9865 (2.0)	AR9463 (2.0, 2.4) Upper Torque Rod AR1224 (2.0) AR1228 (2.2) AR1229 (2.2) Upper Torque Rod AR1232 (2.4)
Engine Mounting - Other				
Transmission Mounting			AR8890 (2.0 Auto.) AR1017 (2.0 Man.)	AR1231 (2.2) AR1235 (2.4 Man.)
FRONT SUSPENSION				
Upper Control Arm Bush - Inner		AR5567		
Upper Control Arm Bush - Outer		AR5567		
Lower Control Arm Bush - Inner	AR9455 - Front	AR5568 - Front Inner AR5569 - Front Outer	AR8205 - Front	AR8642
Lower Control Arm Bush - Outer	AR9456 - Rear	AR7493 - Rear	AR8208 - Rear	AR8640 - LHS AR8641 - RHS
Shock Rubber - Front				
Stabilizer Bar Bush	AR9457 (ID: 21mm) AR9458 (ID: 22mm) AR9459 (ID: 24mm)	AR6235	AR8639	AR9469 - LHS AR9470 - RHS
Stabilizer Link Grommet				
Steering Coupling				
Steering Rack Mounting				
Strut Mounting		AR5573 Kit	AR8636	AR9466
Tension Rod Bush				
Miscellaneous				
REAR SUSPENSION				
Centre Bearing Rubber			AR8891	AR9465 (R20A1) AR9468 (K24Z1/4) AR9471 (N22A2) AR9472 (N22B3)
Lower Control Arm Bush - Inner				
Lower Control Arm Bush - Outer				
Propshaft Coupling				
Shackle Bush - Front				
Shackle Bush - Rear Upper				
Shackle Bush - Rear Lower				
Stabilizer Bar Bush	AR9460 (ID: 10mm)			AR8643
Stabilizer Link Grommet				
Strut Mounting		AR5573 Kit	AR8637	AR9467
Miscellaneous				

APPLICATIONS	HONDA JAZZ II GD 1.4i-DSi - L13A1 1.5i - L15A1	HONDA JAZZ III GE 1.3i - L13Z1 1.3i CVT - LDA3 1.4i - L13Z1 1.5i - L15A7	HONDA JAZZ IV GK 1.2 - L12B4 1.5i - L15Z2	
	YEARS	03-08	08-14	2015-
Engine Configuration	TRANSVERSE	TRANSVERSE	TRANSVERSE	
Engine Mounting - Front	AR9693 (Man.)			
Engine Mounting - Rear	AR8376 (Man.) AR8379 (CVT)	AR9019 (1.3i CVT) AR9448 (Man.) AR9798 (Auto.)	AR1279 (Man.) (1.2, 1.5) Torque Rod AR1281 (1.5 CVT) Torque Rod	
Engine Mounting - Left				
Engine Mounting - Right	AR8375 (Man.) AR8380 (CVT)	AR9020 (1.3i Hybrid - CVT) AR9449 (1.3i, 1.4i, 1.5i)	AR1278	
Engine Mounting - Other				
Transmission Mounting	AR8377 (Man.) AR8378 (CVT)	AR9021 (1.3i Hybrid - CVT) AR9450 (1.3i, 1.4i, 1.5i)	AR1280 (Man.) (1.2, 1.5) AR1282 (1.5 CVT)	
FRONT SUSPENSION				
Upper Control Arm Bush - Inner				
Upper Control Arm Bush - Outer				
Lower Control Arm Bush - Inner	AR8381	AR9016		
Lower Control Arm Bush - Outer	AR8382	AR9017L AR9017R AR9017I Insert Only		
Shock Rubber - Front				
Stabilizer Bar Bush	AR8373 AR9022 - Alt.	AR9022	AR1283	
Stabilizer Link Grommet				
Steering Coupling				
Steering Rack Mounting				
Strut Mounting	AR8374 (Excl. Bearing) AR8374B (Incl. Bearing)	AR8374 (Excl. Bearing) AR8374B (Incl. Bearing)	AR8374 (Excl. Bearing) AR8374B (Incl. Bearing)	
Tension Rod Bush				
Miscellaneous				
REAR SUSPENSION				
Centre Bearing Rubber				
Exhaust Hanger - Middle		AR9473		
Exhaust Hanger - Rear		AR9474		
Lower Control Arm Bush - Inner				
Lower Control Arm Bush - Outer				
Propshaft Coupling				
Shackle Bush - Front				
Shackle Bush - Rear Upper				
Shackle Bush - Rear Lower				
Stabilizer Bar Bush				
Stabilizer Link Grommet				
Strut Mounting				
Miscellaneous				

APPLICATIONS		HYUNDAI ACCENT 1.3 XS, LS - G4EH 1.5 CSi, RSi, LS - G4EK	HYUNDAI ACCENT 1.3 LS - G4EH 1.5 LS - G4EK	HYUNDAI ACCENT 1.3 LS - G4EH 1.5 LS - G4EK 1.6 GLS, HS, SR Sport, - G4ED	HYUNDAI ACCENT 1.6 GLS, HS - G4ED 1.6 - G4FC
YEARS		94-01	00-03	03-06	2006-
Engine Configuration		TRANSVERSE	TRANSVERSE	TRANSVERSE	TRANSVERSE
Engine Mounting - Front		AR7697 SOHC AR7698 DOHC			AR9101 Insert Only AR9756 Complete
Engine Mounting - Rear		AR7709	AR7728	AR7728	AR9102 Insert Only AR9757 Complete
Engine Mounting - Left			AR7729	AR7729	AR9103
Engine Mounting - Right					AR9104
Engine Mounting - Other					
Transmission Mounting		AR7711 SOHC (Man.) (94-96) AR7712 SOHC (Auto.) (94-96) AR7713 DOHC (Auto.) (94-96)			
	FRONT SUSPENSION				
Upper Control Arm Bush - Inner					
Upper Control Arm Bush - Outer					
Lower Control Arm Bush - Inner		AR7717 - Front	AR7848 - Front	AR7848 - Front	AR7848 - Front
Lower Control Arm Bush - Outer		AR7716 - Rear	AR7732 - Rear	AR7732 - Rear	AR7860 - Rear
Stabilizer Bar Bush		AR7718	AR7733	AR7733	AR8647 (06-11) AR9105 (2011-)
Steering Rack Mounting		AR7719 - LHS AR7720 - RHS	AR7734 - L/RHS		
Strut Mounting		AR7705 (1.5 Only)	AR7705	AR7705	AR9100 (06-11) AR8872 (2011-)
Miscellaneous					
	REAR SUSPENSION				
Centre Bearing Rubber					
Exhaust Hanger - Middle					
Exhaust Hanger - Rear					
Lower Control Arm Bush - Inner					
Lower Control Arm Bush - Outer					
Propshaft Coupling					
Stabilizer Bar Bush			AR7735	AR7735	
Strut Mounting			AR8646	AR8646	
Miscellaneous		AR7722 Front Lateral Link AR7723 Rear Lateral Link AR7724 Front Lateral Link Bush AR7725 Rear Trailing Link - LHS AR7726 Rear Trailing Link - RHS AR7727 Rear Trailing Link Bush	AR7736 Front Lateral Link - LHS AR7737 Front Lateral Link - RHS AR7738 Rear Lateral Link - RHS AR7739 Rear Lateral Link - LHS AR7740 Rear Trailing Link Bush - Outer AR7741 Rear Trailing Link Bush - Inner AR7742 Rear Trailing Link - RHS AR7744 Rear Trailing Link - LHS AR7746 Rear Trailing Link Bush - Front AR7747 Rear Trailing Link Bush - Rear		

HYUNDAI

APPLICATIONS	HYUNDAI ATOS 1.0 Prime - G4HC 1.1 GLS - G4HG	HYUNDAI ATOS 1.0 Prime - G4HC 1.1 GLS - G4HG	HYUNDAI BAKKIE 2.5i DT LWB P/up, P/van Dies. - 4D56 2.6i LWB P/van, P/up, Dropside Pet. - 4G54	HYUNDAI ELANTRA J1 1.6 GLS, Exec - G4GR 1.8 GLi, Exec - G4CN
	YEARS	00-07	07-13	97-09
Engine Configuration	TRANSVERSE	TRANSVERSE	INLINE	TRANSVERSE
Engine Mounting - Front	AR8398	AR8398		AR7694 (1.6) AR7693 (1.8)
Engine Mounting - Rear	AR8389	AR8389	AR6715 (2.5) AR6714 (2.6)	AR7748 (1.6) AR7760 (1.8)
Engine Mounting - Left			AR5195	AR7749 (1.6) AR7762 (1.8)
Engine Mounting - Right			AR5195	AR7761
Engine Mounting - Other				
Transmission Mounting	AR8861	AR8861		AR7750 (1.6) AR7765 (1.8)
FRONT SUSPENSION				
Upper Control Arm Bush - Inner				
Upper Control Arm Bush - Outer				
Lower Control Arm Bush - Inner	AR8392	AR8648	AR6720	AR7751 - Front
Lower Control Arm Bush - Outer	AR8391	AR8649L AR8649R	AR6720	AR7752 - Rear
Shock Rubber - Front				
Stabilizer Bar Bush	AR8390	AR8390	AR6723	AR7754
Stabilizer Link Grommet			AR5092	AR7755
Steering Coupling				
Steering Rack Mounting				
Strut Mounting	AR8650	AR8650		AR7706 (1.8)
Tension Rod Bush				
Miscellaneous	AR8862 Stabilizer Bar Link	AR8862 Stabilizer Bar Link		
REAR SUSPENSION				
Centre Bearing Rubber				
Exhaust Hanger - Middle				
Exhaust Hanger - Rear				
Lower Control Arm Bush - Inner				
Lower Control Arm Bush - Outer				
Propshaft Coupling				
Shackle Bush - Front			AR5554 (4)	
Shackle Bush - Rear Upper			AR5552 (4)	
Shackle Bush - Rear Lower			AR5553 (4)	
Shock Rubber - Rear			AR33	
Stabilizer Bar Bush				
Stabilizer Link Grommet				
Strut Mounting				
Miscellaneous				AR7756 Rear Axle Beam Bush AR7757 Rear Lateral Link AR7758 Rear Axle Support Bush - Inner AR7759 Rear Axle Support Bush - Outer

APPLICATIONS	HYUNDAI ELANTRA J2	HYUNDAI ELANTRA XD	HYUNDAI ELANTRA HD	HYUNDAI ELANTRA MD / UD
	1.6 GL S/W, GLi, GLS - G4GR 1.8 GL, GL S/W, GLS - G4FG 2.0 - G4GC	1.6 GL, GLS Pet. - G4ED 2.0 GLS, GLS S/W Pet. - G4GC 2.0 CRDi GLS Dies.	1.6 GLS 2.0 GLS - G4GC	1.6 - G4FG 1.8 - G4NB
YEARS	95-01	00-06	07-11	2011-
Engine Configuration	TRANSVERSE	TRANSVERSE	TRANSVERSE	TRANSVERSE
Engine Mounting - Front	AR7695 - Centre (Man.) AR7696 - Centre (Auto.)	AR7783	AR8874	
Engine Mounting - Rear	AR7766 (95-98) AR7767 (98-01)	AR7785	AR8875	AR8866
Engine Mounting - Left	AR7749		AR8876	AR9542
Engine Mounting - Right	AR7761	AR7704	AR8877	AR9543
Engine Mounting - Other				
Transmission Mounting	AR7770	AR7789 (Auto.) AR7790 (Man.)		
FRONT SUSPENSION				
Upper Control Arm Bush - Inner				
Upper Control Arm Bush - Outer				
Lower Control Arm Bush - Inner	AR7772 - Front	AR7791 - Front	AR7791 - Front	AR9125 - Front
Lower Control Arm Bush - Outer	AR7773 - Rear L/RHS	AR7792 - Rear (OD: 60mm) AR8659 - Rear (OD: 63mm)	AR7792 - Rear	AR7860 - Rear
Shock Rubber - Front				
Stabilizer Bar Bush	AR7774 (95-98)	AR7793	AR8658	AR9126 (ID: 22mm)
Stabilizer Link Grommet				
Steering Coupling				
Steering Rack Mounting				
Strut Mounting	AR7706	AR7706	AR9100	AR9127
Tension Rod Bush				
Miscellaneous				
REAR SUSPENSION				
Centre Bearing Rubber				
Exhaust Hanger - Middle				
Exhaust Hanger - Rear				
Lower Control Arm Bush - Inner				
Lower Control Arm Bush - Outer				
Propshaft Coupling				
Shackle Bush - Front				
Shackle Bush - Rear Upper				
Shackle Bush - Rear Lower				
Stabilizer Bar Bush			AR7777	
Stabilizer Link Grommet				
Strut Mounting				
Miscellaneous	AR7780 Front Lateral Link Bush (97-01) AR7781 Rear Lateral Link Bush (97-01) AR7782 Rear Trailing Link Bush (97-01)	AR7780 Front Lateral Link Bush AR7781 Rear Lateral Link Bush AR7782 Rear Trailing Link Bush		

APPLICATIONS	HYUNDAI GETZ 1.3 - G4EA 1.4i HS - G4EE 1.5 CRDi, HS - D3EA 1.6, HS - G4ED-G	HYUNDAI H1 2.4 CVVT - G4KC 2.5 CRDi - D4CB	HYUNDAI H100 2.5i DT LWB P/up, Dropside Dies. - 4D56 2.6i LWB P/van, Dropside - D4BB [2006-] 2.5i DT LWB P/up, Dropside Dies. - D4BH 2.6i LWB P/van, Dropside - D4BB	HYUNDAI i10 1.1 GLS - G4HG 1.2 GLS, GLS HS - G4LA
YEARS	03-12	2009-	98-09	2008-
Engine Configuration	TRANSVERSE	INLINE	INLINE	TRANSVERSE
Engine Mounting - Front				AR8839
Engine Mounting - Rear	AR7708 (Man.) AR7710 (Auto.) AR9001 (1.4, 1.5)		AR6715 (2.5) (97-04) AR6714 (2.6) (97-04)	
Engine Mounting - Left		AR9031	AR5223	
Engine Mounting - Right	AR7701	AR9031	AR5223	AR8864
Engine Mounting - Other				
Transmission Mounting	AR8395 (1.3) AR7715 Insert for AR8395 AR9002 (1.5, 1.6) AR9738 (1.4)	AR9032		AR8865
FRONT SUSPENSION				
Upper Control Arm Bush - Inner				
Upper Control Arm Bush - Outer				
Lower Control Arm Bush - Inner	AR7848 - Front	AR9033 - Front	AR6720 (97-04) AR8358 (04-09)	AR7848
Lower Control Arm Bush - Outer	AR8778 - Rear	AR9034 - Rear	AR6720	AR8654
Shock Rubber - Front				
Stabilizer Bar Bush	AR8394	AR8665	AR6723 (97-04) AR8393 (04-09)	AR8655
Stabilizer Link Grommet			AR5092 (97-04)	
Steering Coupling				
Steering Rack Mounting				
Strut Mounting	AR7705	AR9035		AR8708
Tension Rod Bush				
Miscellaneous				
REAR SUSPENSION				
Centre Bearing Rubber				
Exhaust Hanger - Middle	AR7730			
Exhaust Hanger - Rear	AR7730			
Lower Control Arm Bush - Inner				
Lower Control Arm Bush - Outer				
Propshaft Coupling				
Shackle Bush - Front			AR5554 (4) (97-04)	
Shackle Bush - Rear Upper			AR5552 (4) (97-04)	
Shackle Bush - Rear Lower			AR5553 (4) (97-04)	
Shock Rubber - Rear			AR33 (97-04)	
Stabilizer Bar Bush		AR9036		
Stabilizer Link Grommet				
Strut Mounting				
Miscellaneous	AR8863 Rear Axle Beam Bush			

APPLICATIONS	HYUNDAI GRAND i10	HYUNDAI i20	HYUNDAI i30	HYUNDAI i30
	1.0 Fluid, Motion, 5-Spd. Man., 4-Spd. Auto - G3LA 1.2 Fluid, Glide, Motion, 5-Spd. Man., 4-Spd. Auto - G4LA	1.2 Fluid, Motion - G4LA 1.4 Fluid, Glide - G4FA 1.4 CRDi Glide - D4FC 1.6 GLS - G4FC	1.6 - G4FG 2.0 - G4GC-G	1.6 GLS, Premium - G4GG 1.8 GLS, Executive - G4NB-B
YEARS	2014-	2009-	10-12	2012-
Engine Configuration		TRANSVERSE	TRANSVERSE	TRANSVERSE
Engine Mounting - Front			AR8874	
Engine Mounting - Rear	AR1002 (1.0) AR1009 (1.2)	AR8866	AR8875	AR9647
Engine Mounting - Left		AR8867 (1.2) AR9851 (1.4, 1.6)	AR8876	AR9648
Engine Mounting - Right	AR1006	AR8868	AR8877	AR9649
Engine Mounting - Other				
Transmission Mounting	AR1004 (Man.) AR1005 (Auto.)			
FRONT SUSPENSION				
Upper Control Arm Bush - Inner				
Upper Control Arm Bush - Outer				
Lower Control Arm Bush - Inner	AR8869 - Front	AR8869 - Front	AR8666 - Front	AR9125 - Front
Lower Control Arm Bush - Outer	AR8870 - Rear	AR8870 - Rear	AR8668 - Rear	AR8817 - Rear
Shock Rubber - Front				
Stabilizer Bar Bush	AR1010	AR8871	AR8658	AR9651
Stabilizer Link Grommet				
Steering Coupling				
Steering Rack Mounting				
Strut Mounting	AR1011	AR8708	AR9100	AR9650
Tension Rod Bush				
Miscellaneous	AR1007 Brake Pedal (Man.) AR1008 Brake Pedal (Auto.)			
REAR SUSPENSION				
Centre Bearing Rubber				
Exhaust Hanger - Middle				
Exhaust Hanger - Rear				
Lower Control Arm Bush - Inner				
Lower Control Arm Bush - Outer				
Propshaft Coupling				
Shackle Bush - Front				
Shackle Bush - Rear Upper				
Shackle Bush - Rear Lower				
Stabilizer Bar Bush			AR8878	AR8878
Stabilizer Link Grommet				
Strut Mounting			AR8879	
Miscellaneous	AR1012 Rear Axle Beam Bush	AR8873 Rear Axle Beam Bush		

APPLICATIONS	HYUNDAI iX35 4X2, 4X4 2.0 CRDi - D4HA, G4KD, G4NA 2.4 - G4KE 4x4	HYUNDAI MATRIX 1.6 - G4ED-G 1.8 - G4GB-G	HYUNDAI SANTA FE' 2.2 CRDi - D4EB 2.2 CRDi - D4HB	HYUNDAI SANTA FE' 4X4 2.4 - G4JS 2.7 - G6BA-G, G6EA
	YEARS	2010-	02-07	2006-
Engine Configuration	TRANSVERSE	TRANSVERSE	TRANSVERSE	TRANSVERSE
Engine Mounting - Front	AR9643		AR9110	AR7907 (2.4) AR7908 (2.7)
Engine Mounting - Rear		AR9654	AR9111	AR7905 (2.4) AR7906 (2.7)
Engine Mounting - Left	AR9644	AR9652	AR9112 (06-10)	AR7909 (2.4) AR7910 (2.7)
Engine Mounting - Right	AR9645	AR9653	AR9113 (06-10)	
Engine Mounting - Other				
Transmission Mounting	AR9646 Other			
FRONT SUSPENSION				
Exhaust Hanger - Front				AR7913
Upper Control Arm Bush - Inner				
Upper Control Arm Bush - Outer				
Lower Control Arm Bush - Inner	AR8816	AR7848	AR8668 - Front	AR7914
Lower Control Arm Bush - Outer	AR8817	AR8659	AR8664 - Rear	AR7915
Shock Rubber - Front				
Stabilizer Bar Bush	AR9106	AR8661	AR8665	AR7916
Stabilizer Link Grommet				
Steering Coupling				
Steering Rack Mounting				AR7917
Strut Mounting	AR8818	AR7706	AR9035	AR7918
Tension Rod Bush				
Miscellaneous				
REAR SUSPENSION				
Centre Bearing Rubber	AR8894		AR8894 (06-13)	AR7911 AR7912 - Alt.
Exhaust Hanger - Middle				AR7913
Exhaust Hanger - Rear				AR7913
Upper Control Arm Bush			AR9107	
Lower Control Arm Bush - Inner				
Lower Control Arm Bush - Outer				AR7921
Propshaft Coupling				
Shackle Bush - Front				
Shackle Bush - Rear Upper				
Shackle Bush - Rear Lower				
Stabilizer Bar Bush	AR8821		AR9108	
Stabilizer Link Grommet				
Strut Mounting	AR8820	AR8662L AR8662R		
Miscellaneous	AR1098L AR1098R Trailing Arm Bush L/RHS			AR7926 Rear Upper / Lower Lateral Link Bush - L/RHS

APPLICATIONS	HYUNDAI SANTA FE' 4X4 2.2 CRDi - D4EB, D4HB 2.7 GLS - G6EA	HYUNDAI S-COUPE 1.5 GT, LS - 4GDM, G4EK-T	HYUNDAI SONATA 2.0 GL, GLS - G4JP	HYUNDAI SONATA 2.0 GL, GLS - G4JP
YEARS	2006-	94-95	94-95	96-99
Engine Configuration	TRANSVERSE	TRANSVERSE	TRANSVERSE	TRANSVERSE
Engine Mounting - Front	AR7908 (2.7) AR9110 (2.2)	AR7697 SOHC AR7698 DOHC	AR7699	AR7813 (96-97) (Man.) AR7814 (97-99) (Man.) AR7815 (96-97) (Auto.) AR7816 (97-99) (Auto.)
Engine Mounting - Rear	AR7906 (2.7) AR9111 (2.2)	AR7709	AR7798 (Man.) AR7797 (Auto.)	AR7817 (96-97) (Man.) AR7818 (97-99) (Man.) AR7819 (96-99) (Auto.)
Engine Mounting - Left	AR7910 (2.7) AR9112 (2.2)		AR7795	AR7795 (96-97) (Man. / Auto.) AR7821 (97-99) (Man. / Auto.)
Engine Mounting - Right	AR9113 (2.2)			
Engine Mounting - Other				
Transmission Mounting		AR7711 (SOHC)	AR7799 (Man.) AR7800 (Auto.)	AR7824 (96-97) (Man.) AR7825 (97-99) (Man.) AR7826 (96-97) (Auto.)
FRONT SUSPENSION				
Upper Control Arm Bush - Inner				
Upper Control Arm Bush - Outer				
Lower Control Arm Bush - Inner	AR8668 - Front	AR7717 - Front	AR7805 - Front	AR7805 - Front
Lower Control Arm Bush - Outer	AR8664 - Rear	AR7716 - Rear	AR7806L - Rear LHS AR7806R - Rear RHS	AR7806L - Rear LHS AR7806R - Rear RHS
Stabilizer Bar Bush	AR8665	AR7718	AR7807	AR7835 AR7836 - Alt
Stabilizer Link Grommet				
Steering Coupling				
Steering Rack Mounting		AR7719 - LHS AR7720 - RHS	AR7837 - L/RHS	AR7837 - L/RHS
Strut Mounting	AR9035	AR7705	AR7707	AR7707
Tension Rod Bush				
Miscellaneous				
REAR SUSPENSION				
Centre Bearing Rubber	AR8894 (06-13)			
Exhaust Hanger - Middle				
Exhaust Hanger - Rear				
Upper Control Arm Bush	AR9107			
Lower Control Arm Bush - Inner				
Lower Control Arm Bush - Outer				
Propshaft Coupling				
Shackle Bush - Front				
Shackle Bush - Rear Upper				
Shackle Bush - Rear Lower				
Stabilizer Bar Bush	AR9108			
Stabilizer Link Grommet				
Strut Mounting				
Miscellaneous		AR7722 Front Lateral Link AR7723 Rear Lateral Link AR7724 Front Lateral Link Bush AR7725 Rear Trailing Link - LHS AR7726 Rear Trailing Link - RHS AR7727 Rear Trailing Link Bush	AR7808 Rear Axle Support Bush - Inner AR7809 Rear Axle Support Bush - Outer AR7810 Rear Lateral Link AR7811 Rear Lateral Link Bush AR7812 Rear Axle Beam Bush	AR7756 Rear Axle Beam Bush AR7838 Front Lateral Link AR7839 Front Lateral Link Bush, Rear Control Arm Bush AR7840 Rear Subframe Bush AR7842 Rear Trailing Link Bush

APPLICATIONS	HYUNDAI SONATA 2.0 GLS, Allegro - G4JP 2.5 V6, Vivante - G6BV	HYUNDAI SONATA 2.7 V6 - G6BA-G	HYUNDAI SONATA 3.0 GLS V6 - G6AT	HYUNDAI SONATA 3.0 GLS V6 - G6AT
YEARS	96-05	96-05	94-95	96-00
Engine Configuration	TRANSVERSE	TRANSVERSE	TRANSVERSE	TRANSVERSE
Engine Mounting - Front	AR7849 (98-05) (Man.) AR7851 (98-05) (Auto.) AR7850 (04-05) (Man.) AR7852 (04-05) (Auto.) AR7859 (2.5) (98-02)	AR7849 (98-05) (Man.) AR7851 (98-05) (Auto.) AR7850 (04-05) (Man.) AR7852 (04-05) (Auto.)		
Engine Mounting - Rear	AR7853 (2.0 Allegro) AR7854 (2.0, 2.5) (04-05)			
Engine Mounting - Left	AR7845 (Man.) AR7847 (Auto.)	AR7895 (03-05)		
Engine Mounting - Right	AR7700 (2.5) (98-02) AR7843 (2.0) (96-04) AR7844 (2.0) (04-05)			
Engine Mounting - Other				
Transmission Mounting	AR7856 (2.0) (96-04)			
FRONT SUSPENSION				
Upper Control Arm Bush - Inner	AR7861 (2.0)	AR7861		
Upper Control Arm Bush - Outer	AR7861 (2.0)	AR7861		
Lower Control Arm Bush - Inner	AR7862 - Front Outer AR7863 - Front Inner	AR7862 - Front Outer AR7863 - Front Inner	AR7805 - Front	AR7805 - Front
Lower Control Arm Bush - Outer	AR7864 - Rear (2.0 Allegro & 2.5) (00-02)	AR7792 - Rear (03-05)	AR7806L - Rear LHS AR7806R - Rear RHS	AR7806L - Rear LHS AR7806R - Rear RHS
Shock Rubber - Front	AR7870 - Upper AR7871 - Lower	AR7870 - Upper AR7871 - Lower		
Stabilizer Bar Bush	AR7866 AR7867 - Alt. (2.0 Allegro, 2.5) AR7868 (2.0) (04-05)	AR7793 (03-05)	AR7807	AR7835 AR7836 - Alt.
Stabilizer Link Grommet	AR7869			
Steering Coupling				
Steering Rack Mounting	AR7872 - L/RHS	AR7896 (03-05)	AR7837 - L/RHS	AR7837 - L/RHS
Strut Mounting	AR7865	AR7865		
Tension Rod Bush				
Miscellaneous				
REAR SUSPENSION				
Centre Bearing Rubber				
Exhaust Hanger - Middle				
Exhaust Hanger - Rear				
Lower Control Arm Bush - Inner				
Lower Control Arm Bush - Outer				
Stabilizer Bar Bush				
Stabilizer Link Grommet	AR7869	AR7869		
Strut Mounting				
Miscellaneous	AR7842 Rear Assisting Link Bush - Upper AR7873 Rear Assisting Link - Lower AR7874 Rear Assisting Link Bush - Lower AR7875 Upper Control Arm Bush - LHS AR7876 Upper Control Arm Bush - RHS AR7878 Rear Knuckle Bush AR7882 Rear Assisting Link - Upper	AR7782 Rear Trailing Link Bush AR7899 Front Lateral Link AR7900 Rear Lateral Link AR7901 Front Lateral Link Bush AR7902 Rear Lateral Link Bush AR7903 Rear Trailing Link - LHS AR7904 Rear Trailing Link - RHS	AR7808 Rear Axle Support Bush - Inner AR7809 Rear Axle Support Bush - Outer AR7810 Rear Lateral Link AR7811 Rear Lateral Link Bush AR7812 Rear Axle Beam Bush	AR7756 Rear Axle Beam Bush AR7838 Front Lateral Link AR7839 Front Lateral Link Bush, Rear Control Arm Bush AR7840 Rear Subframe Bush AR7842 Rear Trailing Link Bush

APPLICATIONS	HYUNDAI SONATA NF 2.4 GLS	HYUNDAI SONATA YF 2.4 GDi - G4KC	HYUNDAI TIBURON 2.0 - G4DF	HYUNDAI TIBURON 2.0 - G4DF 2.7 V6 DOHC - G6BA-G
	YEARS	05-10	10-15	95-03
Engine Configuration	TRANSVERSE	TRANSVERSE	TRANSVERSE	TRANSVERSE
Engine Mounting - Front	AR9115	AR9538	AR7695	AR7893
Engine Mounting - Rear	AR9116		AR7766 AR7883 (99-03) (Auto.)	AR7785
Engine Mounting - Left	AR9117	AR9539	AR7749	
Engine Mounting - Right	AR9118	AR9540	AR7749	AR7704
Engine Mounting - Other				
Transmission Mounting			AR7770	
FRONT SUSPENSION				
Upper Control Arm Bush - Inner	AR8703 - Front	AR8703 - Front		
Upper Control Arm Bush - Outer	AR8703 - Rear	AR8703 - Rear		
Lower Control Arm Bush - Inner	AR8704 - Front AR8705 - Rear	AR8816 - Front	AR7791 (00-03) AR7772 - Front	AR7791 - Front
Lower Control Arm Bush - Outer	AR8706	AR8817 - Rear	AR7773 - Rear L/RHS	AR7792 - Rear
Shock Rubber - Front				
Stabilizer Bar Bush	AR8665	AR9122	AR7884 AR7793 (00-03)	AR7793
Stabilizer Link Grommet				
Steering Coupling				
Steering Rack Mounting				AR7896 - L/RHS
Strut Mounting	AR9120	AR9858	AR7706	AR7706
Tension Rod Bush				
Miscellaneous				
REAR SUSPENSION				
Centre Bearing Rubber				
Exhaust Hanger - Middle				
Exhaust Hanger - Rear				
Lower Control Arm Bush - Inner				
Lower Control Arm Bush - Outer				
Propshaft Coupling				
Stabilizer Bar Bush	AR9119	AR9123		
Stabilizer Link Grommet				
Strut Mounting	AR9121	AR9859		
Miscellaneous			AR7782 (00-03) Rear Trailing Link Bush AR7780 (00-03) Front Lateral Link Bush AR7781 (00-03) Rear Lateral Link Bush AR7887 Front Lateral Link AR7888 Rear Lateral Link AR7889 Rear Trailing Link - LHS (with Rear Drums) AR7890 Rear Trailing Link - RHS (with Rear Drums) AR7891 Rear Trailing Link - LHS (with Rear Discs) AR7892 Rear Trailing Link - RHS (with Rear Discs)	AR7782 Rear Trailing Link Bush AR7899 Front Lateral Link AR7900 Rear Lateral Link AR7901 Front Lateral Link Bush AR7902 Rear Lateral Link Bush AR7903 Rear Trailing Link - LHS AR7904 Rear Trailing Link - RHS

APPLICATIONS	HYUNDAI TUCSON 2.0 GLS - G4GC	HYUNDAI TUCSON 4X4 2.0 CRDi - D4EA 2.7 V6 - G6BA-G	HYUNDAI VELOSTER 1.6 GDi - G4FD, G4FJ	
	YEARS	04-11	04-10	2013-
Engine Configuration	TRANSVERSE	TRANSVERSE	TRANSVERSE	
Engine Mounting - Front	AR9003	AR9007 (2.0) AR9011 (2.7)		
Engine Mounting - Rear	AR9006	AR9010 (2.0) AR9013 (2.7)	AR8866	
Engine Mounting - Left			AR9248	
Engine Mounting - Right	AR9004	AR9008 (2.0) AR9004 (2.7)	AR9249	
Engine Mounting - Other				
Transmission Mounting	AR9005	AR9009 (2.0) AR9012 (2.7)		
FRONT SUSPENSION				
Upper Control Arm Bush - Inner				
Upper Control Arm Bush - Outer				
Lower Control Arm Bush - Inner	AR8666	AR8666	AR9125	
Lower Control Arm Bush - Outer	AR7860	AR7860	AR7860	
Shock Rubber - Front				
Stabilizer Bar Bush	AR8667	AR8667	AR9105 AR9126 - Alt.	
Stabilizer Link Grommet				
Steering Coupling				
Steering Rack Mounting				
Strut Mounting	AR8818		AR9127	
Tension Rod Bush				
Miscellaneous				
REAR SUSPENSION				
Centre Bearing Rubber	AR8913	AR8913		
Exhaust Hanger - Middle				
Exhaust Hanger - Rear				
Lower Control Arm Bush - Inner				
Lower Control Arm Bush - Outer				
Propshaft Coupling	AR8914	AR8914		
Shackle Bush - Front				
Shackle Bush - Rear Upper				
Shackle Bush - Rear Lower				
Stabilizer Bar Bush				
Stabilizer Link Grommet				
Strut Mounting				
Miscellaneous				

APPLICATIONS	ISUZU	ISUZU	ISUZU	ISUZU 4X4	ISUZU
		KBD20/21 2.0 SWB P/up Dies. - C190 KBD22 2.2 LE SWB P/up Dies. - C223 KBD23 2.5 LE SWB P/up Dies. - 4JA1 KBD25/26 2.0 LWB P/up Dies. - C190 KBD27 2.2 LWB P/up Dies. - C223 KBD28 2.5 LWB P/up Dies. - 4JA1	KB21 1.6 SWB, Fleetside, P/up Pet. - G161Z 1.8 SWB, P/up Pet. - G180Z KB22 1.8 SWB P/up Pet. - 180Z KB23 2.0 SWB P/up Pet. - 200Z KB24 2.3 LE SWB P/up Pet. - 4ZD1 KB26 1.6 LWB P/up Pet. - G161Z 1.8 LWB P/up Pet. - G180Z KB27 1.8 LWB P/up Pet. - G180Z KB29 2.3 LWB P/up Pet. - 4ZD1	KB40 SWB P/up Pet. - G161Z KBD40 SWB P/up Dies. - C190 KB41 SWB P/up Pet. - G161Z, SWB P/up Pet. - G180Z KB42 SWB P/up - G180Z KB43 SWB P/up Pet. - G200Z KB44 LE SWB P/up Pet. - 4ZD1 KBD41 Dies. - C190 KBD42 Dies. - C223	KB160 1.6 SWB, Fleetside P/up Pet. - 4ZA1 KB200 2.0 SWB, LWB D/cab, LE, Fleetside P/up Pet. - ZC1 KB220 2.2 LWB D/cab, LE P/up Pet. - C22NE KB230 2.3 SWB, LWB, D/cab P/up Pet. - 4ZD1 KB250D 2.5 SWB, LWB D/cab, LE, Fleetside P/up Dies. - 4JA1 KB280DT 2.8 SWB, LWB LE, D/cab LE, Frontier LX P/up - 4JB1
YEARS		78-89	81-89	79-89	89-04
Engine Configuration		INLINE	INLINE	INLINE	INLINE
Engine Mounting - Left		AR5610 (KBD22/23/26/27/28)	AR5603 (1.6, 2.0, KB29) AR5604 (1.8, KB23/26/27)	AR5610 (KBD41/42) (81-84) AR5604 (KB41/42/43) (81-89), (KB44) (87-89), (KBD42) (84-87) AR5621 (KBD42) (87-89)	AR5611 AR5619 (2.5, 2.8) (89-96) AR6384 (2.5, 2.8) (97-04)
Engine Mounting - Right		AR5609 (KBD22/23/26/27/28)	AR5603 (1.6, 2.0, KB29) AR5604 (1.8, KB23/26/27)	AR5609 (KBD41/42) (81-84) AR5603 (KB41/42/43) (81-89), (KB44) (87-89), (KBD42) (84-87) AR5622 (KBD42) (87-89)	AR5612 AR5618 (2.5, 2.8) (89-96) AR6385 (2.5, 2.8) (97-04)
Transmission Mounting		AR5608 (KBD22/23/26/27/28)	AR5608	AR5608 (KB41/42/43/44), (KBD41, KBD42) (84-87)	AR5613
FRONT SUSPENSION					
Upper Control Arm Bush - Inner		AR5348 - Front (KBD22/23/26/27/28)	AR5348 - Front	AR5348 - Front (KB41, KB42, KB43) (81-89), (KB44) (87-89), (KBD41, KBD42) (81-89)	AR5647 - Front (1.6, 2.0, 2.2, 2.5, 2.8) AR5348 - Front (2.3)
Upper Control Arm Bush - Outer		AR5348 - Rear (KBD22/23/26/27/28)	AR5348 - Rear	AR5348 - Front (KB41, KB42, KB43) (81-89), (KB44) (87-89), (KBD41, KBD42) (81-89)	AR5647 - Rear AR5348 - Rear (2.3)
Lower Control Arm Bush - Inner		AR5349 (KBD22/23/26/27/28)	AR5349	AR5636 (KB44) (87-89), (KBD41, KBD42) (81-89) AR5349 (KB41, KB42, KB43) (81-89), (KBD41, KBD42) (84-87)	AR7509
Lower Control Arm Bush - Outer					
Shock Rubber - Front		AR22 (ID: 10mm) AR33 (ID: 16mm)	AR22 (ID: 10mm) AR33 (ID: 16mm)	AR22 (ID: 10mm) AR33 (ID: 16mm)	AR22 (ID: 10mm) AR33 (ID: 16mm) AR7524 (2.8)
Stabilizer Bar Bush		AR5644 AR5630 (KBD20, KBD25)	AR5644	AR5630 (KB40, KBD40) (79-81) AR5644 (KB41/42/43) (81-89) AR5640 (KB44) (87-89), (KBD41, KBD42) (81-89)	AR5648 (1.6, 2.0, 2.2, 2.8) AR5645 (2.3, 2.5)
Stabilizer Link Grommet		AR22 AR5629 (KBD20, KBD25)	AR22 (not for KB29) AR5629 (KB29)	AR5629 AR22 KB41/42/43 (81-89)	AR22
Tension Rod Bush		AR5392	AR5392	AR5392	AR6170
REAR SUSPENSION					
Centre Bearing Rubber		AR5398 Rubber Only AR5398B Complete	AR5398 Rubber Only AR5398B Complete	AR5398 Rubber Only AR5398B Complete	AR5398 (89-98) Rubber Only AR5398B Complete (89-98) AR6252 Complete (98-04) AR6320 (KB200 D/C) (98-04) - Short Legs AR6331 (98-04) - Long Legs
Exhaust Hanger - Middle		AR5270 (2)	AR5270 (2)	AR5270 (2)	AR5270 (2)
Exhaust Hanger - Rear		AR5270 (1)	AR5270 (1)	AR5270 (1)	AR5270 (1)
Shackle Bush - Front		AR2060 (4) AR5633 (4) (KBD20, KBD25)	AR2060 (4)	AR2060 (4)	AR5370 (2)
Shackle Bush - Rear Upper		AR5065 (4)	AR5065 (4)	AR5065 (4)	AR5065 (4)
Shackle Bush - Rear Lower		AR5065 (4)	AR5065 (4)	AR5065 (4)	AR5065 (4)
Shock Rubber - Rear		AR33	AR33	AR33	AR33

APPLICATIONS	ISUZU 4X4 KB220 LWB D/cab, LE P/up Pet. - C22NE KB230 SWB P/up Pet. - 4ZD1 KB250D SWB/LWB, D/cab, LE, LE D/cab P/up Dies. - 4JA1 KB260 LWB D/cab, LE, LX D/cab P/up - 4ZE1 KB280DT SWB, LWB LE, LE D/cab, LX, LX D/cab P/up - 4JB1	ISUZU KB260 2.6 SWB/LWB LE, LX, D/cab P/up Pet. - 4ZE1 KB320 3.2 V6 SWB, LWB LE, LX, D/cab, Frontier, Reef, Blazer P/up Pet. - 6VD1	ISUZU 4X4 KB320 V6 SWB, LWB Frontier LX, LX, LX D/cab P/up Pet. - 6VD1	ISUZU D-MAX 4X2, 4X4 KB220 Fleetside P/up KB240i LE, D/C LE, Fleetside P/up KB250D, DC LE, D/C LE, Fleetside P/up, D-TEQ KB300 TDC TDi LX, D/C LX, Fleetside P/up, Hi-Rider	
	YEARS	89-04	92-04	98-04	04-13
Engine Configuration	INLINE	INLINE	INLINE	INLINE	INLINE
Engine Mounting - Front					
Engine Mounting - Rear					
Engine Mounting - Left	AR5623 (2.2) AR5611 (2.3, 2.6) AR5619 (2.5, 2.8) (92-96) AR6384 (2.8) (96-04)	AR5611 (260) AR7521 (320)	AR7521	AR1172L (KB250, KB300) AR8313 AR9556 (240i)	
Engine Mounting - Right	AR5612 (2.3, 2.6) AR5618 (2.8) (92-96) AR5623 (2.2) AR6385 (2.8) (96-04)	AR5612 (260) AR7522 (320)	AR7522	AR1172R (KB250, KB300) AR8312 AR9557 (240i)	
Engine Mounting - Other					
Transmission Mounting	N/A (2.2) AR5613 (2.3, 2.5, 2.6) AR5620 (2.8)	AR5613 (260) AR7523 (320)	AR7525	AR5608	
FRONT SUSPENSION					
Upper Control Arm Bush - Inner	AR5647 - Rear	AR5647 - Front	AR5647	AR8320	
Upper Control Arm Bush - Outer	AR5647 - Front	AR5647 - Rear	AR5647	AR8320	
Lower Control Arm Bush - Inner	AR5649 - Front (L85mm) (2.8) (92-96) AR7510 - Front (L56mm) (2.8) (96-04)	AR7509 (260) AR7510 - Front (320)	AR7510 - Front	AR8321	
Lower Control Arm Bush - Outer	AR7511 - Rear	AR7511 - Rear (320)	AR7511 - Rear	AR8321	
Shock Rubber - Front	AR22 (ID: 10mm) AR33 (ID: 16mm) - Alt.	AR22 (ID: 10mm) AR33 (ID: 16mm) - Alt. AR7524 (320)			
Stabilizer Bar Bush	AR5648 (2.2, 2.3, 2.6, 2.8) (92-96) AR5645 (2.5) AR7519 (2.8) (96-04)	AR5648 (260) AR7519 (320)	AR7519		
Stabilizer Link Grommet	AR22 (2.5)				
Strut Mounting				AR1255 (KB250, KB300)	
Tension Rod Bush	AR6170	AR6170	AR6170		
Miscellaneous					
REAR SUSPENSION					
Centre Bearing Rubber	AR5398 Rubber Only (-98) AR5398B Complete (-98) AR6252 Complete (98-04) AR6320 (KB220) (98-), (KB250D, KB280DT) (98-04) - Short Legs AR6331 (98-04) - Long Legs	AR5398 Rubber Only (92-98) AR5398B Complete (92-98) AR6252 Complete (98-04) AR6320 (KB320) (98-04) - Short Legs AR6331 (98-04) - Long Legs	AR6252	AR6320 (KB300) AR9755 (KB250, KB300)	
Exhaust Hanger - Middle	AR5270 (2) (KB220/230/250D/260)	AR5270 (260) (2)			
Exhaust Hanger - Rear	AR5270 (1) (KB220/230/250D/260)	AR5270 (260) (1)			
Lower Control Arm Bush - Inner					
Lower Control Arm Bush - Outer					
Shackle Bush - Front	AR5370 (2)	AR5370 (2)	AR5370 (2)	AR8425	
Shackle Bush - Rear Upper	AR5065 (4)	AR5065 (4)	AR5065 (4)	AR5065	
Shackle Bush - Rear Lower	AR5065 (4)	AR5065 (4)	AR5065 (4)	AR5065	
Shock Rubber - Rear	AR33 (KB220, KB230) (KB250D, KB260)	AR33			
Stabilizer Bar Bush					
Stabilizer Link Grommet					
Miscellaneous					

APPLICATIONS	ISUZU D-TEQ 4X4	ISUZU RELAY	JINBEI HAISE
		KB240i LE, D/C LE, Fleetside P/up KB250D LE, D/C LE, Fleetside P/up KB300TDi LX, D/C LX, Fleetside, "GO Big" P/up Hi-Rider	1.8 LWB Bus, P/van Pet. - 4ZB1 2.0 SWB Bus, P/van Pet. - 4ZC1 WFR 11/12 FVX
YEARS	04-12	83-95	2007-
Engine Configuration	INLINE	INLINE	INLINE
Engine Mounting - Front			
Engine Mounting - Rear			
Engine Mounting - Left	AR8313	AR5627	AR5337
Engine Mounting - Right	AR8312	AR5626	AR5337
Engine Mounting - Other			
Transmission Mounting	AR5608 (2 Bolt Holes, 2 Studs) AR9909 (4 Bolt Holes, 2 Studs)	AR5608 (83-86) AR5628 (86-95)	AR5363
FRONT SUSPENSION			FRONT SUSPENSION
Upper Control Arm Bush - Inner	AR8320 AR8310 (Not for Hi-Rider)		
Upper Control Arm Bush - Outer	AR8320 AR8310 (Not for Hi-Rider)		
Lower Control Arm Bush - Inner	AR8321 AR8385 (Not for Hi-Rider)		
Lower Control Arm Bush - Outer	AR8321 AR8385 - Alt.		
Shock Rubber - Front			
Stabilizer Bar Bush		AR5654	
Stabilizer Link Grommet		AR5092	
Steering Coupling			
Steering Rack Mounting			
Strut Mounting			
Miscellaneous			
REAR SUSPENSION			REAR SUSPENSION
Centre Bearing Rubber		AR5398 Rubber Only AR5398B Complete	
Exhaust Hanger - Middle		AR5270 (2)	
Exhaust Hanger - Rear		AR5270 (1)	
Lower Control Arm Bush - Inner			
Lower Control Arm Bush - Outer			
Propshaft Coupling			
Shackle Bush - Front	AR8425	AR2060 (4)	
Shackle Bush - Rear Upper	AR5065	AR5655 (4)	
Shackle Bush - Rear Lower	AR5065	AR5655 (4)	
Stabilizer Bar Bush			
Strut Mounting			
Miscellaneous			

JINBEI

APPLICATIONS	JEEP	JEEP CHEROKEE 4X4 KJ	JEEP CHEROKEE 4X4 KK	JEEP COMPASS 4X4	JEEP GRAND CHEROKEE 4X4
		2.4 - EDI 2.5 CRD - R425 2.8 CRD - ENR 3.7 CRD - EKG	2.8 CRD - ENS 3.7 CRD - EKG	2.0 CRD - ECD, ECE 2.0 - ECN 2.4 CRD - ED3, ER2	WG, WJ 2.7 CRD - ENF 4.7 V8 - EVA, EVC
YEARS		02-08	2008-	07-18	02-05
Engine Configuration		INLINE	INLINE	TRANSVERSE	INLINE
Engine Mounting - Front				AR9427	
Engine Mounting - Rear				AR9428	
Engine Mounting - Left				AR9429	AR9490
Engine Mounting - Right				AR9430	AR9491
Engine Mounting - Other					
Transmission Mounting					AR9492
FRONT SUSPENSION					
Exhaust Hanger - Front					
Upper Control Arm Bush - Inner		AR9478 - Front & Rear	AR9483 - Front & Rear		
Upper Control Arm Bush - Outer					
Lower Control Arm Bush - Inner		AR9479 - Front & Rear	AR9484 - Front AR9485 - Rear	AR8765 - Front	
Lower Control Arm Bush - Outer		AR9480 - Centre	AR9486 - Centre	AR8763 - Rear	
Shock Rubber - Front					
Stabilizer Bar Bush		AR9475 (ID: 30mm)	AR9487 (ID: 31mm)	AR9434 (2.0 CRD, 2.4 CRD)	AR9493 (ID: 28mm)
Stabilizer Link Grommet		AR9476 Stabilizer Link	AR9482 Stabilizer Link		AR9494 Stabilizer Link
Steering Coupling					
Steering Rack Mounting					
Strut Mounting		AR9477L AR9477R		AR9433	AR9489
Miscellaneous					
REAR SUSPENSION					
Centre Bearing Rubber				AR9436	
Exhaust Hanger - Middle					
Exhaust Hanger - Rear					
Upper Control Arm Bush - Inner		AR8893 - Front & Rear			AR8893 - Front & Rear
Upper Control Arm Bush - Outer					
Propshaft Coupling					
Shackle Bush - Front					
Shackle Bush - Rear Upper					
Shackle Bush - Rear Lower					
Stabilizer Bar Bush		AR9481 (ID: 14mm)	AR9488 (ID: 20mm)	AR9435	AR9488 (ID: 20mm)
Strut Mounting					
Miscellaneous					AR9495 Stabilizer Link

APPLICATIONS	JEEP GRAND CHEROKEE 4X4 WH, WK 3.0 CRD - EXL 3.7 V6 - EKG 4.7 V8 - EVA 5.7 V8 - EZB	JEEP GRAND CHEROKEE 4X4 IV 3.6 V6 - ERB 5.7 V8 - EZH	JEEP PATRIOT 4X4 MK74 2.0 CRD - ECD, ECE 2.4 - ED3	JEEP WRANGLER 4X4 2.8 CRD - ENS 4.0 - SO1
	YEARS	05-13	2011-	2007-
Engine Configuration	INLINE	INLINE	TRANSVERSE	INLINE
Engine Mounting - Front			AR9427	
Engine Mounting - Rear			AR9428	
Engine Mounting - Left			AR9429	
Engine Mounting - Right			AR9430	
Engine Mounting - Other				
Transmission Mounting				
FRONT SUSPENSION				
Exhaust Hanger - Front				
Upper Control Arm Bush - Inner	AR9483 - Front & Rear	AR9498 - Front & Rear		
Upper Control Arm Bush - Outer				
Lower Control Arm Bush - Inner	AR9484 - Front AR9485 - Rear	AR8694 - Front	AR8765 - Front	
Lower Control Arm Bush - Outer	AR9486 - Centre	AR8888 - Rear LHS AR8889 - Rear RHS AR9501 - Centre	AR8763 - Rear	
Shock Rubber - Front				
Stabilizer Bar Bush	AR8848 (ID: 33mm)		AR9434	AR9502
Stabilizer Link Grommet				AR9504 Stabilizer Link
Steering Coupling				
Steering Rack Mounting				
Strut Mounting	AR9489		AR9433	
Tension Rod Bush				
Miscellaneous				
REAR SUSPENSION				
Centre Bearing Rubber			AR9436	
Exhaust Hanger - Middle				
Exhaust Hanger - Rear				
Upper Control Arm Bush - Inner	AR8893 - Front & Rear			
Upper Control Arm Bush - Outer				
Lower Control Arm Bush - Inner				
Lower Control Arm Bush - Outer				
Propshaft Coupling				
Shackle Bush - Front				
Shackle Bush - Rear Upper				
Shackle Bush - Rear Lower				
Stabilizer Bar Bush	AR9488 (ID: 20mm)		AR9435	AR9503
Stabilizer Link Grommet				AR9505 Stabilizer Link
Strut Mounting				
Miscellaneous				

APPLICATIONS	KIA	KIA CARENS	KIA CARNIVAL	KIA CERATO - LD	KIA CERATO - TD
		2.0 CVVT - G4KA 2.0 CRDi - D4EA	2.5 V6 LS MPV - KRVT 2.9 CRDi MPV - J3	1.6 LX - G4FC 2.0 CRDi - D4EA	1.6 LX - G4FC 2.0 - G4KD
YEARS		03-09	00-04	04-09	09-13
Engine Configuration		TRANSVERSE	TRANSVERSE	TRANSVERSE	TRANSVERSE
Engine Mounting - Front		AR9128 (03-06) AR9132 (07-09)		AR9135 (1.6) AR9144 (2.0)	AR8874 (Man.) AR9658 (Auto.)
Engine Mounting - Rear		AR9129 (03-06)		AR9136 (1.6) AR9143 (2.0)	AR9655 (1.6 Man.) AR9659 (Auto.) AR9661 (2.0 Man.)
Engine Mounting - Left				AR9137 (1.6) AR9145 (2.0)	AR9656
Engine Mounting - Right		AR9130 (03-06) AR9133 (07-09)	AR6545	AR9138	AR8877
Engine Mounting - Other					
Transmission Mounting		AR9131 (03-06) AR9134 (07-09)			
		FRONT SUSPENSION			
Exhaust Hanger - Front					
Upper Control Arm Bush - Inner					
Upper Control Arm Bush - Outer					
Lower Control Arm Bush - Inner		AR8075 - Front (03-06) AR8666 - Front (07-09)		AR7791	AR8666
Lower Control Arm Bush - Outer		AR8077 - Rear LHS (03-06) AR8668 - Rear (07-09)		AR9141	AR8668
Shock Rubber - Front					
Stabilizer Bar Bush		AR8658		AR9142	AR9114
Steering Coupling					
Steering Rack Mounting					
Strut Mounting				AR9139	AR9100
Miscellaneous					
		REAR SUSPENSION			
Centre Bearing Rubber					
Exhaust Hanger - Middle					
Exhaust Hanger - Rear					
Lower Control Arm Bush - Inner					
Lower Control Arm Bush - Outer					
Propshaft Coupling					
Shackle Bush - Front					
Shackle Bush - Rear Upper					
Shackle Bush - Rear Lower					
Stabilizer Bar Bush		AR8669		AR8670	
Strut Mounting				AR9140	
Miscellaneous					

APPLICATIONS	KIA CERATO - YD 1.6 - G4FG 1.6T-GDi Koup - G4FJ 2.0 - G4NA	KIA K2700i 2.7i Workhorse D/S, P/up - J2	KIA OPTIMA 2.4 - G4KJ	KIA PICANTO 1.1 LX, EX Std. - G4HG
YEARS	13-18	2004-	12-14	04-11
Engine Configuration	TRANSVERSE	INLINE	TRANSVERSE	TRANSVERSE
Engine Mounting - Front			AR9538	AR9146
Engine Mounting - Rear	AR8866			
Engine Mounting - Left		AR8403	AR9539	AR9147
Engine Mounting - Right	AR9543	AR8403	AR9540	AR9148
Engine Mounting - Other				
Transmission Mounting	AR9542	AR8402		
FRONT SUSPENSION				
Upper Control Arm Bush - Inner		AR9812 - Front		
Upper Control Arm Bush - Outer		AR9813 - Rear		
Lower Control Arm Bush - Inner	AR9125		AR8816	AR7848
Lower Control Arm Bush - Outer	AR8817	AR8399	AR8817	AR8654
Shock Rubber - Front				
Stabilizer Bar Bush		AR8401	AR9122	AR8707
Stabilizer Link Grommet				
Steering Coupling				
Steering Rack Mounting				
Strut Mounting	AR9657		AR8834	AR8708
Tension Rod Bush				
Miscellaneous				
REAR SUSPENSION				
Centre Bearing Rubber				
Exhaust Hanger - Middle				
Exhaust Hanger - Rear				
Lower Control Arm Bush - Inner				
Lower Control Arm Bush - Outer				
Propshaft Coupling				
Shackle Bush - Front				
Shackle Bush - Rear Upper				
Shackle Bush - Rear Lower				
Stabilizer Bar Bush			AR9123	
Stabilizer Link Grommet				
Strut Mounting				
Miscellaneous				

APPLICATIONS	KIA PICANTO 1.0 - G3LA 1.2 - G4LA	KIA RIO I 1.3, RS - A3E 1.5, RS - A5D	KIA RIO II 1.4 - A5D 1.6 Sport - G4ED	KIA RIO III 1.2 - G4LA 1.4 - G4FA
	YEARS	2011-	00-05	05-11
Engine Configuration	TRANSVERSE	TRANSVERSE	TRANSVERSE	TRANSVERSE
Engine Mounting - Front	AR9544 (1.0)		AR9101 Insert Only AR9756 Complete	AR8866
Engine Mounting - Rear			AR9102 Insert Only AR9757 Complete	
Engine Mounting - Left	AR9545 (1.0 Man.) AR9548 (1.2)	AR8039	AR9103	AR9552 (1.2) AR9555 (1.4 Man.)
Engine Mounting - Right	AR9546 (1.0 Man.) AR9550 (1.2)	AR8039	AR9104	AR9553 (1.2, 1.4 Man.)
Engine Mounting - Other				
Transmission Mounting				
FRONT SUSPENSION				
Exhaust Hanger - Front		AR5139		
Upper Control Arm Bush - Inner				
Upper Control Arm Bush - Outer				
Lower Control Arm Bush - Inner	AR8869	AR6027	AR7848	AR8869
Lower Control Arm Bush - Outer	AR8870		AR7860	AR8870
Shock Rubber - Front				
Stabilizer Bar Bush	AR8707		AR8647	AR8647
Stabilizer Link Grommet				
Steering Coupling				
Steering Rack Mounting		AR8068 - LHS AR8069 - RHS		
Strut Mounting	AR8708	AR6056 - L/RHS to 06/02 AR6039 - RHS from 07/02 AR6047 - LHS from 07/02	AR9100	AR8708
Tension Rod Bush				
Miscellaneous				
REAR SUSPENSION				
Centre Bearing Rubber				
Exhaust Hanger - Middle		AR5139		
Exhaust Hanger - Rear		AR5139		
Lower Control Arm Bush - Inner				
Lower Control Arm Bush - Outer				
Propshaft Coupling				
Shackle Bush - Front				
Shackle Bush - Rear Upper				
Shackle Bush - Rear Lower				
Stabilizer Bar Bush				AR9109
Stabilizer Link Grommet				
Strut Mounting				
Miscellaneous		AR6075 Rear Lateral Link AR8067 Rear Axle Beam Bush		

APPLICATIONS	KIA SEDONA 2.5 2.9 CRDi - J3	KIA SEDONA 2.2 CRDi - D4HB 3.8 - KV6	KIA SEPHIA 1.5 LS, RS - BFD SHUMA 1.5i LS - BFD 1.8i GS - TBD SHUMA II 1.6i 1.8i GS - T8 SPECTRA 1.6 Exec., LS - A6	KIA SORENTO 4X2, 4X4 2.5 CRDi SUV - D4CB 3.5 V6 - D4HB 3.8 V6	
	YEARS	04-06	07-13	98-04	02-09
Engine Configuration	TRANSVERSE	TRANSVERSE	TRANSVERSE	TRANSVERSE	INLINE
Engine Mounting - Front	AR9149 (2.5) AR9157 (2.9)				
Engine Mounting - Rear	AR9150 (2.5) AR9158 (2.9)				
Engine Mounting - Left					AR9165 (2.5) AR8088 (3.5, 3.8)
Engine Mounting - Right	AR9151 (2.5) AR9159 (2.9)			AR5577 AR8066 Spectra	AR9165 (2.5) AR8088 (3.5, 3.8)
Engine Mounting - Other					
Transmission Mounting	AR9152 (2.5) AR9160 (2.9)			AR8072	AR9166 (2.5 Man.) AR9167 (2.5 Auto.) AR8089 (3.5, 3.8)
FRONT SUSPENSION					
Exhaust Hanger - Front			AR5139		
Upper Control Arm Bush - Inner					AR8096 AR8097 - Alt.
Upper Control Arm Bush - Outer					AR8096 AR8097 - Alt.
Lower Control Arm Bush - Inner	AR9154	AR8668 - Front	AR8077 - LHS		AR8671 AR8099 - Alt.1 AR8098 - Alt.2
Lower Control Arm Bush - Outer		AR9162 - Rear	AR8075		AR8099 AR8098 - Alt.
Shock Rubber - Front					
Stabilizer Bar Bush	AR9155	AR9163			AR8094 (ID: 27mm) AR8095 - Alt. (ID: 25mm)
Stabilizer Link Grommet					AR8093
Steering Coupling					
Steering Rack Mounting				AR8078 - LHS AR8079 - RHS	
Strut Mounting	AR9153	AR9035			AR8091
Tension Rod Bush					
Miscellaneous					AR8090 Front Subframe Bush
REAR SUSPENSION					
Centre Bearing Rubber					
Exhaust Hanger - Middle					
Exhaust Hanger - Rear					
Lower Control Arm Bush - Inner					
Lower Control Arm Bush - Outer					
Propshaft Coupling					
Shackle Bush - Front					
Shackle Bush - Rear Upper					
Shackle Bush - Rear Lower					
Stabilizer Bar Bush	AR9156	AR9164			AR8107 (ID: 25mm)
Stabilizer Link Grommet					
Strut Mounting					
Miscellaneous					AR8100 Rear Upper Link Bush AR8101 Front Lower Link Bush AR8103 Rear Lower Link Bush

APPLICATIONS	KIA SORENTO 4X2, 4X4 2.2 CRDi - D4HB 3.5 - G6DC	KIA SOUL 1.6 - G4FC 1.6 CRDi - D4FB	KIA SPORTAGE 4X4 2.0 SWB SUV, Wagon Pet. - FE	KIA SPORTAGE 4X2, 4X4 2.0 SWB SUV - G4GC 2.0 CRDi SUV - D4EA 2.7 V6 SUV - G6BA
YEARS	2009-	2009-	98-04	05-10
Engine Configuration	TRANSVERSE	TRANSVERSE	INLINE	TRANSVERSE
Engine Mounting - Front	AR9110			AR9003 (2.0) AR9014 (2.0 CRDi) AR9011 (2.7)
Engine Mounting - Rear	AR9111	AR9169 (09-11) AR9174 (2011-)		AR9006 (2.0) AR9015 (2.0 CRDi) AR9013 (2.7)
Engine Mounting - Left	AR9112	AR9171 (09-11) AR9175 (2011-)	AR5535	
Engine Mounting - Right	AR9113	AR8868 (09-11) AR9176 (2011-)	AR5535	AR9004 (2.0, 2.7) AR9008 (2.0 CRDi)
Engine Mounting - Other				
Transmission Mounting			AR8109	AR9005 (2.0) AR9009 (2.0 CRDi) AR9012 (2.7)
FRONT SUSPENSION				
Upper Control Arm Bush - Inner			AR8111 - Front	
Upper Control Arm Bush - Outer			AR8111 - Rear	
Lower Control Arm Bush - Inner	AR8663 - Front	AR8869	AR8112 - Front	AR8666
Lower Control Arm Bush - Outer	AR8664 - Rear	AR8870	AR8112 - Rear	AR7860
Shock Rubber - Front				
Stabilizer Bar Bush	AR8665	AR9172	AR8110	AR8672
Stabilizer Link Grommet				
Steering Coupling				
Steering Rack Mounting				
Strut Mounting	AR9168	AR9173	AR8113	
Tension Rod Bush				
Miscellaneous				
REAR SUSPENSION				
Centre Bearing Rubber	AR8894			AR8913
Exhaust Hanger - Middle				
Exhaust Hanger - Rear				
Lower Control Arm Bush - Inner				
Lower Control Arm Bush - Outer				
Propshaft Coupling				AR8914
Shackle Bush - Front				
Shackle Bush - Rear Upper				
Shackle Bush - Rear Lower				
Stabilizer Bar Bush	AR9108			
Stabilizer Link Grommet				
Strut Mounting				
Miscellaneous			AR8115 Rear Lateral Link Bush AR8116 Upper Trailing Link Bush AR8117 Lower Trailing Link Bush	

APPLICATIONS	KIA SPORTAGE 4X2, 4X4 2.0 - G4KD, G4NA, G4NC 2.0 CRDi - D4HA 2.4 - G4KE			
	YEARS	2010-		
Engine Configuration	TRANSVERSE			
Engine Mounting - Front	AR9643			
Engine Mounting - Rear				
Engine Mounting - Left	AR9644			
Engine Mounting - Right	AR9645			
Engine Mounting - Other				
Transmission Mounting				
FRONT SUSPENSION				
Upper Control Arm Bush - Inner				
Upper Control Arm Bush - Outer				
Lower Control Arm Bush - Inner	AR8816			
Lower Control Arm Bush - Outer	AR8817			
Shock Rubber - Front				
Stabilizer Bar Bush	AR9106			
Stabilizer Link Grommet				
Steering Coupling				
Steering Rack Mounting				
Strut Mounting	AR8818			
Tension Rod Bush				
Miscellaneous				
REAR SUSPENSION				
Centre Bearing Rubber	AR8894			
Exhaust Hanger - Middle				
Exhaust Hanger - Rear				
Lower Control Arm Bush - Inner				
Lower Control Arm Bush - Outer				
Propshaft Coupling				
Shackle Bush - Front				
Shackle Bush - Rear Upper				
Shackle Bush - Rear Lower				
Stabilizer Bar Bush	AR8821			
Stabilizer Link Grommet				
Strut Mounting	AR8820			
Miscellaneous	AR1098L AR1098R Trailing Arm Bush - L/RHS			

APPLICATIONS	LAND ROVER	LAND ROVER 88-SERIES II, II A/B, III	LAND ROVER DISCOVERY I	LAND ROVER DISCOVERY III	LAND ROVER FREELANDER I - L314
		2.25 SWB P/up Pet., Dies. 2.6 LWB P/up 6-Cyl. SE Pet. - OHI 109 2.25 SWB, LWB P/up Pet., Dies. 2.6 LWB P/up 6-Cyl. SE Pet. - OHI 110 2.6 LWB P/up 6-Cyl. - R6 3.5 V8 LWB "PUP" P/up Pet. - ADE236	2.2 TD 3.5 3.9	2.5 TD V6 2.7 TD V6 4.0 V6 4.4 V8	4X4 1.8 - 18K4F 2.0 TD4 - M47 2.0TD - 20T2N 2.5 - 25K4F
YEARS		58-96	89-04	05-09	98-06
Engine Configuration		INLINE	INLINE	INLINE	INLINE
Engine Mounting - Front					
Engine Mounting - Rear					AR1271 (1.8, 2.0TD) Lower Torque Rod AR1276 (2.0, 2.5) Lower Torque Rod
Engine Mounting - Left		AR2003 AR1440 - Alt			AR1268 (1.8) AR1272 (2.0TD) AR1273 (2.0, 2.5)
Engine Mounting - Right		AR2003 AR1440 - Alt			AR1269 (1.8, 2.0TD) AR1270 (1.8, 2.0TD) Upper Torque Rod AR1274 (2.0) AR1275 (2.0, 2.5) Upper Torque Rod AR1277 (2.5)
Engine Mounting - Other					
Transmission Mounting		AR2003 AR1440 - Alt			
FRONT SUSPENSION					
Upper Control Arm Bush - Inner					
Upper Control Arm Bush - Outer					
Lower Control Arm Bush - Inner			AR8828 - Front	AR8828 - Front (05-08)	AR6461
Lower Control Arm Bush - Outer					AR6460
Shock Rubber - Front					
Stabilizer Bar Bush					AR6462
Steering Coupling					
Steering Rack Mounting					
Strut Mounting					AR6463
Miscellaneous					
REAR SUSPENSION					
Centre Bearing Rubber					
Exhaust Hanger - Middle		AR5125 (82-96)			
Exhaust Hanger - Rear			AR5125	AR5125	
Lower Control Arm Bush - Inner					
Lower Control Arm Bush - Outer					
Propshaft Coupling					
Shackle Bush - Front		AR5371 (4)			
Shackle Bush - Rear Upper		AR5371 (4)			
Shackle Bush - Rear Lower		AR5371 (4)			
Stabilizer Bar Bush					
Strut Mounting					AR6468
Miscellaneous					AR6464 Trailing Link Bush AR6466 Lower Link Bush - Inner AR6467 Lower Link Bush - Outer

APPLICATIONS	LAND ROVER FREELANDER II - L359 4X4 2.0 Pet. - 204PT 2.2D - 224DT 3.2 Pet. - B6324S	MAHINDRA	MAHINDRA BOLERO 4X2, 4X4 MAXI TRUCK 2.5D 2.5TD - XD3, NEF	MAHINDRA SCORPIO 4X2, 4X4 2.0 2.2 CRED 2.5, GLX 2.6, GLX 2.6TD GLX	MAHINDRA SCORPIO MHAWK 4X2, 4X4 2.2D S4 S/cab, S6 D/cab, P/up- VKH4
	YEARS		07-14	2005-	2003-
Engine Configuration	INLINE		INLINE	INLINE	INLINE
Engine Mounting - Front					
Engine Mounting - Rear			AR9727		
Engine Mounting - Left			AR9728		
Engine Mounting - Right	AR1256 (2.0) AR1257 Upper Torque Rod AR1259 (2.2D Man.) AR1260 (2.2D Auto.) AR1262 (3.2)		AR9728		
Engine Mounting - Other					
Transmission Mounting	AR1258 (2.0) AR1261 (2.2D, 3.2)				
FRONT SUSPENSION			FRONT SUSPENSION		
Upper Control Arm Bush - Inner			AR8788	AR8793	
Upper Control Arm Bush - Outer					
Lower Control Arm Bush - Inner	AR1266 - Front		AR8789		
Lower Control Arm Bush - Outer	AR1267L - Rear LHS AR1267R - Rear RHS			AR8795	
Shock Rubber - Front					
Stabilizer Bar Bush	AR1264		AR8791	AR8796	
Stabilizer Link Grommet			AR8792	AR8792	
Steering Coupling					
Steering Rack Mounting					
Strut Mounting	AR1263				
Miscellaneous			AR8790 Strut Bar Bush		
REAR SUSPENSION			REAR SUSPENSION		
Centre Bearing Rubber				AR1099	AR1100
Exhaust Hanger - Middle			AR9729		
Exhaust Hanger - Rear					
Lower Control Arm Bush - Inner					
Lower Control Arm Bush - Outer					
Propshaft Coupling					
Shackle Bush - Front					
Shackle Bush - Rear Upper					
Shackle Bush - Rear Lower					
Stabilizer Bar Bush	AR1265				
Strut Mounting					
Miscellaneous					

APPLICATIONS	MAZDA	MAZDA 121 SOHO 1.3, i Hatch - Endura - EM5 1.4, i Hatch - CVH/PTE	MAZDA 2 - DE 1.3 - ZJ-VE 1.5 - ZY-DE, VE	MAZDA 2 - DL 1.3 - ZJ-VE 1.5 - ZY-DE, VE	MAZDA 3 - BK / BL 1.6 Original, Active, Dynamic - B6ZE, Z6 2.0 Dynamic, Individual, - LF17 2.3 Individual MPS - L3KG 2.5 - L5-VE
		97-99	07-15	2015-	04-14
Engine Configuration		TRANSVERSE	TRANSVERSE	TRANSVERSE	TRANSVERSE
Engine Mounting - Front		AR6480 - RHS AR6489 - RHS (Alt.)			
Engine Mounting - Rear		AR6487	AR9177 (Man.) AR9794 (Auto.)	AR9820 Diesel AR9821 Petrol	AR8616 Engine Side AR8187 Body Side AR9520 - Alt.
Engine Mounting - Left			AR9178 (Man.) AR9795 (Auto.)		AR9963 (1.6)
Engine Mounting - Right			AR9179	AR9824 (Man.) AR9825 (Man.) Petrol - Alt. AR9826 (Auto.) Diesel AR9827 (Auto.) Petrol AR9828 (Auto.) Petrol - Alt.	AR8185 (1.6) 3-Hole AR9863 3-Hole - Alt. AR8826 (2.0, 2.3) 2-Hole AR9802 (2.3, 2.5) 2-Hole
Engine Mounting - Other					
Transmission Mounting		AR6476		AR9831 (Man.) AR9832 (Auto.) Diesel AR9833 (Auto.) Petrol	AR8186
FRONT SUSPENSION					
Exhaust Hanger - Front					
Upper Control Arm Bush - Inner					
Upper Control Arm Bush - Outer					
Lower Control Arm Bush - Inner		AR7411 - Front	AR7012 - Front (2007-) AR8751 - Front (2009-)	AR9834	AR8243 - Front
Lower Control Arm Bush - Outer		AR6496 - Rear	AR7013 - Rear (2007-) AR9047 - Rear (2009-)	AR9835	AR8244 - Rear AR9464L - Rear LHS (Alt.) AR9464R - Rear RHS (Alt.) (Bigger Bracket)
Shock Rubber - Front					
Stabilizer Bar Bush		AR6497	AR8750	AR9836 Petrol (ID: 18mm) AR9837 Diesel (ID: 19mm)	AR8221 (ID: 14/16mm) AR8615 (ID: 18mm)
Steering Coupling					
Steering Rack Mounting					
Strut Mounting		AR6498 (Excl. Bearing) AR6498C (Incl. Bearing)	AR8753	AR8753	AR8193
Miscellaneous					
REAR SUSPENSION					
Centre Bearing Rubber					
Exhaust Hanger - Middle		AR6499			AR5069 AR5139 - Alt.
Exhaust Hanger - Rear		AR6499			
Lower Control Arm Bush - Inner					
Lower Control Arm Bush - Outer					
Propshaft Coupling					
Shackle Bush - Front					
Shackle Bush - Rear Upper					
Shackle Bush - Rear Lower					
Stabilizer Bar Bush					AR8221
Strut Mounting			AR9049	AR9049	
Miscellaneous		AR6523 Rear Axle Carrier Bush	AR9965 Rear Axle Carrier Bush		AR8245 Rear Subframe Bush

APPLICATIONS	MAZDA 3 - BM / BN 1.6 - Z6Y1 2.0 - PEX2, PEY7	MAZDA 323 FWD 1.3 S, L H/back, Sedan - E3 130 Hatch, Midge, Sting, Sedan - E/B3 1.5 GLC, L, SL, SLX, Sport Sedan, Hatchback - E5	MAZDA 323 FWD 130 Hatch, Sedan - B3 MIDGE / STING 160 i, s, Hatch, Sedan - F6 1.6 EGi, S, SL Hatch, Sedan, Sport - B6 160, i, iS, Hatch, Midge, Sting, Sedan - F6 2.0 EGi Hatch, SLE Hatch, SLi, Sedan 200e, i Sedan, Hatch DOHC 8/16 Valve - FE-2000	MAZDA 5 - CR19 2.0 Original, Active, Dynamic, Individual - LFF7
	YEARS	2014-	81-95	85-05
Engine Configuration	TRANSVERSE	TRANSVERSE	TRANSVERSE	TRANSVERSE
Engine Mounting - Front		AR5503	AR5499 Carb - 4 Studs AR5503 Fuel Injection - 2 Studs AR5499W (2.0)	
Engine Mounting - Rear	AR9190			AR8187 AR9520 - Alt.
Engine Mounting - Left	AR9191 AR1286 - Alt.			
Engine Mounting - Right	AR9192 AR9863 - Alt.	AR5500	AR5500	AR8185 3-Hole AR8826 2-Hole
Engine Mounting - Other				
Transmission Mounting		AR5192 (1.3, 1.5 Auto.) AR5498 (1.5 Man.), (1.3, 130, 1.5) (83-95)	AR5498	AR8186
FRONT SUSPENSION				
Exhaust Hanger - Front		AR5139 (2) (1.3, 130, 1.5) (84-91) AR5149 (91-95) (2)	AR5139 (85-91) (2) AR5149 (2) (Midge / Sting) (91-03)	
Upper Control Arm Bush - Inner				
Upper Control Arm Bush - Outer				
Lower Control Arm Bush - Inner	AR9188 - Front	AR5502 - Front	AR5502 - Front	AR8243 - Front
Lower Control Arm Bush - Outer	AR9189L AR9189R AR9189I Insert Only	AR5375 - Rear	AR5375 - Rear	AR8244 - Rear
Stabilizer Bar Bush	AR9837	AR5504 (ID: 27mm) (1.3, 130, 1.5) (83-95) AR5504A (ID: 18mm)	AR5504	AR8221 (ID: 14/16mm) AR8615 (ID: 18mm)
Stabilizer Link Grommet		AR5081	AR5081	
Steering Rack Mounting			AR6530 - RHS (Thick) AR6531 - LHS (Thin)	
Strut Mounting	AR9864	AR6532 - Front (1.3, 130, 1.5) (84-91) AR6210 - Front (1.3, 130, 1.5) (91-95) AR6533 - Rear	AR6532 - Front (85-91) AR6210 - Front (Midge / Sting) (91-03) AR6533 (Midge) (95-05)	AR8195L AR8195R
Miscellaneous		AR6538 Accelerator Pedal Rubber AR6539 Brake & Clutch Pedal Rubber	AR6538 Accelerator Pedal Rubber AR6539 Brake & Clutch Pedal Rubber	
REAR SUSPENSION				
Exhaust Hanger - Middle		AR5069 AR5139 - Alt. AR5061 (1.3, 130, 1.5) (83-95)	AR5061 (130) (85-91) AR5149 (160) (91-95)	
Exhaust Hanger - Rear		AR5069 AR5139 - Alt. (3)	AR5139 (130) (85-91) (3) AR5149 (160) (91-95) (3)	
Shackle Bush - Front				
Shackle Bush - Rear Upper				
Shackle Bush - Rear Lower				
Stabilizer Bar Bush	AR9882	AR5505	AR5505 (85-95)	
Stabilizer Link Grommet		AR5081	AR5081	
Strut Mounting		AR6533	AR6533	
Miscellaneous		AR6144 Trail Link Arm AR6145A Rear Lateral Link - Adjustable AR6148A Rear Lateral Link - Adjustable AR6158 (1.3, 130, 1.5) (83-95) Front Lateral Link - RHS AR6159 (1.3, 130, 1.5) (83-95) Front Lateral Link - LHS	AR6144 Trail Link Arm AR6145A Rear Lateral Link - Adjustable AR6148A Rear Lateral Link - Adjustable AR6158 (1.3, 130, 1.5) (83-95) Front Lateral Link - RHS AR6159 (1.3, 130, 1.5) (83-95) Front Lateral Link - LHS	AR8245 Rear Subframe Bush AR8246 - Alt. Rear Lateral Link Bush

APPLICATIONS	MAZDA 5 - CW 2.0 - LFZB	MAZDA 6 - GG 2.0 Active, Original, Elegant - LFF7 2.3 Dynamic, Individual, Sporty, Sporty Lux - L3C1	MAZDA 6 - GH 2.0 - LF17 2.5 - L5-VE	MAZDA 6 - GJ / GL 2.0 - PEY5 2.2D - SHY1 2.5 - PYY1, PYZA, PYY8
YEARS	10-14	03-09	08-14	2014-
Engine Configuration	TRANSVERSE	TRANSVERSE	TRANSVERSE	TRANSVERSE
Engine Mounting - Front				
Engine Mounting - Rear	AR8187 AR9520 - Alt.	AR8012	AR9180	AR9190
Engine Mounting - Left		AR7999	AR9181	AR9191
Engine Mounting - Right	AR8185 3-Hole AR8826 2-Hole	AR7998	AR9182	AR9192
Engine Mounting - Other				
Transmission Mounting	AR8186			
FRONT SUSPENSION				
Exhaust Hanger - Front				
Upper Control Arm Bush - Inner		AR8420 - Front	AR9185	
Upper Control Arm Bush - Outer		AR8420 - Rear	AR9185	
Lower Control Arm Bush - Inner	AR8243 - Front	AR8055 - Front	AR9183 - Front	AR9188 - Front
Lower Control Arm Bush - Outer	AR8244 - Rear	AR8056 - Rear AR8419 - Rear	AR9184L - Rear AR9184R - Rear	AR9189L - Rear AR9189R - Rear AR9189I Insert Only
Shock Rubber - Front				
Stabilizer Bar Bush	AR8615 (ID: 18mm)	AR8051	AR9186	AR9837
Stabilizer Link Grommet				
Steering Coupling				
Steering Rack Mounting				
Strut Mounting	AR8195L AR8195R			AR9864
Tension Rod Bush				
Miscellaneous		AR8053 Front Subframe Bush - LHS AR8054 Front Subframe Bush - RHS		
REAR SUSPENSION				
Centre Bearing Rubber				
Exhaust Hanger - Middle				
Exhaust Hanger - Rear				
Lower Control Arm Bush - Inner				
Lower Control Arm Bush - Outer				
Propshaft Coupling				
Shackle Bush - Front				
Shackle Bush - Rear Upper				
Shackle Bush - Rear Lower				
Stabilizer Bar Bush	AR8221	AR8052	AR9187	AR9890
Stabilizer Link Grommet				
Strut Mounting				
Miscellaneous	AR8245 Rear Subframe Bush	AR8057 Rear Lateral Link Adjustable - L/RHS		

APPLICATIONS	MAZDA 626	MAZDA 626	MAZDA 626	MAZDA ASTINA
	1.6 L Hatch, Sedan, S Sedan, SL Hatch Man. - F6 1.8 L Hatch, Sedan Man. - F8	2.0 SL Hatch, EGi, Sedan, SLi 16 Valve, SLE, 12 Valve, SLX Sedan, Hatch - FE	2.0i 4-Cyl. 16V Medium, High - FS 2.0i V6 24V High - KF 2.0i S/W, Sedan - FS2B/-D 2.5i V6 Exec. - KL MX6 2.5 V6 - KL	180Se Sedan, Hatch - BPI ETUDE 160, e, i, ie, Ise, Sport 16V - B6i 180e, iSe, Se, Sedan - BPI
YEARS	83-93	83-93	93-03	95-00
Engine Configuration	TRANSVERSE	TRANSVERSE	TRANSVERSE	TRANSVERSE
Engine Mounting - Front	AR5659 (1.8)	AR5659 (2.0SL) AR5221 (2.0 EGI)		
Engine Mounting - Rear	AR5661 AR5624 (1.8 Auto.)	AR5661 AR5624 (2.0 SL / EGI Auto.)	AR6541 (2.0i Man. S/W 4-Cyl.) AR6542 (2.0 Auto. 4-Cyl.) AR6553 (2.0, 2.5 Auto. V6) AR6554 (2.0, 2.5 Man. V6)	AR6213
Engine Mounting - Left	AR5656 (1.6) (97mm)	AR5662 (2.0EGi) (106mm)	AR6543 (Man.) AR6544 (Auto.)	AR6580 (1.6) AR6214 (1.8)
Engine Mounting - Right	AR5660 (1.8)	AR5660 (2.0SL)	AR6545	AR6578
Engine Mounting - Other		AR6391 (2.0 SL, 2.0EGi) - Front Support	AR6548 Damper (All 4-Cyl.)	
Transmission Mounting	AR5657	AR5657	AR6550	AR6212 (Man.) AR6215 (Auto.)
FRONT SUSPENSION				
Lower Control Arm Bush - Inner	AR5663 - Front	AR5663 - Front	AR6558 - Front	AR6582 - Front
Lower Control Arm Bush - Outer	AR6552 - Rear		AR6614L - Rear LHS (2.0i S/W) AR6615R - Rear RHS (2.0i S/W) AR6556 - Rear RHS AR6557 - Rear LHS	AR6583 - Rear RHS AR6584 - Rear LHS
Stabilizer Bar Bush	AR5665	AR5665		AR6586
Stabilizer Link Grommet	AR5081	AR5081		AR6587
Steering Coupling			AR6566 (Not for S/W)	
Steering Rack Mounting				AR6588 - LHS
Strut Mounting	AR6570 AR6571 (1.8)	AR6570 AR6571 (2.0 Auto.)	AR6209 AR6590 (2.0i S/W)	AR6590
Miscellaneous	AR5139 (1.8) Exhaust Hanger - Front	AR5139 (2.0SL) Exhaust Hanger - Front	AR6546 (Man.) X-Member Mounting AR6547 (Auto.) X-Member Mounting	
REAR SUSPENSION				
Exhaust Hanger - Middle	AR5061 AR5149 - Alt.	AR5061 AR5149 - Alt.		AR5149
Exhaust Hanger - Rear	AR5061 AR5139 - Alt.	AR5061 AR5139 - Alt.	AR5149 (2.0i S/W)	
Stabilizer Bar Bush	AR5505	AR5505	AR6560	
Stabilizer Link Grommet	AR5081	AR5081		
Strut Mounting			AR6574 - LHS (4-Cyl.) AR6575 - RHS (4-Cyl.)	
Miscellaneous	AR5951 (86-89) Front Lateral Link - RHS AR5952 (86-89) Front Lateral Link - LHS AR6115 (86-89) Rear Lateral Link - L/RHS AR6162 (1.6) (89-92) Rear Lateral Link - L/RHS AR6165 (1.6) (89-92) Trailing Link - L/RHS	AR5951 (86-89) Front Lateral Link - RHS AR5952 (86-89) Front Lateral Link - LHS AR6115 (86-89) Rear Lateral Link L/RHS AR6156 (86-89) Rear Lateral Link - L/RHS	AR6561 Rear Lateral Link - L/RHS AR6562 Rear Lateral Link - RHS AR6563 Rear Lateral Link - LHS AR6564 Front Lateral Link - RHS AR6565 Front Lateral Link - LHS AR6575 - RHS (4-Cyl.) AR6596 (2.0i S/W) Front Lateral Link - L/RHS AR6598 (2.0i S/W) Rear Lateral Link - L/RHS AR6600 (2.0i S/W) Trailing Link - RHS AR6601 (2.0i S/W) Trailing Link - LHS	AR6595 (06/95) Front Lateral Link - L/RHS AR6596 (07/95-00) Front Lateral Link - L/RHS AR6597 (06/95) Rear Lateral Link - L/RHS AR6598 (07/95-00) Rear Lateral Link - L/RHS AR6599 Trailing Link Normal Wheels - L/RHS AR6600 Trailing Link - RHS for Alloy Wheels AR6601 Trailing Link - LHS for Alloy Wheels

APPLICATIONS	MAZDA B-SERIES B1600 SWB Magnum P/up Pet. - F6 B1800 S/LWB Magnum, Drifter P/up Pet. - F8 B2000 LWB Magnum, Drifter P/up Pet. - FE B2200 SWB, LWB D/cab, Magnum, Drifter P/up Pet. - F2, Dies. - R2 B2500D, TD LWB Drifter, SLX P/up Dies. - WL4	MAZDA B-SERIES B2600 LWB D/cab, Magnum, Drifter, P/up Pet. - 4G54 B2600i LWB D/cab, Drifter SLX P/up Pet.	MAZDA B-SERIES B3000 V6 LWB D/cab, Magnum, Drifter P/up Essex Pet. B3400 V6 LWB D/cab, Magnum P/up Pet.	MAZDA B-SERIES 4X4 B2600 V6 LWB D/cab Magnum, Drifter P/up Pet. - 4G54
YEARS	82-00	86-02	86-99	86-95
Engine Configuration	INLINE	INLINE	INLINE	INLINE
Engine Mounting - Front				
Engine Mounting - Rear				
Engine Mounting - Left	AR5535	AR2015 (2.6) AR5535 (2.6i)	AR2015	AR6618
Engine Mounting - Right	AR5535	AR2015 (2.6) AR5535 (2.6i)	AR2015	AR6618
Engine Mounting - Other				
Transmission Mounting	AR1417 (1.6, 1.8, 2.0, 2.2) AR6622 (2.5 Man.) AR8726 (2.5 Auto.)	AR5172 (2.6) AR6622 (2.6i Man.) AR8726 (2.6i Auto.)	AR5172 (3.0)	AR6619
FRONT SUSPENSION				
Exhaust Hanger - Front				
Upper Control Arm Bush - Inner		AR6450 (2.6i)		
Upper Control Arm Bush - Outer				
Lower Control Arm Bush - Inner	AR5541 (1.6, 1.8) (86-92) AR6059 (2.0, 2.2, 2.5)	AR5546 (2.6i) AR6059 (2.6)	AR6059	AR6059
Lower Control Arm Bush - Outer		AR5540 (2.6i)	AR5540	AR5540
Shock Rubber - Front	AR22	AR5574 (2.6i)	AR22	AR22
Stabilizer Bar Bush	AR6060	AR5551 (2.6i) AR6060 (2.6)	AR6060	AR6060
Stabilizer Link Grommet	AR5092	AR5092 (2.6)	AR5092	AR5092
Steering Coupling				
Steering Rack Mounting				
Strut Mounting				
Tension Rod Bush	AR6055	AR5575 (2.6i) AR6055 (2.6)	AR6055	AR6055
Miscellaneous	AR5418 Brake & Clutch Pedal Rubber	AR5418 (2.6) Brake & Clutch Pedal Rubber AR5423 (2.6i) Brake & Clutch Pedal Rubber	AR5418 Brake & Clutch Pedal Rubber	AR5418 Brake & Clutch Pedal Rubber
REAR SUSPENSION				
Centre Bearing Rubber	AR5537 (1.6, 2.0, 2.2) AR5538 (1.6, 1.8, 2.0, 2.2) AR6184 (2.5)	AR5544 (2.6) AR6184 (2.6i)	AR5538 (3.0) AR6184 (3.4)	AR5544
Exhaust Hanger - Middle	AR5139	AR5139 (2.6)	AR5139	AR5139
Exhaust Hanger - Rear	AR5139	AR5139 (2.6)	AR5139	AR5139
Lower Control Arm Bush - Inner				
Lower Control Arm Bush - Outer				
Propshaft Coupling				
Shackle Bush - Front		AR5359 (4)	AR5359 (4)	AR5359 (4)
Shackle Bush - Rear Upper		AR5394 (4)	AR5394 (4)	AR5394 (4)
Shackle Bush - Rear Lower		AR5543 (4)	AR5543 (4)	AR5543 (4)
Shock Rubber - Rear		AR39	AR39	AR39
Stabilizer Bar Bush				
Stabilizer Link Grommet				
Strut Mounting				
Miscellaneous				

APPLICATIONS	MAZDA B-SERIES 4X4 B3000 V6 LWB D/cab, Magnum, Drifter P/up Essex Pet. B3400 V6 LWB D/cab Magnum P/up Pet.	MAZDA B-SERIES 4X4 B2500D , Td LWB, D/Cab, Magnum, Drifter SLX P/up Dies. - WL4 B2600i V6 LWB Drifter, D/cab Drifter, SLX P/up Pet.	MAZDA BT-50 4X2, 4X4 2.5 TDi SLX D/cab P/up 2.6 SLE D/cab, S/cab P/up 3.0 CRDi D/cab, SLE S/cab CRDi SLX P/up - WLE7	MAZDA BT-50 4X2, 4X4 2.2 - MZ-CD, P4-AT 2.5 - MZI L5-Y3 3.2 - MZ-CD, P5-Y3
YEARS	86-99	96-07	07-12	2012-
Engine Configuration	INLINE	INLINE	INLINE	INLINE
Engine Mounting - Front				
Engine Mounting - Rear				
Engine Mounting - Left	AR2015	AR5535	AR5535 (2.5 TDi, 2.6i) AR8383 (3.0 CRDi)	AR9208 (All Man. Models) AR9089 (All Auto. Models)
Engine Mounting - Right	AR2015	AR5535	AR5535 (2.5 TDi, 2.6i) AR8383 (3.0 CRDi)	AR9209 (All Man. Models) AR9090 (All Auto. Models)
Engine Mounting - Other				
Transmission Mounting	AR5172 (3.0) AR6619 (3.4)	AR8727 (Auto.) AR8728 (Man.)	AR6622 (Man. 4x2) AR8726 (Auto. 4x4)	AR9080 (4x2) (2.2 Man., 3.2 Man.) AR9094 (4x2) (2.2 Auto., 2.5 Man., 3.2 Auto.) AR9210 (4x4) (2.2, 3.2)
FRONT SUSPENSION				
Exhaust Hanger - Front				
Upper Control Arm Bush - Inner			AR8367	AR9062
Upper Control Arm Bush - Outer			AR8367	AR9062
Lower Control Arm Bush - Inner	AR6059 - Front	AR6059 - Front	AR8366	AR9063 - Front
Lower Control Arm Bush - Outer	AR5540 - Rear	AR5540 - Rear		AR9064 - Rear
Shock Rubber - Front			AR8368	
Stabilizer Bar Bush	AR6060	AR6060	AR8369	AR9675
Stabilizer Link Grommet	AR5092	AR5092	AR22	
Steering Coupling				
Steering Rack Mounting				
Strut Mounting				
Tension Rod Bush	AR6055	AR6055		
Miscellaneous	AR5418 Brake & Clutch Pedal Rubber	AR5418 (2.5D) Brake & Clutch Pedal Rubber AR5423 (2.6i) Brake & Clutch Pedal Rubber	AR9759 Stabilizer Pin Kit	
REAR SUSPENSION				
Centre Bearing Rubber	AR5544	AR5544	AR8429 (2.6) AR8430 (3.0)	
Exhaust Hanger - Middle	AR5139	AR5139		
Exhaust Hanger - Rear	AR5139	AR5139		
Lower Control Arm Bush - Inner				
Lower Control Arm Bush - Outer				
Propshaft Coupling				
Shackle Bush - Front	AR5359 (4)	AR5359 (4)		AR8780
Shackle Bush - Rear Upper	AR5394 (4)	AR5394 (4)	AR5394 (4)	AR8781
Shackle Bush - Rear Lower	AR5543 (4)	AR5543 (4)	AR5543 (4)	AR8782
Shock Rubber - Rear	AR39	AR39		
Stabilizer Bar Bush				
Stabilizer Link Grommet				
Strut Mounting				
Miscellaneous				

APPLICATIONS	MAZDA CX-3 2.0 - PEX3	MAZDA CX-5 - GH / KE 2.0 - PEY4	MAZDA CX-7 - ER 4X2, 4X4 2.3 - L3-VDT 2.5 - L5-VE	MAZDA DRIFTER 1.8 SWB, LWB XL P/up Pet. 2.2 SWB, LWB XL 2.5TD LWB Hi Ride, S/cab, SL Hi Ride, SLE, SLX, D/cab, LX Hi Ride P/up Dies. - WL4 2.6i LWB SL Hi Ride S/cab, SLE D/C, SLX, Hi Ride, SLX Hi Ride D/cab
YEARS	2015-	12-15	07-12	00-08
Engine Configuration	INLINE	INLINE	INLINE	INLINE
Engine Mounting - Front				
Engine Mounting - Rear	AR9821 (Man.) AR9820 (Auto.)	AR9190	AR9193	
Engine Mounting - Left	AR9902 (Man.) AR9904 (Auto.)	AR9191	AR9194	AR5535
Engine Mounting - Right	AR9903	AR9192	AR9195	AR5535
Engine Mounting - Other				
Transmission Mounting				AR1417 (-01) AR6622 From (01-05) (Man.) AR8726 From (01-05) (Auto.)
FRONT SUSPENSION				
Exhaust Hanger - Front				
Upper Control Arm Bush - Inner				AR6450 Rubber Bush for SK105 V-Arm Shaft
Upper Control Arm Bush - Outer				AR6450 Rubber Bush for SK105 V-Arm Shaft AR8367 (2.6i Some)
Lower Control Arm Bush - Inner	AR9834 - Front	AR9188 - Front	AR9196 - Front	AR5540 - Front Hi Rider
Lower Control Arm Bush - Outer	AR9835 - Rear	AR9189L - Rear AR9189R - Rear AR9189I Insert Only	AR9197L - Rear AR9197R - Rear AR9197I Insert Only	AR5546 - Rear Standard & Hi Rider
Shock Rubber - Front				AR5574
Stabilizer Bar Bush	AR9837	AR9837	AR9200	AR5551
Stabilizer Link Grommet				
Steering Coupling				
Steering Rack Mounting				
Strut Mounting	AR8753	AR8753		
Tension Rod Bush				
Miscellaneous				AR5423 Brake & Clutch Pedal Rubber
REAR SUSPENSION				
Centre Bearing Rubber			AR9198 - Front AR9199 - Rear	AR5538 (1.8, 2.6) AR5544 Hi Rider AR6184 (2.2, 2.5)
Exhaust Hanger - Middle				AR6318 AR5149 (1.8)
Exhaust Hanger - Rear				AR5149 (1.8)
Lower Control Arm Bush - Inner				
Lower Control Arm Bush - Outer				
Propshaft Coupling				
Shackle Bush - Front				AR5359 (4)
Shackle Bush - Rear Upper				AR5394 (4)
Shackle Bush - Rear Lower				AR5543 (4)
Shock Rubber - Rear				
Stabilizer Bar Bush			AR9201	
Stabilizer Link Grommet				
Strut Mounting				
Miscellaneous				

APPLICATIONS	MAZDA DRIFTER 4X4 2.5TD LWB S/cab, D/cab, SL S/cab, SLE, SLE D/cab, SLX S/cab, SLX, D/cab P/up Dies. - WL4 2.6i V6 LWB S/cab, SL S/cab, SLE, D/Cab, SLX D/cab P/up Pet.	MAZDA ETUDE 160i, iE, iSE, iSE Sport 180iSE, iSX, iSX Sport	MAZDA MARATHON 2.2 LWB Bus, P/van Pet. - F2	MAZDA RUSTLER 130 SWB Drifter, Explorer P/up Pet. - B3 160, i SWB Explorer, Drifter P/up Pet. - B6i, F6 1.3 SWB P/up Kent 2V Pet. 1.4 SWB P/up - CVH, FUA 1.6 LX - CVH, LUC
YEARS	00-08	99-04	91-04	86-02
Engine Configuration	INLINE	TRANSVERSE	INLINE	TRANSVERSE
Engine Mounting - Front				AR5499 (130, 160) (94-02) - Carb (4 Studs) AR5503 (130, 160) (94-02) - Fuel Injection (2 Studs) AR5499W (130, 160) (94-02) - Insert for AR5503 & AR5499 AR6161 (1.3, 1.4, 1.6) (86-93)
Engine Mounting - Rear		AR6551 (160) AR6689 (180)		AR6161 (1.3, 1.4, 1.6) (86-93)
Engine Mounting - Left	AR5535	AR6536	AR5535	
Engine Mounting - Right	AR5535	AR6540 (99-00) (160) AR6549 (00-04) (160) AR6688 (180)	AR5535	AR5500 - Rear (130, 160) (94-02) AR6179 (1.3, 1.4, 1.6) (86-93)
Transmission Mounting	AR8727 (Auto.) AR8728 (Man.)	AR6529	AR5798	AR5498 (130, 160) (94-02)
FRONT SUSPENSION				
Upper Control Arm Bush - Inner	AR6450			
Upper Control Arm Bush - Outer	AR6450			
Lower Control Arm Bush - Inner	AR5540 - Front	AR6603 - Front (99-02) AR6604 - Front (02-04)	AR5799	AR5168 (1.3, 1.4, 1.6) (86-93) AR5375 (130, 160) (94-02)
Lower Control Arm Bush - Outer	AR5546 - Rear	AR6607 - Rear	AR5799	AR5175 (1.3, 1.4, 1.6) (86-93) AR5502 (130, 160) (94-02)
Shock Rubber - Front	AR5574		AR22	
Stabilizer Bar Bush	AR5557	AR6608	AR5802	AR6193 (1.3, 1.4, 1.6) AR5504 (130, 160) (94-02)
Stabilizer Link Grommet			AR5081	AR5081 (130, 160) (94-02)
Steering Coupling			AR5810	SK500 (1.3, 1.4, 1.6)
Steering Rack Mounting		AR6610 AR6609 Rubber Stop	AR6530 - RHS (Thick) AR6531 - LHS (Thin)	AR6530 - RHS (Thick) AR6531 - LHS (Thin)
Strut Mounting		AR6611		AR6602 (1.3, 1.4, 1.6) AR6210 (130, 160) (94-02)
Tension Rod Bush			AR5801	
Miscellaneous	AR5423 Brake & Clutch Pedal Rubber		AR5407 Brake & Clutch Pedal Rubber AR5808 Accelerator Pedal Rubber	
REAR SUSPENSION				
Centre Bearing Rubber	AR5544			
Exhaust Hanger - Middle			AR5139	AR5125
Exhaust Hanger - Rear			AR5139	AR5125
Shackle Bush - Front	AR5359 (4)	AR5359 (4)	AR5543 (4)	AR5163 (4) (130, 160) (94-02)
Shackle Bush - Rear Upper	AR5394 (4)	AR5394 (4)	AR5543 (4)	AR5488 (4) (1.3, 1.4, 1.6) (86-93) AR5163 (4) (130, 160) (94-02)
Shackle Bush - Rear Lower	AR5543 (4)	AR5543 (4)	AR5543 (4)	AR5163 (1.3, 1.4, 1.6)
Shock Rubber - Rear	AR39	AR39	AR39	
Miscellaneous		AR6680 (99-00) Rear Lateral Link - L/RHS AR6681 (00-04) Rear Lateral Link - L/RHS AR6682 (99-10/00) Front Lateral Link - L/RHS AR6683 (12/00-04) Front Lateral Link - L/RHS AR6684 (99-10/00) Trailing Link - LHS AR6685 (99-10/00) Trailing Link - RHS AR6686 (11/00-04) Trailing Link - LHS AR6687 (11/00-04) Trailing Link - RHS		

APPLICATIONS

MERCEDES-BENZ

MERCEDES-BENZ BM903 / BM904 SPRINTER 308D SWB Bus, P/van Dies. - OM601 LA 312D LWB Bus, P/van Dies. - OM602 313CDi SWB/ LWB Bus, P/van Dies. - OM611 412D LWB P/van Dies. - OM602 LA 413 CDi SWB P/van Dies. - OM611 DELA	MERCEDES-BENZ BM906 SPRINTER 309 CDi Bus, P/van - OM646.985 311 CDi LWB Bus, P/van - OM646.985 315 CDi Bus, P/van - OM646.990 318 CDi Bus, P/van - OM642.992 509 CDi Bus, P/van - OM646.984 511 CDi Bus, P/van - OM646.985 515 CDi Bus, P/van - OM646.986 518 CDi Bus, P/van - OM646.992	MERCEDES-BENZ BM906 SPRINTER 309 CDi P/van, 16-Seater - OM646.984 315 CDi FC, 16-Seater - OM646.989, 990 318 CDi P/van - OM642.992, 993, 896 319 CDi DC, FC, PV, XC - OM642.992, 896, 898 518 CDi FC, DC, PV, 22-Seater - OM646.992, 993, 896 519 CDi - OM642.896, 898, 992	MERCEDES-BENZ R170 SLK200 2.0 Kompressor - M111.958 SLK230 2.3 Kompressor - M111.973, M111.978	
YEARS	96-06	2006-	2009-	99-04
Engine Configuration	INLINE	INLINE	INLINE	INLINE
Engine Mounting - Front				
Engine Mounting - Rear		AR8610 AR8611 - Alt.	AR8610 AR8611 - Alt.	
Engine Mounting - Left	AR5199 (308) AR5201 (312, 313, 412, 413)	AR8612	AR8612	AR6661
Engine Mounting - Right	AR5199 (308) AR5201 (312, 313, 412, 413)	AR8612	AR8612	AR6661
Transmission Mounting	AR5200			AR6666
FRONT SUSPENSION				
Upper Control Arm Bush - Inner				AR6744 - Front & Rear (-00)
Upper Control Arm Bush - Outer				
Lower Control Arm Bush - Inner	AR5220 - Front	AR8605 - Front	AR8605 - Front	AR6511 Repair Kit
Lower Control Arm Bush - Outer	AR5220 - Rear	AR8605 - Rear	AR8605 - Rear	
Stabilizer Bar Bush	AR5219	AR8608 (ID: 16.5mm) AR8609 (ID: 21mm)	AR8608 (ID: 16.5mm) AR8609 (ID: 21mm)	AR6645B Inner (ID: 24mm) AR6646 Outer (ID: 18mm)
Stabilizer Link Grommet	AR5213 Link Bushes (2 per Link)			
Strut Mounting	AR5208 - Upper AR5209 - Lower	AR8607	AR8607	
Miscellaneous				AR6690 Steering Arm Bush AR6092 Propshaft Centering Bush
REAR SUSPENSION				
Centre Bearing Rubber	AR5205		AR9312	AR6671
Lower Control Arm Bush - Inner				AR6652
Lower Control Arm Bush - Outer				AR6652
Propshaft Coupling				
Rear X-Member Bushes - Front				AR6698 (97-00) Kit AR6670 (00-04) Kit
Rear X-Member Bushes - Rear				AR5720 AR6673 Bush Kit
Shackle Bush - Front	AR5210 (12 x 32 x 80) AR5222 (16 x 38 x 80)			
Shackle Bush - Rear Upper	AR5211 (12 x 134) AR5222 (16 x 38 x 80)			
Shackle Bush - Rear Lower	AR5212 (12 x 50 x 80) AR5222 (16 x 38 x 80)			
Stabilizer Link Grommet	AR5214	AR5214	AR5214	AR6508 Stabilizer Link Assy
Miscellaneous			AR9535 Exhaust Hanger	AR6507 Rear Subframe Link Bush AR6616 Rear Axle Control Arm Strut - Centre AR6617 Rear Axle Upper Control Arm Camber Strut AR6654 Rear Axle Front Lower Thrust Arm AR6701 Rear Axle Lower Wheel Bearing Housing

APPLICATIONS	MERCEDES-BENZ W124 E-CLASS 200, E, E200 2.0 - M102.922 220E, E220 2.2 - M111.960 230E, E230 2.3 - M102.982	MERCEDES-BENZ W124 E-CLASS 260E 2.6 6-Cyl., - M103.940 280E 2.8 6-Cyl., - M104.942 300D 3.0 5-Cyl. 300E 3.0 6-Cyl. 320E, E320 3.2 6-Cyl., Sportline - M104.992	MERCEDES-BENZ W126 S-CLASS 280S, SE 2.8 6-Cyl. - M110.987/89 300SE 3.0 6-Cyl. - M103.981 380SE 3.8 V8 - M116.963 420SE 4.2 V8 - M116.965 500SE 5.0 V8 - M117.965	MERCEDES-BENZ W140 S-CLASS S320 3.2 6-Cyl. - M104.994 S420 4.2 V8 - M119.971 S500 5.0 8-Cyl. - M119.970
	YEARS	86-96	86-96	86-93
Engine Configuration	INLINE	INLINE	INLINE	INLINE
Engine Mounting - Front				
Engine Mounting - Rear				
Engine Mounting - Left	AR6635	AR6635	AR6692 (2.8, 3.8, 4.2, 5.0) AR6691 (3.0)	
Engine Mounting - Right	AR6635	AR6635	AR6692 (2.8, 3.8, 4.2, 5.0) AR6655 (3.0)	
Transmission Mounting	AR6640	AR6640	AR6620 (2.8, 3.8, 4.2, 5.0) AR6640 (3.0)	AR6666 from Chassis A328811
FRONT SUSPENSION				
Upper Control Arm Bush - Inner				
Upper Control Arm Bush - Outer			AR6631	
Lower Control Arm Bush - Inner	AR6695 Repair Kit (86-96)	AR6695 Repair Kit (86-96)	AR6516	
Lower Control Arm Bush - Outer				
Stabilizer Bar Bush	AR6512 - Inner (ID: 26.5mm) AR6645A - Inner (ID: 24mm) AR6645 (ID: 23mm) - Inner / Outer AR6646 - Outer (ID: 18mm)	AR6512 - Inner (ID: 26.5mm) AR6645B - Inner (ID: 24mm) AR6646 - Outer (ID: 18mm)		AR5144
Stabilizer Link Grommet				
Strut Mounting	AR6647	AR6647		
Miscellaneous	AR6092 Propshaft Centering Bush	AR6092 Propshaft Centering Bush	AR6092 Propshaft Centering Bush SK516 Radius Link Repair Kit	AR6092 Propshaft Centering Bush
REAR SUSPENSION				
Centre Bearing Rubber	AR6638 (ID: 25mm) (2.0, 2.2, 2.3)	AR6632 (30mm)	AR6513 (280, 300, 380) AR6632 (420, 500)	
Lower Control Arm Bush - Inner	AR6652	AR6652	AR6652	
Lower Control Arm Bush - Outer	AR6652	AR6652	AR6652	
Propshaft Coupling	AR6660 - Front AR6186 - Rear	AR6660 - Front (3.0) AR6186 - Rear (2.6, 3.0) AR8427 (2.8, 3.2)	AR6660 - Front AR6187 - Rear	
Rear Axle Bushes - Front	AR6697 Rear Axle Frame Diff. Mounting	AR6697 Rear Axle Frame Diff. Mounting		
Rear Axle Bushes - Rear	AR6696 Rear Axle Frame Diff. Mounting	AR6696 Rear Axle Frame Diff. Mounting		
Rear X-Member Bushes - Front	AR6670 (200, 220, 230) Rear Axle X-Member Kit	AR6670 (300D) Rear Axle X-Member Kit AR6698 (260, 280, 300E, 320) Rear Axle X-Member Kit		
Rear X-Member Bushes - Rear	AR6699 Rear Axle X-Member - Rear	AR6699 Rear Axle X-Member - Rear		
Stabilizer Bar Bush				
Stabilizer Link Grommet	AR6508 Stabilizer Link Assembly	AR6508 Stabilizer Link Assembly		
Miscellaneous	AR6507 Rear Subframe Link Bush AR6616 Rear Axle Control Arm Strut - Centre AR6617 Rear Axle Upper Control Arm Camber Strut AR6654 Rear Axle Front Lower Thrust Arm AR6701 Rear Axle Lower Wheel Bearing Housing	AR6507 Rear Subframe Link Bush AR6616 Rear Axle Control Arm Strut - Centre AR6617 Rear Axle Upper Control Arm Camber Strut AR6654 Rear Axle Front Lower Thrust Arm AR6701 Rear Axle Lower Wheel Bearing Housing	AR6514 Axle Subframe Bush Kit AR6516 Support Link Bush - Outer AR6517 Support Link Bush - Inner AR6654 Rear Axle Front Lower Thrust Arm	

APPLICATIONS	MERCEDES-BENZ W163 ML-CLASS ML230 SUV - M111.977 ML270 CDI SUV - OM612.963 ML320 SUV - M112.942 ML430 SUV - M113.942 ML500 SUV - M113.964 ML55 AMG SUV - M113.981	MERCEDES-BENZ W163 ML-CLASS ML320 CDI SUV - OM642.940 ML350 SUV - M272.967 ML500 SUV - M273.963 ML63 AMG SUV - M156.980	MERCEDES-BENZ W168 A-CLASS A160 1.6 Classic, Elegance - M166.940 A190 1.9 Elegance - M167.690	MERCEDES-BENZ W169 A-CLASS A170 1.7 Classic - M266.940 A180 2.0 CDI Classic - OM640.940 A200 2.0 Elegance - M266.960	
	YEARS	98-06	2006-	00-05	05-13
	Engine Configuration	INLINE	INLINE	TRANSVERSE	TRANSVERSE
	Engine Mounting - Front				AR8677 - L/RHS
	Engine Mounting - Rear	AR8693			AR8675 - LHS (Man.) AR8676 - LHS (Auto.) AR8678 - RHS
	Engine Mounting - Left	AR8692	AR8696	AR6694	
	Engine Mounting - Right	AR8691	AR8696	AR6694	
	Engine Mounting - Other				
	Transmission Mounting		AR8697	AR6693	
	FRONT SUSPENSION				
Upper Control Arm Bush - Inner		AR9498 - Front & Rear			
Upper Control Arm Bush - Outer					
Lower Control Arm Bush - Inner		AR8694 - Front	AR6707 - Front	AR8214 - Front	
Lower Control Arm Bush - Outer		AR9501 - Centre	AR6708 - Rear	AR8215 - Rear	
Shock Rubber - Front					
Stabilizer Bar Bush					
Stabilizer Link Grommet					
Steering Coupling					
Steering Rack Mounting					
Strut Mounting			AR6760	AR8674	
Tension Rod Bush					
Miscellaneous			AR6706 Gear Rod Mounting		
REAR SUSPENSION					
Centre Bearing Rubber					
Exhaust Hanger - Middle					
Exhaust Hanger - Rear					
Lower Control Arm Bush - Inner	AR8690 - Front	AR8695	AR6472 Rear Wishbone Repair Kit		
Lower Control Arm Bush - Outer			AR6752 Rear Wishbone Repair Kit		
Propshaft Coupling					
Rear X-Member Bushes - Front			AR6713 Body Mounting	AR8212	
Rear X-Member Bushes - Rear			AR6721 Body Mounting		
Rear X-Member Bushes - Front					
Rear X-Member Bushes - Rear					
Stabilizer Bar Bush				AR8673	
Stabilizer Link Grommet					
Strut Mounting					
Miscellaneous				AR8213 Rear Axle Link Bush - Inner & Outer AR8216 Rear Axle Upper Control Arm Bush - Front	

APPLICATIONS	MERCEDES-BENZ W176 A-CLASS A180 - M270.910 A180 CDi - OM607.951, OM651.901 A200 - M270.910 A220 CDi - OM651.930 A250 - M270.920	MERCEDES-BENZ W201 E-CLASS 190E 1.8 - M102.920 2.0 - M102.922 2.3 Sportline - M102.983	MERCEDES-BENZ W202 C-CLASS C180 1.8 Classic - M111.920/21 C200 2.0 Classic, Elegance - M111.941	MERCEDES-BENZ W202 C-CLASS C220 2.2 Classic, Elegance - M111.961 C230 2.3 Classic, Elegance, Kompressor, Sport - M111.974 C240 2.4 Classic, Elegance - M112.910 C250D, TD 2.5 5-Cyl., - M605.910 C280 2.8 6-Cyl. Elegance - M104.941
	YEARS	2013-	93-94	94-00
Engine Configuration	TRANSVERSE	INLINE	INLINE	INLINE
Engine Mounting - Rear	AR9508 - LHS AR9509 - RHS			
Engine Mounting - Left		AR6635	AR6661	AR6661
Engine Mounting - Right	AR9510	AR6635	AR6661	AR6661
Transmission Mounting	AR9506 (Man. & Auto.) AR9507 Dual Clutch	AR6640 (Man.) AR6656 (Auto.)	AR6640 (Man.) AR6656 (Auto.)	AR6665 (Man.) AR6666 (Auto.)
FRONT SUSPENSION				
Upper Control Arm Bush - Inner			AR6744 - Front & Rear	AR6744 - Front & Rear
Upper Control Arm Bush - Outer				
Lower Control Arm Bush - Inner	AR9511 - Front	AR6642 Repair Kit (1.8, 2.0) AR6695 Repair Kit (2.3)	AR6667 AR6511 - Front & Rear	AR6667 AR6511 - Front & Rear
Lower Control Arm Bush - Outer	AR9512L - Rear AR9512R - Rear			
Stabilizer Bar Bush		AR6645B - Inner (ID: 24mm)	AR6509 - Inner (ID: 23mm) AR6645B - Inner (ID: 24mm) AR6512 - Inner (Alt.) (ID: 26.5mm) AR6646 - Outer (ID: 18mm)	AR6509 - Inner (ID: 23mm) AR6645B - Inner (ID: 24mm) AR6512 - Inner (Alt.) (ID: 26.5mm) AR6646 - Outer (ID: 18mm)
Strut Mounting	AR9514 Without Sport Suspension AR9515 With Sport Suspension			
Miscellaneous		AR6092 Propshaft Centering Bush	AR6092 Propshaft Centering Bush AR6690 Steering Arm Bush	AR6092 Propshaft Centering Bush AR6690 Steering Arm Bush
REAR SUSPENSION				
Centre Bearing Rubber		AR6671	AR6358 AR6671 - Alt.	AR6358 AR6671 - Alt.
Lower Control Arm Bush - Inner		AR6652	AR6652	AR6652
Lower Control Arm Bush - Outer		AR6652	AR6652	AR6652
Propshaft Coupling		AR6660 - Front AR6186 - Rear	AR6079 - Front (C180 Man.) AR6080 - Front (C180 Auto.) to A348436, F267959 AR6081 - Front (C180 Auto.) from A348437, F267960 AR6674 - Rear (C180) AR6664 - Front (C200 Man.) to A348436, F267959 AR6186 - Rear (C200 Man.) from A348437, F267960 AR6082 - Front (C200 Auto.) AR8427 (Some)	AR6186 - Rear (C220, C250) AR6664 - Front (C220 Man.) AR6082 - Front (C220, C230 Auto.) AR6084 - Front (C250 Man.) AR8149 - Rear (C280) AR8427 (Some)
Rear X-Member Bushes - Front		AR5720 AR6670 Bush Kit - Rear Subframe to floor - Front	AR5720 AR6670 Bush Kit - Rear Subframe to floor - Front	AR5720 AR6670 Bush Kit - Rear Subframe to floor - Front
Rear X-Member Bushes - Rear		AR6673 Bush Kit - Rear Subframe to floor - Rear	AR6673 Bush Kit - Rear Subframe to floor - Rear	AR6673 Bush Kit - Rear Subframe to floor - Rear
Stabilizer Link Grommet		AR6508 Stabilizer Link Assembly		
Miscellaneous	AR9513 Trailing Arm Bush	AR6507 Rear Subframe Link Bush AR6616 Rear Axle Control Arm Strut - Centre AR6617 Rear Axle Upper Control Arm Camber Strut AR6654 Rear Axle Front Lower Thrust Arm AR6701 Rear Axle Lower Wheel Bearing Housing	AR6507 Rear Subframe Link Bush AR6616 Rear Axle Control Arm Strut - Centre AR6617 Rear Axle Upper Control Arm Camber Strut AR6654 Rear Axle Front Lower Thrust Arm AR6701 Rear Axle Lower Wheel Bearing Housing	AR6507 Rear Subframe Link Bush AR6616 Rear Axle Control Arm Strut - Centre AR6617 Rear Axle Upper Control Arm Camber Strut AR6654 Rear Axle Front Lower Thrust Arm AR6701 Rear Axle Lower Wheel Bearing Housing

APPLICATIONS	MERCEDES-BENZ W203 C-CLASS	MERCEDES-BENZ W203 C-CLASS	MERCEDES-BENZ W203 C-CLASS	MERCEDES-BENZ W204 C-CLASS
	C180 1.8 Classic - M111.920 C200 2.0 Classic, S/W - M271.940 C220 2.2 CDi Classic, S/W, Elegance - OM611.962, OM646.963 C230 2.3 Coupe	C240 2.6 V6 Elegance, S/W, Elegance S/W - M203.086 C270 2.7 CDi 5-Cyl. Elegance, S/W - OM612.962 C320 3.2 V6 Avantgarde Elegance, SW - M111.946	C180K - M271.946 C200K - M271.940 C220 CDi - OM611.962, OM646.963 C230K - M271.948 C240, C240T - M112.912 C320 CDi - OM642.910 C350 - M272.960	C180K - M271.910, M271.952 C200K - M271.950 C220 CDi - OM651.911 C300 - M272.947 C350 CDi - OM642.960 C350 - M272.961
YEARS	00-08	00-09	00-11	07-14
Engine Configuration	INLINE	INLINE	INLINE	INLINE
Engine Mounting - Front				
Engine Mounting - Rear				
Engine Mounting - Left	AR5196	AR5141 (C240, 320) AR5143 (C270)	AR5141 (C240) AR5143 (220 CDi, 320 CDi, 350) AR6661 (C180K, 200K, 230K)	AR8683
Engine Mounting - Right	AR6661	AR5141 (C240, 320) AR5142 (C270)	AR5141 (C240) AR5142 (220 CDi, 320 CDi, 350) AR6661 (C180K, 200K, 230K)	AR8683
Engine Mounting - Other				
Transmission Mounting	AR6666	AR6666 AR8300 - Alt.	AR6666 AR8300 - Alt.	AR8684 - Rear
FRONT SUSPENSION				
Upper Control Arm Bush - Inner	AR5820	AR5820	AR5820	AR5820
Upper Control Arm Bush - Outer				
Lower Control Arm Bush - Inner	AR5822	AR5822	AR5822	
Lower Control Arm Bush - Outer				AR8680 - Rear
Stabilizer Bar Bush	AR6677 (ID: 20.6mm) AR6422 (ID: 22mm)	AR6677 (ID: 20.6mm) AR6422 (ID: 22mm)	AR6677 (ID: 20.6mm) AR6422 (ID: 22)	
Stabilizer Link Grommet				
Steering Coupling				
Steering Rack Mounting	AR6348	AR6348	AR6348	
Strut Mounting	AR6359	AR6359	AR6359	AR8681
Miscellaneous				
REAR SUSPENSION				
Centre Bearing Rubber	AR9516	AR9516 AR9517 (C270 CDi)	AR9516 AR9517 AR9518 (C220 CDi, 320 CDi)	AR9521
Upper Control Arm Bush - Inner				
Upper Control Arm Bush - Outer				AR8216
Lower Control Arm Bush - Inner	AR6652	AR6652	AR6652	
Lower Control Arm Bush - Outer	AR6652	AR6652	AR6652	AR8679
Propshaft Coupling	AR8149	AR8149 AR8150 (C270 CDi)	AR8149 AR8150 (C220 CDi, 350) AR9519 (C320 CDi)	AR8149
Rear X-Member Bushes - Front	AR5720 AR6797 - Alt.	AR5720 AR6797 - Alt.	AR5720 AR6797 - Alt.	AR8299
Rear X-Member Bushes - Rear	AR6798	AR6798	AR6798	
Stabilizer Bar Bush				
Stabilizer Link Grommet				
Strut Mounting				AR8682
Miscellaneous	AR6507 Rear Subframe Link Bush AR6510 Rear Axle X-Member Bush AR6616 Rear Axle Control Arm Strut - Centre AR6617 Rear Axle Upper Control Arm Camber Strut AR6654 Rear Axle Front Lower Thrust Arm AR6701 Rear Axle Lower Wheel Bearing Housing	AR6507 Rear Subframe Link Bush AR6616 Rear Axle Control Arm Strut - Centre AR6617 Rear Axle Upper Control Arm Camber Strut AR6654 Rear Axle Front Lower Thrust Arm AR6701 Rear Axle Lower Wheel Bearing Housing	AR6507 Rear Subframe Link Bush AR6616 Rear Axle Control Arm Strut - Centre AR6617 Rear Axle Upper Control Arm Camber Strut AR6654 Rear Axle Front Lower Thrust Arm AR6701 Rear Axle Lower Wheel Bearing Housing	

APPLICATIONS	MERCEDES-BENZ W208 CLK-CLASS CLK230 2.3 Kompressor - M111.973/5 CLK320 3.2 V6 Cabrio - M112.940 W209 CLK320 3.2 V6 Elegance, Cabrio - M112.940	MERCEDES-BENZ W210 E-CLASS E200K 2.0 - M111.957 E230 2.3 - M111.970 E240 2.4 - M112.911 E280 2.8 V6 - M112.921 E320 3.2 V6 - M104.995, M112.941 E430 4.3 V8 - M113.940	MERCEDES-BENZ W211 E-CLASS E220 CDI 2.2 - OM646.961 E240 2.6 - M112.913 E280 3.0 - M272.943 E320 3.2 - M112.949	MERCEDES-BENZ W211 E-CLASS E200K - M271.941/956 E270 CDI - OM647.961 E320 - M112.949 E320 CDI - OM642.920 E350 - M272.964 E500 - M113.967
YEARS	98-05	96-02	02-10	02-10
Engine Configuration	INLINE	INLINE	INLINE	INLINE
Engine Mounting - Front				
Engine Mounting - Rear			AR9526 (E240, E320)	
Engine Mounting - Left	AR6661 (W208 CLK230)	AR6661 AR6703 (2.8, 3.2, 4.3)	AR6661 (E220 Only) AR6703 (E280)	AR5143 (E270) AR9526 (E320, E200K) AR9528 (E350)
Engine Mounting - Right	AR6661 (W208 CLK230)	AR6661 (2.0, 2.3, 2.4) AR6703 (2.8, 3.2, 4.3)	AR6661 (E240) AR6703 (E280)	AR5142 (E270) AR9526 (E320, E200K) AR9529 (E350)
Engine Mounting - Other				
Transmission Mounting	AR6666	AR6659 (Auto.) AR6666 (Man.)	AR6659 (Auto.) AR6666 (Man.)	AR6666 AR9530 (E350)
FRONT SUSPENSION				
Upper Control Arm Bush - Inner	AR6744 - Front & Rear	AR6744 - Front & Rear	AR8322 - Front & Rear	AR8322 - Front & Rear
Upper Control Arm Bush - Outer				
Lower Control Arm Bush - Inner		AR5147 Repair Kit	AR8323 - Front Inner AR8325 - Rear Outer	AR8323 - Front Inner
Lower Control Arm Bush - Outer	AR5820 (W209) AR6667 - Front & Rear (to A443812, F500865) AR6511 - Front & Rear Kit (from A443813, F500866)		AR8325	AR8325
Stabilizer Bar Bush	(W209 CLK320) AR6677 (ID: 20.6mm) AR6422 (ID: 22mm)	AR5144 (to A394035) AR5145 (from A394035)		AR9525
Stabilizer Link Grommet		AR6605 Stabilizer Link - RHS AR6606 Stabilizer Link - LHS		
Steering Rack Mounting	AR6348 (W209)			
Strut Mounting			AR8359	AR8359
Miscellaneous	AR6092 Propshaft Centering Bush AR6690 Steering Arm Bush	AR6092 Propshaft Centering Bush		
REAR SUSPENSION				
Centre Bearing Rubber		AR5198	AR9522	AR9522 AR9527 (E320 CDI)
Lower Control Arm Bush - Inner	AR6652	AR6652		
Lower Control Arm Bush - Outer	AR6652	AR6652		
Propshaft Coupling	AR8149	AR6664 - Front AR8427 (2.8, 3.2)	AR8150K (E220CDI)	AR8149 (E200K, E320) AR8150 (E270 CDI, E500) AR9519 (E320 CDI)
Rear X-Member Bushes - Front	AR5720 (W208) AR6670 Bush Kit - Rear Subframe to floor - Front	AR5616		
Rear X-Member Bushes - Rear	AR6673 Bush Kit - Rear Subframe to floor - Rear	AR5617 AR5720 - Alt.		
Stabilizer Bar Bush				AR8673 (ID: 27mm)
Stabilizer Link Grommet		AR6508 Stabilizer Link Assembly		
Miscellaneous	AR6507 Rear Subframe Link Bush AR6654 Rear Axle Front Lower Thrust Arm AR6701 Rear Axle Lower Wheel Bearing Housing - L/RHS	AR6507 Rear Subframe Link Bush AR6510 Rear Axle X-Member Bush AR6616 Strut Link Upper AR6617 Camber Strut AR6654 Thrust Control Arm AR6701 Rear Axle Lower Wheel Bearing Housing - L/RHS	AR9523 Front Subframe Bush AR9524 Rear Subframe Bush	

APPLICATIONS	MERCEDES-BENZ W212 E-CLASS E200 CGI - M271.820 E250 CDI - OM651.924 E300 - M272.952, E350 CDI - OM642.850 E500 - M273.971 (06-12)	MERCEDES-BENZ W212 E-CLASS E200 - M274.920 E250 - M274.920 E250, CGI - M271.860 E350 - M276.980 E400 - M276.820 E500 - M278.922	MERCEDES-BENZ W220 S-CLASS S320 3.2 CDI 6-Cyl. - M613.960 S500 5.0 V8 - M113.960 S600L 5.5 V12 - M137.960	MERCEDES-BENZ W245 B-CLASS B170 6-Spd. Man. - M266.940 B180 CVT - M266.940 B200 5-Spd. Man. - M266.960 B200 CDI 6-Spd. Man., CVT - OM640.941 B200 Turbo 6-Spd. Man., CVT - M266.980
YEARS	2009-	2011-	99-04	06-12
Engine Configuration	INLINE	INLINE	INLINE	TRANSVERSE
Engine Mounting - Front				AR8677 - L/RHS (B170, B180, B200) AR1210 - L/RHS (B200CDi) AR1211 - L/RHS (B200 Turbo Man.) AR1212 - L/RHS (B200 Turbo CVT)
Engine Mounting - Rear				AR8675 - LHS (Man.) (B170, B200) AR8676 - LHS (B180, B200 Turbo) AR8678 - RHS (B170, B180, B200/Turbo) AR1213 - RHS (B200CDi) AR1214 - LHS (B200CDi)
Engine Mounting - Left	AR8683	AR8683 (E250 CGI, E500) AR9532 (E350, E400) AR9533 (E200, E250)		
Engine Mounting - Right	AR8683	AR8683 (E250 CGI, E500) AR9532 (E350, E400) AR9533 (E200, E250)		
Engine Mounting - Other				
Transmission Mounting	AR8684	AR8684 (E250 CGI, E350, E400, E500) AR9534 (E200, E250)	AR6666 Chassis A328811 & A290167 on	
FRONT SUSPENSION				
Upper Control Arm Bush - Inner	AR8685 - Rear	AR8685 - Rear		
Upper Control Arm Bush - Outer				
Lower Control Arm Bush - Inner	AR9531 - Front	AR9531 - Front		AR8214 - Front
Lower Control Arm Bush - Outer				AR8215 - Rear
Stabilizer Bar Bush				
Stabilizer Link Grommet				
Strut Mounting	AR8687	AR8687		AR8674
Tension Rod Bush				
Miscellaneous			AR6092 Propshaft Centering Bush	
REAR SUSPENSION				
Centre Bearing Rubber		AR9521		
Upper Control Arm Bush - Inner				
Upper Control Arm Bush - Outer	AR8216			
Lower Control Arm Bush - Inner	AR8686		AR6652	
Lower Control Arm Bush - Outer			AR6652	
Propshaft Coupling		AR8150 (E250 CGI, E350)		
Rear X-Member Bushes - Front				AR8212
Rear X-Member Bushes - Rear				
Stabilizer Bar Bush				AR8673
Stabilizer Link Grommet			AR6508 Stabilizer Link Assembly	
Strut Mounting		AR8682		
Miscellaneous			AR6507 Rear Subframe Link Bush AR6654 Rear Axle Front Lower Thrust Arm AR6701 Rear Axle Lower Wheel Bearing Housing - L/RHS	AR8213 Rear Axle Link Bush - Inner & Outer AR8216 Rear Axle Upper Control Arm Bush - Front

APPLICATIONS	MERCEDES-BENZ W242, W246 B-CLASS B180 - M270.910 B180 CDi - OM651.901 B200 - M270.910 B200 CDi - OM651.901 B250 - M270.920	MERCEDES-BENZ W638 VITO 2.2 CDi LWB Crew Bus, Crew Cab P/van, High Roof P/van Dies. - OM611LA	MERCEDES-BENZ W639 VITO 113 CDi 115 CDi - OM646.980/982 116 CDi - OM651.940 120 CDi 122 CDi - OM642.890	
	YEARS	2012-	03-06	2004-
Engine Configuration	TRANSVERSE	INLINE	INLINE	
Engine Mounting - Front				
Engine Mounting - Rear	AR9508 - LHS AR9509 - RHS		AR8611	
Engine Mounting - Left			AR8689	
Engine Mounting - Right	AR9510	AR5250	AR8689	
Engine Mounting - Other				
Transmission Mounting	AR9506 (Man. & Auto.) AR9507 (Dual Clutch)	AR5241		
FRONT SUSPENSION				
Upper Control Arm Bush - Inner				
Upper Control Arm Bush - Outer				
Lower Control Arm Bush - Inner	AR9511 - Front	AR5242	AR5242	
Lower Control Arm Bush - Outer	AR9512L - Rear AR9512R - Rear		AR5242	
Shock Rubber - Front				
Stabilizer Bar Bush		AR5248	AR5248	
Stabilizer Link Grommet				
Steering Coupling				
Steering Rack Mounting				
Strut Mounting	AR9514	AR5237 - Upper AR5238 - Lower	AR8688	
Tension Rod Bush				
Miscellaneous				
REAR SUSPENSION				
Centre Bearing Rubber			AR9536 - Front AR9537 - Rear	
Exhaust Hanger - Middle				
Exhaust Hanger - Rear				
Lower Control Arm Bush - Inner				
Lower Control Arm Bush - Outer				
Propshaft Coupling			AR9519	
Rear X-Member Bushes - Front		AR5239		
Rear X-Member Bushes - Rear		AR5240		
Stabilizer Bar Bush			AR5248	
Stabilizer Link Grommet		AR5244 Stabilizer Link		
Strut Mounting				
Miscellaneous	AR9513 Trailing Arm Bush	AR5249 Trailing Arm Bush		

APPLICATIONS	MITSUBISHI	MITSUBISHI ASX 2.0 - 4B11	MITSUBISHI COLT LDV 1.6 SWB/ LWB Lo-Line K01/11 P/up Pet. - 4G32 2.0 SWB/ LWB D/cab Hi-Line, Lo-Line K12 P/up Pet. - 4G63 2.5D LWB Hi-Line, Lo-Line D/cab K14 P/up Dies. - 4D56 2.6 LWB Hi-Line K13 P/up - 4G54	MITSUBISHI COLT LDV 4X4 2.5D LWB Hi-Line K34 P/up Dies. - 4D56 2.6 LWB Lo-/Hi-Line K33 P/up Pet. - 4G54 3.0 V6 LWB Lo-Line D/cab, Hi-Line Rodeo K36 Pet. - 6G72	MITSUBISHI COLT LDV 2.0, i LWB Std., Hi-Line S/Cab, K62T P/up, Pet. - 4G63 2.4i LWB Hi-Line S/Cab, D/Cab, Hi Rider K65T, P/up Pet. 2.5D LWB Hi-Line, Std., S/cab, K64T P/up Dies. - 4D56
		YEARS	2011-	94-98	94-98
Engine Configuration		TRANSVERSE	INLINE	INLINE	INLINE
Engine Mounting - Front		AR9423			
Engine Mounting - Rear		AR9424		AR6714 (2.6) AR6715 (2.5, 3.0)	
Engine Mounting - Left			AR5696 (1.6) AR5694 (2.0) AR6711 (2.5) AR6710 (2.6)	AR6711 (2.5, 3.0) AR6712 (2.6)	AR5694 (2.0, 2.4) AR6709 (2.5)
Engine Mounting - Right		AR9430	AR5696 (1.6) AR5694 (2.0, 2.6) AR6709 (2.5)	AR6709	AR5694 (2.0, 2.4) AR6709 (2.5)
Engine Mounting - Other					
Transmission Mounting		AR9426	AR5695	AR6716 (2.6) Extension Housing Mounting AR6717 (2.5, 3.0) Extension Housing Mounting	AR5638 (2.0, 2.4) AR5731 (2.5)
FRONT SUSPENSION					
Upper Control Arm Bush - Inner			Complete with Arm	Complete with Arm	AR9664 - Front
Upper Control Arm Bush - Outer			Complete with Arm	Complete with Arm	AR9664 - Rear
Lower Control Arm Bush - Inner		AR8765 - Front	AR6718 - Front	AR6719 - Front	AR5625 Std. AR6719 - Front Hi Rider
Lower Control Arm Bush - Outer		AR8763 - Rear	AR6718 - Rear	AR6720 - Rear	AR5759 - Rear Hi Rider
Shock Rubber - Front			AR22	AR5092	AR22
Stabilizer Bar Bush		AR9559	AR6722	AR6723	
Steering Coupling			AR6724		
Steering Rack Mounting					
Strut Mounting		AR9558			
Miscellaneous					AR5599 Strut Bar Bush Kit
REAR SUSPENSION					
Centre Bearing Rubber			AR6198	AR6199	AR6198 Std. AR6199 (2.0, 2.4i, 2.5D)
Exhaust Hanger - Middle					
Exhaust Hanger - Rear					
Lower Control Arm Bush - Inner					
Lower Control Arm Bush - Outer					
Propshaft Coupling					
Shackle Bush - Front			AR5554 (4)	AR5554 (4)	AR5554 (4)
Shackle Bush - Rear Upper			AR5552 (4)	AR5552 (4)	AR5552 (4)
Shackle Bush - Rear Lower			AR5553 (4)	AR5553 (4)	AR5553 (4)
Stabilizer Bar Bush		AR9560			
Strut Mounting					
Miscellaneous					

APPLICATIONS	MITSUBISHI COLT LDV 2.8D, TD LWB Std. S/Cab, Hi-Line S/Cab Hi Rider, Hi-Line Raised Body, Pioneer D/Cab Hi Rider P/up Dies. - K67/77T 3.0i V6 LWB ClubCab K76T P/up Pet. - 6G72	MITSUBISHI COLT LDV 4X4 2.4i LWB S/cab, Hi-Line D/cab, Trailbuster S/cab, P/up Pet. - K65/75T 2.8D LWB S/cab, P/up Dies. - K77T 2.8TD LWB Rodeo D/cab, P/up Turbo Dies. - K77T 3.0i V6 LWB Rodeo D/cab, ClubCab - K76T, P/up Pet. - 6G72	MITSUBISHI COLT LDV 2.0 LWB P/up 2.0i LWB Hi-Line P/up	MITSUBISHI L300 1.6 SWB Mini Bus, Van Pet. - 4G32 1.8 SWB/ LWB D/S, P/U, P/up, P/van Pet. - 4G62 2.0 LWB P/up Pet. - 4G62 STARWAGON 2.0 LWB S, SL, SLE P/van Pet. - 4G62
	YEARS	01-09	98-09	04-09
Engine Configuration	INLINE	INLINE	INLINE	INLINE
Engine Mounting - Front				
Engine Mounting - Rear		AR5723 - RHS AR5724 - RHS (3.0)		
Engine Mounting - Left	AR5650 (2.8D) AR5721 (2.8 Pioneer) AR6709 (3.0i)	AR5694 (2.4) (-2004) AR5650 (2.8) (-2004) AR5722 (2.8) (-2004) AR6709 (3.0) (-2004) AR8338 (04-09)	AR8338	AR5194
Engine Mounting - Right	AR5650 (2.8D) AR5721 (2.8 Pioneer) AR6709 (3.0i)	AR5694 (2.4) AR5650 (2.8) AR5722 (2.8) AR6709 (3.0)	AR5722	AR5194
Engine Mounting - Other				
Transmission Mounting	AR5638 (2.8D Std., Hi Rider) AR5735 (3.0i) AR5733 (Pioneer)	AR5734 (2.4) (-2004) AR5747 (2.8) (-2004) AR5735 (2.8, 3.0 Man.) (-2004) AR5736 (3.0 Auto.) (-2004) AR8335 (04-09)	AR8335	
FRONT SUSPENSION				
Upper Control Arm Bush - Inner	AR9664 - Front	AR9664 - Front	AR9664 - Front	See SK104
Upper Control Arm Bush - Outer	AR9664 - Rear	AR9664 - Rear	AR9664 - Rear	See SK104
Lower Control Arm Bush - Inner	AR5625 (2.8D Standard) AR6719 - Front (3.0i)	AR6719 - Front	AR5625	AR6705 - Front
Lower Control Arm Bush - Outer	AR5759 - Rear Hi Rider (3.0i)	AR5759 - Rear	AR5759	AR6705 - Rear
Shock Rubber - Front	AR5757	AR5757		
Stabilizer Bar Bush	AR5760 - Outer (2.8D, 3.0i) AR5761 - Inner (2.8D) AR5762 (2.8D, 3.0i Pioneer, Rodeo)	AR5760 - Outer AR5761 - Inner (2.4i, 2.8D) AR5762 - Inner (2.8TD, 3.0i)	AR5761	AR5549 (ID: 20.5mm) AR5550 (ID: 22mm)
Stabilizer Link Grommet	AR5763 Stabilizer Link Kit	AR5763 Stabilizer Link Kit	AR5763 Stabilizer Link Kit	AR22
Steering Coupling				
Steering Rack Mounting				
Strut Mounting				
Tension Rod Bush				
Miscellaneous	AR5599 Strut Bar Bush Kit		AR5599 Strut Bar Bush Kit	
REAR SUSPENSION				
Centre Bearing Rubber	AR6198 (2.8D Standard) AR6199 (Rest)	AR6199	AR6198 AR6199 - Alt.	
Exhaust Hanger - Middle				
Exhaust Hanger - Rear				
Lower Control Arm Bush - Inner				
Lower Control Arm Bush - Outer				
Propshaft Coupling				
Shackle Bush - Front	AR5554 (4)	AR5554 (4)	AR5554 (4)	AR5554 (4)
Shackle Bush - Rear Upper	AR5552 (4)	AR5552 (4)	AR5552 (4)	AR5552 (4)
Shackle Bush - Rear Lower	AR5553 (4)	AR5553 (4)	AR5553 (4)	AR5553 (4)
Shock Rubber - Rear				AR33
Stabilizer Bar Bush				
Stabilizer Link Grommet				AR22
Strut Mounting				
Miscellaneous				

APPLICATIONS	MITSUBISHI LANCER 1.5 - 4A91 1.6 - 4G18	MITSUBISHI OUTLANDER 4X4 2.4 - 4B12	MITSUBISHI PAJERO 4X4 2.6 SWB, LWB GLS SJ25/26/45 SUV Pet. - 4G54	MITSUBISHI PAJERO 4X4 2.8TDi LWB GLS SUV V23C Dies. - 4M40 3.0 6-Cyl. SWB GLS Wagon V43W, V64W Pet. - 6G72
	YEARS	03-10	07-14	83-94
Engine Configuration	TRANSVERSE	TRANSVERSE	INLINE	INLINE
Engine Mounting - Front	AR9423	AR9423		
Engine Mounting - Rear	AR9424	AR9564		
Engine Mounting - Left			AR6709	AR5722 (2.8) AR6709 (3.0)
Engine Mounting - Right	AR9430	AR9430	AR6709	AR5765 (2.8) AR6709 (3.0)
Engine Mounting - Other				
Transmission Mounting	AR9426	AR9426	AR5766 AR5767 Transfer Case Support	AR5735 (2.8, 3.0)
FRONT SUSPENSION				
Upper Control Arm Bush - Inner			Complete with Arm	Complete with Arm
Upper Control Arm Bush - Outer			Complete with Arm	Complete with Arm
Lower Control Arm Bush - Inner	AR8765 - Front	AR8765 - Front	AR6719 - Front	AR6719 - Front
Lower Control Arm Bush - Outer	AR8763 - Rear	AR8763 - Rear	AR6720 - Rear	AR5759 - Rear
Shock Rubber - Front			AR5092	AR5757
Stabilizer Bar Bush	AR8764	AR9565	AR5158	AR7537
Stabilizer Link Grommet			AR5771 Stabilizer Link Kit LHS AR5772 Stabilizer Link Kit RHS	AR5763 Stabilizer Link Kit
Steering Coupling				
Steering Rack Mounting				
Strut Mounting	AR9561	AR9558		
Tension Rod Bush				
Miscellaneous				
REAR SUSPENSION				
Centre Bearing Rubber		AR9563	AR6198	AR6198
Exhaust Hanger - Middle				
Exhaust Hanger - Rear				
Lower Control Arm Bush - Inner				
Lower Control Arm Bush - Outer				
Propshaft Coupling				
Shackle Bush - Front				AR5554 (4)
Shackle Bush - Rear Upper			AR5552 (4)	AR5552 (4)
Shackle Bush - Rear Lower			AR5553 (4)	AR5553 (4)
Stabilizer Bar Bush	AR9562	AR9566	AR5768	
Stabilizer Link Grommet			AR5769 Stabilizer Link Bush Kit	
Strut Mounting				
Miscellaneous				

APPLICATIONS	MITSUBISHI PAJERO 4X4 3.5 V6 LWB GLS SUV V25/45W Pet. - 6G74	MITSUBISHI PAJERO 4X4 3.2 Di-D, Di-D GLS, GLX, TDi GLS SUV 3.8 X-Treme, GLS SUV DOCH - 6G75	MITSUBISHI PAJERO 4X4 2.5 Di-D - 4D56 3.2 Di-DC - 4M41 3.2 Di-D - 4M41	MITSUBISHI TRITON 4X2, 4X4 2.4 MPI D/cab P/up 2.5 Di-D Clubcab P/up 3.2 Di-D D/cab P/up 3.5 MPI Clubcab P/up
	YEARS	95-01	02-07	2009-
Engine Configuration	INLINE	INLINE	INLINE	INLINE
Engine Mounting - Front				
Engine Mounting - Rear		AR9568 - L/RHS		
Engine Mounting - Left	AR6709	AR9567 - Front	AR8339	AR8339
Engine Mounting - Right	AR6709	AR9567 - Front	AR8339	AR8339
Engine Mounting - Other				
Transmission Mounting			AR8341	AR8341
FRONT SUSPENSION				
Upper Control Arm Bush - Inner	Complete with Arm	AR8711		
Upper Control Arm Bush - Outer	Complete with Arm	AR8711		
Lower Control Arm Bush - Inner	AR6719 - Front	AR8709 - Front	AR8342	AR8342
Lower Control Arm Bush - Outer	AR5759 - Rear	AR8710 - Rear		
Shock Rubber - Front	AR5757			
Stabilizer Bar Bush	AR7537	AR9570	AR8340	AR8340
Stabilizer Link Grommet	AR5763 Stabilizer Link Kit	AR9569		
Steering Coupling				
Steering Rack Mounting			AR9573	
Strut Mounting			AR8343	AR8343
Tension Rod Bush				
Miscellaneous				
REAR SUSPENSION				
Centre Bearing Rubber	AR6198			AR8978
Exhaust Hanger - Middle				
Exhaust Hanger - Rear				
Lower Control Arm Bush - Inner				
Lower Control Arm Bush - Outer				
Propshaft Coupling				
Shackle Bush - Front	AR5554 (4)			AR8783
Shackle Bush - Rear Upper	AR5552 (4)			AR5552 (4)
Shackle Bush - Rear Lower	AR5553 (4)			AR5553 (4)
Stabilizer Bar Bush		AR9571	AR9572	
Stabilizer Link Grommet		AR8712 Stabilizer Link Assy.		
Strut Mounting				
Miscellaneous				

APPLICATIONS

NISSAN

NISSAN 1-TONNER HARDBODY AW/D22 1.6 SWB P/up Pet. - NA16S, L16SJ 1.8 SWB, LWB Custom, King Cab P/up Pet. - L18SR 2.0 SWB, LWB Custom P/up Pet. - NA20 2.4 LWB Custom, Hi Rider, Twincab, SE, SE D/cab Pet. - Z24	NISSAN 1-TONNER HARDBODY AW/D22 2.5D SWB, LWB Custom, D/cab, Hi Rider, Twin Cab P/up Dies. - TD25i 2.7D SWB, LWB Custom, D/cab, Hi Rider, Twincab, SE D/cab P/up Dies. - TD27i 3.0 V6 LWB SE D/cab, Hi Rider P/up Pet. - VG30E	NISSAN 1-TONNER HARDBODY AW/D22 4X4 2.4 LWB Custom, Patrol, Tracker P/up Pet. - Z24S 2.7D SWB, LWB Hi Rider, Twin Cab, SE, SE D/cab P/up Dies. - TD27i 3.0 V6 LWB D/cab, Twincab, Patrol P/up Pet. - VG30E	NISSAN 1400 1.4 SWB P/van, P/up - Pet. - A14S B140 1.4 SWB Deluxe, Sport, Std., CHAMP P/up Pet. - A14S	
YEARS	88-98	88-98	88-99	80-08
Engine Configuration	INLINE	INLINE	INLINE	INLINE
Engine Mounting - Front				
Engine Mounting - Rear				
Engine Mounting - Left	AR5864	AR6183 (2.5, 2.7) AR5866 (3.0)	AR5864 (2.4) AR6183 (2.7) AR5866 (3.0)	AR674
Engine Mounting - Right	AR5864	AR5864 (2.5, 2.7) AR5866 (3.0)	AR5864 (2.4, 2.7) AR5866 (3.0)	AR674
Engine Mounting - Other				
Transmission Mounting	AR5865	AR5865 (2.5, 2.7) AR5867 (3.0)	AR5867	AR5831 (80-93) AR5382 (93-04)
FRONT SUSPENSION				
Upper Control Arm Bush - Inner	AR5387 - Front	AR5387 - Front	AR5387	
Upper Control Arm Bush - Outer	AR5387 - Rear	AR5387 - Rear	AR5387	
Lower Control Arm Bush - Inner	AR5946	AR5946	AR5946	AR5399
Lower Control Arm Bush - Outer			AR5946	
Shock Rubber - Front	AR5092	AR5092	AR5092	AR22
Stabilizer Bar Bush	AR5940	AR5940	AR5940	AR5871
Stabilizer Link Grommet				AR5081 AR6440 Stabilizer Link Pin Kit
Steering Coupling				
Steering Rack Mounting				
Strut Mounting				AR6817
Tension Rod Bush	AR5947	AR5947	AR5947	AR5380
Miscellaneous				AR5315 Gear Shift Bush AR5316 Gear Shift Grommet AR5406 Brake & Clutch Pedal Rubber
REAR SUSPENSION				
Centre Bearing Rubber	AR5308 (OD: 111mm) AR5309 (OD: 120mm)	AR5308 (OD: 111mm) AR5309 (OD: 120mm)	AR5309 (2.4, 2.7) AR5299 (3.0)	
Exhaust Hanger - Middle	AR5938	AR5938	AR5938	AR5051
Exhaust Hanger - Rear		AR5937	AR5937	AR5051
Lower Control Arm Bush - Inner				
Lower Control Arm Bush - Outer				
Propshaft Coupling				
Shackle Bush - Front	AR5343 (2)	AR5343 (2)	AR5343 (2)	
Shackle Bush - Rear Upper	AR5379 (4)	AR5379 (4)	AR5379 (4)	AR2068 (4)
Shackle Bush - Rear Lower	AR5379 (4)	AR5379 (4)	AR5379 (4)	AR2067 (4)
Shock Rubber - Rear	AR5939	AR5939	AR5939	
Stabilizer Bar Bush				
Strut Mounting				
Miscellaneous				AR5873 (8) Shackle Bush - Front Upper AR5386 (4) Shackle Bush - Front Lower

APPLICATIONS	NISSAN 620	NISSAN ALMERA	NISSAN ALMERA	NISSAN DATSUN GO/+
	1.5 SWB, LWB P/up Pet. - J15 680 1.5 SWB P/up Pet. - J15 2.2 LWB P/up Dies. - SD22	1.6 Comfort, Elegance, Luxury - GA16DE 1.8 Elegance, Luxury - QG18DE	1.5 - HR15DE	1.2 - HR12DE
YEARS	73-80	01-06	2013-	2014-
Engine Configuration	INLINE	TRANSVERSE	TRANSVERSE	TRANSVERSE
Engine Mounting - Front		AR8058		
Engine Mounting - Rear		AR8035	AR9245 (Man. / Auto.)	AR9668 AR1047 (GO+)
Engine Mounting - Left	AR5857			AR9669 AR1048 (GO+)
Engine Mounting - Right	AR5857	AR8034	AR9247 (Man. / Auto.)	AR9670 AR1049 (GO+)
Engine Mounting - Other				
Transmission Mounting	AR5357	AR8036 (1.6) AR8044 (1.8)	AR9246 (Man. / Auto.)	
FRONT SUSPENSION				
Upper Control Arm Bush - Inner	AR2018 - Front (620) AR5387 - Front (680)			
Upper Control Arm Bush - Outer	AR2018 - Rear (620) AR5387 - Rear (680)			
Lower Control Arm Bush - Inner	AR5177	AR8064 - Front	AR9214 - Front	AR9214 - Front
Lower Control Arm Bush - Outer		AR8065 - Rear	AR9215 - Rear	AR9215 - Rear
Shock Rubber - Front	AR33 (ID: 16mm) AR5092 - Alt. (ID: 10mm)			
Stabilizer Bar Bush	AR5936	AR8432	AR9216	
Stabilizer Link Grommet	AR22			
Steering Coupling				
Steering Rack Mounting				
Strut Mounting		AR8433	AR9250	AR9673
Tension Rod Bush				
Miscellaneous				
REAR SUSPENSION				
Centre Bearing Rubber				
Exhaust Hanger - Middle				
Exhaust Hanger - Rear				
Lower Control Arm Bush - Inner				
Lower Control Arm Bush - Outer				
Propshaft Coupling				
Shackle Bush - Front	AR5343 (680) (4)			
Shackle Bush - Rear Upper	AR5377 (680) (4)			
Shackle Bush - Rear Lower	AR5377 (680) (4)			
Stabilizer Bar Bush				
Stabilizer Link Grommet				
Strut Mounting				
Miscellaneous			AR9252 Rear Axle Beam Bush	

APPLICATIONS	NISSAN E20 1.6 SWB Bus, Coach, P/van Pet. - J16 1.8 SWB, LWB 10, 16-Seater Bus, Coach, Coach, GL, GLE, Econolux, Ekonovan, Ekonowagon Pet. - L18	NISSAN HARDBODY QW/244 2.0 SWB, LWB SL P/up - Pet. NA20S 2.0i SWB, LWB S/Cab, SL, S/cab P/up Pet. - KA20 2.4i LWB S/cab, SL S/cab, D/cab, SL D/cab, Hi Rider S/Cab, D/cab P/up Pet. - KA24 2.7 SE, D/C, TD LWB S/cab, D/cab, SE P/up Dies. - TD27i	NISSAN HARDBODY D22 / QW/244 3.0i V6 LWB SL P/up Pet. - VG30E 3.0D, TD LWB Hi Rider, KingCab, Hi Rider P/up - Dies. - ZD30 3.2D LWB SE, SL, SLE D/cab P/up Dies. - QD32 3.3 V6 LWB Hi Rider, S/cab, D/cab, KingCab P/up Pet. - VG33E	NISSAN HARDBODY 4X4 D22 / QW/244 2.4i, LWB S/cab, SL D/cab, P/up Pet. - KA24E 2.7D, LWB S/cab, SE, D/cab, P/up Dies. - TD27i 3.0 V6 LWB D/cab, SE, SE D/cab, SL P/up Pet. - ZD30
YEARS	73-96	98-11	98-10	98-10
Engine Configuration	INLINE	INLINE	INLINE	INLINE
Engine Mounting - Front				
Engine Mounting - Rear				
Engine Mounting - Left		AR5864 (2.0, 2.4) AR5273 (2.7)	AR5276 (3.0D, 3.2) AR5866 (3.0i, 3.3)	AR5273 (2.4, 2.7) AR5866 (3.0)
Engine Mounting - Right		AR5864 (2.0, 2.4) AR6183 (2.7)	AR5277 (3.0D, 3.2) AR5866 (3.0i, 3.3)	AR6183 (2.4, 2.7) AR5866 (3.0)
Engine Mounting - Other				
Transmission Mounting	AR5357	AR5865	AR5867	AR5865 (2.7) AR5867 (2.4, 3.0)
FRONT SUSPENSION				
Exhaust Hanger - Front		AR5937	AR5937	AR5937
Upper Control Arm Bush - Inner		AR7527 - Front	AR7527 - Front	AR7527 - Front
Upper Control Arm Bush - Outer		AR7527 - Rear	AR7527 - Rear	AR7527 - Rear
Lower Control Arm Bush - Inner	AR5177	AR5946	AR5946	AR5946
Lower Control Arm Bush - Outer				AR5946
Shock Rubber - Front	AR33 (ID: 16mm) AR5092 (ID: 10mm) - Alt.	AR5092	AR5092	AR5092
Stabilizer Bar Bush		AR5786	AR5786	AR5782 (2.4, 2.7) AR5786 (3.0)
Stabilizer Link Grommet				AR5787
Steering Coupling				
Steering Rack Mounting				
Strut Mounting				
Tension Rod Bush	AR5306	AR5947	AR5947	
Miscellaneous	AR5407 Brake & Clutch Pedal Rubber AR5409 Accelerator Pedal Rubber AR5410 Gear Link Grommet AR5948 Gear Lever Insulator AR5953 (1.8) Caliper Link Pin with Rubber AR5954 (1.8) Caliper Link Pin w/o Rubber			
REAR SUSPENSION				
Centre Bearing Rubber	AR5308	AR5308	AR5308	AR5309
Exhaust Hanger - Middle		AR5938	AR5938	AR5934 AR5938 - Alt.
Exhaust Hanger - Rear		AR5937	AR5937	AR5937
Lower Control Arm Bush - Inner				
Lower Control Arm Bush - Outer				
Shackle Bush - Front	AR5941 (4)	AR5343 Std. (2) AR6413 Hi Rider (2)	AR5343 Std. (2) AR6413 Hi Rider (2)	AR6413 (2)
Shackle Bush - Rear Upper	AR5320 (4)	AR5379 Std. (4) AR6414 (4) For Stepped Shackle Hi Rider	AR5379 Std. (4) AR6414 (4) For Stepped Shackle Hi Rider	AR5379 (4)
Shackle Bush - Rear Lower	AR5320 (4)	AR5379 (4)	AR5379 (4)	AR5379 (4)
Shock Rubber - Rear	AR33	AR5939	AR5939	AR5939
Stabilizer Bar Bush				
Stabilizer Link Grommet				
Strut Mounting				
Miscellaneous				

APPLICATIONS	NISSAN HARDBODY 4X4 D22 / QW/244	NISSAN HARDBODY NP300 D22	NISSAN HARDBODY 4X4 NP300 D22	NISSAN INTERSTAR 2.5dCi SWB, LWB HR, SR P/van Dies. - G9U
	3.0TD LWB D/cab, KingCab P/up Dies. - ZD30 3.2D LWB SL S/cab, SE D/cab P/up Dies. - QD32 3.3i V6 LWB D/cab, Hi Rider D/cab P/up Pet. - VG33E	2.0i SWB, LWB S, SE P/up Pet. - KA20DE 2.4i LWB D/cab, D/cab Hi Rider P/up Pet. - KA24DE 2.5 TDi LWB S, SE, D/C, D/C Hi Rider, P/up Dies. - YD25DDTi	2.4i LWB S/C, D/C Hi Rider P/up Pet. - KA24DE 2.5 TDi LWB S, SE, D/C, D/C Hi Rider P/up Dies. - YD25DDTi	
YEARS	99-10	2008-	2008-	2006-
Engine Configuration	INLINE	INLINE	INLINE	INLINE
Engine Mounting - Front				
Engine Mounting - Rear				AR8438
Engine Mounting - Left	AR5276 (3.2 Only)	AR5864 (2.0, 2.4) AR9242 (2.5)	AR5273 (2.4) AR9242 (2.5)	
Engine Mounting - Right	AR5277 (3.2 Only)	AR5864 (2.0, 2.4) AR9243 (2.5)	AR6183 (2.4) AR9243 (2.5)	
Engine Mounting - Other				
Transmission Mounting	AR5867 (3.2 Only)	AR5865 (2.0, 2.4) AR5867 (2.5)	AR5867 (2.4) AR9674 (2.5)	
FRONT SUSPENSION				
Exhaust Hanger - Front	AR5937			
Upper Control Arm Bush - Inner	AR7527 - Front	AR7527 - Front	AR7527 - Front	
Upper Control Arm Bush - Outer	AR7527 - Rear	AR7527 - Rear	AR7527 - Rear	
Lower Control Arm Bush - Inner	AR5776	AR5946	AR5776	AR8434 - Front
Lower Control Arm Bush - Outer	AR5946		AR5946	AR8435 - Rear
Shock Rubber - Front	AR5092	AR5092	AR5092	
Stabilizer Bar Bush	AR5782	AR5786	AR5782	AR8436
Stabilizer Link Grommet	AR5787	AR1103 Stabilizer Link Pin Kit	AR5787 AR1103 Stabilizer Link Pin Kit	
Steering Coupling				
Steering Rack Mounting				
Strut Mounting				
Tension Rod Bush		AR5947		
Miscellaneous				
REAR SUSPENSION				
Centre Bearing Rubber	AR5309	AR5308	AR5309	
Exhaust Hanger - Middle	AR5934 AR5938 - Alt.		AR5934	
Exhaust Hanger - Rear	AR5937			
Lower Control Arm Bush - Inner				
Lower Control Arm Bush - Outer				
Propshaft Coupling				
Shackle Bush - Front	AR6413 (2)	AR5343 Std. (2) AR6413 Hi Rider (2)	AR6413 (2)	
Shackle Bush - Rear Upper	AR5379 (4)	AR5379 Std. (4) AR6414 (4) For Stepped Shackle Hi Rider	AR5379 (4)	
Shackle Bush - Rear Lower	AR5379 (4)	AR5379 (4)	AR5379 (4)	
Shock Rubber - Rear	AR5939			
Stabilizer Bar Bush				
Stabilizer Link Grommet				
Strut Mounting				
Miscellaneous				AR8437 Rear Axle Beam Bush

APPLICATIONS	NISSAN JUKE 4X2, 4X4 1.2T - HRA2DDT 1.5dCi - K9K 1.6 - HR16DE 1.6 DIG-T - MR16DDT, AWD	NISSAN LIVINA 1.6 Acenta, Acenta+, Visia, X-Gear Vista 5-Spd. Man. - HR16DE GRAND LIVINA 1.6 Acenta, Acenta+ 5-Spd. Man. - HR16DE	NISSAN MAXIMA GV 300SE 6-Cyl. - VG30E	NISSAN MAXIMA QX 2.0 - VQ20E/DE 3.0 V6 - VQ30DE
YEARS	2011-	07-15	91-97	96-04
Engine Configuration	INLINE	TRANSVERSE	TRANSVERSE	TRANSVERSE
Engine Mounting - Front			AR6740	AR8484
Engine Mounting - Rear	AR8903 (1.2T, 1.6, 1.6T AWD) Lower Torque Rod AR9967 (1.5, 1.6T) Lower Torque Rod	AR8181		AR8481
Engine Mounting - Left				AR8482
Engine Mounting - Right	AR9233 (1.6) AR9807 (1.5, 1.6, 1.6T, AWD) Upper Torque Rod AR1166 (1.2T) AR1168 (1.6T, AWD) AR1169 (1.5)	AR8363	AR6741	AR8483
Engine Mounting - Other				
Transmission Mounting	AR8364 (1.5, 1.6, 1.6T AWD) AR1167 (1.2T, 1.6T)	AR8364		
FRONT SUSPENSION				
Upper Control Arm Bush - Inner				
Upper Control Arm Bush - Outer				
Lower Control Arm Bush - Inner	AR8895 - Front	AR8360 - Front	AR6745 - Front	
Lower Control Arm Bush - Outer	AR8896 - Rear	AR8361 - Rear	AR6746 - Rear	AR5774 - Front L/RHS AR5775L - Rear LHS AR5775R - Rear RHS
Shock Rubber - Front				
Stabilizer Bar Bush	AR8898	AR8365	AR6747	
Stabilizer Link Grommet			AR22	AR22
Steering Coupling				
Steering Rack Mounting			AR6748 - RHS AR6749 - LHS	
Strut Mounting	AR9238L AR9238R	AR8160L AR8160R	AR6750	
Tension Rod Bush				
Miscellaneous				
REAR SUSPENSION				
Centre Bearing Rubber				
Exhaust Hanger - Middle			AR5149	AR5149
Exhaust Hanger - Rear			AR5149	AR5149
Lower Control Arm Bush - Inner				
Lower Control Arm Bush - Outer				
Propshaft Coupling				
Shackle Bush - Front				
Shackle Bush - Rear Upper				
Shackle Bush - Rear Lower				
Shock Rubber - Rear				
Stabilizer Bar Bush				
Stabilizer Link Grommet				
Strut Mounting	AR8899			
Miscellaneous		AR8477 Rear Axle Beam Bush		

APPLICATIONS	NISSAN MICRA K12	NISSAN MICRA K13	NISSAN MICRA K14	NISSAN MURANO Z50
	1.4 Comfort, Elegance, SE, Accenta, +, Sport, Visia - CR14DE 1.5dCi Tekna - K9K276, K9K722	1.2 - HR12DE 1.5 - HR15DE 1.5dCi - K9K700/4	0.9T - H4B408, HR09DET	4X4 3.5i V6, X-Tronic SUV - VQ35DE
YEARS	04-11	11-18	2018-	05-10
Engine Configuration	TRANSVERSE	TRANSVERSE	TRANSVERSE	INLINE
Engine Mounting - Front				AR8444
Engine Mounting - Rear	AR8362 Support Mounting AR1293 - Alt. (1.5) Support Mounting	AR9775 (1.2) AR9245 (1.5)	AR1044 Torque Rod	AR8446
Engine Mounting - Left				AR8442
Engine Mounting - Right	AR8239 (1.4, 1.5) AR1170 (1.5) Upper Torque Rod	AR9777 (1.2) AR9247 (1.5 - HR15DE) AR1160 (1.5 - K9K)	AR1045	AR8441
Engine Mounting - Other				
Transmission Mounting	AR8179 (1.4) AR8528 (1.5)	AR9776 (1.2) AR9246 (1.5)	AR1161	
FRONT SUSPENSION				
Upper Control Arm Bush - Inner				
Upper Control Arm Bush - Outer				
Lower Control Arm Bush - Inner	AR8360	AR9214 - Front	AR9214 - Front	AR8822 - Front
Lower Control Arm Bush - Outer	AR8361	AR9215 - Rear	AR9215 - Rear	AR8823 - Rear
Shock Rubber - Front				
Stabilizer Bar Bush		AR9216	AR1163	AR8439
Stabilizer Link Grommet				
Steering Coupling				
Steering Rack Mounting				
Strut Mounting	AR8160L AR8160R	AR9250	AR1162	AR8440
Tension Rod Bush				
Miscellaneous				
REAR SUSPENSION				
Centre Bearing Rubber				AR5308
Exhaust Hanger - Middle				
Exhaust Hanger - Rear				
Lower Control Arm Bush - Inner				
Lower Control Arm Bush - Outer				
Propshaft Coupling				
Shackle Bush - Front				
Shackle Bush - Rear Upper				
Shackle Bush - Rear Lower				
Stabilizer Bar Bush				
Stabilizer Link Grommet				
Strut Mounting				
Miscellaneous		AR8477 Rear Axle Beam Bush		

APPLICATIONS	NISSAN MURANO Z51 4X4 3.5i V6, X-Tronic SUV - VQ35DE	NISSAN NAVARA D40 4X2, 4X4 2.5dCi LWB D/cab LE, SE, XE P/up Dies. - YD25DDTi 3.0dCi V6 LWB D/cab P/up Dies. - V9X 4.0i V6 LWB LE D/cab P/up Pet. - VQ40DE	NISSAN NP200 1.5dCi SWB S, SE P/up Dies. - K9K 1.6 SWB S, SE P/up Pet. 8V - K7M, 16V - K4M	NISSAN NV200 M20 1.5dCi - K9K 1.6 - HR16DE
YEARS	09-15	2005-	2008-	2013-
Engine Configuration	INLINE	INLINE	TRANSVERSE	TRANSVERSE
Engine Mounting - Front				
Engine Mounting - Rear	AR9219		AR8478 (1.5, 1.6) Support Mounting AR8524 - Alt. 1 (1.5) Support Mounting AR8767 - Alt. 2 (1.5) Support Mounting AR1293 - Alt. 3 (1.5, 1.6) Support Mounting AR1294 - Alt. 4 (1.5, 1.6) Support Mounting	AR8181 (1.6) Support Mounting AR8362 (1.5) Support Mounting
Engine Mounting - Left		AR8811 (2.5) AR8452 (3.0) AR8454 (4.0)		
Engine Mounting - Right	AR9220 - Front AR9221 - Rear	AR8811 (2.5) AR8452 (3.0) AR8454 (4.0)	AR8239 (1.5) AR8769 - Alt. (1.5) AR8651 (1.6 8V - K7M) AR8768 (1.6 16V - K4M) AR1178 - Alt. (1.6 16V - K4M)	AR8363 (1.6) AR8239 (1.5) AR1170 (1.6) Upper Torque Rod
Engine Mounting - Other				
Transmission Mounting		AR8810 (2.5 Man.) AR8838 (2.5 Auto.) AR8451 (3.0) AR8453 (4.0)	AR8480 (1.5, 1.6 8V) AR8479 - Alt. (1.6)	AR8528
FRONT SUSPENSION				
Upper Control Arm Bush - Inner		AR8447		
Upper Control Arm Bush - Outer		AR8447		
Lower Control Arm Bush - Inner	AR9222 - Front	AR8448	AR8474 - Front	AR8360 - Front
Lower Control Arm Bush - Outer	AR9223 - Rear	AR8448	AR8474 - Rear	AR8361 - Rear
Shock Rubber - Front				
Stabilizer Bar Bush	AR9224	AR8449	AR8475	AR8365
Stabilizer Link Grommet			AR8815 Stabilizer Link Pin Kit	
Steering Coupling				
Steering Rack Mounting		AR9218		
Strut Mounting	AR9225	AR8450	AR8476	AR8469L AR8469R
Tension Rod Bush				
Miscellaneous				
REAR SUSPENSION				
Centre Bearing Rubber	AR5308	AR8814		
Exhaust Hanger - Middle				
Exhaust Hanger - Rear				
Lower Control Arm Bush - Inner				
Lower Control Arm Bush - Outer				
Propshaft Coupling				
Shackle Bush - Front		AR8455 (2)		AR8937
Shackle Bush - Rear Upper		AR8456 (4)		AR8935
Shackle Bush - Rear Lower		AR5379 (4)		AR8936
Stabilizer Bar Bush	AR9227			AR9662
Stabilizer Link Grommet				
Strut Mounting	AR9226			
Miscellaneous			AR8477 Rear Axle Beam Bush	AR9773 Brake + Clutch Pedal

APPLICATIONS	NISSAN NV350 2.5 Impendulo 16-Seater Taxi - F9Q760	NISSAN PATHFINDER R51 4X4 2.5dCi LWB D/cab LE, SUV Dies. - YD25DDTi 3.0dCi V6 LWB D/cab SUV Dies. - V9X 4.0i V6 LWB LE D/cab SUV Pet. - VQ40DE	NISSAN PATROL Y60 4X4 3.0 V6 LWB Twin Cab S/W Pet. - VG30E	NISSAN PATROL Y61 4X4 3.0 V6 LWB Y60 S/W Pet. - VG30E 3.0Di 6-Cyl. LWB GRX, TDi GL S/W Dies. - Y61 4.2 6-Cyl. LWB LDF P/up, S/W Dies. - TD42 4.5 6-Cyl. LWB P/up Dies. - Y61 4.8 6-Cyl. LWB GL, GRX P/up Dies. - Y61
	YEARS	2014-	05-15	90-94
Engine Configuration	INLINE	INLINE	INLINE	INLINE
Engine Mounting - Front				
Engine Mounting - Rear	AR8934			
Engine Mounting - Left	AR8932	AR8811 (2.5) AR8452 (3.0) AR8454 (4.0)	AR5866	AR5864
Engine Mounting - Right	AR8931	AR8811 (2.5) AR8452 (3.0) AR8454 (4.0)	AR5866	AR5864
Engine Mounting - Other				
Transmission Mounting	AR8933	AR8810 (2.5) AR8451 (3.0) AR8453 (4.0)	AR5867	AR5865
FRONT SUSPENSION				
Upper Control Arm Bush - Inner		AR8447	AR5387 - Front	AR5387 - Front (95-98) AR7527 - Front (98-03)
Upper Control Arm Bush - Outer		AR8447	AR5387 - Rear	AR5387 - Rear (95-98) AR7527 - Rear (98-03)
Lower Control Arm Bush - Inner	AR8941 - Front	AR8448	AR5946	AR5946
Lower Control Arm Bush - Outer	AR8942 - Rear	AR8448	AR5946	AR5946
Shock Rubber - Front			AR5092	AR5092
Stabilizer Bar Bush	AR8939	AR8449	AR5940	AR5940
Stabilizer Link Grommet			AR22	AR22
Steering Coupling				
Steering Rack Mounting	AR8938			
Strut Mounting		AR8450		
Tension Rod Bush			AR5947	AR5947
Miscellaneous				
REAR SUSPENSION				
Centre Bearing Rubber		AR8814	AR5299	AR5308
Exhaust Hanger - Middle				
Exhaust Hanger - Rear				
Lower Control Arm Bush - Inner				
Lower Control Arm Bush - Outer				
Propshaft Coupling				
Shackle Bush - Front	AR8937	No Shackle Bushes	AR5343 (2)	AR5343 (95-98) (2) AR6413 (98-03) (2)
Shackle Bush - Rear Upper	AR8935	No Shackle Bushes	AR5379 (4)	AR5379 (4)
Shackle Bush - Rear Lower	AR8936	No Shackle Bushes	AR5379 (4)	AR5379 (4)
Stabilizer Bar Bush				
Stabilizer Link Grommet				
Strut Mounting				
Miscellaneous				

APPLICATIONS	NISSAN PRIMASTER 1.9dCi Minibus - F9Q760	NISSAN PRIMERA 160 SE, Si - SR16DE	NISSAN PRIMERA 200 GSi, Si, STI, Elegance, Luxury - SR20DE	NISSAN QASHQAI J10 4X2, 4X4 1.5dCi Acenta SUV - K9K 1.6 Visia, +2, Acenta SUV - HR16DE 2.0 Acenta, +2, CVT SUV - MR20DE 2.0dCi Acenta SUV - M9R
YEARS	07-11	98-02	98-02	07-15
Engine Configuration	INLINE	TRANSVERSE	TRANSVERSE	TRANSVERSE
Engine Mounting - Front	AR8463 Lower Torque Rod	AR6759	AR6766 (Man.) AR6767 (Auto.)	
Engine Mounting - Rear		AR6768	AR6768	AR1196 (1.5dCi) Lower Torque Rod AR1198 (2.0dCi 4X2) Lower Torque Rod AR8473 (2.0dCi 4X4) Lower Torque Rod AR9228 (1.6, 2.0) Torque Rod Assy.
Engine Mounting - Left	AR1102		AR6764 (Man.) AR6769 (Auto.)	AR8471 (2.0dCi 4X4)
Engine Mounting - Right	AR8462 AR1101 Upper Torque Rod	AR6762	AR6763	AR1050 (2.0) AR1193 (1.5dCi) AR1194 (1.5dCi, 2.0dCi) Upper Torque Rod AR8470 (1.6) AR8472 (2.0dCi)
Engine Mounting - Other				
Transmission Mounting				AR1051 (2.0) AR1195 (1.5dCi) AR8480 (1.6)
FRONT SUSPENSION				
Upper Control Arm Bush - Inner		AR5784 - Inner	AR5784 - Inner	
Upper Control Arm Bush - Outer		AR5785 - Outer	AR5785 - Outer	
Lower Control Arm Bush - Inner	AR8458 - Front	AR5774 - Front L/RHS	AR5774 - Front L/RHS	AR9229 - Front
Lower Control Arm Bush - Outer	AR6098 - Rear	AR5775L - Rear LHS AR5775R - Rear RHS	AR5775L - Rear LHS AR5775R - Rear RHS	AR9230 - Rear
Shock Rubber - Front				
Stabilizer Bar Bush	AR8460	AR6772	AR6772	AR8468 (ID: 22mm) AR1143 (ID: 21.5mm)
Stabilizer Link Grommet				
Steering Coupling				
Steering Rack Mounting		AR6773 - LHS AR6774 - RHS	AR6773 - LHS AR6774 - RHS	
Strut Mounting	AR8459			AR8469L AR8469R
Tension Rod Bush				
Miscellaneous				
REAR SUSPENSION				
Centre Bearing Rubber				
Exhaust Hanger - Middle		AR5149	AR5149	
Exhaust Hanger - Rear				
Propshaft Coupling				
Shackle Bush - Front				
Shackle Bush - Rear Upper				
Shackle Bush - Rear Lower				
Stabilizer Bar Bush				AR8467
Stabilizer Link Grommet				AR1144L AR1144R Stabilizer Link - L/RHS
Strut Mounting				
Miscellaneous	AR8461 Rear Axle Beam Bush			

APPLICATIONS	NISSAN QASHQAI J11 4X2 1.2T Acenta + D - HRA2DDT 1.5dCi Acenta - K9K 1.6dCi Acenta - R9M 1.6 Acenta Tech - MR16DDT	NISSAN SABRE 160 GX, GXi - GA16DS	NISSAN SABRE 200 GXi - SR20DE	NISSAN SANI 4X4 2.2 LWB S/W Pet. - Z22 2.4 LWB Patrol S/W Pet. - Z24
	YEARS	2014-	94-02	94-02
Engine Configuration	TRANSVERSE	TRANSVERSE	TRANSVERSE	INLINE
Engine Mounting - Front	AR1147 (1.6dCi) Torque Rod Assy.	AR6223	AR6223	
Engine Mounting - Rear	AR1153 (MR16DDT) AR1185 (Excl. MR16DDT) Torque Rod Assy.	AR6225	AR6225	
Engine Mounting - Left	AR1155 (1.6dCi Only) AR1182 (Excl. 1.6dCi)	AR6222	AR6786 (94-97)	AR5864
Engine Mounting - Right	AR1153 (MR16DDT) AR1154 (1.6dCi) AR1187 (1.2T) AR1188 (1.5dCi)	AR6219	AR6219 (94-97) AR6804 (97-02)	AR5864
Engine Mounting - Other		AR6800 Dynamic Damper (97-02)	AR6800 Dynamic Damper (97-02)	
Transmission Mounting				AR5867
FRONT SUSPENSION				
Exhaust Hanger - Front		AR5149	AR5149	
Upper Control Arm Bush - Inner				AR5387 - Front
Upper Control Arm Bush - Outer				AR5387 - Rear
Lower Control Arm Bush - Inner	AR9996	AR5383 - Front	AR5383 - Front	AR5946
Lower Control Arm Bush - Outer	AR9997	AR8415 - Rear	AR8415 - Rear	
Shock Rubber - Front				AR5092
Stabilizer Bar Bush	AR1186 (Excl. 1.6dCi) AR1189 (1.6dCi Only)	AR6788	AR6788	AR5940
Stabilizer Link Grommet				
Steering Coupling				
Steering Rack Mounting		AR6216 - LHS AR6217 - RHS	AR6789 (94-97) AR6216 - LHS (97-02) AR6217 - RHS (97-02)	
Strut Mounting	AR1141	AR6211	AR6211	
Tension Rod Bush				AR5947
Miscellaneous				
REAR SUSPENSION				
Centre Bearing Rubber				AR5309
Exhaust Hanger - Middle		AR5149	AR5149	AR5938
Exhaust Hanger - Rear				AR5937
Lower Control Arm Bush - Inner				
Lower Control Arm Bush - Outer				
Propshaft Coupling				
Shackle Bush - Front				AR5343 (2)
Shackle Bush - Rear Upper				AR5379 (4)
Shackle Bush - Rear Lower				AR5379 (4)
Shock Rubber - Rear				
Stabilizer Bar Bush	AR8467			
Stabilizer Link Grommet	AR1144L AR1144R Stabilizer Link - L/RHS			
Strut Mounting				
Miscellaneous		AR5901 Lateral Link Bush AR6796 Radius Rod Bush AR6803 Radius Rod (97-02)	AR5901 Lateral Link Bush AR6805 Radius Rod	

APPLICATIONS	NISSAN SANI AW	NISSAN SANI 4X4	NISSAN SENTRA	NISSAN SENTRA
	2.4 LWB D/cab, Hi Rider S/W Pet. - Z24 2.5D LWB Custom S/W Dies. - TD25i 2.7D LWB MKII, Exec. S/W Dies. - TD27i 3.0 V6 LWB D/cab, MKII, Exec. S/W Pet. - VG30E	2.7D LWB D/cab S/W, Mk II, Exec. S/W Dies. - TD27i 3.0 V6 LWB D/cab, D/cab Exec., S/W, MKII, Exec., S/W Pet. - VG30E	1.3 GL, SX - E13S 1.6 GL, GX, GXE, GXEi Coupe, SGLi - E16E/S	1.8i 16V T/cam Coupe, Sedan Exec. - CA18DE
YEARS	88-99	90-99	87-92	89-92
Engine Configuration	INLINE	INLINE	TRANSVERSE	TRANSVERSE
Engine Mounting - Front			AR5845	AR5845
Engine Mounting - Rear			AR5845 (Man.) AR6370 (SGLi Auto.)	AR5845
Engine Mounting - Left	AR5864 (2.4) AR6183 (2.5, 2.7) AR5866 (3.0)	AR5866 (3.0) AR6183 (2.7)	AR5843	AR5847
Engine Mounting - Right	AR5864 (2.4, 2.5, 2.7) AR5866 (3.0)	AR5864 (2.7) AR5866 (3.0)		
Engine Mounting - Other				
Transmission Mounting	AR5865 (2.4, 2.5, 2.7) AR5867 (3.0)	AR5866 (3.0) AR5867 (2.7)	AR5844	AR5848
FRONT SUSPENSION				
Exhaust Hanger - Front			AR5149	AR5149
Upper Control Arm Bush - Inner	AR5387 - Front			
Upper Control Arm Bush - Outer	AR5387 - Rear			
Lower Control Arm Bush - Inner	AR5946		AR5383 - Front	AR5383 - Front
Lower Control Arm Bush - Outer			AR5384 - Rear	AR5384 - Rear
Shock Rubber - Front			AR5910	AR5910
Stabilizer Bar Bush	AR5940		AR5900	AR5900
Stabilizer Link Grommet			AR22	
Steering Coupling				
Steering Rack Mounting				
Strut Mounting				
Tension Rod Bush	AR5947			
Miscellaneous				
REAR SUSPENSION				
Centre Bearing Rubber	AR5308 (OD: 111mm) AR5309 - Alt. (OD: 120mm)			
Exhaust Hanger - Middle	AR5938		AR5149	AR5149
Exhaust Hanger - Rear	AR5937			
Lower Control Arm Bush - Inner				
Lower Control Arm Bush - Outer				
Propshaft Coupling				
Shackle Bush - Front	AR5343 Std. (2) AR6413 Hi Rider (2)			
Shackle Bush - Rear Upper	AR5379 (4)			
Shackle Bush - Rear Lower	AR5379 (4)		AR5910	
Shock Rubber - Rear	AR5939			
Stabilizer Bar Bush			AR5905	AR5905
Stabilizer Link Grommet			AR5904	AR5904
Strut Mounting				
Miscellaneous			AR5901 Front & Rear Link Bush	AR5901 Front & Rear Link Bush

APPLICATIONS	NISSAN SENTRA 140, GX, GXi, i, Si - GA14DNE/DS	NISSAN SENTRA 160, GSi, GX, GXi, SE, Si - GA16DNE/S	NISSAN SENTRA 200 GSi, STi - SR20DE	NISSAN SENTRA 1.6 5-Spd. Man., CVT - HR16DE
	YEARS	92-02	92-02	92-02
Engine Configuration	TRANSVERSE	TRANSVERSE	TRANSVERSE	TRANSVERSE
Engine Mounting - Front	AR6223	AR6223	AR6223	
Engine Mounting - Rear	AR6225	AR6218 (Auto.) AR6225 (Man.)	AR6225	AR8903 Lower Torque Rod
Engine Mounting - Left	AR6220	AR6221 (Auto.) AR6222 (Man.)	AR6786	
Engine Mounting - Right		AR6219	AR6219 (92-97) AR6804 (97-02)	AR9233
Engine Mounting - Other		AR6800 Dynamic Damper (97-02)	AR6800 Dynamic Damper (97-02)	
Transmission Mounting				AR8364
FRONT SUSPENSION				
Exhaust Hanger - Front	AR5149	AR5149	AR5149	
Upper Control Arm Bush - Inner				
Upper Control Arm Bush - Outer				
Lower Control Arm Bush - Inner	AR5383 - Front	AR5383 - Front	AR5383 - Front	AR8360 - Front
Lower Control Arm Bush - Outer	AR8415 - Rear	AR8415 - Rear	AR8415 - Rear	AR8361 - Rear
Shock Rubber - Front				
Stabilizer Bar Bush	AR6788	AR6788	AR6788	AR9237
Stabilizer Link Grommet				
Steering Coupling				
Steering Rack Mounting	AR6216 - RHS (92-97) AR6217 - LHS (92-97) AR6217 - RHS (97-02) AR6789 - LHS (97-02)	AR6216 - RHS (Man.) AR6217 - LHS (Man.) AR6789 P/S	AR6216 - RHS (Man.) AR6217 - LHS (Man.) AR6789 P/S	
Strut Mounting	AR6211	AR6211	AR6211	AR9238L AR9238R
Tension Rod Bush				
Miscellaneous				
REAR SUSPENSION				
Centre Bearing Rubber				
Exhaust Hanger - Middle	AR5149	AR5149	AR5149	
Exhaust Hanger - Rear				
Lower Control Arm Bush - Inner				
Lower Control Arm Bush - Outer				
Propshaft Coupling				
Shackle Bush - Front				
Shackle Bush - Rear Upper				
Shackle Bush - Rear Lower				
Shock Rubber - Rear				AR9239
Stabilizer Bar Bush				
Stabilizer Link Grommet				
Strut Mounting				
Miscellaneous	AR5901 Lateral Link Bush AR6796 Radius Rod Bush AR6803 Radius Rod (97-02)	AR5901 Lateral Link Bush AR6796 Radius Rod Bush AR6803 Radius Rod (97-02)	AR5901 Lateral Link Bush AR6805 Radius Rod	

APPLICATIONS	NISSAN SKYLINE R31 2.0 GL, GLE, SGI, SGLi - CA20, RB20E 3.0 6-Cyl. SGLi - RB30E	NISSAN TERRANO II 4X4 2.7 Dies. - TD27	NISSAN TIIDA 1.6 Visia, Visia +, Acenta 5-Spd. Man., 4-Spd. Auto. - HR16DE 1.8 Acenta 6-Spd. Man. - MR18DE	NISSAN X-TRAIL T30 4X2, 4X4 2.0 SUV Pet. - QR20DE 2.2D SE SUV Dies. - YD22ETI 2.5 SE, SE SUV - QR25DE
YEARS	87-92	00-02	06-13	01-08
Engine Configuration	INLINE	INLINE	TRANSVERSE	TRANSVERSE
Engine Mounting - Front				AR8203 (2.2D Only) AR8204 (Excl. 2.2D)
Engine Mounting - Rear			AR8181 Support Mounting	AR8303 (Excl. 2.0) AR9764 (2.0 Only)
Engine Mounting - Left	AR5852	AR5864		
Engine Mounting - Right	AR5852	AR5864	AR8363 (1.6) AR8417 (1.8) AR9814 Upper Torque Rod	AR8302 (Excl. 2.2D) AR1204 (2.2D Only)
Engine Mounting - Other	AR5924 X-Member Mounting			
Transmission Mounting	AR5854 (Man.) AR5855 (Auto.)	AR5865	AR8364 (1.6 Man., 1.8) AR8416 (1.6 Auto.)	AR8304 (Excl. 2.5 Auto.) AR8305 (2.5 Auto. Only)
FRONT SUSPENSION				
Exhaust Hanger - Front		AR5937		
Upper Control Arm Bush - Inner		AR5387 - Front		
Upper Control Arm Bush - Outer		AR5387 - Rear		
Lower Control Arm Bush - Inner		AR5946	AR8360 - Front	AR8284 - Front
Lower Control Arm Bush - Outer		AR5946	AR8361 - Rear	AR8285 - Rear AR8285I - Rear (Insert)
Shock Rubber - Front	AR5928	AR5092		
Stabilizer Bar Bush	AR5922	AR5940 AR1042 - Alt.	AR8365	AR9951
Stabilizer Link Grommet	AR22			
Steering Coupling				
Steering Rack Mounting				
Strut Mounting	AR6811 (88-92)		AR8160L AR8160R	AR8440
Tension Rod Bush	AR5388	AR5947		
Miscellaneous				
REAR SUSPENSION				
Centre Bearing Rubber	AR5308	AR5308		
Exhaust Hanger - Middle	AR5149		AR5149	
Exhaust Hanger - Rear	AR5149		AR5149	
Lower Control Arm Bush - Inner	AR5925			
Lower Control Arm Bush - Outer	AR5925			
Propshaft Coupling				
Shackle Bush - Front		AR5343 (2)	AR5386 (4)	
Shackle Bush - Rear Upper		AR5379 (4)	AR2068 (4)	
Shackle Bush - Rear Lower		AR5379 (4)	AR2067 (4)	
Shock Rubber - Rear			AR33	
Stabilizer Bar Bush				AR9952
Stabilizer Link Grommet	AR22			
Strut Mounting				
Miscellaneous				

APPLICATIONS	NISSAN X-TRAIL T31 4X2, 4X4 2.0 XE SUV Pet. - MR20DE 2.0dCi XE SUV - M1D/M9R 830/2 2.5 CVT LE, LE, SE Man. SUV - QR25DE	NISSAN X-TRAIL T32 4X2, 4X4 1.6dCi - R9M 2.0 CVT, 6-Spd. - MR20DD 2.5 SE, CVT - QR25DE		
YEARS	2008-	2014-		
Engine Configuration	TRANSVERSE	TRANSVERSE		
Engine Mounting - Front		AR1147 Torque Rod Assy. (4X2, 4X4 1.6, 4X4 2.5)		
Engine Mounting - Rear	AR8473 (4X4 2.0dCi) Torque Rod Assy. AR9228 (2.0, 2.5) AR1206 (4X2 2.0dCi) Torque Rod Assy.			
Engine Mounting - Left	AR8471 (4X4 2.0dCi) AR9667 (2.0) AR1205 (4X2 2.0dCi) AR1208 (2.5 Man.) AR1209 (2.5 CVT)	AR1149 (4X4 2.5) (14-16) AR1150 (4X4 2.5) (16-18) AR1152 (4X2 2.0)		
Engine Mounting - Right	AR8472 - Front (dCi Only) AR9251 (2.0) AR1194 - Upper (2.0dCi) Torque Rod Assy. AR1201 (2.5) AR1207 - Upper (2.5) Torque Rod Assy.	AR1146 (4X4 2.5) AR1151 (4X2 2.0) AR1154 Bracket (4X2, 4X4 1.6) AR1155 (4X2, 4X4 1.6)		
Engine Mounting - Other				
Transmission Mounting	AR1051 (2.0 - MR20DE)	AR1148 Torque Rod Assy. (4X4 2.0, 4X4 2.5) (16-18) AR1153 Lower Torque Rod (4X2, 4X4 1.6)		
FRONT SUSPENSION				
Exhaust Hanger - Front				
Upper Control Arm Bush - Inner				
Upper Control Arm Bush - Outer				
Lower Control Arm Bush - Inner	AR9229 - Front	AR9996 - Front		
Lower Control Arm Bush - Outer	AR9230 - Rear	AR9997 - Rear		
Shock Rubber - Front				
Stabilizer Bar Bush	AR8468 (ID: 22.7mm) AR1143 (ID: 21.5mm)	AR1140 (4X2, 4X4 1.6) AR1143 (4X2 2.0, 4X4 2.5)		
Stabilizer Link Grommet				
Strut Mounting	AR8469L AR8469R	AR1141		
Tension Rod Bush				
Miscellaneous				
REAR SUSPENSION				
Centre Bearing Rubber				
Lower Control Arm Bush - Inner				
Lower Control Arm Bush - Outer				
Propshaft Coupling				
Shackle Bush - Front				
Shackle Bush - Rear Upper				
Shackle Bush - Rear Lower				
Shock Rubber - Rear				
Stabilizer Bar Bush	AR1145	AR1142 (4X2, 4X4 1.6) AR1145 (4X2 2.0, 4X4 2.5)		
Stabilizer Link Grommet	AR1144L AR1144R Stabilizer Link - L/RHS	AR1144L AR1144R Stabilizer Link - L/RHS		
Strut Mounting				
Miscellaneous				

APPLICATIONS

OPEL

	OPEL ADAM 1.0T Jam, Glam, Rocks - B10XFT 1.4 - A14XER, B14XER ADAM S 1.4T - B14NEH	OPEL ASTRA F 140, i, iS - 14NV 160, i, Estate, iE, iS OHC - 16NZ 180i 18SE/XL iE OHC - 18XE 200i, Estate, iE - 20SE, tS - 20XE	OPEL ASTRA G 1.6 Classic CD, Classic CDE, Comfort, CS, Elegance - C16SEL 1.8 Caravan CD S/W, Classic CDE, CSE, Elegance, Irmscher, Sport - X18XE1 2.0 Classic CDX, Coupe', CSX - X20XEV	OPEL ASTRA H 1.4 Essentia - Z14XEP 1.6 Enjoy, Essentia - Z16XEP 1.8 Enjoy, Sport, GTC, GTC, Sport - Z18XER 1.9 CDTi Enjoy, GTC, Sport - Z19DT 2.0 Coupe' Turbo, GSi, GTC Turbo, OPC, Turbo Sport, GTC Turbo Sport - Z20LER
YEARS	2014-	93-99	99-04	04-10
Engine Configuration	TRANSVERSE	TRANSVERSE	TRANSVERSE	TRANSVERSE
Engine Mounting - Front			AR6838 AR6842 - Alt. (2.0)	AR8229 (1.4, 1.6, 1.8) AR8230 (1.9) AR9866 (2.0)
Engine Mounting - Rear	AR8493 (1.4) Engine Side AR8494 (1.4) Body Side	AR6254 (1.4, 1.6, 2.0) AR6255 (1.8)	AR6839	AR6839
Engine Mounting - Left		AR6253 - Front (without Aircon) AR6257 - Front (with Aircon)	AR6840 (1.6, 1.8) AR6843 (2.0)	AR9867
Engine Mounting - Right	AR8491 (1.0) AR9697 (1.4)	AR6166 - Front (1.4, 1.6) AR6433 - Front (1.8, 2.0)	AR6841	AR8231 (1.4, 1.6, 1.8) AR8232 (1.9 Man.) AR8233 (1.9 Auto.) AR9868 (2.0)
Engine Mounting - Other				
Transmission Mounting	AR9696 (1.0, 1.4)			
FRONT SUSPENSION				
Upper Control Arm Bush - Inner				
Upper Control Arm Bush - Outer				
Lower Control Arm Bush - Inner	AR8237 - Front	AR6383 - Front	AR5750 - Front	AR8234 - Front
Lower Control Arm Bush - Outer	AR8238 - Rear	AR6406 - Rear (Excl. 2.0ts) AR5750 - Rear (Only 2.0ts)	AR6846 - Rear	AR8234 - Rear
Shock Rubber - Front				
Stabilizer Bar Bush		AR6828 (1.4, 1.6, 1.8) AR6837 (2.0)	AR5751	AR6820
Stabilizer Link Grommet		AR7528 (1.4, 1.6, 1.8) Stabilizer Link AR7529 (2.0) Stabilizer Link		
Steering Coupling				
Steering Rack Mounting				
Strut Mounting	AR8490	AR6189	AR6848 (Excl. Bearing) AR6848B (Incl. Bearing)	AR8235
Miscellaneous			AR6850 Front X-Member Bush	
REAR SUSPENSION				
Centre Bearing Rubber				
Exhaust Hanger - Middle			AR6851	
Exhaust Hanger - Rear			AR6851	
Lower Control Arm Bush - Inner				
Lower Control Arm Bush - Outer				
Propshaft Coupling				
Shackle Bush - Front				
Shackle Bush - Rear Upper				
Shackle Bush - Rear Lower				
Stabilizer Bar Bush		AR5744		
Strut Mounting				
Miscellaneous	AR9698 Rear Axle Beam Bush	AR6834 Rear Axle Beam Bush	AR6854 Rear Carrier Bush	

APPLICATIONS	OPEL ASTRA J 1.4T, GTC - A14NET, B14NET 1.6 Essentia - A16XER 1.6T, Cosmo, GTC, Sport - A16LET 2.0 OPC - A20NFT, B20NFT	OPEL CORSA B 130 i, Lite, i S, le Chill Sedan, Hatch - 13NE 140i Classic, Active, Lite, Lite+ Sedan, Hatch - 14NE 160 i Classic, Sport, S, GSi, GSi Ltd., Classic iE, CD, CDE, S, Sedan, Hatch - 16SE	OPEL CORSA C 140i Classic Comfort, Chill, Club, Sport, Lite, Lite+, S, Lite Sport, Sedan, Hatch - 14NE 1.6i Elegance, Sport, Classic, Elegance Sedan, Hatch - 16SE 1.7i DTi Hatch, Classic Eleganc Sedan, Hatch Dies. - X17D 1.8i Hatch GSi, Classic Executive Sedan, Hatch	OPEL CORSA D 1.3 CDTi Enjoy Hatch - Z13DTH/J 1.4i Enjoy, Essentia, Cosmo Hatch, Sport - Z14XEP/R 1.4T - A14NEL 1.6i Sport, OPC A/Z - 16LEL
	YEARS	2010-	96-03	03-08
Engine Configuration	TRANSVERSE	TRANSVERSE	TRANSVERSE	TRANSVERSE
Engine Mounting - Front	AR1074 (A14NET, A16LET) AR1135 (B14NET) AR9396 (2.0 OPC)		AR8060 - Middle AR8062 - RHS AR8236 - LHS	
Engine Mounting - Rear	AR9394	AR6260		AR8494
Engine Mounting - Left		AR6258 - Front	AR8061	AR8492 (1.3, 1.4) AR8496 (1.6) AR9804 (1.4) - Alt.
Engine Mounting - Right	AR9395	AR6259 - Front		AR8491 (1.3, 1.4) AR8495 (1.6)
Engine Mounting - Other				
Transmission Mounting	AR1070 (B14NET) AR1071 (A14NET, A16LET)		AR8779	AR8493
FRONT SUSPENSION				
Upper Control Arm Bush - Inner				
Upper Control Arm Bush - Outer				
Lower Control Arm Bush - Inner	AR8485 - Front (Excl. GTC)	AR6855	AR6102 - Front	AR8237 - Front
Lower Control Arm Bush - Outer	AR8486 - Rear (Excl. GTC)		AR6103 - Rear	AR8238 - Rear (ID: 12mm) AR9924 - Rear (ID: 14mm)
Shock Rubber - Front				
Stabilizer Bar Bush	AR8487 (Excl. GTC)	AR6856	AR5751	AR8489
Stabilizer Link Grommet				
Steering Coupling				
Steering Rack Mounting		AR6866 - LHS AR6867 - RHS		
Strut Mounting	AR8845 (Excl. GTC)	AR6316	AR6848 (Excl. Bearing) AR6848B (Incl. Bearing)	AR8490
Tension Rod Bush		AR1157L (with Bracket) AR1157R (with Bracket) AR6857		
Miscellaneous				
REAR SUSPENSION				
Centre Bearing Rubber				
Exhaust Hanger - Front	AR1075			
Exhaust Hanger - Middle		AR6858	AR6851	
Exhaust Hanger - Rear		AR6859	AR6851	
Lower Control Arm Bush - Inner				
Lower Control Arm Bush - Outer				
Propshaft Coupling				
Shackle Bush - Front				
Shackle Bush - Rear Upper				
Shackle Bush - Rear Lower				
Stabilizer Bar Bush		AR6864		
Stabilizer Link Grommet				
Strut Mounting				
Miscellaneous			AR8063 Rear Axle Beam Bush	AR9698 Rear Axle Beam Bush

APPLICATIONS	OPEL CORSA E 1.0T - B10XFT, F10XFT 1.4T - B14XEL, B14NEH	OPEL CORSA LDV I 130i Utility P/up Pet. - 13NE 1.4i Utility, S P/up Pet. - 14NE 1.6i Utility, S, P/up Sport - 16NE 1.7D Utility P/up Dies. - X17D	OPEL CORSA LDV II 1.4i Utility S, Sport, Club P/up Pet. - 14XE 1.7D Utility, Sport, Club DTI P/up Dies. - Y17DT 1.8i Utility, Sport, Club P/up - Z18XEL	OPEL CORSA P/VAN PRONTO P/VAN [99-00] 1.3i Pet. - 3NE COMBO P/VAN [05-12] 1.4i Pet. - Z14XEP
YEARS	2015-	97-04	02-10	99-12
Engine Configuration		TRANSVERSE	TRANSVERSE	TRANSVERSE
Engine Mounting - Front			AR8060 - Middle AR8062 - RHS AR8236 - LHS	AR8060 - Middle (Combo) AR8062 - RHS (Combo) AR8236 - LHS (Combo)
Engine Mounting - Rear	AR8494 Body Side (1.0, 1.4 B14NEH) AR9978 Engine Side (1.0) AR9979 Body Side (1.4 B14XEL) AR9980 Engine Side (1.4 B14XEL) AR9981 Engine Side (1.4 B14NEH)	AR6260		AR6260 (Pronto)
Engine Mounting - Left		AR6258 - Front (1.3, 1.4, 1.6) AR6261 - Front (1.7)	AR8061	AR6258 - Front (Pronto) AR8061 (Combo)
Engine Mounting - Right	AR8491 (1.0) AR9982 (1.4 B14XEL) AR9983 (1.4 B14NEH)	AR6259 - Front (1.3, 1.4, 1.6) AR6262 - Front (1.7)		AR6259 - Front (Pronto)
Engine Mounting - Other				
Transmission Mounting	AR9696 (1.0) AR9984 (1.4 B14XEL) AR9985 (1.4 B14NEH)		AR8779	AR8779 (Combo)
FRONT SUSPENSION				
Upper Control Arm Bush - Inner				
Upper Control Arm Bush - Outer				
Lower Control Arm Bush - Inner	AR8237 - Front	AR6855 - Front	AR6103 - Rear	AR6102 - Front (Combo) AR6855 - Front (Pronto)
Lower Control Arm Bush - Outer	AR8238 - Rear (ID: 12mm) AR9924 - Rear (ID: 14mm)	AR6855 - Rear	AR6102 - Front	AR6103 - Rear (Combo) AR6855 - Front (Pronto)
Shock Rubber - Front				
Stabilizer Bar Bush	AR9986	AR6856	AR5751	AR5751 (Combo) AR6856 (Pronto)
Stabilizer Link Grommet				
Steering Rack Mounting		AR6866 - LHS AR6867 - RHS (1.3, 1.4, 1.6) AR6868 - RHS (1.7)	AR6866 - LHS AR6867 - RHS	
Strut Mounting	AR8490	AR6316	AR6848 (Excl. Bearing) AR6848B (Incl. Beaing)	AR6316 (Pronto) AR6848 (Combo) (Excl. Bearing) AR6848B (Combo) (Incl. Bearing)
Tension Rod Bush		AR1157L (with Bracket) AR1157R (with Bracket) - Pre-Lotus Suspension AR6857 Pre-Lotus AR8407 Lotus		AR1157L (with Bracket) AR1157R (with Bracket) AR6857 (Pronto)
Miscellaneous				
REAR SUSPENSION				
Exhaust Hanger - Middle		AR6267		AR6851
Exhaust Hanger - Rear		AR6861		AR6851
Shackle Bush - Front				
Shackle Bush - Rear Upper		AR6862 (2)		
Shackle Bush - Rear Lower		AR6863 (2)		
Stabilizer Bar Bush		AR6864		
Stabilizer Link Grommet				
Strut Mounting	AR9987L AR9987R			
Miscellaneous	AR9698 Rear Axle Beam Bush		AR8063 Rear Axle Beam Bush	AR6854 (Combo) Rear Axle Beam Bush

APPLICATIONS	OPEL KADETT 1.3 Cub, GL, LS, Rebel 5-Spd. Man. - NV 140 CL 5-Spd., Cub 4-Spd. Man. - 14NV	OPEL KADETT 1.6 L, GL, GLS, GSE, Rebel, 160 Cub - 16SV 160 GSE, GSi, - 16NZ, i, Aspen - 16NZ, L, GL - 16SH 1.8 GLX - 18SV, GSi - 18E, SE - L18LV 2.0 SGi 200 Boss, Super Boss, CD, GSi 8V - 20SEH, GSi 16V - 20XE, 20SHE	OPEL KADETT 140, S - 14NE 160i S - 16NZ 180i, iE - 18SE	OPEL KADETT 200iS - 20SE, tS - 20XE
	YEARS	80-93	84-93	93-99
Engine Configuration	TRANSVERSE	TRANSVERSE	TRANSVERSE	TRANSVERSE
Engine Mounting - Front				
Engine Mounting - Rear	AR5737	AR5737	AR6254 - Front (1.4, 1.6) AR6255 - Front (1.8)	AR6256
Engine Mounting - Left	AR5738	AR5738	AR6253 - Front (without Aircon) AR6257 - Front (with Aircon)	AR6253 - Front
Engine Mounting - Right	AR5739	AR5739	AR6166 - Front (1.4, 1.6) AR6433 - Front (1.8)	AR6433 - Front
Engine Mounting - Other				
Transmission Mounting				
FRONT SUSPENSION				
Upper Control Arm Bush - Inner				
Upper Control Arm Bush - Outer				
Lower Control Arm Bush - Inner	AR5740 - Front	AR5740 - Front	AR6383 - Front	AR6383 - Front
Lower Control Arm Bush - Outer	AR5741 - Rear	AR5741 - Rear	AR6406 - Rear	AR5750 - Rear ("tS" Only) AR6406 - Rear (Excl. "tS")
Shock Rubber - Front				
Stabilizer Bar Bush	AR5745	AR5745	AR6828	AR6837
Stabilizer Link Grommet	AR5742	AR5742	AR7528 Stabilizer Link	AR7529 Stabilizer Link
Steering Coupling				
Steering Rack Mounting		AR6870 - LHS (P/S) (1.8, 2.0, 200) AR6871 - RHS (P/S) (1.8, 2.0, 200)		
Strut Mounting	AR6268	AR6268	AR6189	AR6189
Tension Rod Bush				
Miscellaneous				
REAR SUSPENSION				
Centre Bearing Rubber				
Exhaust Hanger - Middle		AR6267		
Exhaust Hanger - Rear		AR6267		
Lower Control Arm Bush - Inner				
Lower Control Arm Bush - Outer				
Propshaft Coupling				
Shackle Bush - Front				
Shackle Bush - Rear Upper				
Shackle Bush - Rear Lower				
Stabilizer Bar Bush	AR5744	AR5744	AR5744	AR5744
Stabilizer Link Grommet				
Strut Mounting				
Miscellaneous	AR5743 (OD: 48mm) Rear Axle Beam Bush AR6834 - Alt. (OD: 59mm) Rear Carrier Bush AR6874 Rear Offset Carrier Bush	AR5743 (OD: 48mm) Rear Axle Beam Bush AR6834 - Alt. (OD: 59mm) Rear Carrier Bush AR6874 Rear Offset Carrier Bush	AR6834 Rear Axle Beam Bush	AR6834 Rear Axle Beam Bush

APPLICATIONS	OPEL MERIVA 1.4 Essentia MPV - Z14XEP 1.4T - A14NEL, B14NEL 1.6 Club, Comfort, Enjoy MPV - Z16XE/P 1.7 CDTi Elegance, Enjoy - Z17DT/H/R 1.8 Elegance, Easytronic MPV - Z18XE	OPEL MOKKA 1.4T - A14NET, B14NET	OPEL MONZA 160 CLS, GLS - 16SV, GSi, i Aspen - 16SE 1.8 CLX, GLE, Convertible - 18SV GLi, GLX - 18SE 2.0 Cabrio, CLi - 20SV 2.0 XE CD, CLE, GLE, GLi - 20SE/SV	OPEL OMEGA 2.2i 2.6i V6
YEARS	03-15	15-16	86-93	01-04
Engine Configuration	TRANSVERSE	TRANSVERSE	TRANSVERSE	TRANSVERSE
Engine Mounting - Front	AR8060 - Middle AR8062 - RHS AR8236 - LHS			
Engine Mounting - Rear		AR9700 Engine Side AR9701 Body Side	AR5737	
Engine Mounting - Left	AR8061		AR5738	AR8118
Engine Mounting - Right		AR9699	AR5739	AR8118
Engine Mounting - Other				
Transmission Mounting		AR9702		AR8119
FRONT SUSPENSION				
Upper Control Arm Bush - Inner				
Upper Control Arm Bush - Outer				
Lower Control Arm Bush - Inner	AR6102 - Front	AR9746 - Front	AR5740 - Front	AR8120
Lower Control Arm Bush - Outer	AR6103 - Rear	AR9747 - Rear	AR5741 - Rear	AR8121
Shock Rubber - Front				
Stabilizer Bar Bush	AR5751		AR5745	AR8122
Stabilizer Link Grommet			AR5742	
Steering Coupling				
Steering Rack Mounting			AR6870 P/S - LHS (2.0) AR6871 P/S - RHS (2.0)	
Strut Mounting	AR6848 (Excl. Bearing) AR6848B (Incl. Bearing)	AR8845	AR6268	AR8123
Tension Rod Bush				
Miscellaneous				
REAR SUSPENSION				
Centre Bearing Rubber				AR8124
Exhaust Hanger - Middle			AR6267	AR6851
Exhaust Hanger - Rear			AR6267	AR6851
Lower Control Arm Bush - Inner				
Lower Control Arm Bush - Outer				
Propshaft Coupling				AR8125
Shackle Bush - Front				
Shackle Bush - Rear Upper				
Shackle Bush - Rear Lower				
Stabilizer Bar Bush			AR5744	AR8130
Stabilizer Link Grommet				
Strut Mounting				
Miscellaneous	AR5269 Rear Axle Beam Bush AR8063 - Alt. Rear Axle Beam Bush		AR5743 (OD: 48mm) Rear Axle Beam Bush AR6834 - Alt. (OD: 59mm) Rear Carrier Bush AR6874 Rear Offset Carrier Bush	AR8126 Rear Axle Beam Bush - Front AR8127 Rear Axle Beam Bush - Rear AR8128 Rear Trailing Link Bush No. 1 AR8129 Rear Trailing Link Bush No. 2

APPLICATIONS	OPEL VIVARO 1.9 CDTi P/van, Enjoy Bus Dies. - F9Q760 2.0i P/van Pet. - F4R720	OPEL ZAFIRA I 1.8i CD Elegance MPV - X18XE1 2.0 OPC MPV - X20XEV 2.2i Elegance MPV - Z22SE	OPEL ZAFIRA II 1.6 Essentia MPV - Z16XEP 1.8i Enjoy, CD, Elegance MPV - Z18XEP 2.0 OPC MPV - Z20LEX 2.2i Enjoy, Elegance MPV	
YEARS	06-15	01-05	05-09	
Engine Configuration	TRANSVERSE	TRANSVERSE	TRANSVERSE	
Engine Mounting - Front	AR8463 Lower Torque Rod	AR6842	AR8229 (1.6, 1.8)	
Engine Mounting - Rear		AR6839	AR6839	
Engine Mounting - Left	AR1102	AR6840 (1.8) AR6843 (2.0, 2.2 Man.) AR6869 (2.2 Auto.)		
Engine Mounting - Right	AR8462 AR1101 Upper Torque Rod	AR6841	AR8231 (1.6, 1.8)	
Engine Mounting - Other				
Transmission Mounting				
FRONT SUSPENSION				
Upper Control Arm Bush - Inner				
Upper Control Arm Bush - Outer				
Lower Control Arm Bush - Inner	AR8458 - Front	AR5750 - Front	AR8234 - Front	
Lower Control Arm Bush - Outer	AR6098 - Rear	AR6846 - Rear	AR8234 - Rear	
Shock Rubber - Front				
Stabilizer Bar Bush	AR8460	AR5751 (1.8)	AR6820	
Stabilizer Link Grommet				
Steering Coupling				
Steering Rack Mounting				
Strut Mounting	AR8459	AR6848 (Excl. Bearing) AR6848B (Incl. Bearing)	AR8235	
Tension Rod Bush				
Miscellaneous		AR6850 Front X-Member Bush		
REAR SUSPENSION				
Centre Bearing Rubber				
Exhaust Hanger - Middle		AR6851 (2.0, 2.2)	AR6851	
Exhaust Hanger - Rear		AR6851 (2.0, 2.2)	AR6851	
Lower Control Arm Bush - Inner				
Lower Control Arm Bush - Outer				
Propshaft Coupling				
Shackle Bush - Front				
Shackle Bush - Rear Upper				
Shackle Bush - Rear Lower				
Stabilizer Bar Bush				
Stabilizer Link Grommet				
Strut Mounting				
Miscellaneous	AR8461 Rear Axle Beam Bush	AR6854 Rear Carrier Bush		

APPLICATIONS

PEUGEOT

	PEUGEOT 1007 1.6 3 Dr. Hatch - TU5JP4	PEUGEOT 107 1.0 XR, XR+, X-Line, Urban, Trendy - 1KR-FE 1.6 CC Sport2, XS, GTi - EP6C, VTi, Dynamic, Sportium - EP6DT, HDi XS, Dynamic, Sportium - 9HR-DV6C, DV6TED4	PEUGEOT 206 1.4 Popart, X-Line - TU3JP 1.6 CC, SW XS, XT, XT Premium 2A/C - TU5JP4 2.0 CC, GTi, GTi 180 Pet. - EW10J4, XT HDi Dies. - DW10TD	PEUGEOT 207 1.4 XL, XR, XR+, Urban, Active, Pop Art - EP3 1.6 Dynamix, Sportium, XS - 5FS-EP6C, 5FW- EP6, HDi - 9HR-DV6C, XS - 9HY-DV6TED4, 9HZ-DV6TED4 1.6 GT - 5FX-EP6DT, GTi - 5FY-EP6DTS 207 "CC" 1.6 Sport 1 - 5FS- EP6C, 5FW-EP6, Sport 2 - 5FX-EP6DT, EU5 - 5FR-EP6DT, 5FV- EP6CDT
YEARS	05-08	06-16	01-08	06-13
Engine Configuration	TRANSVERSE	TRANSVERSE	TRANSVERSE	TRANSVERSE
Engine Mounting - Front	AR8701			
Engine Mounting - Rear	AR8511	AR8503	AR7337 - RHS (2.0)	AR8511 (1.4, 1.6 Auto.) AR8513 (1.6 Man.) AR1112 (1.6)
Engine Mounting - Left	AR8512	AR8504	AR7334	AR8512
Engine Mounting - Right		AR8502	AR5800 (1.6) AR5804 (2.0) AR7333 (1.4)	AR1111 (1.6) AR1113 - Alt. (1.6)
Engine Mounting - Other				
Transmission Mounting				
	FRONT SUSPENSION			
Upper Control Arm Bush - Inner				
Upper Control Arm Bush - Outer				
Lower Control Arm Bush - Inner	AR7338 - Front	AR8497 - Front	AR5789 - Front	AR8505 - Front
Lower Control Arm Bush - Outer	AR7339 - Rear	AR8498 - Rear	AR5790 - Rear	AR8506 - Rear
Shock Rubber - Front				
Stabilizer Bar Bush	AR8700	AR8499	AR5752 (ID: 19mm) AR5753 (ID: 18mm)	AR8507 (ID: 20mm) AR8508 (ID: 21mm)
Stabilizer Link Grommet		AR9404 Stabilizer Link Pin Kit		
Steering Coupling				
Steering Rack Mounting				
Strut Mounting	AR8428 Locating Pin Centre	AR8500	AR5791 - RHS AR5792 - LHS	AR8509 Locating Pin Centre
Miscellaneous				
	REAR SUSPENSION			
Centre Bearing Rubber				
Exhaust Hanger - Middle				
Exhaust Hanger - Rear				
Lower Control Arm Bush - Inner				
Lower Control Arm Bush - Outer				
Propshaft Coupling				
Shackle Bush - Front				
Shackle Bush - Rear Upper				
Shackle Bush - Rear Lower				
Stabilizer Bar Bush				
Strut Mounting				
Miscellaneous		AR8501 Rear Axle Beam Bush		AR8510 Rear Axle Beam Bush

APPLICATIONS	PEUGEOT 2008	PEUGEOT 208	PEUGEOT 306	PEUGEOT 307
	1.2 THP 110 Active, Allure, GT-Line, Puretech - HNP-EB2ADT, HNV-EB2DTM, HNZ-EB2DT 1.6 HDi Active, Allure - 9HP-DV6DTE 1.6 VTi, Active, Allure - 5FS-EP6C	1.0 VTi - ZMZ-EBO 1.2 THP 110, GT-Line - HNP-EB2ADT, HNV-EB2DTM, HNZ-EB2DT 1.2 VTi - HMZ-EB2/F 1.6 VTi - 5FS-EP6C 1.6 HDi - 9HD-DV6DTE 1.6 HDi - 9HJ/P-DV6CTED 1.6 GTi - 5FU-EP6CDTX, 5GR-EP6FDTX	1.6 XT S/W - TU5JP 1.8 XT 2.0 XSi, Cabrio OHC - XU10J2/K	1.6 Estate, XR, XS HDi, XT - TU5JP4 1.6 HDi 110, XS - 9HY-DV6TED4, 9HZ-DV6TED4 2.0 CC 100, CC,130, XS, Man. - EW10J4, XS HDi - DW10TD
YEARS	2013-	2012-	99-02	01-07
Engine Configuration	TRANSVERSE	TRANSVERSE	TRANSVERSE	TRANSVERSE
Engine Mounting - Front				
Engine Mounting - Rear	AR1112 (Excl. 5FS-EP6C)	AR1088 (1.0, 1.2) AR1112 - Alt. AR8511 (1.6 VTi, GTi) AR8513 (1.0, 1.2, 1.6 HDi)	AR5872 (1.8, 2.0) Support Yoke Bush AR7320 (1.6) Support Yoke Bush AR7332 - RHS (1.6) AR7337 - RHS fits Engine Bracket (1.8, 2.0)	AR7337 - RHS fits Engine Bracket
Engine Mounting - Left			AR5797 (2.0) AR5886 (1.8) AR7334 (1.6)	AR5797
Engine Mounting - Right	AR1089 AR1111 - Alt. (DV6DTE) AR1113 - Alt. (5FS-EP6C)	AR1089 (1.6) AR1111 - Alt. (1.6) AR1113 - Alt. (1.6, Excl. HDi) AR9412	AR5805 (1.6, 1.8) AR5883 (2.0) AR7331 (1.6, 1.8, 2.0) Buffer Bracket	AR8761 (1.6) AR8809 (2.0)
Engine Mounting - Other				
Transmission Mounting		AR9413 (1.0, 1.2) AR9417 (1.6) AR1110 (1.2)		
FRONT SUSPENSION				
Upper Control Arm Bush - Inner				
Upper Control Arm Bush - Outer				
Lower Control Arm Bush - Inner	AR1090 - Front	AR9415 - Front AR1090 - Front (Alt.)	AR5181 (2) - Front	AR5884 - Front
Lower Control Arm Bush - Outer	AR1091 - Rear	AR9416 - Rear AR1091 - Rear (Alt.)	AR5180 - Rear	AR5789 - Rear
Shock Rubber - Front				
Stabilizer Bar Bush		AR8508 (ID: 21mm)	AR5807 (ID: 17mm) AR5821 (ID: 18mm) AR5825 (ID: 21mm)	AR5754 (ID: 21mm) AR5755 (ID: 20mm)
Stabilizer Link Grommet				
Steering Coupling				
Steering Rack Mounting				
Strut Mounting	AR1107	AR8981 Locating Pin Centre AR1107 - Alt.	AR5826	AR5885 (Incl. Bearing)
Tension Rod Bush				
Miscellaneous				
REAR SUSPENSION				
Exhaust Hanger - Middle				
Exhaust Hanger - Rear				
Lower Control Arm Bush - Inner				
Lower Control Arm Bush - Outer				
Propshaft Coupling				
Shackle Bush - Front				
Shackle Bush - Rear Upper				
Shackle Bush - Rear Lower				
Stabilizer Bar Bush				
Stabilizer Link Grommet				
Strut Mounting				
Miscellaneous		AR9414 Rear Axle Beam Bush	AR5815 (2.0) Axle Subframe Mounting - RHS AR5827 (2.0) Axle Subframe Mounting - Rear AR5828 (2.0) Axle Subframe Mounting - LHS	AR1093 Rear Axle Beam Bush

APPLICATIONS	PEUGEOT 3008 1.6i Exec., VTI Comfort, THP Premium - EP6/-DT 1.6i THP Active, Executive, Premium - 5FV-EP6CDT 1.6i VTI Access, Comfort - 5FS-EP6C, 5FW-EP6 2.0 HDi Active, Allure, Exec., Grip, Premium - DW10CTED4, DW10FD	PEUGEOT 3008 - P84 1.2 THP Active - HNS-EB2ADTS, HNY-EB2DTS 1.6i THP, Active, Allure, GT-Line - 5GY-EP6FDTM, 5GZ-EP6FDT 2.0 HDi Active, Allure - AHX-DW10FD	PEUGEOT 308 - T7 1.6i VTI, THP X-Line, XS, XT, CC, SW, Comfort, Premium, GTi - EP6/-DT/CDTX, DV6TED4 2.0 HDi CC, SW - DW10CTED4, Active - AHX-DW10FD	PEUGEOT 308 - T9 1.2 THP 110 Active, Puretech - HNP-EB2ADT, HNV-EB2DTM, HNZ-EB2DT, THP 130 Allure, GT-Line - HNY-EB2DTS 1.6 e-THP, GT - 5GT-EP6FDTX
YEARS	2010-	2017-	07-13	2013-
Engine Configuration	TRANSVERSE	TRANSVERSE	TRANSVERSE	TRANSVERSE
Engine Mounting - Front	AR8515 to fit "Eye Joint Link"		AR8515 to fit "Eye Joint Link"	
Engine Mounting - Rear	AR8516 Bush (1.6) AR8517 Bush (2.0) AR1108 - Alt.	AR1108 (1.2, 1.6)	AR8516 Bush (1.6) AR8517 Bush (2.0)	AR1108 (1.6) AR1112 - Alt. (1.2)
Engine Mounting - Left	AR7334 (1.6) AR5797 (2.0)		AR7334 (1.6) AR5797 (2.0)	
Engine Mounting - Right	AR9418 (1.6)		AR9418 (1.6)	AR1109 - Upper (1.6)
Engine Mounting - Other				
Transmission Mounting		AR1110 (1.2, 1.6)	AR1092 (1.6)	AR1110
FRONT SUSPENSION				
Upper Control Arm Bush - Inner				
Upper Control Arm Bush - Outer				
Lower Control Arm Bush - Inner	AR5884 - Front	AR1104 - Front	AR5884 - Front AR1104 - Front (Alt.) (DW10FD)	AR1104 - Front
Lower Control Arm Bush - Outer	AR5789 - Rear	AR1105 - Rear	AR5789 - Rear	AR1105 - Rear
Shock Rubber - Front				
Stabilizer Bar Bush			AR5755 (ID: 20mm)	
Stabilizer Link Grommet				
Steering Coupling				
Steering Rack Mounting				
Strut Mounting	AR8514 AR1106 - Alt.		AR8514	AR1106
Tension Rod Bush				
Miscellaneous				
REAR SUSPENSION				
Centre Bearing Rubber				
Exhaust Hanger - Middle				
Exhaust Hanger - Rear				
Lower Control Arm Bush - Inner				
Lower Control Arm Bush - Outer				
Propshaft Coupling				
Shackle Bush - Front				
Shackle Bush - Rear Upper				
Shackle Bush - Rear Lower				
Stabilizer Bar Bush				
Stabilizer Link Grommet				
Strut Mounting				
Miscellaneous				

APPLICATIONS	PEUGEOT 406 2.0 ST, ST Comfort, ST Estate - XU10J2TE, HDi, Comfort, Exec. - 8RHY/-Z, DW10TD/ATED 3.0 V6 Coupe', ST, Executive, SV Auto. - ES9J4S	PEUGEOT 5008 2.0 HDi Active - AHX-DW10FD	PEUGEOT BOXER 2.5TD 1.8 Ton Delivery Van Dies. - DJ5TED	PEUGEOT BOXER 2.2 HDi Delivery Van Dies. - 4H4 2.5 TDi Delivery Van Dies. - DJ5TED
YEARS	96-05	2011-	02-06	06-09
Engine Configuration	TRANSVERSE	TRANSVERSE	INLINE	INLINE
Engine Mounting - Front				
Engine Mounting - Rear	AR7332 - RHS fits "Eye Joint Link" AR7337 - RHS fits "Eye Joint Link"	AR1108	AR5958	AR8522 (2.2 Only)
Engine Mounting - Left	AR5889 (Man.) AR5891 (Auto.) AR5886 (2.0 HDi Only)		AR5959	AR8523 (2.2 Only)
Engine Mounting - Right	AR5804 (3.0) from job 007967 AR5914 (2.0) from Job 007967 AR5883 to job 007966		AR5961	AR8521 (2.2 Only)
Engine Mounting - Other				
Transmission Mounting		AR1110	AR5964	
FRONT SUSPENSION				
Upper Control Arm Bush - Inner				
Upper Control Arm Bush - Outer				
Lower Control Arm Bush - Inner	AR5931 - Front		AR8518 - Front	AR9419 - Front
Lower Control Arm Bush - Outer	AR5919 - Rear		AR8519 - Rear	AR9420 - Rear
Shock Rubber - Front				
Stabilizer Bar Bush				
Stabilizer Link Grommet			AR6001	
Steering Coupling				
Steering Rack Mounting				
Strut Mounting	AR5957 (2.0)	AR1106	AR5989 - LHS AR5984 - RHS	AR8520L AR8520R
Tension Rod Bush				
Miscellaneous			AR8774 Stabilizer Link Assembly	
REAR SUSPENSION				
Centre Bearing Rubber				
Exhaust Hanger - Middle				
Exhaust Hanger - Rear				
Lower Control Arm Bush - Inner	AR5956			
Lower Control Arm Bush - Outer	AR5935			
Propshaft Coupling				
Shackle Bush - Front			AR5981 (4)	
Shackle Bush - Rear Upper			AR5981 (4)	
Shackle Bush - Rear Lower			AR5983 (4)	
Stabilizer Bar Bush				
Stabilizer Link Grommet				
Strut Mounting				
Miscellaneous	AR5929 Axle Subframe Support Bush AR5949 Trailing Arm Bush - Rear AR5950 Rear Axle Beam Bush AR5955 Trailing Arm Bush - Front			

APPLICATIONS	PEUGEOT BOXER 2.2 HDi "120" 4HU - P22DTE 2.2 HDi "130" 4HH - P22DTE 3.0 HDi "130" F1CE0481D - F30DT	PEUGEOT EXPERT 2.0 HDi	PEUGEOT PARTNER 1.9D P/van 2.0 Grand Raid HDi Dies.	PEUGEOT PARTNER 1.6 HDi
YEARS	2007-	2008-	03-09	08-18
Engine Configuration	INLINE	INLINE	TRANSVERSE	TRANSVERSE
Engine Mounting - Front				
Engine Mounting - Rear	AR8522 (2.2) Engine Side AR9421 (2.2) Body Side AR9636 (3.0) Engine Side AR9637 (3.0) Body Side	AR7320 Support Yoke Bush AR7337	AR5872 Support Yoke Bush AR7337 - RHS (Insert)	AR8516 Bush
Engine Mounting - Left	AR8523 (2.2) AR9638 (3.0)	AR5891	AR5797	AR7334
Engine Mounting - Right	AR8521 (2.2) AR9639 (3.0)		AR5883 AR7331 Buffer Bracket	
Engine Mounting - Other				
Transmission Mounting				
FRONT SUSPENSION				
Upper Control Arm Bush - Inner				
Upper Control Arm Bush - Outer				
Lower Control Arm Bush - Inner	AR9419 - Front		AR5181 - Front (2)	AR5884
Lower Control Arm Bush - Outer	AR9420 - Rear		AR5180 - Rear	AR5789
Shock Rubber - Front				
Stabilizer Bar Bush			AR5825	AR9401 (ID: 24.5mm) AR9402 (ID: 21mm) AR9403 (ID: 23mm)
Stabilizer Link Grommet	AR6001			
Steering Coupling				
Steering Rack Mounting				
Strut Mounting	AR8520L AR8520R		AR5171	AR5885
Tension Rod Bush				
Miscellaneous	AR8774 Stabilizer Link Assembly			
REAR SUSPENSION				
Centre Bearing Rubber				
Exhaust Hanger - Middle	AR9422			
Exhaust Hanger - Rear				
Lower Control Arm Bush - Inner				
Lower Control Arm Bush - Outer				
Propshaft Coupling				
Shackle Bush - Front				
Shackle Bush - Rear Upper				
Shackle Bush - Rear Lower				
Stabilizer Bar Bush				
Stabilizer Link Grommet				
Strut Mounting				
Miscellaneous				AR9400 Rear Axle Beam Bush

APPLICATIONS	RENAULT	RENAULT CAPTUR	RENAULT CLIO II	RENAULT CLIO III	RENAULT CLIO IV
		0.9 TCe - H4B 1.2 - H5F 1.5dCi - K9K	1.2 8V - D4F 1.4 16V - K4J, 8V - K7J 1.5dCi - K9K 1.6 16V - K7M 2.0 Sport - F4R	1.4 16V - K4J 1.5dCi - K9K 1.6 - K4M 2.0 Sport - F4R	0.9T TCe 90 - H4B 1.2 5-Spd. Man. - D4F
YEARS		2015-	99-08	04-14	2013-
Engine Configuration		TRANSVERSE	TRANSVERSE	TRANSVERSE	TRANSVERSE
Engine Mounting - Front					
Engine Mounting - Rear		AR9576 (0.9)		AR8524 Support Mounting AR8181 - Alt. Support Mounting	AR9576 Lower Torque Rod
Engine Mounting - Left			AR6004		
Engine Mounting - Right		AR1158 (0.9)	AR9694 (1.2) AR6003 (1.4, 1.6, 2.0) AR9589 (1.5) AR1254 - Alt. (1.5)	AR1295 (Alt. 1.4) (1.5, 1.6) AR1297 (Alt. 1.6) (1.4, 1.6 Auto.) AR1299 - Alt. (1.5) AR1298 (1.5) Upper Torque Rod	AR1158 (0.9) AR1284 (1.2)
Engine Mounting - Other					
Transmission Mounting		AR9577 (0.9)	AR8144 (1.2, 1.4) Lower Rear Support AR8144A - Alt. (1.2, 1.4) Lower Rear Support AR8144AB - Alt. (1.5, 1.6, 2.0) Lower Rear Support AR1253 - Alt. (1.4 16V) Lower Rear Support	AR8480 (1.4, 1.6) AR8528 (1.5)	AR9577
FRONT SUSPENSION					
Upper Control Arm Bush - Inner					
Upper Control Arm Bush - Outer					
Lower Control Arm Bush - Inner		AR6815	AR6002	AR8360 - Front	AR6815 - Front
Lower Control Arm Bush - Outer		AR6819	AR6002	AR8218 - Rear	AR6819 - Rear
Shock Rubber - Front					
Stabilizer Bar Bush			AR6808	AR6809	
Stabilizer Link Grommet			AR8815 Stabilizer Link Pin Kit		
Steering Coupling					
Steering Rack Mounting					
Strut Mounting		AR1138 (Hole Spacing - 106mm)	AR6005 AR8160L - Alt. AR8160R - Alt.	AR1138 (Clio III) (Hole Spacing - 106mm) AR8160L - Alt. AR8160R - Alt.	AR1138 (Hole Spacing - 106mm) AR9578 (Hole Spacing - 120mm)
Miscellaneous					
REAR SUSPENSION					
Centre Bearing Rubber					
Exhaust Hanger - Middle					
Exhaust Hanger - Rear					
Lower Control Arm Bush - Inner					
Lower Control Arm Bush - Outer					
Propshaft Coupling					
Shackle Bush - Front					
Shackle Bush - Rear Upper					
Shackle Bush - Rear Lower					
Stabilizer Bar Bush					
Strut Mounting					
Miscellaneous					

APPLICATIONS	RENAULT DUSTER I 4X2, 4X4 1.5dCi - K9K858/884 1.6 - K4M616	RENAULT FLUENCE 1.6 - H4M720 1.6 - K4M838/839 2.0 - M4R714/751	RENAULT KADJAR 4X2, 4X4 1.2T Dynamique - H5F408 1.5dCi Dynamique - K9K 1.6dCi Dynamique - R9M	RENAULT KANGOO I 1.4 Multix Authentique MPV Pet., Express Van Pet. - E7J780, 8V - K7J700 1.5dCi Express Van Dies. - K9K700/704
YEARS	13-17	11-16	2016-	01-07
Engine Configuration	TRANSVERSE	TRANSVERSE	TRANSVERSE	TRANSVERSE
Engine Mounting - Front			AR1147 (1.6dCi) Torque Rod Assy.	
Engine Mounting - Rear	AR9581 AR1293 - Alt. (1.6) Support Mounting	AR1251 (1.6 - H4M, 2.0) Lower Torque Rod AR8538 (1.6 - K4M) Lower Torque Rod	AR1181 (1.2T, 1.5dCi) Torque Rod Assy. AR1185 (1.6dCi) Torque Rod Assy.	AR6818 (1.4)
Engine Mounting - Left		AR8534 (1.6 - H4M, 2.0) AR8537 (1.6 - K4M)	AR1155 (1.5dCi, 4X4 1.6dCi) AR1182 (1.2T, 4X2 1.6dCi)	AR6004
Engine Mounting - Right	AR8769	AR1252 (1.6 - H4M) AR8533 (1.6 - K4M, 2.0)	AR1180 (1.2T) AR1183 (1.5dCi) AR1184 (1.6dCi)	AR1254 (1.5) AR6003 (1.4)
Engine Mounting - Other				
Transmission Mounting	AR8479 (1.6) AR8480 - Alt. (1.6) AR8528 (1.5)			AR1253 (1.5) Lower Rear Support AR8144 Lower Rear Support AR8144A Lower Rear Support AR8144AB Lower Rear Support
FRONT SUSPENSION				
Upper Control Arm Bush - Inner				
Upper Control Arm Bush - Outer				
Lower Control Arm Bush - Inner	AR9582 - Front	AR8529 - Front	AR9996	AR6002
Lower Control Arm Bush - Outer	AR9582 - Rear	AR8530 - Rear	AR9997	AR6002
Shock Rubber - Front				
Stabilizer Bar Bush	AR9579	AR9587 (ID 22.5mm) AR9588 (ID: 20mm)	AR1186	AR6808
Stabilizer Link Grommet				AR8815 Stabilizer Link Pin Kit
Steering Coupling				
Steering Rack Mounting				
Strut Mounting	AR8476	AR9586	AR1141	AR6005
Tension Rod Bush				
Miscellaneous		AR9583 Front Axle Beam Bush - Front AR9584 Front Axle Beam Bush - Rear		
REAR SUSPENSION				
Centre Bearing Rubber				
Lower Control Arm Bush - Inner				
Lower Control Arm Bush - Outer				
Propshaft Coupling				
Shackle Bush - Front				
Shackle Bush - Rear Upper				
Shackle Bush - Rear Lower				
Stabilizer Bar Bush	AR9580		AR8467	
Stabilizer Link Grommet			AR1144L AR1144R Stabilizer Link - L/RHS	
Strut Mounting				
Miscellaneous	AR8477 Rear Axle Beam Bush	AR9585 Rear Axle Beam Bush		

APPLICATIONS	RENAULT KANGOO II 1.6 8V 64kw 5-Spd. Man. - K7M750 1.6 16V 78kw 5-Spd. Man. - K4M830/1/4	RENAULT KOLEOS - HY 4X2, 4X4 2.0dCi Dynamique, Premium, SUV - M1D/M9R830/32 2.5 Dynamique, Premium SUV - 2TR702, CVT - 2TR703	RENAULT KWID 1.0 - B4D404	RENAULT LAGUNA 1.6 RT, RTE - K4M720 1.8 RN, RN Estate, RT - F3P/P6 3.0 RXT V6 - L7X700
YEARS	2008-	2008-	2015-	96-02
Engine Configuration	TRANSVERSE	TRANSVERSE	TRANSVERSE	TRANSVERSE
Engine Mounting - Front		AR8473 - Upper RHS (dCi Only)		
Engine Mounting - Rear	AR8524 (1.6 - K4M) Support Mounting AR9591 Lower Torque Rod AR8767 - Alt. 1 Lower Torque Rod AR1294 - Alt. 2 Support Mounting	AR9228 (2.5) AR1199 (2.0dCi) Torque Rod Assy.	AR9974	AR6061 (1.6) (99-00) AR6069 (1.8) AR6087 (1.6) (00-01)
Engine Mounting - Left		AR8471 - Rear (dCi Only) AR1200 (2.0dCi) AR1203 (2.5)	AR9975	
Engine Mounting - Right	AR8470 (1.6 - K7M) AR8651 (1.6 - K4M)	AR8472 - Front (dCi Only) AR9951 (2.0dCi) AR1194 - Upper (2.0dCi) Torque Rod Assy. AR1201 (2.5) AR1202 - Upper (2.5) Torque Rod Assy.	AR9976	AR6041 (1.6) AR6086 (1.8)
Engine Mounting - Other				
Transmission Mounting	AR8480 (1.6 - K7M) AR9577 (1.6 - K4M)			AR6085 (1.8)
FRONT SUSPENSION				
Upper Control Arm Bush - Inner				
Upper Control Arm Bush - Outer				
Lower Control Arm Bush - Inner	AR6002 - Front AR6815 - Front (1.6)	AR9229		AR6088
Lower Control Arm Bush - Outer	AR6002 - Rear AR6819 - Rear (1.6)	AR9230		
Shock Rubber - Front				
Stabilizer Bar Bush	AR6808	AR1140 (ID: 22.5mm)	AR9579	
Stabilizer Link Grommet	AR8815 Stabilizer Link Pin Kit			
Steering Coupling				
Steering Rack Mounting				
Strut Mounting	AR6005 AR9592 (1.6)	AR8469L AR8469R	AR1136	AR6089 - LHS AR6090 - RHS
Tension Rod Bush				
Miscellaneous				
REAR SUSPENSION				
Centre Bearing Rubber				
Lower Control Arm Bush - Inner				
Lower Control Arm Bush - Outer				
Propshaft Coupling				
Shackle Bush - Front				
Shackle Bush - Rear Upper				
Shackle Bush - Rear Lower				
Stabilizer Bar Bush		AR1145 (ID: 17mm)		
Stabilizer Link Grommet		AR1144L AR1144R Stabilizer Link - L/RHS		
Strut Mounting				
Miscellaneous			AR1137 Rear Axle Beam Bush	

APPLICATIONS	RENAULT LAGUNA 2.0 RT, RT Estate, RXE	RENAULT LAGUNA 1.8 Authentique, Expression - F4P7 1.9dCi Expression 2.0 Expression 3.0 Privilege - L7X731	RENAULT LOGAN 1.6 Expression - K7M710	RENAULT MEGANE I 1.4 Authentique - E7J626, K4J750 1.6 Classic RT, Classic RXE, Classic RXT, RN Hatch, RSi Coupe, RT Cabriolet, RT Coupe, RT Hatch, RXE, RXE Cab., RXI Cab., RXT - K7M702, K4M700/01 2.0 Cabriolet, RSi Cabriolet, RXE Classic, - F3R796/7/8, Coupe 16V/8V, RSi Coupe, RXE - F3R750, F7R710, F7R714
	YEARS	96-00	01-09	08-12
Engine Configuration	TRANSVERSE	TRANSVERSE	TRANSVERSE	TRANSVERSE
Engine Mounting - Front				
Engine Mounting - Rear	AR6061 Code A56 AR6069 Code B56	AR6087 (1.8) AR6095 (1.9 dCi, 2.0)	AR8478 Support Mounting AR1293 - Alt. Support Mounting	
Engine Mounting - Left				AR6004
Engine Mounting - Right	AR6041 16V, Code A56 AR6096 8V, Code B56 AR6097 16V, Code B56	AR6086 (1.8)	AR8651	AR6801 (2.0) AR8408 (1.4, 1.6)
Engine Mounting - Other				
Transmission Mounting	AR6085	AR6085 (1.8)	AR8479 AR8480 - Alt.	AR1248 (1.4, 1.6) Lower Rear Support AR1249 (2.0) Lower Rear Support AR8144 Lower Rear Support
FRONT SUSPENSION				
Upper Control Arm Bush - Inner				
Upper Control Arm Bush - Outer				
Lower Control Arm Bush - Inner	AR6088	AR6098	AR8474	AR6353
Lower Control Arm Bush - Outer		AR6099	AR8474	AR6353
Shock Rubber - Front				
Stabilizer Bar Bush			AR8475	AR6808 (ID: 23mm) AR6809 (ID: 24mm)
Stabilizer Link Grommet			AR8815 Stabilizer Link Pin Kit	
Steering Coupling				
Steering Rack Mounting				
Strut Mounting	AR9862	AR9862	AR8476	AR6765
Tension Rod Bush				
Miscellaneous				
REAR SUSPENSION				
Centre Bearing Rubber				
Exhaust Hanger - Middle			AR9689	
Exhaust Hanger - Rear			AR9689	
Lower Control Arm Bush - Inner				
Lower Control Arm Bush - Outer				
Propshaft Coupling				
Shackle Bush - Front				
Shackle Bush - Rear Upper				
Shackle Bush - Rear Lower				
Stabilizer Bar Bush				
Stabilizer Link Grommet				
Strut Mounting				
Miscellaneous		AR6093 - LHS Rear Axle Beam Bush AR6094 - RHS Rear Axle Beam Bush	AR8477 Rear Axle Beam Bush	

APPLICATIONS	RENAULT MEGANE II 1.5dCi Authentique, Shake It! 5-Spd. Man. - K9K722 1.6 5-Spd. Man., CC Dynamique, Expression, Cabrio, Coupe, Privilège - K4M760/1 Authentique, Shake It! - K4M701, Classic, Expression, Privilège - K4M700, K4M812	RENAULT MEGANE II 1.9dCi, CC Dynamique, DCi Privilège, Dynamique, '+' 6-Spd. Man. - F9Q800 2.0, CC Privilège, Classic Dynamique 6-Spd. Man. - F4R770 2.0T Sport, F1 Team 6-Spd. Man. - F4R774	RENAULT MEGANE III 1.2 Tce, GT-Line - H5F404 1.4 Tce Coupe, CC, Hatch Dynamique, GT-Line - H4J700 1.6 Coupe, Hatch Dynamique, Shake It! - K4M9766/858 1.6dCi - R9M402	RENAULT MEGANE III 1.9dCi Hatch, Dynamique - F9Q870/72 2.0i Coupe RS250 Cup, Sport 2.0 RS265 - F4R874 2.0 RB7
YEARS	02-10	02-10	2010-	2010-
Engine Configuration	TRANSVERSE	TRANSVERSE	TRANSVERSE	TRANSVERSE
Engine Mounting - Front				
Engine Mounting - Rear	AR8478 (1.5, 1.6) Lower Torque Rod AR8524 - Alt. 1 (1.5, 1.6) Lower Torque Rod AR8767 - Alt. 2 (1.6) Lower Torque Rod AR1293 - Alt. 3 (1.6) Support Mounting AR1294 - Alt. 4 Support Mounting	AR8526 Lower Torque Rod	AR1251 (1.2) Lower Torque Rod AR8535 (1.4, 1.6dCi) Lower Torque Rod AR8538 (1.6) Lower Torque Rod	AR8535 (2.0) Lower Torque Rod AR8541 (1.9dCi) Lower Torque Rod
Engine Mounting - Left			AR8534 (1.2, 1.4, 1.6dCi) AR8537 (1.6)	AR8534 (2.0) AR8537 (1.9dCi)
Engine Mounting - Right	AR8239 (1.5) AR8470 (1.6)	AR8241 AR8527 Upper Torque Rod	AR1250 (1.2) AR1252 (1.4) AR8533 (1.6) AR8536 (1.4, 1.6dCi) Upper Torque Rod AR9594 (1.6dCi)	AR8539 (1.9dCi) AR8540 (1.9dCi) Upper Torque Rod AR9594 (2.0) AR8536 (2.0) Upper Torque Rod
Engine Mounting - Other				
Transmission Mounting	AR8480 (1.6) AR8528 (1.5)	AR8528		
FRONT SUSPENSION				
Upper Control Arm Bush - Inner				
Upper Control Arm Bush - Outer				
Lower Control Arm Bush - Inner	AR6815 - Front	AR6815 - Front	AR8529 - Front	AR6815 - Front (2.0) AR8529 - Front
Lower Control Arm Bush - Outer	AR6819 - Rear	AR6819 - Rear	AR8530 - Rear	AR6819 - Rear (2.0) AR8530 - Rear
Shock Rubber - Front				
Stabilizer Bar Bush	AR7141	AR7141		
Stabilizer Link Grommet				
Steering Coupling				
Steering Rack Mounting				
Strut Mounting	AR6816	AR6816	AR8531	AR8531
Tension Rod Bush				
Miscellaneous				
REAR SUSPENSION				
Centre Bearing Rubber				
Exhaust Hanger - Middle				
Exhaust Hanger - Rear				
Lower Control Arm Bush - Inner				
Lower Control Arm Bush - Outer				
Propshaft Coupling				
Shackle Bush - Front				
Shackle Bush - Rear Upper				
Shackle Bush - Rear Lower				
Stabilizer Bar Bush				
Stabilizer Link Grommet				
Strut Mounting				
Miscellaneous			AR8532 Rear Axle Beam Bush	AR8532 Rear Axle Beam Bush

APPLICATIONS	RENAULT MEGANE IV 1.2T Dynamique - H5F408 1.6 Dynamique - H4M750 1.6 GT-Line - M5M450 1.8 RS 280 EDC Lux - M5P402	RENAULT MODUS 1.2 Authentique 5-Spd. Man. - D4F740 1.4 Expression, Dynamique 5-Spd. Man. - K4J770/780 1.6 Expression 5-Spd. Man. - K4M790	RENAULT SANDERO I 1.4 Authentique, Ambience - K7J710 1.6 Cup, Dynamique, Stepway, Expression, '+', Pack, League, United - K7M690/710	RENAULT SANDERO II 900T - H4B400
YEARS	2016-	05-08	09-15	2014-
Engine Configuration	TRANSVERSE	TRANSVERSE	TRANSVERSE	TRANSVERSE
Engine Mounting - Front				
Engine Mounting - Rear	AR1185 Torque Rod Assy.	AR8478 (1.2) Support Mounting AR8524 (1.4, 1.6) Support Mounting AR8767 - Alt. (1.4) Lower Torque Rod AR1293 - Alt. (1.2) Support Mounting AR1294 - Alt. Support Mounting	AR8478 Lower Torque Rod AR1293 - Alt. Support Mounting	AR9576 Lower Torque Rod
Engine Mounting - Left	AR1155 (1.2T Auto., 1.6 GT, 1.8 RS) AR1182 (1.2T Man., 1.6)			AR1159
Engine Mounting - Right	AR1180 (1.2T) AR1190 (1.6) AR1191 (1.6 GT) AR1192 (1.8 RS)	AR1295 (1.4, 1.6) AR1296 (1.2) AR1297 - Alt. (1.6)	AR8651	AR1158
Engine Mounting - Other				
Transmission Mounting		AR8480 (1.6) AR8528 (1.2, 1.4)	AR8479 AR8480 - Alt.	
FRONT SUSPENSION				
Upper Control Arm Bush - Inner				
Upper Control Arm Bush - Outer				
Lower Control Arm Bush - Inner		AR8360 - Front	AR8474	AR8474
Lower Control Arm Bush - Outer		AR8218 - Rear	AR8474	AR8474
Shock Rubber - Front				
Stabilizer Bar Bush		AR6809	AR8475	AR8475
Stabilizer Link Grommet			AR8815 Stabilizer Link Pin Kit	AR8815 Stabilizer Link Pin Kit
Steering Coupling				
Steering Rack Mounting				
Strut Mounting	AR1141	AR1138 (Hole Spacing - 106mm) AR8160L AR8160R	AR8476	AR8476
Tension Rod Bush				
Miscellaneous				
REAR SUSPENSION				
Centre Bearing Rubber				
Exhaust Hanger - Middle				
Exhaust Hanger - Rear				
Lower Control Arm Bush - Inner				
Lower Control Arm Bush - Outer				
Propshaft Coupling				
Shackle Bush - Front				
Shackle Bush - Rear Upper				
Shackle Bush - Rear Lower				
Stabilizer Bar Bush	AR8467			
Stabilizer Link Grommet	AR1144L AR1144R Stabilizer Link - L/RHS			
Strut Mounting				
Miscellaneous			AR8477 Rear Axle Beam Bush	AR8477 Rear Axle Beam Bush

APPLICATIONS	RENAULT SCENIC I 1.4 RTE MPV - K4J750 1.6 RT, RXE MPV - K47M701/2 1.9dCi - F9Q732 2.0 RXE, RXi MPV - F3R796	RENAULT SCENIC II 1.6 Authentique, Expression - K4M761/782 1.9dCi Expression, Dynamique Dies. - F9Q812 2.0 Dynamique, Privilege MPV - F4R770/771 GRAND SCENIC II [05-10] 1.6 16V - K4M761/782 1.9dCi Privilege - JAO5, F9Q740 2.0 Expression MPV - F4R740/1	RENAULT SCENIC III 1.6 Expression MPV - K4M858 1.9dCi Dynamique MPV Dies. - F9Q870/72 GRAND SCENIC III 1.6dCi - R9M402 1.9dCi Dynamique MPV - F9Q870/72 2.0 - M9R615	RENAULT TRAFIC 1.9dCi MPV, 100 Panel Van Dies. - F9Q760
YEARS	98-02	02-10	2010-	05-07
Engine Configuration	TRANSVERSE	TRANSVERSE	TRANSVERSE	INLINE
Engine Mounting - Front				
Engine Mounting - Rear	AR6142 (1.6 Man.)	AR8478 Support Mounting (Scenic & Grand Scenic 2.0) AR8524 Support Mounting (Scenic 1.6) (Grand Scenic 1.6, 2.0) AR8526 Support Mounting (Scenic & Grand Scenic 1.9) AR8767 - Alt. Support Mounting (Scenic & Grand Scenic 1.6) AR1293 - Alt. Support Mounting (Scenic & Grand Scenic 1.6)	AR8535 Lower Torque Rod (Grand Scenic 1.6) AR8538 Lower Torque Rod (Scenic 1.6) AR8541 Lower Torque Rod (Scenic 1.9) (Grand Scenic 1.9, 2.0)	AR8463 - Lower
Engine Mounting - Left	AR6004		AR8537	AR8462
Engine Mounting - Right	AR6137 (1.6 Man.) AR6801 (2.0) AR8408 (1.4, 1.6 Auto., 1.9)	AR8239 (Scenic & Grand Scenic 2.0) AR8241 (Scenic & Grand Scenic 1.9) AR8527 Upper Torque Rod (Scenic & Grand Scenic) (1.9, 2.0) AR8470 (Scenic & Grand Scenic 1.6)	AR8533 (Scenic 1.6) AR8539 (Scenic 1.9) AR8540 Upper Torque Rod (Scenic 1.9) (Grand Scenic)	AR8462
Engine Mounting - Other				
Transmission Mounting	AR1248 (1.4, 1.6 Auto.) Lower Rear Support AR1249 (2.0) Lower Rear Support AR1253 (1.4, 1.6 Auto.) Lower Rear Support AR8144 (1.9) Lower Rear Support AR8144AB (1.9) Lower Rear Support	AR8480 (Scenic & Grand Scenic) (1.6 5-Spd. Man.) AR8528 (Scenic 1.9, 2.0) (Grand Scenic) (1.6 6-Spd. Man., 1.9, 2.0)		
FRONT SUSPENSION				
Upper Control Arm Bush - Inner				
Upper Control Arm Bush - Outer				
Lower Control Arm Bush - Inner	AR6353 - Front	AR6815 - Front	AR8529 - Front	AR8458 - Front
Lower Control Arm Bush - Outer	AR6353 - Rear	AR6819 - Rear	AR8530 - Rear	AR6098 - Rear
Shock Rubber - Front				
Stabilizer Bar Bush	AR6808 (ID: 23mm) AR6809 (ID: 24mm)	AR7141		AR8460
Stabilizer Link Grommet				
Strut Mounting	AR6765	AR6816	AR8531	AR8459
Tension Rod Bush				
Miscellaneous				
REAR SUSPENSION				
Lower Control Arm Bush - Inner				
Lower Control Arm Bush - Outer				
Shackle Bush - Front				
Shackle Bush - Rear Upper				
Shackle Bush - Rear Lower				
Stabilizer Bar Bush				
Stabilizer Link Grommet				
Strut Mounting				
Miscellaneous			AR8532 Rear Axle Beam Bush	AR8461 Rear Axle Beam Bush

APPLICATIONS	RENAULT TWINGO 1.2 Dynamique, '+' - D4F772 1.6 RS, Gordini - K4M854			
	YEARS	08-13		
	Engine Configuration	TRANSVERSE		
	Engine Mounting - Front			
	Engine Mounting - Rear	AR8544		
	Engine Mounting - Left	AR8543 (1.2) AR9596 (1.6)		
	Engine Mounting - Right	AR6003 (1.6) AR8542 (1.2)		
	Engine Mounting - Other			
	Transmission Mounting	AR8144AB (1.6) Lower Rear Support AR8545 Lower Rear Support		
	FRONT SUSPENSION			
Upper Control Arm Bush - Inner				
Upper Control Arm Bush - Outer				
Lower Control Arm Bush - Inner	AR6002			
Lower Control Arm Bush - Outer	AR6002			
Shock Rubber - Front				
Stabilizer Bar Bush	AR6808			
Stabilizer Link Grommet				
Steering Coupling				
Steering Rack Mounting				
Strut Mounting	AR6005			
Tension Rod Bush				
Miscellaneous				
REAR SUSPENSION				
Centre Bearing Rubber				
Exhaust Hanger - Middle				
Exhaust Hanger - Rear				
Lower Control Arm Bush - Inner				
Lower Control Arm Bush - Outer				
Propshaft Coupling				
Shackle Bush - Front				
Shackle Bush - Rear Upper				
Shackle Bush - Rear Lower				
Stabilizer Bar Bush				
Stabilizer Link Grommet				
Strut Mounting				
Miscellaneous				

APPLICATIONS	SEAT	SEAT ALTEA	SEAT IBIZA	SEAT IBIZA	SEAT LEON
		2.0 FSi - BVY, BVZ 2.0 TDi MPV - BMM	1.4 Sport - BXW 1.6 - BAH 2.0 - AZL, BBX	1.8T Cupra - BBU 1.9 TDi 96kw - ASZ, BLT, Cupra 118kw - BPX, BUK	2.0 FSi - BLR, BLY, BVZ 2.0 TDi - BKD, BMM, CFHC, CLCB 2.0T/FSi - BWA, BWJ, CDLD
YEARS		06-09	06-09	06-09	06-09
Engine Configuration		TRANSVERSE	TRANSVERSE	TRANSVERSE	TRANSVERSE
Engine Mounting - Front					
Engine Mounting - Rear		AR6896 (Man.) Support Mounting AR6898 (Auto.) Support Mounting	AR7050 (1.4, 1.6) Support Mounting AR7051 - Alt. (1.6, 2.0) Support Mounting	AR7066 Support Mounting AR8255 - Alt.(1.9) Support Mounting	AR6896 (Man.) Support Mounting AR6898 (Auto.) Support Mounting
Engine Mounting - Left					
Engine Mounting - Right		AR6923 (TDi) AR8042 (FSi)	AR7014 AR7008 - Alt. (1.6)	AR7014	AR6923 (TDi) AR8042 (FSi)
Engine Mounting - Other		AR6912 (5-Spd. Man.) Upper Subframe Bush AR6908 (6-Spd. Man. / Auto.) Upper Subframe Bush AR6906 (Man.) Lower Subframe Bush AR6909 (Auto.) Lower Subframe Bush			AR6912 (5-Spd. Man.) Upper Subframe Bush AR6908 (6-Spd. Man. / Auto.) Upper Subframe Bush AR6906 (Man.) Lower Subframe Bush AR6909 (Auto.) Lower Subframe Bush
Transmission Mounting		AR6895 - LHS (All Auto.) AR7010 - LHS (TDi Man.) AR6907 - LHS (Alt.) (TDi Man.) AR7222 - LHS (FSi Man.)	AR6916	AR6916	AR6895 - LHS (All Auto.) AR7222 - LHS (FSi Man.) AR7010 - LHS (TDi Man.) AR6907 - LHS (Alt.) (TDi Man.)
FRONT SUSPENSION					
Upper Control Arm Bush - Inner					
Upper Control Arm Bush - Outer					
Lower Control Arm Bush - Inner		AR6899 - Front	AR6911 - Front	AR6911 - Front	AR6899 - Front
Lower Control Arm Bush - Outer		AR6883 - Rear LHS AR6884 - Rear RHS	AR6913 - Rear (Insert)	AR6913 - Rear (Insert)	AR6883 - Rear LHS AR6884 - Rear RHS
Shock Rubber - Front					
Stabilizer Bar Bush		AR7023 (ID: 21mm) AR7041 (ID: 23mm) AR7126 (ID: 17mm)	AR7009 (ID: 18mm)	AR7009 (ID: 18mm)	AR7023 (ID: 21mm) AR7041 (ID: 23mm) AR7126 (ID: 17mm)
Steering Coupling					
Steering Rack Mounting		AR8250	AR8257	AR8257	AR8250
Strut Mounting		AR7129 (Excl. Bearing) AR7129B (Incl. Bearing)	AR6910	AR6910	AR7129 (Excl. Bearing) AR7129B (Incl. Bearing)
Miscellaneous					
REAR SUSPENSION					
Lower Control Arm Bush - Inner		AR6873			AR6873
Lower Control Arm Bush - Outer		AR6901			AR6901
Stabilizer Bar Bush		AR8251 (ID: 20mm) AR8252 (ID: 21mm)			AR8251 (ID: 20mm) AR8252 (ID: 21mm)
Strut Mounting		AR7197	AR7027	AR7027	AR7197
Miscellaneous		AR6930 Rear Axle Upper Arm - Inner L/RHS AR6931 Rear Axle Upper Arm - Outer L/RHS AR6957 Rear Axle Lateral Link Bush - Outer AR6958 Rear Axle Lateral Link Bush - Inner AR6962 Rear Axle Trailing Link Bush	AR7102 Rear Axle Beam Bush	AR7102 Rear Axle Beam Bush	AR6930 Rear Axle Upper Arm - Inner L/RHS AR6931 Rear Axle Upper Arm - Outer L/RHS AR6957 Rear Axle Lateral Link Bush - Outer AR6958 Rear Axle Lateral Link Bush - Inner AR6962 Rear Axle Trailing Link Bush

APPLICATIONS	SUZUKI	SUZUKI ALTO 1.0 - K10B	SUZUKI CELERIO 1.0 - K10B	SUZUKI JIMNY 4X4 1.3 - M13A	SUZUKI SWIFT 1.5i GL, GLS Hatch - M15A
		09-15	2015-	2008-	08-11
YEARS		09-15	2015-	2008-	08-11
Engine Configuration		TRANSVERSE	TRANSVERSE	TRANSVERSE	TRANSVERSE
Engine Mounting - Front					
Engine Mounting - Rear		AR9609	AR9609		AR9622
Engine Mounting - Left		AR9610	AR9610	AR9626	AR9624
Engine Mounting - Right		AR9611	AR9611	AR9626	AR9625
Engine Mounting - Other					
Transmission Mounting				AR9627	
		FRONT SUSPENSION			
Upper Control Arm Bush - Inner					
Upper Control Arm Bush - Outer					
Lower Control Arm Bush - Inner		AR9607 - Front	AR9607 - Front		AR8547 - Front
Lower Control Arm Bush - Outer		AR9608 - Rear	AR9608 - Rear		AR8548 - Rear
Shock Rubber - Front					
Stabilizer Bar Bush		AR9613	AR9613	AR9628	AR8549
Steering Coupling					
Steering Rack Mounting					
Strut Mounting		AR9612	AR9612		AR8550
Miscellaneous					
		REAR SUSPENSION			
Centre Bearing Rubber					
Exhaust Hanger - Middle					
Exhaust Hanger - Rear					
Lower Control Arm Bush - Inner					
Lower Control Arm Bush - Outer					
Propshaft Coupling					
Shackle Bush - Front					
Shackle Bush - Rear Upper					
Shackle Bush - Rear Lower					
Stabilizer Bar Bush					
Strut Mounting					
Miscellaneous					AR8551 Rear Axle Beam Bush

APPLICATIONS	SUZUKI SWIFT 1.2 GA, GL - K12M 1.4 GL, GLS, SE - K14B 1.6 - M16A	SUZUKI SX4 2.0 - J20A, J20B	SUZUKI GRAND VITARA 4X4 2.4	
	YEARS	2010-	08-14	2012-
Engine Configuration	TRANSVERSE	TRANSVERSE	TRANSVERSE	
Engine Mounting - Front		AR9629		
Engine Mounting - Rear	AR9614 (1.2, 1.4) AR9619 (1.6)	AR9630		
Engine Mounting - Left	AR9615 (1.2, 1.4) AR9620 (1.6)	AR9631	AR9869	
Engine Mounting - Right	AR9616 (1.2, 1.4) AR9621 (1.6)	AR9632	AR9869	
Engine Mounting - Other				
Transmission Mounting			AR9870	
FRONT SUSPENSION				
Upper Control Arm Bush - Inner				
Upper Control Arm Bush - Outer				
Lower Control Arm Bush - Inner	AR8552 - Rear	AR8552 - Rear	AR9872 - Front	
Lower Control Arm Bush - Outer	AR8548 - Front	AR8548 - Front	AR9873 - Rear	
Shock Rubber - Front				
Stabilizer Bar Bush	AR9618	AR9763 (J20A)	AR9874	
Stabilizer Link Grommet				
Steering Coupling				
Steering Rack Mounting				
Strut Mounting	AR9617	AR9617	AR9871	
Tension Rod Bush				
Miscellaneous				
REAR SUSPENSION				
Centre Bearing Rubber				
Exhaust Hanger - Middle	AR5262			
Exhaust Hanger - Rear	AR5262			
Upper Control Arm Bush - Inner		AR9875 - Front	AR9875 - Front	
Upper Control Arm Bush - Outer		AR9875 - Rear	AR9875 - Rear	
Lower Control Arm Bush - Inner				
Lower Control Arm Bush - Outer				
Propshaft Coupling				
Shackle Bush - Front				
Shackle Bush - Rear Upper				
Shackle Bush - Rear Lower				
Stabilizer Bar Bush				
Stabilizer Link Grommet				
Strut Mounting				
Miscellaneous	AR9774 Rear Axle Beam Bush			

APPLICATIONS	TATA	TATA BOLT 1.2T XMS, XT	TATA INDICA / VISTA 1.4 LEi, LSi, LX, LXi 1.4 TDi DLX, DL INDIGO 1.4 GLX, GLS, GSX S/W 1.4 TDi DLX S/W	TATA SAFARI 4X2, 4X4 2.2 CRDi GLS, GLX Dies.	TATA TELCOLINE 2.0 TD, LWB D/C P/up 483 Dies. - DLTC
		YEARS	2015-	2005-	2007-
Engine Configuration		TRANSVERSE	TRANSVERSE	INLINE	INLINE
Engine Mounting - Front			AR8797		
Engine Mounting - Rear		AR9704		AR9715 (4x2) AR9716 (4x4)	AR8411
Engine Mounting - Left		AR9705	AR8356 (1.4 Petrol Only)	AR9714	AR8409
Engine Mounting - Right		AR9706	AR8357	AR9714	AR8410
Engine Mounting - Other					
Transmission Mounting			AR8356 (1.4 Petrol Only)		
		FRONT SUSPENSION			
Upper Control Arm Bush - Inner				AR8412	AR8412
Upper Control Arm Bush - Outer				AR8412	AR8412
Lower Control Arm Bush - Inner		AR9707 - Front	AR8287 - Front	AR8413	AR8413
Lower Control Arm Bush - Outer		AR9708 - Rear	AR8288 - Rear	AR8413	AR8413
Shock Rubber - Front					
Stabilizer Bar Bush		AR9709	AR8800	AR8800 (4x2) AR9717 (4x4)	AR8800
Stabilizer Link Grommet			AR8414	AR8414	AR8414
Steering Coupling					
Steering Rack Mounting					
Strut Mounting		AR9710			
Miscellaneous					
		REAR SUSPENSION			
Centre Bearing Rubber					
Exhaust Hanger - Middle		AR9711		AR9718	
Exhaust Hanger - Rear		AR9711		AR9718	
Lower Control Arm Bush - Inner			AR8801		
Lower Control Arm Bush - Outer			AR8802		
Propshaft Coupling					
Shackle Bush - Front					
Shackle Bush - Rear Upper					
Shackle Bush - Rear Lower					
Stabilizer Bar Bush		AR9712		AR8800 (4x2) AR9719 (4x4)	
Stabilizer Link Grommet				AR9720	
Strut Mounting					
Miscellaneous		AR9713 Rear Axle Beam Bush			

APPLICATIONS	TOYOTA	TOYOTA AURIS	TOYOTA AURIS	TOYOTA AVANZA	TOYOTA AVANZA
		1.4 RT, RS - 4ZZ-FE 1.6 RT, XI, XS, Sport X, XR - 1ZR-FE 1.8 RS, RX - 2ZR-FAE 2.0D-4D RS, RX, Turbo, XD - 1AD-FTV	1.3 X - 1NR-FE 1.6 XS - 1ZR-FAE 1.8 HSD	1.3 P/van 1.3 S, SX MPV - K3-VE 1.5 SX, TX MPV - 3SZ-VE	1.3 S P/van - K3-VE 1.3 S, SX MPV - K3-VE 1.5 SX, TX MPV - 3SZ-VE
YEARS		07-13	2010-	06-12	12-16
Engine Configuration		TRANSVERSE	TRANSVERSE	TRANSVERSE	TRANSVERSE
Engine Mounting - Front		AR8328 (Excl. 2.0D) AR7564 (2.0D)	AR8328 (1.3, 1.6) AR9257 (1.8)		
Engine Mounting - Rear		AR8329 (Excl. 2.0D) AR8555 (2.0D)	AR8329 (1.3, 1.6) AR9258 (1.8)		
Engine Mounting - Left		AR8330 (Excl. 2.0D) AR8556 (2.0D)	AR8561 (1.3) AR9256 (1.6) AR9259 (1.8)	AR7687 (1.5) AR9042 (1.3)	AR9042
Engine Mounting - Right		AR8331 (1.4) AR8557 (1.6, 1.8) AR8553 (2.0D)	AR8560 (1.3) AR8557 (1.6) AR9260 (1.8)	AR7676 (1.5) AR9041 (1.3)	AR9041
Engine Mounting - Other					
Engine Stabilizer Rubber					
Transmission Mounting				AR7688	AR7688
		FRONT SUSPENSION			
Exhaust Hanger - Front					
Upper Control Arm Bush - Inner					
Upper Control Arm Bush - Outer					
Lower Control Arm Bush - Inner		AR8806 - Front	AR8806 - Front	AR8145 - Front	AR9043
Lower Control Arm Bush - Outer		AR8807 - Rear	AR8807 - Rear	AR8146 - Rear	AR9044
Shock Rubber - Front					
Stabilizer Bar Bush		AR8333 - LHS AR8334 - RHS	AR8333 - LHS AR8334 - RHS	AR7689	
Stabilizer Link Grommet					
Steering Coupling					
Steering Rack Mounting					
Strut Mounting		AR8332	AR8332	AR8558	AR9852
Tension Rod Bush					
Miscellaneous					
		REAR SUSPENSION			
Centre Bearing Rubber				AR8887	AR8887
Exhaust Hanger - Middle					
Exhaust Hanger - Rear					
Lower Control Arm Bush - Inner					
Lower Control Arm Bush - Outer					
Propshaft Coupling					
Shackle Bush - Front					
Shackle Bush - Rear Upper					
Shackle Bush - Rear Lower					
Stabilizer Bar Bush					
Stabilizer Link Assembly					
Strut Mounting					
Miscellaneous		AR8559 Rear Axle Beam Bush	AR8559 Rear Axle Beam Bush		AR9838 Lateral Link Bush - LHS AR9839 Lateral Link Bush - RHS AR9840 Upper Control Arm Link

APPLICATIONS	TOYOTA AVANZA	TOYOTA AVENSIS	TOYOTA AYGO	TOYOTA CAMRY I
	1.3 S, SX MPV - 1NR-VE 1.3 S P/van - 1NR-VE 1.5 SX, TX MPV - 2NR-VE	2.0 Advanced - 1AZ-FSE 2.2 D-4D Exclusive - 2AD-FTV 2.4 Exclusive - 2AZ-FSE	1.0 Fresh, Wild, Hatch - 1KR-FE	SXV10 220 Si, Sei 16V - 5S-FE SXV11 200i, Si, 16V - 3S-FE
YEARS	2015-	06-09	2011-	92-01
Engine Configuration	TRANSVERSE	TRANSVERSE	TRANSVERSE	TRANSVERSE
Engine Mounting - Front		AR7564 (2.0) AR8348 (2.4) AR8350 (2.2D)		AR6301 (Man.) AR6306 (Si Auto.)
Engine Mounting - Rear		AR8346 (2.0) AR8349 (2.4) AR8351 (2.2D)	AR8503	AR6300 (Man.) AR6303 (Auto.) (92-97)
Engine Mounting - Left	AR9841	AR8345 (2.0, 2.4) AR8352 (2.2D)	AR8504	
Engine Mounting - Right	AR9841	AR8347 (2.0, 2.4) AR8353 (2.2D)	AR8502	
Engine Mounting - Other				
Engine Stabilizer Rubber				AR6312 (Man.) AR6404A Stabilizer Rod Insert for AR6312 AR6313 (Si Auto.)
Transmission Mounting	AR9842			AR6307 (Man.) AR6394 (Si Auto.)
FRONT SUSPENSION				
Exhaust Hanger - Front				AR6319
Upper Control Arm Bush - Inner				
Upper Control Arm Bush - Outer				
Lower Control Arm Bush - Inner	AR9043 - Front	AR7590 - Front	AR8497 - Rear	AR8423 - Front
Lower Control Arm Bush - Outer	AR9044 - Rear	AR7591 - Rear	AR8498 - Front	AR8424 - Rear
Shock Rubber - Front				
Stabilizer Bar Bush	AR9845	AR8355	AR8499	AR6036 (92-97) AR6380 (97-01)
Stabilizer Link Grommet			AR9404 Complete Pin Kit	
Steering Coupling				AR6379
Steering Rack Mounting				AR6381 (92-97) AR6396 (97-01)
Strut Mounting	AR9852	AR8354	AR8500	AR6310
Tension Rod Bush				
Miscellaneous				
REAR SUSPENSION				
Centre Bearing Rubber	AR9846			
Exhaust Hanger - Middle				AR6319
Exhaust Hanger - Rear				AR6319
Lower Control Arm Bush - Inner				
Lower Control Arm Bush - Outer				AR6389
Propshaft Coupling				
Shackle Bush - Front				
Shackle Bush - Rear Upper				
Shackle Bush - Rear Lower				
Stabilizer Bar Bush				AR6390
Stabilizer Link Grommet				
Strut Mounting				AR6311L - LHS AR6311R - RHS
Miscellaneous	AR9847 Lateral Arm AR9848 Upper Control Arm Link		AR8501 Rear Axle Beam Bush	AR6314 Rear Adjustable Lateral Link Bush - Inner

APPLICATIONS	TOYOTA CAMRY I VCV10 300 SEi Quad Cam 5-Spd. - 3VZ-FE	TOYOTA CAMRY I MCV10 300 V6 SEi Quad Cam, Aluminum - 1MZ-FE	TOYOTA CAMRY II 2.4i GLi, XLi	TOYOTA CAMRY II MCV10 3.0 GLX Sedan V6 Quad Cam, Aluminum - 1MZ-FE
YEARS	92-97	97-01	01-06	01-06
Engine Configuration	TRANSVERSE	TRANSVERSE	TRANSVERSE	TRANSVERSE
Engine Mounting - Front	AR6401 (92-95) (Auto.) AR6402 (95-97) (Auto.)	AR6407		AR7539 (Man.) AR7540 (Auto.)
Engine Mounting - Rear	AR6304	AR6304	AR7546	
Engine Mounting - Left			AR7547 (Man.) AR7548 (Auto.)	
Engine Mounting - Right			AR7549	
Engine Mounting - Other				
Engine Stabilizer Rubber	AR6404 Stabilizer Rod Complete AR6404A Stabilizer Rod Insert	AR6410 Stabilizer Rod	AR7544 Stabilizer Link	AR6410 Stabilizer Link AR7544 Stabilizer Link with Damper
Transmission Mounting	AR6308 (Auto.) AR6400 (Man.)	AR6409	AR7541 (Auto.) AR7542 (Man.)	AR7541 (Auto.) AR7542 (Man.)
FRONT SUSPENSION				
Exhaust Hanger - Front	AR6319	AR6319		
Upper Control Arm Bush - Inner				
Upper Control Arm Bush - Outer				
Lower Control Arm Bush - Inner	AR8423 - Front	AR8423 - Front		
Lower Control Arm Bush - Outer	AR8424 - Rear	AR8424 - Rear		
Shock Rubber - Front				
Stabilizer Bar Bush	AR6036	AR6380	AR7550	AR7550
Stabilizer Link Grommet				
Steering Coupling	AR6379	AR6379		
Steering Rack Mounting	AR6381	AR6396		
Strut Mounting	AR6310	AR6310		AR7552L AR7552R
Tension Rod Bush				
Miscellaneous			See TR6106 Front Stabilizer Link Assembly	See TR6106 Front Stabilizer Link Assembly
REAR SUSPENSION				
Centre Bearing Rubber				
Exhaust Hanger - Middle	AR6319	AR6319		
Exhaust Hanger - Rear	AR6319	AR6319		
Lower Control Arm Bush - Inner				
Lower Control Arm Bush - Outer	AR6389	AR6389		
Propshaft Coupling				
Shackle Bush - Front				
Shackle Bush - Rear Upper				
Shackle Bush - Rear Lower				
Stabilizer Bar Bush	AR6390			
Stabilizer Link Grommet				
Strut Mounting	AR6311L - LHS AR6311R - RHS	AR6311L - LHS AR6311R - RHS		
Miscellaneous	AR6314 Rear Adjustable Lateral Link Bush - Inner	AR6314 Rear Adjustable Lateral Link Bush - Inner	AR7557 Rear Trailing Link AR7558 Rear Lateral Link No.1 - RHS AR7559 Rear Lateral Link No.1 - LHS AR7560 Rear Lateral Link No.2	AR7557 Rear Trailing Link AR7558 Rear Lateral Link No.1 - RHS AR7559 Rear Lateral Link No.1 - LHS AR7560 Rear Lateral Link No.2

APPLICATIONS	TOYOTA C-HR 1.2T - 8NR-FTS	TOYOTA CONDOR 1.8 Estate, TE Estate MPV Pet. - 2Y 2.0i Estate, TE, Estate MPV 2.4i Estate, TE, TX Estate MPV Pet. - 2RZ-E	TOYOTA CONDOR 4X2, 4X4 2.4i Estate, TX Estate MPV Pet., 5-Spd. Man. - 2RZ-E 3.0 SWB Estate, TX Estate MPV Dies. - 5L 3.0 Estate, TE Estate MPV Dies. 5-Spd. Man. - 5L	TOYOTA CONQUEST EE80 1.3 L, GL 12V 4-Spd. Man. - 2E-L
	YEARS	2017-	00-05	00-05
Engine Configuration	TRANSVERSE	INLINE	INLINE	TRANSVERSE
Engine Mounting - Front				AR5968
Engine Mounting - Rear	AR1173 AR1173I Insert			AR5966
Engine Mounting - Left	AR1174 AR1175 Damper	AR5337 (1.8) AR5366 (2.4i)	AR5408	AR5967
Engine Mounting - Right	AR1176	AR5337 (1.8) AR5366 (2.4i)	AR5408	AR5969
Engine Mounting - Other				
Engine Stabilizer Rubber				
Transmission Mounting		AR5340	AR5340 (4x2) AR6278 (4x4)	
FRONT SUSPENSION				
Exhaust Hanger - Front		AR6265	AR6265	AR5262
Upper Control Arm Bush - Inner		AR8133 - Front	AR8133 - Front	
Upper Control Arm Bush - Outer		AR8135 - Rear	AR8135 - Rear	
Lower Control Arm Bush - Inner		AR6064	AR6064 (4x2) AR8134 (4x4)	AR6167 - Front
Lower Control Arm Bush - Outer				AR6026 - Rear
Shock Rubber - Front		AR5092	AR5092	
Stabilizer Bar Bush		AR8136	AR8136 (4x2) AR8137 (4x4)	AR6016
Stabilizer Link Grommet				AR5081
Steering Coupling				
Steering Rack Mounting		AR6905	AR6905	AR6071 - RHS AR6431 - LHS
Strut Mounting	AR1177			AR6250
Tension Rod Bush		AR6058	AR6058	AR6019
Miscellaneous				
REAR SUSPENSION				
Centre Bearing Rubber		AR8132	AR8132 (4x2) AR8141 (4x4)	
Exhaust Hanger - Middle			AR7601 (4x4)	AR5262
Exhaust Hanger - Rear		AR6265	AR6265 (4x2) AR7601 (4x4)	AR5262
Lower Control Arm Bush - Inner				
Lower Control Arm Bush - Outer				
Propshaft Coupling				
Shackle Bush - Front		AR5065 (4)	AR5065 (4)	
Shackle Bush - Rear Upper		AR5065 (4)	AR5065 (4)	
Shackle Bush - Rear Lower		AR5065 (4)	AR5065 (4)	
Stabilizer Bar Bush				AR6028
Stabilizer Link Grommet				AR6037 Stabilizer Link Bush
Strut Mounting				AR5614
Miscellaneous				

APPLICATIONS	TOYOTA CONQUEST EE90 1.3 S, GS 12V 4-Spd. Man. - 2E-L 130 Zipp, Sport, Tazz, Sport 4-Spd., Tropique, Ruby, Edition, Mc Tazz, XE 12V 5-Spd. Man. - 2E 130 Carri P/van OHC 5-Spd. Man. - 2E	TOYOTA CONQUEST AE92 1.6 RSi Twincam 5-Spd. Man. - 4A-GE	TOYOTA CONQUEST AE92 1.6 LS 3-Spd. Auto. - 4A-F 1.6 RS, Sport DOHC 5-Spd. Man. - 4A-F	TOYOTA CONQUEST AE92 160 i RS DOHC 4-Spd. Auto. - 4A-FE
	YEARS	88-06	88-93	88-93
Engine Configuration	TRANSVERSE	TRANSVERSE	TRANSVERSE	TRANSVERSE
Engine Mounting - Front	AR5970	AR5970	AR5970 (Man.) AR5972 (Auto.)	AR5970
Engine Mounting - Rear	AR5978	AR5975	AR5975 (Man.) AR5978 (Auto.)	AR5978
Engine Mounting - Left	AR6232	AR6343	AR6232	
Engine Mounting - Right	AR5976	AR5973	AR5979	AR5986
Engine Mounting - Other	AR5977 - Centre	AR5974 - Centre		
Engine Stabilizer Rubber			AR6264 - Centre	
Transmission Mounting				
FRONT SUSPENSION				
Exhaust Hanger - Front	AR6295	AR5262	AR5262	
Upper Control Arm Bush - Inner				
Upper Control Arm Bush - Outer				
Lower Control Arm Bush - Inner	AR6168A (ID: 34mm) AR6168 - Front (ID: 35mm)	AR6168A (ID: 34mm) AR6168 - Front (ID: 35mm)	AR6168A (ID: 34mm) AR6168 - Front (ID: 35mm)	AR6168A (ID: 34mm) AR6168 - Front (ID: 35mm)
Lower Control Arm Bush - Outer	AR6030 - Rear	AR6030 - Rear	AR6030 - Rear	AR6030 - Rear
Shock Rubber - Front				
Stabilizer Bar Bush	AR6029	AR6029	AR6029	AR6029
Stabilizer Link Grommet	AR5081	AR5081	AR5081	AR5081
Steering Coupling				
Steering Rack Mounting	AR6071 - RHS AR6332 - LHS	AR6071 - RHS AR6072 - LHS	AR6071 - RHS AR6072 - LHS	AR6071 - RHS AR6072 - LHS
Strut Mounting	AR6249	AR6249	AR6249	AR6249
Tension Rod Bush				
Miscellaneous				
REAR SUSPENSION				
Centre Bearing Rubber				
Exhaust Hanger - Middle				
Exhaust Hanger - Rear				
Lower Control Arm Bush - Inner			AR6068 (Only Auto.)	
Lower Control Arm Bush - Outer				
Propshaft Coupling				
Shackle Bush - Front				
Shackle Bush - Rear Upper				
Shackle Bush - Rear Lower				
Shock Rubber - Rear				
Stabilizer Bar Bush	AR6031	AR6031 (89-93)	AR6031	AR6031
Stabilizer Link Grommet				
Strut Mounting	AR6284L AR6284R	AR6284L AR6284R	AR6284L AR6284R	AR6284L AR6284R
Miscellaneous	AR6204 Rear Lateral Link AR6205 Front Lateral Link AR6206 Rear Trailing Link AR6206I (Insert Only) Rear Trailing Link Bush	AR6204 Rear Lateral Link AR6205 Front Lateral Link AR6206 Rear Trailing Link AR6206I (Insert Only) Rear Trailing Link Bush	AR6169 (92-93) Arm Assembly - Rear AR6204 Rear Lateral Link AR6205 Front Lateral Link AR6206 Rear Trailing Link AR6206I (Insert Only) Rear Trailing Link Bush	AR6204 Rear Lateral Link AR6205 Front Lateral Link AR6206 Rear Trailing Link AR6206I (Insert Only) Rear Trailing Link Bush

APPLICATIONS	TOYOTA CONQUEST AE93 180 i RS, RSi, Sport DOHC 5-Spd. Man. - 7A-FE	TOYOTA CONQUEST AE92 160 i RS, Sport, RSE DOHC 5-Spd. Man. - 4A-FE 160 i RSE, XE DOHC 5-Spd. Man. - 4A-FE TAZZ 160 i RSE, XE DOHC 5-Spd. Man. - 4A-FE	TOYOTA COROLLA TE72 1.8 RWD GLS, SE OHV 5-Spd. Man., 3/4-Spd. Auto. - 3T	TOYOTA COROLLA AE80 1.3 FWD GL 8V 4-Spd. Man. - 2A-L EE80 1.3 FWD L, GL OHC 4-Spd. Man. - 2E-L AE82 1.6 L - 4A-GE
	YEARS	93-96	93-06	80-85
Engine Configuration	TRANSVERSE	TRANSVERSE	INLINE	TRANSVERSE
Engine Mounting - Front	AR6291	AR6291		AR5965 (AE80) AR5968 (AE82, EE80)
Engine Mounting - Rear	AR6290	AR6290		AR6014 (AE80) AR5966 (AE82, EE80)
Engine Mounting - Left	AR6289	AR6289	AR5992	AR5967
Engine Mounting - Right	AR5986	AR5986	AR5992	AR6337 (AE80) AR5969 (AE82, EE80)
Engine Mounting - Other				
Engine Stabilizer Rubber				
Transmission Mounting			AR5338 (Man.) AR5339 (Auto.)	AR5963 (AE80 Only)
FRONT SUSPENSION				
Exhaust Hanger - Front			AR5069	AR5262
Upper Control Arm Bush - Inner				
Upper Control Arm Bush - Outer				
Lower Control Arm Bush - Inner	AR6168A (ID: 34mm) AR6168 - Front (ID: 35mm)	AR6168A (ID: 34mm) AR6168 - Front (ID: 35mm)	AR6017	AR6167 - Front
Lower Control Arm Bush - Outer	AR6030 - Rear	AR6030 - Rear		AR6026 - Rear
Shock Rubber - Front				
Stabilizer Bar Bush	AR6029	AR6029	AR5332	AR6016
Stabilizer Link Grommet			AR6326	AR5081
Steering Coupling				
Steering Rack Mounting	AR6071 - RHS AR6072 - LHS (P/S) AR6332 - LHS (M/S)	AR6071 - RHS AR6332 - LHS		AR6071 - RHS AR6072 - LHS
Strut Mounting	AR6293	AR6249	AR6327	AR6250
Tension Rod Bush			AR6328 (1980) AR6329 (81-85)	AR6329
Miscellaneous				
REAR SUSPENSION				
Centre Bearing Rubber			AR5296	
Exhaust Hanger - Middle			AR5069	AR5262
Exhaust Hanger - Rear			AR5069	AR5262
Lower Control Arm Bush - Inner				AR6068
Lower Control Arm Bush - Outer				
Propshaft Coupling				
Shackle Bush - Front			AR6023 (2)	
Shackle Bush - Rear Upper			AR6022 (4)	
Shackle Bush - Rear Lower			AR6022A (2)	
Shock Rubber - Rear			AR22 - Top Lower AR5092 - Top Upper	
Stabilizer Bar Bush	AR6031	AR6031		AR6028
Stabilizer Link Grommet			AR6326	AR6037
Strut Mounting		AR6284L AR6284R		AR5614
Miscellaneous	AR6169 (RSi) Rear Lateral Link AR6172 Trailing Link AR6204 Rear Lateral Link AR6206 Rear Trailing Link AR6206I (Insert Only) Rear Trailing Link Bush	AR6204 Rear Lateral Link AR6205 Front Lateral Link AR6206 Rear Trailing Link AR6206I (Insert Only) Rear Trailing Link Bush		

APPLICATIONS	TOYOTA COROLLA AE92	TOYOTA COROLLA EE90	TOYOTA COROLLA AE92	TOYOTA COROLLA AE93
	1.6 GL, GLS, Exec., Sprinter, GLE, Sport. - 4A-F DOHC, GLi, GLi Exec. - 4A-GE DOHC, 5-Spd. Man., 3-Spd. Auto., GL, GLX DOHC 4-Spd. Auto. - 4A-F	1.3 FWD L, GL, GLE, Sprinter OHC 4/5-Spd. Man. - 2E, 2E-L	160i GL, GLE, Sprinter, DOHC 5-Spd. Man., 4-Spd. Auto. - 4A-FE	180i FWD GL, GLE, Sprinter, GSE, GSX, DOHC Man., Auto. - 7A-FE
YEARS	88-93	88-96	92-96	93-96
Engine Configuration	TRANSVERSE	TRANSVERSE	TRANSVERSE	TRANSVERSE
Engine Mounting - Front	AR5970 (GL, GLE, GLS) AR5972 (Others)	AR5970	AR5970 (Auto.) AR6291 (Man.)	AR5970 (Auto.) AR6291 (Man.)
Engine Mounting - Rear	AR5615 (GLX) AR5975 (GLE, GLS) AR5978 (GL, GLi)	AR5978	AR5978 (Auto.) AR6290 (Man.)	AR5978 (Auto.) AR6290 (Man.)
Engine Mounting - Left	AR6232 (GL, GLS Exec.) AR6342 (GLX) AR6343 (Others)	AR6232	AR6289 (Man.)	AR6289 (Man.)
Engine Mounting - Right	AR5973 (88-89) AR5979 (4A-F, 4A-GE) AR6363 (89-93)	AR5976	AR5986	AR5986
Engine Mounting - Other	AR5974 - Centre	AR5977 - Centre	AR5974 - Centre	
Engine Stabilizer Rubber	AR6264 (GL, Auto.)		AR6264 (Auto.)	
Transmission Mounting				
FRONT SUSPENSION				
Exhaust Hanger - Front	AR5262	AR6295		
Upper Control Arm Bush - Inner				
Upper Control Arm Bush - Outer				
Lower Control Arm Bush - Inner	AR6168A (ID: 34mm) AR6168 - Front (ID: 35mm)	AR6168A (ID: 34mm) AR6168 - Front (ID: 35mm)	AR6168A (ID: 34mm) AR6168 - Front (ID: 35mm)	AR6168A (ID: 34mm) AR6168 - Front (ID: 35mm)
Lower Control Arm Bush - Outer	AR6030 - Rear	AR6030 - Rear	AR6030 - Rear	AR6030 - Rear
Shock Rubber - Front				
Stabilizer Bar Bush	AR6029	AR6029	AR6029	AR6029
Stabilizer Link Grommet	AR5081	AR5081	AR5081	
Steering Coupling				
Steering Rack Mounting	AR6071 - RHS AR6332 - LHS		AR6071 - RHS AR6332 - LHS	AR6071 - RHS AR6332 - LHS
Strut Mounting	AR6249 (GL, GLS Exec.) AR6293 (Others)	AR6249	AR6249	AR6249 AR6293 (GSX Only)
Tension Rod Bush				
Miscellaneous				
REAR SUSPENSION				
Centre Bearing Rubber				
Exhaust Hanger - Middle				
Exhaust Hanger - Rear	AR6175		AR6175	
Lower Control Arm Bush - Inner				
Lower Control Arm Bush - Outer				
Propshaft Coupling				
Shackle Bush - Front				
Shackle Bush - Rear Upper				
Shackle Bush - Rear Lower				
Stabilizer Bar Bush	AR6031	AR6031	AR6031	AR6031
Stabilizer Link Grommet				
Strut Mounting	AR6284L AR6284R	AR6284L AR6284R	AR6284L AR6284R	AR6284L AR6284R
Miscellaneous	AR6204 Rear Lateral Link AR6205 Front Lateral Link AR6206 Rear Trailing Link AR6206I (Insert Only) Rear Trailing Link Bush	AR6204 Rear Lateral Link AR6205 Front Lateral Link AR6206 Rear Trailing Link AR6206I (Insert Only) Rear Trailing Link Bush	AR6204 Rear Lateral Link AR6205 Front Lateral Link AR6206 Rear Trailing Link AR6206I (Insert Only) Rear Trailing Link Bush	AR6169 (GSX Only) Rear Lateral Link AR6204 Rear Lateral Link AR6205 Front Lateral Link AR6206 Rear Trailing Link AR6206I (Insert Only) Rear Trailing Link Bush

APPLICATIONS	TOYOTA COROLLA AE111 160i GL, GLE P/S DOHC, 5-Spd. Man., 4-Spd. Auto. - 4A-FE, RSi, RXi DOHC 5/6-Spd. Man. - 4A-GE	TOYOTA COROLLA EE110 130 FWD GLE OHC 5-Spd. Man. - 2E	TOYOTA COROLLA AE112 180i GLE, GSE DOHC, 5-Spd. Man., 4-Spd. Auto. - 7A-FE	TOYOTA COROLLA AE111 160i GL, GLE DOHC, 5-Spd. Man., 4-Spd. Auto. - 4A-FE, Si, RXi, DOHC 5/6-Spd. Man. - 4A-GE
YEARS	96-99	96-02	96-02	99-02
Engine Configuration	TRANSVERSE	TRANSVERSE	TRANSVERSE	TRANSVERSE
Engine Mounting - Front	AR6226	AR6226	AR6226 (96-99) AR5972 (99-02)	AR5972 (GL, GLE)
Engine Mounting - Rear	AR6230 (RSi, RXi Man.) AR6231 (GL, GLE Auto.)	AR6230	AR6230	AR6230 (Man.) AR6231 (GL, GLE Auto.)
Engine Mounting - Left	AR6229 (GL, GLE) (96-98) AR6289 (RSi, RXi) (1997-) AR6349 (RSi, RXi) (1998-)	AR6207	AR6229 (96-98) AR5980 (98-99) AR5980 (Man.) (99-02) AR6347 (Auto.) (99-02)	AR5980 (GL, GLE Man.) AR6347 (GL, GLE Auto.) AR6349 (RXi) (Early 1999) AR6350 (Late 1999-)
Engine Mounting - Right	AR6228 (GL, GLE) AR6351 (RSi, RXi)	AR6227 AR6351 - Alt.	AR6351	AR6228 (GL, GLE) AR6351 (RXi)
Engine Mounting - Other				
Engine Stabilizer Rubber				
Transmission Mounting		AR5977		
FRONT SUSPENSION				
Exhaust Hanger - Front				
Upper Control Arm Bush - Inner				
Upper Control Arm Bush - Outer				
Lower Control Arm Bush - Inner	AR6168A (ID: 34mm) AR6168 - Front (ID: 35mm)	AR6168A (ID: 34mm) AR6168 - Front (ID: 35mm)	AR6168A (ID: 34mm) AR6168 - Front (ID: 35mm)	AR6168A (ID: 34mm) AR6168 - Front (ID: 35mm)
Lower Control Arm Bush - Outer	AR6455 - Rear	AR6455 - Rear	AR6455 - Rear	AR6455 - Rear
Shock Rubber - Front				
Stabilizer Bar Bush	AR6296	AR6296	AR6296	AR6296
Stabilizer Link Grommet				
Steering Coupling				
Steering Rack Mounting	AR6072 - LHS AR6297 - RHS	AR6071 - RHS AR6332 - LHS	AR6072 - LHS AR6297 - RHS	AR6072 - LHS AR6297 - RHS
Strut Mounting	AR6293 (GL, GLE) AR6336 (RSi, RXi)	AR6293 (GLE)	AR6293 (96-99) AR6336 (99-02)	AR6336
Tension Rod Bush				
Miscellaneous				
REAR SUSPENSION				
Centre Bearing Rubber				
Exhaust Hanger - Middle	AR6366	AR6366		AR6366
Exhaust Hanger - Rear	AR6366	AR6366		AR6366
Lower Control Arm Bush - Inner				
Lower Control Arm Bush - Outer				
Propshaft Coupling				
Shackle Bush - Front				
Shackle Bush - Rear Upper				
Shackle Bush - Rear Lower				
Stabilizer Bar Bush	AR6031	AR6031	AR6031	AR6031
Stabilizer Link Grommet				
Strut Mounting			AR6284L AR6284R	
Miscellaneous				

APPLICATIONS	TOYOTA COROLLA F11	TOYOTA COROLLA E150	TOYOTA COROLLA E180	TOYOTA COROLLA QUEST
	140i GLE, GLS, Sprinter 5-Spd. Man. - 4ZZ-FE KS1 160i GLE, GLS, GSX, Sprinter - 3ZZ-FE GF2 180i GLE, GLS, GSX, Sprinter DOHC - 1ZZ-FE	1.3 Advanced, Impact, Professional, 6-Spd. Man. - 1NR-FE 1.4 VVT-i Advanced, Professional 5-Spd. Man. - 4ZZ-FE 1.6 Advanced, Professional, Sprinter, 6-Spd. Man., 4-Spd. Auto. - 1ZR-FE 1.8 Advanced, Exclusive, 6-Spd. Man., 4-Spd. Auto. - 2ZR-FE 2.0 Sprinter, Exclusive 6-Spd. Man./Auto., - 3ZR-FE 2.0D-4D Advanced, Exclusive 6-Spd. Man. - 1AD-FTV	1.3 Esteem, Prestige - 1NR-FE 1.4D-4D Esteem, Prestige - 1ND-TV 1.6 Esteem, Prestige, + - 1ZR-FE 1.8 Exclusive, Prestige - 2ZR-FE	1.6 - 1ZR-FE
YEARS	02-08	07-13	14-19	2014-
Engine Configuration	TRANSVERSE	TRANSVERSE	TRANSVERSE	TRANSVERSE
Engine Mounting - Front	AR7564 (160i, 180i) AR7565 (140i)	AR8328 (Excl. 2.0D-4D) AR7564 (2.0D-4D)	AR8328 (1.3, 1.4D, 1.6 Man.) AR1243 (1.6 CVT, 1.8)	AR8328
Engine Mounting - Rear	AR7563	AR8329 (Excl. 2.0D-4D) AR8555 (2.0D-4D)	AR8329 (1.3, 1.4D, 1.6 Man.) AR1245 (1.6 CVT, 1.8)	AR8329
Engine Mounting - Left	AR7569	AR8330 (Excl. 1.3, 2.0D-4D) AR8556 (2.0D-4D) AR8561 (1.3) AR9256 (Excl. 1.3, 2.0D-4D)	AR1239 (1.3) AR1242 (1.4D) AR1246 (1.6 CVT, 1.8) AR1247 (1.6 Man.)	AR9256
Engine Mounting - Right	AR7561	AR8331 (1.4) AR8557 (1.6) AR8553 (2.0 Dies.) AR8560 (1.3)	AR1237 (1.3) AR1240 (1.4D) AR1244 (1.6, 1.8)	AR8557
Engine Mounting - Other				
Engine Stabilizer Rubber				
Transmission Mounting				
FRONT SUSPENSION				
Exhaust Hanger - Front				
Lower Control Arm Bush - Inner	AR7590 - Front	AR8806 - Front	AR8806 - Front	AR8806 - Front
Lower Control Arm Bush - Outer	AR7591 - Rear	AR8807 - Rear	AR8807 - Rear	AR8807 - Rear
Shock Rubber - Front				
Stabilizer Bar Bush	AR7571	AR8333 - LHS AR8334 - RHS	AR8333 - LHS AR8334 - RHS	AR8333 - LHS AR8334 - RHS
Stabilizer Link Grommet				
Steering Coupling	AR7572			
Steering Rack Mounting				
Strut Mounting	AR7573	AR8332	AR8332	AR8332
Tension Rod Bush				
Miscellaneous				
REAR SUSPENSION				
Exhaust Hanger - Middle				AR9737
Exhaust Hanger - Rear				AR7644
Lower Control Arm Bush - Inner				
Lower Control Arm Bush - Outer				
Shackle Bush - Front				
Shackle Bush - Rear Upper				
Shackle Bush - Rear Lower				
Stabilizer Bar Bush				
Stabilizer Link Grommet				
Strut Mounting				
Miscellaneous	AR7576 Rear Axle Beam Bush	AR8559 Rear Axle Beam Bush	AR8559 Rear Axle Beam Bush	AR8559 Rear Axle Beam Bush

APPLICATIONS	TOYOTA COROLLA VERSO 1.6S, SX, TX MPV 5/6-Spd. Man. - 3ZZ-FE 1.8 SX, TX MPV 5/6-Spd. Man. - 1ZZ-FE	TOYOTA COROLLA VERSO 2.0D-4D TX MPV, 6-Spd. Man. - 1CD-FTV	TOYOTA VERSO 1.6 - 1ZR-FAE 1.8 - 2ZR-FAE 2.0D-4D - 1AD-FTV	TOYOTA CRESSIDA GX71 2.0 GLi6 5-Spd. Man., Executive DOHC - 1G-E, I.R.S. 4-Spd. Auto. - 1G-FE
	YEARS	04-09	04-09	09-14
Engine Configuration	TRANSVERSE	TRANSVERSE	TRANSVERSE	INLINE
Engine Mounting - Front	AR7564 AR7565 - Alt.	AR8564	AR7564 (2.0) AR9280 (1.6, 1.8) AR9287 (1.8 CVT)	
Engine Mounting - Rear	AR7563	AR8565	AR9281 (1.6, 1.8) AR9288 (1.8 CVT) AR9290 (2.0)	
Engine Mounting - Left	AR7569	AR8566	AR9256 (1.6, 1.8) AR9289 (1.8 CVT) AR9291 (2.0)	AR5985 (86-89) AR7526 (89-92)
Engine Mounting - Right	AR7561	AR8563	AR8553 (2.0) AR8557 (1.6, 1.8)	AR5985 (86-89) AR7526 (89-92)
Engine Mounting - Other				
Engine Stabilizer Rubber				
Transmission Mounting				AR5339
FRONT SUSPENSION				
Exhaust Hanger - Front				
Upper Control Arm Bush - Inner				
Upper Control Arm Bush - Outer				
Lower Control Arm Bush - Inner	AR8806 - Front	AR8806 - Front	AR8806 - Front	AR6017
Lower Control Arm Bush - Outer	AR8807 - Rear	AR8807 - Rear	AR8807 - Rear	
Shock Rubber - Front				
Stabilizer Bar Bush	AR7007	AR7007	AR9284 - LHS AR9285 - RHS	AR6341
Stabilizer Link Grommet				AR22 (ID: 10mm)
Steering Coupling				
Steering Rack Mounting				AR6073 - RHS AR6074 - LHS
Strut Mounting	AR8567	AR8568	AR9286	AR6375
Tension Rod Bush				
Miscellaneous				
REAR SUSPENSION				
Centre Bearing Rubber				AR5312
Exhaust Hanger - Middle				AR5262
Exhaust Hanger - Rear				AR5069
Lower Control Arm Bush - Inner				AR6043
Lower Control Arm Bush - Outer				AR6042
Propshaft Coupling				
Shackle Bush - Front				
Shackle Bush - Rear Upper				
Shackle Bush - Rear Lower				
Shock Rubber - Rear				AR22 - Top Lower AR5092 - Top Upper
Stabilizer Bar Bush				
Stabilizer Link Grommet				AR6326
Strut Mounting				
Miscellaneous	AR8559 Rear Axle Beam Bush	AR8559 Rear Axle Beam Bush	AR8559 Rear Axle Beam Bush	

APPLICATIONS	TOYOTA CRESSIDA MX73 2.8i RSi, RSi Exec. DOHC 5-Spd. Man., 4-Spd. Auto. - 5M-GE MX75 3.0 GLS 5-Spd. Man., ECT 3.0i I.R.S. 24V DOHC 4-Spd. Auto. - 7M-GE	TOYOTA CRESSIDA RX70 2.0 GL, GLX, GL S/W - 21R, RX72 2.4 GLE, GL S/W, GLE S/W - 22R RX73 I.R.S. GL, GLE 4/5-Spd. Man./Auto. - 22R	TOYOTA CRESSIDA YX72 2.0 GS, GS Exec., GSE OHV 5-Spd. Man. - 3Y	TOYOTA DYNA YU80 2.0 - 3Y YU81/2/5/210 2.2 - Y RU85 2.4 - 22R BU81, OWU90 3.0 - 11B, BU101/41/211 3.7 - 14B OWU95 3.8 - ADE314N CWU90/95 4.0 - ADE364C, NBU91/96, TBU91/96, ADE364C/N
	YEARS	86-92	87-92	89-92
Engine Configuration	INLINE	INLINE	INLINE	INLINE
Engine Mounting - Front				
Engine Mounting - Rear				
Engine Mounting - Left	AR7526 (3.0)	AR5987	AR5369	
Engine Mounting - Right	AR7526 (3.0)	AR5987	AR5369	
Transmission Mounting	AR5339 (2.8) AR6070 (3.0)	AR5340	AR5340	
FRONT SUSPENSION				
Exhaust Hanger - Front	AR5262	AR5069	AR5069	
Upper Control Arm Bush - Inner			AR6017	
Upper Control Arm Bush - Outer				
Lower Control Arm Bush - Inner	AR6017	AR6017		
Lower Control Arm Bush - Outer				
Shock Rubber - Front				
Stabilizer Bar Bush	AR6341	AR6341 (RX72/73) AR6442 (RX70)	AR6341	
Stabilizer Link Grommet	AR22 (ID: 10mm)	AR22 (ID: 10mm) (RX70/72/73) AR6326 (RX70)	AR22 (ID: 10mm)	
Steering Coupling				
Steering Rack Mounting	AR6073 - RHS AR6074 - LHS	AR6073 - RHS AR6074 - LHS	AR6073 - RHS AR6074 - LHS	
Strut Mounting	AR6375	AR6375	AR6375	
Tension Rod Bush				
Miscellaneous				
REAR SUSPENSION				
Centre Bearing Rubber		AR5298 (RX70) AR5312 (RX72/73)	AR5312	AR5301
Exhaust Hanger - Middle	AR5262	AR5262	AR5262	
Exhaust Hanger - Rear	AR5069	AR5069	AR5069	
Lower Control Arm Bush - Inner	AR6043	AR6043 (RX72/73)		
Lower Control Arm Bush - Outer	AR6042	AR6042 (RX72/73)		
Propshaft Coupling				
Shackle Bush - Front				
Shackle Bush - Rear Upper				
Shackle Bush - Rear Lower				
Shock Rubber - Rear	AR22 - Top Lower AR5092 - Top Upper	AR22 - Top Lower AR5092 - Top Upper	AR5939	AR5939
Stabilizer Bar Bush				
Stabilizer Link Grommet	AR6373 (2.8)	AR6326	AR6037 Stabilizer Link Bush AR6326	
Strut Mounting				
Miscellaneous			AR6367 Lateral Control Arm Bush - Outer (15mm) AR6368 Lateral Control Arm Bush - Outer (12mm) AR6372 Lateral Control Arm Bush - Inner	

APPLICATIONS	TOYOTA ETIOS 1.5 Xi - 2NR-FE 1.5 Xs Cross	TOYOTA FORTUNER 4X2, 4X4 3.0D-4D, Raised Body - 1KD-FTV, 5LE, 4x4 4.0 V6, Raised Body Pet. - 1GR-FE	TOYOTA FORTUNER 4X2, 4X4 2.5D-4D 4-Spd. Auto., 5-Spd. Man. - 2KD-FTV 4x2 3.0D-4D DSi 4-Spd. Auto. - 1KD-FTV, 4x2, 4x4, 5-Spd. Man. - 5LE 4x4 4.0 5-Spd. Auto. - 1GR-FE 4x4	TOYOTA FORTUNER 4X2, 4X4 2.4TD RB - 2GD-FTV 4x2 2.7 VVTi RB - 2TR-FE 4x2 2.8TD - 1GD-FTV 4x4 2.8TD RB - 1GD-FTV 4x2 3.0D-4D 5-Spd. Auto., 6-Spd. Man. - 1KDFTV 4x4 4.0 V6 - 1GR-FE 4x4
YEARS	2012-	06-11	11-16	2015-
Engine Configuration	TRANSVERSE	INLINE	INLINE	INLINE
Engine Mounting - Front				
Engine Mounting - Rear	AR8880			
Engine Mounting - Left	AR8882	AR7592 (3.0) AR7595 (3.0 5LE, 4.0)	AR7592 (2.5, 3.0) AR7595 (3.0 5LE, 4.0)	AR9771 (3.0D-4D) AR9781 (2.4, 2.8) AR9796 (2.7) AR9894 (4.0)
Engine Mounting - Right	AR8881	AR7592 (3.0) AR7595 (3.0 5LE, 4.0)	AR7592 (2.5, 3.0) AR7595 (3.0 5LE, 4.0)	AR9771 (3.0D-4D) AR9781 (2.4, 2.8) AR9796 (2.7) AR9894 (4.0)
Transmission Mounting		AR7597 (3.0 4x4) AR8858 (4.0) AR9768 (3.0 Man. 4x2) AR9793 (3.0 Auto. 4x2)	AR7597 (3.0 Man./Auto. 4x4) AR8858 (4.0 4x4) AR9768 (2.5, 3.0 Man. 4x2) AR9793 (2.5, 3.0 Auto. 4x2)	AR9784
FRONT SUSPENSION				
Exhaust Hanger - Front		AR7600	AR7600	
Upper Control Arm Bush - Inner		AR8570 - Front (ID: 15mm)	AR8570 - Front	AR8570 - Front
Upper Control Arm Bush - Outer		AR8570 - Rear (ID: 15mm)	AR8570 - Rear	AR8570 - Rear
Lower Control Arm Bush - Inner	AR8883	AR8571 - Front (ID: 14.5mm)	AR8571 - Front	AR9785 - Front
Lower Control Arm Bush - Outer	AR8884	AR8572 - Rear (ID: 14.5mm)	AR8572 - Rear	AR9786 - Rear
Shock Rubber - Front			AR7629	AR9788
Stabilizer Bar Bush	AR8885	AR7605	AR7606	AR9787
Stabilizer Link Grommet	AR9404 Complete Pin Kit	AR7608		
Steering Coupling				
Steering Rack Mounting				
Strut Mounting	AR8886	AR7602 (4x2) AR7603 (4x4)	AR7603	AR9789
Tension Rod Bush				
Miscellaneous			AR9808 Bump Stop Rubber	AR9799 (Excl. 3.0D-4D) Brake Pedal Rubber AR9808 Bump Stop Rubber
REAR SUSPENSION				
Centre Bearing Rubber		AR7618	AR7618	AR9766
Exhaust Hanger - Middle		AR7601	AR7601	
Exhaust Hanger - Rear	AR9736	AR7601	AR7601	
Shackle Bush - Front				
Shackle Bush - Rear Upper				
Shackle Bush - Rear Lower				
Shock Rubber - Rear		AR7612	AR7612	AR9811 (Excl. 3.0D-4D)
Stabilizer Bar Bush				AR9790
Stabilizer Link Grommet				
Miscellaneous	AR9735 Rear Axle Beam Bush	AR8573 Rear Lateral Link AR8574 (2) Rear Lateral Link Bush AR9770 Trailing Arm Bush		AR9809 Trailing Arm Bush AR9816 Lateral Arm

APPLICATIONS	TOYOTA HIACE	TOYOTA HIACE	TOYOTA HILUX	TOYOTA HILUX
	YH50 1.8 SWB P/van 4-Spd. Man. Pet. - 2Y YH60 1.8 LWB LS Wagon, P/van 5-Spd. Man. Pet. - 2Y	YH53 2.2 SWB LS, GLX, GLX Exec. Wagon, Super10 - 4Y YH63 2.2 LWB Super16, SuperT, P/van, Siyaya Pet. 5-Spd. Man., 4-Spd. Auto. - 4Y	LN50 2.2 SWB P/up Dies. 4-Spd. Man. - L LN55 2.2 LWB P/up Dies. - L YN58 2.2 LWB Raider, SRX P/up Pet. - 4Y	RN58 2.4 LWB S, S D/cab, SR D/cab, SRX, Raider Pet. - 22R LN51 2.4 SWB S D/cab, Raider P/up Dies. - 2L LN56 2.4 LWB Raider D/cab P/up Dies. - 2L
YEARS	83-91	86-09	84-98	84-98
Engine Configuration	INLINE	INLINE	INLINE	INLINE
Engine Mounting - Front				
Engine Mounting - Rear				
Engine Mounting - Left	AR5337 (YH50) AR5369 (YH60)	AR5369	AR5366 (YN58) AR5408 (LN50/LN55)	AR5337 (RN58) AR5408 (LN51/56)
Engine Mounting - Right	AR5337 (YH50) AR5369 (YH60)	AR5369	AR5366 (YN58) AR5408 (LN50/LN55)	AR5337 (RN58) AR5408 (LN51/56)
Engine Mounting - Other				
Transmission Mounting	AR5363	AR5363	AR5335 (LN50) AR5340 (LN55/YN58)	AR5340
FRONT SUSPENSION				
Exhaust Hanger - Front	AR5262	AR5262	AR5262 (YN58)	AR5262
Upper Control Arm Bush - Inner	AR6051 - Front	AR6051 - Front		
Upper Control Arm Bush - Outer	AR6052 - Rear	AR6052 - Rear		
Lower Control Arm Bush - Inner	AR6053	AR6053 (86-95) AR6425 (95-09)	AR6059	AR6059
Lower Control Arm Bush - Outer				
Shock Rubber - Front	AR5092	AR5092	AR22	AR22
Stabilizer Bar Bush	AR5368	AR5368 (86-92) AR6419 (92-97) AR6430 (97-09)	AR5331 (SRX YN58) AR6060 (LN50/55)	AR5331 (LN51/56) AR6060 (RN58)
Stabilizer Link Grommet	AR22	AR22	AR5436	AR5436
Steering Coupling	AR6050	AR6050	AR6057	AR6057
Steering Rack Mounting		AR6426 - LHS (92-09) AR6427 - RHS (92-09) AR6428 - RHS (P/S)		
Strut Mounting				
Tension Rod Bush	AR6415	AR6415 (86-88) AR6416 (88-09)	AR6055 (YN58) AR6058 (LN50/LN55)	AR6055 (RN58) AR6058 (LN51/56)
Miscellaneous	AR5411 Gear Link Grommet AR6048 Brake & Clutch Pedal Rubber AR6049 Accelerator Pedal Rubber ARTOY5 Short Caliper Link Pin Kit ARTOY6 Long Caliper Link Pin Kit	AR5411 Gear Link Grommet AR6048 Brake & Clutch Pedal Rubber AR6049 Accelerator Pedal Rubber AR6294 (93-09) Caliper Guide Pin & Bush		
REAR SUSPENSION				
Centre Bearing Rubber			AR5311	AR5311
Exhaust Hanger - Middle			AR5262	AR5262
Exhaust Hanger - Rear			AR6265	AR6265
Lower Control Arm Bush - Inner				
Lower Control Arm Bush - Outer				
Shackle Bush - Front	AR5370 (2)	AR5370 (2)	AR5065 (4)	AR5065 (4) (LN51/56) AR6178 (4) (RN58)
Shackle Bush - Rear Upper	AR5376 (4)	AR5376 (4)	AR5065 (4)	AR5065 (4) (LN51/56) AR6178 (4) (RN58)
Shackle Bush - Rear Lower	AR5370 (2)	AR5370 (2)	AR5065 (4)	AR5065 (4)
Shock Rubber - Rear	AR33	AR33	AR33	AR33
Stabilizer Bar Bush				
Stabilizer Link Grommet			AR6190 (10mm) Stabilizer Link Pin Kit AR6191 (7.5mm) Stabilizer Link Pin Kit	AR6190 (10mm) Stabilizer Link Pin Kit AR6191 (7.5mm) Stabilizer Link Pin Kit
Miscellaneous	AR8139 Bump Stop Rubber	AR8139 Bump Stop Rubber		

APPLICATIONS	TOYOTA HILUX 4X4 YN67 2.2 LWB Raider D/cab, D/cab P/up Pet. - 4Y	TOYOTA HILUX YN51 1.8 SWB S, SR, Raider P/up Pet., 5-Spd. Man. - 2Y YN56 1.8 LWB P/up 4/5-Spd. Man. Pet. - 2Y	TOYOTA HILUX 4X4 LN65 2.4 LWB D/cab, Raider D/Cab Dies. - 2L RN67 2.4 LWB Raider, D/cab, Raider D/cab Pet. - 22R	TOYOTA HILUX 4X4 LN57 2.8 LWB Raider D/cab, P/up Dies. - 3L LN67 2.8 LWB P/up, Raider D/cab Dies. - 3L
	YEARS	85-94	86-98	89-98
Engine Configuration	INLINE	INLINE	INLINE	INLINE
Engine Mounting - Front				
Engine Mounting - Rear				
Engine Mounting - Left	AR5366	AR5337	AR5337	AR5408
Engine Mounting - Right	AR5366	AR5337	AR5337	AR5408
Engine Mounting - Other				
Engine Stabilizer Rubber				
Transmission Mounting	AR6007	AR5340	AR6007	AR5340 (LN57) AR6008 (LN67)
FRONT SUSPENSION				
Exhaust Hanger - Front	AR5262	AR5262	AR5262 (95-98)	AR5262
Upper Control Arm Bush - Inner				
Upper Control Arm Bush - Outer				
Lower Control Arm Bush - Inner		AR6059		AR6059 (LN57)
Lower Control Arm Bush - Outer				
Shock Rubber - Front		AR22		AR22 (LN57) AR5092 (LN67)
Stabilizer Bar Bush		AR6060		AR6066 (LN57)
Stabilizer Link Grommet		AR5436		AR5436 (LN57)
Steering Coupling	AR6451 (1985 Only)	AR6057 (86-91) AR6452 (91-98)	AR6057	AR6057
Steering Rack Mounting				
Strut Mounting				
Tension Rod Bush		AR6055		AR6058 (LN57)
Miscellaneous	AR5065 (4) Shackle Bush - Front Upper AR5065 (37mm) (4) Shackle Bush - Rear Lower AR5376 (56mm) (4) Shackle Bush - Rear Upper		AR5065 (4) (37mm) Shackle Bush - Front Upper & Lower AR5376 (4) (56mm) Shackle Bush - Rear Upper	AR5065 (4) (37mm) Shackle Bush - Front Upper & Lower AR5376 (4) (56mm) Shackle Bush - Rear Upper
REAR SUSPENSION				
Centre Bearing Rubber	AR5313	AR5311	AR5311	AR5311
Exhaust Hanger - Middle	AR5262	AR5262	AR5262	AR5262
Exhaust Hanger - Rear	AR6265	AR6265	AR6265	AR6265
Lower Control Arm Bush - Inner				
Lower Control Arm Bush - Outer				
Propshaft Coupling				
Shackle Bush - Front	AR5065 (4) (85-91) AR6178 (4) (92-94)	AR5065 (4)	AR5065 (4)	AR5065 (4)
Shackle Bush - Rear Upper	AR5065 (4)	AR5065 (86-91) (4) AR6178 (92-98) (4)	AR5065 (89-91) (4) AR6178 (92-95) (4)	AR6178 (4)
Shackle Bush - Rear Lower		AR5065 (4)	AR5065 (4)	AR5065 (4)
Shock Rubber - Rear		AR33		AR33
Stabilizer Bar Bush				
Stabilizer Link Grommet	AR6190 (10mm) Stabilizer Link Pin Kit AR6191 (7.5mm) Stabilizer Link Pin Kit	AR6190 (10mm) Stabilizer Link Pin Kit AR6191 (7.5mm) Stabilizer Link Pin Kit	AR6190 (10mm) Stabilizer Link Pin Kit AR6191 (7.5mm) Stabilizer Link Pin Kit	AR6190 (10mm) Stabilizer Link Pin Kit AR6191 (7.5mm) Stabilizer Link Pin Kit
Strut Mounting				
Miscellaneous				

APPLICATIONS	TOYOTA HILUX YN140 1.8 SWB, LWB D/cab, Raider Pet, 5-Spd. Man. - 2Y	TOYOTA HILUX RZN147 2.0 LWB SR D/cab Pet. 5-Spd. Man. - 1RZ-E 2.0 SWB SR, DLX, S, Pet. 5-Spd. Man. - 1RZ-E	TOYOTA HILUX LN140 2.4 SWB DLX P/up Dies. - 2L LN145 2.4 LWB P/up Dies. - 2L	TOYOTA HILUX 4X4 RZN169 2.7i LWB P/up, Raider, Raider D/C, SRX D/C, DLX S/C, Legend35, Legend35 D/C Pet. - 3RZ-FE
	YEARS	98-05	98-05	98-05
Engine Configuration	INLINE	INLINE	INLINE	INLINE
Engine Mounting - Front				
Engine Mounting - Rear				
Engine Mounting - Left	AR5337	AR5337	AR5408	AR5366
Engine Mounting - Right	AR5337	AR5337	AR5408	AR5366
Engine Mounting - Other				
Engine Stabilizer Rubber				
Transmission Mounting	AR5340	AR6276	AR5340	AR6278
FRONT SUSPENSION				
Exhaust Hanger - Front	AR6265		AR6265	
Upper Control Arm Bush - Inner				AR6051 - Front
Upper Control Arm Bush - Outer				AR6052 - Rear
Lower Control Arm Bush - Inner	AR6435	AR6435	AR6435	AR6286
Lower Control Arm Bush - Outer				AR6286
Shock Rubber - Front	AR22	AR22	AR22	AR5092 - Upper AR6277 - Lower
Stabilizer Bar Bush	AR6066	AR6066	AR6066	AR6066
Stabilizer Link Grommet	AR5436	AR5436	AR5436	AR22
Steering Coupling			AR6057	
Steering Rack Mounting				
Strut Mounting				
Tension Rod Bush	AR6055	AR6055	AR6055	
Miscellaneous				
REAR SUSPENSION				
Centre Bearing Rubber	AR6195	AR6195	AR6195	AR6195
Exhaust Hanger - Middle	AR5262		AR5262	
Exhaust Hanger - Rear	AR6265	AR6265	AR6265	AR6265
Lower Control Arm Bush - Inner				
Lower Control Arm Bush - Outer				
Propshaft Coupling				
Shackle Bush - Front	AR5065 (4)	AR5065 (4) (4 Leaf Spring) AR5370 (4) (5 Leaf Spring)	AR5065 (4) (4 Leaf Spring) AR5370 (4) (5 Leaf Spring)	AR5370 (2)
Shackle Bush - Rear Upper	AR6178 (4)	AR6178 (4)	AR6178 (4)	AR6178 (4)
Shackle Bush - Rear Lower	AR5065 (4)	AR5065 (4)	AR5065 (4)	AR5065 (4)
Shock Rubber - Rear	AR33	AR33	AR33	
Stabilizer Bar Bush				
Stabilizer Link Grommet	AR6190 (10mm) Stabilizer Link Pin Kit AR6191 (7.5mm) Stabilizer Link Pin Kit	AR6190 (10mm) Stabilizer Link Pin Kit AR6191 (7.5mm) Stabilizer Link Pin Kit	AR6190 (10mm) Stabilizer Link Pin Kit AR6191 (7.5mm) Stabilizer Link Pin Kit	AR6190 (10mm) Stabilizer Link Pin Kit AR6191 (7.5mm) Stabilizer Link Pin Kit
Strut Mounting				
Miscellaneous				

APPLICATIONS	TOYOTA HILUX RZN194 2.7i LWB Legend35, Raider, Raider D/cab, Raised body Pet. 5-Spd. Man. - 3RZ-FE	TOYOTA HILUX LN192 3.0D LWB D-E DLX, Raider D/cab Raised Body Dies. - 5L 3.0iD LWB D/cab Raider, Legend35 Raider, D/cab, Raider Dies. - KZ-TE	TOYOTA HILUX "VIGO" 4X2 2.0i LWB S/cab, S, SRX, P/up Pet. Standard Body - 1TR-FE	TOYOTA HILUX "VIGO" 4X2, 4X4 2.5 TDi LWB D-4D S/cab, S, SRX, HO Raised Body, D/C Raider P/up Dies. - 2KD-FTV	
	YEARS	98-05	98-05	05-11	05-11
	Engine Configuration	INLINE	INLINE	INLINE	INLINE
	Engine Mounting - Front				
	Engine Mounting - Rear				
	Engine Mounting - Left	AR5366	AR5408 (Std.) AR6405 (KZ-TE)	AR7595	AR7592
	Engine Mounting - Right	AR5366	AR5408 (Std.) AR6405 (KZ-TE)	AR7595	AR7592
	Engine Mounting - Other				
	Engine Stabilizer Rubber				
	Transmission Mounting	AR5340 AR6276 - Alt.	AR8857 AR6388 - Alt. (3.0 KZ-TE)	AR7596	AR7596 (4x2) AR7597 (4x4)
FRONT SUSPENSION					
Exhaust Hanger - Front			AR7600	AR7600	
Upper Control Arm Bush - Inner	AR6051 - Front	AR6051 - Front	AR8808 - Front	AR8570 - Front (ID: 15mm) Raised Body AR8808 - Front (ID: 12.5mm) Standard Body	
Upper Control Arm Bush - Outer	AR6052 - Rear	AR6052 - Rear	AR8808 - Rear	AR8570 - Rear (ID: 15mm) Raised Body AR8808 - Rear (ID: 12.5mm) Standard Body	
Lower Control Arm Bush - Inner	AR6286	AR6286	AR8799 - Front	AR8571 - Front (ID: 14.5mm) Raised Body AR8799 - Front (ID: 16.5mm) Standard Body	
Lower Control Arm Bush - Outer	AR6286	AR6286	AR8798 - Rear	AR8572 - Rear (ID: 14.5mm) Raised Body AR8798 - Rear (ID: 16.5mm) Standard Body	
Shock Rubber - Front	AR5092 - Upper AR6277 - Lower	AR5092 - Upper AR6277 - Lower	AR7629		
Stabilizer Bar Bush	AR6066	AR6066	AR7605	AR7605 (4x2) AR7606 (4x4)	
Stabilizer Link Grommet		AR22	AR22	AR7608	
Strut Mounting			AR7602	AR7602 (4x2) AR7603 (4x4)	
Tension Rod Bush					
Miscellaneous			AR9817 Bump Stop	AR9817 Bump Stop Std. Body	
REAR SUSPENSION					
Centre Bearing Rubber	AR6195	AR6195 AR8140 - Alt. (3.0 KZ-TE)	AR7618	AR7618 AR8897 - Alt. (4x4)	
Exhaust Hanger - Middle			AR7601	AR7601	
Exhaust Hanger - Rear	AR6265	AR6265	AR7601	AR7601	
Shackle Bush - Front	AR5370 (2)	AR5370 (2)	AR7613 (4)	AR7613 (4) Standard Body AR7615 (4) Raised Body	
Shackle Bush - Rear Upper	AR6178 (4)	AR6178 (4)	AR7616 (4)	AR7616 (4)	
Shackle Bush - Rear Lower	AR5065 (4)	AR5065 (4)	AR7617 (4)	AR7617 (4)	
Shock Rubber - Rear					
Stabilizer Bar Bush					
Stabilizer Link Grommet	AR6190 (10mm) Stabilizer Link Pin Kit AR6191 (7.5mm) Stabilizer Link Pin Kit	AR6190 (10mm) Stabilizer Link Pin Kit AR6191 (7.5mm) Stabilizer Link Pin Kit			
Strut Mounting					
Miscellaneous					

APPLICATIONS	TOYOTA HILUX "VIGO" 4X2, 4X4 2.7i LWB S/cab Raider, D/cab Raider, S/Cab, HO Raised Body, Legend40 P/up Pet. - 2TR-FE	TOYOTA HILUX "VIGO" 4X2, 4X4 3.0D-4D LWB Raider, D/Cab Raider Raised Body, Legend40 P/up Dies. - 1KD-FTV 4.0 V6 D/cab Raider Raised Body, Legend40 P/up Pet. - 1GR-FE	TOYOTA HILUX 4X2 2.0 VVTi 5-Spd. Man. S/cab Std. Body - 1TR-FE 2.5D-4D 5-Spd. Man. Std., Raised Body - 2KD-FTV	TOYOTA HILUX 4X2 2.7 VVTi - 2TR-FE 3.0D-4D - 1KD-FTV 4.0 - 1GR-FE
	YEARS	05-11	05-11	11-16
Engine Configuration	INLINE	INLINE	INLINE	INLINE
Engine Mounting - Front				
Engine Mounting - Rear				
Engine Mounting - Left	AR7595	AR7592 (3.0) AR7593 (4.0)	AR7593 (2.0) AR7592 (2.5)	AR7593 (2.7) AR7592 (3.0) AR7595 (4.0)
Engine Mounting - Right	AR7595	AR7592 (3.0) AR7593 (4.0)	AR7593 (2.0) AR7592 (2.5)	AR7593 (2.7) AR7592 (3.0) AR7595 (4.0)
Engine Mounting - Other				
Engine Stabilizer Rubber				
Transmission Mounting	AR7596 (4x2) AR7597 (4x4)	AR7596 (3.0 4x2) AR7597 (3.0 4x4) AR8858 (4.0 4x4)	AR7596 AR9768 - Alt. (2.5)	AR7596 (2.7) AR9768 (3.0) AR8858 (4.0)
FRONT SUSPENSION				
Exhaust Hanger - Front	AR7600	AR7600	AR7601	
Upper Control Arm Bush - Inner	AR8570 - Front (ID: 15mm)	AR8570 - Front (ID: 15mm)	AR8570 - Front (Raised Body) AR8808 - Front (Std. Body)	AR8570 - Front
Upper Control Arm Bush - Outer	AR8570 - Rear (ID: 15mm)	AR8570 - Rear (ID: 15mm)	AR8570 - Rear (Raised Body) AR8808 - Rear (Std. Body)	AR8570 - Rear
Lower Control Arm Bush - Inner	AR8571 - Front (ID: 14.5mm)	AR8571 - Front (ID: 14.5mm)	AR8571 - Front (Raised Body) AR8799 - Front (Std. Body)	AR8571 - Front
Lower Control Arm Bush - Outer	AR8572 - Rear (ID: 14.5mm)	AR8572 - Rear (ID: 14.5mm)	AR8572 - Rear (Raised Body) AR8798 - Rear (Std. Body)	AR8572 - Rear
Shock Rubber - Front			AR7629	AR7629
Stabilizer Bar Bush	AR7605 (4x2) AR7606 (4x4)	AR7605 (4x2) AR7606 (4x4)	AR7605 Std. Body AR7606 Raised Body	AR7606
Stabilizer Link Grommet	AR7608	AR7608	AR22	
Steering Coupling				
Steering Rack Mounting				
Strut Mounting	AR7602 (4x2) AR7603 (4x4)	AR7602 (4x2) AR7603 (4x4)	AR7602 Std. Body AR7603 Raised Body	AR7603
Tension Rod Bush				
Miscellaneous			AR9808 Bump Stop Raised Body AR9817 Bump Stop Std. Body	AR9808 Bump Stop
REAR SUSPENSION				
Centre Bearing Rubber	AR7618 AR8897 - Alt. (4x4)	AR7618 AR8897 - Alt. (4x4)	AR7618	AR7618
Exhaust Hanger - Middle	AR7601	AR7601	AR7601	
Exhaust Hanger - Rear	AR7601	AR7601	AR7601	
Lower Control Arm Bush - Inner				
Lower Control Arm Bush - Outer				
Shackle Bush - Front	AR7613 (4) Standard Body AR7615 (4) Raised Body	AR7613 (4) Standard Body AR7615 (4) Raised Body	AR7613 (4) Std. Body AR7615 (4) Raised Body	AR7615 (4)
Shackle Bush - Rear Upper	AR7616 (4)	AR7616 (4)	AR7616 (4)	AR7616 (4)
Shackle Bush - Rear Lower	AR7617 (4)	AR7617 (4)	AR7617 (4)	AR7617 (4)
Shock Rubber - Rear			AR7612	AR7612
Stabilizer Bar Bush				
Stabilizer Link Grommet				
Strut Mounting				
Miscellaneous				

APPLICATIONS	TOYOTA HILUX 4X4 2.5D-4D 5-Spd. Man. Raised Body - 2KD-FTV 3.0D-4D - 1KD-FTV 4.0 - 1GR-FE	TOYOTA HILUX "REVO" 4X2 2.0 VVT-i - 1TR-FE 2.4 GD Std. Body - 2GD-FTV 2.4 GD-6 Raised Body - 2GD-FTV 2.7 VVT-i - 2TR-FE	TOYOTA HILUX "REVO" 4X2 2.8 GD-6 Raised Body - 1GD-FTV 4.0 V6 Raised Body - 1GD-FE	TOYOTA HILUX "REVO" 4X4 2.4 GD-6 Raised Body - 2GD-FTV 2.8 GD-6 Raised Body - 1GD-FTV 4.0 V6 Raised Body - 1GD-FE
YEARS	11-16	2016-	2016-	2016-
Engine Configuration	INLINE	INLINE	INLINE	INLINE
Engine Mounting - Front				
Engine Mounting - Rear				
Engine Mounting - Left	AR7592 (2.5, 3.0) AR7595 (4.0)	AR9781 (2.4) AR9796 (2.0, 2.7)	AR9781 (2.8) AR9894 (4.0)	AR9781 (2.4, 2.8) AR9894 (4.0)
Engine Mounting - Right	AR7592 (2.5, 3.0) AR7595 (4.0)	AR9781 (2.4) AR9796 (2.0, 2.7)	AR9781 (2.8) AR9894 (4.0)	AR9781 (2.4, 2.8) AR9894 (4.0)
Engine Mounting - Other				
Engine Stabilizer Rubber				
Transmission Mounting	AR7597 (3.0 Man.) AR8858 (4.0) AR9769 (2.5) AR9793 (3.0 Auto.)	AR7596 (2.0, 2.7) AR9791 (2.4) Raised Body AR9793 (2.4)	AR9791 (2.8 Man.) AR9800 (2.8 Auto.) AR9896 (4.0)	AR9801 (2.4, 2.8) AR9895 (4.0)
FRONT SUSPENSION				
Exhaust Hanger - Front	AR7601 (2.5)			
Upper Control Arm Bush - Inner	AR8570 - Front	AR8570 (2.4, 2.7) Raised Body AR8808 (2.0, 2.4) Std. Body	AR8570 - Front	AR8570 - Front
Upper Control Arm Bush - Outer	AR8570 - Rear	AR8570 (2.4, 2.7) Raised Body AR8808 (2.0, 2.4) Std. Body	AR8570 - Rear	AR8570 - Rear
Lower Control Arm Bush - Inner	AR8571 - Front	AR8799 (2.0, 2.4) Std. Body AR9785 (2.4, 2.7) Raised Body	AR9785 - Front	AR9785 - Front
Lower Control Arm Bush - Outer	AR8572 - Rear	AR8798 (2.0, 2.4) Std. Body AR9786 (2.4, 2.7) Raised Body	AR9786 - Rear	AR9786 - Rear
Shock Rubber - Front	AR7629	AR9788	AR9788 (2.8)	AR9788 (2.4, 2.8)
Stabilizer Bar Bush	AR7606	AR7605 (2.0, 2.4) Std. Body	AR9787	AR9787 (2.8, 4.0)
Stabilizer Link Grommet	AR22 (2.5)	AR22		AR22 (2.4)
Steering Coupling				
Steering Rack Mounting				
Strut Mounting	AR7603	AR7602 (2.0, 2.4) Std. Body AR9789 (2.4, 2.7) Raised Body	AR9789	AR9789
Tension Rod Bush				
Miscellaneous	AR9808 Bump Stop	AR9808 Bump Stop (2.4, 2.7) Raised Body AR9817 Bump Stop (2.0, 2.4) Std. Body	AR9808 Bump Stop	AR9808 Bump Stop
REAR SUSPENSION				
Centre Bearing Rubber	AR7618	AR9766	AR9766	AR9766
Exhaust Hanger - Middle	AR7601 (2.5)			
Exhaust Hanger - Rear	AR7601 (2.5)			
Lower Control Arm Bush - Inner				
Lower Control Arm Bush - Outer				
Propshaft Coupling				
Shackle Bush - Front	AR7615 (4)	AR7613 (4)	AR5370 (2) (2.8)	AR5370 (2) (2.4, 2.8)
Shackle Bush - Rear Upper	AR7616 (4)	AR7616 (4)	AR9892 (4) (2.8)	AR9892 (4) (2.4, 2.8)
Shackle Bush - Rear Lower	AR7617 (4)	AR9893 (4)	AR9893 (4) (2.8)	AR9893 (4) (2.4, 2.8)
Shock Rubber - Rear	AR7612	AR9849	AR9849 (4)	AR9849 (4)
Stabilizer Bar Bush				
Stabilizer Link Grommet				
Strut Mounting				
Miscellaneous				

APPLICATIONS	TOYOTA LAND CRUISER 4X4 FJ62 4.0, GX P/up Pet. 5-Spd. Man., 4-Spd. Auto. - 3F 4.2 P/up, GX Pet. 5-Spd. Man., 4-Spd. Auto. - 2F	TOYOTA LAND CRUISER 4X4 FJ75 / HJ75 4.0 DLX P/up Petrol 5-Spd. Man. - 3F	TOYOTA LAND CRUISER 4X4 FJ80 4.0 GX, VX P/up Pet. 4-Spd. Auto. - 3F-E	TOYOTA LAND CRUISER 4X4 FZJ75 4.2 GX S/W Pet. 4-Spd. Man. - 1FZ-F HZJ75 4.2 P/up Dies., 4-Spd. Man. - 1HZ
	YEARS	87-90	85-92	90-92
Engine Configuration	INLINE	INLINE	INLINE	INLINE
Engine Mounting - Front				
Engine Mounting - Rear				
Engine Mounting - Left	AR5997	AR6954		AR6279 (Pet.) AR6960 (Dies.)
Engine Mounting - Right	AR5997	AR5997 (85-90) AR6283 (90-91)		AR6279 (Pet.) AR6960 (Dies.)
Engine Mounting - Other				
Engine Stabilizer Rubber				
Transmission Mounting	AR5998 (4.0 Man., 4.2 Std.) AR6961 (4.0 Auto., 4.2 GX)	AR5998	AR6272	AR6272 (Pet.) AR6285 (Dies.)
FRONT SUSPENSION				
Exhaust Hanger - Front				
Upper Control Arm Bush - Inner				
Upper Control Arm Bush - Outer				
Lower Control Arm Bush - Inner	AR6967 (4.0)			
Lower Control Arm Bush - Outer	AR6968 (4.0)			
Shock Rubber - Front	AR33	AR5092 - Upper	AR6969	AR5092 - Upper
Stabilizer Bar Bush	AR5332 (GX) AR6060 (Standard)	AR5368 (85-92) AR6060 (1985)	AR6984 (90-91) AR6971 (91-92)	
Stabilizer Link Grommet	AR5436 AR8841 Kit	AR5436	AR5436	
Steering Coupling			AR6974	
Steering Rack Mounting				
Strut Mounting			AR1255	
Tension Rod Bush				
Miscellaneous			AR6982 (2) Lateral Control Rod Bush	
REAR SUSPENSION				
Centre Bearing Rubber				
Exhaust Hanger - Middle				
Exhaust Hanger - Rear				
Lower Control Arm Bush - Inner				
Lower Control Arm Bush - Outer				
Propshaft Coupling				
Shackle Bush - Front	AR5319 (4)	AR5321 (4)		AR5321 (4)
Shackle Bush - Rear Upper	AR5319 (4)	AR5321 (4)		AR5321 (4)
Shackle Bush - Rear Lower	AR5319 (4)	AR5321 (4)		AR5321 (4)
Shock Rubber - Rear	AR33 (4.0) AR5939 (4.2)	AR33	AR5092 - Upper	AR5939
Stabilizer Bar Bush	AR6060	AR6060		
Stabilizer Link Grommet	AR6037		AR5436	
Strut Mounting				
Miscellaneous			AR6979 (4) Upper Control Arm Bush AR6980 (4) Lower Control Arm Bush AR6981 (2) Lateral Centre Rod Bush	

APPLICATIONS	TOYOTA LAND CRUISER 4X4 FZJ80 / HDJ80 4.5 Std., GX P/up, GX, VX S/W 12V Dies. 5-Spd. Man., 4-Spd. Auto. - 1FZ-FE, 1HD	TOYOTA LAND CRUISER 4X4 FZJ100 / HDJ100 / UZJ100 4.7 VX V8 Petrol 5-Spd. Man., 4-Spd. Auto. - 2UZ-FE	TOYOTA LAND CRUISER 4X4 FZJ100 4.2 VX TD P/up, S/W, GX DSL P/up AHC Diesel 5-Spd. Auto.	TOYOTA LAND CRUISER 4X4 FZJ105 4.2 Std., GX P/up Dies. Turbo 5-Spd. Man., 4-Spd. Auto. - 1FZ-FE HZJ105 4.2 GX P/up Dies. Turbo 5-Spd. Man., Auto. - 1HZ
	YEARS	90-98	98-03	02-04
Engine Configuration	INLINE	INLINE	INLINE	INLINE
Engine Mounting - Front				
Engine Mounting - Rear				
Engine Mounting - Left	AR6964 (HDJ) (90-93) AR6964 (FZJ) (95-98) AR6965 (HDJ) (93-98) AR6985 (FZJ) (92-95)	AR6994	AR6964	AR6964
Engine Mounting - Right	AR6964 (HDJ) (90-93) AR6964 (FZJ) (95-98) AR6965 (HDJ) (93-98) AR6985 (FZJ) (92-95)	AR6994	AR6964	AR6964
Engine Mounting - Other				
Transmission Mounting	AR6966 (Man.) AR6986 (Auto.)	AR6995	AR6272	AR6272 (FZJ Man.) AR6285 (HZJ Man.) AR6993 (Auto.)
FRONT SUSPENSION				
Exhaust Hanger - Front		AR6319		AR6318
Upper Control Arm Bush - Inner		AR7002	AR7625	
Upper Control Arm Bush - Outer		AR7002	AR7625	
Lower Control Arm Bush - Inner	AR6967	AR6996 - Front	AR7626	AR6967
Lower Control Arm Bush - Outer	AR6968	AR6997 - Rear	AR7626	AR6968
Shock Rubber - Front	AR5092	AR6998	AR7629	AR5092
Stabilizer Bar Bush	AR6971 (92-95) AR6972 (96-98)	AR6999	AR7630 AR7631 - Alt.	AR6991
Stabilizer Link Grommet	AR8841 Kit	AR5092 AR8841 Kit	AR5092	AR6037 AR8841 Kit
Steering Coupling		AR7000		AR6974
Steering Rack Mounting		AR7001		
Strut Mounting			AR1255	
Tension Rod Bush				
Miscellaneous	AR6982 (2) Lateral Control Rod Bush	AR7003 (2) Lateral Control Rod Bush		AR6982 (2) Lateral Control Rod Bush
REAR SUSPENSION				
Centre Bearing Rubber				
Exhaust Hanger - Middle	AR6318			
Exhaust Hanger - Rear	AR6318	AR6265		
Lower Control Arm Bush - Inner				
Lower Control Arm Bush - Outer				
Shackle Bush - Front				
Shackle Bush - Rear Upper				
Shackle Bush - Rear Lower		AR7006 Bush		
Shock Rubber - Rear	AR5092 - Upper		AR5092 - Top No. 1 AR6277 - Top No. 2	AR5092 - Upper (FZJ Only)
Stabilizer Bar Bush	AR5368			AR5368
Stabilizer Link Grommet	AR5436 AR6037 Stabilizer Link Bush	AR5436 AR6037 Stabilizer Link Bush	AR5081	AR5436 AR6037 Stabilizer Link Bush
Strut Mounting				
Miscellaneous	AR6979 (4) Upper Control Arm Bush AR6980 (4) Lower Control Arm Bush AR6981 (2) Lateral Control Arm Bush	AR6979 (4) Upper Control Arm Bush AR6980 (4) Lower Control Arm Bush AR6981 (2) Lateral Control Arm Bush	AR7636 Rear Trailing Link Bush AR7637 Rear Trailing Link Bush - Alt. AR7638 Upper Control Arm Link Bush AR7639 Rear Lateral Link AR7640 Rear Lateral Link - Alt	AR6979 (4) Upper Control Arm Bush AR6980 (4) Lower Control Arm Bush AR6981 (2) Lateral Control Arm Bush

APPLICATIONS	TOYOTA LAND CRUISER 4X4 FZJ105 / UZJ105 4.5 GX S/W Dies. 5-Spd. Man., 4-Spd. Auto. 4.7 VX S/W V8 Petrol	TOYOTA LAND CRUISER 4X4 HDJ100 4.5 GX, VX S/W Dies. 5-Spd. Man., 4-Spd. Auto. - 1FZ-FE	TOYOTA LAND CRUISER 4X4 HJ60 / HJ62 4.0, GX P/up Dies. - 2H 4-Spd. Man. Turbo Dies. 4-Spd. Man., Auto. - 12H	TOYOTA LAND CRUISER 4X4 HZJ80 4.2 Std., GX 5-Spd. Man. Dies. 4-Spd. Auto., 5-Spd. Man. - 1HZ
	YEARS	03-08	98-06	87-90
Engine Configuration	INLINE	INLINE	INLINE	INLINE
Engine Mounting - Front				
Engine Mounting - Rear				
Engine Mounting - Left		AR6965	AR5999	AR6964 (90-93) AR6965 (93-95)
Engine Mounting - Right		AR6965	AR5999	AR6964 (90-93) AR6965 (93-95)
Engine Mounting - Other				
Engine Stabilizer Rubber				
Transmission Mounting		AR6966 (Man.) AR6986 (Auto.)	AR5998 (Man.)	AR6272
FRONT SUSPENSION				
Exhaust Hanger - Front		AR6318		
Upper Control Arm Bush - Inner	AR7649			
Upper Control Arm Bush - Outer	AR7649			
Lower Control Arm Bush - Inner	AR7650	AR6967		AR6967
Lower Control Arm Bush - Outer	AR7650	AR6968		AR6968
Shock Rubber - Front	AR7629		AR33	AR5092 (90-92)
Stabilizer Bar Bush	AR7654		AR6060	AR6971 (92-95)
Stabilizer Link Grommet	AR5092	AR8841 Kit	AR5436	AR5436 (90-95) Stabilizer Link Only
Steering Coupling				AR6974
Steering Rack Mounting				
Strut Mounting	AR7651 AR7652 - Alt. 1 AR7653 - Alt. 2			
Tension Rod Bush				
Miscellaneous		AR6982 Lateral Control Rod Bush (2)		AR6982 (2) Lateral Control Rod Bush
REAR SUSPENSION				
Centre Bearing Rubber				
Exhaust Hanger - Middle	AR6318	AR6318		
Exhaust Hanger - Rear	AR6318	AR6318		
Lower Control Arm Bush - Inner				
Lower Control Arm Bush - Outer				
Propshaft Coupling				
Shackle Bush - Front			AR5319 (4)	
Shackle Bush - Rear Upper			AR5319 (4)	
Shackle Bush - Rear Lower			AR5319 (4)	
Shock Rubber - Rear		AR5092 - Upper	AR33	AR5092 - Upper
Stabilizer Bar Bush		AR5368	AR6060	AR5368 (92-95)
Stabilizer Link Grommet	AR5081	AR5436 AR6037 Stabilizer Link Bush	AR6037	AR5368 (92-95)
Strut Mounting				
Miscellaneous	AR7662 Rear Lateral Link Bush AR7663 Rear Lateral Link Bush AR7664 Rear Trailing Link Bush	AR6979 (4) Upper Control Arm Bush AR6980 (4) Lower Control Arm Bush AR6981 (2) Lateral Control Arm Bush		AR6979 (4) Upper Control Arm Bush AR6980 (4) Lower Control Arm Bush AR6981 (2) Lateral Control Rod Bush

APPLICATIONS	TOYOTA LAND CRUISER 4X4 HZJ80 4.2 GX, VX Dies. 5-Spd. Man., 4-Spd. Auto. - 1HD-FT	TOYOTA LAND CRUISER 4X4 PHJ75 4.0 DLX 236 Perkins Dies. 4-Spd. Man.	TOYOTA LAND CRUISER 4X4 UZJ100 4.2 VX TD S/W, GX DSL S/W, P/up S/W AHC Dies. 4/5-Spd. Auto. - 1HD-FTE	TOYOTA LAND CRUISER 4X4 76-SERIES 78-SERIES 79-SERIES 4.2D P/up, S/W Dies. 5-Spd. Man. - 1HZ
YEARS	96-98	85-91	04-08	2009-
Engine Configuration	INLINE	INLINE	INLINE	INLINE
Engine Mounting - Front				
Engine Mounting - Rear				AR8577
Engine Mounting - Left	AR6964 (Auto.) AR6987 (Man.)		AR9267	AR8576
Engine Mounting - Right	AR6964 (Auto.) AR6987 (Man.)		AR9267	AR8576
Engine Mounting - Other				
Engine Stabilizer Rubber				
Transmission Mounting	AR6988 (Man.) AR6989 (Auto.)	AR5998 (Early 86)	AR9266	
FRONT SUSPENSION				
Exhaust Hanger - Front				
Upper Control Arm Bush - Inner			AR7649	
Upper Control Arm Bush - Outer			AR7649	
Lower Control Arm Bush - Inner	AR6967		AR7650	Solid Front Axle
Lower Control Arm Bush - Outer	AR6968		AR7650	Solid Front Axle
Shock Rubber - Front	AR5092 (90-92)	AR5092 - Upper	AR7629	
Stabilizer Bar Bush	AR6971 (90-92) AR6972 (92-95)	AR5368 (87-91) AR6060 (1985)	AR7654	
Stabilizer Link Grommet	AR5436 (90-95) Stabilizer Link Only	AR5436 (85-90)	AR5092	AR8842 Kit
Steering Coupling	AR6974			
Steering Rack Mounting				
Strut Mounting			AR7651 AR7652 - Alt. 1 AR7653 - Alt. 2	
Tension Rod Bush				
Miscellaneous	AR6982 (2) Lateral Control Rod Bush	AR5319 (4) Front Upper Shackle Bush AR5319 (4) Rear Upper & Lower Shackle Bushes		AR6982 (2) Lateral Control Rod Bush
REAR SUSPENSION				
Centre Bearing Rubber				
Exhaust Hanger - Middle				
Exhaust Hanger - Rear				
Lower Control Arm Bush - Inner				
Lower Control Arm Bush - Outer				
Propshaft Coupling				
Shackle Bush - Front		AR5321 (4)		AR8406 (4)
Shackle Bush - Rear Upper		AR5321 (4)		AR8404 (4)
Shackle Bush - Rear Lower		AR5321 (4)		AR8405 (4)
Shock Rubber - Rear	AR5092 - Upper	AR33		
Stabilizer Bar Bush	AR5368			
Stabilizer Link Grommet			AR5081	AR6937
Strut Mounting				
Miscellaneous	AR6979 (4) Upper Control Arm Bush AR6980 (4) Lower Control Arm Bush AR6981 (2) Lateral Control Arm Bush		AR7662 Rear Lateral Link Bush AR7663 Rear Lateral Link Bush AR7664 Rear Trailing Link Bush	

APPLICATIONS	TOYOTA LAND CRUISER 4X4 79-SERIES 4.0 P/up Pet. 5-Spd. Man. - 1GR-FE	TOYOTA LAND CRUISER 4X4 100-SERIES 4.0 GX DSL S/W, VX S/W Pet. 5-Spd. Man., Auto.	TOYOTA LAND CRUISER 4X4 100-SERIES 4.2D 5-Spd. Man., 4-Spd. Auto. 4.7 V8 5-Spd. Auto.	TOYOTA LAND CRUISER 4X4 200-SERIES 4.5 VX TD S/W Dies., 6-Spd. Man. - 1VD-FTV 4.7 VX S/W V8 Petrol 5-Spd. Man. - 2UZ-FE
	YEARS	2009-	98-06	02-07
Engine Configuration	INLINE	INLINE	INLINE	INLINE
Engine Mounting - Front				
Engine Mounting - Rear	AR8579	AR7642		AR8586 (4.5) AR8584 (4.7)
Engine Mounting - Left	AR8578	AR7641	AR9267	AR8585 (4.5) AR8583 (4.7)
Engine Mounting - Right	AR8578	AR7641	AR9267	AR8585 (4.5) AR8583 (4.7)
Engine Mounting - Other				
Engine Stabilizer Rubber				
Transmission Mounting			AR9266	
FRONT SUSPENSION				
Exhaust Hanger - Front				
Upper Control Arm Bush - Inner	Solid Front Axle	AR7649	AR7002	AR8580
Upper Control Arm Bush - Outer	Solid Front Axle	AR7649	AR7002	AR8580
Lower Control Arm Bush - Inner		AR7650	AR6997 - Front	AR8581
Lower Control Arm Bush - Outer		AR8572	AR6996 - Rear	AR1179
Shock Rubber - Front		AR7629		
Stabilizer Bar Bush	AR8575	AR7654	AR6999	
Stabilizer Link Grommet	AR8842 Kit	AR5092		
Steering Coupling				
Steering Rack Mounting			AR7001	
Strut Mounting		AR7651 AR7652 - Alt. 1 AR7653 - Alt. 2		AR8582
Tension Rod Bush				
Miscellaneous	AR6982 (2) Lateral Control Rod Bush			
REAR SUSPENSION				
Centre Bearing Rubber				
Exhaust Hanger - Middle				
Exhaust Hanger - Rear				
Lower Control Arm Bush - Inner				
Lower Control Arm Bush - Outer				
Propshaft Coupling				
Shackle Bush - Front	AR8406 (4)			
Shackle Bush - Rear Upper	AR8404 (4)			
Shackle Bush - Rear Lower	AR8405 (4)			
Shock Rubber - Rear				
Stabilizer Bar Bush			AR7007	
Stabilizer Link Grommet	AR6937	AR5081		
Strut Mounting				
Miscellaneous		AR7662 Rear Lateral Link Bush AR7663 Rear Lateral Link Bush AR7664 Rear Trailing Link Bush		

APPLICATIONS	TOYOTA LAND CRUISER 4X4 200-SERIES 4.6 V8 6-Spd. Auto. - 1UR-FE	TOYOTA LAND CRUISER 4X4 PRADO 90/95 3.0 GX, VX S/W Dies. 5-Spd. Man., Auto. - 1KZ-TE 3.4 GX, VX S/W Man., Auto. Pet.	TOYOTA LAND CRUISER 4X4 PRADO 120 3.0TD, VX S/W Dies., 5-Spd. Man., 4-Spd. Auto. - 1KZ-TE 4.0 GX, VX S/W 4-Spd. Auto. Pet. - 1GR-FE	TOYOTA LAND CRUISER 4X4 PRADO 150 3.0D VX, TX S/W 4-Spd. Auto., Dies. - 1KD-FTV 4.0 TX, VX S/W 4-Spd. Auto. Pet. - 1GR-FE
	YEARS	2012-	96-02	02-09
Engine Configuration	INLINE	INLINE	INLINE	INLINE
Engine Mounting - Front				
Engine Mounting - Rear	AR9261			
Engine Mounting - Left	AR9262	AR5366 (3.0) AR7621 (3.4)	AR5366 (3.0) AR7641 (4.0)	AR7592 (3.0 1KD-FTV) AR7641 (4.0)
Engine Mounting - Right	AR9263	AR5366 (3.0) AR7621 (3.4)	AR5366 (3.0) AR7641 (4.0)	AR7592 (3.0 1KD-FTV) AR7641 (4.0)
Engine Mounting - Other				
Engine Stabilizer Rubber				
Transmission Mounting		AR7619 (3.0 Auto.) AR7620 (3.0 Man.) AR7622 (3.4 Man.) AR7623 (3.4 Auto.)	AR7643 (3.0) AR7642 (4.0)	AR7643 (3.0) AR7642 (4.0)
FRONT SUSPENSION				
Exhaust Hanger - Front			AR7644 (04-05)	
Upper Control Arm Bush - Inner	AR8580	AR7625	AR7649	AR7649
Upper Control Arm Bush - Outer	AR8580	AR7625	AR7649	AR7649
Lower Control Arm Bush - Inner	AR8581	AR7626	AR7650	AR7650
Lower Control Arm Bush - Outer	AR1179	AR7626	AR8572	AR8572
Shock Rubber - Front		AR7629	AR7629	
Stabilizer Bar Bush	AR9264	AR7630 AR7631 - Alt.	AR7654	AR7654
Stabilizer Link Grommet		AR5092	AR5092	AR5092
Steering Coupling				
Steering Rack Mounting				
Strut Mounting			AR7651 AR7652 - Alt.	AR7651
Tension Rod Bush				
Miscellaneous				
REAR SUSPENSION				
Centre Bearing Rubber				
Exhaust Hanger - Middle			AR7644 (04-05)	
Exhaust Hanger - Rear				
Lower Control Arm Bush - Inner				
Lower Control Arm Bush - Outer				
Propshaft Coupling				
Shackle Bush - Front				
Shackle Bush - Rear Upper				
Shackle Bush - Rear Lower				
Shock Rubber - Rear		AR5092 - Top No. 1 AR6277 - Top No. 2		
Stabilizer Bar Bush	AR9265			
Stabilizer Link Grommet		AR5081	AR5081	
Strut Mounting				
Miscellaneous		AR7636 Rear Trailing Link Bush AR7637 Rear Trailing Link Bush - Alt. AR7638 Upper Control Arm Link Bush AR7639 Rear Lateral Link AR7640 Rear Lateral Link - Alt.	AR7662 Rear Lateral Link Bush AR7663 Rear Lateral Link Bush AR7664 Rear Trailing Link Bush	

APPLICATIONS	TOYOTA QUANTUM 2.5D, "Family" Bus, 10/14 Seater MPV Dies. - 2KD-FTV 2.7, "Family" Bus, 10/14/15 Seater, MPV, Ses' fikile Pet. - 2TR-FE	TOYOTA RAV4 I 4X4 SXA10 / SXA11 2.0 3/5-Dr. SUV, DOHC, 5-Spd. Man., 4-Spd. Auto. - 3S-FE	TOYOTA RAV4 I 4X4 SXA10 / SXA11 2.0 3/5-Dr. SUV, DOHC, 5-Spd. Man., 4-Spd. Auto. - 3S-FE	TOYOTA RAV4 II A/ZCA20 4X2 1.8 SUV Pet. 5-Spd. Man. - 1ZZ-FE A/ZCA20 4X4 2.0 SUV 5-Spd. Man., 4-Spd. Auto.- 1AZ-FE
	YEARS	2005-	94-97	97-02
Engine Configuration	INLINE	TRANSVERSE	TRANSVERSE	TRANSVERSE
Engine Mounting - Front		AR6273	AR6273	AR7668
Engine Mounting - Rear				AR7666 (180) AR7670 (200)
Engine Mounting - Left	AR7598	AR6269 (Man.) AR6270 (Auto.)	AR6947	AR7667 (180) AR7671 (200)
Engine Mounting - Right	AR7598	AR6271	AR6949	AR7665 (180) AR7669 (200)
Engine Mounting - Other				
Engine Stabilizer Rubber				
Transmission Mounting	AR7599	AR6932 (Man.) (94-95) AR6274 (Auto.) (94-95) AR6934 (Auto.) (95-97)	AR6934 (Auto.)	
FRONT SUSPENSION				
Exhaust Hanger - Front				AR7644
Upper Control Arm Bush - Inner	AR7604			
Upper Control Arm Bush - Outer	AR7607			
Lower Control Arm Bush - Inner	AR6425	AR6275 - Front	AR6275 - Front	AR6275 - Front
Lower Control Arm Bush - Outer		AR6935 - Rear	AR6935 - Rear	AR6935 - Rear
Shock Rubber - Front				
Stabilizer Bar Bush	AR7614	AR6066	AR6066 (SXA10) AR6950 (SXA11)	AR7672
Stabilizer Link Grommet	AR22	AR6937	Front Stabilizer Link Assembly Bush AR6937 (SXA10) AR6952 (SXA11)	
Steering Coupling				AR7673
Steering Rack Mounting		AR6938	AR6938	AR7674 - LHS AR7675 - RHS
Strut Mounting		AR6939	AR6939	AR6939
Tension Rod Bush	AR8418			
Miscellaneous	AR9803 Bump Stop			AR7677 Front Stabilizer Link Assembly
REAR SUSPENSION				
Centre Bearing Rubber	AR8143	AR6942	AR6942	AR7686
Exhaust Hanger - Middle		AR6318	AR6318	AR6295 - RHS AR7644 - LHS
Exhaust Hanger - Rear		AR6318	AR6318	AR7644 - LHS
Lower Control Arm Bush - Inner				AR7678
Lower Control Arm Bush - Outer		AR6940 - Rear	AR6940 - Rear	
Shackle Bush - Front	AR8455			
Shackle Bush - Rear Upper	AR5376 (4)			
Shackle Bush - Rear Lower	AR5376 (4)			
Shock Rubber - Rear	AR22	AR5092 - Upper	AR5092 - Upper	AR5092 - Top
Stabilizer Bar Bush				
Stabilizer Link Grommet				
Strut Mounting				
Miscellaneous				AR7683 Rear Upper Lateral Link AR7684 Rear Lower Lateral Link - LHS AR7685 Rear Lower Lateral Link - RHS

APPLICATIONS	TOYOTA RAV4 III 4X4 ACE / ALA 2.0 GX, VX, Fierce SUV Pet., 5-Spd. Man., 4-Spd. Auto. - 1AZ-FE 2.2D-4D GX, VX Dies. 5-Spd. Man.- 2AD-FTV	TOYOTA RAV4 IV 4X2 2.0 - 3ZR-FE RAV4 IV 4X4 2.2D - 2AD-FHV, 2AD-FTV	TOYOTA RAV4 IV 4X2 2.0 GX - 3ZR-FE 2.5 VX AWD - 2AR-FE	TOYOTA RUNX 140i R, RS, RT - 4ZZ-FE 160i RS, RT, RX - 3ZZ-FE 180i RSi, RX 16V - 1ZZ-FE
	YEARS	06-13	2013-	2013-
Engine Configuration	TRANSVERSE	TRANSVERSE	TRANSVERSE	TRANSVERSE
Engine Mounting - Front	AR8591 (2.0) AR8595 (2.2) (06-08) AR8596 (2.2) (2008-)	AR8591 (2.0) AR8596 (2.2)	AR9925 (Man.) AR9287 (CVT 2.0) AR8591 (2.5)	AR7564 (1.6,1.8) AR7565 (1.4)
Engine Mounting - Rear	AR8592 (2.0) AR8597 (2.2) (06-08)	AR8592 (2.0) AR9272 (2.2)	AR9927 (Man.) AR9928 (CVT 2.0) AR9929 (2.5)	AR7563
Engine Mounting - Left	AR8593 (2.0) AR8599 (2.2)	AR8593 (2.0) AR9273 (2.2)	AR9930 (Man.) AR9931 (CVT 2.0) AR9932 (2.5)	AR7569
Engine Mounting - Right		AR9274	AR9933 (CVT 2.0 Man.) AR9934 (2.5)	AR7561
Engine Mounting - Other				
Engine Stabilizer Rubber				
Transmission Mounting	AR8590 (2.0) AR8594 (2.2)	AR8590 (2.0)		
FRONT SUSPENSION				
Exhaust Hanger - Front				
Upper Control Arm Bush - Inner				
Upper Control Arm Bush - Outer				
Lower Control Arm Bush - Inner	AR8806 - Front	AR8806 - Front	AR8806 - Front	AR7590
Lower Control Arm Bush - Outer	AR8807 - Rear	AR8807 - Rear	AR8807 - Rear	AR7591
Shock Rubber - Front				
Stabilizer Bar Bush	AR8587L AR8587R	AR9277	AR9935L AR9935R	AR7571
Stabilizer Link Grommet				
Steering Coupling				AR7572
Steering Rack Mounting				
Strut Mounting	AR8332	AR9278	AR9278	AR7573
Tension Rod Bush				
Miscellaneous				
REAR SUSPENSION				
Centre Bearing Rubber	AR9311	AR9311	AR9936 (2.5) AR9311 - Alt.	
Exhaust Hanger - Middle				
Exhaust Hanger - Rear				
Lower Control Arm Bush - Inner				
Lower Control Arm Bush - Outer				
Propshaft Coupling				
Shackle Bush - Front				
Shackle Bush - Rear Upper				
Shackle Bush - Rear Lower				
Shock Rubber - Rear		AR9279		
Stabilizer Bar Bush			AR9279	
Stabilizer Link Grommet				
Strut Mounting				
Miscellaneous				AR7576 Rear Axle Beam Bush

APPLICATIONS	TOYOTA STALLION KF50 1.5 Commuter, P/up, SR5 P/up, Bus, P/van Pet. 4/5-Spd. Man. - 5K	TOYOTA STALLION YF50 1.8 P/up - 2Y, SR5 P/up, P/van, Pet. - 2Y LF50 2400D P/up Dies. - 2L	TOYOTA VENTURE YF50 1.8 P/van, 8/10-Seater Pet., 4/5-Spd. Man. - 2Y YF51 2.2 10-Seater, Getaway 5-Seater, GLE 9-Seater Pet. 5-Spd. Man. - 4Y LF50 2.4 10-Seater Dies. 5-Spd. Man. - 2L	TOYOTA YARIS 1.0 T1, Zen1 Hatch - 1KR-FE 1.3 T3, Zen3, '+', Spirit Hatch, Sedan Man./Auto. - 2SZ-FE
	YEARS	87-91	91-04	91-04
Engine Configuration	INLINE	INLINE	INLINE	TRANSVERSE
Engine Mounting - Front				
Engine Mounting - Rear				AR7581 (1.0) AR7587 (1.3)
Engine Mounting - Left		AR5337 (1.8) AR5408 (2.4)	AR5337 (1.8, 2.2) AR5408 (2.4)	AR7582 (1.0) AR7583 (1.3)
Engine Mounting - Right		AR5337 (1.8) AR5408 (2.4)	AR5337 (1.8, 2.2) AR5408 (2.4)	AR7580 (1.0) AR7584 (1.3)
Engine Mounting - Other	AR5340	AR5335 (91-95) AR5340 (95-04)		
Engine Stabilizer Rubber				
Transmission Mounting			AR5335 (1.8 4-Spd.) AR5340 (1.8 + 2.2 5-Spd., 2.4)	
FRONT SUSPENSION				
Exhaust Hanger - Front	AR6412	AR6265	AR6265	
Upper Control Arm Bush - Inner	AR6062 - Front	AR6062 - Front	AR6062 - Front	
Upper Control Arm Bush - Outer	AR6063 - Rear	AR6063 - Rear	AR6063 - Rear	
Lower Control Arm Bush - Inner	AR6064	AR6064	AR6064	AR7577 - Front
Lower Control Arm Bush - Outer				AR7578 - Rear
Shock Rubber - Front	AR5092	AR5092	AR5092	
Stabilizer Bar Bush	AR6054	AR6036	AR6036	AR7575
Stabilizer Link Grommet	AR22	AR22	AR22	AR7579 (ID: 8.5mm) Rubber Only AR9404 Complete Pin Kit
Steering Coupling	AR6900 (87-90) AR6065 (90-91)		AR6065 (2.4)	
Steering Rack Mounting		AR6902 - RHS (M/S) AR6903 - LHS (M/S) AR6905 - L/RHS (P/S)	AR6902 - RHS (M/S) AR6903 - LHS (M/S) AR6905 - L/RHS (P/S)	AR7585
Strut Mounting				AR7588 AR7588B
Tension Rod Bush	AR6058	AR6058	AR6058 (1.8, 2.2)	
Miscellaneous				
REAR SUSPENSION				
Centre Bearing Rubber		AR5295	AR5295	
Exhaust Hanger - Middle	AR6412	AR5262	AR5262	
Exhaust Hanger - Rear	AR6412	AR6265	AR6265	
Lower Control Arm Bush - Inner				
Lower Control Arm Bush - Outer				
Propshaft Coupling				
Shackle Bush - Front	AR5065 (4)	AR5065 (4)	AR5065 (4)	
Shackle Bush - Rear Upper	AR5065 (4)	AR5065 (4)	AR5065 (4)	
Shackle Bush - Rear Lower	AR5065 (4)	AR5065 (4)	AR5065 (4)	
Shock Rubber - Rear	AR5939	AR5939	AR5939 (1.8, 2.2)	
Stabilizer Bar Bush				
Stabilizer Link Grommet				
Strut Mounting				
Miscellaneous				AR7570 Rear Axle Beam Bush

APPLICATIONS	TOYOTA YARIS 1.3 Zen3 - 2NZ-FE	TOYOTA YARIS 1.0 - 1KR-FE 1.3 CVT, 6-Spd. - 1NR-FE 1.5 Hybrid - 1NR-ZFXE	TOYOTA YARIS 1.0 - 1KR-FE	TOYOTA YARIS 1.3 - 1NR-FE
	YEARS	10-13	10-14	2013- 13-17
Engine Configuration	TRANSVERSE	TRANSVERSE	TRANSVERSE	TRANSVERSE
Engine Mounting - Front				
Engine Mounting - Rear	AR7587	AR9292 (1.0) AR9296 (1.3) AR9302 (1.5)	AR9937	AR9296 (CVT) AR9938 (Man.)
Engine Mounting - Left	AR7583	AR9293 (1.0) AR9297 (1.3) AR9303 (1.5)	AR9941	AR9942 (Man.) AR9943 (CVT)
Engine Mounting - Right	AR7584	AR9294 (1.0) AR9298 (1.3) AR9304 (1.5)	AR9947	AR9948
Engine Mounting - Other				
Engine Stabilizer Rubber				
Transmission Mounting				
FRONT SUSPENSION				
Exhaust Hanger - Front				
Upper Control Arm Bush - Inner				
Upper Control Arm Bush - Outer				
Lower Control Arm Bush - Inner	AR7577 - Front	AR7577 - Front	AR7577 - Front	AR7577 - Front
Lower Control Arm Bush - Outer	AR7578 - Rear	AR7578 - Rear	AR7578 - Rear	AR7578 - Rear
Shock Rubber - Front				
Stabilizer Bar Bush	AR7575	AR7575 (1.0, 1.3) AR9307 (1.5)	AR7575	AR7575
Stabilizer Link Grommet	AR7579 (ID: 8.5mm) Rubber Only AR9404 Complete Pin Kit	AR7579 (ID: 8.5mm) Rubber Only AR9404 Complete Pin Kit		
Steering Coupling				
Steering Rack Mounting				
Strut Mounting	AR7588 AR7588B	AR7588 AR7588B	AR9308	AR9308
Tension Rod Bush				
Miscellaneous				
REAR SUSPENSION				
Centre Bearing Rubber				
Exhaust Hanger - Middle				
Exhaust Hanger - Rear				
Lower Control Arm Bush - Inner				
Lower Control Arm Bush - Outer				
Propshaft Coupling				
Shackle Bush - Front				
Shackle Bush - Rear Upper				
Shackle Bush - Rear Lower				
Shock Rubber - Rear				
Stabilizer Bar Bush				
Stabilizer Link Grommet				
Strut Mounting				
Miscellaneous	AR7570 Rear Axle Beam Bush	AR9295 (1.0, 1.3) Rear Axle Beam Bush AR9309 (1.5 Only) Rear Axle Beam Bush	AR9309 Rear Axle Beam Bush	AR9309 Rear Axle Beam Bush

APPLICATIONS	TOYOTA YARIS 1.5 Pulse Hybrid - 2NR-FKE			
	YEARS	14-17		
	Engine Configuration	TRANSVERSE		
	Engine Mounting - Front			
	Engine Mounting - Rear	AR9939		
	Engine Mounting - Left	AR9945		
	Engine Mounting - Right	AR9949		
	Engine Mounting - Other			
	Engine Stabilizer Rubber			
	Transmission Mounting			
FRONT SUSPENSION				
Exhaust Hanger - Front				
Upper Control Arm Bush - Inner				
Upper Control Arm Bush - Outer				
Lower Control Arm Bush - Inner	AR7577 - Front			
Lower Control Arm Bush - Outer	AR7578 - Rear			
Shock Rubber - Front				
Stabilizer Bar Bush	AR7575			
Stabilizer Link Grommet				
Steering Coupling				
Steering Rack Mounting				
Strut Mounting	AR9308			
Tension Rod Bush				
Miscellaneous				
REAR SUSPENSION				
Centre Bearing Rubber				
Exhaust Hanger - Middle				
Exhaust Hanger - Rear				
Lower Control Arm Bush - Inner				
Lower Control Arm Bush - Outer				
Propshaft Coupling				
Shackle Bush - Front				
Shackle Bush - Rear Upper				
Shackle Bush - Rear Lower				
Shock Rubber - Rear				
Stabilizer Bar Bush				
Stabilizer Link Grommet				
Strut Mounting				
Miscellaneous	AR9309 Rear Axle Beam Bush			

APPLICATIONS

VOLKSWAGEN

VW AMAROK 4X2, 4X4
2.0 BiTDi - CDCA,
 CNEA, CSHA
2.0 TDi - CDBA, CNFA,
 CNFB
2.0 TSi - CFPA

VW BEETLE
9C1 / 9V1
1.8T Coupe - APH/ AWU
1Y7
2.0i Cabriolet, Coupe,
 HighLine - AEG
9C1
2.0i Cabriolet, Coupe,
 HighLine - AEG

VW BEETLE
1.2 TSi - CBZB
1.4 TSi - CZDA

VW CADDY
1.6, i P/up Dies., Pet.
 4-Spd. Man. - HM, HV,
 JK
1.8 L Sport, Sport
 P/up - HV

YEARS	10-16	00-12	2012-	81-03
Engine Configuration	TRANSVERSE	TRANSVERSE	TRANSVERSE	TRANSVERSE
Engine Mounting - Front				AR6105 Buffer (81-96) AR6171 (96-03)
Engine Mounting - Rear		AR7044 Support Mounting	AR6896 Support Mounting	AR6104 - LHS (96-03)
Engine Mounting - Left	AR8840			AR6104A (81-96) AR7039 - Front LHS (96-03)
Engine Mounting - Right	AR8840	AR7019 AR6919 - Alt.	AR6929	AR6104 (81-96) AR6251 (96-03)
Engine Mounting - Other			AR6908 Upper Subframe Bush AR6909 Lower Subframe Bush	
Transmission Mounting	AR8979 (Man.) AR8919 (Auto.)	AR7021 - LHS	AR7222	AR3030 (Pet.) AR3031 (Dies.)
FRONT SUSPENSION				
Exhaust Hanger - Front				
Upper Control Arm Bush - Inner	AR8906			
Upper Control Arm Bush - Outer	AR8906			
Lower Control Arm Bush - Inner	AR8907 - Front	AR5413 - Front	AR6899 - Front	AR6107 - Front
Lower Control Arm Bush - Outer	AR8915 - Rear AR8916 - Centre	AR6417 - Rear	AR9315 - Rear	AR6106 - Rear
Shock Rubber - Front				
Stabilizer Bar Bush	AR8917	AR7022 (ID: 19mm) AR7023 (ID: 21mm) AR7041 (ID: 23mm)		AR6108 - Inner AR6109 - Outer
Stabilizer Link Grommet	AR8918 Stabilizer Link			
Steering Coupling				
Steering Rack Mounting		AR7024 (2)		AR7030 - LHS (81-96) AR7031 - RHS (81-96) AR7033 (2) (96-03)
Strut Mounting	AR8980	AR7025	AR7129 (Excl. Bearing) AR7129B (Incl. Bearing)	AR2025
Tension Rod Bush				
Miscellaneous		AR7029 Front Axle X-Member Bush		AR123 Air Cleaner Mounting
REAR SUSPENSION				
Centre Bearing Rubber	AR9310			
Exhaust Hanger - Middle				AR5020
Exhaust Hanger - Rear		AR7005 Bracket		AR5020
Lower Control Arm Bush - Inner				
Lower Control Arm Bush - Outer				
Propshaft Coupling				
Shackle Bush - Front				AR6135 (2)
Shackle Bush - Rear Upper	AR8786			AR6130 (4)
Shackle Bush - Rear Lower	AR8785			AR6130 (4)
Stabilizer Bar Bush		AR7028 (ID: 18mm)		
Strut Mounting			AR7197	
Miscellaneous	AR8784 Rear Spring Front Eye Bush	AR7102 (2) Rear Axle Beam Bush	AR9313 Rear Axle Beam Bush	

APPLICATIONS	VW CADDY 1.6i Life Van, MPV - BGU 1.9 TDi, Life Van, MPV - BJB 2.0 SDi Van - BDJ	VW CADDY 2.0 TDi 5-Spd. Man. - CLCA 2.0 TDi - CFHC, CLCB	VW CC 2.0 TDi - CFGB 2.0 TSi - CCZB 3.6 FSi V6 4-Motion - BWS	VW CITI GOLF 1.3 L, Chico, L Shuttle 4-Spd. Man., Chico Lux 1.6 L, Chico Lux, Deco, Designa, Blues, Ritz, Shuttle, Sonic, Sport Chico 4/5-Spd. Man., 3-Spd. Auto., - HM 1.8 CTi, Designa, L Sport, 5-Spd. Man. - BZF
YEARS	04-16	2010-	2009-	83-02
Engine Configuration	TRANSVERSE	TRANSVERSE	TRANSVERSE	TRANSVERSE
Engine Mounting - Front				AR6105
Engine Mounting - Rear	AR6896 (1.6, 1.9) Support Mounting AR6898 (2.0) Support Mounting	AR6898	AR6898	
Engine Mounting - Left				AR6104A (OD: 64.4mm)
Engine Mounting - Right	AR6929 (1.6) AR7198 (1.9, 2.0)	AR7198	AR8042	AR6104 (OD: 74.6mm)
Engine Mounting - Other	AR6908 Upper Subframe Bush AR6909 Lower Subframe Bush	AR6908 Upper Subframe Bush AR6909 Lower Subframe Bush	AR6908 Upper Subframe Bush AR6909 Lower Subframe Bush	
Transmission Mounting	AR6918 - LHS (1.6) AR7222 - LHS (1.9, 2.0)	AR7222	AR7222	AR3030 (Man.) AR3031 (Auto.)
FRONT SUSPENSION				
Exhaust Hanger - Front				AR5020
Upper Control Arm Bush - Inner				
Upper Control Arm Bush - Outer				
Lower Control Arm Bush - Inner	AR6899 - Front	AR6899 - Front	AR6899 - Front	AR6107 - Front
Lower Control Arm Bush - Outer	AR6883 - Rear LHS AR6884 - Rear RHS	AR6883 - Rear LHS AR6884 - Rear RHS AR9315 (2011-)	AR6883 - Rear LHS AR6884 - Rear RHS	AR6106 - Rear
Shock Rubber - Front				
Stabilizer Bar Bush	AR7041 (ID: 23mm)			AR6108 - Inner AR6109 - Outer
Stabilizer Link Grommet				
Steering Coupling				
Steering Rack Mounting				AR7030 - LHS AR7031 - RHS
Strut Mounting	AR7129 (Excl. Bearing) AR7129B (Incl. Bearing)	AR7129 (Excl. Bearing) AR7129B (Incl. Bearing)	AR7129 (Excl. Bearing) AR7129B (Incl. Bearing)	AR2025
Tension Rod Bush				
Miscellaneous				AR123 Air Cleaner Mounting
REAR SUSPENSION				
Centre Bearing Rubber				
Exhaust Hanger - Middle				AR5020
Exhaust Hanger - Rear				AR5020
Lower Control Arm Bush - Inner				
Lower Control Arm Bush - Outer				
Propshaft Coupling				
Shackle Bush - Front				
Shackle Bush - Rear Upper	AR8248	AR8248		
Shackle Bush - Rear Lower	AR8249	AR8249		
Stabilizer Bar Bush	AR8247	AR8247	AR8252	AR6110 - Inner AR6111 - Outer
Stabilizer Link Grommet				
Strut Mounting				AR7037 - Upper AR7038 - Lower
Miscellaneous			AR6962 (2) Rear Axle Trailing Link Bush	AR7085 (2) Rear Axle Beam Bush

APPLICATIONS	VW CITI GOLF 1.4 L, Chico 1.4i, L, Citi.com, VeloCiti, TenaCiti, CitiStorm, Sport, Rox, Rhythm Man. - AGY, BSY 1.6i Life, Velociti, TenaCiti, CitiStorm, Sport, Rox 5-Spd. Man. - AFX	VW CRAFTER 2.0 BiTDi - CKTB, CSNB 2.5 TDi 35-Series SWB P/van, 50 HR-Series LWB, XLWB P/van - BJK, BJM	VW FOX 1.3 L, L Trippa 4-Spd. Man. 1.6 L 4/5-Spd. Man., 3-Spd. Auto. 1.8 L Sport 5-Spd. Man.	VW GOLF II 1.3 CL 4-Spd. Man. 1.6 CSL 5-Spd. Man. 1.8 GTS 16V, CSX, GTi 8V, 16V, 5-Spd. Man., 3-Spd. Auto. 2.0 GTi 8V, Exec. 16V 5-Spd. Man.
YEARS	99-09	2007-	87-96	84-92
Engine Configuration	TRANSVERSE	INLINE	TRANSVERSE	TRANSVERSE
Engine Mounting - Front	AR6171 Buffer		AR6105 Buffer	AR6181 (1.3, 1.6, 1.8) AR6117 (2.0)
Engine Mounting - Rear	AR6104 - Rear LHS	AR8610		
Engine Mounting - Left	AR7039 - Front LHS	AR8612	AR6104A (64.4mm)	AR6113 - Front LHS (1.3, 1.6, 1.8) AR6112 - Rear LHS (1.8, 2.0 GTi)
Engine Mounting - Right	AR6251	AR8612	AR6104 (74.6mm)	AR6114
Engine Mounting - Other				
Transmission Mounting	AR3030		AR3030 (Man.) AR3031 (Auto.)	
FRONT SUSPENSION				
Exhaust Hanger - Front	AR5020		AR5020	AR5020
Upper Control Arm Bush - Inner				
Upper Control Arm Bush - Outer				
Lower Control Arm Bush - Inner	AR6107 - Front	AR8605 - Front	AR6107 - Front	AR5413 - Front
Lower Control Arm Bush - Outer	AR6106 - Rear	AR8605 - Rear	AR6106 - Rear	AR5414 - Rear Old Design + Tube AR6417 - Rear New Design
Shock Rubber - Front				
Stabilizer Bar Bush	AR6108 - Inner AR6109 - Outer	AR8606	AR6108 - Inner AR6109 - Outer	AR6116
Stabilizer Link Grommet				AR7530 (79mm) Stabilizer Link AR7531 (76.5mm) Stabilizer Link
Steering Coupling				
Steering Rack Mounting	AR7033 (2)		AR7030 - LHS AR7031 - RHS	AR7033 (2) (M/S) AR7380 (2) (P/S)
Strut Mounting	AR2025	AR8607	AR2025	AR2024
Tension Rod Bush				
Miscellaneous	AR123 Air Cleaner Mounting		AR123 Air Cleaner Mounting	AR123 Air Cleaner Mounting
REAR SUSPENSION				
Centre Bearing Rubber		AR9312		
Exhaust Hanger - Middle	AR5020		AR5019	AR5291
Exhaust Hanger - Rear	AR5020		AR5019	AR5291
Lower Control Arm Bush - Inner				
Lower Control Arm Bush - Outer				
Propshaft Coupling				
Shackle Bush - Front		AR8614 (35" 2.0 BiTDi) AR8819 (50")		
Shackle Bush - Rear Upper				
Shackle Bush - Rear Lower		AR5222 (50") AR8614 (35" 2.0 BiTDi)		
Stabilizer Bar Bush	AR6110 - Inner AR6111 - Outer		AR6110 - Inner AR6111 - Outer	
Stabilizer Link Grommet				
Strut Mounting	AR7037 - Upper AR7038 - Lower		AR7037 - Upper AR7038 - Lower	AR7037 - Upper AR7038 - Lower
Miscellaneous	AR7085 (2) Rear Axle Beam Bush		AR7085 (2) Rear Axle Beam Bush	AR7096 (2) Rear Axle Beam Bush

APPLICATIONS	VW GOLF III 1.6 GS 5-Spd. Man. 1.8 GSX, GTS 5-Spd. Man., 3-Spd. Auto. 2.0 GTi, 8V GTi Exec. 5-Spd. Man. 2.8 VR6, VR6 Exec. V6 5-Spd. Man., 4-Spd. Auto.	VW GOLF IV 1.6i Comfortline, Std., Tiptronic 1.8 GTi HighLine 1.8T GTi 1.9 TDi HighLine, Comfortline, DSG 2.0i Cabrio, HighLine	VW GOLF V 1.6i Comfortline, Tiptronic, Trendline - BGU 1.9 TDi Comfortline, DSG - BLS, BXE	VW GOLF V 2.0 TDi DSG Sport, Sport Tiptronic, Sport 5-Spd. Man., 6-Spd. Auto. - BKD 2.0i Trendline, GTi DSG, Comfortline, GTi 5-Spd. Man., 6-Spd. Auto. - BLX 2.0 FSi Sport, Sport Tiptronic 6-Spd. Man., Auto. - BLY
YEARS	92-99	99-04	04-09	04-09
Engine Configuration	TRANSVERSE	TRANSVERSE	TRANSVERSE	TRANSVERSE
Engine Mounting - Front	AR6171			
Engine Mounting - Rear		AR7044 (Man.) Support Mounting AR6990 (Auto.) Support Mounting	AR6896 (Man.) Support Mounting AR6898 (Auto.) Support Mounting	AR6896 (Man.) Support Mounting AR6898 (Auto.) Support Mounting
Engine Mounting - Left				
Engine Mounting - Right	AR6251	AR7019	AR6929 (1.6) AR7198 (1.9)	AR6923 (2.0 TDi) AR8042 (2.0i, FSi)
Engine Mounting - Other		AR7029 Front Axle X-Member Bush	AR6908 Upper Subframe Bush AR6909 Lower Subframe Bush	AR6908 Upper Subframe Bush AR6909 Lower Subframe Bush
Transmission Mounting	AR7039 (1.6, 1.8, 2.0) AR7040 (2.8)	AR7021	AR7222 - LHS	AR7010 - LHS (Man.) (2.0 TDi) AR7222 - LHS (Alt.) (Auto./Man.)
FRONT SUSPENSION				
Exhaust Hanger - Front	AR7082	AR7082		
Upper Control Arm Bush - Inner				
Upper Control Arm Bush - Outer				
Lower Control Arm Bush - Inner	AR5413 - Front	AR5413 - Front	AR6899 - Front	AR6899 - Front
Lower Control Arm Bush - Outer	AR5414 - Rear Old Design + Tube AR6417 - Rear New Design	AR6417 - Rear New Design	AR6883 - Rear LHS AR6884 - Rear RHS	AR6883 - Rear LHS AR6884 - Rear RHS
Stabilizer Bar Bush	AR6116 (1.6, 1.8, 2.0)	AR7023 (ID: 21mm) AR7041 (ID: 23mm)	AR7023 (ID: 21mm) AR7041 (ID: 23mm) AR7126 (ID: 17mm)	AR7023 (ID: 21mm) AR7041 (ID: 23mm) AR7126 (ID: 17mm)
Stabilizer Link Grommet	AR7530 (79mm) (1.6, 1.8, 2.0) Stabilizer Link AR7531 (76.5mm) (1.6, 1.8, 2.0) Stabilizer Link AR7534 (2.8) Link Assembly	AR7042 (4)		
Steering Coupling				
Steering Rack Mounting	AR7033 (2) (M/S) AR7380 (2) (P/S)	AR7380	AR8250	AR8250
Strut Mounting	AR6180	AR7025 Rubber	AR7129 (Excl. Bearing) AR7129B (Incl. Bearing)	AR7129 (Excl. Bearing) AR7129B (Incl. Bearing)
Miscellaneous				
REAR SUSPENSION				
Exhaust Hanger - Middle	AR7082	AR7082		
Exhaust Hanger - Rear	AR7082	AR7005 Bracket		
Lower Control Arm Bush - Inner			AR6873	AR6873
Lower Control Arm Bush - Outer			AR6901	AR6901
Stabilizer Bar Bush		AR7028 AR7045 - Alt.		AR8251 (ID: 20mm) AR8252 (ID: 21mm)
Stabilizer Link Grommet				
Strut Mounting	AR7037 - Upper AR7038 - Lower	AR7026	AR7197	AR7197
Miscellaneous	AR7028 Rear Stabilizer Bar Bush AR7087 (2) Rear Axle Beam Bush	AR7102 (2) Rear Axle Beam Bush Kit	AR6930 Rear Axle Upper Inner - L/RHS AR6931 Rear Axle Upper Outer - L/RHS AR6957 Rear Axle Lateral Link Bush - Outer AR6958 Rear Axle Lateral Link Bush - Inner AR6962 Rear Axle Trailing Link Bush	AR6930 Rear Axle Upper Inner - L/RHS AR6931 Rear Axle Upper Outer - L/RHS AR6957 Rear Axle Lateral Link Bush - Outer AR6958 Rear Axle Lateral Link Bush - Inner AR6962 Rear Axle Trailing Link Bush

APPLICATIONS	VW GOLF VI 1.4 TSi Trendline, Comfortline, HighLine - CAXA, CAVD 1.6i Trendline - BSE, BSF, CCSA 1.6 TDi Comfortline, DSG, Bluemotion - CAYC 2.0 TDi HighLine - CBAB, CFFB 2.0 GTi DSG - CCZB 2.0 TSi-R 4-Motion, DSG	VW GOLF VII 1.2 TSi - CJZA 1.4 TSi - CHPA, CMBA, CPVA, CPTA, CXSA 2.0 TDi - CRBC, CRLB, CRMB, CRUA, CRVA, CYKB	VW JETTA II 1.6 CSL 5-Spd. Man. 1.8 CLi, CLi Exec., Executive, CLX, CSX 5-Spd. Man., 3-Spd. Auto. 2.0 L 16V 5-Spd. Man.	VW JETTA III 1.6 CSL 5-Spd. Man. 1.8 CLX, CSX 5-Spd. Man., 3-Spd. Auto. 2.0 CLi, CLi Exec. 5-Spd. Man. 2.8 VR6 Exec. V6 5-Spd. Man., 4-Spd. Auto.
YEARS	09-13	2013-	85-92	92-99
Engine Configuration	TRANSVERSE	TRANSVERSE	TRANSVERSE	TRANSVERSE
Engine Mounting - Front			AR6181 (1.6, 1.8) AR6117 (2.0)	AR6171
Engine Mounting - Rear	AR6896 (1.4 Man.) Support Mounting AR6898 Support Mounting (1.6 Auto., 2.0 GTi, TSi) AR8600 (TDi Only) Support Mounting	AR6898 (2.0) AR8912 (1.2, 1.4)		
Engine Mounting - Left			AR6113 - Front LHS	AR7039 - Front LHS AR7040 - Front LHS (VR6)
Engine Mounting - Right	AR6929 (1.4, 1.6) AR6923 (2.0) AR8042 (TSi) AR8603 (GTi)	AR8911 (1.2, 1.4)	AR6114	AR6251
Engine Mounting - Other	AR6908 Upper Subframe Bush AR6909 Lower Subframe Bush	AR6908 Upper Subframe Bush AR6909 Lower Subframe Bush		
Transmission Mounting	AR7222 - LHS AR7010 - LHS (Alt. - 2.0 Auto.)	AR7222 (2.0) AR8910 (1.2, 1.4)		
FRONT SUSPENSION				
Exhaust Hanger - Front			AR5020	AR7082
Upper Control Arm Bush - Inner				
Upper Control Arm Bush - Outer				
Lower Control Arm Bush - Inner	AR6899 - Front	AR6899 - Front	AR5413 - Front	AR5413 - Front
Lower Control Arm Bush - Outer	AR6883 - Rear LHS AR6884 - Rear RHS	AR6883 - Rear LHS AR6884 - Rear RHS	AR5414 - Rear (Old Design) AR6417 - Rear (New Design)	AR5414 - Rear (Old Design) AR6417 - Rear (New Design)
Shock Rubber - Front				
Stabilizer Bar Bush	AR7023 (ID: 21mm) AR7041 (ID: 23mm)		AR6116	AR6116
Stabilizer Link Grommet			AR7530 (79mm) Stabilizer Link AR7531 (76.5mm) Stabilizer Link	AR7530 (79mm) Stabilizer Link AR7531 (76.5mm) Stabilizer Link
Steering Coupling				
Steering Rack Mounting	AR8250		AR7033 (2) (M/S) AR7380 (2) (P/S)	AR7033 (2) (M/S) AR7380 (2) (P/S)
Strut Mounting	AR7129 (Excl. Bearing) AR7129B (Incl. Bearing)	AR8909	AR2024	AR6180
Miscellaneous			AR123 Air Cleaner Mounting	
REAR SUSPENSION				
Exhaust Hanger - Middle			AR5291	AR7082
Exhaust Hanger - Rear			AR5291	AR7082
Lower Control Arm Bush - Inner	AR6873			
Lower Control Arm Bush - Outer	AR6901			
Stabilizer Bar Bush				AR7028
Stabilizer Link Grommet				
Strut Mounting	AR7197		AR7037 - Upper AR7038 - Lower	AR7037 - Upper AR7038 - Lower
Miscellaneous	AR6930 Rear Axle Upper Inner - L/RHS AR6931 Rear Axle Upper Outer - L/RHS AR6957 Rear Axle Lateral Link Bush - Outer AR6958 Rear Axle Lateral Link Bush - Inner AR6962 Rear Axle Trailing Link Bush	AR8905 Rear Axle Beam Bush AR9314 Brake Pedal Rubber	AR7096 (2) Rear Axle Beam Bush	AR7087 (2) Rear Axle Beam Bush

APPLICATIONS	VW JETTA IV 1.6i Comfortline Std. 5-Spd. Man., 4-Spd. Auto. 1.9 TDi HighLine 5-Spd. Man. 2.0i HighLine 5-Spd. Man. 2.3 V5 5-Spd. Man.	VW JETTA V 1.4 TSi Trendline, Comfortline, DSG, High- Line - CAVD, CAXA 1.6 TDi Comfortline, DSG - CAYC	VW JETTA V 1.6i Comfortline, Tiptronic, Trendline 1.9 TDi Comfortline, DSG - BKC 2.0i Trendline, DSG, Comfortline, 5-Spd. Man., 6-Spd. Auto. - BHY 2.0 FSi, TFSi Sportline, Tiptronic 6-Spd. Man./Auto.	VW JETTA V 2.0 TDi Sportline, Tiptronic, HighLine 5-Spd. Man., 6-Spd. Auto. - AZV, BKD, BMM 2.0 TSi HighLine
YEARS	99-05	09-11	05-11	2005-
Engine Configuration	TRANSVERSE	TRANSVERSE	TRANSVERSE	TRANSVERSE
Engine Mounting - Front				
Engine Mounting - Rear	AR7044 Support Mounting	AR6896 Support Mounting AR6898 (1.6 TDi) Support Mounting	AR6896 (Man.) Support Mounting AR6898 (Auto.) Support Mounting	AR6896 Support Mounting (2.0 TDi Man.) AR6898 Support Mounting (2.0 TDi Auto., 2.0 TSi)
Engine Mounting - Left				
Engine Mounting - Right	AR7019	AR6929	AR6929 (1.6i) AR7198 (1.9 TDi) AR8042 (2.0i, TFSi)	AR6923 (2.0 TDi) AR8042 (2.0 TSi)
Engine Mounting - Other	AR7029 Front Axle X-Member Bush	AR6908 Upper Subframe Bush AR6909 Lower Subframe Bush	AR6908 Upper Subframe Bush AR6909 Lower Subframe Bush	AR6908 Upper Subframe Bush AR6909 Lower Subframe Bush
Transmission Mounting	AR7021	AR7222 - LHS	AR7222 - LHS	AR7222 - LHS AR7010 - LHS (Alt.) (2.0 TDi Man.)
FRONT SUSPENSION				
Exhaust Hanger - Front	AR7082			
Upper Control Arm Bush - Inner				
Upper Control Arm Bush - Outer				
Lower Control Arm Bush - Inner	AR5413 - Front	AR6899 - Front	AR6899 - Front	AR6899 - Front
Lower Control Arm Bush - Outer	AR5414 - Rear (Old Design) AR6417 - Rear (New Design)	AR6883 - Rear LHS AR6884 - Rear RHS	AR6883 - Rear LHS AR6884 - Rear RHS	AR6883 - Rear LHS AR6884 - Rear RHS
Shock Rubber - Front				
Stabilizer Bar Bush	AR7023 (ID: 21mm) AR7041 (ID: 23mm)	AR7023 (ID: 21mm) AR7041 (ID: 23mm)	AR7023 (ID: 21mm) AR7041 (ID: 23mm) AR7126 (ID: 17mm)	AR7023 (ID: 21mm) AR7041 (ID: 23mm) AR7126 (ID: 17mm) (2.0 TDi)
Stabilizer Link Grommet	AR7042 (4)			
Steering Coupling				
Steering Rack Mounting	AR7380	AR8250	AR8250	AR8250
Strut Mounting	AR7025 Rubber	AR7129 (Excl. Bearing) AR7129B (Incl. Bearing)	AR7129 (Excl. Bearing) AR7129B (Incl. Bearing)	AR7129 (Excl. Bearing) AR7129B (Incl. Bearing)
Tension Rod Bush				
Miscellaneous				
REAR SUSPENSION				
Centre Bearing Rubber				
Exhaust Hanger - Middle	AR7082			
Exhaust Hanger - Rear	AR7005 Bracket			
Lower Control Arm Bush - Inner		AR6873	AR6873	AR6873
Lower Control Arm Bush - Outer		AR6901	AR6901	AR6901
Stabilizer Bar Bush	AR7028 AR7045 - Alt.			
Stabilizer Link Grommet				
Strut Mounting		AR7197	AR7197	AR7197
Miscellaneous	AR7102 (2) Rear Axle Beam Bush Kit	AR6930 Rear Axle Upper Inner - L/RHS AR6931 Rear Axle Upper Outer - L/RHS AR6957 Rear Axle Lateral Link Bush - Outer AR6958 Rear Axle Lateral Link Bush - Inner AR6962 Rear Axle Trailing Link Bush	AR6930 Rear Axle Upper Inner - L/RHS AR6931 Rear Axle Upper Outer - L/RHS AR6957 Rear Axle Lateral Link Bush - Outer AR6958 Rear Axle Lateral Link Bush - Inner AR6962 Rear Axle Trailing Link Bush	AR6930 Rear Axle Upper Inner - L/RHS AR6931 Rear Axle Upper Outer - L/RHS AR6957 Rear Axle Lateral Link Bush - Outer AR6958 Rear Axle Lateral Link Bush - Inner AR6962 Rear Axle Trailing Link Bush

APPLICATIONS	VW JETTA VI 1.2 TSi - CBZB 1.4 TSi - CAVD, CAXA 1.6 TDi - CAYC 2.0 TDi - CFHC, CJAA, CLCB	VW KOMBI T2 / T3 1.8 Microbus, P/van, Volksiebus 1.9 Microbus, P/van 2.0 Microbus, P/van, L Exec. Bus, Kamper, P/up 2.1 Fi Caravelle, Microbus 2.3 Microbus, Volksiebus 2.5i Caravelle, Microbus 2.6i Caravelle, Microbus	VW KOMBI T3 4X4 2.1 Fi Syncro Pet. - DJ	VW KOMBI T4 2.5 TDi Microbus, Caravelle, Trend, High Dies. - AAB, ACV
YEARS	2011-	74-04	89-93	99-03
Engine Configuration	TRANSVERSE	INLINE	INLINE	INLINE
Engine Mounting - Front				
Engine Mounting - Rear	AR6896 (1.2) Support Mounting AR6898 (1.4, 1.6, 2.0) Support Mounting	AR6382 (2.3, 2.5, 2.6)		
Engine Mounting - Left		AR6136 (1.8) AR5318 (1.9, 2.0, 2.1)	AR5318	
Engine Mounting - Right	AR6929 (1.4) AR8042 (1.2, 1.6, 2.0)	AR6136 (1.8) AR5317 (1.9, 2.0, 2.1)	AR5317	AR7109 (Man.) AR7099 (Auto.)
Engine Mounting - Other	AR6908 Upper Subframe Bush AR6909 Lower Subframe Bush	AR7090 Engine Stabilizer Mounting AR7101 Bush on G.Box Pendulum Rod		AR7101 Bush on Gearbox Pendulum Rod
Transmission Mounting	AR7010 (2.0 Man.) AR7222 (1.2, 1.4, 1.6)	AR6128	AR7112	AR7088 for Mechanical Clutch AR7089 for Hydraulic Clutch
FRONT SUSPENSION				
Exhaust Hanger - Front				
Upper Control Arm Bush - Inner		AR6129 - Front	AR6129 - Front	
Upper Control Arm Bush - Outer		AR6129 - Rear	AR6129 - Rear	AR7107 - Rear
Lower Control Arm Bush - Inner	AR6899 - Front	AR6130	AR6130	
Lower Control Arm Bush - Outer	AR6883 - Rear LHS AR6884 - Rear RHS AR9315 - Alt.			AR7104
Shock Rubber - Front		AR6133	AR6133	AR6133
Stabilizer Bar Bush	AR7023 (ID: 21mm) AR7041 (ID: 23mm)	AR6131 (ID: 20mm)	AR6131 (ID: 20mm)	AR7106 (ID: 27mm)
Stabilizer Link Grommet		AR6132 (ID: 21mm) AR6133 - Lower (2)	AR6132 (ID: 21mm)	AR7108A Link Bush
Steering Coupling		AR7097	AR7097	
Steering Rack Mounting	AR8250	AR7093	AR7093	AR7093
Strut Mounting	AR7129 (Excl. Bearing) AR7129B (Incl. Bearing)			
Tension Rod Bush		AR7094 - Rear AR7095 - Front		
Miscellaneous		AR5028 Spark Plug Cap		
REAR SUSPENSION				
Centre Bearing Rubber				
Exhaust Hanger - Middle				
Exhaust Hanger - Rear				
Lower Control Arm Bush - Inner	AR6873	AR6134 - Front	AR6134	AR6134 Front Carrier Bush
Lower Control Arm Bush - Outer	AR6901	AR6134 - Rear	AR6134	AR6134 Rear Carrier Bush
Stabilizer Bar Bush				
Stabilizer Link Grommet				
Strut Mounting	AR7197			
Miscellaneous	AR6930 Rear Axle Upper Inner - L/RHS AR6931 Rear Axle Upper Outer - L/RHS AR6957 Rear Axle Lateral Link Bush - Outer AR6958 Rear Axle Lateral Link Bush - Inner AR6962 Rear Axle Trailing Link Bush			

APPLICATIONS	VW KOMBI T5 4X2, 4X4 1.9 TDi Crewbus, Microbus, Beach, Van, P/van, S/Cab, D/Cab P/up Dies. - AXC 2.0 TDi CAAB, CAAC, CCHA 2.0 BiTDi 4-Motion - CFCA 2.5 TDi Crewbus, Beach, California Microbus, Van, P/van, S/Cab, D/Cab, HO P/up Dies. - AXD	VW PASSAT IV 1.8T 5-Spd. Man., 5-Spd. Auto. 2.8 V6 Quattro, Quattro Tiptronic 5-Spd. Man., 5-Spd. Auto.	VW PASSAT V 1.8 TSi Comfortline, DSG, HighLine - BZB, CDAA 1.9 TDi Comfortline, DSG, HighLine - BKC, BLS, BXE 2.0 FSi, TFSi Comfortline, HighLine - AXX, BLR, BLY, BPY, BVY, BVZ, BWA, CAWB, CBFA, CCZ/TA 2.0 TDi Comfortline, HighLine, DSG - BMP 3.2 FSi Sportline, DSG - AXZ	VW PASSAT 1.8 TSi - CDAA 2.0 TDi - CFFB
	YEARS	04-10	99-05	05-11
Engine Configuration	INLINE / TRANSVERSE	TRANSVERSE	TRANSVERSE	TRANSVERSE
Engine Mounting - Front	AR8260			
Engine Mounting - Rear	AR8263 AR8265 - Alt. (2.5 4X4)		AR6896 (Man.) Support Mounting AR6898 (Auto.) Support Mounting	AR9316
Engine Mounting - Left		AR7060 (1.8)		
Engine Mounting - Right	AR8256 (1.9, 2.0) AR8259 (2.5)	AR7060 (1.8)	AR7198 (1.9) AR6923 (2.0 TDi) AR8042 (2.0 T/FSi, 3.2)	AR8042 (1.8) AR9317 (2.0)
Engine Mounting - Other		AR7189 Support Frame Bush - Front AR7188 Support Frame Bush - Rear	AR6908 Upper Subframe Bush AR6909 Lower Subframe Bush	AR6908 Upper Subframe Bush AR6909 Lower Subframe Bush
Transmission Mounting	AR8266 (1.9, 2.0) AR8269 (2.5 Man.) AR8270 (2.5 Auto.)	AR7058 - LHS AR7065 - RHS AR7067 (Auto.) AR7186 (Man.)	AR7222 - LHS (1.8, 1.9, 2.0 T/FSi) AR7010 - LHS (Alt.) (2.0 TDi, 3.2 Man.)	AR7010 (2.0) AR9857 (1.8)
FRONT SUSPENSION				
Exhaust Hanger - Front				
Upper Control Arm Bush - Inner		AR7072 - Front & Rear		
Upper Control Arm Bush - Outer				
Lower Control Arm Bush - Inner	AR8272 - Front	AR7068 - Front AR7069 - Rear	AR6899 - Front	AR6899 - Front
Lower Control Arm Bush - Outer	AR8271 - Rear	AR7177 - Front	AR6913 - Rear (Insert) AR9780 - Rear (Complete)	AR6913 - Rear (Insert) AR9780 - Rear (Complete)
Shock Rubber - Front				
Stabilizer Bar Bush	AR8273	AR7174 (ID: 24.8mm)	AR7041 (ID: 23mm)	
Stabilizer Link Grommet				
Steering Coupling				
Steering Rack Mounting				
Strut Mounting	AR8274	AR7071	AR7129 (Excl. Bearing) AR7129B (Incl. Bearing)	
Tension Rod Bush				
Miscellaneous				
REAR SUSPENSION				
Centre Bearing Rubber				
Exhaust Hanger - Middle				
Exhaust Hanger - Rear				
Lower Control Arm Bush - Inner	AR8281 Front Carrier Bush	AR7075		
Lower Control Arm Bush - Outer	AR8282 Rear Carrier Bush	AR7074		
Propshaft Coupling				
Shackle Bush - Front				
Shackle Bush - Rear Upper				
Shackle Bush - Rear Lower				
Stabilizer Bar Bush				
Stabilizer Link Grommet				
Strut Mounting				
Miscellaneous	AR8275 Rear Trailing Arm Bush - Outer AR8276 Rear Trailing Arm Bush - Inner AR8280 Rear Axle Beam Bush	AR7078 Lateral Link Bush to job 3BX 560 000 AR7079 Lateral Link Bush from job 3BX 560 001	AR6962 Rear Axle Beam Bush	

APPLICATIONS	VW POLO 6N 1.4i Classic, Playa 1.6i Classic Lux, Classic, Playa 1.8i Classic Lux, Playa 5-Spd. Man.	VW POLO 9N 1.4i, FSi Classic 5-Spd. Man. 62kw - AXU, 61kw - BLM 1.4 TDi Classic 5-Spd. Man. 55kw - AMF, BAY, 59kw - BMS, BNV 1.6i, Classic 5-Spd. Man. 74kw - BAH, 1.6i, Classic 5-Spd. Man., 4-Spd. Auto. 77kw - BTS	VW POLO 9N 1.8T GTi 6-Spd. Man. 110kw - BBU, BJX 1.9 TDi 5-Spd. Man. 74kw - ATD, AXR 96kw - ASZ, BLT 2.0i, Classic 85kw - BBX CROSS POLO [07-10] 1.6i 5-Spd. Man. 74kw - BAH 1.6 TDi 5-Spd. Man. 77kw - ATD, AXR 1.9 TDi 5-Spd. Man. 74kw - ATD, AXR	VW POLO 6R 1.2 TDi 55kw 5-Spd. Man. - CFWA 1.4i 63kw 5-Spd. Man., 7-Spd. DSG - CGGB, CLPA 1.4 TSi GTi 132kw 7-Spd. DSG - CAVE 1.6i 77kw 5-Spd. Man., 6-Spd. Auto. - CLSA 1.6 TDi 77kw 5-Spd. Man. - CAYC, CLNA
	YEARS	96-03	02-10	02-10
Engine Configuration	TRANSVERSE	TRANSVERSE	TRANSVERSE	TRANSVERSE
Engine Mounting - Front	AR6171			
Engine Mounting - Rear		AR7050 (1.4, 1.6 Man.) Support Mounting AR7051 - Alt. (1.4, 1.6 Man.) Support Mounting AR7066 (1.4 TDi) Support Mounting AR9969 (1.6 Auto.) Support Mounting	AR7050 (1.6) Support Mounting AR7051 - Alt. (1.6) Support Mounting AR7066 (1.8T, 1.9 TDi - 74kw) Support Mounting AR8255 (1.9 TDi - 96kw) Support Mounting AR1287 (2.0) Support Mounting	AR7050 (1.4 Man., 1.6 Man.) Support Mounting AR7051 - Alt. (1.4 Man., 1.6 Man.) Support Mounting AR7066 (1.2 TDi, 1.4 DSG, 1.6 TDi) Support Mounting AR9969 (1.6 Auto.) Support Mounting
Engine Mounting - Left				
Engine Mounting - Right	AR6251	AR7014	AR7014	AR7014 AR7008 - Alt. (1.4, 1.6)
Engine Mounting - Other				
Transmission Mounting	AR6915 (1.4i) AR7039 (1.6i, 1.8i)	AR6916	AR6916	AR6916
FRONT SUSPENSION				
Exhaust Hanger - Front				
Upper Control Arm Bush - Inner				
Upper Control Arm Bush - Outer				
Lower Control Arm Bush - Inner	AR5413 - Front	AR6911 - Front	AR6911 - Front	AR6911 - Front
Lower Control Arm Bush - Outer	AR5414 - Rear	AR6913 - Rear	AR6913 - Rear	AR6913 - Rear
Shock Rubber - Front				
Stabilizer Bar Bush	AR6116	AR7009 (ID: 18mm) AR9352 (ID: 16mm)	AR7009 (ID: 18mm) AR9352 (ID: 16mm)	AR7009 (ID: 18mm) AR9352 (ID: 16mm)
Stabilizer Link Grommet	AR7532 Stabilizer Link			
Steering Coupling				
Steering Rack Mounting	AR7033 (2) (M/S) AR7380 (2) (P/S)	AR8257	AR8257	AR8257
Strut Mounting	AR6180	AR6910	AR6910	AR6910
Tension Rod Bush				
Miscellaneous				
REAR SUSPENSION				
Centre Bearing Rubber				
Exhaust Hanger - Middle				
Exhaust Hanger - Rear				
Lower Control Arm Bush - Inner				
Lower Control Arm Bush - Outer				
Propshaft Coupling				
Shackle Bush - Front				
Shackle Bush - Rear Upper				
Shackle Bush - Rear Lower				
Stabilizer Bar Bush				
Stabilizer Link Grommet				
Strut Mounting	AR7037 - Upper AR7038 - Lower	AR7026	AR7026	AR7026
Miscellaneous	AR7084 (2) Rear Axle Beam Bush	AR7102 (2) Rear Axle Beam Bush Kit	AR7102 (2) Rear Axle Beam Bush Kit	AR7102 (2) Rear Axle Beam Bush Kit

APPLICATIONS	VW POLO 6C, GP 1.0 TSi 70kw 5-Spd. Man. - CHZB 1.0 TSi R-Line 81kw 7-Spd. DSG - CHZC	VW POLO 6C, GP 1.2 TSi 66kw 5-Spd. Man. - CJZC 1.2 TSi 81kw 5-Spd. Man., 7-Spd. DSG - CJZD	VW POLO 6C, GP 1.4i 63kw 5-Spd. Man. - CGGB, CLPA 1.4 TDi 55kw 5-Spd. Man. - CUSA, CYZB 1.4 TDi 77kw 5-Spd. Man. - CUTA, CYZA 1.6i 77kw 5-Spd. Man., 6-Spd. Auto. - CLSA	VW POLO 6C, GP 1.5 TDi 81kw 5-Spd. Man. 1.8 TSi GTi 141kw 6-Spd. Man. - DAJA, 7-Spd. DSG - DAJB
YEARS	2014-	2014-	2014-	2014-
Engine Configuration	TRANSVERSE	TRANSVERSE	TRANSVERSE	TRANSVERSE
Engine Mounting - Front				
Engine Mounting - Rear	AR9899 Support Mounting	AR1288 (1.2 Man.) Support Mounting AR9969 (1.2 DSG) Support Mounting	AR1289 (1.4 TDi) Support Mounting AR7050 (1.4, 1.6 Man.) Support Mounting AR7051 - Alt. (1.4, 1.6 Man.) Support Mounting AR9969 (1.6 Auto.) Support Mounting	AR8255 (1.8 Man.) Support Mounting AR1290 (1.8 DSG) Support Mounting
Engine Mounting - Left				
Engine Mounting - Right	AR9901	AR7014	AR7014 (1.4, 1.6) AR7008 - Alt. (1.4, 1.6) AR9901 (1.4 TDi)	AR9901
Engine Mounting - Other				
Transmission Mounting	AR6916	AR6916	AR6916	AR6916
FRONT SUSPENSION				
Exhaust Hanger - Front				
Upper Control Arm Bush - Inner				
Upper Control Arm Bush - Outer				
Lower Control Arm Bush - Inner	AR5413 - Front	AR5413 - Front	AR5413 - Front	AR5413 - Front
Lower Control Arm Bush - Outer	AR5414 - Rear	AR5414 - Rear	AR5414 - Rear	AR5414 - Rear
Shock Rubber - Front				
Stabilizer Bar Bush	AR7009 (ID: 18mm) AR9352 (ID: 16mm) AR9964 (ID: 17mm) (1.0)	AR7009 (ID: 18mm) AR9352 (ID: 16mm) AR9964 (ID: 17mm) (1.0)	AR7009 (ID: 18mm) AR9352 (ID: 16mm) AR9964 (ID: 17mm) (1.0)	AR7009 (ID: 18mm) AR9352 (ID: 16mm) AR9964 (ID: 17mm) (1.0)
Stabilizer Link Grommet				
Steering Coupling				
Steering Rack Mounting				
Strut Mounting	AR7025	AR7025	AR7025	AR7025
Tension Rod Bush				
Miscellaneous				
REAR SUSPENSION				
Centre Bearing Rubber				
Exhaust Hanger - Middle				
Exhaust Hanger - Rear				
Lower Control Arm Bush - Inner				
Lower Control Arm Bush - Outer				
Propshaft Coupling				
Shackle Bush - Front				
Shackle Bush - Rear Upper				
Shackle Bush - Rear Lower				
Stabilizer Bar Bush	AR7028 (1.0)	AR7028 (1.0)	AR7028 (1.0)	AR7028 (1.0)
Stabilizer Link Grommet				
Strut Mounting	AR7026	AR7026	AR7026	AR7026
Miscellaneous	AR7102 (2) Rear Axle Beam Bush Kit	AR7102 (2) Rear Axle Beam Bush Kit	AR7102 (2) Rear Axle Beam Bush Kit	AR7102 (2) Rear Axle Beam Bush Kit

APPLICATIONS	VW POLO "VIVO" I 1.4i 55kw 5-Spd. Man. - CLPB 1.4i 63kw - 5-Spd. Man., 6-Spd. Auto. - CLPA 1.6i 77kw 5-Spd. Man. - CLSA	VW POLO "VIVO" II 1.0 TSi GT 6-Spd. Man. - CHZC 1.4i 55kw 5-Spd. Man. - CLPB 1.4i 63kw - 5-Spd. Man. - CLPA 1.6i 77kw 5-Spd. Man., 6-Spd. Auto. - CLSA	VW SCIROCCO 1.4 TSi - CAVD 2.0 TSi, DSG, R - CDLF	VW SHARAN 1.8T MPV Man., - AJH, AWC 2.8 VR6 - AMY, AAA
YEARS	10-17	2018-	2009-	99-10
Engine Configuration	TRANSVERSE	TRANSVERSE	TRANSVERSE	INLINE
Engine Mounting - Front				
Engine Mounting - Rear	AR7050 (1.4 Man., 1.6) Support Mounting AR7051 - Alt. (1.4 Man., 1.6) Support Mounting AR9969 (1.4 Auto.) Support Mounting	AR9899 Support Mounting AR9966 - Alt. Support Mounting	AR6896 (1.4) Support Mounting AR6898 (2.0) Support Mounting	
Engine Mounting - Left				AR7114 (1.8 Man.) (99-01) AR7118 (2.8 Auto.) (99-01) AR7119 (2.8 Man.) (99-01)
Engine Mounting - Right	AR7014 AR7008 - Alt.	AR7008 (1.4, 1.6) AR9901 (1.0)	AR6929 (1.4) AR8042 (2.0)	AR7116 (1.8 Man.) (99-01) AR7120 (2.8 Auto.) (99-01) AR7121 (2.8 Man.) (99-01)
Engine Mounting - Other			AR6908 Upper Subframe Bush AR6909 Lower Subframe Bush	
Transmission Mounting	AR6916	AR6916	AR7222 - LHS	
FRONT SUSPENSION				
Exhaust Hanger - Front				AR7082
Upper Control Arm Bush - Inner				
Upper Control Arm Bush - Outer				
Lower Control Arm Bush - Inner	AR6911 - Front	AR5413 - Front	AR6899 - Front	AR7122 - Front
Lower Control Arm Bush - Outer	AR6417 - Rear	AR5414 - Rear	AR6883 - Rear LHS AR6884 - Rear RHS	AR7123 - Rear
Shock Rubber - Front				
Stabilizer Bar Bush	AR7009 (ID: 18mm) AR9352 (ID: 16mm)	AR7009 (ID: 18mm) AR9352 (ID: 16mm) AR9964 (ID: 17mm)	AR7023 (ID: 21mm) AR7041 (ID: 23mm)	AR7124
Stabilizer Link Grommet				
Steering Rack Mounting	AR8257		AR8250	AR7125
Strut Mounting	AR6910	AR7025	AR7129 (Excl. Bearing) AR7129B (Incl. Bearing)	AR6180
Tension Rod Bush				
Miscellaneous				
REAR SUSPENSION				
Centre Bearing Rubber				AR7127
Lower Control Arm Bush - Inner			AR6873	AR7122 - Front & Rear
Lower Control Arm Bush - Outer			AR6901	AR7128
Propshaft Coupling				AR7130 - Front AR7131 - Rear
Shackle Bush - Front				
Shackle Bush - Rear Upper				
Shackle Bush - Rear Lower				
Stabilizer Bar Bush				
Stabilizer Link Grommet				
Strut Mounting		AR7027	AR7197	
Miscellaneous	AR7102 (2) Rear Axle Beam Bush Kit	AR7102 (2) Rear Axle Beam Bush Kit	AR6930 Rear Axle Upper Inner - L/RHS AR6931 Rear Axle Upper Outer - L/RHS AR6957 Rear Axle Lateral Link Bush - Outer AR6958 Rear Axle Lateral Link Bush - Inner AR6962 Rear Axle Trailing Link Bush	

APPLICATIONS	VW TIGUAN 4X2, 4X4 1.4 TSi Trend&Fun, Track&Field - BWK, CAVA 2.0 TDi Track&Field, Sport&Style, Trend&Fun - CBAB 2.0 TSi Track&Field, Sport&Style, 4-Motion - CCZA	VW TIGUAN 4X2, 4X4 1.4 TSi - CAXA 1.4 TSi 4-Motion - CAVD, CTHD 2.0 TDi - CFFD 2.0 TSi 4-Motion - CCZB	VW TOUAREG 4X4 2.5 TDi R5 - BAC, BPE 3.0 TDi V6 - BKS, CATA, CASA, CASC, CNRB (06-08) 4.2 V8 - AXQ (04-07) 5.0 TDi V10 - AYH, BLE, BWF	VW TOUAREG 4X4 3.6 FSi V6 - BHK, BHL 4.2 V8 - BAR
YEARS	08-11	11-17	04-11	07-11
Engine Configuration	TRANSVERSE	TRANSVERSE	INLINE	INLINE
Engine Mounting - Front				
Engine Mounting - Rear	AR6896 (1.4) Support Mounting AR6898 (2.0) Support Mounting	AR9319 (6-Spd. Man.) AR9325 (6/7-Spd. Auto.)		
Engine Mounting - Left			AR9337 (5.0) AR9339 (2.5) AR9340 (4.2)	AR9340
Engine Mounting - Right	AR6929 (1.4) AR6923 (2.0 TDi) AR8042 (2.0 TSi)	AR6929 (1.4) AR9326 (2.0)	AR9337 (5.0) AR9339 (2.5) AR9340 (4.2)	AR9340
Engine Mounting - Other	AR6908 Upper Subframe Bush AR6909 Lower Subframe Bush	AR6908 Upper Subframe Bush AR6909 Lower Subframe Bush		
Transmission Mounting	AR7222 - LHS (1.4, Man. 2.0 TSi, Auto., DSG) (2.0 TDi Auto.) AR7010 - LHS (2.0 TDi Man.)	AR7010 AR9318 (Man.) AR9327 (Auto.)	AR9338	AR9338
FRONT SUSPENSION				
Exhaust Hanger - Front				
Upper Control Arm Bush - Inner			AR9329	AR9329
Upper Control Arm Bush - Outer			AR9329	AR9329
Lower Control Arm Bush - Inner	AR6899 - Front	AR6899 - Front	AR9330 - Front Inner AR9331 - Front Outer	AR9330 - Front Inner AR9331 - Front Outer
Lower Control Arm Bush - Outer	AR6883 - Rear LHS AR6884 - Rear RHS	AR6883 - Rear LHS AR6884 - Rear RHS	AR9332 - Rear	AR9332 - Rear
Stabilizer Bar Bush	AR7023 (ID: 21mm) AR7041 (ID: 23mm)		AR8827	AR8827
Stabilizer Link Grommet				
Steering Coupling				
Steering Rack Mounting	AR8250			
Strut Mounting	AR7129 (Excl. Bearing) AR7129B (Incl. Bearing)	AR7129 (Excl. Bearing) AR7129B (Incl. Bearing)	AR9334	AR9334
Miscellaneous			AR9333 Front Axle Beam Bush - Front & Rear L/RHS	AR9333 Front Axle Beam Bush - Front & Rear L/RHS
REAR SUSPENSION				
Centre Bearing Rubber	AR9322	AR9322		
Exhaust Hanger - Middle				
Exhaust Hanger - Rear				
Lower Control Arm Bush - Inner	AR6873	AR6873		
Lower Control Arm Bush - Outer	AR6901	AR6901		
Propshaft Coupling		AR9323 - Front AR9324 - Rear		
Stabilizer Bar Bush			AR8827	AR8827
Stabilizer Link Grommet				
Strut Mounting	AR7197		AR9334	AR9334
Miscellaneous	AR6930 Rear Axle Upper Inner - L/RHS AR6931 Rear Axle Upper Outer - L/RHS AR6957 Rear Axle Lateral Link Bush - Outer AR6958 Rear Axle Lateral Link Bush - Inner AR6962 Rear Axle Trailing Link Bush	AR9320 Carrier Bush - Front AR9321 Carrier Bush - Rear	AR9335 Brake Pedal Rubber AR9336 Accelerator Pedal Rubber	AR9335 Brake Pedal Rubber AR9336 Accelerator Pedal Rubber

APPLICATIONS	VW TOUAREG 4X4 3.0 TDi V6 - CASA, CNRB 3.6 FSi V6 - CGRA 4.2 TDi V8 - CKDA	VW TOURAN 1.6 5-Spd. Man. - BGU, BSE, BSF 1.9 TDi MPV TrendLine, DSG - BKC, BLS, BXE 2.0 FSi MPV HighLine - BLY 2.0 TDi MPV Comfortline, HighLine, DSG - AZV	VW TOURAN 1.2 TSi - CBZB 1.4 TSi - CAVC, CTHC 2.0 TDi - CFHF, CLCA	VW UP 1.0 - CHYB
YEARS	2010-	04-11	2011-	2015-
Engine Configuration	INLINE	TRANSVERSE	TRANSVERSE	TRANSVERSE
Engine Mounting - Front				
Engine Mounting - Rear		AR6896 (Man.) Support Mounting AR6898 (Auto.) Support Mounting	AR6896 (1.2, 1.4) AR6898 (2.0)	AR9355
Engine Mounting - Left	AR9341 (3.0) AR9342 (3.6) AR9343 (4.2)			AR9354
Engine Mounting - Right	AR9341 (3.0) AR9342 (3.6) AR9343 (4.2)	AR7198 (1.9) AR6923 (2.0 TDi) AR8042 (2.0 FSi)	AR6929 (1.2, 1.4) AR8042 (2.0)	AR9353
Engine Mounting - Other		AR6908 Upper Subframe Bush AR6909 Lower Subframe Bush		
Transmission Mounting	AR9338	AR7222 - LHS AR7010 - LHS (Alt.) (2.0 TDi Man.)	AR7010 (2.0) AR7222 (1.2, 1.4)	
FRONT SUSPENSION				
Exhaust Hanger - Front				
Upper Control Arm Bush - Inner	AR9344			
Upper Control Arm Bush - Outer	AR9344			
Lower Control Arm Bush - Inner	AR9330 - Front Inner AR9331 - Front Outer	AR6899 - Front	AR6899 - Front	AR5413 - Front
Lower Control Arm Bush - Outer	AR9332 - Rear	AR6883 - Rear LHS AR6884 - Rear RHS	AR6883 - Rear LHS AR6884 - Rear RHS	AR6417 - Rear
Shock Rubber - Front				
Stabilizer Bar Bush	AR8827	AR7041 (ID: 23mm)	AR7041 (ID: 23mm)	AR9352
Stabilizer Link Grommet				
Steering Coupling				
Steering Rack Mounting		AR8250	AR8250	
Strut Mounting	AR9347	AR7129 (Excl. Bearing) AR7129B (Incl. Bearing)	AR7129 (Excl. Bearing) AR7129B (Incl. Bearing)	AR7025
Tension Rod Bush				
Miscellaneous	AR9348 (3.0, 3.6) Front Axle Beam Bush AR9349 (4.2) Front Axle Beam Bush			
REAR SUSPENSION				
Exhaust Hanger - Middle				
Exhaust Hanger - Rear				
Lower Control Arm Bush - Inner		AR6873	AR6873	
Lower Control Arm Bush - Outer		AR6901	AR6901	
Stabilizer Bar Bush	AR8827			
Stabilizer Link Grommet				
Strut Mounting	AR9350	AR7197	AR7197	
Miscellaneous	AR9335 Brake Pedal Rubber AR9336 Accelerator Pedal Rubber	AR6930 Rear Axle Upper Inner - L/RHS AR6931 Rear Axle Upper Outer - L/RHS AR6957 Rear Axle Lateral Link Bush - Outer AR6958 Rear Axle Lateral Link Bush - Inner AR6962 Rear Axle Trailing Link Bush	AR6930 Rear Axle Upper Inner - L/RHS AR6931 Rear Axle Upper Outer - L/RHS AR6957 Rear Axle Lateral Link Bush - Outer AR6958 Rear Axle Lateral Link Bush - Inner AR6962 Rear Axle Trailing Link Bush	AR9351 Rear Axle Beam Bush

APPLICATIONS	VOLVO	VOLVO C30	VOLVO C70	VOLVO S40	VOLVO S40
		1.6 Pet. - B4164S3 1.6 D2 Dies. - D4162T 1.8 - B4184S11 2.0i - B4204S3 2.0D 2.5i - B5254T3/7	2.5 T5 Sedan - B5254T3/7	2.0T Sedan 4-Spd. Auto., 5-Spd.Man. - B4204T2/3	1.6 D2 - D4162T 1.8i - B4184S11 2.0 - B4204S3 2.0 D4 - D5204T 2.0D - D4204T
YEARS		07-13	06-13	97-04	04-12
Engine Configuration		TRANSVERSE	TRANSVERSE	TRANSVERSE	TRANSVERSE
Engine Mounting - Front					
Engine Mounting - Rear		AR8187 Body Side AR8616 (1.6 Dies., 1.8, 2.0) Engine Side AR8617 (2.5) Engine Side AR8617I Insert Only AR9601 (1.6 Pet.) Engine Side	AR8187 Body Side AR8617 Engine Side AR8617I Insert Only		AR8187 Body Side AR8616 (1.6, 1.8, 2.0) Engine Side AR8617 (2.0D) Engine Side AR8617I Insert Only
Engine Mounting - Left		AR9599 (2.5 Only)		AR7456 (Auto.)	AR9599 (2.0 D4)
Engine Mounting - Right		AR8826 (1.6 Pet., 1.8, 2.0) AR9124 (2.5) AR9598 (1.6 Dies.) AR9995 (2.0D)	AR9124	AR7455 (Auto.) AR7459 (Man.)	AR9598 (1.6) AR8826 (1.8, 2.0) AR9603 (2.0) AR9600 (2.0D) AR9995 - Alt. (2.0D)
Engine Mounting - Other					
Transmission Mounting		AR8186	AR8186	AR7490 (Auto.) AR7491 (Man.) AR8138 (97-00)	AR8186 (1.6, 1.8, 2.0, 2.0D)
		FRONT SUSPENSION			
Upper Control Arm Bush - Inner					
Upper Control Arm Bush - Outer					
Lower Control Arm Bush - Inner		AR8243 - Front	AR8243 - Front	AR7457 - Front	AR8243 - Front
Lower Control Arm Bush - Outer		AR8244 - Rear	AR8244 - Rear	AR7474 - Front Outer LHS AR7475 - Front Outer RHS	AR8244 - Rear
Stabilizer Bar Bush		AR8221 (ID: 16mm) AR8615 (ID: 18mm)			AR8221 (ID: 16mm) AR8615 (ID: 18mm)
Stabilizer Link Grommet					
Steering Coupling					
Steering Rack Mounting					
Strut Mounting		AR8193	AR8193	AR7458 AR9053 - Alt. 1 AR9961 - Alt. 2	AR8193 AR9961 - Alt.
Miscellaneous					
		REAR SUSPENSION			
Centre Bearing Rubber					
Exhaust Hanger - Middle					
Exhaust Hanger - Rear					
Lower Control Arm Bush - Inner					
Lower Control Arm Bush - Outer					
Propshaft Coupling					
Shackle Bush - Front					
Shackle Bush - Rear Upper					
Shackle Bush - Rear Lower					
Stabilizer Bar Bush		AR9602 (ID: 16.5mm)			AR9602 (ID: 16.5mm)
Stabilizer Link Grommet					
Strut Mounting					
Miscellaneous		AR8245 Rear Subframe Bush AR8246 Rear Lateral Link Bush	AR8245 Rear Subframe Bush AR8246 Rear Lateral Link Bush	AR7462 (259mm) Rear Axle Rod - RHS AR7463 (225mm) Rear Axle Rod - LHS AR7482 (143mm) Rear Axle Rod - L/RHS AR7379 Radius Arm Bush AR7476 Rear Axle Bush	AR8245 Rear Subframe Bush AR8246 Rear Lateral Link Bush











APPLICATIONS	VOLVO S40 2.4 D5 - D5244T13 2.4i - B5244S4 2.5i T5 - B5254T3/7	VOLVO S60 2.0T - B5204T5 2.3 T5 - B5234T3 2.4 - B5244S 2.4 D5 - D5244T/4 2.4 T5 - B5244T5 2.5 R 4X4 - B5244T4 2.5T - B5254T2	VOLVO V40 2.0T Estate, 5-Spd. Man., 4-Spd. Auto. - B4204S, B4204T2	VOLVO V40 1.6 D2 - D4162T 1.6 T3 - B4164T3 1.6 T4 - B4164T 2.0 D3 - D5204T6 2.0 D4 Cross Country - D5204T4 2.5 T5 - B5254T12
YEARS	04-12	03-09	97-04	2012-
Engine Configuration	TRANSVERSE	TRANSVERSE	TRANSVERSE	TRANSVERSE
Engine Mounting - Front		AR7309 - Centre AR7513 Lower Torque Rod Mounting AR9606 - Centre (2.4 D5)		
Engine Mounting - Rear	AR8187 Body Side AR8617 AR8617I Insert Only	AR7321 AR8624 (2.4 D5)		AR8187 Body Side AR8617 (2.0, 2.5) Engine Side AR8617I Insert Only AR9604 (1.6) Engine Side
Engine Mounting - Left	AR8186 (2.4, 2.5) AR9599 (2.0 D5)		AR7456 (Auto.)	AR8186 (1.6) AR9599 (2.0, 2.5)
Engine Mounting - Right	AR9124 (2.4i, 2.5) AR9603 (2.4)	AR7310	AR7455 (Auto.) AR7459 (Man.)	AR9124 (T5 2.5) AR9598 (D2 1.6) AR9603 (D3/4 2.0) AR9640 (T3/4 1.6)
Engine Mounting - Other				
Transmission Mounting			AR7490 (Auto.) AR7491 (Man.)	
FRONT SUSPENSION				
Upper Control Arm Bush - Inner				
Upper Control Arm Bush - Outer				
Lower Control Arm Bush - Inner	AR8243 - Front	AR7485 - Front	AR7457 - Front	AR8243 - Front
Lower Control Arm Bush - Outer	AR8244 - Rear	AR7486 - Rear	AR7474 - Front Outer LHS AR7475 - Front Outer RHS	AR8244 AR9464L - Alt. AR9464R - Alt. (Bigger Bracket)
Stabilizer Bar Bush	AR8221 (ID: 16mm) AR8615 (ID: 18mm)			AR9425 (ID 23.5mm)
Stabilizer Link Grommet				
Steering Coupling				
Steering Rack Mounting				
Strut Mounting	AR8193	AR8622 - Upper AR8623 - Lower	AR7458 AR9053 - Alt.	AR9605
Miscellaneous				
REAR SUSPENSION				
Centre Bearing Rubber				
Exhaust Hanger - Middle				
Exhaust Hanger - Rear				
Lower Control Arm Bush - Inner				
Lower Control Arm Bush - Outer				
Propshaft Coupling				
Shackle Bush - Front				
Shackle Bush - Rear Upper				
Shackle Bush - Rear Lower				
Stabilizer Bar Bush	AR9602 (ID: 16.5mm)			
Stabilizer Link Grommet				
Strut Mounting				
Miscellaneous	AR8245 Rear Subframe Bush AR8246 Rear Lateral Link Bush	AR7477 Rear Axle Beam Bush - Front AR7478 Rear Axle Beam Bush - Rear	AR7379 Radius Arm Bush AR7462 (259mm) Rear Axle Rod - RHS AR7463 (225mm) Rear Axle Rod - LHS AR7476 Rear Axle Bush AR7482 (143mm) Rear Axle Rod - L/RHS	





APPLICATIONS	VOLVO V50 1.8 2.0i Sedan R-Design, Powershift - B4204S3 2.0D VS Sedan - B5244S 2.4 D5 2.4i VS T5 Sedan - B5252FS 2.5i T5 Sedan R-Design, Geartronic - B5254T3/7	VOLVO S70 2.4 Estate - B5254S 2.5T R Sedan, Estate 5-Spd. Man., 4-Spd. Auto. - D5252T V70 2.3 T5 Sedan, Estate - B5234T4	VOLVO XC70 4X4 2.4 D5 Estate, SUV, Geartronic - B5244T3/4 2.5 T5 Estate, SUV, Geartronic - B5254T2	VOLVO XC70 4X4 2.4 D5 Estate, SUV, Geartronic - D5244T5/10/14/16 2.5 T5 Estate, SUV, Geartronic - B5254T2 3.2 Estate, SUV, Geartronic - B6324S
YEARS	04-12	97-04	99-07	2007-
Engine Configuration	TRANSVERSE	TRANSVERSE	TRANSVERSE	TRANSVERSE
Engine Mounting - Front		AR7464 AR7513 Lower Torque Rod Mounting AR7465 Insert for AR7513	AR7309 - Centre AR7513 Lower Torque Rod Mounting AR7465 Insert for AR7513	AR7309 - Centre AR7513 Lower Torque Rod Mounting AR7465 Insert for AR7513
Engine Mounting - Rear	AR8187 Body Side AR8616 - Alt. (2.0) Engine Side AR8617 - Alt. (2.4, 2.5) Engine Side AR8617I Insert Only	AR7377 - Lower		
Engine Mounting - Left		AR7349		
Engine Mounting - Right	AR8185 AR9995 (2.0D)	AR7310	AR7310	AR7310 AR8619 - Alt.
Engine Mounting - Other				
Transmission Mounting	AR8186	AR7321 (2.3, 2.4) AR7299 (2.5)	AR7321	AR7321
FRONT SUSPENSION				
Upper Control Arm Bush - Inner				
Upper Control Arm Bush - Outer				
Lower Control Arm Bush - Inner	AR8243 - Front	AR8243 - Front	AR7485 - Front	AR7485 - Front
Lower Control Arm Bush - Outer	AR8244 - Rear	AR8244 - Rear	AR7486 - Rear	AR7486 - Rear
Stabilizer Bar Bush	AR8221 (ID: 16mm) AR8615 (ID: 18mm)			
Stabilizer Link Grommet				
Steering Coupling				
Steering Rack Mounting				
Strut Mounting	AR8193	AR7470 - Upper AR7487 - Upper (Alt.) AR7488 - Lower	AR7470 - Upper AR7488 - Lower	
Miscellaneous		AR7382 Axle Frame Mounting - Front Axle Subframe - Front AR7383 Axle Frame Mounting for Front Axle Subframe - Rear RHS AR7384 Axle Frame Mounting for Front Axle Subframe - Rear LHS		AR7382 Axle Frame Mounting - Front Axle Subframe - Front AR7383 Axle Frame Mounting for Front Axle Subframe - Rear RHS AR7384 Axle Frame Mounting for Front Axle Subframe - Rear LHS
REAR SUSPENSION				
Lower Control Arm Bush - Inner		AR7499 - L/RHS		
Lower Control Arm Bush - Outer		AR7500 - Upper L/RHS		
Propshaft Coupling				
Stabilizer Bar Bush				
Stabilizer Link Grommet				
Strut Mounting				
Miscellaneous	AR8245 Rear Subframe Bush AR8246 Rear Lateral Link Bush	AR7477 Axle Frame Mounting for Rear Axle Support AR7478 Axle Frame Mounting for Rear Axle Support - Upper Rear L/RHS AR7479 Rear Axle Upper Front Cross Strut Bearing Axle Support - L/RHS AR7502 Rear Axle Upper Front - L/RHS AR7503 Cross Strut Bush at Wheel Carrier	AR7477 Axle Frame Mounting for Rear Axle Support - Front AR7478 Axle Frame Mounting for Rear Axle Support - Rear	

APPLICATIONS	VOLVO XC90 2.4i D5 5/7-Seater SUV Geartronic, R-Design, Exec. - D5244T4 2.5 T5 5/7-Seater SUV Geartronic - B5254T2	VOLVO XC90 2.9 T6 5/7-Seater SUV - B6294T 3.2 5/7-Seater SUV Geartronic, R-Design - B6324S 4.4 7-Seater SUV Geartronic, Executive, R-Design - B8444S		
	YEARS	2003-	2003-	
	Engine Configuration	TRANSVERSE	TRANSVERSE	
	Engine Mounting - Front	AR7309 - Centre AR7513 Lower Torque Rod Mounting	AR7309 - Centre (All, except 4.4) AR8626 - Lower (All, except 4.4)	
	Engine Mounting - Rear			
	Engine Mounting - Left			
	Engine Mounting - Right	AR7310	AR8625 (All, except 4.4)	
	Engine Mounting - Other			
	Transmission Mounting	AR7321 (2.5) AR8624 (2.4)	AR7365 (All, except 4.4)	
	FRONT SUSPENSION			
Upper Control Arm Bush - Inner				
Upper Control Arm Bush - Outer				
Lower Control Arm Bush - Inner	AR8620 - Front	AR8620 - Front		
Lower Control Arm Bush - Outer	AR8621 - Rear	AR8621 - Rear		
Stabilizer Bar Bush				
Stabilizer Link Grommet				
Steering Coupling				
Steering Rack Mounting				
Strut Mounting	AR8622 - Upper AR8623 - Lower	AR8622 - Upper AR8623 - Lower		
Miscellaneous	AR7382 Axle Frame Mounting for Front Axle Subframe - Front AR7383 Axle Frame Mounting for Front Axle Subframe - Rear RHS AR7384 Axle Frame Mounting for Front Axle Subframe - LHS	AR7382 Axle Frame Mounting for Front Axle Subframe - Front AR7383 Axle Frame Mounting for Front Axle Subframe - Rear RHS AR7384 Axle Frame Mounting for Front Axle Subframe - LHS		
REAR SUSPENSION				
Centre Bearing Rubber				
Exhaust Hanger - Middle				
Exhaust Hanger - Rear				
Lower Control Arm Bush - Inner				
Lower Control Arm Bush - Outer				
Propshaft Coupling				
Shackle Bush - Front				
Shackle Bush - Rear Upper				
Shackle Bush - Rear Lower				
Stabilizer Bar Bush				
Stabilizer Link Grommet				
Strut Mounting				
Miscellaneous	AR7383 Axle Frame Mounting for Rear Axle Support - RHS AR7384 Axle Frame Mounting for Rear Axle Support - LHS	AR7383 Axle Frame Mounting for Rear Axle Support - RHS AR7384 Axle Frame Mounting for Rear Axle Support - LHS		







ENGINE MOUNTING & RUBBER BUYERS GUIDE













187

	AR1001 Volkswagen Beetle - All Models (61-79) Engine Mounting - Front
	AR1002 Hyundai Grand i10 (BA) (G3LA) 1.0 5-Spd. Man., 4-Spd. Auto. (2014-) Engine Mounting - Rear
	AR1004 Hyundai Grand i10 (BA) (G3LA) 1.0 5-Spd. Man., (G4LA) 1.25 5-Spd. Man. (2014-) Transmission Mounting
	AR1005 Hyundai Grand i10 (BA) (G3LA) 1.0 4-Spd. Auto., (G4LA) 1.25 4-Spd. Auto. (2014-) Engine Mounting - Front
	AR1006 Hyundai Grand i10 (BA) (G3LA) 1.0 5-Spd. Man., 4-Spd. Auto., (G4LA) 1.25 5-Spd. Man., 4-Spd. Auto. (2014-) Engine Mounting - RHS
	AR1007 Hyundai Grand i10 (BA) (G3LA) 1.0 5-Spd. Man., (G4LA) 1.25 5-Spd. Man. (2014-) Brake Pedal
	AR1008 Hyundai Grand i10 (BA) (G3LA) 1.0 4-Spd. Auto., (G4LA) 1.25 4-Spd. Auto. (2014-) Brake Pedal
	AR1009 Hyundai Grand i10 (BA) (G4LA) 1.25 5-Spd. Man., 4-Spd. Auto. (2014-) Engine Mounting - Rear
	AR1010 Hyundai Grand i10 (BA) (G3LA) 1.0 5-Spd. Man., 4-Spd. Auto., (G4LA) 1.25 5-Spd. Man., 4-Spd. Auto. (2014-) Front Stabilizer Bar Bush
	AR1011 Hyundai Grand i10 (BA) (G3LA) 1.0 5-Spd. Man., 4-Spd. Auto., (G4LA) 1.25 5-Spd. Man., 4-Spd. Auto. (2014-) Front Strut Mounting
	AR1012 Hyundai Grand i10 (BA) (G3LA) 1.0 5-Spd. Man., 4-Spd. Auto., (G4LA) 1.25 5-Spd. Man., 4-Spd. Auto. (2014-) Rear Axle Beam Bush
	AR1013 BMW 1-Series (F20, F21) 118i (B38B15A) 1.5 (2015-), 3-Series (F30) 318i (B38B15A) 1.5 (2015-) Engine Mounting - LHS
	AR1014 BMW 1-Series (F20, F21) 118i (B38B15A) 1.5 (2015-), 3-Series (F30) 318i (B38B15A) 1.5 (2015-) Engine Mounting - RHS

	AR1015 Honda CR-V II (RD) 4X4 (K20A4) 2.0i SWB SUV Man. (05-09) Engine Mounting - Front
	AR1016 Honda CR-V II (RD) 4X4 (K20A4) 2.0i SWB SUV Man. (05-09) Engine Mounting - Rear
	AR1017 Honda CR-V II (RD) 4X4 (K20A4) 2.0i SWB SUV Man. (05-09) Transmission Mounting
	AR1019 Brake Pedal Rubber BMW 1-Series (F20, F21) 116i (N13B16A) 1.6, 118i (B38B15A) 1.5, (N13B16A) 1.6, 120d (B47D20A) 2.0, 120i (N13B16A) 1.6, (B48B20A) 2.0, 125i (B48B20B, N20B20A) 2.0, M135i (N55B30A) 3.0 (11-19), 2-Series (F22, F23) 220d (B47D20A) 2.0 Coupe, 220i (B48B20A, N20B20A/B) 2.0 Coupe, 228i (N20B20A, N26B20A) 2.0 Coupe, 230i (B46B20B, B48B20A) 2.0 Coupe, M235i (N55B30A) 3.0 Coupe, M240i (B58B30A) 3.0 Coupe (14-19), 3-Series (F30, F31) 316i (N13B16A) 1.6, 318i (B38A15A) 1.6, 320d (N47D20A) 2.0, 320i (B48B20A, N20B20A/B/D) 2.0, 328i (N20B20A) 2.0, 330d (N57D30A) 3.0, 330i (B46B20A, B48B20A) 2.0, 335i (N55B30A) 3.0, 340i (B58B30A) 3.0 (12-19), (F34) 320d GT (B47D20A, N47D20C) 2.0, 320i GT (N20B20A/B) 2.0, 328i GT (N20B20A, N26B20A) 2.0, 335i GT (N55B30A) 3.0, 340i GT (B58B30A) 3.0 (2013-), 4-Series (F32) 420d (B47B20A, N47D20C) 2.0 Coupe, 420i (N20B20A/B) 2.0 Coupe, 428i (N20B20A, N26B20A) 2.0 Coupe, 430i (B46B20B, B48B20B) 2.0 Coupe, 435i (N55B30A) 3.0 Coupe, 440i (B58B30A) 3.0 Coupe (2014-), (F33) 420i (N20B20B) 2.0 Cabriolet, 428i (N20B20A, N26B20A) 2.0 Cabriolet, 430i (B48B20B) 2.0 Cabriolet, 435i (N55B30A) 3.0 Cabriolet, 440i (B58B30A) 3.0 Cabriolet (2014-), (F36) 420d (B47B20A, N47D20C) 2.0 Gran Coupe, 420i (N20B20B) 2.0 Gran Coupe, 428i (N20B20A, N26B20A) 2.0 Gran Coupe, 430i (B48B20B) 2.0 Gran Coupe, 435i (N55B30A) 3.0 Gran Coupe, 440i (B58B30A) 3.0 Gran Coupe (2014-) - Man. Models
	AR1020 Brake Pedal Rubber BMW 1-Series (F20, F21) 116i (N13B16A) 1.6, 118i (B38B15A) 1.5, (N13B16A) 1.6, 120d (B47D20A) 2.0, 120i (N13B16A) 1.6, (B48B20A) 2.0, 125i (B48B20B, N20B20A) 2.0, M135i (N55B30A) 3.0 (11-19), 2-Series (F22, F23) 220d (B47D20A) 2.0 Coupe, 220i (B48B20A, N20B20A/B) 2.0 Coupe, 228i (N20B20A, N26B20A) 2.0 Coupe, 230i (B46B20B, B48B20A) 2.0 Coupe, M235i (N55B30A) 3.0 Coupe, M240i (B58B30A) 3.0 Coupe (14-19), 3-Series (F30, F31) 316i (N13B16A) 1.6, 318i (B38A15A) 1.6, 320d (N47D20A) 2.0, 320i (B48B20A, N20B20A/B/D) 2.0, 328i (N20B20A) 2.0, 330d (N57D30A) 3.0, 330i (B46B20A, B48B20A) 2.0, 335i (N55B30A) 3.0, 340i (B58B30A) 3.0 (12-19), (F34) 320d GT (B47D20A, N47D20C) 2.0, 320i GT (N20B20A/B) 2.0, 328i GT (N20B20A, N26B20A) 2.0, 335i GT (N55B30A) 3.0, 340i GT (B58B30A) 3.0 (2013-), 4-Series (F32) 420d (B47B20A, N47D20C) 2.0 Coupe, 420i (N20B20A/B) 2.0 Coupe, 428i (N20B20A, N26B20A) 2.0 Coupe, 430i (B46B20B, B48B20B) 2.0 Coupe, 435i (N55B30A) 3.0 Coupe, 440i (B58B30A) 3.0 Coupe (2014-), (F33) 420i (N20B20B) 2.0 Cabriolet, 428i (N20B20A, N26B20A) 2.0 Cabriolet, 430i (B48B20B) 2.0 Cabriolet, 435i (N55B30A) 3.0 Cabriolet, 440i (B58B30A) 3.0 Cabriolet (2014-), (F36) 420d (B47B20A, N47D20C) 2.0 Gran Coupe, 420i (N20B20B) 2.0 Gran Coupe, 428i (N20B20A, N26B20A) 2.0 Gran Coupe, 430i (B48B20B) 2.0 Gran Coupe, 435i (N55B30A) 3.0 Gran Coupe, 440i (B58B30A) 3.0 Gran Coupe (2014-) - Auto. Models

ENGINE MOUNTING & RUBBER BUYERS GUIDE

	<p>AR1029 Lower Trailing Arm - Front L/RHS BMW 1-Series (F20, F21) 116i (N13B16A) 1.6, 118i (B38B15A) 1.5, (N13B16A) 1.6, 120d (B47D20A) 2.0, 120i (N13B16A) 1.6, (B48B20A) 2.0, 125i (B48B20B, N20B20A) 2.0, M135i (N55B30A) 3.0 (11-19), 2-Series (F22, F23) 220d (B47D20A) 2.0 Coupe, 220i (B48B20A, N20B20A/B) 2.0 Coupe, 228i (N20B20A, N26B20A) 2.0 Coupe, 230i (B46B20B, B48B20A) 2.0 Coupe, M235i (N55B30A) 3.0 Coupe, M240i (B58B30A) 3.0 Coupe (14-19), 3-Series (F30, F31) 316i (N13B16A) 1.6, 318i (B38A15A) 1.6, 320d (N47D20A) 2.0, 320i (B48B20A, N20B20A/B/D) 2.0, 328i (N20B20A) 2.0, 330d (N57D30A) 3.0, 330i (B46B20A, B48B20A) 2.0, 335i (N55B30A) 3.0, 340i (B58B30A) 3.0 (12-19), (F34) 320d GT (B47D20A, N47D20C) 2.0, 320i GT (N20B20A/B) 2.0, 328i GT (N20B20A, N26B20A) 2.0, 335i GT (N55B30A) 3.0, 340i GT (B58B30A) 3.0 (2013-), 4-Series (F32) 420d (B47B20A, N47D20C) 2.0 Coupe, 420i (N20B20A/B) 2.0 Coupe, 428i (N20B20A, N26B20A) 2.0 Coupe, 430i (B46B20B, B48B20B) 2.0 Coupe, 435i (N55B30A) 3.0 Coupe, 440i (B58B30A) 3.0 Coupe (2014-), (F33) 420i (N20B20B) 2.0 Cabriolet, 428i (N20B20A, N26B20A) 2.0 Cabriolet, 430i (B48B20B) 2.0 Cabriolet, 435i (N55B30A) 3.0 Cabriolet, 440i (B58B30A) 3.0 Cabriolet (2014-), (F36) 420d (B47B20A, N47D20C) 2.0 Gran Coupe, 420i (N20B20B) 2.0 Gran Coupe, 428i (N20B20A, N26B20A) 2.0 Gran Coupe, 430i (B48B20B) 2.0 Gran Coupe, 435i (N55B30A) 3.0 Gran Coupe, 440i (B58B30A) 3.0 Gran Coupe (2014-)</p>
	<p>AR1030 Lower Trailing Arm - Rear L/RHS BMW 1-Series (F20, F21) 116i (N13B16A) 1.6, 118i (B38B15A) 1.5, (N13B16A) 1.6, 120d (B47D20A) 2.0, 120i (N13B16A) 1.6, (B48B20A) 2.0, 125i (B48B20B, N20B20A) 2.0, M135i (N55B30A) 3.0 (11-19), 2-Series (F22, F23) 220d (B47D20A) 2.0 Coupe, 220i (B48B20A, N20B20A/B) 2.0 Coupe, 228i (N20B20A, N26B20A) 2.0 Coupe, 230i (B46B20B, B48B20A) 2.0 Coupe, M235i (N55B30A) 3.0 Coupe, M240i (B58B30A) 3.0 Coupe (14-19), 3-Series (F30, F31) 316i (N13B16A) 1.6, 318i (B38A15A) 1.6, 320d (N47D20A) 2.0, 320i (B48B20A, N20B20A/B/D) 2.0, 328i (N20B20A) 2.0, 330d (N57D30A) 3.0, 330i (B46B20A, B48B20A) 2.0, 335i (N55B30A) 3.0, 340i (B58B30A) 3.0 (12-19), (F34) 320d GT (B47D20A, N47D20C) 2.0, 320i GT (N20B20A/B) 2.0, 328i GT (N20B20A, N26B20A) 2.0, 335i GT (N55B30A) 3.0, 340i GT (B58B30A) 3.0 (2013-), 4-Series (F32) 420d (B47B20A, N47D20C) 2.0 Coupe, 420i (N20B20A/B) 2.0 Coupe, 428i (N20B20A, N26B20A) 2.0 Coupe, 430i (B46B20B, B48B20B) 2.0 Coupe, 435i (N55B30A) 3.0 Coupe, 440i (B58B30A) 3.0 Coupe (2014-), (F33) 420i (N20B20B) 2.0 Cabriolet, 428i (N20B20A, N26B20A) 2.0 Cabriolet, 430i (B48B20B) 2.0 Cabriolet, 435i (N55B30A) 3.0 Cabriolet, 440i (B58B30A) 3.0 Cabriolet (2014-), (F36) 420d (B47B20A, N47D20C) 2.0 Gran Coupe, 420i (N20B20B) 2.0 Gran Coupe, 428i (N20B20A, N26B20A) 2.0 Gran Coupe, 430i (B48B20B) 2.0 Gran Coupe, 435i (N55B30A) 3.0 Gran Coupe, 440i (B58B30A) 3.0 Gran Coupe (2014-)</p>
	<p>AR1031 Engine Mounting - LHS BMW 1-Series (F20, F21) 120i (B48B20A) 2.0 (11-19), 2-Series (F22, F23) 230i (B46B20B, B48B20A) 2.0 Coupe (14-19), 3-Series (F30, F31) 320i (B48B20A) 2.0, 330i (B46B20A, B48B20A) 2.0 (12-19), 4-Series (F32) 430i (B46B20B, B48B20B) 2.0 Coupe, (F33) 430i (B48B20B) 2.0 Cabriolet, (F36) 430i (B48B20B) 2.0 Gran Coupe (2014-)</p>
	<p>AR1032 Engine Mounting - RHS BMW 1-Series (F20, F21) 120i (B48B20A) 2.0 (11-19), 2-Series (F22, F23) 230i (B46B20B, B48B20A) 2.0 Coupe (14-19), 3-Series (F30, F31) 320i (B48B20A) 2.0, 330i (B46B20A, B48B20A) 2.0 (12-19), 4-Series (F32) 430i (B46B20B, B48B20B) 2.0 Coupe, (F33) 430i (B48B20B) 2.0 Cabriolet, (F36) 430i (B48B20B) 2.0 Gran Coupe (2014-)</p>
	<p>AR1033 Centre Bearing Rubber BMW 3-Series (F34) 320d GT (B47D20A) 2.0, 320i GT (N20B20A/B) 2.0, 328i GT (N20B20A, N26B20A) 2.0, 335i GT (N55B30A) 3.0 (2013-)</p>
	<p>AR1035 Centre Bearing Rubber BMW 3-Series (F30, F31) 330d (N57D30A) 3.0 (12-19)</p>

	<p>AR1037 Engine Mounting - LHS BMW 1-Series (F20, F21) 120d (B47D20A) 2.0 (11-19), 2-Series (F22, F23) 220d (B47D20A) 2.0 Coupe (14-19), 3-Series (F34) 320d GT (B47D20A) 2.0 (2015-), 4-Series (F32) 420d (B47B20A) 2.0 Coupe (2014-), (F36) 420d (B47B20A) 2.0 Gran Coupe (2014-)</p>
	<p>AR1038 Engine Mounting - RHS BMW 1-Series (F20, F21) 120d (B47D20A) 2.0 (11-19), 2-Series (F22, F23) 220d (B47D20A) 2.0 Coupe (14-19), 3-Series (F34) 320d GT (B47D20A) 2.0 (2015-), 4-Series (F32) 420d (B47B20A) 2.0 Coupe (2014-), (F36) 420d (B47B20A) 2.0 Gran Coupe (2014-)</p>
	<p>AR1039 Engine Mounting - LHS BMW 3-Series (F30, F31) 330d (N57D30A) 3.0 (12-19)</p>
	<p>AR1040 Engine Mounting - RHS BMW 3-Series (F30, F31) 330d (N57D30A) 3.0 (12-19)</p>
	<p>AR1041 Front Lower Control Arm Bush - Inner Chevrolet Spark (M150) (F8CV) 0.8 L, LS, (B10S) 1.0 LS, LT (03-05), Spark, Spark Lite (M200, M250) (F8CV) 0.8 L, LS, (B10S1) 1.0 LS, LT (2005-); Daewoo Matiz (F8CV) 800cc S, SE (99-03)</p>
	<p>AR1042 Front Stabilizer Bar Bush Nissan Terrano II (R20) 4X4 (TD27TI) 2.7 TDi SUV (98-07)</p>
	<p>AR1044 Engine Mounting - Rear Torque Rod Nissan Micra (K14) (H4B408, HR09DET) 0.9T (2018-)</p>
	<p>AR1045 Engine Mounting - RHS Nissan Micra (K14) (H4B408, HR09DET) 0.9T (2018-)</p>
	<p>AR1046 Engine Mounting - L/RHS Ford Escort MKI, MK II 1.1 300 SWB P/van Kent Pet., 1.3 30/35/45 SWB P/van Kent Pet., 1.6 45 P/van SWB P/van Kent Pet. (68-81)</p>
	<p>AR1046A Engine Mounting - L/RHS Ford Escort MKI, MK II 1.6 45 P/van SWB P/van Kent Pet. (68-81)</p>
	<p>AR1047 Engine Mounting - Rear Datsun GO+ (HR12DE) 1.2 (2014-)</p>
	<p>AR1048 Engine Mounting - LHS Datsun GO+ (HR12DE) 1.2 (2014-)</p>
	<p>AR1049 Engine Mounting - RHS Datsun GO+ (HR12DE) 1.2 (2014-)</p>

BARTOLD
 NO PICTURE AVAILABLE AT TIME OF PRINT

ENGINE MOUNTING & RUBBER BUYERS GUIDE

	AR1050 Nissan Qashqai (J10, J11) (MR20DE) 2.0 Acenta, +2, CVT SUV (07-15) Engine Mounting - RHS		AR1064 Chevrolet Captiva (C100, C140) (LF1, LFW) 3.0 6-Spd. Auto. AWD (2011-) Transmission Mounting
	AR1051 Nissan Qashqai I (J10) 4X2 (MR20DE) 2.0 Acenta 6-Spd. Man. (08-13), X-Trail (T31) 4X2 (MR20DE) 2.0 6-Spd. Man. (07-15) Transmission Mounting		AR1065 Chevrolet Captiva (C100, C140) (Z22D1) 2.2D LTZ 6-Spd. Auto. AWD, 4X2, (LE5) 2.4 LT 6-Spd. Auto. 4X2, (LE9) 2.4 LT 6-Spd. Man. 4X2, (LF1, LFW) 3.0 6-Spd. Auto. AWD (2011-) Rear Stabilizer Link Grommet
	AR1052 Chevrolet Captiva (C100, C140) (Z22D1) 2.2D LTZ 6-Spd. Auto. AWD, 4X2 (2011-) Engine Mounting - Front		AR1066 Chevrolet Captiva (C100, C140) (Z22D1) 2.2D LTZ 6-Spd. Auto. AWD, 4X2, (LE5) 2.4 LT 6-Spd. Auto. 4X2, (LE9) 2.4 LT 6-Spd. Man. 4X2, (LF1, LFW) 3.0 6-Spd. Auto. AWD (2011-) Rear Lateral Link - Lower
	AR1053 Chevrolet Captiva (C100, C140) (Z22D1) 2.2D LTZ 6-Spd. Auto. AWD, 4X2 (2011-) Engine Mounting - Rear		AR1067 Chevrolet Captiva (C100, C140) (Z22D1) 2.2D LTZ 6-Spd. Auto. AWD, 4X2, (LE5) 2.4 LT 6-Spd. Auto. 4X2, (LE9) 2.4 LT 6-Spd. Man. 4X2, (LF1, LFW) 3.0 6-Spd. Auto. AWD (2011-) Rear Lateral Link - Upper
	AR1054 Chevrolet Captiva (C100, C140) (Z22D1) 2.2D LTZ 6-Spd. Auto. AWD, 4X2 (2011-) Engine Mounting - RHS		AR1068 Chevrolet Utility (LDP) 1.3 CDTi S/cab P/up (2013-) Exhaust Hanger - Front
	AR1055 Chevrolet Captiva (C100, C140) (Z22D1) 2.2D LTZ 6-Spd. Auto. AWD, 4X2 (2011-) Transmission Mounting		AR1069 Chevrolet Cruze (Z20D1) 2.0D, LS 6-Spd. Man. (2012-) Transmission Mounting
	AR1056 Chevrolet Captiva (C100, C140) (LE5) 2.4 LT 6-Spd. Auto. 4X2, (LE9) 2.4 LT 6-Spd. Man. 4X2 (2011-) Engine Mounting - Front		AR1070 Chevrolet Cruze (B14NET) 1.4T, LS 6-Spd. Auto. (2012-); Opel Astra J (B14NET) 1.4T Auto. (2010-) Transmission Mounting
	AR1057 Chevrolet Captiva (C100, C140) (LE5) 2.4 LT 6-Spd. Auto. 4X2, (LE9) 2.4 LT 6-Spd. Man. 4X2 (2011-) Engine Mounting - Rear		AR1071 Chevrolet Cruze (A14NET) 1.4T, LS 6-Spd. Man. (2012-); Opel Astra J (A14NET) 1.4T Man., (A16LET) 1.6T Cosmo, Sport (2010-) Transmission Mounting
	AR1058 Chevrolet Captiva (C100, C140) (LE5) 2.4 LT 6-Spd. Auto. 4X2, (LE9) 2.4 LT 6-Spd. Man. 4X2 (2011-) Engine Mounting - RHS		AR1074 Chevrolet Cruze (A14NET) 1.4T, LS 6-Spd. Man. (2012-); Opel Astra J (A14NET) 1.4T Man., (A16LET) 1.6T Cosmo, Sport (2010-) Engine Mounting - Front
	AR1059 Chevrolet Captiva (C100, C140) (LE5) 2.4 LT 6-Spd. Auto. 4X2, (LE9) 2.4 LT 6-Spd. Man. 4X2 (2011-) Transmission Mounting		AR1075 Chevrolet Cruze (A14NET) 1.4T, LS 6-Spd. Man., (B14NET) 1.4T, LS 6-Spd. Auto., (F16D4) 1.6 5-Spd. Man., (F18D4) 1.8, LS 5-Spd. Man., (F18D4) 1.8, LS 6-Spd. Auto., (Z20D1) 2.0D, LS, LT 6-Spd. Man./Auto., (Z20S1) 2.0D, L 5-Spd. Man. (2012-); Opel Astra J (A14NET) 1.4T Man., (B14NET) 1.4T Auto., (A16LET) 1.6T Cosmo, Sport, (A16XER) 1.6 Essentia, (B20NFT) 2.0T OPC (2010-) Exhaust Hanger - Front
	AR1060 Chevrolet Captiva (C100, C140) (LF1, LFW) 3.0 6-Spd. Auto. AWD (2011-) Engine Mounting - Front		AR1076 Chevrolet Cruze (F16D4) 1.6 5-Spd. Man., (F18D4) 1.8, LS 5-Spd. Man. (2012-), Orlando (J309) (F18D4) 1.8L 5-Spd. Man. MPV (2012-) Transmission Mounting
	AR1061 Chevrolet Captiva (C100, C140) (LF1, LFW) 3.0 6-Spd. Auto. AWD (2011-) Engine Mounting - Rear		AR1077 Chevrolet Cruze (Z20D1) 2.0D, LS, LT 6-Spd. Man./Auto. (2012-) Engine Mounting - RHS
	AR1062 Chevrolet Captiva (C100, C140) (LF1, LFW) 3.0 6-Spd. Auto. AWD (2011-) Engine Mounting - RHS		AR1078 Chevrolet Cruze (Z20S1) 2.0D, L 5-Spd. Man. (2012-) Engine Mounting - RHS

ENGINE MOUNTING & RUBBER BUYERS GUIDE

191

	AR1079 Engine Mounting - Front Chevrolet Cruze (Z20D13) 2.0D, LT 6-Spd. Auto. (2012-)
	AR1080 Engine Mounting - Front Chevrolet Cruze (Z20S1) 2.0D, L 5-Spd. Man. (2012-)
	AR1081 Transmission Mounting Chevrolet Cruze (Z20D13) 2.0D, LT 6-Spd. Auto. (2012-)
	AR1082 Transmission Mounting Chevrolet Cruze (Z20S1) 2.0D, L 5-Spd. Man. (2012-)
	AR1083L Tension Rod Bush - LHS (with Bracket) Chevrolet Utility 1.3D AC, Club, Sport, 1.4 AC, Club, Sport, 1.8 AC, Club, Sport (2010-)
	AR1083R Tension Rod Bush - RHS (with Bracket) Chevrolet Utility 1.3D AC, Club, Sport, 1.4 AC, Club, Sport, 1.8 AC, Club, Sport (2010-)
	AR1084 Rear Stabilizer Bar Bush Chevrolet Trailblazer 4X2, 4X4 (LVN) 2.5 LT 5-Spd. Man., (A9J6, LWH) 2.8 LTZ 5-Spd. Man., (LFX) 3.6 LTZ (2012-)
	AR1085 Rear Upper Trailing Link Chevrolet Trailblazer 4X2, 4X4 (LVN) 2.5 LT 5-Spd. Man., (A9J6, LWH) 2.8 LTZ 5-Spd. Man., (LFX) 3.6 LTZ (2012-)
	AR1086 Rear Lower Trailing Link Chevrolet Trailblazer 4X2, 4X4 (LVN) 2.5 LT 5-Spd. Man., (A9J6, LWH) 2.8 LTZ 5-Spd. Man., (LFX) 3.6 LTZ (2012-)
	AR1087 Rear Trailing Link Chevrolet Trailblazer 4X2, 4X4 (LVN) 2.5 LT 5-Spd. Man., (A9J6, LWH) 2.8 LTZ 5-Spd. Man., (LFX) 3.6 LTZ (2012-)
	AR1088 Engine Mounting - Rear Citroen C3 (SC) (ZMZ-EB0) 1.0i VTi 68 Attraction, (HMZ-EB2, HMZ-EB2F) 1.2i VTi 82 Attraction, Seduction (2013-), C4 Cactus (HMZ-EB2F) 1.2 PureTech AWD (2015-), DS3 (HMZ-EB2, HMZ-EB2F) 1.2 VTi 82 Design Hatchback, Cabriolet (2013-); Peugeot 208 (CA, CC) (ZMZ-EB0) 1.0 Acces, Pop'Art, Puretech, (HMZ-EB2, HMZ-EB2F) 1.2 Access, Active, Puretech (2012-)
	AR1089 Engine Mounting - RHS Citroen C3 (SC) (8FP-EP3C) 1.4i VTi 95 Attraction+, Seduction, (5FS-EP6C) 1.6i VTi 120 Exclusive, Seduction (2010-), DS3 (5FS-EP6C) 1.6i VTi 120 (2010-); Peugeot 208 (CU) (5FS-EP6C) 1.6 Active, Allure (2013-), 208 (CA) (8FS-EP3, EP3C) 1.6 Active, Allure, (5FS-EP6C) 1.6 Allure (2012-)

	AR1090 Front Lower Control Arm Bush - Front Citroen C3 (SC) (ZMZ-EB0) 1.0i VTi 68 Attraction, (HMZ-EB2, HMZ-EB2F) 1.2i VTi 82 Attraction, Seduction (2013-), (K6E-TU3A, KFT-TU3AE5) 1.4i Attraction, (8FP-EP3C) 1.4i VTi 95 Attraction+, Seduction, (9HJ-DV6DTE4) 1.6 HDi 90 Seduction, (5FS-EP6C) 1.6i VTi 120 Exclusive, Seduction (2010-), DS3 (HNZ-EB2DT) 1.2 THP 110, (HMZ-EB2, HMZ-EB2F) 1.2 VTi 82 Design (2013-), (5FM-EP6DT) 1.6 PureTech e-THP Sport, (9HP-DV6DTE4) 1.6 e-HDi 90 Style Sport, (5FD-EP6DTS) 1.6 VTi Racing, (5FR-EP6DT, 5FV-EP6CDT) 1.6 THP 155 Sport, Ultra Prestige, Hatchback, Cabriolet, (5FS-EP6C) 1.6 VTi 120 Style, Design, Sport, Techno, Hatchback, Cabriolet (2010-); Peugeot 208 (CU) (HNP-EB2ADT, HNV-EB2DTM, HNZ-EB2DT) 1.2 THP 110, Active, Allure, Puretech, (9HP-DV6DTE4) 1.6 HDi Active, Allure, (5FS-EP6C) 1.6 VTi Active, Allure (2013-), 208 (CA, CC) (ZMZ-EB0) 1.0 Access, Pop'Art, Puretech, (HMZ-EB2, HMZ-EB2F) 1.2 Access, Active, Puretech, (HNP-EB2ADT, HNV-EB2DTM, HNZ-EB2DT) 1.2 THP 110, GT-Line, Puretech, Turbo, (5FS-EP6C) 1.6 Active, Allure, (5FU-EP6CDTX) 1.6 GTi, (5GR-EP6FDTX) 1.6 GTi THP, (9HJ-DV6DTE4, 9HP-DV6DTE4) 1.6 HDi Active, (9HD-DV6C) 1.6 HDi Allure (2012-)
	AR1091 Front Lower Control Arm Bush - Rear Citroen C3 (SC) (ZMZ-EB0) 1.0i VTi 68 Attraction, (HMZ-EB2, HMZ-EB2F) 1.2i VTi 82 Attraction, Seduction (2013-), (K6E-TU3A, KFT-TU3AE5) 1.4i Attraction, (8FP-EP3C) 1.4i VTi 95 Attraction+, Seduction, (9HJ-DV6DTE4) 1.6 HDi 90 Seduction, (5FS-EP6C) 1.6i VTi 120 Exclusive, Seduction (2010-), DS3 (HNZ-EB2DT) 1.2 THP 110, (HMZ-EB2, HMZ-EB2F) 1.2 VTi 82 Design (2013-), (5FM-EP6DT) 1.6 PureTech e-THP Sport, (9HP-DV6DTE4) 1.6 e-HDi 90 Style Sport, (5FD-EP6DTS) 1.6 VTi Racing, (5FR-EP6DT, 5FV-EP6CDT) 1.6 THP 155 Sport, Ultra Prestige, Hatchback, Cabriolet, (5FS-EP6C) 1.6 VTi 120 Style, Design, Sport, Techno, Hatchback, Cabriolet (2010-); Peugeot 208 (CU) (HNP-EB2ADT, HNV-EB2DTM, HNZ-EB2DT) 1.2 THP 110, Active, Allure, Puretech, (9HP-DV6DTE4) 1.6 HDi Active, Allure, (5FS-EP6C) 1.6 VTi Active, Allure (2013-), 208 (CA, CC) (ZMZ-EB0) 1.0 Access, Pop'Art, Puretech, (HMZ-EB2, HMZ-EB2F) 1.2 Access, Active, Puretech, (HNP-EB2ADT, HNV-EB2DTM, HNZ-EB2DT) 1.2 THP 110, GT-Line, Puretech, Turbo, (5FS-EP6C) 1.6 Active, Allure, (5FU-EP6CDTX) 1.6 GTi, (5GR-EP6FDTX) 1.6 GTi THP, (9HJ-DV6DTE4, 9HP-DV6DTE4) 1.6 HDi Active, (9HD-DV6C) 1.6 HDi Allure (2012-)
	AR1092 Transmission Mounting Citroen C4 (B7) (5FS-EP6C) 1.6 VTi 120 Attraction, Exclusive, Seduction (2010-), DS4 (5FS-EP6C) 1.6 VTi 120 Design, Style, Sport (2011-); Peugeot 308 (4A, 4C) (5FX-EP6DT) 1.6 THP 16V Premium, XT Hatchback, (5FV-EP6CDT) 1.6 VTi Active, Premium Hatchback (2007-), CC (4B) (5FX-EP6DT, 5FV-EP6CDT) 1.6 THP 16V Cabriolet (2009-)
	AR1093 Rear Axle Beam Bush Citroen C4 (LA) (5FW-EP6) 1.6 VTi 120 Seduction Coupe, (RFK-EW10J4S) 2.0 VTS 16V Coupe (2005-), C4 (LC) (5FW-EP6) 1.6 VTi 120 Attraction, Exclusive, Seduction Hatchback, (5FX-EP6DT) 1.6 THP 150 Exclusive Hatchback (2010-); Peugeot 307 (3A/C) (NFU-TU5JP4) 1.6 X-Line, XR, XT, 16V (9HY-DV6TE4, 9HZ-DV6TE4) 1.6 HDi 110 Design, XS, (RFJ-EW10A, RFN-EW10J4) 2.0 XS 16V, (RHY-DW10TD) 2.0 XS HDi (2001-)
	AR1094 Engine Mounting - RHS Citroen C4 (LA) (5FW-EP6) 1.6 VTi 120 Seduction Coupe (2010-), C4 (LC) (5FW-EP6) 1.6 VTi 120 Attraction, Exclusive, Seduction Hatchback (2010-), C4 (B7) (5FS-EP6C) 1.6 VTi 120 Attraction, Exclusive, Seduction (2010-), C4 Picasso VTi 120 (5FS-EP6C) 1.6 Seduction MPV (2011-)
	AR1095 Transmission Mounting Chevrolet Spark, Spark Lite (M200, M250) (F8CV) 0.8 5-Spd. Man., (B10S1) 1.0 5-Spd. Man. (2005-)

ENGINE MOUNTING & RUBBER BUYERS GUIDE









	AR1096 Engine Mounting - RHS Chevrolet Spark (M300) (B12D1) 1.2 5-Spd. Man. Campus, Curved, Pronto (2010-)		AR1106 Front Strut Mounting Citroen C4 Picasso (9HC-DV6C, BHX-DV6FC) 1.6 e-Hdi Intensive, Seduction MPV, (5FS-EP6C) 1.6 VTi 120 Seduction MPV, (5GZ-EP6FDT) 1.6 e-THP Intensive MPV (2011-); Peugeot 3008 (5FV-EP6CDT) 1.6 THP Active, Executive, Premium, (5FS-EP6C, 5FW-EP6) 1.6 VTi Access, Comfort, (RHH-DW10CTED4) 2.0 HDi Allure, Executive, (AHX-DW10FD, RHE-DW10CTED4) 2.0 HDi Active, Allure, Executive, Premium, Premium Grip (2010-), 308 (LB, LP) (HNP-EB2ADT, HNV-EB2DTM, HNZ-EB2DT) 1.2 THP 110 Active, (HNY-EB2DTS) 1.2 THP 130 Allure, GT-Line, GT (5GT-EP6FDTX) 1.6 e-THP (2015-), 5008 (MC, MJ, MR) (AHX-DW10FD) 2.0 HDi Active MPV (2011-)
	AR1097 Transmission Mounting Chevrolet Spark (M300) (B12D1) 1.2 5-Spd. Man. Campus, Curved, Pronto (2010-)		AR1107 Front Strut Mounting Citroen C3 (SC) (ZMZ-EB0) 1.0 VTi 68 Attraction, (HMZ-EB2, HMZ-EB2F) 1.2 VTi 82 Attraction, Seduction, (K6E-TU3A, KFT-TU3AE5) 1.4i Attraction, (8FP-EP3C) 1.4i VTi 95 Attraction, Seduction, (9HJ-DV6DTEDEM, 9HP-DV6DTEDEM) 1.6 eHDi 90 Seduction, (9HX-DV6ATED4) 1.6 HDi 90 Seduction, (5FS-EP6C) 1.6i VTi 120 Exclusive, Seduction (2010-), C3 Picasso (5FS-EP6C, 5FW-EP6) 1.6i VTi 120 Seduction, Panoramic (2010-), C4 Cactus (HNP-EB2ADT, HNV-EB2DTM, HNZ-EB2DT) 1.2 PureTech e-THP AWD, (HMZ-EB2F) 1.2 PureTech AWD (2015-), DS3 (HNZ-EB2DT) 1.2 PureTech e-THP Style, (HMZ-EB2, HMZ-EB2F) 1.2 VTi 82 Design, (5FM-EP6DT) 1.6 PureTech e-THP Sport, (9HP-DV6DTEDEM) 1.6 e-HDi 90 Style, Sport, (5FD-EP6DTS) 1.6 VTi Racing, (5FR-EP6DT, 5FV-EP6CDT) 1.6 THP 150, 155 Sport, Ultra Prestige, (5FS-EP6C) 1.6 VTi 120 Style, Design, Sport, Techno, (HNZ-EB2DT) 1.2 PureTech e-THP Style Cabriolet, (HMZ-EB2F) 1.2 VTi 82 Design Cabriolet, (5FV-EP6CDT) 1.6 THP 155 Sport Cabriolet, (5FS-EP6C) 1.6 VTi 120 Style Cabriolet (2010-); Peugeot 208 (CU) (HNP-EB2ADT, HNV-EB2DTM, HNZ-EB2DT) 1.2 THP 110 Active, Allure, GT-Line, PureTech, (9HP-DV6DTEDEM) 1.6 HDi Active, Allure, (5FS-EP6C) 1.6 Active, Allure (2017-), 208 (CA, CC) (ZMZ-EB0) 1.0 Access, Pop'Art, Puretech, (HNP-EB2ADT, HNV-EB2DTM, HNZ-EB2DT) 1.2 GT Line Puretech Turbo, (HMZ-EB2, HMZ-EB2F) 1.2 Access, Active, Puretech, (5FS-EP6C) 1.6 Active, Allure, (5FU-EP6CDTX) 1.6 GTi, (5GR-EP6FDTX) 1.6 THP GTi, (9HJ-DV6DTEDEM, 9HP-DV6DTEDEM) 1.6 HDi Active, (9HD-DV6C) 1.6 HDi Allure (2012-)
	AR1098L Rear Trailing Arm Bush - LHS Hyundai iX35 4X2, 4X4 (G4KD) 2.0 CRDi, (G4KE) 2.4 (2010-)		AR1108 Engine Mounting - Rear Citroen C4 Picasso (9HC-DV6C, BHX-DV6FC) 1.6 e-HDi Intensive, Seduction MPV, (5FS-EP6C) 1.6 VTi 120 Seduction MPV, (5GZ-EP6FDT) 1.6 e-THP Intensive MPV (2011-); Peugeot 3008 (5FV-EP6CDT) 1.6 THP Active, Executive, Premium, (5FS-EP6C, 5FW-EP6) 1.6 VTi Access, Comfort, (RHH-DW10CTED4) 2.0 HDi Allure, Executive, (AHX-DW10FD, RHE-DW10CTED4) 2.0 HDi Active, Allure, Executive, Premium, Premium Grip (2010-), (HNS-EB2ADTS, HNY-EB2DTS) 1.2 THP Active, (5GY-EP6FDTM, 5GZ-EP6FDT) 1.6 THP Active, Allure, GT-Line (2017-), 308 (CA, LB, LP) (HNP-EB2ADT, HNV-EB2DTM, HNZ-EB2DT) 1.2 THP 110 Active, PureTech, (HNY-EB2DTS) 1.2 THP 130 Allure, GT-Line, Puretech, (5GT-EP6FDTX) 1.6 GT e-THP (2015-), 5008 (MC, MJ, MR) (AHX-DW10FD) 2.0 HDi Active MPV (2011-)
	AR1098R Rear Trailing Arm Bush - RHS Hyundai iX35 4X2, 4X4 (G4KD) 2.0 CRDi, (G4KE) 2.4 (2010-)		AR1109 Engine Mounting - RHS Citroen Grand C4 Picasso (5FW-EP6) 1.6 VTi 120 Seduction MPV (2011-), C4 Picasso (9HC-DV6C, BHX-DV6FC) 1.6 e-HDi Intensive, Seduction MPV, (5GZ-EP6FDT) 1.6 e-THP Intensive MPV, (5FS-EP6C) 1.6 VTi 120 Seduction MPV (2011-); Peugeot 308 (5GT-EP6FDTX) 1.6 GT e-THP (2015-)
	AR1099 Centre Bearing Rubber Mahindra Scorpio 4X2, 4X4 2.0, 2.2, 2.5, 2.6 (2003-)		AR1110 Transmission Mounting Citroen C4 Picasso (9HC-DV6C, BHX-DV6FC) 1.6 e-HDi Intensive, Seduction MPV, (5FS-EP6C) 1.6 VTi 120 Seduction MPV, (5GZ-EP6FDT) 1.6 e-THP Intensive MPV (2011-); Peugeot 208 (CA, CC) (HNP-EB2ADT, HNV-EB2DTM, HNZ-EB2DT) 1.2 GT-Line Puretech Turbo (2015-), 3008 (HNS-EB2ADTS, HNY-EB2DTS) 1.2 THP Active, (5GY-EP6FDTM, 5GZ-EP6FDT) 1.6 THP Active, Allure, GT-Line (2017-), 308 (LB, LP) (HNP-EB2ADT, HNV-EB2DTM, HNZ-EB2DT) 1.2 THP 110 Active, Allure, GT-Line (2017-), 308 (LB, LP) (HNP-EB2ADT, HNV-EB2DTM, HNZ-EB2DT) 1.2 THP 110 Active, Puretech, (HNY-EB2DTS) 1.2 THP 130 Allure, GT-Line, Puretech, (5GT-EP6FDTX) 1.6 GT e-THP (2015-), 5008 (MC, MJ, MR) (AHX-DW10FD) 2.0 HDi Active MPV (2011-)
	AR1100 Centre Bearing Rubber Mahindra Scorpio 4X2, 4X4 (VKH4) 2.2D mHawk S4 S/cab, S6 D/cab, P/up (2017-)		AR1110 Transmission Mounting Citroen C4 Picasso (9HC-DV6C, BHX-DV6FC) 1.6 e-HDi Intensive, Seduction MPV, (5FS-EP6C) 1.6 VTi 120 Seduction MPV, (5GZ-EP6FDT) 1.6 e-THP Intensive MPV (2011-); Peugeot 208 (CA, CC) (HNP-EB2ADT, HNV-EB2DTM, HNZ-EB2DT) 1.2 GT-Line Puretech Turbo (2015-), 3008 (HNS-EB2ADTS, HNY-EB2DTS) 1.2 THP Active, (5GY-EP6FDTM, 5GZ-EP6FDT) 1.6 THP Active, Allure, GT-Line (2017-), 308 (LB, LP) (HNP-EB2ADT, HNV-EB2DTM, HNZ-EB2DT) 1.2 THP 110 Active, Allure, GT-Line (2017-), 308 (LB, LP) (HNP-EB2ADT, HNV-EB2DTM, HNZ-EB2DT) 1.2 THP 110 Active, Puretech, (HNY-EB2DTS) 1.2 THP 130 Allure, GT-Line, Puretech, (5GT-EP6FDTX) 1.6 GT e-THP (2015-), 5008 (MC, MJ, MR) (AHX-DW10FD) 2.0 HDi Active MPV (2011-)
	AR1101 Engine Mounting - RHS Upper Torque Rod Nissan Primastar (F9Q760) 1.9dCi 6-Spd. Man. (2007-); Opel Vivaro (F9Q760) 1.9dCi 6-Spd. Man. (2006-); Renault Traffic II (F9Q760) 1.9dCi 6-Spd. Man. (05-08)		AR1110 Transmission Mounting Citroen C4 Picasso (9HC-DV6C, BHX-DV6FC) 1.6 e-HDi Intensive, Seduction MPV, (5FS-EP6C) 1.6 VTi 120 Seduction MPV, (5GZ-EP6FDT) 1.6 e-THP Intensive MPV (2011-); Peugeot 208 (CA, CC) (HNP-EB2ADT, HNV-EB2DTM, HNZ-EB2DT) 1.2 GT-Line Puretech Turbo (2015-), 3008 (HNS-EB2ADTS, HNY-EB2DTS) 1.2 THP Active, (5GY-EP6FDTM, 5GZ-EP6FDT) 1.6 THP Active, Allure, GT-Line (2017-), 308 (LB, LP) (HNP-EB2ADT, HNV-EB2DTM, HNZ-EB2DT) 1.2 THP 110 Active, Allure, GT-Line (2017-), 308 (LB, LP) (HNP-EB2ADT, HNV-EB2DTM, HNZ-EB2DT) 1.2 THP 110 Active, Puretech, (HNY-EB2DTS) 1.2 THP 130 Allure, GT-Line, Puretech, (5GT-EP6FDTX) 1.6 GT e-THP (2015-), 5008 (MC, MJ, MR) (AHX-DW10FD) 2.0 HDi Active MPV (2011-)
	AR1102 Engine Mounting - LHS Nissan Primastar (F9Q760) 1.9dCi 6-Spd. Man. (2007-); Opel Vivaro (F9Q760) 1.9dCi 6-Spd. Man. (2006-); Renault Traffic II (F9Q760) 1.9dCi 6-Spd. Man. (05-08)		AR1110 Transmission Mounting Citroen C4 Picasso (9HC-DV6C, BHX-DV6FC) 1.6 e-HDi Intensive, Seduction MPV, (5FS-EP6C) 1.6 VTi 120 Seduction MPV, (5GZ-EP6FDT) 1.6 e-THP Intensive MPV (2011-); Peugeot 208 (CA, CC) (HNP-EB2ADT, HNV-EB2DTM, HNZ-EB2DT) 1.2 GT-Line Puretech Turbo (2015-), 3008 (HNS-EB2ADTS, HNY-EB2DTS) 1.2 THP Active, (5GY-EP6FDTM, 5GZ-EP6FDT) 1.6 THP Active, Allure, GT-Line (2017-), 308 (LB, LP) (HNP-EB2ADT, HNV-EB2DTM, HNZ-EB2DT) 1.2 THP 110 Active, Allure, GT-Line (2017-), 308 (LB, LP) (HNP-EB2ADT, HNV-EB2DTM, HNZ-EB2DT) 1.2 THP 110 Active, Puretech, (HNY-EB2DTS) 1.2 THP 130 Allure, GT-Line, Puretech, (5GT-EP6FDTX) 1.6 GT e-THP (2015-), 5008 (MC, MJ, MR) (AHX-DW10FD) 2.0 HDi Active MPV (2011-)
	AR1103 Stabilizer Pin Kit Nissan Hardbody (D22) NP300 4X2, 4X4 (KA20DE) 2.0, (KA24DE) 2.4, (YD25DDTi) 2.5 (2008-)		AR1110 Transmission Mounting Citroen C4 Picasso (9HC-DV6C, BHX-DV6FC) 1.6 e-HDi Intensive, Seduction MPV, (5FS-EP6C) 1.6 VTi 120 Seduction MPV, (5GZ-EP6FDT) 1.6 e-THP Intensive MPV (2011-); Peugeot 208 (CA, CC) (HNP-EB2ADT, HNV-EB2DTM, HNZ-EB2DT) 1.2 GT-Line Puretech Turbo (2015-), 3008 (HNS-EB2ADTS, HNY-EB2DTS) 1.2 THP Active, (5GY-EP6FDTM, 5GZ-EP6FDT) 1.6 THP Active, Allure, GT-Line (2017-), 308 (LB, LP) (HNP-EB2ADT, HNV-EB2DTM, HNZ-EB2DT) 1.2 THP 110 Active, Allure, GT-Line (2017-), 308 (LB, LP) (HNP-EB2ADT, HNV-EB2DTM, HNZ-EB2DT) 1.2 THP 110 Active, Puretech, (HNY-EB2DTS) 1.2 THP 130 Allure, GT-Line, Puretech, (5GT-EP6FDTX) 1.6 GT e-THP (2015-), 5008 (MC, MJ, MR) (AHX-DW10FD) 2.0 HDi Active MPV (2011-)
	AR1104 Front Lower Control Arm Bush - Inner Front Citroen C4 Picasso (9HC-DV6C, BHX-DV6FC) 1.6 e-Hdi Intensive, Seduction MPV, (5FS-EP6C) 1.6 VTi 120 Seduction MPV, (5GZ-EP6FDT) 1.6 e-THP Intensive MPV (2011-); Peugeot 3008 (HNS-EB2ADTS, HNY-EB2DTS) 1.2 THP Active SUV, (5GY-EP6FDTM, 5GZ-EP6FDT) 1.6 THP Active, Allure, GT-Line SUV, (AHX-DW10FD) 2.0 HDi Active, Allure (2017-), 308 (LB, LP) (HNP-EB2ADT, HNV-EB2DTM, HNZ-EB2DT) 1.2 THP 110 Active, Puretech, (HNY-EB2DTS) 1.2 THP 130 Allure, GT-Line, Puretech, GT (5GT-EP6FDTX) 1.6 e-THP (2015-), (AHX-DW10FD) 2.0 HDi Active (2011-)		AR1110 Transmission Mounting Citroen C4 Picasso (9HC-DV6C, BHX-DV6FC) 1.6 e-HDi Intensive, Seduction MPV, (5FS-EP6C) 1.6 VTi 120 Seduction MPV, (5GZ-EP6FDT) 1.6 e-THP Intensive MPV (2011-); Peugeot 208 (CA, CC) (HNP-EB2ADT, HNV-EB2DTM, HNZ-EB2DT) 1.2 GT-Line Puretech Turbo (2015-), 3008 (HNS-EB2ADTS, HNY-EB2DTS) 1.2 THP Active, (5GY-EP6FDTM, 5GZ-EP6FDT) 1.6 THP Active, Allure, GT-Line (2017-), 308 (LB, LP) (HNP-EB2ADT, HNV-EB2DTM, HNZ-EB2DT) 1.2 THP 110 Active, Allure, GT-Line (2017-), 308 (LB, LP) (HNP-EB2ADT, HNV-EB2DTM, HNZ-EB2DT) 1.2 THP 110 Active, Puretech, (HNY-EB2DTS) 1.2 THP 130 Allure, GT-Line, Puretech, (5GT-EP6FDTX) 1.6 GT e-THP (2015-), 5008 (MC, MJ, MR) (AHX-DW10FD) 2.0 HDi Active MPV (2011-)
	AR1105 Front Lower Control Arm Bush - Outer Rear Citroen C4 Picasso (9HC-DV6C, BHX-DV6FC) 1.6 e-Hdi Intensive, Seduction MPV, (5FS-EP6C) 1.6 VTi 120 Seduction MPV, (5GZ-EP6FDT) 1.6 e-THP Intensive MPV (2011-); Peugeot 3008 (HNS-EB2ADTS, HNY-EB2DTS) 1.2 THP Active SUV, (5GY-EP6FDTM, 5GZ-EP6FDT) 1.6 THP Active, Allure, GT-Line SUV, (AHX-DW10FD) 2.0 HDi Active, Allure (2017-), 308 (LB, LP) (HNP-EB2ADT, HNV-EB2DTM, HNZ-EB2DT) 1.2 THP 110 Active, Puretech, (HNY-EB2DTS) 1.2 THP 130 Allure, GT-Line, Puretech, GT (5GT-EP6FDTX) 1.6 e-THP (2015-), (AHX-DW10FD) 2.0 HDi Active (2011-)		AR1110 Transmission Mounting Citroen C4 Picasso (9HC-DV6C, BHX-DV6FC) 1.6 e-HDi Intensive, Seduction MPV, (5FS-EP6C) 1.6 VTi 120 Seduction MPV, (5GZ-EP6FDT) 1.6 e-THP Intensive MPV (2011-); Peugeot 208 (CA, CC) (HNP-EB2ADT, HNV-EB2DTM, HNZ-EB2DT) 1.2 GT-Line Puretech Turbo (2015-), 3008 (HNS-EB2ADTS, HNY-EB2DTS) 1.2 THP Active, (5GY-EP6FDTM, 5GZ-EP6FDT) 1.6 THP Active, Allure, GT-Line (2017-), 308 (LB, LP) (HNP-EB2ADT, HNV-EB2DTM, HNZ-EB2DT) 1.2 THP 110 Active, Allure, GT-Line (2017-), 308 (LB, LP) (HNP-EB2ADT, HNV-EB2DTM, HNZ-EB2DT) 1.2 THP 110 Active, Puretech, (HNY-EB2DTS) 1.2 THP 130 Allure, GT-Line, Puretech, (5GT-EP6FDTX) 1.6 GT e-THP (2015-), 5008 (MC, MJ, MR) (AHX-DW10FD) 2.0 HDi Active MPV (2011-)

ENGINE MOUNTING & RUBBER BUYERS GUIDE

	<p>AR1111 Engine Mounting - RHS</p> <p>Citroen C3 (SC) (9HJ-DV6DTEDM, 9HP-DV6DTEDE) 1.6 eHdi 90 Seduction, (9HX-DV6ATED4) 1.6 HDi 90 Seduction (2010-), DS3 (9HP-DV6DTEDE) 1.6 e-Hdi 90 Style, Sport (2012-); Peugeot 2008 (9HP-DV6DTEDE) 1.6 HDi Active, Allure (2017-), 207 (WA, WC) (9HY-DV6TED4, 9HZ-DV6TED4) 1.6 HDi Dynamic, XS, (9HR-DV6C) 1.6 HDi Dynamic, Sportium (2006-), 208 (CA, CC) (9HJ-DV6DTEDM, 9HP-DV6DTEDE) 1.6 HDi Active, (9HD-DV6C) 1.6 HDi Allure (2013-)</p>
	<p>AR1112 Engine Mounting - Rear</p> <p>Citroen C3 (SC) (9HJ-DV6DTEDM, 9HP-DV6DTEDE) 1.6 eHdi 90 Seduction, (9HX-DV6ATED4) 1.6 HDi 90 Seduction (2010-), C3 Picasso (SH) (5FS-EP6C, 5FW-EP6) 1.6i VTI 120 Seduction, Panoramic (2010-), C4 Cactus (HNP-EB2ADT, HNV-EB2DTM, HNZ-EB2DT) 1.2 e-THP PureTech AWD (2015-), DS3 (9HP-DV6DTEDE) 1.6 e-Hdi 90 Style, Sport, (5FR-EP6DT, 5FV-EP6CDT) 1.6 THP 155 Sport, Ultra Prestige (2010-), 1.2 e-THP Style, PureTech Cabriolet, (5FV-EP6CDT) 1.6 THP 155 Sport Cabriolet (2013-); Peugeot 2008 (CU) (HNP-EB2ADT, HNV-EB2DTM, HNZ-EB2DT) 1.2 THP 110, Active, Allure, Puretech, (9HP-DV6DTEDE) 1.6 HDi Active, Allure (2013-), 207 (WA, WC) (5FY-EP6DTS) 1.6 GTi, (5FX-EP6DT) 1.6 GT, (5FS-EP6C, 5FW-EP6) 1.6 Dynamix, Sportium, XS, (9HY-DV6TED4, 9HZ-DV6TED4) 1.6 HDi Dynamic, XS, (9HR-DV6C) 1.6 HDi Dynamic, Sportium (06-13), 207 CC (WD) (5FS-EP6C, 5FW-EP6) 1.6 Sport 1, (5FX-EP6DT) 1.6 Sport 2, (5FR-EP6DT, 5FV-EP6CDT) 1.6 Sport 2 EU5 (07-13), 208 (CA/C) (ZMZ-EB0) 1.0 Access, Pop'Art, Puretech, (HNP-EB2ADT, HNV-EB2DTM, HNZ-EB2DT) 1.2 THP 110, GT-Line, Puretech, Turbo, (9HJ-DV6DTEDM, 9HP-DV6DTEDE) 1.6 HDi Active, (9HD-DV6C) 1.6 HDi Allure (2012-), 308 (LB, LP) (HNP-EB2ADT, HNV-EB2DTM, HNZ-EB2DT) 1.2, THP, Active, Puretech (2015-)</p>
	<p>AR1113 Engine Mounting - RHS</p> <p>Citroen C3 Picasso (SH) (5FS-EP6C, 5FW-EP6) 1.6i VTI 120 Seduction, Panoramic (2010-), DS3 (5FM-EP6DT) 1.6 e-THP, Sport, PureTech, (5FD-EP6DTS) 1.6 VTI Racing, (5FR-EP6DT, 5FV-EP6CDT) 1.6 THP 155 Sport, Ultra Prestige, (5FS-EP6C) 1.6 VTI 120 Style, Design, Sport, Techno (2010-), (5FV-EP6CDT) 1.6 THP 155 Sport Cabriolet, (5FS-EP6C) 1.6 VTI 120 Style Cabriolet (2013-); Peugeot 2008 (CU) (5FS-EP6C) 1.6 Active, Allure (2013-), 207 (WA, WC) (5FY-EP6DTS) 1.6 GTi, (5FX-EP6DT) 1.6 GT, (5FS-EP6C, 5FW-EP6) 1.6 Dynamix, Sportium, XS (06-13), 207 CC (WD) (5FS-EP6C, 5FW-EP6) 1.6 Sport 1, (5FX-EP6DT) 1.6 Sport 2, (5FR-EP6DT, 5FV-EP6CDT) 1.6 Sport 2 EU5 (07-13), 208 (CA, CC) (5FS-EP6C) 1.6 Active, Allure, (5FU-EP6CDTX) 1.6 GTi, (5GR-EP6FDTX) 1.6 THP, GTi (2012-)</p>
	<p>AR1114 Transmission Mounting</p> <p>BMW 1-Series (F20, F21) 118i (B38B15A) 1.5 (11-19), 3-Series (F30, F31) 318i (B38A15A) 1.6 (12-19)</p>

	<p>AR1115 Rear Strut Mounting</p> <p>BMW 1-Series (F20, F21) 116i (N13B16A) 1.6, 118i (B38B15A) 1.5, (N13B16A) 1.6, 120d (B47D20A) 2.0, 120i (N13B16A) 1.6, (B48B20A) 2.0, 125i (B48B20B, N20B20A) 2.0, M135i (N55B30A) 3.0 (11-19), (F40) 118i (B38A15A) 1.5, M-Sport, Sportline (2020-), 2-Series (F22, F23) 220d (B47D20A) 2.0 Coupe, 220i (B48B20A, N20B20A/B) 2.0 Coupe, 228i (N20B20A, N26B20A) 2.0 Coupe, 230i (B46B20B, B48B20A) 2.0 Coupe, M235i (N55B30A) 3.0 Coupe, M240i (B58B30A) 3.0 Coupe (14-19), (F44) 218i (B38A15A) 1.5 Gran Coupe, 220d (B47C20B) 2.0 Gran Coupe, M235i (B48A20E) 2.0 Gran Coupe (2020-), (F45) 218i Active Tourer (B38A15A) 1.5, 220d Active Tourer (B47C20A/B) 2.0, 220i Active Tourer (B48A20A/F) 2.0, 225i Active Tourer (B48A20B) 2.0 (2015-), (F46) 218i Gran Tourer (B38A15A) 1.5, 220d Gran Tourer (B47C20A/B) 2.0, 220i Gran Tourer (B48A20A) 2.0 (2015-), 3-Series (F30, F31) 316i (N13B16A) 1.6, 318i (B38A15A) 1.6, 320d (N47D20A) 2.0, 320i (B48B20A, N20B20A/B/D) 2.0, 328i (N20B20A) 2.0, 330d (N57D30A) 3.0, 330i (B46B20A, B48B20A) 2.0, 335i (N55B30A) 3.0, 340i (B58B30A) 3.0 (12-19), (F34) 320d GT (B47D20A, N47D20C) 2.0, 320i GT (N20B20A/B) 2.0, 328i GT (N20B20A, N26B20A) 2.0, 335i GT (N55B30A) 3.0, 340i GT (B58B30A) 3.0 (2013-), 4-Series (F32) 420d (B47B20A, N47D20C) 2.0 Coupe, 420i (N20B20A/B) 2.0 Coupe, 428i (N20B20A, N26B20A) 2.0 Coupe, 430i (B46B20B, B48B20B) 2.0 Coupe, 435i (N55B30A) 3.0 Coupe, 440i (B58B30A) 3.0 Coupe (2014-), (F33) 420i (N20B20B) 2.0 Cabriolet, 428i (N20B20A, N26B20A) 2.0 Cabriolet, 430i (B48B20B) 2.0 Cabriolet, 435i (N55B30A) 3.0 Cabriolet, 440i (B58B30A) 3.0 Cabriolet (2014-), (F36) 420d (B47B20A, N47D20C) 2.0 Gran Coupe, 420i (N20B20B) 2.0 Gran Coupe, 428i (N20B20A, N26B20A) 2.0 Gran Coupe, 430i (B48B20B) 2.0 Gran Coupe, 435i (N55B30A) 3.0 Gran Coupe, 440i (B58B30A) 3.0 Gran Coupe (2014-), X1 (F48) sDrive18i (B38A15A) 1.5, sDrive20d (B47C20A/B) 2.0, sDrive20i (B48A20A/F) 2.0, xDrive20d (B47C20A/B) 2.0, xDrive20i (B48A20A/F) 2.0, xDrive25i (B48A20B) 2.0 (2015-), X2 (F39) sDrive18i (B38A15A) 1.5, sDrive20i (B48A20A) 2.0, xDrive20d (B47C20A/B) 2.0 (2018-) - Vehicles without Electronic Suspension Control; Mini Cooper Clubman (F54) (B36A15A, B38A15A) 1.5 6-Spd. Auto., 7-Spd. Dual Clutch, Cooper S (B46A20A, B48A20A, B48A20F) 2.0 6-Spd. Man., John Cooper Works All4 (B48A20B) 2.0 6-Spd. Man. AWD (2015-), Cooper Hatch (F55) (B36A15A, B38A15A) 1.5 6-Spd. Man./Auto., Cooper S (B46A20A, B48A20A) 2.0 6-Spd. Man. One (B38A12A) 1.2 6-Spd. Auto. (2013-), Cooper Hatch (F56) (B36A15A, B38A15A) 1.5 6-Spd. Auto., 7-Spd. Dual Clutch, Cooper S (B46A20A, B48A20A, B48A20F) 2.0 6-Spd. Man., John Cooper Works All4 (B46A20B, B48A20B) 2.0 6-Spd. Man. AWD, One (B38A12A) 1.2 6-Spd. Auto., (B38A15A) 1.5 6-Spd. Man. (2013-), Cooper Hatch (F57) (B36A15A, B38A15A) 1.5 Cabriolet 6-Spd. Auto., 7-Spd. Dual Clutch, Cooper S (B46A20A, B48A20A) 2.0 Cabriolet 6-Spd. Man. (2013-), Cooper Countryman (F60) (B36A15A, B38A15A, B38A15F) 1.5 6-Spd. Auto. 7-Spd. Dual Clutch, Cooper D (B47C20A, B47C20B) 2.0 6-Spd. Man., Cooper S (B46A20A, B48A20A) 2.0 6-Spd. Man., John Cooper Works All4 (B48A20B) 2.0 6-Spd. Man. (2017-) - Vehicles without Vehicle Dynamic Control</p>
	<p>AR1116 Engine Mounting - LHS</p> <p>BMW 2-Series (F45) 218i Active Tourer (B38A15A) 1.5 Man., 220d Active Tourer (B47C20A/B) 2.0 Man., 220i Active Tourer (B48A20A/F) 2.0 Man., 225i Active Tourer (B48A20B) 2.0 Man. (2015-), (F46) 218i Gran Tourer (B38A15A) 1.5, 220d Gran Tourer (B47C20A/B) 2.0, 220i Gran Tourer (B48A20A) 2.0 (2015-), (F44) 220d (B47C20B) 2.0 Gran Coupe (2020-), X1 (F48) sDrive18i (B38A15A) 1.5 Man., sDrive20d (B47C20A/B) 2.0 Man., sDrive20i (B48A20A/F) 2.0 Man. (2015-), X2 (F39) sDrive18i (B38A15A) 1.5, sDrive20i (B48A20A) 2.0 (2018-); Mini Cooper Clubman (F54) (B36A15A, B38A15A) 1.5 6-Spd. Man., 7-Spd. Dual Clutch, Cooper S (B46A20A, B48A20A, B48A20F) 2.0 (2010-), Cooper Hatch (F55) (B36A15A, B38A15A) 1.5, Cooper S (B46A20A, B48A20A) 2.0, One (B38A12A) 1.2 (2013-), Cooper Hatch (F56) (B36A15A, B38A15A) 1.5 6-Spd. Man., 7-Spd. Dual Clutch, Cooper S (B46A20A, B48A20A, B48A20F) 2.0, John Cooper Works (B46A20B, B48A20B) 2.0, One (B38A12A) 1.2 6-Spd. Man., (B38A15A) 1.5 (2013-), Cooper Hatch (F57) (B36A15A, B38A15A) 1.5 6-Spd. Man., 7-Spd. Dual Clutch Cabriolet, Cooper S (B46A20A, B48A20A) 2.0 Cabriolet (2013-), Cooper Countryman (F60) (B36A15A, B38A15A, B38A15F) 1.5 SUV, Cooper D Countryman (B47C20A, B47C20B) 2.0 SUV, Cooper S Countryman (B46A20A, B48A20A) 2.0 (2017-) - Man. Models</p>

ENGINE MOUNTING & RUBBER BUYERS GUIDE

	<p>AR1117 Engine Mounting - LHS</p> <p>BMW 2-Series (F45) 218i Active Tourer (B38A15A) 1.5 Auto., 220d Active Tourer (B47C20A/B) 2.0 Auto., 220i Active Tourer (B48A20A/F) 2.0 Auto. (2015-), X1 (F48) sDrive18i (B38A15A) 1.5 Auto., sDrive20d (B47C20A/B) 2.0 Auto. (2015-); Mini Cooper Clubman (F54) (B36A15A, B38A15A) 1.5 (2010-), Cooper Hatch (F55) (B36A15A, B38A15A) 1.5, One (B38A12A) 1.2 (2013-), Cooper Hatch (F56) (B36A15A, B38A15A) 1.5, One (B38A12A) 1.2, (B38A15A) 1.5 (2013-), Cooper Countryman (F60) (B36A15A, B38A15A, B38A15F) 1.5 SUV (2017-) - Auto. Models</p>	<p>AR1122 Front Lower Control Arm Bush - Inner Front</p> <p>BMW 1-Series (F20, F21) 116i (N13B16A) 1.6, 118i (B38B15A) 1.5, (N13B16A) 1.6, 120d (B47D20A) 2.0, 120i (N13B16A) 1.6, (B48B20A) 2.0, 125i (B48B20B, N20B20A) 2.0, M135i (N55B30A) 3.0 (11-19), (F40) 118i (B38A15A) 1.5, M-Sport, Sportline (2020-), 2-Series (F22, F23) 220d (B47D20A) 2.0 Coupe, 220i (B48B20A, N20B20A/B) 2.0 Coupe, 228i (N20B20A, N26B20A) 2.0 Coupe, 230i (B46B20B, B48B20A) 2.0 Coupe, M235i (N55B30A) 3.0 Coupe, M240i (B58B30A) 3.0 Coupe (14-19), (F44) 218i (B38A15A) 1.5 Gran Coupe, 220d (B47C20B) 2.0 Gran Coupe, M235i (B48A20E) 2.0 Gran Coupe (2020-), (F45) 218i Active Tourer (B38A15A) 1.5, 220d Active Tourer (B47C20A/B) 2.0, 220i Active Tourer (B48A20A/F) 2.0, 225i Active Tourer (B48A20B) 2.0 (2015-), (F46) 218i Gran Tourer (B38A15A) 1.5, 220d Gran Tourer (B47C20A/B) 2.0, 220i Gran Tourer (B48A20A) 2.0 (2015-), 3-Series (F30, F31) 316i (N13B16A) 1.6, 318i (B38A15A) 1.6, 320d (N47D20A) 2.0, 320i (B48B20A, N20B20A/B/D) 2.0, 328i (N20B20A) 2.0, 330d (N57D30A) 3.0, 330i (B46B20A, B48B20A) 2.0, 335i (N55B30A) 3.0, 340i (B58B30A) 3.0 (12-19), (F34) 320d GT (B47D20A, N47D20C) 2.0, 320i GT (N20B20A/B) 2.0, 328i GT (N20B20A, N26B20A) 2.0, 335i GT (N55B30A) 3.0, 340i GT (B58B30A) 3.0 (2013-), 4-Series (F32) 420d (B47B20A, N47D20C) 2.0 Coupe, 420i (N20B20A/B) 2.0 Coupe, 428i (N20B20A, N26B20A) 2.0 Coupe, 430i (B46B20B, B48B20B) 2.0 Coupe, 435i (N55B30A) 3.0 Coupe, 440i (B58B30A) 3.0 Coupe (2014-), (F33) 420i (N20B20B) 2.0 Cabriolet, 428i (N20B20A, N26B20A) 2.0 Cabriolet, 430i (B48B20B) 2.0 Cabriolet, 435i (N55B30A) 3.0 Cabriolet, 440i (B58B30A) 3.0 Cabriolet (2014-), (F36) 420d (B47B20A, N47D20C) 2.0 Gran Coupe, 420i (N20B20B) 2.0 Gran Coupe, 428i (N20B20A, N26B20A) 2.0 Gran Coupe, 430i (B48B20B) 2.0 Gran Coupe, 435i (N55B30A) 3.0 Gran Coupe, 440i (B58B30A) 3.0 Gran Coupe (2014-), X1 (F48) sDrive18i (B38A15A) 1.5, sDrive20d (B47C20A/B) 2.0, sDrive20i (B48A20A/F) 2.0, xDrive20d (B47C20A/B) 2.0, xDrive20i (B48A20A/F) 2.0, xDrive25i (B48A20B) 2.0 (2015-), X2 (F39) sDrive18i (B38A15A) 1.5, sDrive20i (B48A20A) 2.0, xDrive20d (B47C20A/B) 2.0 (2018-); Mini Cooper Clubman (F54) (B36A15A, B38A15A) 1.5 6-Spd. Auto., 7-Spd. Dual Clutch, Cooper S (B46A20A, B48A20A, B48A20F) 2.0 6-Spd. Man., John Cooper Works All4 (B48A20B) 2.0 6-Spd. Man. AWD (2015-), Cooper Hatch (F55) (B36A15A, B38A15A) 1.5 6-Spd. Man./Auto., Cooper S (B46A20A, B48A20A) 2.0 6-Spd. Man, One (B38A12A) 1.2 6-Spd. Auto. (2013-), Cooper Hatch (F56) (B36A15A, B38A15A) 1.5 6-Spd. Auto., 7-Spd. Dual Clutch, Cooper S (B46A20A, B48A20A, B48A20F) 2.0 6-Spd. Man., John Cooper Works All4 (B46A20B, B48A20B) 2.0 6-Spd. Man. AWD, One (B38A12A) 1.2 6-Spd. Auto., (B38A15A) 1.5 6-Spd. Man. (2013-), Cooper Hatch (F57) (B36A15A, B38A15A) 1.5 Cabriolet 6-Spd. Auto., 7-Spd. Dual Clutch, Cooper S (B46A20A, B48A20A) 2.0 Cabriolet 6-Spd. Man. (2013-), Cooper Countryman (F60) (B36A15A, B38A15A, B38A15F) 1.5 6-Spd. Auto. 7-Spd. Dual Clutch, Cooper D (B47C20A, B47C20B) 2.0 6-Spd. Man, Cooper S (B46A20A, B48A20A) 2.0 6-Spd. Man., John Cooper Works All4 (B48A20B) 2.0 6-Spd. Man. (2017-)</p>
	<p>AR1118 Engine Mounting - RHS</p> <p>BMW 1-Series (F40) 118i (B38A15A) 1.5 6-Spd. Man., M-Sport, Sportline (2020-), 2-Series (F45) 218i Active Tourer (B38A15A) 1.5 Man., 220i Active Tourer (B48A20A/F) 2.0 Man. (2015-), X1 (F48) sDrive18i (B38A15A) 1.5 Man. (2015-), X2 (F39) sDrive18i (B38A15A) 1.5 (2018-); Mini Cooper Clubman (F54) (B36A15A, B38A15A) 1.5 (2010-), Cooper Hatch (F55) (B36A15A, B38A15A) 1.5, One (B38A12A) 1.2 (2013-), Cooper Hatch (F56) (B36A15A, B38A15A) 1.5 (2013-), Cooper Hatch (F57) (B36A15A, B38A15A) 1.5 Cabriolet (2013-), (F60) Cooper Countryman (B36A15A, B38A15A, B38A15F) 1.5 SUV (2017-)</p>	
	<p>AR1119 Engine Mounting - RHS</p> <p>BMW 1-Series (F40) 118i (B38A15A) 1.5 7-Spd. Dual Clutch, M-Sport, Sportline (2020-), 2-Series (F45) 218i Active Tourer (B38A15A) 1.5 Auto., 220i Active Tourer (B48A20A/F) 2.0 Auto. (2015-), (F46) 218i Gran Tourer (B38A15A) 1.5 Auto., Steptronic (2015-), X1 (F48) sDrive18i (B38A15A) 1.5 Auto. (2015-), X2 (F39) sDrive18i (B38A15A) 1.5 6-Spd. Man. (2018-); Mini Cooper Clubman (F54) (B36A15A, B38A15A) 1.5 (2010-), Cooper Hatch (F55) (B36A15A, B38A15A) 1.5, One (B38A12A) 1.2 (2013-), Cooper Hatch (F56) (B36A15A, B38A15A) 1.5 (2013-), Cooper Hatch (F57) (B36A15A, B38A15A) 1.5 Cabriolet (2013-), (F60) Cooper Countryman (B36A15A, B38A15A, B38A15F) 1.5 SUV (2017-)</p>	
	<p>AR1120 Transmission Mounting</p> <p>BMW 1-Series (F40) 118i (B38A15A) 1.5 6-Spd. Man., M-Sport, Sportline (2020-), 2-Series (F45) 218i Active Tourer (B38A15A) 1.5 Man. (2015-), (F46) 218i Gran Tourer (B38A15A) 1.5 Man., 220i Gran Tourer (B48A20A) 2.0 Steptronic (2015-), X1 (F48) sDrive18i (B38A15A) 1.5 Man. (2015-), X2 (F39) sDrive18i (B38A15A) 1.5 Man. (2018-); Mini Cooper Clubman (F54) (B36A15A, B38A15A) 1.5 (2010-), Cooper Hatch (F55) (B36A15A, B38A15A) 1.5, One (B38A12A) 1.2 (2013-), Cooper Hatch (F56) (B36A15A, B38A15A) 1.5, One (B38A12A) 1.2, (B38A15A) 1.5 (2013-), Cooper Hatch (F57) (B36A15A, B38A15A) 1.5 Cabriolet (2013-), Cooper Countryman (F60) (B36A15A, B38A15A, B38A15F) 1.5 SUV (2017-) - Man. Models</p>	
	<p>AR1121 Transmission Mounting</p> <p>BMW 1-Series (F40) 118i (B38A15A) 1.5 7-Spd. Dual Clutch, M-Sport, Sportline (2020-), 2-Series (F45) 218i Active Tourer (B38A15A) 1.5 Auto., 220d Active Tourer (B47C20A/B) 2.0 Steptronic, Twin Clutch Gearbox., 220i Active Tourer (B48A20A/F) 2.0 Auto. (2015-), (F46) 218i Gran Tourer (B38A15A) 1.5 Auto. (2015-), X1 (F48) sDrive18i (B38A15A) 1.5 Auto., sDrive20d (B47C20A/B) 2.0 Steptronic, xDrive20d (B47C20A/B) 2.0 Auto. (2015-), X2 (F39) sDrive18i (B38A15A) 1.5 7-Spd. Dual Clutch (2018-); Mini Cooper Clubman (F54) (B36A15A, B38A15A) 1.5 6-Spd. Auto., 7-Spd. Dual Clutch, Cooper S (B46A20A, B48A20A, B48A20F) 2.0 6-Spd. Man., John Cooper Works All4 (B48A20B) 2.0 6-Spd. Man. AWD (2015-), Cooper Hatch (F55) (B36A15A, B38A15A) 1.5 6-Spd. Man./Auto., Cooper S (B46A20A, B48A20A) 2.0 6-Spd. Man, One (B38A12A) 1.2 6-Spd. Auto. (2013-), Cooper Hatch (F56) (B36A15A, B38A15A) 1.5 6-Spd. Auto., 7-Spd. Dual Clutch, Cooper S (B46A20A, B48A20A, B48A20F) 2.0 6-Spd. Man., John Cooper Works All4 (B46A20B, B48A20B) 2.0 6-Spd. Man. AWD, One (B38A12A) 1.2 6-Spd. Auto., (B38A15A) 1.5 6-Spd. Man. (2013-), Cooper Hatch (F57) (B36A15A, B38A15A) 1.5 Cabriolet 6-Spd. Auto., 7-Spd. Dual Clutch, Cooper S (B46A20A, B48A20A) 2.0 Cabriolet 6-Spd. Man. (2013-), Cooper Countryman (F60) (B36A15A, B38A15A, B38A15F) 1.5 6-Spd. Auto. 7-Spd. Dual Clutch, Cooper D (B47C20A, B47C20B) 2.0 6-Spd. Man, Cooper S (B46A20A, B48A20A) 2.0 6-Spd. Man., John Cooper Works All4 (B48A20B) 2.0 6-Spd. Man. (2017-)</p>	

ENGINE MOUNTING & RUBBER BUYERS GUIDE



	AR1123L Front Lower Control Arm Bush - Outer Rear LHS
	<p>BMW 1-Series (F20, F21) 116i (N13B16A) 1.6, 118i (B38B15A) 1.5, (N13B16A) 1.6, 120d (B47D20A) 2.0, 120i (N13B16A) 1.6, (B48B20A) 2.0, 125i (B48B20B, N20B20A) 2.0, M135i (N55B30A) 3.0 (11-19), (F40) 118i (B38A15A) 1.5, M-Sport, Sportline (2020-), 2-Series (F22, F23) 220d (B47D20A) 2.0 Coupe, 220i (B48B20A, N20B20A/B) 2.0 Coupe, 228i (N20B20A, N26B20A) 2.0 Coupe, 230i (B46B20B, B48B20A) 2.0 Coupe, M235i (N55B30A) 3.0 Coupe, M240i (B58B30A) 3.0 Coupe (14-19), (F44) 218i (B38A15A) 1.5 Gran Coupe, 220d (B47C20B) 2.0 Gran Coupe, M235i (B48A20E) 2.0 Gran Coupe (2020-), (F45) 218i Active Tourer (B38A15A) 1.5, 220d Active Tourer (B47C20A/B) 2.0, 220i Active Tourer (B48A20A/F) 2.0, 225i Active Tourer (B48A20B) 2.0 (2015-), (F46) 218i Gran Tourer (B38A15A) 1.5, 220d Gran Tourer (B47C20A/B) 2.0, 220i Gran Tourer (B48A20A) 2.0 (2015-), 3-Series (F30, F31) 316i (N13B16A) 1.6, 318i (B38A15A) 1.6, 320d (N47D20A) 2.0, 320i (B48B20A, N20B20A/B/D) 2.0, 328i (N20B20A) 2.0, 330d (N57D30A) 3.0, 330i (B46B20A, B48B20A) 2.0, 335i (N55B30A) 3.0, 340i (B58B30A) 3.0 (12-19), (F34) 320d GT (B47D20A, N47D20C) 2.0, 320i GT (N20B20A/B) 2.0, 328i GT (N20B20A, N26B20A) 2.0, 335i GT (N55B30A) 3.0, 340i GT (B58B30A) 3.0 (2013-), 4-Series (F32) 420d (B47B20A, N47D20C) 2.0 Coupe, 420i (N20B20A/B) 2.0 Coupe, 428i (N20B20A, N26B20A) 2.0 Coupe, 430i (B46B20B, B48B20B) 2.0 Coupe, 435i (N55B30A) 3.0 Coupe, 440i (B58B30A) 3.0 Coupe (2014-), (F33) 420i (N20B20B) 2.0 Cabriolet, 428i (N20B20A, N26B20A) 2.0 Cabriolet, 430i (B48B20B) 2.0 Cabriolet, 435i (N55B30A) 3.0 Cabriolet, 440i (B58B30A) 3.0 Cabriolet (2014-), (F36) 420d (B47B20A, N47D20C) 2.0 Gran Coupe, 420i (N20B20B) 2.0 Gran Coupe, 428i (N20B20A, N26B20A) 2.0 Gran Coupe, 430i (B48B20B) 2.0 Gran Coupe, 435i (N55B30A) 3.0 Gran Coupe, 440i (B58B30A) 3.0 Gran Coupe (2014-), X1 (F48) sDrive18i (B38A15A) 1.5, sDrive20d (B47C20A/B) 2.0, sDrive20i (B48A20A/F) 2.0, xDrive20d (B47C20A/B) 2.0, xDrive20i (B48A20A/F) 2.0, xDrive25i (B48A20B) 2.0 (2015-), X2 (F39) sDrive18i (B38A15A) 1.5, sDrive20i (B48A20A) 2.0, xDrive20d (B47C20A/B) 2.0 (2018-); Mini Cooper Clubman (F54) (B36A15A, B38A15A) 1.5 6-Spd. Auto., 7-Spd. Dual Clutch, Cooper S (B46A20A, B48A20A, B48A20F) 2.0 6-Spd. Man., John Cooper Works All4 (B48A20B) 2.0 6-Spd. Man. AWD (2015-), Cooper Hatch (F55) (B36A15A, B38A15A) 1.5 6-Spd. Man./Auto., Cooper S (B46A20A, B48A20A) 2.0 6-Spd. Man, One (B38A12A) 1.2 6-Spd. Auto. (2013-), Cooper Hatch (F56) (B36A15A, B38A15A) 1.5 6-Spd. Auto., 7-Spd. Dual Clutch, Cooper S (B46A20A, B48A20A, B48A20F) 2.0 6-Spd. Man., John Cooper Works All4 (B46A20B, B48A20B) 2.0 6-Spd. Man. AWD, One (B38A12A) 1.2 6-Spd. Auto., (B38A15A) 1.5 6-Spd. Man. (2013-), Cooper Hatch (F57) (B36A15A, B38A15A) 1.5 Cabriolet 6-Spd. Auto., 7-Spd. Dual Clutch, Cooper S (B46A20A, B48A20A) 2.0 Cabriolet 6-Spd. Man. (2013-), Cooper Countryman (F60) (B36A15A, B38A15A, B38A15F) 1.5 6-Spd. Auto. 7-Spd. Dual Clutch, Cooper D (B47C20A, B47C20B) 2.0 6-Spd. Man, Cooper S (B46A20A, B48A20A) 2.0 6-Spd. Man., John Cooper Works All4 (B48A20B) 2.0 6-Spd. Man. (2017-)</p>

	AR1123R Front Lower Control Arm Bush - Outer Rear RHS
	<p>BMW 1-Series (F20, F21) 116i (N13B16A) 1.6, 118i (B38B15A) 1.5, (N13B16A) 1.6, 120d (B47D20A) 2.0, 120i (N13B16A) 1.6, (B48B20A) 2.0, 125i (B48B20B, N20B20A) 2.0, M135i (N55B30A) 3.0 (11-19), (F40) 118i (B38A15A) 1.5, M-Sport, Sportline (2020-), 2-Series (F22, F23) 220d (B47D20A) 2.0 Coupe, 220i (B48B20A, N20B20A/B) 2.0 Coupe, 228i (N20B20A, N26B20A) 2.0 Coupe, 230i (B46B20B, B48B20A) 2.0 Coupe, M235i (N55B30A) 3.0 Coupe, M240i (B58B30A) 3.0 Coupe (14-19), (F44) 218i (B38A15A) 1.5 Gran Coupe, 220d (B47C20B) 2.0 Gran Coupe, M235i (B48A20E) 2.0 Gran Coupe (2020-), (F45) 218i Active Tourer (B38A15A) 1.5, 220d Active Tourer (B47C20A/B) 2.0, 220i Active Tourer (B48A20A/F) 2.0, 225i Active Tourer (B48A20B) 2.0 (2015-), (F46) 218i Gran Tourer (B38A15A) 1.5, 220d Gran Tourer (B47C20A/B) 2.0, 220i Gran Tourer (B48A20A) 2.0 (2015-), 3-Series (F30, F31) 316i (N13B16A) 1.6, 318i (B38A15A) 1.6, 320d (N47D20A) 2.0, 320i (B48B20A, N20B20A/B/D) 2.0, 328i (N20B20A) 2.0, 330d (N57D30A) 3.0, 330i (B46B20A, B48B20A) 2.0, 335i (N55B30A) 3.0, 340i (B58B30A) 3.0 (12-19), (F34) 320d GT (B47D20A, N47D20C) 2.0, 320i GT (N20B20A/B) 2.0, 328i GT (N20B20A, N26B20A) 2.0, 335i GT (N55B30A) 3.0, 340i GT (B58B30A) 3.0 (2013-), 4-Series (F32) 420d (B47B20A, N47D20C) 2.0 Coupe, 420i (N20B20A/B) 2.0 Coupe, 428i (N20B20A, N26B20A) 2.0 Coupe, 430i (B46B20B, B48B20B) 2.0 Coupe, 435i (N55B30A) 3.0 Coupe, 440i (B58B30A) 3.0 Coupe (2014-), (F33) 420i (N20B20B) 2.0 Cabriolet, 428i (N20B20A, N26B20A) 2.0 Cabriolet, 430i (B48B20B) 2.0 Cabriolet, 435i (N55B30A) 3.0 Cabriolet, 440i (B58B30A) 3.0 Cabriolet (2014-), (F36) 420d (B47B20A, N47D20C) 2.0 Gran Coupe, 420i (N20B20B) 2.0 Gran Coupe, 428i (N20B20A, N26B20A) 2.0 Gran Coupe, 430i (B48B20B) 2.0 Gran Coupe, 435i (N55B30A) 3.0 Gran Coupe, 440i (B58B30A) 3.0 Gran Coupe (2014-), X1 (F48) sDrive18i (B38A15A) 1.5, sDrive20d (B47C20A/B) 2.0, sDrive20i (B48A20A/F) 2.0, xDrive20d (B47C20A/B) 2.0, xDrive20i (B48A20A/F) 2.0, xDrive25i (B48A20B) 2.0 (2015-), X2 (F39) sDrive18i (B38A15A) 1.5, sDrive20i (B48A20A) 2.0, xDrive20d (B47C20A/B) 2.0 (2018-); Mini Cooper Clubman (F54) (B36A15A, B38A15A) 1.5 6-Spd. Auto., 7-Spd. Dual Clutch, Cooper S (B46A20A, B48A20A, B48A20F) 2.0 6-Spd. Man., John Cooper Works All4 (B48A20B) 2.0 6-Spd. Man. AWD (2015-), Cooper Hatch (F55) (B36A15A, B38A15A) 1.5 6-Spd. Man./Auto., Cooper S (B46A20A, B48A20A) 2.0 6-Spd. Man, One (B38A12A) 1.2 6-Spd. Auto. (2013-), Cooper Hatch (F56) (B36A15A, B38A15A) 1.5 6-Spd. Auto., 7-Spd. Dual Clutch, Cooper S (B46A20A, B48A20A, B48A20F) 2.0 6-Spd. Man., John Cooper Works All4 (B46A20B, B48A20B) 2.0 6-Spd. Man. AWD, One (B38A12A) 1.2 6-Spd. Auto., (B38A15A) 1.5 6-Spd. Man. (2013-), Cooper Hatch (F57) (B36A15A, B38A15A) 1.5 Cabriolet 6-Spd. Auto., 7-Spd. Dual Clutch, Cooper S (B46A20A, B48A20A) 2.0 Cabriolet 6-Spd. Man. (2013-), Cooper Countryman (F60) (B36A15A, B38A15A, B38A15F) 1.5 6-Spd. Auto. 7-Spd. Dual Clutch, Cooper D (B47C20A, B47C20B) 2.0 6-Spd. Man, Cooper S (B46A20A, B48A20A) 2.0 6-Spd. Man., John Cooper Works All4 (B48A20B) 2.0 6-Spd. Man. (2017-)</p>

















 NO PICTURE AVAILABLE AT TIME OF PRINT	AR1124 Front Stabilizer Bar Bush
	<p>BMW 2-Series (F45) 218i Active Tourer (B38A15A) 1.5, 220d Active Tourer (B47C20A/B) 2.0, 220i Active Tourer (B48A20A/F) 2.0, 225i Active Tourer (B48A20B) 2.0 (2015-), (F46) 220d Gran Tourer (B47C20A/B) 2.0 (2015-), X1 (F48) sDrive18i (B38A15A) 1.5, sDrive20d (B47C20A/B) 2.0, sDrive20i (B48A20A/F) 2.0, xDrive20d (B47C20A/B) 2.0, xDrive20i (B48A20A/F) 2.0, xDrive25i (B48A20B) 2.0 (2015-)</p>

ENGINE MOUNTING & RUBBER BUYERS GUIDE

	<p>AR1125 Front Strut Mounting</p> <p>BMW 1-Series (F40) 118i (B38A15A) 1.5, M-Sport, Sportline (2020-), 2-Series (F45) 218i Active Tourer (B38A15A) 1.5, 220d Active Tourer (B47C20A/B) 2.0, 220i Active Tourer (B48A20A/F) 2.0, 225i Active Tourer (B48A20B) 2.0 (2015-), (F46) 218i Gran Tourer (B38A15A) 1.5, 220d Gran Tourer (B47C20A/B) 2.0, 220i Gran Tourer (B48A20A) 2.0 (2015-), (F44) 218i (B38A15A) 1.5 Gran Coupe, 220d (B47C20B) 2.0 Gran Coupe, M235i (B48A20E) 2.0 Gran Coupe (2020-), X1 (F48) sDrive18i (B38A15A) 1.5, sDrive20d (B47C20A/B) 2.0, sDrive20i (B48A20A/F) 2.0, xDrive20d (B47C20A/B) 2.0, xDrive20i (B48A20A/F) 2.0, xDrive25i (B48A20B) 2.0 (2015-), X2 (F39) sDrive18i (B38A15A) 1.5, sDrive20i (B48A20A) 2.0, xDrive20d (B47C20A/B) 2.0 (2018-) - Standard & Sport Suspension: Mini Cooper Clubman (F54) (B36A15A, B38A15A) 1.5 6-Spd. Auto., 7-Spd. Dual Clutch, Cooper S (B46A20A, B48A20A, B48A20F) 2.0 6-Spd. Man., John Cooper Works All4 (B48A20B) 2.0 6-Spd. Man. AWD (2015-)</p>
	<p>AR1126 Front Strut Mounting</p> <p>BMW 2-Series (F45) 218i Active Tourer (B38A15A) 1.5, 220d Active Tourer (B47C20A/B) 2.0, 220i Active Tourer (B48A20A/F) 2.0, 225i Active Tourer (B48A20B) 2.0 (2015-), (F46) 218i Gran Tourer (B38A15A) 1.5, 220d Gran Tourer (B47C20A/B) 2.0, 220i Gran Tourer (B48A20A) 2.0 (2015-), (F44) 218i (B38A15A) 1.5 Gran Coupe, 220d (B47C20B) 2.0 Gran Coupe, M235i (B48A20E) 2.0 Gran Coupe (2020-), X1 (F48) sDrive18i (B38A15A) 1.5, sDrive20d (B47C20A/B) 2.0, sDrive20i (B48A20A/F) 2.0, xDrive20d (B47C20A/B) 2.0, xDrive20i (B48A20A/F) 2.0, xDrive25i (B48A20B) 2.0 (2015-), X2 (F39) sDrive18i (B38A15A) 1.5, sDrive20i (B48A20A) 2.0, xDrive20d (B47C20A/B) 2.0 (2018-) - Vehicles with Electronic Suspension Control: Mini Cooper Clubman (F54) (B36A15A, B38A15A) 1.5 6-Spd. Auto., 7-Spd. Dual Clutch, Cooper S (B46A20A, B48A20A, B48A20F) 2.0 6-Spd. Man., John Cooper Works All4 (B48A20B) 2.0 6-Spd. Man. AWD (2015-), Mini Cooper Countryman (F60) (B36A15A, B38A15A, B38A15F) 1.5 6-Spd. Auto. 7-Spd. Dual Clutch, Cooper D (B47C20A, B47C20B) 2.0 6-Spd. Man., Cooper S (B46A20A, B48A20A) 2.0 6-Spd. Man., John Cooper Works All4 (B48A20B) 2.0 6-Spd. Man. (2017-) - Vehicles with Dynamic Damper Control</p>

	<p>AR1127 Rear Strut Mounting</p> <p>BMW 1-Series (F20, F21) 116i (N13B16A) 1.6, 118i (B38B15A) 1.5, (N13B16A) 1.6, 120d (B47D20A) 2.0, 120i (N13B16A) 1.6, (B48B20A) 2.0, 125i (B48B20B, N20B20A) 2.0, M135i (N55B30A) 3.0 (11-19), (F40) 118i (B38A15A) 1.5, M-Sport, Sportline (2020-), 2-Series (F22, F23) 220d (B47D20A) 2.0 Coupe, 220i (B48B20A, N20B20A/B) 2.0 Coupe, 228i (N20B20A, N26B20A) 2.0 Coupe, 230i (B46B20B, B48B20A) 2.0 Coupe, M235i (N55B30A) 3.0 Coupe, M240i (B58B30A) 3.0 Coupe (14-19), (F44) 218i (B38A15A) 1.5 Gran Coupe, 220d (B47C20B) 2.0 Gran Coupe, M235i (B48A20E) 2.0 Gran Coupe (2020-), (F45) 218i Active Tourer (B38A15A) 1.5, 220d Active Tourer (B47C20A/B) 2.0, 220i Active Tourer (B48A20A/F) 2.0, 225i Active Tourer (B48A20B) 2.0 (2015-), (F46) 218i Gran Tourer (B38A15A) 1.5, 220d Gran Tourer (B47C20A/B) 2.0, 220i Gran Tourer (B48A20A) 2.0 (2015-), 3-Series (F30, F31) 316i (N13B16A) 1.6, 318i (B38A15A) 1.6, 320d (N47D20A) 2.0, 320i (B48B20A, N20B20A/B/D) 2.0, 328i (N20B20A) 2.0, 330d (N57D30A) 3.0, 330i (B46B20A, B48B20A) 2.0, 335i (N55B30A) 3.0, 340i (B58B30A) 3.0 (12-19), (F34) 320d GT (B47D20A, N47D20C) 2.0, 320i GT (N20B20A/B) 2.0, 328i GT (N20B20A, N26B20A) 2.0, 335i GT (N55B30A) 3.0, 340i GT (B58B30A) 3.0 (2013-), 4-Series (F32) 420d (B47B20A, N47D20C) 2.0 Coupe, 420i (N20B20A/B) 2.0 Coupe, 428i (N20B20A, N26B20A) 2.0 Coupe, 430i (B46B20B, B48B20B) 2.0 Coupe, 435i (N55B30A) 3.0 Coupe, 440i (B58B30A) 3.0 Coupe (2014-), (F33) 420i (N20B20B) 2.0 Cabriolet, 428i (N20B20A, N26B20A) 2.0 Cabriolet, 430i (B48B20B) 2.0 Cabriolet, 435i (N55B30A) 3.0 Cabriolet, 440i (B58B30A) 3.0 Cabriolet (2014-), (F36) 420d (B47B20A, N47D20C) 2.0 Gran Coupe, 420i (N20B20B) 2.0 Gran Coupe, 428i (N20B20A, N26B20A) 2.0 Gran Coupe, 430i (B48B20B) 2.0 Gran Coupe, 435i (N55B30A) 3.0 Gran Coupe, 440i (B58B30A) 3.0 Gran Coupe (2014-), X1 (F48) sDrive18i (B38A15A) 1.5, sDrive20d (B47C20A/B) 2.0, sDrive20i (B48A20A/F) 2.0, xDrive20d (B47C20A/B) 2.0, xDrive20i (B48A20A/F) 2.0, xDrive25i (B48A20B) 2.0 (2015-), X2 (F39) sDrive18i (B38A15A) 1.5, sDrive20i (B48A20A) 2.0, xDrive20d (B47C20A/B) 2.0 (2018-) - Vehicles with Electronic Suspension Control: Mini Cooper Clubman (F54) (B36A15A, B38A15A) 1.5 6-Spd. Auto., 7-Spd. Dual Clutch, Cooper S (B46A20A, B48A20A, B48A20F) 2.0 6-Spd. Man., John Cooper Works All4 (B48A20B) 2.0 6-Spd. Man. AWD (2015-), Cooper Hatch (F55) (B36A15A, B38A15A) 1.5 6-Spd. Man./Auto., Cooper S (B46A20A, B48A20A) 2.0 6-Spd. Man., One (B38A12A) 1.2 6-Spd. Auto. (2013-), Cooper Hatch (F56) (B36A15A, B38A15A) 1.5 6-Spd. Auto., 7-Spd. Dual Clutch, Cooper S (B46A20A, B48A20A, B48A20F) 2.0 6-Spd. Man., John Cooper Works All4 (B46A20B, B48A20B) 2.0 6-Spd. Man. AWD, One (B38A12A) 1.2 6-Spd. Auto., (B38A15A) 1.5 6-Spd. Man. (2013-), Cooper Hatch (F57) (B36A15A, B38A15A) 1.5 Cabriolet 6-Spd. Auto., 7-Spd. Dual Clutch, Cooper S (B46A20A, B48A20A) 2.0 Cabriolet 6-Spd. Man. (2013-), Cooper Countryman (F60) (B36A15A, B38A15A, B38A15F) 1.5 6-Spd. Auto. 7-Spd. Dual Clutch, Cooper D (B47C20A, B47C20B) 2.0 6-Spd. Man., Cooper S (B46A20A, B48A20A) 2.0 6-Spd. Man., John Cooper Works All4 (B48A20B) 2.0 6-Spd. Man. (2017-)</p>
	<p>AR1128 Rear Strut Mounting</p> <p>BMW 2-Series (F22, F23) 220d (B47D20A) 2.0 Coupe, 220i (B48B20A, N20B20A/B) 2.0 Coupe, 228i (N20B20A, N26B20A) 2.0 Coupe, 230i (B46B20B, B48B20A) 2.0 Coupe, M235i (N55B30A) 3.0 Coupe, M240i (B58B30A) 3.0 Coupe (14-19), (F45) 218i Active Tourer (B38A15A) 1.5, 220d Active Tourer (B47C20A/B) 2.0, 220i Active Tourer (B48A20A/F) 2.0, 225i Active Tourer (B48A20B) 2.0 (2015-), (F46) 218i Gran Tourer (B38A15A) 1.5, 220d Gran Tourer (B47C20A/B) 2.0, 220i Gran Tourer (B48A20A) 2.0 (2015-), X1 (F48) sDrive18i (B38A15A) 1.5, sDrive20d (B47C20A/B) 2.0, sDrive20i (B48A20A/F) 2.0, xDrive20d (B47C20A/B) 2.0, xDrive20i (B48A20A/F) 2.0, xDrive25i (B48A20B) 2.0 (2015-), X2 (F39) sDrive18i (B38A15A) 1.5, sDrive20i (B48A20A) 2.0, xDrive20d (B47C20A/B) 2.0 (2018-) - Vehicles with Standard + Sport Suspension</p>
	<p>AR1129 Engine Mounting - RHS</p> <p>BMW 2-Series (F45) 220d Active Tourer (B47C20A/B) 2.0 Auto. (2015-), (F46) 220d Gran Tourer (B47C20A/B) 2.0 (2015-), X1 (F48) sDrive20d (B47C20A/B) 2.0 (2015-); Mini Cooper Countryman (F60) D (B47C20A, B47C20B) 2.0 6-Spd. Man. (2017-)</p>

ENGINE MOUNTING & RUBBER BUYERS GUIDE

	<p>AR1130 Transmission Mounting</p> <p>BMW 2-Series (F45) 220d Active Tourer (B47C20A/B) 2.0 Auto., 220i Active Tourer (B48A20A/F) 2.0 Auto., 225i Active Tourer (B48A20B) 2.0 Auto. (2015-), (F46) 220d Gran Tourer (B47C20A/B) 2.0 Auto., 220i Gran Tourer (B48A20A) 2.0 Auto. (2015-), (F44) 220d (B47C20B) 2.0 Gran Coupe (2020-), X1 (F48) sDrive20d (B47C20A/B) 2.0, sDrive20i (B48A20A/F) 2.0, xDrive20d (B47C20A/B) 2.0, xDrive20i (B48A20A/F) 2.0, xDrive25i (B48A20B) 2.0 (2015-), X2 (F39) sDrive20i (B48A20A) 2.0, xDrive20d (B47C20A/B) 2.0 (2018-); Mini Cooper Clubman (F54) (B36A15A, B38A15A) 1.5 6-Spd. Auto., 7-Spd. Dual Clutch, Cooper S (B46A20A, B48A20A, B48A20F) 2.0 6-Spd. Man., John Cooper Works All4 (B48A20B) 2.0 6-Spd. Man. AWD (2015-), Cooper Hatch (F55) (B36A15A, B38A15A) 1.5 6-Spd. Man./Auto., Cooper S (B46A20A, B48A20A) 2.0 6-Spd. Man., One (B38A12A) 1.2 6-Spd. Auto. (2013-), Cooper Hatch (F56) (B36A15A, B38A15A) 1.5 6-Spd. Auto., 7-Spd. Dual Clutch, Cooper S (B46A20A, B48A20A, B48A20F) 2.0 6-Spd. Man., John Cooper Works All4 (B46A20A, B48A20B) 2.0 6-Spd. Man. AWD, One (B38A12A) 1.2 6-Spd. Auto., (B38A15A) 1.5 6-Spd. Man. (2013-), Cooper Hatch (F57) (B36A15A, B38A15A) 1.5 Cabriolet 6-Spd. Auto., 7-Spd. Dual Clutch, Cooper S (B46A20A, B48A20A) 2.0 Cabriolet 6-Spd. Man. (2013-), Cooper Countryman (F60) (B36A15A, B38A15A, B38A15F) 1.5 6-Spd. Auto. 7-Spd. Dual Clutch, Cooper D (B47C20A, B47C20B) 2.0 6-Spd. Man., Cooper S (B46A20A, B48A20A) 2.0 6-Spd. Man., John Cooper Works All4 (B48A20B) 2.0 6-Spd. Man. (2017-)</p>		<p>AR1135 Engine Mounting - Front</p> <p>Chevrolet Cruze (B14NET) 1.4T, LS 6-Spd. Auto. (2012-); Opel Astra J (B14NET) 1.4T Auto. (2010-)</p>
	<p>AR1131 Rear Lateral Link - Upper L/RHS</p> <p>BMW 1-Series (F40) 118i (B38A15A) 1.5, M-Sport, Sportline (2020-), 2-Series (F45) 218i Active Tourer (B38A15A) 1.5, 220d Active Tourer (B47C20A/B) 2.0, 220i Active Tourer (B48A20A/F) 2.0, 225i Active Tourer (B48A20B) 2.0 (2015-), (F46) 218i Gran Tourer (B38A15A) 1.5, 220d Gran Tourer (B47C20A/B) 2.0, 220i Gran Tourer (B48A20A) 2.0 (2015-), (F44) 218i (B38A15A) 1.5 Gran Coupe, 220d (B47C20B) 2.0 Gran Coupe, M235i (B48A20E) 2.0 Gran Coupe (2020-), X1 (F48) sDrive18i (B38A15A) 1.5, sDrive20d (B47C20A/B) 2.0, sDrive20i (B48A20A/F) 2.0, xDrive20d (B47C20A/B) 2.0, xDrive20i (B48A20A/F) 2.0, xDrive25i (B48A20B) 2.0 (2015-), X2 (F39) sDrive18i (B38A15A) 1.5, sDrive20i (B48A20A) 2.0, xDrive20d (B47C20A/B) 2.0 (2018-)</p>		<p>AR1136 Front Strut Mounting</p> <p>Renault Kwid (B4D404) 1.0 (2015-)</p>
	<p>AR1132 Rear Lateral Link - Lower L/RHS</p> <p>BMW 1-Series (F40) 118i (B38A15A) 1.5, M-Sport, Sportline (2020-), 2-Series (F45) 218i Active Tourer (B38A15A) 1.5, 220d Active Tourer (B47C20A/B) 2.0, 220i Active Tourer (B48A20A/F) 2.0, 225i Active Tourer (B48A20B) 2.0 (2015-), (F46) 218i Gran Tourer (B38A15A) 1.5, 220d Gran Tourer (B47C20A/B) 2.0, 220i Gran Tourer (B48A20A) 2.0 (2015-), (F44) 218i (B38A15A) 1.5 Gran Coupe, 220d (B47C20B) 2.0 Gran Coupe, M235i (B48A20E) 2.0 Gran Coupe (2020-), X1 (F48) sDrive18i (B38A15A) 1.5, sDrive20d (B47C20A/B) 2.0, sDrive20i (B48A20A/F) 2.0, xDrive20d (B47C20A/B) 2.0, xDrive20i (B48A20A/F) 2.0, xDrive25i (B48A20B) 2.0 (2015-), X2 (F39) sDrive18i (B38A15A) 1.5, sDrive20i (B48A20A) 2.0, xDrive20d (B47C20A/B) 2.0 (2018-)</p>		<p>AR1137 Rear Axle Beam Bush</p> <p>Renault Kwid (B4D404) 1.0 (2015-)</p>
	<p>AR1133 Engine Mounting - RHS</p> <p>BMW 2-Series (F45) 225i Active Tourer (B48A20B) 2.0 (2015-), (F46) 220i Gran Tourer (B48A20A) 2.0 (2015-), (F44) 220d (B47C20B) 2.0 Gran Coupe (2020-), X1 (F48) sDrive20i (B48A20A/F) 2.0, xDrive20d (B47C20A/B) 2.0, xDrive20i (B48A20A/F) 2.0, xDrive25i (B48A20B) 2.0 (2015-), X2 (F39) sDrive20i (B48A20A) 2.0, xDrive20d (B47C20A/B) 2.0 (2018-); Cooper Clubman (F54) S (B46A20A, B48A20A, B48A20F) 2.0 (2010-), Mini Cooper Hatch (F55) S (B46A20A, B48A20A) 2.0 (2013-), Cooper Hatch (F56) S (B46A20A, B48A20A, B48A20F) 2.0, John Cooper Works (B46A20A, B48A20B) 2.0 (2013-), Cooper Hatch (F57) S (B46A20A, B48A20A) 2.0 Cabriolet (2013-), Cooper Countryman (F60) S (B46A20A, B48A20A) 2.0 (2017-)</p>		<p>AR1138 Front Strut Mounting</p> <p>Renault Captur (H4B) 0.9 TCe, (H5F) 1.2, (K9K) 1.5dCi (2015-), Clio III (K4J) 1.4, (K9K) 1.5, (K4M) 1.6, (F4R) 2.0 16V (04-14), Clio IV (H4B) 0.9 TCe, (D4F) 1.2, (H5F) 1.2, (M5M) 1.6 RS (2013-), Modus (D4F) 1.2, (K4J) 1.4, (K4M) 1.6 (05-08)</p>
	<p>AR1134 Engine Mounting - Front</p> <p>Honda Accord (R20A3) 2.0i V-TEC (08-15)</p>		<p>AR1139 Engine Mounting - Front</p> <p>Chevrolet Cruze (J300) (LXT) 1.6 L, LS Man. Pet. Sedan, (LDE) 1.6 Pet. Man. Sedan, (2H0, F18D4) 1.8 Pet. Man./Auto. Sedan (2009-), (J305) (LDE) 1.6 Pet. Man. Hatchback, (2H0, F18D4) 1.8 Pet. Man. Hatchback (2011-), Orlando (J309) (F18D4) 1.8L 5-Spd. Man. MPV (2012-)</p>
	<p>AR1140 Front Stabilizer Bar Bush</p> <p>Nissan X-Trail (T32) 4X2, 4X4 (R9M) 1.6dCi CVT (2014-); Renault Koleos I (HY) 4X4 (M9R) 2.0dCi 6-Spd. Auto./Man., (2TR702) 2.5 Dynamique 6-Spd. Man., (2TR703) 2.5 CVT (08-15)</p>		<p>AR1141 Front Strut Mounting</p> <p>Nissan Qashqai II (J11) 4X2 (HRA2DDT) 1.2T Acenta + D 6-Spd. Man., (K9K) 1.5dCi Acenta 6-Spd. Man., (R9M) 1.6dCi Acenta 6-Spd. Man., (MR16DDT) 1.6 Acenta Tech 6-Spd. Man. (2014-), X-Trail (T32) 4X2, 4X4 (R9M) 1.6 dCi CVT, 6-Spd., 4X2 (MR20DD) 2.0 CVT, 6-Spd., 4X4 (QR25DE) 2.5 SE, CVT (2014-); Renault Kadjar 4X2 (H5F408) 1.2T Dynamique 6-Spd. Man., (K9K) 1.5dCi Dynamique 6-Spd. Auto., 4X4 (R9M) 1.6dCi Dynamique 6-Spd. Man. (2016-), Megane IV (H5F408) 1.2T Dynamique 7-Spd. Auto., 6-Spd. Man. (2016-)</p>
			<p>AR1142 Rear Stabilizer Bar Bush</p> <p>Nissan X-Trail (T32) 4X2, 4X4 (R9M) 1.6dCi CVT (2014-)</p>
			<p>AR1143 Front Stabilizer Bar Bush</p> <p>Nissan Qashqai I (J10) 4X2 (K9K) 1.5dCi Acenta 6-Spd. Man., (M9R) 2.0dCi Acenta 6-Spd. Man. AWD, 4X4 (M9R) 2.0dCi 6-Spd. Man. (08-13), X-Trail (T32) 4X2 (MR20DD) 2.0 CVT, 6-Spd., 4X4 (QR25DE) 2.5 SE, CVT (2014-)</p>
			<p>AR1144L Rear Stabilizer Link - LHS</p> <p>Nissan Qashqai I (J10) 4X2 (K9K) 1.5dCi Acenta 6-Spd. Man., (HR16DE) 1.6 Acenta 5-Spd. Man., (MR20DE) 2.0 Acenta 6-Spd. Man., (M9R) 2.0dCi Acenta 6-Spd. Man. AWD, 4X4 (M9R) 2.0dCi 6-Spd. Man. (08-13), Qashqai II (J11) 4X2 (HRA2DDT) 1.2T Acenta + D 6-Spd. Man., (K9K) 1.5dCi Acenta 6-Spd. Man., (R9M) 1.6dCi Acenta 6-Spd. Man., (MR16DDT) 1.6 Acenta Tech 6-Spd. Man. (2014-), X-Trail (T31) 4X2 (MR20DE) 2.0 6-Spd. Man., 4X2 (M9R) 2.0dCi 6-Spd. Man., 4X4 (M9R) 2.0dCi SE 6-Spd. Auto., 4X4 (QR25DE) 2.5 SE 6-Spd. Man., CVT (07-15), X-Trail (T32) 4X2, 4X4 (R9M) 1.6 dCi CVT, 6-Spd., (MR20DD) 2.0 CVT, 6-Spd., (QR25DE) 2.5 SE, CVT (2014-); Renault Kadjar 4X2 (H5F408) 1.2T Dynamique 6-Spd. Man., (K9K) 1.5dCi Dynamique 6-Spd. Auto., 4X4 (R9M) 1.6dCi Dynamique 6-Spd. Man. (2016-), Koleos I (HY) 4X4 (M9R) 2.0dCi 6-Spd. Auto./Man., (2TR702) 2.5 Dynamique 6-Spd. Man., (2TR703) 2.5 CVT (08-15)</p>

ENGINE MOUNTING & RUBBER BUYERS GUIDE

	<p>AR1144R Rear Stabilizer Link - RHS Nissan Qashqai I (J10) 4X2 (K9K) 1.5dCi Acenta 6-Spd. Man., (HR16DE) 1.6 Acenta 5-Spd. Man., (MR20DE) 2.0 Acenta 6-Spd. Man., (M9R) 2.0dCi Acenta 6-Spd. Man. AWD, 4X4 (M9R) 2.0dCi 6-Spd. Man. (08-13), Qashqai II (J11) 4X2 (HRA2DDT) 1.2T Acenta + D 6-Spd. Man., (K9K) 1.5dCi Acenta 6-Spd. Man., (R9M) 1.6dCi Acenta 6-Spd. Man., (MR16DDT) 1.6 Acenta Tech 6-Spd. Man. (2014-), X-Trail (T31) 4X2 (MR20DE) 2.0 6-Spd. Man., 4X2 (M9R) 2.0dCi 6-Spd. Man., 4X4 (M9R) 2.0dCi SE 6-Spd. Auto, 4X4 (QR25DE) 2.5 SE 6-Spd. Man., CVT (07-15), X-Trail (T32) 4X2, 4X4 (R9M) 1.6 dCi CVT, 6-Spd., (MR20DD) 2.0 CVT, 6-Spd., (QR25DE) 2.5 SE, CVT (2014-); Renault Kadjar 4X2 (H5F408) 1.2T Dynamique 6-Spd. Man., (K9K) 1.5dCi Dynamique 6-Spd. Auto., 4X4 (R9M) 1.6dCi Dynamique 6-Spd. Man. (2016-), Koleos I (HY) 4X4 (M9R) 2.0dCi 6-Spd. Auto./Man., (2TR702) 2.5 Dynamique 6-Spd. Man., (2TR703) 2.5 CVT (08-15)</p>		<p>AR1155 Engine Mounting - LHS Nissan Qashqai II (J11) 4X2 (R9M) 1.6dCi Acenta 6-Spd. Man. (2014-), X-Trail (T32) 4X2, 4X4 (R9M) 1.6 dCi CVT, 6-Spd. (2014-); Renault Megane IV (H5F408) 1.2T Dynamique 7-Spd. Auto., (M5M450) 1.6 GT-Line 7-Spd. Auto., (M5P402) 1.8 RS 280 EDC Lux 6-Spd. Auto. (2016-)</p>
	<p>AR1145 Rear Stabilizer Bar Bush Nissan X-Trail (T31) 4X2 (MR20DE) 2.0 6-Spd. Man., 4X2 (M9R) 2.0dCi 6-Spd. Man., 4X4 (M9R) 2.0dCi SE 6-Spd. Auto, 4X4 (QR25DE) 2.5 SE 6-Spd. Man., CVT (07-15), X-Trail (T32) 4X2 (MR20DD) 2.0 CVT, 6-Spd., 4X4 (QR25DE) 2.5 SE, CVT (2014-); Renault Koleos I (HY) 4X4 (M9R) 2.0dCi 6-Spd. Auto./Man., (2TR702) 2.5 Dynamique 6-Spd. Man., (2TR703) 2.5 CVT (08-15)</p>		<p>AR1156 Engine Mounting - Front Daihatsu Sirion (K3-VE) 1.3 Sport Man. Pet. (00-05)</p>
	<p>AR1146 Engine Mounting - RHS Nissan X-Trail (T32) 4X4 (QR25DE) 2.5 SE, CVT (2014-)</p>		<p>AR1157L Tension Rod Bush - LHS (with Bracket) Opel Corsa B (13NE) 130 i, Lite, i S, le Chill Sedan, Hatch, (14NE) 140i Classic, Active, Lite, Lite+ Sedan, Hatch, (16SE) 160 i Classic, Sport, S, GSi, GSi Ltd., Classic iE, CD, CDE, S, Sedan, Hatch (96-03), Corsa LDV I (13NE) 130i Utility P/up Pet., (14NE) 1.4i Utility, S P/up Pet., (16NE) 1.6i Utility, S, P/up Sport, (X17D) 1.7D Utility P/up Dies. (97-04) - Pre-Lotus, Corsa Pronto P/van (3NE) 1.3i Pet. (99-00)</p>
	<p>AR1147 Front Torque Rod Assembly Nissan Qashqai II (J11) 4X2 (R9M) 1.6dCi Acenta 6-Spd. Man. (2014-), X-Trail (T32) 4X2, 4X4 (R9M) 1.6dCi CVT, 4X4 (QR25DE) 2.5 SE, CVT (2014-)</p>		<p>AR1157R Tension Rod Bush - RHS (with Bracket) Opel Corsa B (13NE) 130 i, Lite, i S, le Chill Sedan, Hatch, (14NE) 140i Classic, Active, Lite, Lite+ Sedan, Hatch, (16SE) 160 i Classic, Sport, S, GSi, GSi Ltd., Classic iE, CD, CDE, S, Sedan, Hatch (96-03), Corsa LDV I (13NE) 130i Utility P/up Pet., (14NE) 1.4i Utility, S P/up Pet., (16NE) 1.6i Utility, S, P/up Sport, (X17D) 1.7D Utility P/up Dies. (97-04) - Pre-Lotus, Corsa Pronto P/van (3NE) 1.3i Pet. (99-00)</p>
	<p>AR1148 Rear / Transmission Torque Rod Assy. Nissan X-Trail (T32) 4X4 (MR20DD) 2.0 CVT, 6-Spd., (QR25DE) 2.5 SE, CVT (16-18)</p>		<p>AR1158 Engine Mounting - RHS Renault Captur (H4B) 0.9T TCe, (H5F) 1.2, (K9K) 1.5dCi (2013-), Clio IV (H4B) 0.9T TCe 90 (2013-), Sandero II (B8) (H4B400) 900T TCe 90 (2014-)</p>
	<p>AR1149 Engine Mounting - LHS Nissan X-Trail (T32) 4X4 (QR25DE) 2.5 SE, CVT (14-16)</p>		<p>AR1159 Engine Mounting - LHS Renault Sandero II (B8) (H4B400) 900T TCe 90 (2014-)</p>
	<p>AR1150 Engine Mounting - LHS Nissan X-Trail (T32) 4X4 (QR25DE) 2.5 SE, CVT (16-18)</p>		<p>AR1160 Engine Mounting - RHS Nissan Micra (K13) (K9K) 1.5dCi (11-18)</p>
	<p>AR1151 Engine Mounting - RHS Nissan Qashqai II (J11) 4X2 (MR16DDT) 1.6 Acenta Tech 6-Spd. Man. (2014-), X-Trail (T32) 4X2 (MR20DD) 2.0 CVT, 6-Spd. (2014-)</p>		<p>AR1161 Transmission Mounting Nissan Micra (K14) (H4B408, HR09DET) 0.9T (2018-)</p>
	<p>AR1152 Engine Mounting - LHS Nissan X-Trail (T32) 4X2 (MR20DD) 2.0 CVT, 6-Spd. (2014-)</p>		<p>AR1162 Front Strut Mounting Nissan Micra (K14) (H4B408, HR09DET) 0.9T (2018-)</p>
	<p>AR1153 Lower Torque Rod Mounting Nissan Qashqai II (J11) 4X2 (MR16DDT) 1.6 Acenta Tech 6-Spd. Man. (2014-), X-Trail (T32) 4X2, 4X4 (R9M) 1.6 dCi CVT, 6-Spd. (2014-)</p>		<p>AR1163 Front Stabilizer Bar Bush Nissan Micra (K14) (H4B408, HR09DET) 0.9T (2018-)</p>
	<p>AR1154 Engine Mounting - RHS Nissan Qashqai II (J11) 4X2 (R9M) 1.6dCi Acenta 6-Spd. Man. (2014-), X-Trail (T32) 4X2, 4X4 (R9M) 1.6 dCi CVT, 6-Spd. (2014-)</p>		<p>AR1164 Engine Mounting - Front Chevrolet Cruze (F18D4) 1.8, LS 6-Spd. Auto. (2012-)</p>
	<p>AR1165 Transmission Mounting Chevrolet Cruze (F18D4) 1.8, LS 6-Spd. Auto. (2012-)</p>		<p>AR1165 Transmission Mounting Chevrolet Cruze (F18D4) 1.8, LS 6-Spd. Auto. (2012-)</p>

ENGINE MOUNTING & RUBBER BUYERS GUIDE

199













 NO PICTURE AVAILABLE AT TIME OF PRINT	AR1166 Nissan Juke 4X2 (HRA2DDT) 1.2 6-Spd. Man. (15-19)	Engine Mounting - RHS
	AR1167 Nissan Juke 4X2 (HRA2DDT) 1.2 6-Spd. Man. (15-19), (MR16DDT) 1.6 6-Spd. Man., 1.6 DIG-T 6-Spd. Man. (11-19)	Transmission Mounting
	AR1168 Nissan Juke 4X2 (MR16DDT) 1.6 DIG-T 6-Spd. Man., 4X4 1.6 DIG-T CVT (11-19)	Engine Mounting - RHS
	AR1169 Nissan Juke 4X2 (K9K) 1.5dCi 6-Spd. Man. (15-19)	Engine Mounting - RHS
	AR1170 Nissan Micra (K12) (K9K) 1.5dCi 5-Spd. Man. (04-11), NV200 (K9K) 1.5dCi 5-Spd. Man. (2013-)	Engine Mounting - RHS Upper Torque Rod
	AR1171 Chevrolet Utility 1.3D AC, Club, Sport, 1.4 AC, Club, Sport, 1.8 AC, Club, Sport (2010-)	Rear Stabilizer Bar Bush
	AR1172L/R Isuzu KB-Series (D-MAX) 4X2, 4X4 KB250 (4JK1) DC LE, D/C LE, Fleetside P/up, KB300 (4JJ1) TDC TDi LX, D/C LX, Fleetside P/up, Hi-Rider (04-13)	Engine Mounting - LHS
	AR1172L/R Isuzu KB-Series (D-MAX) 4X2, 4X4 KB250 (4JK1) DC LE, D/C LE, Fleetside P/up, KB300 (4JJ1) TDC TDi LX, D/C LX, Fleetside P/up, Hi-Rider (04-13)	Engine Mounting - RHS
 NO PICTURE AVAILABLE AT TIME OF PRINT	AR1173 Toyota C-HR (NGX10) (8NR-FTS) 1.2T (2017-)	Engine Mounting - Rear
 NO PICTURE AVAILABLE AT TIME OF PRINT	AR1173I Toyota C-HR (NGX10) (8NR-FTS) 1.2T (2017-)	Engine Mounting - Rear (Insert)
 NO PICTURE AVAILABLE AT TIME OF PRINT	AR1174 Toyota C-HR (NGX10) (8NR-FTS) 1.2T (2017-)	Engine Mounting - LHS
 NO PICTURE AVAILABLE AT TIME OF PRINT	AR1175 Toyota C-HR (NGX10) (8NR-FTS) 1.2T (2017-)	Engine Mounting - LHS (Damper)
 NO PICTURE AVAILABLE AT TIME OF PRINT	AR1176 Toyota C-HR (NGX10) (8NR-FTS) 1.2T (2017-)	Engine Mounting - RHS













 NO PICTURE AVAILABLE AT TIME OF PRINT	AR1177 Toyota C-HR (NGX10) (8NR-FTS) 1.2T (2017-)	Front Strut Mounting
 NO PICTURE AVAILABLE AT TIME OF PRINT	AR1178 Nissan NP200 (K4M) 1.6 16V SWB S, SE P/up (2008-)	Engine Mounting - RHS
	AR1179 Toyota Land Cruiser (VDJ200) 4X4 (1VD-FTV) 4.5D VX V8, (1UR-FE) 4.6 VX V8, (2UZ-FE) 4.7 VX V8 (2010-)	Front Lower Control Arm Bush - Outer Rear
 NO PICTURE AVAILABLE AT TIME OF PRINT	AR1180 Renault Kadjar 4X2 (H5F408) 1.2T Dynamique 6-Spd. Man. (2016-), Megane IV (H5F408) 1.2T Dynamique 7-Spd. Auto., 6-Spd. Man. (2016-)	Engine Mounting - RHS
	AR1181 Renault Kadjar 4X2 (H5F408) 1.2T Dynamique 6-Spd. Man., (K9K) 1.5dCi Dynamique 6-Spd. Auto. (2016-)	Engine Mounting - Rear Torque Rod
	AR1182 Nissan Qashqai II (J11) 4X2 (HRA2DDT) 1.2T Acenta + D 6-Spd. Man., (K9K) 1.5dCi Acenta 6-Spd. Man., (MR16DDT) 1.6 Acenta Tech 6-Spd. Man. (2014-); Renault Kadjar 4X2 (H5F408) 1.2T Dynamique 6-Spd. Man. (2016-), Megane IV (H5F408) 1.2T Dynamique 6-Spd. Man., (H4M750) 1.6 Dynamique 5-Spd. Man. (2016-)	Engine Mounting - LHS
	AR1183 Renault Kadjar 4X2 (K9K) 1.5dCi Dynamique 6-Spd. Auto. (2016-)	Engine Mounting - RHS
	AR1184 Renault Kadjar 4X4 (R9M) 1.6dCi Dynamique 6-Spd. Man. (2016-)	Engine Mounting - RHS
	AR1185 Nissan Qashqai II (J11) 4X2 (HRA2DDT) 1.2T Acenta + D 6-Spd. Man., (K9K) 1.5dCi Acenta 6-Spd. Man., (R9M) 1.6dCi Acenta 6-Spd. Man. (2014-); Renault Kadjar 4X4 (R9M) 1.6dCi Dynamique 6-Spd. Man. (2016-), Megane IV (H5F408) 1.2T Dynamique 7-Spd. Auto., 6-Spd. Man., (H4M750) 1.6 Dynamique 5-Spd. Man., (M5M450) 1.6 GT-Line 7-Spd. Auto., (M5P402) 1.8 RS 280 EDC Lux 6-Spd. Auto. (2016-)	Engine Mounting - Rear Lower Torque Rod
	AR1186 Nissan Qashqai II (J11) 4X2 (HRA2DDT) 1.2T Acenta + D 6-Spd. Man., (K9K) 1.5dCi Acenta 6-Spd. Man., (MR16DDT) 1.6 Acenta Tech 6-Spd. Man. (2014-); Renault Kadjar 4X2 (H5F408) 1.2T Dynamique 6-Spd. Man., (K9K) 1.5dCi Dynamique 6-Spd. Auto., 4X4 (R9M) 1.6dCi Dynamique 6-Spd. Man. (2016-)	Front Stabilizer Bar Bush
	AR1187 Nissan Qashqai II (J11) 4X2 (HRA2DDT) 1.2T Acenta + D 6-Spd. Man. (2014-)	Engine Mounting - RHS
 NO PICTURE AVAILABLE AT TIME OF PRINT	AR1188 Nissan Qashqai II (J11) 4X2 (K9K) 1.5dCi Acenta 6-Spd. Man. (2014-)	Engine Mounting - RHS

ENGINE MOUNTING & RUBBER BUYERS GUIDE

	AR1189 Front Stabilizer Bar Bush Nissan Qashqai II (J11) 4X2 (R9M) 1.6dCi Acenta 6-Spd. Man. (2014-)		AR1201 Engine Mounting - RHS Nissan X-Trail (T31) 4X4 (QR25DE) 2.5 SE 6-Spd. Man., CVT (07-15); Renault Koleos I (HY) 4X4 (2TR702) 2.5 Dynamique 6-Spd. Man., (2TR703) 2.5 CVT (08-15)
	AR1190 Engine Mounting - RHS Renault Megane IV (H4M750) 1.6 Dynamique 5-Spd. Man. (2016-)		AR1202 Engine Mounting - RHS Upper Torque Rod Renault Koleos I (HY) 4X4 (2TR702) 2.5 Dynamique 6-Spd. Man., (2TR703) 2.5 CVT (08-15)
	AR1191 Engine Mounting - RHS Renault Megane IV (M5M450) 1.6 GT-Line 7-Spd. Auto. (2016-)		AR1203 Engine Mounting - LHS Renault Koleos I (HY) 4X4 (2TR702) 2.5 Dynamique 6-Spd. Man., (2TR703) 2.5 CVT (08-15)
	AR1192 Engine Mounting - RHS Renault Megane IV (M5P402) 1.8 RS 280 EDC Lux 6-Spd. Auto. (2017-)		AR1204 Engine Mounting - RHS Nissan X-Trail (T30) 4X4 (YD22ETI) 2.2D 6-Spd. Man. (01-07)
	AR1193 Engine Mounting - RHS Nissan Qashqai I (J10) 4X2 (K9K) 1.5dCi Acenta 6-Spd. Man. (08-13); Renault Megane IV (M5M450) 1.6 GT-Line 7-Spd. Auto. (2016-)		AR1205 Engine Mounting - LHS Nissan X-Trail (T31) 4X2 2.0dCi (M9R) 6-Spd. Man. (07-15)
	AR1194 Engine Mounting - RHS Upper Torque Rod Nissan Qashqai I (J10) 4X2 (K9K) 1.5dCi Acenta 6-Spd. Man., 4X4 (M9R) 2.0dCi 6-Spd. Man. (08-13), X-Trail (T31) 4X2 (M9R) 2.0dCi 6-Spd. Man., 4X4 (M9R) 2.0dCi 6-Spd. Auto. (07-15); Renault Koleos I (HY) 4X4 (M9R) 2.0dCi 6-Spd. Auto./Man. (08-15), Megane IV (M5P402) 1.8 RS 280 EDC Lux 6-Spd. Auto. (2017-)		AR1206 Engine Mounting - Rear Torque Rod Nissan X-Trail (T31) 4X2 2.0dCi (M9R) 6-Spd. Man. (07-15)
	AR1195 Transmission Mounting Nissan Qashqai I (J10) 4X2 (K9K) 1.5dCi Acenta 6-Spd. Man. (08-13)		AR1207 Engine Mounting - RHS Upper Torque Rod Nissan X-Trail (T31) 4X4 (QR25DE) 2.5 SE 6-Spd. Man., CVT (07-15)
	AR1196 Engine Mounting - Rear Lower Torque Rod Nissan Qashqai I (J10) 4X2 (K9K) 1.5dCi Acenta 6-Spd. Man. (08-13)		AR1208 Engine Mounting - LHS Nissan X-Trail (T31) 4X4 (QR25DE) 2.5 SE 6-Spd. Man. (07-15)
	AR1197 Engine Mounting - RHS Upper Torque Rod Nissan Qashqai I (J10) (M9R) 2.0dCi Acenta 6-Spd. Man. AWD (08-13)		AR1209 Engine Mounting - LHS Nissan X-Trail (T31) 4X4 (QR25DE) 2.5 LE CVT (07-15)
	AR1198 Engine Mounting - Rear Torque Rod Nissan Qashqai I (J10) (M9R) 2.0dCi Acenta 6-Spd. Man. AWD (08-13)		AR1210 Engine Mounting - Front L/RHS Mercedes-Benz B-Class (W245) B200CDi (OM640.941) 2.0 6-Spd. Man., CVT (06-12)
	AR1199 Engine Mounting - Rear Torque Rod Renault Koleos I (HY) 4X4 (M9R) 2.0dCi 6-Spd. Auto./Man. (08-15)		AR1211 Engine Mounting - Front L/RHS Mercedes-Benz B-Class (W245) B200 Turbo (M266.980) 2.0 6-Spd. Man. (06-12)
	AR1200 Engine Mounting - LHS Renault Koleos I (HY) 4X4 (M9R) 2.0dCi 6-Spd. Auto./Man. (08-15)		AR1212 Engine Mounting - Front L/RHS Mercedes-Benz B-Class (W245) B200 Turbo (M266.980) 2.0 CVT (06-12)
			AR1213 Engine Mounting - Rear RHS Mercedes-Benz B-Class (W245) B200CDi (OM640.941) 2.0 6-Spd. Man., CVT (06-12)

ENGINE MOUNTING & RUBBER BUYERS GUIDE

	AR1214 Engine Mounting - Rear LHS Mercedes-Benz B-Class (W245) B200CDi (OM640.941) 2.0 6-Spd. Man., CVT (06-12)
	AR1215 Engine Mounting - RHS Honda Civic VIII (R18A1) 1.8 Exi, Lxi 5-Spd. Man./Auto. (06-11)
	AR1216 Engine Mounting - RHS Upper Torque Rod Honda Civic VIII (R18A1) 1.8 Exi 5-Spd. Man. (06-11)
	AR1217 Engine Mounting - Rear Lower Torque Rod Honda Civic VIII (R18A1) 1.8 Exi 5-Spd. Man. (06-11)
	AR1218 Transmission Mounting Honda Civic VIII (R18A1) 1.8 Exi, Lxi 5-Spd. Man./Auto. (06-11)
	AR1219 Engine Mounting - RHS Upper Torque Rod Honda Civic VIII (R18A1) 1.8 Lxi 5-Spd. Auto. (06-11)
	AR1220 Engine Mounting - Rear Lower Torque Rod Honda Civic VIII (R18A1) 1.8 Lxi 5-Spd. Auto. (06-11)
	AR1221 Front Strut Mounting Honda Civic VIII (R18A1) 1.8 Exi, Lxi 5-Spd. Man./Auto. (06-11)
	AR1222 Front Strut Mounting Honda Civic VIII (R18A2) 1.8 Vxi 6-Spd. Man. (06-11)
	AR1223 Front Lower Control Arm Bush - Inner Front Honda Civic VIII (R18A1) 1.8 Exi, Lxi 5-Spd. Man./Auto. (06-11)
	AR1224 Engine Mounting - RHS Honda CR-V III 4X4 (R20A1) 2.0 6-Spd. Man., (R20A1) 2.0 RVSi 5-Spd. Auto. (07-12)
	AR1226 Engine Mounting - Rear Lower Torque Rod Honda CR-V III 4X4 (R20A1) 2.0 6-Spd. Man., (K24Z4) 2.4 6-Spd. Man. (07-12)

	AR1227 Engine Mounting - LHS Honda CR-V III 4X4 (R20A1) 2.0 6-Spd. Man. (07-12)
	AR1228 Engine Mounting - RHS Honda CR-V III 4X4 (N22A2) 2.2 i-CTDi 6-Spd. Man. (07-12)
	AR1229 Engine Mounting - RHS Upper Torque Rod Honda CR-V III 4X4 (N22A2) 2.2 i-CTDi 6-Spd. Man. (07-12)
	AR1230 Engine Mounting - Rear Lower Torque Rod Honda CR-V III 4X4 (N22A2) 2.2 i-CTDi 6-Spd. Man. (07-12)
	AR1231 Transmission Mounting Honda CR-V III 4X4 (N22A2) 2.2 i-CTDi 6-Spd. Man. (07-12)
	AR1232 Engine Mounting - RHS Honda CR-V III 4X4 (K24Z4) 2.4 5-Spd. Auto., 6-Spd. Man. (07-12)
	AR1234 Engine Mounting - Front Honda CR-V III 4X4 (K24Z4) 2.4 6-Spd. Man. (07-12)
	AR1235 Transmission Mounting Honda CR-V III 4X4 (K24Z4) 2.4 6-Spd. Man. (07-12)
	AR1237 Engine Mounting - RHS Toyota Corolla (E180) (1NR-FE) 1.3 Esteem, Prestige 6-Spd. Man. (14-19)
	AR1239 Engine Mounting - LHS Toyota Corolla (E180) (1NR-FE) 1.3 Esteem, Prestige 6-Spd. Man. (14-19)
	AR1240 Engine Mounting - RHS Toyota Corolla (E180) (1ND-TV) 1.4D-4D Esteem, Prestige 6-Spd. Man. (14-19)
	AR1242 Engine Mounting - LHS Toyota Corolla (E180) (1ND-TV) 1.4D-4D Esteem, Prestige 6-Spd. Man. (14-19)
	AR1243 Engine Mounting - Front Toyota Corolla (E180) (2ZR-FE) 1.8 16V Exclusive CVT (14-19)

ENGINE MOUNTING & RUBBER BUYERS GUIDE

	AR1244 Engine Mounting - RHS Toyota Corolla (E180) (1ZR-FE) 1.6 Prestige 6-Spd. Man., CVT, (2ZR-FE) 1.8 16V Exclusive CVT (14-19)		AR1257 Engine Mounting - RHS Upper Torque Rod Land Rover Freelander II 4X4 (L359) (204PT) 2.0 Pet. 6-Spd. Auto., (224DT) 2.2D 6-Spd. Man./Auto., (B6324S) 3.2 Pet. 6-Spd. Auto. (07-14)
	AR1245 Engine Mounting - Rear Toyota Corolla (E180) (1ZR-FE) 1.6 Prestige CVT, (2ZR-FE) 1.8 16V Exclusive CVT (14-19)		AR1258 Transmission Mounting Land Rover Freelander II 4X4 (L359) (204PT) 2.0 Pet. 6-Spd. Auto. (07-14)
	AR1246 Engine Mounting - LHS Toyota Corolla (E180) (2ZR-FE) 1.8 16V Exclusive CVT (14-19)		AR1259 Engine Mounting - RHS Land Rover Freelander II 4X4 (L359) (224DT) 2.2D 6-Spd. Man. (07-14)
	AR1247 Engine Mounting - Front Toyota Corolla (E180) (1ZR-FE) 1.6 Prestige 6-Spd. Man. (14-19)		AR1260 Engine Mounting - RHS Land Rover Freelander II 4X4 (L359) (224DT) 2.2D 6-Spd. Auto. (07-14)
	AR1248 Engine Mounting - Rear Lower Support Renault Megane I (K4J750) 1.4 5-Spd. Man., (K4M700/1) 1.6 5-Spd. Man., 4-Spd. Auto. (96-02)		AR1261 Transmission Mounting Land Rover Freelander II 4X4 (L359) (224DT) 2.2D 6-Spd. Man./Auto., (B6324S) 3.2 Pet. 6-Spd. Auto. (07-14)
	AR1249 Engine Mounting - Rear Lower Support Renault Megane I (F3R750, F7R710/4) 2.0 5-Spd. Man. (96-02)		AR1262 Engine Mounting - RHS Land Rover Freelander II 4X4 (L359) (B6324S) 3.2 Pet. 6-Spd. Auto. (07-14)
	AR1250 Engine Mounting - RHS Renault Megane III (H5F404) 1.2 6-Spd. Man. (09-15)		AR1263 Front Strut Mounting Land Rover Freelander II 4X4 (L359) (204PT) 2.0 Pet. 6-Spd. Auto., (224DT) 2.2D 6-Spd. Man./Auto., (B6324S) 3.2 Pet. 6-Spd. Auto. (07-14)
	AR1251 Engine Mounting - Rear Lower Torque Rod Renault Megane III (H5F404) 1.2 6-Spd. Man. (09-15)		AR1264 Front Stabilizer Bar Bush Land Rover Freelander II 4X4 (L359) (204PT) 2.0 Pet. 6-Spd. Auto., (224DT) 2.2D 6-Spd. Man./Auto., (B6324S) 3.2 Pet. 6-Spd. Auto. (07-14)
	AR1252 Engine Mounting - RHS Renault Megane III (H4J700) 1.4 6-Spd. Man. (09-15)		AR1265 Rear Stabilizer Bar Bush Land Rover Freelander II 4X4 (L359) (204PT) 2.0 Pet. 6-Spd. Auto., (224DT) 2.2D 6-Spd. Man./Auto., (B6324S) 3.2 Pet. 6-Spd. Auto. (07-14)
	AR1253 Engine Mounting - Rear Lower Support Renault Clio II (K4J) 1.4 16V (99-08), Scenic I (K4J) 1.4 5-Spd. Man., (K7M) 1.6 4-Spd. Auto. (98-03)		AR1266 Front Lower Control Arm Bush - Inner Front Land Rover Freelander II 4X4 (L359) (204PT) 2.0 Pet. 6-Spd. Auto., (224DT) 2.2D 6-Spd. Man./Auto., (B6324S) 3.2 Pet. 6-Spd. Auto. (07-14)
	AR1254 Engine Mounting - RHS Renault Clio II (K9K) 1.5dCi (99-08), Kangoo I (K9K) 1.6 5-Spd. Man. (01-13)		AR1267L Front Lower Control Arm Bush - Outer Rear LHS Land Rover Freelander II 4X4 (L359) (204PT) 2.0 Pet. 6-Spd. Auto., (224DT) 2.2D 6-Spd. Man./Auto., (B6324S) 3.2 Pet. 6-Spd. Auto. (07-14)
	AR1255 Front Strut Mounting Isuzu KB-Series (D-MAX) 4X2 KB250 (4JK1) DC LE, D/C LE, Fleetside P/up, KB300 (4JJ1) TDC TDi LX, D/C LX, Fleetside P/up, Hi-Rider (04-13); Toyota Land Cruiser (FJ80) 4X4 (3F-E) 4.0 GX, VX P/up Pet., 4-Spd. Auto. (90-92), (FZJ100) 4X4 4.2 VX TD P/up, S/W, GX DSL P/up AHC Diesel 5-Spd. Auto. (02-04)		AR1267R Front Lower Control Arm Bush - Outer Rear RHS Land Rover Freelander II 4X4 (L359) (204PT) 2.0 Pet. 6-Spd. Auto., (224DT) 2.2D 6-Spd. Man./Auto., (B6324S) 3.2 Pet. 6-Spd. Auto. (07-14)
	AR1256 Engine Mounting - RHS Land Rover Freelander II 4X4 (L359) (204PT) 2.0 Pet. 6-Spd. Auto. (07-14)		

ENGINE MOUNTING & RUBBER BUYERS GUIDE

203

	AR1268 Land Rover Freelander I 4X4 (L314) (18K4F) 1.8 5-Spd. Man. (98-06)	Engine Mounting - LHS		AR1280 Honda Jazz IV (GK) (L12B4) 1.2 5-Spd. Man., (L15Z2) 1.5 5-Spd. Man. (2015-)	Transmission Mounting
	AR1269 Land Rover Freelander I 4X4 (L314) (18K4F) 1.8 5-Spd. Man., (20T2N) 2.0TD 5-Spd. Man. (98-06)	Engine Mounting - RHS		AR1281 Honda Jazz IV (GK) (L15Z2) 1.5 CVT (2015-)	Engine Mounting - Rear Torque Rod
	AR1270 Land Rover Freelander I 4X4 (L314) (18K4F) 1.8 5-Spd. Man., (20T2N) 2.0TD 5-Spd. Man. (98-06)	Engine Mounting - RHS Upper Torque Rod		AR1282 Honda Jazz IV (GK) (L15Z2) 1.5 CVT (2015-)	Transmission Mounting
	AR1271 Land Rover Freelander I 4X4 (L314) (18K4F) 1.8 5-Spd. Man., (20T2N) 2.0TD 5-Spd. Man. (98-06)	Engine Mounting - Rear Lower Torque Rod		AR1283 Honda Jazz IV (GK) (L12B4) 1.2 5-Spd. Man., (L15Z2) 1.5 5-Spd. Man., CVT. (2015-)	Front Stabilizer Bar Bush
	AR1272 Land Rover Freelander I 4X4 (L314) (20T2N) 2.0TD 5-Spd. Man. (98-06)	Engine Mounting - LHS		AR1284 Renault Clio IV (D4F) 1.2 5-Spd. Man. (2013-)	Engine Mounting - RHS
	AR1273 Land Rover Freelander I 4X4 (L314) (M47) 2.0 TD4 5-Spd. Man., (25K4F) 2.5 5-Spd. Auto. (98-06)	Engine Mounting - LHS		AR1286 Mazda 3 (BM, BN) (Z6Y1) 1.6, (PEX2, PEY7) 2.0 (2014-)	Engine Mounting - LHS
	AR1274 Land Rover Freelander I 4X4 (L314) (M47) 2.0 TD4 5-Spd. Man. (98-06)	Engine Mounting - RHS		AR1287 Volkswagen Polo (9N) (BBX) 2.0 85kw 5-Spd. Man. (2005-)	Engine Mounting - Rear Support
	AR1275 Land Rover Freelander I 4X4 (L314) (M47) 2.0 TD4 5-Spd. Man., (25K4F) 2.5 5-Spd. Auto. (98-06)	Engine Mounting - RHS Upper Torque Rod		AR1288 Volkswagen Polo (6C, GP) (CJZC) 1.2 TSi 66kw 5-Spd. Man., (CJZD) 1.2 TSi 81kw 5-Spd. Man. (2014-)	Engine Mounting - Rear Support
	AR1276 Land Rover Freelander I 4X4 (L314) (M47) 2.0 TD4 5-Spd. Man., (25K4F) 2.5 5-Spd. Auto. (98-06)	Engine Mounting - Rear Lower Torque Rod		AR1289 Volkswagen Polo (6C) (CUSA, CYZB) 1.4 TDi 55kw 5-Spd. Man., (CUTA, CYZA) 1.4 TDi 77kw 5-Spd. Man. (2014-)	Engine Mounting - Rear Support
	AR1277 Land Rover Freelander I 4X4 (L314) (25K4F) 2.5 5-Spd. Auto. (98-06)	Engine Mounting - RHS		AR1290 Volkswagen Polo (6C, GP) (DAJB) 1.8 TSi GTi 141kw 7-Spd. DSG (2015-)	Engine Mounting - Rear Support
	AR1278 Honda Jazz IV (GK) (L12B4) 1.2 5-Spd. Man., (L15Z2) 1.5 5-Spd. Man., CVT. (2015-)	Engine Mounting - RHS		AR1293 Nissan Micra (K12) (K9K276) 1.5dCi 63kw 5-Spd. Man. Hatch, (K9K722) 1.5dCi 60kw 5-Spd. Man. Hatch (06-10), NP200 (K9K) 1.5dCi SWB S, SE P/up Dies., (K4M) 1.6 16V SWB S, SE P/up Pet., (K7M) 1.6 8V SWB S, SE P/up Pet. (2008-); Renault Clio III (D4F) 1.2 16V 55kw Man. Hatch (06-12), Duster I (HS) (K4M) 1.6 16V 75kw Man. SUV (13-17), Grand Scenic II (K4M) 1.6 16V 83kw Man. MPV (04-09), Logan (K7M) 1.6 8V 64kw Man. Sedan (2008-), Megane II (K4M) 1.6 16V 83kw Man. Hatch, Sedan (03-09), Modus (D4F) 1.2 55kw Man. MPV (2005-), Sandero I (K7J710) 1.4 55kw Man. Hatch, (K7M710) 1.6 64kw Man. Hatch (2009-), Scenic II (K4M) 1.6 16V 83kw Man. MPV (04-09)	Engine Mounting - Rear Support
	AR1279 Honda Jazz IV (GK) (L12B4) 1.2 5-Spd. Man., (L15Z2) 1.5 5-Spd. Man. (2015-)	Engine Mounting - Rear Torque Rod			

ENGINE MOUNTING & RUBBER BUYERS GUIDE

	AR1294 Engine Mounting - Rear Support Nissan NP200 (K9K) 1.5dCi SWB S, SE P/up Dies., (K4M) 1.6 16V SWB S, SE P/up Pet., (K7M) 1.6 8V SWB S, SE P/up Pet. (2008-); Renault Clio III (D4F7) 1.2 16V 55kw Man., (K4J) 1.4 16V 72kw Man., (K9K) 1.5dCi 60kw Man., (K4M) 1.6 16V 82kw Man. (06-12), Kangoo I (K7M750) 1.6 8V 64kw Man., (K4M830, K4M831, K4M834) 1.6 16V 78kw Man. (2011-), Megane II (K9K) 1.5dCi 60kw Man., (K4M) 1.6 16V 83kw Man. (03-09), Modus (D4F) 1.2 55kw Man., (K4J) 1.4 72kw Man., (K4M) 1.6 16V 82kw Man. (2005-)
	AR1295 Engine Mounting - RHS Renault Clio III (K4J) 1.4 16V, (K9K) 1.5dCi 5-Spd. Man. (04-14), Modus (K4J) 1.4 5-Spd. Man. (05-08)
	AR1296 Engine Mounting - RHS Renault Modus (D4F740) 1.2 5-Spd. Man. (05-08)
	AR1297 Engine Mounting - RHS Renault Clio III (K4J) 1.4 16V, (K4M800, K4M804) 1.6 5-Spd. Man., (K4M801) 1.6 4-Spd. Auto. (04-14)
	AR1298 Engine Mounting - RHS Upper Torque Rod Renault Clio III (K9K) 1.5dCi (06-09)
	AR1299 Engine Mounting - RHS Renault Clio III (K9K) 1.5dCi (06-09)
	AR1306 Engine Mounting - Rear Ford Fiesta (SFJA, SFJB, SFJC, SFJD) 1.0 74kW 6-Spd. Auto. (08-17)
	AR120 Engine Stabilizer Rubber Leyland Mini - All Models (66-84) ID: 14, OD: 25, L: 21
	AR121 Exhaust Hanger - Middle Fiat Uno (156A2) 1.0 Cento, (160A3) 1.1 Fire, Mia, Rio, Tempo, Espresso P/van (90-05) ID: 45, OD: 68, L: 15
	AR122 Exhaust Hanger - Rear Leyland Mini - All Models (66-84) THREAD: M8 x 1.25 OD: 26

	AR123 Air Cleaner Mounting BMW 3-Series (E30) 316 (M10) 1.8, 316i (M40) 1.6, (M40) 1.8 Cabriolet, 318i (M40) 1.8 Cabriolet, 320i (M20, M50) 2.0, 323i (M20) 2.3, 325i (M20B25) 2.5, (M20B27) 2.7 Shadowline, iS, Shadowline, Cabriolet, 333i (M30) 3.3 6-Cyl. (83-92), (E36) 316i (M40) 1.8 Dolphin Shape, 318i (M40) 1.8 Motorsport I / II, (M42) 1.9 S, 320i (M50) 2.0, 323i (M52) 2.5, 325i (M50) 2.5 Dolphin Convertible, 325tds (M51) 2.5 6-Cyl. Dies., 328i (M52T) 2.8, 328i (M52TU) 2.8 Dolphin Convertible, Individual (92-00), 5-Series (E28) M5 (MX30) 3.5 (86-89), (E34) 520i (M50B20) 2.0, 525i (M50B25) 2.5 (89-96), 530i (M60B30) 3.0 V8, 535i (M30B35) 3.5 6-Cyl., 540 (M60B40) 4.0 Edition V8 (95-96), M5 (M50B35) 3.5 6-Cyl. (92-94), 7-Series (E23) 728 (M30B28) 2.8, 728i (M30B28) 2.8, 730 (M30B28) 3.0, 733i (M30B32) 3.2, 735i (M30) 3.5, 745i (S38) 3.5 6-Cyl. (78-89), (E32) 730i (M30, M60) 3.0, 735i (M30) 3.5 6-Cyl., 740i (M60, M62) 4.0, 750iL (M70) 5.0 V12 (87-96); VW Caddy (HM, HV, JK) 1.6, i P/up Dies., Pet. 4-Spd. Man., (HV) 1.8 L Sport, Sport, P/up (81-03), Citi Golf 1.3 L, Chico, L Shuttle 4-Spd. Man., Chico Lux, (HM) 1.6 L, Chico Lux, Deco, Designa, Blues, Ritz, Shuttle, Sonic, Sport Chico 4/5-Spd. Man., 3-Spd. Auto., (BZF) 1.8 CTi, Designa, L Sport, 5-Spd. Man. (83-02), 1.4 L, Chico, (AGY, BSY) 1.4i, L, Citi.com, VeloCiti, TenaCiti, CitiStorm, Sport, Rox, Rhythm Man., (AFX) 1.6i Life, Velociti, TenaCiti, CitiStorm, Sport, Rox 5-Spd. Man. (99-09), Fox 1.3 L, L Trippa 4-Spd. Man., 1.6 L 4/5-Spd. Man., 3-Spd. Auto., 1.8 L Sport 5-Spd. Man. (87-96), Golf II 1.3 CL 4-Spd. Man., 1.6 CSL 5-Spd. Man., 1.8 GTS 16V, CSX, GTi 8V, 16V, 5-Spd. Man., 3-Spd. Auto., 2.0 GTi 8V, Exec. 16V 5-Spd. Man. (84-92), Jetta II 1.6 CSL 5-Spd. Man., 1.8 CLi, CLi Exec., Executive, CLX, CSX 5-Spd. Man., 3-Spd. Auto., 2.0 L 16V 5-Spd. Man. (85-92)
	AR1391 Engine Mounting - RHS Renault R5 (75-85)
	AR1417 Transmission Mounting Ford Courier (F6) 1.6 SWB P/up Pet., (F2, R2) 2.2 D/cab, Explorer, Std., XLT, Leisure SWB, LWB P/up Pet. - F2, Dies. - R2 (86-00), Ranger 1.8, XL SWB, LWB P/up Pet., 2.2, XL SWB, LWB P/up Pet., (WL4) 2.5D, TD High Trail, High Trail XL, XL D/cab, XLT Hi Trail, Super Cab XLT Hi Trail SWB, LWB P/up Dies., 4.0 V6 SubCab XLT Hi Trail, Super Cab XLT, XLE D/C, Hi Trail SWB, LWB P/up Pet. (99-01); Mazda B-Series B1600 (F6) 1.8 SWB Magnum P/up Pet., B1800 (F8) 1.8 S/LWB Magnum, Drifter P/up Pet., B2000 (FE) 2.0 LWB Magnum, Drifter P/up Pet., B2200 (F2, R2) 2.2 SWB, LWB D/cab, Magnum, Drifter P/up Pet. - F2, Dies. - R2 (82-00), Drifter 1.8 SWB, LWB XL P/up Pet., 2.2 SWB, LWB XL, (WL4) 2.5TD LWB Hi Ride, S/cab, SL Hi Ride, SLE, SLX, D/cab, LX Hi Ride, P/up Dies., 2.6i LWB SL Hi Ride S/cab, SLE D/C, SLX, Hi Ride, SLX Hi Ride D/cab (00-08)
	AR1419 Engine Mounting - L/RHS Mazda 323 1.3, 1.4 (77-81) L: 82, W: 35
	AR1440 Engine Mounting - L/RHS, Transmission Mounting Land Rover 88-Series II, II A/B, III 2.25 SWB P/up Pet., Dies., (OHI) 2.6 LWB P/up 6-Cyl. SE Pet., 109-Series 2.25 SWB, LWB P/up Pet., Dies., (OHI) 2.6 LWB P/up 6-Cyl. SE Pet., 110-Series (R6) 2.6 LWB P/up 6-Cyl., (ADE236) 3.5 V8 LWB "PUP" P/up Pet. (58-96)
	AR1457 Front Lower Control Arm Bush - Inner Ford Cortina MKIII 1.6 L SWB P/up Kent Pet., 2.0 V4 SWB P/up Koln Pet., 2.5 V6 L SWB P/up Essex Pet., (EV30) 3.0 GT, L, XL, XLE "Big Six" Essex (71-77)
	AR1486 Front Upper Control Arm Bush - Inner & Outer Ford Cortina MKIII 1.6 L SWB P/up Kent Pet., 2.0 V4 SWB P/up Koln Pet., 2.5 V6 L SWB P/up Essex Pet., (EV30) 3.0 GT, L, XL, XLE "Big Six" Essex (71-77) ID: 12, OD: 33, L: 39

ENGINE MOUNTING & RUBBER BUYERS GUIDE

 ID: 14.5, OD: 33, L: 44	AR1486A Front Upper Control Arm Bush - Inner Front & Outer Rear Ford Cortina MKIV 1.3 L Kent, 1.6 1-Tonner SWB P/up Kent Pet., 2.0 GL, GLE Koln, 3.0 V6 1-Tonner SWB P/up Essex Pet., Cortina MKV 1.6 1-Tonner SWB P/up Kent Pet., 2.4D 1-Tonner SWB P/up York Pet., 3.0 V6 1-Tonner SWB, LWB P/up Essex Pet. (77-86)
 ID: 12, OD: 31, L: 70	AR1487 Front Lower Control Arm Bush - Inner Ford Cortina MKIV 1.3 L Kent, 1.6 1-Tonner SWB P/up Kent Pet., 2.0 GL, GLE Koln, 3.0 V6 1-Tonner SWB P/up Essex Pet., Cortina MKV 1.6 1-Tonner SWB P/up Kent Pet., 2.4D 1-Tonner SWB P/up York Pet., 3.0 V6 1-Tonner SWB, LWB P/up Essex Pet. (77-86)
 ID: 12.5, OD: 40, L: 44	AR1490 Front Lower Control Arm Bush - Outer Ford Cortina MKIII 1.6 L SWB P/up Kent Pet., 2.0 V4 SWB P/up Koln Pet., 2.5 V6 L SWB P/up Essex Pet., (EV30) 3.0 GT, L, XL, XLE "Big Six" Essex (71-77)
 ID: 12.5, OD: 40, L: 44	AR1491 Front Lower Control Arm Bush - Outer Ford Cortina MKIV 1.3 L Kent, 1.6 1-Tonner SWB P/up Kent Pet., 2.0 GL, GLE Koln, 3.0 V6 1-Tonner SWB P/up Essex Pet., Cortina MKV 1.6 1-Tonner SWB P/up Kent Pet., 2.4D 1-Tonner SWB P/up York Pet., 3.0 V6 1-Tonner SWB, LWB P/up Essex Pet. (77-86)
 ID: 12, OD: 39.5, L: 45	AR1493 Front Upper Control Arm Bush - Front Ford Cortina MKIII, MKIV, MKV (71-86)
 ID: 12.5, OD: 40, L: 44	AR1494 Front Upper Control Arm Bush - Rear Ford Cortina MKIII, MKIV, MKV (71-86)
 THREAD: M10 x 1.25 OD: 63, L: 79, W: 34	AR2003 Engine Mounting - L/RHS, Transmission Mounting Land Rover 88-Series II, II A/B, III 2.25 SWB P/up Pet., Dies., (OHI) 2.6 LWB P/up 6-Cyl. SE Pet., 109-Series 2.25 SWB, LWB P/up Pet., Dies., (OHI) 2.6 LWB P/up 6-Cyl. SE Pet., 110-Series (R6) 2.6 LWB P/up 6-Cyl., (ADE236) 3.5 V8 LWB "PUP" P/up Pet. (58-96)
 ID: 58, OD: 87, T: 15	AR2011 Exhaust Hanger - Middle, Rear Ford Cortina MKI, MKII (62-71), Escort (68-80)
 OD: 46, L: 37	AR2013 Exhaust Hanger - Middle, Rear Ford Cortina MKIII 1.6 L SWB P/up Kent Pet., 2.0 V4 SWB P/up Koln Pet., 2.5 V6 L SWB P/up Essex Pet., (EV30) 3.0 GT, L, XL, XLE, "Big Six" Essex (71-77), Cortina MKIV 1.3 L Kent, 1.6 1-Tonner SWB P/up Kent Pet., 2.0 GL, GLE Koln, 3.0 V6 1-Tonner SWB P/up Essex Pet. (77-86), Cortina MKV 1.6 1-Tonner SWB P/up Kent Pet., 2.4D 1-Tonner SWB P/up York Pet., 3.0 V6 1-Tonner SWB, LWB P/up Essex Pet. (77-86)
 ID: 31, OD: 57, T: 13	AR2014 Exhaust Hanger - Middle BMW 3-Series (E30) 316 (M10) 1.8, 316i (M40) 1.6, (M40) 1.8 Cabriolet, 318i (M40) 1.8 Cabriolet (83-92), 320i (M20, M50) 2.0, 323i (M20) 2.3, 325i (M20B25) 2.5, (M20B27) 2.7 Shadowline, iS Shadowline, Cabriolet, 333i (M30) 3.3 6-Cyl. (83-92)

 THREAD: M10 x 1.5 OD: 70, L: 38.5/92.5	AR2015 Engine Mounting - L/RHS Ford Cortina MKIII 1.6 L SWB P/up Kent Pet., 2.0 V4 SWB P/up Koln Pet., 2.5 V6 L SWB P/up Essex Pet., (EV30) 3.0 GT, L, XL, XLE "Big Six" Essex (71-77), Cortina MKIV 1.3 L Kent, 1.6 1-Tonner SWB P/up Kent Pet., 2.0 GL, GLE Koln, 3.0 V6 1-Tonner SWB P/up Essex Pet. (77-86), Cortina MKV 1.6 1-Tonner SWB P/up Kent Pet., 2.4D 1-Tonner SWB P/up York Pet., 3.0 V6 1-Tonner SWB, LWB P/up Essex Pet. (77-86), Courier 3.0 V6 D/cab, Std., L, Leisure, Explorer SWB, LWB P/up, Essex Pet. (86-00), Courier 4X4 (WL4) 2.5D TD V6 D/cab, Leisure LWB P/up Dies., 3.0 V6 Std., XLT, D/cab, Leisure, Explorer, Exec. LWB P/up Essex Pet., 3.4 V6 Leisure D/cab LWB P/up Pet. (90-00); Mazda B-Series B2600 (4G54) LWB D/cab, Magnum, Drifter, P/up Pet. (86-02), B3000 V6 LWB D/cab, Magnum, Drifter P/up Essex Pet., B3400 V6 LWB D/cab, Magnum P/up Pet. (86-99), B-Series 4X4 B3000 V6 LWB D/cab, Magnum, Drifter P/up Essex Pet., B3400 V6 LWB D/cab Magnum P/up Pet. (86-99)
 ID: 12.5, OD: 25, L: 24.5	AR2018 Front Upper Control Arm Bush - Inner & Outer Nissan 620 (J15) 1.5 SWB, LWB P/up Pet. (73-80)
	AR2022 Exhaust Hanger - Middle Ford Escort MKI / II 1.1 300 SWB P/van Kent Pet., 1.3 30/35/45 SWB P/van Kent Pet., 1.6 45 P/van SWB P/van Kent Pet. (68-81)
	AR2024 Front Strut Mounting Volkswagen Golf II 1.3 CL 4-Spd. Man., 1.6 CSL 5-Spd. Man., 1.8 GTS 16V, CSX, GTi 8V, 16V, 5-Spd. Man., 3-Spd. Auto., 2.0 GTi 8V, Exec. 16V 5-Spd. Man. (84-92), Jetta II 1.6 CSL 5-Spd. Man., 1.8 CLi, CLi Exec., Executive, CLX, CSX 5-Spd. Man., 3-Spd. Auto., 2.0 L 16V 5-Spd. Man. (85-92)
	AR2025 Front Strut Mounting Volkswagen Caddy (HM, HV, JK) 1.6, i P/up Dies., Pet. 4-Spd. Man., (HV) 1.8 L Sport, Sport, P/up (81-03), Citi Golf 1.3 L, Chico, L Shuttle 4-Spd. Man., Chico Lux, (HM) 1.6 L, Chico Lux, Deco, Designa, Blues, Ritz, Shuttle, Sonic, Sport Chico 4/5-Spd. Man., 3-Spd. Auto., (BZF) 1.8 CTi, Designa, L Sport, 5-Spd. Man. (83-02), 1.4 L, Chico, (AGY, BSY) 1.4i, L, Citi.com, VeloCiti, TenaCiti, CitiStorm, Sport, Rox, Rhythm Man., (AFX) 1.6i Life, Velociti, TenaCiti, CitiStorm, Sport, Rox 5-Spd. Man. (99-09), Fox 1.3 L, L Trippa 4-Spd. Man., 1.6 L 4/5-Spd. Man., 3-Spd. Auto., 1.8 L Sport 5-Spd. Man. (87-96)
 ID: 12, OD: 21/30, L: 33.5	AR2029 Universal Mounting Various Makes & Models
 THREAD: M10 x 1.5 OD: 50, L: 36	AR2039 Universal Mounting Various Makes & Models
 ID: 14, OD: 28.5, L: 39	AR2042 Shackle Bush - Rear Upper Ford Cortina MKIII 1.6 L SWB P/up Kent Pet., 2.0 V4 SWB P/up Koln Pet., 2.5 V6 L SWB P/up Essex Pet., (EV30) 3.0 GT, L, XL, XLE "Big Six" Essex (71-77), Cortina MKIV 1.3 L Kent, 1.6 1-Tonner SWB P/up Kent Pet., 2.0 GL, GLE Koln, 3.0 V6 1-Tonner SWB P/up Essex Pet. (77-86), Cortina MKV 1.6 1-Tonner SWB P/up Kent Pet., 2.4D 1-Tonner SWB P/up York Pet., 3.0 V6 1-Tonner SWB, LWB P/up Essex Pet. (77-86)



ENGINE MOUNTING & RUBBER BUYERS GUIDE

 <p>ID: 18, OD: 40, L: 36</p>	<p>AR2060 Shackle Bush - Front</p> <p>Isuzu KBD-Series KBD20/21 (C190) 2.0 SWB P/up Dies., KBD22 (C223) 2.2 LE SWB P/up Dies., KBD23 (4JA1) 2.5 LE SWB P/up Dies., KBD25/26 (C190) 2.0 LWB P/up Dies., KBD27 (C223) 2.2 LWB P/up Dies., KBD28 (4JA1) 2.5 LWB P/up Dies. (78-89), KB-Series KB21 (G180Z) 1.6 SWB, Fleetside, P/up Pet. (G161Z) 1.8 SWB, P/up Pet., KB22 (180Z) 1.8 SWB P/up Pet., KB23 (200Z) 2.0 SWB P/up Pet., KB24 (4ZD1) 2.3 LE SWB P/up Pet., KB26 (G161Z) 1.6 LWB P/up Pet., (G180Z) 1.8 LWB P/up Pet., KB27 (G180Z) 1.8 LWB P/up Pet., KB29 (4ZD1) 2.3 LWB P/up Pet. (81-89), KB-Series 4X4 KB40 (G161Z) SWB P/up Pet., KB41 (G161Z), SWB P/up Pet. (G180Z) SWB P/up Pet., KB42 (G180Z) SWB P/up, KB43 (G200Z) SWB P/up Pet., KB44 (4ZD1) LE SWB P/up Pet. (79-89), KBD-Series 4X4 KBD40 (C190) SWB P/up Dies., KBD41 (C190) Dies., KBD42 (C223) Dies. (79-89)</p>
 <p>ID: 20.5, OD: 49, L: 18</p>	<p>AR2062 Tension Rod Bush</p> <p>Ford Cortina MKIII 1.6 L SWB P/up Kent Pet., 2.0 V4 SWB P/up Koln Pet., 2.5 V6 L SWB P/up Essex Pet., (EV30) 3.0 GT, L, XL, XLE "Big Six" Essex (71-77), Cortina MKIV 1.3 L Kent, 1.6 1-Tonner SWB P/up Kent Pet., 2.0 GL, GLE Koln, 3.0 V6 1-Tonner SWB P/up Essex Pet. (77-86), Cortina MKV 1.6 1-Tonner SWB P/up Kent Pet., 2.4D 1-Tonner SWB P/up York Pet., 3.0 V6 1-Tonner SWB, LWB P/up Essex Pet. (77-86)</p>
 <p>ID: 11, OD: 23, L: 45</p>	<p>AR2067 Shackle Bush - Rear Lower</p> <p>Nissan 1400 (A14S) 1.4 SWB P/van, P/up Pet., B140 (A14S) 1.4 SWB Deluxe, Sport, Std., CHAMP P/up Pet. (80-93), Tiida (HR16DE) 1.6 Visia, Visia +, Acenta, (MR18DE) 1.8 Acenta (06-13)</p>
 <p>ID: 12, OD: 23, L: 32</p>	<p>AR2068 Shackle Bush - Rear Upper</p> <p>Nissan 1400 (A14S) 1.4 SWB P/van, P/up Pet., B140 (A14S) 1.4 SWB Deluxe, Sport, Std., CHAMP P/up Pet. (80-93), Tiida (HR16DE) 1.6 Visia, Visia +, Acenta, (MR18DE) 1.8 Acenta (06-13)</p>
 <p>ID: 49, OD: 133, H: 30</p>	<p>AR2075 Propshaft Coupling</p> <p>BMW 1-Series (E81, E87) 116i (N45) 1.6, 118i (N46) 2.0, 120i (N46) 2.0, 130i (N52) 3.0 (04-15), (E88) 120i (N46) 2.0 (04-15), (E82) 120d (N47) 2.0 (2005-), (E87) 118d (M47) 2.0, 120d (M47) 2.0 (2005-), 3-Series (E36) 328i (M52T) 2.8 (92-99), Z3 (M52) 2.8 Roadster, (M54) 3.0 Roadster 6-Cyl. (97-03), (E46) 318i (M43) 1.8, (M43) 2.0 Touring SW, (N42) 2.0, 318ti (M47B) 2.0 Compact, 320d (M47D) 2.0 (98-05), 320i (M52) 2.0, (M54) 2.2, 323Ci (M52) 2.5 Coupe, 323i (M52) 2.5, 325Ci (M54) 2.5 Coupe, 325i, 325ti (M50, M54) 2.5 Touring SW, Compact (99-05), 328i (M52TU) 2.8 Coupe, 330Ci (M54) 3.0 Convertible, 330d (M57) 3.0 Dies., 330i (M54) 3.0 (99-05), (E90) 320d (M47) 2.0, 320i (N46) 2.0 (05-13), 5-Series (E34) 525i (M50B25) 2.5, M5 (M50B35) 3.5 6-Cyl., 530i (M60B30) 3.0 V8, 535i (M30B35) 3.5 6-Cyl., 540i (M60B40) 4.0 Edition V8 (89-96), (E39) 530i (M54) 3.0 (96-04), 7-Series (E23) 728 (M30B28) 2.8, 728i (M30B28) 2.8, 730 (M30B28) 3.0, 733i (M30B32) 3.2, 735i (M30) 3.5, 745i (S38) 3.5 6-Cyl. (78-89), (E32) 730i (M30, M60) 3.0, 735i (M30) 3.5 6-Cyl. (87-96), X3 (E83) 4X4 (M54, N52N) 2.5i SUV, LCi SUV, (M57N2) 3.0d SUV, (N52N) 3.0si (04-07), (M47N2) 2.0d Steptronic SUV Dies., (N46) 2.0i (06-10), X5 (E53) 4X4 (M57N) 3.0d Steptronic SUV Dies., (M54) 3.0i Steptronic SUV 6-Cyl. Pet., (M62) 4.4i Steptronic SUV Pet., (N62) 4.8iS Steptronic SUV V8 Pet. (01-10)</p>



 <p>ID: 10, OD: 25, W: 16</p>	<p>AR22 Shock Rubber - Front & Rear, Stabilizer Link Grommet</p> <p>Ford Courier (F6) 1.6 SWB P/up Pet., (F8) 1.8 SWB, LWB P/up Ch. Cab, Std., XLT Pet., (FE) 2.0 XLT LWB P/up Pet., 2.2 D/cab, Explorer, Std., XLT, Leisure SWB, LWB P/up (F2) Pet., (R2) Dies., (WL4) 2.5D TD, Leisure LWB P/up Dies., 3.0 V6 D/cab, Std., L, Leisure, Explorer SWB, LWB P/up, Essex Pet., 3.4 V6 Leisure, D/cab SWB, LWB P/up Pet. (86-00), Everest 4X2, 4X4 3.0 TDCi (09-15), Husky (4G62) 1.8 1-Ton SWB P/up, P/van, Bus Pet., (4G63) 2.0 1-Ton SWB P/up, P/van, Bus Pet. (85-99), Ranger 2.5D TD XL D/cab, XLT, SubCab, XLT Hi Trail, Super Cab XLT LWB P/up Dies., 3.0 TDCi D/cab XLE, SubCab XLT, Hi Trail, Super Cab XLT LWB P/up Dies. (07-12), Spectron (F2) 2.2 LWB Bus, P/van Pet. (91-04); Isuzu KBD-Series KBD20/21 (C190) 2.0 SWB P/up Dies., KBD22 (C223) 2.2 LE SWB P/up Dies., KBD23 (4JA1) 2.5 LE SWB P/up Dies., KBD25/26 (C190) 2.0 LWB P/up Dies., KBD27 (C223) 2.2 LWB P/up Dies., KBD28 (4JA1) 2.5 LWB P/up Dies. (78-89), KB-Series KB21 (G180Z) 1.6 SWB, Fleetside, P/up Pet., (G161Z) 1.8 SWB, P/up Pet., KB22 (180Z) 1.8 SWB P/up Pet., KB23 (200Z) 2.0 SWB P/up Pet., KB24 (4ZD1) 2.3 LE SWB P/up Pet., KB26 (G161Z) 1.6 LWB P/up Pet., (G180Z) 1.8 LWB P/up Pet., KB27 (G180Z) 1.8 LWB P/up Pet., KB29 (4ZD1) 2.3 LWB P/up Pet. (81-89), KB-Series 4X4 KB40 (G161Z) SWB P/up Pet., KB41 (G161Z), SWB P/up Pet. (G180Z) SWB P/up Pet., KB42 (G180Z) SWB P/up, KB43 (G200Z) SWB P/up Pet., KB44 (4ZD1) LE SWB P/up Pet. (79-89), KBD-Series 4X4 KBD40 (C190) SWB P/up Dies., KBD41 (C190) Dies., KBD42 (C223) Dies. (79-89), KB-Series KB160 (4ZA1) 1.6 SWB, Fleetside P/up Pet., KB200 (ZC1) 2.0 SWB, LWB, D/cab, LE, Fleetside, P/up Pet., KB220 (C22NE) 2.2 LWB D/cab, LE P/up Pet., KB230 (4ZD1) 2.3 SWB, LWB, D/cab P/up Pet., KB250D (4JA1) 2.5 SWB, LWB D/cab, LE, Fleetside, P/up Dies., KB280DT (4JB1) 2.8 SWB, LWB LE, D/cab LE, Frontier LX P/up (89-04), KB-Series KB260 (4ZE1) 2.6 SWB/LWB LE, LX, D/cab P/up Pet., KB320 (6VD1) 3.2 V6 SWB, LWB LE, LX, D/cab, Frontier, Reef, Blazer P/up Pet. (92-04); Mazda B-Series B3000 V6 LWB D/cab, Magnum, Drifter P/up Essex Pet., B3400 V6 LWB D/cab, Magnum P/up Pet. (86-99), B-Series 4X4 B2600 (4G54) V6 LWB D/cab Magnum, Drifter P/up Pet. (86-95), BT-50 4X2, 4X4 2.5 TD SLX D/cab P/up, 2.6 SLE D/cab, S/cab, P/up, (WLE7) 3.0 CRDi D/cab, SLE S/cab, CRDi SLX P/up (07-12), Marathon (F2) 2.2 LWB Bus, P/van Pet. (91-04); Mitsubishi Colt LDV (4G32) 1.6 SWB/ LWB Lo-Line K01/11 P/up Pet., (4G63) 2.0 SWB/ LWB D/cab Hi-Line, Lo-Line K12 P/up Pet., (4D56) 2.5D LWB Hi-Line, Lo-Line D/cab K14 P/up Dies., (4G54) 2.6 LWB Hi-Line K13, P/up (94-98), Colt LDV (4G63) 2.0, i LWB Std., Hi-Line S/cab, K62T P/up, Pet., 2.4i LWB Hi-Line, S/cab, D/cab, Hi Rider K65T, P/up Pet., (4D56) 2.5D LWB Hi-Line, Std., S/cab, K64T P/up Dies. (98-09), L300 (4G32) 1.6 SWB Mini Bus, Van Pet., (4G62) 1.8 SWB/ LWB, D/S, P/U, P/up, P/van Pet., (4G62) 2.0 LWB P/up Pet. (82-01), Starwagon (4G62) 2.0 LWB S, SL, SLE P/van Pet. (82-01); Nissan 1400 (A14S) 1.4 SWB P/van, P/up Pet., B140 (A14S) 1.4 SWB Deluxe, Sport, Std., CHAMP P/up Pet. (80-93), 620 (J15) 1.5 SWB, LWB P/up Pet. (73-80), 680 (J15) 1.5 SWB P/up Pet., (SD22) 2.2 LWB P/up Dies. (73-80), Maxima (GV) (VG30E) 300SE 6-Cyl. (91-97), Maxima (QX) (VQ20E/DE) 2.0, (VQ30DE) 3.0 V6 (96-04), Patrol (Y60) 4X4 (VG30E) 3.0 V6 LWB Twin Cab S/W Pet. (90-94), Patrol (Y61) 4X4 (VG30E) 3.0 V6 LWB Y60 S/W Pet., 3.0Di 6-Cyl. LWB GRX, TDi GL S/W Dies., (TD42) 4.2 6-Cyl. LWB LDF P/up, S/W Dies., 4.5 6-Cyl. LWB P/up Dies., 4.8 6-Cyl. LWB GL, GRX P/up Dies. (95-04), Sentra (E13S) 1.3 GL, SX, (E16E/S) 1.6 GL, GX, GXE, GXEi Coupe, SGLi (87-92), Skyline (R31) (CA20, RB20E) 2.0 GL, GLE, SGi, SGLi, (RB30E) 3.0 6-Cyl. SGLi (87-92)</p>
---	---

ENGINE MOUNTING & RUBBER BUYERS GUIDE













 <p>ID: 10, OD: 25, W: 16</p>	<p>AR22 - Continued</p> <p>Toyota Cressida (GX71) (1G-E) 2.0 GLi6 5-Spd. Man., Executive DOHC, I.R.S. 4-Spd. Auto. (86-92), (MX73) (5M-GE) 2.8i RSi, RSi Exec. DOHC 5-Spd. Man., 4-Spd. Auto., (MX75) 3.0 GLS 5-Spd. Man., (ECT) (7M-GE) 3.0i I.R.S. 24V DOHC 4-Spd. Auto. (86-92), (RX70) (21R) 2.0 GL, GLX, GL S/W, (RX72) (22R) 2.4 GLE, GL S/W, GLE S/W, (RX73) (22R) I.R.S. GL, GLE 4/5-Spd. Man./Auto. (87-92), (YX72) (3Y) 2.0 GS, GS Exec., GSE OHV 5-Spd. Man. (89-92); Toyota HiAce (YH50) (2Y) 1.8 SWB P/van 4-Spd. Man. Pet., (YH60) (2Y) 1.8 LWB LS Wagon, P/van 5-Spd. Man. Pet. (83-91), (YH53) (4Y) 2.2 SWB LS, GLX, GLX Exec. Wagon, Super10, (YH63) (4Y) 2.2 LWB Super16, SuperT, P/van, Siyaya Pet. 5-Spd. Man., 4-Spd. Auto. (86-09), Hilux (LN50) (L) 2.2 SWB P/up Dies. 4-Spd. Man. (84-98), (LN51) (2L) 2.4 SWB S D/cab, Raider P/up Dies. (84-98), (LN55) (L) 2.2 LWB P/up Dies. (84-98), (LN56) (2L) 2.4 LWB Raider, D/cab P/up Dies. (84-98), (LN57) (3L) 2.8 LWB Raider D/cab, P/up Dies. (95-05), (LN140) (2L) 2.4 SWB DLX P/up Dies. (98-05), (LN145) 2.4 LWB P/up Dies. (98-05), (LN192) (5L) 3.0D LWB D-E DLX, Raider D/cab Raised Body Dies., (KZ-TE) 3.0iD LWB D/cab Raider, Legend35 Raider, D/cab, Raider Dies. (98-05), (RN58) (22R) 2.4 LWB S, S D/cab, SR D/cab, SRX, Raider Pet. (84-98), (RZN147) (1RZ-E) 2.0 LWB SR D/cab Pet. 5-Spd. Man., (1RZ-E) 2.0 SWB SR, DLX, S, Pet. 5-Spd. Man. (98-05), (RZN169) (3RZ-FE) 2.7i LWB P/up, Raider, Raider D/C, SRX D/C, DLX S/C, Legend35, Legend35 D/C Pet. (98-05), (YN51) (2Y) 1.8 SWB S, SR, Raider P/up Pet., 5-Spd. Man. (86-98), (YN56) (2Y) 1.8 LWB P/up 4/5-Spd. Man. Pet. (86-98), (YN58) (4Y) 2.2 LWB Raider, SRX P/up Pet. (84-98), (YN140) (2Y) 1.8 SWB, LWB D/cab, Raider Pet. 5-Spd. Man. (98-05), Hilux "VIGO" 4X2 (1TR-FE) 2.0i LWB S/cab, S, SRX, P/up Pet. Standard Body (05-11), Hilux 4X2 (1TR-FE) 2.0 VVT-i 5-Spd. Man., S/cab Std. Body, (2KD-FTV) 2.5D-4D 5-Spd. Man. Std., Raised Body, Hilux 4X4 (2KDF-TV) 2.5D-4D 5-Spd. Man., Raised Body (11-16), Hilux "REVO" 4X2 (1TR-FE) 2.0 VVT-i, (2GD-FTV) 2.4 GD Std. Body, (2GD-FTV) 2.4 GD-6 Raised Body, (2TR-FE) 2.7 VVT-i, Hilux "REVO" 4X4 (2GD-FTV) 2.4 GD-6 Raised Body (2016-), Quantum (2KD-FTV) 2.5D, "Family" Bus, 10/14 Seater MPV Dies., (2TR-FE) 2.7, "Family" Bus, 10/14/15 Seater, MPV, Ses' fikile Pet. (2005-), Stallion (KF50) (5K) 1.5 Commuter, P/up, SR5 P/up, Bus, P/van Pet., 4/5-Spd. Man. (87-91), (YF50) (2Y) 1.8 P/up, (2Y) 1.8 SR5 P/up, P/van, Pet., (LF50) (2L) 2400D P/up Dies. (91-04), Venture (YF50) (2Y) 1.8 P/van, 8/10-Seater Pet., 4/5-Spd. Man., (YF51) (4Y) 2.2 10-Seater, Getaway 5-Seater, GLE 9-Seater Pet. 5-Spd. Man., (LF50) (2L) 2.4 10-Seater Dies. 5-Spd. Man. (91-04)</p>
 <p>M8/12 x 66/80 x 42</p>	<p>AR3030 Transmission Mounting</p> <p>Volkswagen Caddy (HM, HV, JK) 1.6, i P/up, Pet. 4-Spd. Man., (HV) 1.8 L Sport, Sport, P/up (81-03), Citi Golf 1.3 L, Chico, L Shuttle 4-Spd. Man., Chico Lux, (HM) 1.6 L, Chico Lux, Deco, Designa, Blues, Ritz, Shuttle, Sonic, Sport Chico 4/5-Spd. Man., (BZF) 1.8 CTi, Designa, L Sport, 5-Spd. Man. (83-02), 1.4 L, Chico, (AGY, BSY) 1.4i, L, Citi.com, VeloCiti, TenaCiti, CitiStorm, Sport, Rox, Rhythm Man., (AFX) 1.6i Life, Velociti, TenaCiti, CitiStorm, Sport, Rox 5-Spd. Man. (99-09), Fox 1.3 L, L Trippa 4-Spd. Man., 1.6 L 4/5-Spd. Man., 1.8 L Sport 5-Spd. Man. (87-96)</p>
 <p>M8/12 x 66/89 x 46</p>	<p>AR3031 Transmission Mounting</p> <p>Volkswagen Caddy (HM, HV, JK) 1.6, i P/up Dies., 4-Spd. Man., (HV) 1.8 L Sport, Sport, P/up (81-03), Citi Golf 1.3 L, Chico, L Shuttle Auto., Chico Lux, (HM) 1.6 L, Chico Lux, Deco, Designa, Blues, Ritz, Shuttle, Sonic, Sport Chico 3-Spd. Auto., (BZF) 1.8 CTi, Designa, L Sport, Auto. (83-02), Fox 1.3 L, L Trippa Auto., 1.6 L 3-Spd. Auto., 1.8 L Sport Auto. (87-96)</p>
	<p>AR3032 Engine Mounting - L/RHS</p> <p>Audi 80 1.5 GL, 1.6 (75-78); Volkswagen Passat 1.3, 1.5, 1.6, 1.8, 1.9, 2.2 (74-87)</p>
 <p>ID: 17.2, OD: 30, L: 21</p>	<p>AR32 Shock Rubber & Stabilizer Grommet</p> <p>Various Makes & Models</p>

 <p>ID: 15, OD: 27.4, L: 18.2</p>	<p>AR33 Shock Rubber - Front / Rear</p> <p>Fiat Uno (156A2) 1.0 Cento, (160A3) 1.1 Fire, Mia, Rio, Tempo, Espresso P/van (90-05), (146C1) 1.4 Beat, Mia, Pacer, Pacer SX, Tempo SX, (146A) 1.4 Turbo (90-98); GoNow X-Space 2.2i DC, DCext, 2.8 TDX DC (07-10); GWM Steed 2.2i D/cab Lux, Multi-Wagon (07-11); Hyundai Bakkie (4D56) 2.5i DT LWB P/up, P/van Dies., (4G54) 2.6i LWB P/van, P/up, Dropside Pet. (97-09), H100 (4D56) 2.5i DT LWB P/up, Dropside Dies., (4G54) 2.6i LWB P/van, Dropside Pet. (98-04); Isuzu KBD-Series KBD20/21 (C190) 2.0 SWB P/up Dies., KBD22 (C223) 2.2 LE SWB P/up Dies., KBD23 (4JA1) 2.5 LE SWB P/up Dies., KBD25/26 (C190) 2.0 LWB P/up Dies., KBD27 (C223) 2.2 LWB P/up Dies., KBD28 (4JA1) 2.5 LWB P/up Dies. (78-89), KB-Series KB21 (G180Z) 1.6 SWB, Fleetside, P/up Pet. (G161Z) 1.8 SWB, P/up Pet., KB22 (180Z) 1.8 SWB P/up Pet., KB23 (200Z) 2.0 SWB P/up Pet., KB24 (4ZD1) 2.3 LE SWB P/up Pet., KB26 (G161Z) 1.6 LWB P/up Pet., (G180Z) 1.8 LWB P/up Pet., KB27 (G180Z) 1.8 LWB P/up Pet., KB29 (4ZD1) 2.3 LWB P/up Pet. (81-89), KB-Series 4X4 KB40 (G161Z) SWB P/up Pet., KB41 (G161Z), SWB P/up Pet. (G180Z) SWB P/up Pet., KB42 (G180Z) SWB P/up, KB43 (G200Z) SWB P/up Pet., KB44 (4ZD1) LE SWB P/up Pet. (79-89), KBD-Series 4X4 KBD40 (C190) SWB P/up Dies., KBD41 (C190) Dies., KBD42 (C223) Dies. (79-89), KB-Series KB160 (4ZA1) 1.6 SWB, Fleetside P/up Pet., KB200 (ZC1) 2.0 SWB, LWB, D/cab, LE, Fleetside, P/up Pet., KB220 (C22NE) 2.2 LWB D/cab, LE P/up Pet., KB230 (4ZD1) 2.3 SWB, LWB, D/cab P/up Pet., KB250D (4JA1) 2.5 SWB, LWB D/cab, LE, Fleetside, P/up Dies., KB280DT (4JB1) 2.8 SWB, LWB LE, D/cab LE, Frontier LX P/up (89-04), KB-Series 4X4 KB220 (C22NE) LWB D/cab, LE, P/up Pet., KB230 (4ZD1) SWB P/up Pet., KB250D (4JA1) SWB / LWB, D/cab, LE, LE D/cab P/up Dies., KB260 (4ZE1) LWB D/cab, LE, LX D/cab P/up (89-04), KB-Series KB260 (4ZE1) 2.6 SWB/LWB LE, LX, D/cab P/up Pet., KB320 (6VD1) 3.2 V6 SWB, LWB LE, LX, D/cab, Frontier, Reef, Blazer P/up Pet. (92-04); Mitsubishi L300 (4G32) 1.6 SWB Mini Bus, Van Pet., (4G62) 1.8 SWB/ LWB, D/S, P/U, P/up, P/van Pet., (4G62) 2.0 LWB P/up Pet. (82-01), Starwagon (4G62) 2.0 LWB S, SL, SLE P/van Pet. (82-01); Nissan 620 (J15) 1.5 SWB, LWB P/up Pet. (73-80), 680 (J15) 1.5 SWB P/up Pet., (SD22) 2.2 LWB P/up Dies. (73-80), E20 (J16) 1.6 SWB Bus, Coach, P/van Pet., (L18) 1.8 SWB, LWB 10, 16-Seater Bus, Coach, Coach, GL, GLE, Econolux, Ekonovan, Ekonowagon Pet. (73-96), Tiida (HR16DE) 1.6 Visia, Visia +, Acenta, (MR18DE) 1.8 Acenta (06-13); Toyota HiAce (YH50) (2Y) 1.8 SWB P/van 4-Spd. Man. Pet., (YH60) (2Y) 1.8 LWB LS Wagon, P/van 5-Spd. Man. Pet. (83-91), (YH53) (4Y) 2.2 SWB LS, GLX, GLX Exec. Wagon, Super10, (YH63) (4Y) 2.2 LWB Super16, SuperT, P/van, Siyaya Pet. 5-Spd. Man., 4-Spd. Auto. (86-09), Hilux (LN50) (L) 2.2 SWB P/up Dies. 4-Spd. Man. (84-98), (LN51) (2L) 2.4 SWB S D/cab, Raider P/up Dies. (84-98), (LN55) (L) 2.2 LWB P/up Dies. (84-98), (LN56) (2L) 2.4 LWB Raider, D/cab P/up Dies. (84-98), (LN57) (3L) 2.8 LWB Raider D/cab, P/up Dies. (95-05), (LN140) (2L) 2.4 SWB DLX P/up Dies. (98-05), (LN145) 2.4 LWB P/up Dies. (98-05), (RN58) (22R) 2.4 LWB S, S D/cab, SR D/cab, SRX, Raider Pet. (84-98), (RZN147) (1RZ-E) 2.0 LWB SR D/cab Pet. 5-Spd. Man., (1RZ-E) 2.0 SWB SR, DLX, S, Pet. 5-Spd. Man. (98-05), (YN51) (2Y) 1.8 SWB S, SR, Raider P/up Pet., 5-Spd. Man. (86-98), (YN56) (2Y) 1.8 LWB P/up 4/5-Spd. Man. Pet. (86-98), (YN58) (4Y) 2.2 LWB Raider, SRX P/up Pet. (84-98), (YN140) (2Y) 1.8 SWB, LWB D/cab, Raider Pet. 5-Spd. Man. (98-05), Land Cruiser (FJ62) 4X4 (3F) 4.0, GX P/up Pet. 5-Spd. Man., 4-Spd. Auto., (2F) 4.2 P/up, GX Pet. 5-Spd. Man., 4-Spd. Auto. (87-90), (HJ60) 4X4 (2H) 4.0, GX P/up Dies., (12H) 4.0 4-Spd. Man. Turbo Dies. 4-Spd. Man., Auto. (87-90), (HJ62) 4X4 (2H) 4.0, GX P/up Dies., (12H) 4.0 4-Spd. Man. Turbo Dies. 4-Spd. Man., Auto. (87-90), (HJ75) 4X4 (3F) 4.0 DLX P/up Petrol 5-Spd. Man. (85-92), (PHJ75) 4X4 4.0 DLX 236 Perkins Dies. 4-Spd. Man. (85-91)</p>
	<p>AR351 Engine Mounting - L/RHS</p> <p>Leyland Mini - All Models (59-84)</p>

ENGINE MOUNTING & RUBBER BUYERS GUIDE





 <p>ID: 10.5, OD: 25, L: 22</p>	<p>AR39 Shock Rubber - Rear</p> <p>Ford Courier (F6) 1.6 SWB P/up Pet., (F8) 1.8 SWB, LWB P/up Ch. Cab, Std., XLT Pet., (FE) 2.0 XLT LWB P/up Pet., 2.2 D/cab, Explorer, Std., XLT, Leisure SWB, LWB P/up (F2) Pet., (R2) Dies., (WL4) 2.5D TD, Leisure LWB P/up Dies., 3.0 V6 D/cab, Std., L, Leisure, Explorer SWB, LWB P/up, Essex Pet., 3.4 V6 Leisure, D/cab SWB, LWB P/up Pet. (86-00), Courier 4X4 (WL4) 2.5D TD V6 D/cab, Leisure LWB P/up Dies., 3.0 V6 Std., XLT, D/cab, Leisure, Explorer, Exec. LWB P/up Essex Pet., 3.4 V6 Leisure D/cab LWB P/up Pet. (90-00), Ranger 4X4 2.5D, TD V6 XL D/cab, XLT, SubCab, XLT Hi Trail, Super Cab XLT LWB P/up Dies., 4.0 V6 D/cab XLE, SubCab XLT Hi Trail, Super Cab XLT LWB P/up Pet. (00-10), 2.5D TD XL D/cab, XLT, SubCab, XLT Hi Trail, Super Cab XLT LWB P/up Dies., 3.0 TDCi D/cab XLE, SubCab XLT, Hi Trail, Super Cab XLT LWB P/up Dies. (07-12), Spectron (F2) 2.2 LWB Bus, P/van Pet. (91-04); Mazda B-Series B2600 (4G54) LWB D/cab, Magnum, Drifter, P/up Pet., B2600i LWB D/cab, Drifter SLX P/up Pet. (86-02), B3000 V6 LWB D/cab, Magnum, Drifter P/up Essex Pet., B3400 V6 LWB D/cab, Magnum P/up Pet. (86-99), B-Series 4X4 B2600 (4G54) V6 LWB D/cab Magnum, Drifter P/up Pet. (86-95), B3000 V6 LWB D/cab, Magnum, Drifter P/up Essex Pet., B3400 V6 LWB D/cab Magnum P/up Pet. (86-99), B2500D (WL4) TD LWB, D/cab, Magnum, Drifter SLX P/up Dies., B2600i V6 LWB Drifter, D/cab Drifter, SLX P/up Pet. (96-07), Drifter 4X4 (WL4) 2.5TD LWB S/cab, D/cab, SL S/cab, SLE, SLE D/cab, SLX S/cab, SLX, D/cab P/up Dies., 2.6i V6 LWB S/cab, SL S/cab, SLE, D/cab, SLX D/cab P/up Pet. (00-08), Etude 160i, iE, iSE, iSE Sport, 180iSE, iSX, iSX Sport (99-04), Marathon (F2) 2.2 LWB Bus, P/van Pet. (91-04)</p>
	<p>AR49 Distributor Cap Rubber</p> <p>Various Makes & Models</p>

ENGINE MOUNTING & RUBBER BUYERS GUIDE

	<p>AR5001 Bonnet Clip Various Makes & Models</p>		<p>AR5055 Exhaust Hanger - Front Renault R5 1.3, 1.4 (68-85)</p>
	<p>AR5019 Exhaust Hanger - Middle, Rear Volkswagen Fox 1.3 L, L Trippa 4-Spd. Man., 1.6 L 4/5-Spd. Man., 3-Spd. Auto., 1.8 L Sport 5-Spd. Man. (87-96)</p>	<p>THREAD: M6 x 1.0</p> 	<p>AR5060 Shackle Bush - Rear Upper Mazda B-Series B1600, B1800 (75-79)</p>
	<p>AR5020 Exhaust Hanger - Front, Middle, Rear Volkswagen Caddy (HM, HV, JK) 1.6, i P/up Dies., Pet. 4-Spd. Man., (HV) 1.8 L Sport, Sport, P/up (81-03), Citi Golf 1.3 L, Chico, L Shuttle 4-Spd. Man., Chico Lux, (HM) 1.6 L, Chico Lux, Deco, Designa, Blues, Ritz, Shuttle, Sonic, Sport Chico 4/5-Spd. Man., 3-Spd. Auto., (BZF) 1.8 CTi, Designa, L Sport, 5-Spd. Man. (83-02), 1.4 L, Chico, (AGY, BSY) 1.4i, L, Citi.com, VeloCiti, TenaCiti, CitiStorm, Sport, Rox, Rhythm Man., (AFX) 1.6i Life, Velociti, TenaCiti, CitiStorm, Sport, Rox 5-Spd. Man. (99-09), Fox 1.3 L, L Trippa 4-Spd. Man., 1.6 L 4/5-Spd. Man., 3-Spd. Auto., 1.8 L Sport 5-Spd. Man. (87-96), Golf II 1.3 CL 4-Spd. Man., 1.6 CSL 5-Spd. Man., 1.8 GTS 16V, CSX, GTi 8V, 16V, 5-Spd. Man., 3-Spd. Auto., 2.0 GTi 8V, Exec. 16V 5-Spd. Man. (84-92), Jetta II 1.6 CSL 5-Spd. Man., 1.8 CLi, CLi Exec., Executive, CLX, CSX 5-Spd. Man., 3-Spd. Auto., 2.0 L 16V 5-Spd. Man. (85-92)</p>	<p>ID: 17.25, OD: 32, L: 38.5</p> 	<p>AR5061 Exhaust Hanger - Middle, Rear Ford Laser (B3, E3) 1.3 Dash, GL, L, Tracer H/B, Sedan, Tonic (86-95), (CHV-FUA) 1.4 L, (E5) 1.5 GL, GLS, Sport (86-92), (B6, F6, CVH) 1.6 i, 16, GL, Sport, Tracer H/B, Sedan, Plus, TX3 (86-91), (FE) 2.0i RS (91-94), Meteor (B3, E3) 1.3 GL, L (86-95), (CVH) 1.4 LX, (E5) 1.5 GL, GLS (86-92), (B6, F6, CVH) 1.6 16, GL, GLE, GLi, Sport (86-91), (FE) 2.0 GLE, GLi (91-94), Tracer (B3, E3) 1.3 H/B, Sedan, Tonic, Plus (95-02); Mazda 323 FWD (E3) 1.3 S, L H/back, Sedan, (E/B3) 130 Hatch, Midge, Sting, Sedan, (E5) 1.5 GLC, L, SL, SLX, Sport Sedan, Hatchback (83-95), (B3) 130 Hatch, Sedan (85-91), 626 (F6) 1.6 L Hatch, Sedan, S Sedan, SL Hatch Man., (F8) 1.8 L Hatch, Sedan Man., (FE) 2.0 SL Hatch, EG, Sedan, SLi 16 Valve, SLE, 12 Valve, SLX Sedan, Hatch (86-93)</p>
	<p>AR5027 Rear Stabilizer Bar Bush BMW Mini Cooper (R55) (N12B16A, N16B16A) 1.6 Clubman, (R56) (N12B16A, N16B16A) 1.6 Hatch, (R57) (N12B16A, N16B16A) 1.6 Convertible, (R58) (N16B16A) 1.6 Coupe, (R59) (N16B16A) 1.6 Roadster, (R60) (N16B16A) 1.6 Countryman, (R61) (N16B16A) 1.6 Paceman (2007-), Mini Cooper S (R55) (N14B16A, N18B16A) 1.6 Clubman, (R56) (N14B16A, N18B16A) 1.6 Hatch, (R57) (N14B16A, N18B16A) 1.6 Convertible, (R58) (N18B16A) 1.6 Coupe, (R59) (N18B16A) 1.6 Roadster, (R60) (N18B16A) 1.6 Countryman, (R61) (N18B16A) 1.6 Paceman (2007-), Cooper S 4X4 (R60) (N18B16A) 1.6 Countryman, (R61) (N18B16A) 1.6 Paceman (2010-), Cooper John (R55) (N14B16C) 1.6 Clubman, (R56) (N14B16C, N18B16C) 1.6 Hatch, (R57) (N14B16C, N18B16C) 1.6 Convertible, (R58) (N14B16C, N18B16C) 1.6 Coupe, (R59) (N14B16C, N18B16C) 1.6 Roadster (2007-), Countryman JCW (R56) (N18B16C) 1.6 Hatch, (R60) (N18B16A) 1.6 Countryman (2007-), One (R56) (N16B16A) 1.6 Hatch, (R57) (N16B16A) 1.6 Convertible (2007-)</p>	<p>ID: 16, OD: 25, L: 40</p> 	<p>AR5063 Shackle Bush - Rear Toyota Land Cruiser 3.6, 3.9, 4.2 P/up (69-80)</p>
	<p>AR5028 Spark Plug Cap Volkswagen Kombi (T2, T3) 1.8 Microbus, P/van, Volksiebus, 1.9 Microbus, P/van, 2.0 Microbus, P/van, L Exec. Bus, Kamper, P/up, 2.1 Fi Caravelle, Microbus, 2.3 Microbus, Volksiebus, 2.5i Caravelle, Microbus, 2.6i Caravelle, Microbus (74-04)</p>		<p>AR5064 Shackle Bush - Rear Upper, Lower Toyota Land Cruiser 3.6, 3.9, 4.2 P/up (69-80)</p>
	<p>AR5051 Exhaust Hanger - Middle, Rear Nissan 1400 (A14S) 1.4 SWB P/van, P/up Pet., B140 (A14S) 1.4 SWB Deluxe, Sport, Std., CHAMP P/up Pet. (80-08)</p>	<p>ID: 18, OD: 30.6, L: 40</p>	
	<p>AR5053 Transmission Mounting BMW Mini Cooper (R55) (N16B16A) 1.6 Clubman, (R56) (N16B16A) 1.6 Hatch, (R57) (N16B16A) 1.6 Convertible, (R58) (N16B16A) 1.6 Coupe, (R59) (N16B16A) 1.6 Roadster, (R60) (N16B16A) 1.6 Countryman, (R61) (N16B16A) 1.6 Paceman (2007-), Cooper S (R55) (N14B16A, N18B16A) 1.6 Clubman, (R56) (N14B16A, N18B16A) 1.6 Hatch, (R57) (N14B16A, N18B16A) 1.6 Convertible, (R58) (N18B16A) 1.6 Coupe, (R59) (N18B16A) 1.6 Roadster, (R60) (N18B16A) 1.6 Countryman, (R61) (N18B16A) 1.6 Paceman (2007-), Cooper S 4X4 (R60) (N18B16A) 1.6 Countryman, (R61) (N18B16A) 1.6 Paceman (2010-), Cooper John (R55) (N14B16C) 1.6 Clubman, (R56) (N14B16C, N18B16C) 1.6 Hatch, (R57) (N14B16C, N18B16C) 1.6 Convertible, (R58) (N14B16C, N18B16C) 1.6 Coupe, (R59) (N14B16C, N18B16C) 1.6 Roadster (2007-), Countryman JCW (R56) (N18B16C) 1.6 Hatch, (R60) (N18B16A) 1.6 Countryman (2007-), Mini One (R56) (N16B16A) 1.6 Hatch, (R57) (N16B16A) 1.6 Convertible (2007-) - Man. Models</p>		

ENGINE MOUNTING & RUBBER BUYERS GUIDE

	<p>AR5065 Shackle Bush - Front, Rear Upper & Lower</p> <p>GoNow X-Space 2.2i DC, DCext., 2.8 TDX DC (07-10), X-Space 4X4 2.2 iL DC, XL DCext., 2.8 TDX DCext. (07-10); GWM Steed 2.2i D/cab Lux, Multi-Wagon (07-11); Isuzu KBD-Series KBD20/21 (C190) 2.0 SWB P/up Dies., KBD22 (C223) 2.2 LE SWB P/up Dies., KBD23 (4JA1) 2.5 LE SWB P/up Dies., KBD25/26 (C190) 2.0 LWB P/up Dies., KBD27 (C223) 2.2 LWB P/up Dies., KBD28 (4JA1) 2.5 LWB P/up Dies. (78-89), KB-Series KB21 (G180Z) 1.6 SWB, Fleetside, P/up Pet. (G161Z) 1.8 SWB, P/up Pet., KB22 (180Z) 1.8 SWB P/up Pet., KB23 (200Z) 2.0 SWB P/up Pet., KB24 (4ZD1) 2.3 LE SWB P/up Pet., KB26 (G161Z) 1.6 LWB P/up Pet., (G180Z) 1.8 LWB P/up Pet., KB27 (G180Z) 1.8 LWB P/up Pet., KB29 (4ZD1) 2.3 LWB P/up Pet. (81-89), KB-Series 4X4 KB40 (G161Z) SWB P/up Pet., KB41 (G161Z), SWB P/up Pet. (G180Z) SWB P/up Pet., KB42 (G180Z) SWB P/up, KB43 (G200Z) SWB P/up Pet., KB44 (4ZD1) LE SWB P/up Pet. (79-89), KBD-Series 4X4 KBD40 (C190) SWB P/up Dies., KBD41 (C190) Dies., KBD42 (C223) Dies. (79-89), KB-Series KB160 (4ZA1) 1.6 SWB, Fleetside P/up Pet., KB200 (ZC1) 2.0 SWB, LWB, D/cab, LE, Fleetside, P/up Pet., KB220 (C22NE) 2.2 LWB D/cab, LE P/up Pet., KB230 (4ZD1) 2.3 SWB, LWB, D/cab P/up Pet., KB250D (4JA1) 2.5 SWB, LWB D/cab, LE, Fleetside, P/up Dies., KB280DT (4JB1) 2.8 SWB, LWB LE, D/cab LE, Frontier LX P/up (89-04), KB-Series 4X4 KB220 (C22NE) LWB D/cab, LE, P/up Pet., KB230 (4ZD1) SWB P/up Pet., KB250D (4JA1) SWB, LWB, D/cab, LE, LE D/cab P/up Dies., KB260 (4ZE1) LWB D/cab, LE, LX D/cab P/up, KB280DT (4JB1) SWB, LWB LE, LE D/cab, LX, LX D/cab, P/up (89-04), KB-Series KB260 (4ZE1) 2.6 SWB, LWB LE, LX, D/cab P/up Pet., KB320 (6VD1) 3.2 V6 SWB, LWB LE, LX, D/cab, Frontier, Reef, Blazer P/up Pet. (92-04), KB-Series 4X4 KB320 (6VD1) V6 SWB, LWB Frontier LX, LX, LX D/cab P/up Pet. (98-04), KB-Series KB220 Fleetside P/up, KB240i LE, D/C LE, Fleetside P/up, KB250D, DC LE, D/C LE, Fleetside P/up, D-TEQ, KB300 TDC TDi LX, D/C LX, Fleetside P/up, Hi-Rider, D-MAX (04-13), KB-Series D-TEQ 4X4 KB240i LE, D/C LE, Fleetside P/up, KB250D LE, D/C LE, Fleetside P/up, KB300TDi LX, D/C LX, Fleetside, "GO Big" P/up Hi-Rider (04-12); Toyota Condor (2Y) 1.8 Estate, TE Estate MPV Pet., 2.0i Estate, TE, Estate MPV, (2RZ-E) 2.4i Estate, TE, TX Estate MPV Pet. (00-05), Condor 4X2, 4X4 (2RZ-E) 2.4i Estate, TX Estate MPV Pet., 5-Spd. Man., (5L) 3.0 SWB Estate, TX Estate MPV Dies., (5L) 3.0 Estate, TE Estate MPV Dies. 5-Spd. Man. (00-05), Hilux (LN50) (L) 2.2 SWB P/up Dies. 4-Spd. Man. (84-98), (LN51) (2L) 2.4 SWB S D/cab, Raider P/up Dies. (84-98), (LN55) (L) 2.2 LWB P/up Dies. (84-98), (LN56) (2L) 2.4 LWB Raider, D/cab P/up Dies. (84-98), (LN57) (3L) 2.8 LWB Raider D/cab, P/up Dies. (95-05), (LN65) (2L) 2.4 LWB D/cab, Raider, D/cab Dies. (89-98), (LN67) (3L) 2.8 LWB P/up, Raider, D/cab Dies. (95-05), (LN140) (2L) 2.4 SWB DLX P/up Dies. (98-05), (LN145) 2.4 LWB P/up Dies. (98-05), (LN192) (5L) 3.0D LWB D-E DLX, Raider D/cab Raised Body Dies., (KZ-TE) 3.0iD LWB D/cab Raider, Legend35 Raider, D/cab, Raider Dies. (98-05), (RN67) (22R) 2.4 LWB Raider, D/cab, Raider D/cab Pet. (89-98), (RZN147) (1RZ-E) 2.0 LWB SR D/cab Pet. 5-Spd. Man., (1RZ-E) 2.0 SWB SR, DLX, S, Pet. 5-Spd. Man. (98-05), (RZN169) (3RZ-FE) 2.7i LWB P/up, Raider, Raider D/C, SRX D/C, DLX S/C, Legend35, Legend35 D/C Pet. (98-05), (RZN194) (3RZ-FE) 2.7i LWB Legend35, Raider, Raider D/cab, Raised Body Pet. 5-Spd. Man. (98-05), (YN51) (2Y) 1.8 SWB S, SR, Raider P/up Pet., 5-Spd. Man. (86-98), (YN56) (2Y) 1.8 LWB P/up 4/5-Spd. Man. Pet. (86-98), (YN58) (4Y) 2.2 LWB Raider, SRX P/up Pet. (84-98), (YN67) (4Y) 2.2 LWB Raider D/cab, D/cab P/up Pet. (85-94), (YN140) (2Y) 1.8 SWB, LWB D/cab, Raider Pet, 5-Spd. Man. (98-05), Stallion (KF50) (5K) 1.5 Commuter, P/up, SR5 P/up, Bus, P/van Pet., 4/5-Spd. Man. (87-91), (YF50) (2Y) 1.8 P/up, (2Y) 1.8 SR5 P/up, P/van, Pet., (LF50) (2L) 2400D P/up Dies. (91-04), Venture (YF50) (2Y) 1.8 P/van, 8/10-Seater Pet., 4/5-Spd. Man., (YF51) (4Y) 2.2 10-Seater, Getaway 5-Seater, GLE 9-Seater Pet. 5-Spd. Man., (LF50) (2L) 2.4 10-Seater Dies. 5-Spd. Man. (91-04)</p>
 <p>ID: 17.5, OD: 29.5, L: 36.5</p>	<p>AR5067 Shackle Bush - Front, Rear Lower</p> <p>Ford Cortina MKIII 1.6 L SWB P/up Kent Pet., 2.0 V4 SWB P/up Köln Pet., 2.5 V6 L SWB P/up Essex Pet., (EV30) 3.0 GT, L, XL, XLE "Big Six" Essex (71-77)</p>

	<p>AR5069 Exhaust Hanger - Front, Middle, Rear</p> <p>BMW 5-Series (E39) 530d (M57) 3.0 Dies. (96-04); Mazda 3 (BK, BL) (B6ZE, Z6) 1.6 Original, Active, Dynamic, (LF17) 2.0 Dynamic, Individual, (L3KG) 2.3 Individual MPS, (L5-VE) 2.5 (04-14), 323 FWD (E3) 1.3 S, L H/back, Sedan, (E/B3) 130 Hatch, Midge, Sting, Sedan, (E5) 1.5 GLC, L, SL, SLX, Sport Sedan, Hatchback (81-95); Toyota Corolla (TE72) (3T) 1.8 RWD GLS, SE OHV 5-Spd. Man., 3/4-Spd. Auto. (80-85), Cressida (GX71) (1G-E) 2.0 GLi6 5-Spd. Man., Executive DOHC, (1G-FE) I.R.S. 4-Spd. Auto. (86-92), (MX73) (5M-GE) 2.8i RSi, RSi Exec. DOHC 5-Spd. Man., 4-Spd. Auto., (MX75) 3.0 GLS 5-Spd. Man., (ECT) (7M-GE) 3.0i I.R.S. 24V DOHC 4-Spd. Auto. (86-92), (RX70) (21R) 2.0 GL, GLX, GL S/W, (RX72) (22R) 2.4 GLE, GL S/W, GLE S/W, (RX73) (22R) I.R.S. GL, GLE 4/5-Spd. Man./Auto. (87-92), (YX72) (3Y) 2.0 GS, GS Exec., GSE OHV 5-Spd. Man. (89-92)</p>
 <p>ID: 20, OD: 32.5, L: 36.5</p>	<p>AR5080 Shackle Bush - Front Upper</p> <p>Various Makes & Models</p>
 <p>ID: 8, OD: 22, L: 13</p>	<p>AR5081 Stabilizer Link Grommet</p> <p>Ford Laser (B3, E3) 1.3 Dash, GL, L, Tracer H/B, Sedan, Tonic (86-95), (CHV-FUA) 1.4 L, (E5) 1.5 GL, GLS, Sport (86-92), (B6, F6, CVH) 1.6 i, 16, GL, Sport, Tracer H/B, Sedan, Plus, TX3 (86-91), (FE) 2.0i RS (91-94), Meteor (B3, E3) 1.3 GL, L (86-95), (CVH) 1.4 LX, (E5) 1.5 GL, GLS (86-92), (B6, F6, CVH) 1.6 16, GL, GLE, GLi, Sport (86-91), (FE) 2.0 GLE, GLi (91-94), Tracer (B3, E3) 1.3 H/B, Sedan, Tonic, Plus (95-02), Sierra 1.6 GL, L, SW Kent, 2.0 GL, GL S/W, GLE, GLEA, GLi, LX Sedan, SW Köln (83-93); Honda Ballade (SH4) (D15B3) 150 16V SOHC, (D16A9) 160i 16V SOHC, DOHC (89-92); Mazda 323 FWD (E3) 1.3 S, L H/back, Sedan, (E/B3) 130 Hatch, Midge, Sting, Sedan, (E5) 1.5 GLC, L, SL, SLX, Sport Sedan, Hatchback (81-95), (B3) 130 Hatch, Sedan (85-05), Midage / Sting (F6) 160 i, s, Hatch, Sedan, (B6) 1.6 Egi, S, SL Hatch, Sedan, Sport, (F6) 160, i, s, Hatch, Midge, Sting, Sedan, 2.0 Egi Hatch, SLE Hatch, SLi, Sedan, (FE-2000) 200e, i Sedan, Hatch DOHC 8/16 Valve (85-05), 626 (F6) 1.6 L Hatch, Sedan, S Sedan, SL Hatch Man., (F8) 1.8 L Hatch, Sedan Man., (FE) 2.0 SL Hatch, Egi, Sedan, SLi 16 Valve, SLE, 12 Valve, SLX Sedan, Hatch (83-93), Marathon (F2) 2.2 LWB Bus, P/van Pet. (91-04), Rustler (B3) 130 SWB Drifter, Explorer P/up Pet., (B6i, F6) 160, i SWB Explorer, Drifter P/up Pet. (94-02); Nissan 1400 (A14S) 1.4 SWB P/van, P/up Pet., B140 (A14S) 1.4 SWB Deluxe, Sport, Std., CHAMP P/up Pet. (80-08); Toyota Conquest (EE80) (2E-L) 1.3 L, GL 12V 4-Spd. Man. (85-88), (EE90) (2E-L) 1.3 S, GS 12V 4-Spd. Man., (2E) 130 Zipp, Sport, Tazz, Sport 4-Spd., Tropicque, Ruby, Edition, Mc Tazz, XE 12V 5-Spd. Man., (2E) 130 Carri P/van OHC 5-Spd. Man. (88-06), (AE92) (4A-GE) 1.6 RSi Twincam 5-Spd. Man. (88-93), (4A-F) 1.6 LS 3-Spd. Auto., (4A-F) 1.6 RSi. Sport DOHC 5-Spd. Man. (88-93), (4A-FE) 160 i RS DOHC 4-Spd. Auto. (93-94), Corolla (AE80) (2A-L) 1.3 FWD GL 8V 4-Spd. Man. (84-88), (AE82) (4A-GE) 1.6 L (84-88), (EE80) (2E-L) 1.3 FWD L, GL OHC 4-Spd. Man. (84-88), (AE92) (4A-F) 1.6 GL, GLS, Exec., Sprinter, GLE, Sport., (4A-GE) 1.6 DOHC, GLi, GLi Exec., (4A-F) 1.6 DOHC, 5-Spd. Man., 3-Spd. Auto., GL, GLX DOHC 4-Spd. Auto. (88-93), (4A-FE) 160i GL, GLE, Sprinter, DOHC 5-Spd. Man., 4-Spd. Auto. (92-96), (EE90) (2E, 2E-L) 1.3 FWD L, GL, GLE, Sprinter OHC 4/5-Spd. Man. (88-96), Land Cruiser (FZJ100) 4X4 4.2 VX TD P/up, S/W, GX DSL P/up AHC Diesel 5-Spd. Auto. (02-04), (FZJ105) 4X4 4.5 GX S/W Dies. 5-Spd. Man., 4-Spd. Auto., 4.7 VX S/W V8 Petrol (03-08), (UZJ100) 4X4 (1HD-FTE) 4.2 VX TD S/W, GX DSL S/W, P/up S/W AHC Dies. 4/5-Spd. Auto. (04-08), (UZJ105) 4X4 4.5 GX S/W Dies. 5-Spd. Man., 4-Spd. Auto., 4.7 VX S/W V8 Petrol (03-08), Prado 90/95 4X4 (1KZ-TE) 3.0 GX, VX S/W Dies. 5-Spd. Man., Auto., 3.4 GX, VX S/W Man., Auto., Pet. (96-02), Prado 120 4X4 (1KZ-TE) 3.0TD, VX S/W Dies., 5-Spd. Man., 4-Spd. Auto., (1GR-FE) 4.0 GX, VX S/W 4-Spd. Auto. Pet. (02-09), 100-Series 4X4 4.0 GX DSL S/W, VX S/W Pet. 5-Spd. Man., Auto. (98-06)</p>
 <p>ID: 16, OD: 37, L: 23</p>	<p>AR5088 Tension Rod Bush</p> <p>Nissan 1200, 1400 (71-80)</p>

ENGINE MOUNTING & RUBBER BUYERS GUIDE

211

 <p>ID: 17.5, OD: 52, L: 29</p>	<p>AR5089 Tension Rod Bush Nissan 1600, 160U, 160Y, 160Z (69-78), 1800, 1800J, 180U (69-80), Pulsar 1.3 (69-86)</p>
 <p>OD: 92.5, L: 56</p>	<p>AR5089A Centre Bearing Rubber - Rubber Only Ford Cortina MKIII 1.6 L SWB P/up Kent Pet., 2.0 V4 SWB P/up Koln Pet., 2.5 V6 L SWB P/up Essex Pet., (EV30) 3.0 GT, L, XL, XLE "Big Six" Essex (71-77), Cortina MKIV 1.3 L Kent, 1.6 1-Tonner SWB P/up Kent Pet., 2.0 GL, GLE Koln, 3.0 V6 1-Tonner SWB P/up Essex Pet. (77-86), Cortina MKV 1.6 1-Tonner SWB P/up Kent Pet., 2.4D 1-Tonner SWB P/up York Pet., 3.0 V6 1-Tonner SWB, LWB P/up Essex Pet. (77-86), Escort MKI / II 1.1 300 SWB P/van Kent Pet., 1.3 30/35/45 SWB P/van Kent Pet., 1.6 45 P/van SWB P/van Kent Pet. (68-81)</p>
	<p>AR5089AB Centre Bearing Rubber - Complete Ford Cortina MKIII 1.6 L SWB P/up Kent Pet., 2.0 V4 SWB P/up Koln Pet., 2.5 V6 L SWB P/up Essex Pet., (EV30) 3.0 GT, L, XL, XLE "Big Six" Essex (71-77), Cortina MKIV 1.3 L Kent, 1.6 1-Tonner SWB P/up Kent Pet., 2.0 GL, GLE Koln, 3.0 V6 1-Tonner SWB P/up Essex Pet. (77-86), Cortina MKV 1.6 1-Tonner SWB P/up Kent Pet., 2.4D 1-Tonner SWB P/up York Pet., 3.0 V6 1-Tonner SWB, LWB P/up Essex Pet. (77-86), Escort MKI / II 1.1 300 SWB P/van Kent Pet., 1.3 30/35/45 SWB P/van Kent Pet., 1.6 45 P/van SWB P/van Kent Pet. (68-81)</p>

	<p>AR5092 Shock Rubber - Front & Rear, Stabilizer Link Grommet Ford Courier (F6) 1.6 SWB P/up Pet., (F8) 1.8 SWB, LWB P/up Ch. Cab, Std., XLT Pet., (FE) 2.0 XLT LWB P/up Pet., 2.2 D/cab, Explorer, Std., XLT, Leisure SWB, LWB P/up (F2) Pet., (R2) Dies., (WL4) 2.5D TD, Leisure LWB P/up Dies., 3.0 V6 D/cab, Std., L, Leisure, Explorer SWB, LWB P/up, Essex Pet., 3.4 V6 Leisure, D/cab SWB, LWB P/up Pet. (86-00), Courier 4X4 (WL4) 2.5D TD V6 D/cab, Leisure LWB P/up Dies., 3.0 V6 Std., XLT, D/cab, Leisure, Explorer, Exec. LWB P/up Essex Pet., 3.4 V6 Leisure D/cab LWB P/up Pet. (90-00), Husky (4G62) 1.8 1-Ton SWB P/up, P/van, Bus Pet., (4G63) 2.0 1-Ton SWB P/up, P/van, Bus Pet. (85-99); Hyundai Bakkie (4D56) 2.5i DT LWB P/up, P/van Dies., (4G54) 2.6i LWB P/van, P/up, Dropside Pet. (97-09), H100 (4D56) 2.5i DT LWB P/up, Dropside Dies., (4G54) 2.6i LWB P/van, Dropside Pet. (98-04); Isuzu Relay (4ZB1) 1.8 LWB Bus, P/van Pet., (4ZC1) 2.0 SWB Bus, P/van Pet. (83-95), WFR 11/12 FXV (83-95); Mazda B-Series B1600 (F6) SWB Magnum P/up Pet., B1800 (F8) S/LWB Magnum, Drifter P/up Pet., B2000 (FE) LWB Magnum, Drifter P/up Pet., B2200 SWB, LWB D/cab, Magnum, Drifter P/up (F2) Pet., (R2) Dies., B2500D (WL4), TD LWB Drifter, SLX P/up Dies. (82-00), B2600 (4G54) LWB D/cab, Magnum, Drifter, P/up Pet. (86-02), B3000 V6 LWB D/cab, Magnum, Drifter P/up Essex Pet., B3400 V6 LWB D/cab, Magnum P/up Pet. (86-99), B-Series 4X4 B2600 (4G54) V6 LWB D/cab Magnum, Drifter P/up Pet. (86-95), B2500D (WL4) TD LWB, D/cab, Magnum, Drifter SLX P/up Dies., B2600i V6 LWB Drifter, D/cab Drifter, SLX P/up Pet. (96-07); Mitsubishi Colt LDV 4X4 (4D56) 2.5D LWB Hi-Line K34 P/up Dies., (6G72) 3.0 V6 LWB Lo-Line, D/cab, Hi-Line Rodeo K36 Pet. (94-98), Pajero 4X4 (4G54) 2.6 SWB, LWB GLS, SJ25/26/45 SUV Pet. (83-94); Nissan 1-Tonner Hardbody (AW/D22) (NA16S, L16SJ) 1.6 SWB P/up Pet., (L18SR) 1.8 SWB, LWB Custom, King Cab P/up Pet., (NA20) 2.0 SWB, LWB Custom P/up Pet., (Z24) 2.4 LWB Custom, Hi Rider, Twincab, SE, SE D/cab Pet. (88-98), 1-Tonner Hardbody (AW/D22) (TD25i) 2.5D SWB, LWB, Custom, D/cab, Hi Rider, Twin Cab P/up Dies., (TD27i) 2.7D SWB, LWB, Custom, D/cab, Hi Rider, Twincab, SE D/cab P/up Dies., (VG30E) 3.0 V6 LWB SE D/cab, Hi Rider P/up Pet. (88-98), 1-Tonner Hardbody (AW/D22) 4X4 (Z24S) 2.4 LWB Custom, Patrol, Tracker P/up Pet., (TD27i) 2.7D SWB, LWB Hi Rider, Twin Cab, SE, SE D/cab P/up Dies., (VG30E) 3.0 V6 LWB D/cab, Twin Cab, Patrol P/up Pet. (88-99), 620 (J15) 1.5 SWB, LWB P/up Pet. (73-80), 680 (J15) 1.5 SWB P/up Pet., (SD22) 2.2 LWB P/up Dies. (73-80), E20 (J16) 1.6 SWB Bus, Coach, P/van Pet., (L18) 1.8 SWB, LWB 10, 16-Seater Bus, Coach, Coach, GL, GLE, Econolux, Ekonovan, Ekonowagon Pet. (73-96), Hardbody (QW/244) (NA20S) 2.0 SWB, LWB SL P/up Pet., (KA20) 2.0i SWB, LWB S/cab, SL, S/cab P/up Pet., (KA24) 2.4i LWB S/cab, SL S/cab, D/cab, SL D/cab, Hi Rider S/cab, D/cab P/up Pet., (TD27i) 2.7 SE, D/C, TD LWB, S/cab, D/cab, SE P/up Dies. (98-11), Hardbody (D22, QW/244) (VG30E) 3.0i V6 LWB SL P/up Pet., (ZD30) 3.0D, TD LWB Hi Rider, KingCab, Hi Rider P/up Dies., (QD32) 3.2D LWB SE, SL, SLE, D/cab P/up Dies., (VG33E) 3.3 V6 LWB Hi Rider, S/cab, D/cab, KingCab P/up Pet. (98-10), Hardbody (D22, QW/244) 4X4 (KA24E) 2.4i, LWB S/cab, SL D/cab, P/up Pet., (TD27i) 2.7D, LWB S/cab, SE, D/cab, P/up Dies., (ZD30) 3.0 V6 LWB D/cab, SE, SE D/cab, SL P/up Pet. (98-10), (ZD30) 3.0TD LWB D/cab, KingCab P/up Dies., (QD32) 3.2D LWB SL S/cab, SE D/cab P/up Dies., (VG33E) 3.3i V6 LWB D/cab, Hi Rider D/cab P/up Pet. (99-10), Hardbody NP300 (D22) (KA20DE) 2.0i SWB, LWB S, SE P/up Pet., (KA24DE) 2.4i LWB D/cab, D/cab Hi Rider P/up Pet., (YD25DDTi) 2.5 Tdi LWB S, SE, D/C, D/C Hi Rider, P/up Dies. (2008-), Hardbody NP300 (D22) 4X4 (KA24DE) 2.4i LWB S/C, D/C Hi Rider P/up Pet., (YD25DDTi) 2.5 Tdi LWB S, SE, D/C, D/C Hi Rider P/up Dies. (2008-), Patrol (Y60) 4X4 (VG30E) 3.0 V6 LWB Twin Cab S/W Pet. (90-94), (Y61) 4X4 (VG30E) 3.0 V6 LWB Y60 S/W Pet., 3.0Di 6-Cyl. LWB GRX, TDi GL S/W Dies., (TD42) 4.2 6-Cyl. LWB LDF P/up, S/W Dies., 4.5 6-Cyl. LWB P/up Dies., 4.8 6-Cyl. LWB GL, GRX P/up Dies. (95-04), Sani 4X4 (Z22) 2.2 LWB S/W Pet., (Z24) 2.4 LWB Patrol S/W Pet. (86-94), Terrano II 4X4 (TD27) 2.7 Dies. (00-02)</p>
 <p>ID: 10, OD: 30, L: 15.5</p>	

ENGINE MOUNTING & RUBBER BUYERS GUIDE

 <p>ID: 10, OD: 30, L: 15.5</p>	<p>AR5092 - Continued</p> <p>Toyota Condor (2Y) 1.8 Estate, TE Estate MPV Pet., 2.0i Estate, TE, Estate MPV, (2RZ-E) 2.4i Estate, TE, TX Estate MPV Pet. (00-05), Condor 4X2, 4X4 (2RZ-E) 2.4i Estate, TX Estate MPV Pet., 5-Spd. Man., (5L) 3.0 SWB Estate, TX Estate MPV Dies., (5L) 3.0 Estate, TE Estate MPV Dies. 5-Spd. Man. (00-05), Corolla (TE72) (3T) 1.8 RWD GLS, SE OHV 5-Spd. Man., 3/4-Spd. Auto. (80-85), Cressida (GX71) (1G-E) 2.0 GLi6 5-Spd. Man., Executive DOHC, (1G-FE) I.R.S. 4-Spd. Auto. (86-92), (MX73) (5M-GE) 2.8i RSi, RSi Exec. DOHC 5-Spd. Man., 4-Spd. Auto., (MX75) 3.0 GLS 5-Spd. Man., (ECT) (7M-GE) 3.0i I.R.S. 24V DOHC 4-Spd. Auto. (86-92), (RX70) (21R) 2.0 GL, GLX, GL S/W, (RX72) (22R) 2.4 GLE, GL S/W, GLE S/W, (RX73) (22R) I.R.S. GL, GLE 4/5-Spd. Man./Auto. (87-92), HiAce (YH50) (2Y) 1.8 SWB P/van 4-Spd. Man. Pet., (YH60) (2Y) 1.8 LWB LS Wagon, P/van 5-Spd. Man. Pet. (83-91), (YH53) (4Y) 2.2 SWB LS, GLX, GLX Exec. Wagon, Super10, (YH63) (4Y) 2.2 LWB Super16, SuperT, P/van, Siyaya Pet. 5-Spd. Man., 4-Spd. Auto. (86-09), Hilux (LN67) (3L) 2.8 LWB P/up, Raider, D/cab Dies. (95-05), (LN192) (5L) 3.0D LWB D-E DLX, Raider D/cab Raised Body Dies., (KZ-TE) 3.0iD LWB D/cab Raider, Legend35 Raider, D/cab, Raider Dies. (98-05), (RZN169) (3RZ-FE) 2.7i LWB P/up, Raider, Raider D/C, SRX D/C, DLX S/C, Legend35, Legend35 D/C Pet. (98-05), (RZN194) (3RZ-FE) 2.7i LWB Legend35, Raider, Raider D/cab, Raised Body Pet. 5-Spd. Man. (98-05), Land Cruiser (FJ75) 4X4 (3F) 4.0 DLX P/up Petrol 5-Spd. Man. (85-92), (3F) 4.0 DLX P/up Petrol 5-Spd. Man. (85-92), (FJ80) 4X4 (3F-E) 4.0 GX, VX P/up Pet., 4-Spd. Auto. (90-92), (FZJ75) 4X4 (1FZ-F) 4.2 GX S/W Pet. 4-Spd. Man. (90-97), (FZJ80) 4X4 (1FZ-FE, 1HD) 4.5 Std., GX P/up, GX, VX S/W 12V Dies. 5-Spd. Man., 4-Spd. Auto. (90-98), (FZJ100) 4X4 (2UZ-FE) 4.7 VX V8 Petrol 5-Spd. Man., 4-Spd. Auto. (98-03), 4.2 VX TD P/up, S/W, GX DSL P/up AHC Diesel 5-Spd. Auto. (02-04), (FZJ105) 4X4 (1FZ-FE) 4.2 Std., GX P/up Dies. Turbo 5-Spd. Man., 4-Spd. Auto. (98-06), 4.5 GX S/W Dies. 5-Spd. Man., 4-Spd. Auto., 4.7 VX S/W V8 Petrol (03-08), (HDJ80) 4X4 (1FZ-FE, 1HD) 4.5 Std., GX P/up, GX, VX S/W 12V Dies. 5-Spd. Man., 4-Spd. Auto. (90-98), (HDJ100) 4X4 (2UZ-FE) 4.7 VX V8 Petrol 5-Spd. Man., 4-Spd. Auto. (98-03), (1FZ-FE) 4.5 GX, VX S/W Dies. 5-Spd. Man., 4-Spd. Auto. (98-06), (HJ75) 4X4 (3F) 4.0 DLX P/up Petrol 5-Spd. Man. (85-92), (HZJ75) 4X4 (1HZ) 4.2 P/up Dies., 4-Spd. Man. (90-97), (HZJ80) 4X4 (1HZ) 4.2 Std., GX 5-Spd. Man. Dies. 4-Spd. Auto., 5-Spd. Man. (90-92), (1HD-FT) 4.2 GX, VX Dies. 5-Spd. Man., 4-Spd. Auto. (96-98), (HZJ105) 4X4 (1HZ) 4.2 GX P/up Dies. Turbo 5-Spd. Man., Auto. (98-06), (PHJ75) 4X4 4.0 DLX 236 Perkins Dies. 4-Spd. Man. (85-91), (UZJ100) 4X4 (2UZ-FE) 4.7 VX V8 Petrol 5-Spd. Man., 4-Spd. Auto. (98-03), (1HD-FTE) 4.2 VX TD S/W, GX DSL S/W, P/up S/W AHC Dies. 4/5-Spd. Auto. (04-08), (UZJ105) 4X4 4.5 GX S/W Dies. 5-Spd. Man., 4-Spd. Auto., 4.7 VX S/W V8 Petrol (03-08), Prado 90/95 4X4 (1KZ-TE) 3.0 GX, VX S/W Dies. 5-Spd. Man., Auto., 3.4 GX, VX S/W Man., Auto., Pet. (96-02), Prado 120 4X4 (1KZ-TE) 3.0TD, VX S/W Dies., 5-Spd. Man., 4-Spd. Auto., (1GR-FE) 4.0 GX, VX S/W 4-Spd. Auto. Pet. (02-09), Prado 150 4X4 (1KD-FTV) 3.0D VX, TX S/W 4-Spd. Auto., Dies., (1GR-FE) 4.0 TX, VX S/W 4-Spd. Auto. Pet. (2010-), 100-Series 4X4 4.0 GX DSL S/W, VX S/W Pet. 5-Spd. Man., Auto. (98-06), RAV4 I (SXA10/11) 4X4 (3S-FE) 2.0 3/5-Dr. SUV, DOHC, 5-Spd. Man., 4-Spd. Auto. (94-02), RAV4 II (AZCA20) 4X2 (1ZZ-FE) 1.8 SUV Pet. 5-Spd. Man., RAV4 II 4X4 (1AZ-FE) 2.0 SUV 5-Spd. Man., 4-Spd. Auto. (02-06), Stallion (KF50) (5K) 1.5 Commuter, P/up, SR5 P/up, Bus, P/van Pet., 4/5-Spd. Man. (87-91), (YF50) (2Y) 1.8 P/up, (2Y) 1.8 SR5 P/up, P/van, Pet., (LF50) (2L) 2400D P/up Dies. (91-04), Venture (YF50) (2Y) 1.8 P/van, 8/10-Seater Pet., 4/5-Spd. Man., (YF51) (4Y) 2.2 10-Seater, Getaway 5-Seater, GLE 9-Seater Pet. 5-Spd. Man., (LF50) (2L) 2.4 10-Seater Dies. 5-Spd. Man. (91-04)</p>
 <p>ID: 10, OD: 26, L: 22.7</p>	<p>AR5095 Front Lower Control Arm Bush - Inner</p> <p>Ford Escort MKI / II 1.1 300 SWB P/van Kent Pet., 1.3 30/35/45 SWB P/van Kent Pet., 1.6 45 P/van SWB P/van Kent Pet. (68-81)</p>

	<p>AR5125 Exhaust Hanger - Middle, Rear</p> <p>Ford Bantam 1.3 SWB P/up Kent 2V Pet., (CVH) 1.6 Leisure SWB P/up Pet. (83-86), (CVH, FUA) 1.4 Leisure SWB P/up Pet. (86-94), (B3) 1.3 130 Explorer SWB P/up Pet., (F6) 160i, Explorer, Leisure, Sport SWB P/up Pet. (94-03), Escort MKIII FWD 1.3 GL, L Kent, (HL16CVH) 1.6 GLE, L Sport, XR3, i, (Endura DE) 1.8i GLi Pet. - Zetec, TD Dies. (81-86), Sapphire 1.6 L Kent, 2.0 GL, GLE, 2.0i GLi, GLi Exec., GLEA Koln, 3.0 V6 Ghia, GLX Essex (89-93), Sierra 1.6 GL, L, SW Kent, 2.0 GL, GL S/W, GLE, GLEA, GLi, LX Sedan, SW Koln, (Cologne) 2.3 V6 GLE, SW, 3.0 V6 GLS, GLX, LX, RS, XR6, 3.0i V6 RS Essex (83-93); Land Rover 88-Series II, II A/B, III 2.25 SWB P/up Pet., Dies., (OHI) 2.6 LWB P/up 6-Cyl. SE Pet., 109-Series 2.25 SWB, LWB P/up Pet., Dies., (OHI) 2.6 LWB P/up 6-Cyl. SE Pet., 110-Series (R6) 2.6 LWB P/up 6-Cyl., (ADE236) 3.5 V8 LWB "PUP" P/up Pet. (82-86), Discovery I 2.2 TD, 3.5, 3.9 (89-04), Discovery III 2.5 TD V6, 2.7 TD V6, 4.0 V6, 4.4 V8 (05-09); Mazda Rustler (B3) 130 SWB Drifter, Explorer P/up Pet., (B6i, F6) 160, i SWB Explorer, Drifter P/up Pet., 1.3 SWB P/up Kent 2V Pet., (CVH, FUA) 1.4 SWB P/up, (CVH, LUC) 1.6 LX (86-02)</p>
	<p>AR5133 Exhaust Hanger - Middle</p> <p>Opel Kadett 1.2, 1.3, 1.6, 1.8 (80-85)</p>
	<p>AR5134 Tension Rod Bush</p> <p>Honda Ballade (SH4) (D15B3) 150 16V SOHC, (D16A9) 160i 16V SOHC, DOHC (89-92)</p>
	<p>AR5139 Exhaust Hanger - Front, Middle, Rear</p> <p>Ford Courier (F6) 1.6 SWB P/up Pet., (F8) 1.8 SWB, LWB P/up Ch. Cab, Std., XLT Pet., (FE) 2.0 XLT LWB P/up Pet., 2.2 D/cab, Explorer, Std., XLT, Leisure SWB, LWB P/up (F2) Pet., (R2) Dies., (WL4) 2.5D TD, Leisure LWB P/up Dies., 3.0 V6 D/cab, Std., L, Leisure, Explorer SWB, LWB P/up, Essex Pet., 3.4 V6 Leisure, D/cab SWB, LWB P/up Pet. (86-00), Courier 4X4 (WL4) 2.5D TD V6 D/cab, Leisure LWB P/up Dies., 3.0 V6 Std., XLT, D/cab, Leisure, Explorer, Exec. LWB P/up Essex Pet., 3.4 V6 Leisure D/cab LWB P/up Pet. (90-00), Laser 1.3 Dash, GL, L, Tracer H/B, Sedan, Tonic (86-95), (CHV-FUA) 1.4 L, (E5) 1.5 GL, GLS, Sport (86-92), (B6, F6, CVH) 1.6 i, 16, GL, Sport, Tracer H/B, Sedan, Plus, TX3 (86-91), (FE) 2.0i RS (91-94), Meteor (B3, E3) 1.3 GL, L (86-95), (CVH) 1.4 LX, (E5) 1.5 GL, GLS (86-92), (B6, F6, CVH) 1.6 16, GL, GLE, GLi, Sport (86-91), (FE) 2.0 GLE, GLi (91-94), Tracer (B3, E3) 1.3 H/B, Sedan, Tonic, Plus (95-02), Spectron (F2) 2.2 LWB Bus, P/van Pet. (91-04); Kia Rio I (A3E) 1.3, RS, (A5D) 1.5, RS (00-05), Sephia (BFD) 1.5 LS, RS (98-04), Shuma (BFD) 1.5i LS, (TBD) 1.8i GS (98-04), Shuma II 1.6i, (T8) 1.8i GS (98-04), Spectra (A6) 1.6 Exec., LS (98-04); Mazda 3 (BK, BL) (B6ZE, Z6) 1.6 Original, Active, Dynamic, (LF17) 2.0 Dynamic, Individual, (L3KG) 2.3 Individual MPS, (L5-VE) 2.5 (04-14), 323 FWD (B3) 130 Hatch, Sedan (85-91), Midge / Sting (F6) 160 i, s, Hatch, Sedan, (B6) 1.6 EGi, S, SL Hatch, Sedan, Sport, (F6) 160, i, iS, Hatch, Midge, Sting, Sedan, 2.0 EGi Hatch, SLE Hatch, SLi, Sedan, (FE-2000) 200e, i Sedan, Hatch DOHC 8/16 Valve (85-91), 626 (F6) 1.6 L Hatch, Sedan, S Sedan, SL Hatch Man., (F8) 1.8 L Hatch, Sedan Man., (FE) 2.0 SL Hatch, EGi, Sedan, SLi 16 Valve, SLE, 12 Valve, SLX Sedan, Hatch (83-93), B-Series B1600 (F6) SWB Magnum P/up Pet., B1800 (F8) S/LWB Magnum, Drifter P/up Pet., B2000 (FE) LWB Magnum, Drifter P/up Pet., B2200 SWB, LWB D/cab, Magnum, Drifter P/up (F2) Pet., (R2) Dies., B2500D (WL4), TD LWB Drifter, SLX P/up Dies. (82-00), B2600 (4G54) LWB D/cab, Magnum, Drifter, P/up Pet. (86-02), B3000 V6 LWB D/cab, Magnum, Drifter P/up Essex Pet., B3400 V6 LWB D/cab, Magnum P/up Pet. (86-99), B-Series 4X4 B2600 (4G54) V6 LWB D/cab Magnum, Drifter P/up Pet. (86-95), B3000 V6 LWB D/cab, Magnum, Drifter P/up Essex Pet., B3400 V6 LWB D/cab Magnum P/up Pet. (86-99), B2500D (WL4) TD LWB, D/cab, Magnum, Drifter SLX P/up Dies., B2600i V6 LWB Drifter, D/cab Drifter, SLX P/up Pet. (96-07), Marathon (F2) 2.2 LWB Bus, P/van Pet. (91-04)</p>
	<p>AR5140 Front Stabilizer Bar Bush</p> <p>Chevrolet Spark (M150) (F8CV) 0.8 L, LS, (B10S1) 1.0 LS, LT (03-05), Spark, Spark Lite (M200, M250) (F8CV) 0.8 L, LS, (B10S1) 1.0 LS, LT (2005-), Spark (M300) (B12D1) 1.2 (2010-); Daewoo Matiz (F8CV) 800cc S, SE (99-03)</p>

ENGINE MOUNTING & RUBBER BUYERS GUIDE

	<p>AR5141 Engine Mounting - L/RHS Mercedes-Benz (W203) C-Class C240 (M203.086) 2.6 V6 Elegance, S/W, Elegance S/W, C320 (M111.946) 3.2 V6 Avantgarde Elegance, SW, (M112.912) C240 (00-11)</p>		<p>AR5153 Exhaust Hanger - Middle Daewoo Espero (C18LE) 1.8 CD, (C20LE) 2.0 CD (96-98)</p>
	<p>AR5142 Engine Mounting - RHS Mercedes-Benz (W203) C-Class C270 (OM612.962) 2.7 CDi 5-Cyl. Elegance, S/W, (M271.946) C180K, (M271.940) C200K, (OM611.962, OM646.963) C220 CDi, (OM642.910) C320 CDi, (M272.960) C350 (00-11), (W211) E-Class (OM647.961) E270 CDi (02-10)</p>		<p>AR5157 Front Stabilizer Bar Bush Ford Focus I (ZH16MEFI) 1.6 Ambiente, Trend, (F9DA) 1.8 TDCi Trend, (ZH20MEFI) 2.0 RS, Trend, ST170 (00-05)</p> <p>ID: 21.5, L: 46, H: 48.7</p>
	<p>AR5143 Engine Mounting - LHS Mercedes-Benz (W203) C-Class C270 (OM612.962) 2.7 CDi 5-Cyl. Elegance, S/W, (OM611.962, OM646.963) C220 CDi, (OM642.910) C320 CDi, (M272.960) C350 (00-11), (W211) E-Class (OM647.961) E270 CDi (02-10)</p>		<p>AR5158 Front Stabilizer Bar Bush Mitsubishi Pajero 4X4 (4G54) 2.6 SWB, LWB GLS, SJ25/26/45 SUV Pet. (83-94)</p>
	<p>AR5144 Front Stabilizer Bar Bush Mercedes-Benz (W140) S-Class S320 (M104.994) 3.2 6-Cyl., S420 (M119.971) 4.2 V8, S500 (M119.970) 5.0 8-Cyl. (93-99), (W210) E-Class E200K (M111.957) 2.0, E230 (M111.970) 2.3, E240 (M112.911) 2.4, E280 (M112.921) 2.8 V6, E320 (M104.995, M112.941) 3.2 V6, E430 (M113.940) 4.3 V8 (96-02)</p> <p>ID: 26, OD: 46, L: 65</p>		<p>AR5159 Transmission Mounting Ford Cortina MKIII 1.6 L SWB P/up Kent Pet., 2.0 V4 SWB P/up Koln Pet., 2.5 V6 L SWB P/up Essex Pet., (EV30) 3.0 GT, L, XL, XLE "Big Six" Essex (71-77), Cortina MKIV 1.3 L Kent, 1.6 1-Tonner SWB P/up Kent Pet., 2.0 GL, GLE Koln, 3.0 V6 1-Tonner SWB P/up Essex Pet. (77-86), Cortina MKV 1.6 1-Tonner SWB P/up Kent Pet., 2.4D 1-Tonner SWB P/up York Pet., 3.0 V6 1-Tonner SWB, LWB P/up Essex Pet. (77-86)</p>
	<p>AR5145 Front Stabilizer Bar Bush Mercedes-Benz (W210) E-Class E200K (M111.957) 2.0, E230 (M111.970) 2.3, E240 (M112.911) 2.4, E280 (M112.921) 2.8 V6, E320 (M104.995, M112.941) 3.2 V6, E430 (M113.940) 4.3 V8 (96-02)</p> <p>ID: 26.5</p>		<p>AR5160 Front Subframe Insulator - Upper Ford Cortina MKIII 1.6 L SWB P/up Kent Pet., 2.0 V4 SWB P/up Koln Pet., 2.5 V6 L SWB P/up Essex Pet., (EV30) 3.0 GT, L, XL, XLE "Big Six" Essex (71-77), Cortina MKIV 1.3 L Kent, 1.6 1-Tonner SWB P/up Kent Pet., 2.0 GL, GLE Koln, 3.0 V6 1-Tonner SWB P/up Essex Pet. (77-86), Cortina MKV 1.6 1-Tonner SWB P/up Kent Pet., 2.4D 1-Tonner SWB P/up York Pet., 3.0 V6 1-Tonner SWB, LWB P/up Essex Pet. (77-86)</p> <p>ID: 12, OD: 70, L: 71</p>
	<p>AR5147 Front Lower Control Arm Bush - Inner Repair Kit Mercedes-Benz (W210) E-Class E200K (M111.957) 2.0, E230 (M111.970) 2.3, E240 (M112.911) 2.4, E280 (M112.921) 2.8 V6, E320 (M104.995, M112.941) 3.2 V6, E430 (M113.940) 4.3 V8 (96-02)</p> <p>NO PICTURE AVAILABLE AT TIME OF PRINT ID: 15/20, OD: 60/70, L: 90/47</p>		<p>AR5163 Shackle Bush - Front, Rear Upper & Lower Ford Bantam 1.3 SWB P/up Kent 2V Pet., (CVH) 1.6 Leisure SWB P/up Pet. (83-86), (CVH, FUA) 1.4 Leisure SWB P/up Pet., (CVH) 1.6 Leisure, Nite SWB P/up Pet. (86-94), (B3) 1.3 130 Explorer SWB P/up Pet., (F6) 160i, Explorer, Leisure, Sport SWB P/up Pet. (94-03), Bantam 'Boet' (CLTA) 1.3i XL, XLS SWB P/up Pet., (Zetec) 1.6i XLE, XLT, SWB P/up Pet., 1.8di XL SWB P/up Dies. (02-12), Cortina MKIV 1.3 L Kent, 1.6 1-Tonner SWB P/up Kent Pet., 2.0 GL, GLE Koln, 3.0 V6 1-Tonner SWB P/up Essex Pet. (77-86), Cortina MKV 1.6 1-Tonner SWB P/up Kent Pet., 2.4D 1-Tonner SWB P/up York Pet., 3.0 V6 1-Tonner SWB, LWB P/up Essex Pet. (77-86); Mazda Rustler (B3) 130 SWB Drifter, Explorer P/up Pet., (B6i, F6) 160, i SWB Explorer, Drifter P/up Pet., 1.3 SWB P/up Kent 2V Pet., (CVH, FUA) 1.4 SWB P/up, (CVH, LUC) 1.6 LX (86-02)</p>
	<p>AR5149 Exhaust Hanger - Front, Middle, Rear Ford Laser (B3, E3) 1.3 Dash, GL, L, Tracer H/B, Sedan, Tonic (91-95), (CHV-FUA) 1.4 L, (E5) 1.5 GL, GLS, Sport (91-92), (B6, F6, CVH) 1.6 i, 16, GL, Sport, Tracer H/B, Sedan, Plus, TX3 (91-92), (FE) 2.0i RS (91-94), Meteor (B3, E3) 1.3 GL, L (91-95), (CVH) 1.4 LX, (E5) 1.5 GL, GLS (91-92), (B6, F6, CVH) 1.6 16, GL, GLE, GLi, Sport (91-92), (FE) 2.0 GLE, GLi (91-94), Tracer (B3, E3) 1.3 H/B, Sedan, Tonic, Plus (95-02), (B6, F6) 1.6i 16, Sedan, Hatchback, Plus, Sport, Tonic (95-02), Ranger 1.8, XL SWB, LWB P/up Pet. (99-10); Mazda 323 FWD (E3) 1.3 S, L H/back, Sedan, (E/B3) 130 Hatch, Midge, Sting, Sedan, (E5) 1.5 GLC, L, SL, SLX, Sport Sedan, Hatchback (91-95), Midge / Sting (F6) 160 i, s, Hatch, Sedan, (B6) 1.6 EGi, S, SL Hatch, Sedan, Sport, (F6) 160, i, iS, Hatch, Midge, Sting, Sedan, 2.0 EGi Hatch, SLE Hatch, SLi, Sedan, (FE-2000) 200e, i Sedan, Hatch DOHC 8/16 Valve (91-03), 626 (F6) 1.6 L Hatch, Sedan, S Sedan, SL Hatch Man., (F8) 1.8 L Hatch, Sedan Man. (83-93), (FS2B/D) 2.0i S/W, Sedan (93-03), Astina (BPI) 180Se Sedan, Hatch (95-00), Etude (B6i) 160, e, i, ie, Ise, Sport 16V, (BPI) 180e, iSe, Se, Sedan (95-00), Drifter 1.8 SWB, LWB XL P/up Pet. (00-08); Nissan Maxima (GV) (VG30E) 300SE 6-Cyl. (91-97), Maxima (QX) (VQ20E/DE) 2.0, (VQ30DE) 3.0 V6 (96-04), Primera (SR16DE) 160 SE, Si, (SR20DE) 200 GSi, Si, STi, Elegance, Luxury (98-02), Sabre (GA16DS) 160 GX, GXi, (SR20DE) 200 GXi (94-02), Sentra (E13S) 1.3 GL, SX, (E16E/S) 1.6 GL, GX, GXE, GXEi Coupe, SGLi (87-92), (CA18DE) 1.8i 16V T/cam Coupe, Sedan Exec. (89-92), (GA14DNE/DS) 140, GX, GXi, i, Si (92-02), (GA16DNE/S) 160, GSi, GX, GXi, SE, Si (92-02), (SR20DE) 200 GSi, STi (92-02), Skyline (R31) (CA20, RB20E) 2.0 GL, GLE, SGi, SGLi, (RB30E) 3.0 6-Cyl. SGLi (87-92), Tiida (HR16DE) 1.6 Visia, Visia +, Acenta, (MR18DE) 1.8 Acenta (06-13)</p>		<p>AR5164 Front Subframe Insulator - Lower Ford Cortina MKIII 1.6 L SWB P/up Kent Pet., 2.0 V4 SWB P/up Koln Pet., 2.5 V6 L SWB P/up Essex Pet., (EV30) 3.0 GT, L, XL, XLE "Big Six" Essex (71-77), Cortina MKIV 1.3 L Kent, 1.6 1-Tonner SWB P/up Kent Pet., 2.0 GL, GLE Koln, 3.0 V6 1-Tonner SWB P/up Essex Pet. (77-86), Cortina MKV 1.6 1-Tonner SWB P/up Kent Pet., 2.4D 1-Tonner SWB P/up York Pet., 3.0 V6 1-Tonner SWB, LWB P/up Essex Pet. (77-86)</p> <p>ID: 12, OD: 51, L: 73.5</p>
	<p>AR5152 Exhaust Hanger - Middle, Rear Ford Escort MKIII FWD 1.3 GL, L Kent, (HL16CVH) 1.6 GLE, L Sport, XR3, i, (Endura DE) 1.8i GLi Pet. - Zetec, TD Dies. (81-86)</p>		<p>AR5166 Front Lower Control Arm Bush - Outer Daewoo Matiz (F8CV) 800cc S, SE (99-03)</p> <p>ID: 10, OD: 27, L: 52</p>
			<p>AR5167 Rear Lower Control Arm Bush - Inner & Outer Ford Escort MKIII FWD 1.3 GL, L Kent, (HL16CVH) 1.6 GLE, L Sport, XR3, i, (Endura DE) 1.8i GLi Pet. - Zetec, TD Dies. (81-86)</p>

ENGINE MOUNTING & RUBBER BUYERS GUIDE

 <p>ID: 10, OD: 32, L: 51</p>	<p>AR5168 Front Lower Control Arm Bush - Inner</p> <p>Ford Bantam 1.3 SWB P/up Kent 2V Pet., (CVH) 1.6 Leisure SWB P/up Pet. (83-86), (CVH, FUA) 1.4 Leisure SWB P/up Pet., (CVH) 1.6 Leisure, Nite SWB P/up Pet. (86-94), Escort MKIII FWD 1.3 GL, L Kent, (HL16CVH) 1.6 GLE, L Sport, XR3, i, (Endura DE) 1.8i GLi Pet. - Zetec, TD Dies. (81-86), Sapphire 1.6 L Kent, 2.0 GL, GLE, 2.0i GLi, GLi Exec., GLEA Koln, 3.0 V6 Ghia, GLX Essex (89-93), Sierra 1.6 GL, L, SW Kent, 2.0 GL, GL S/W, GLE, GLEA, GLi, LX Sedan, SW Koln, (Cologne) 2.3 V6 GLE, SW, 3.0 V6 GLS, GLX, LX, RS, XR6, 3.0i V6 RS Essex (83-93); Mazda Rustler 1.3 SWB P/up Kent 2V Pet., (CVH, FUA) 1.4 SWB P/up, (CVH, LUC) 1.6 LX (86-93)</p>
	<p>AR5171 Front Strut Mounting</p> <p>Citroen Berlingo (TU3JP) 1.4i Multispace, Multispace Executive MPV, P/van, (XUD9A) 1.9D P/van Dies. (03-10), Xsara (TU5JP4) 1.6 SX, (EW10J4, XU10J4RS, DW10ATED) 2.0 VTS, HDi (01-06), Picasso (TU5JP4) 1.6, (EW7J4, XU7JP4) 1.8 Exclusive, (W10J4, DW10ATE) 2.0 Exclusive, HDi Exclusive (01-06); Peugeot Partner 1.9D P/van, 2.0 Grand Raid HDi Dies. (03-10)</p>
	<p>AR5172 Transmission Mounting</p> <p>Ford Courier 3.0 V6 D/cab, Std., L, Leisure, Explorer SWB, LWB P/up, Essex Pet., 3.4 V6 Leisure, D/cab SWB, LWB P/up Pet. (86-00), Sapphire 1.6 L Kent, 2.0 GL, GLE, 2.0i GLi, GLi Exec., GLEA Koln, 3.0 V6 Ghia, GLX Essex (89-93), Sierra 1.6 GL, L, SW Kent, 2.0 GL, GL S/W, GLE, GLEA, GLi, LX Sedan, SW Koln, (Cologne) 2.3 V6 GLE, SW, 3.0 V6 GLS, GLX, LX, RS, XR6, 3.0i V6 RS Essex (83-93); Mazda B-Series B2600 (4G54) LWB D/cab, Magnum, Drifter, P/up Pet. (86-02), B3000 V6 LWB D/cab, Magnum, Drifter P/up Essex Pet. (86-99), B-Series 4X4 B3000 V6 LWB D/cab, Magnum, Drifter P/up Essex Pet. (86-99)</p>
 <p>ID: 12, OD: 44.3, L: 49</p>	<p>AR5173 Front Lower Control Arm Bush - Inner</p> <p>Daewoo Nubira I (616L, A16DM) 1.6 SX, (C20SED, X20S) 2.0 CDX (97-03), Nubira II 1.6 SX, 2.0 CDX (97-03)</p>
 <p>ID: 16, OD: 49, L: 53</p>	<p>AR5174 Front Lower Control Arm Bush - Outer</p> <p>Daewoo Nubira I (616L, A16DM) 1.6 SX, (C20SED, X20S) 2.0 CDX (97-03), Nubira II 1.6 SX, 2.0 CDX (97-03)</p>
 <p>ID: 16, OD: 47, L: 20</p>	<p>AR5175 Front Lower Control Arm Bush - Outer</p> <p>Ford Bantam 1.3 SWB P/up Kent 2V Pet., (CVH) 1.6 Leisure SWB P/up Pet. (83-86), (CVH, FUA) 1.4 Leisure SWB P/up Pet., (CVH) 1.6 Leisure, Nite SWB P/up Pet. (86-94), Escort MKIII FWD 1.3 GL, L Kent, (HL16CVH) 1.6 GLE, L Sport, XR3, i, (Endura DE) 1.8i GLi Pet. - Zetec, TD Dies. (81-86); Mazda Rustler 1.3 SWB P/up Kent 2V Pet., (CVH, FUA) 1.4 SWB P/up, (CVH, LUC) 1.6 LX (86-93)</p>
	<p>AR5177 Front Lower Control Arm Bush - Inner</p> <p>Nissan 620 (J15) 1.5 SWB, LWB P/up Pet. (73-80), 680 (J15) 1.5 SWB P/up Pet., (SD22) 2.2 LWB P/up Dies. (73-80), E20 (J16) 1.6 SWB Bus, Coach, P/van Pet., (L18) 1.8 SWB, LWB 10, 16-Seater Bus, Coach, Coach, GL, GLE, Econolux, Ekonovan, Ekonowagon Pet. (73-96)</p>
	<p>AR5178 Rear Subframe Bush - Front</p> <p>BMW 7-Series (E38) 740i (M60) 4.0 V8, (M62) 4.4 V8, 750iL (M73) 5.4 V12 (96-03)</p>
 <p>ID: 69, H: 42/58</p>	<p>AR5179 Rear Subframe Bush - Rear</p> <p>BMW 5-Series (E39) 523i (M52) 2.5, 525i (M54) 2.5, 528i (M52) 2.8, 530d (M57) 3.0 Dies., 530i (M54) 3.0 (96-04), 540i (M62) 4.4, M5 (S38) 3.6 (98-04), (S62) 4.9 V8 (99-04)</p>

 <p>ID: 19</p>	<p>AR5180 Front Lower Control Arm Bush - Outer, Rear</p> <p>Citroen Berlingo (TU3JP) 1.4i Multispace, Multispace Executive MPV, P/van, (XUD9A) 1.9D P/van Dies. (03-10), Xsara (TU5JP4) 1.6 SX, (EW10J4, XU10J4RS, DW10ATED) 2.0 VTS, HDi (01-06), Picasso (TU5JP4) 1.6, (EW7J4, XU7JP4) 1.8 Exclusive, (W10J4, DW10ATE) 2.0 Exclusive, HDi Exclusive (01-06); Peugeot 306 (TU5JP) 1.6 XT S/W, (XU10J2/K) 2.0 XSi, Cabrio OHC (95-03), Partner 1.9D P/van, 2.0 Grand Raid HDi Dies. (03-10)</p>
 <p>ID: 12, OD: 33, L: 30.8</p>	<p>AR5181 Front Lower Control Arm Bush - Inner, Front</p> <p>Citroen Berlingo (TU3JP) 1.4i Multispace, Multispace Executive MPV, P/van, (XUD9A) 1.9D P/van Dies. (03-10), Xsara (TU5JP4) 1.6 SX, (EW10J4, XU10J4RS, DW10ATED) 2.0 VTS, HDi (01-06), Picasso (TU5JP4) 1.6, (EW7J4, XU7JP4) 1.8 Exclusive, (W10J4, DW10ATE) 2.0 Exclusive, HDi Exclusive (01-06); Peugeot 306 (TU5JP) 1.6 XT S/W, (XU10J2/K) 2.0 XSi, Cabrio OHC (95-03), Partner 1.9D P/van, 2.0 Grand Raid HDi Dies. (03-10)</p>
	<p>AR5185 Engine Mounting - RHS</p> <p>Ford Focus I (ZH16MEFI) 1.6 Ambiente, Trend, (ZH20MEFI) 2.0 RS, Trend, ST170 (03-05)</p>
	<p>AR5186 Engine Mounting - Rear</p> <p>Ford Focus I (ZH16MEFI) 1.6 Ambiente, Trend, (F9DA) 1.8 TDCi Trend, (ZH20MEFI) 2.0 RS, Trend, ST170 (00-05)</p>
	<p>AR5187 Transmission Mounting</p> <p>Ford Focus I (ZH16MEFI) 1.6 Ambiente, Trend, (F9DA) 1.8 TDCi Trend, (ZH20MEFI) 2.0 RS, Trend, ST170 (00-05)</p>
 <p>ID: 12, OD: 41, L: 64.6</p>	<p>AR5188 Front Lower Control Arm Bush - Inner, Front</p> <p>Ford Focus I (ZH16MEFI) 1.6 Ambiente, Trend, (F9DA) 1.8 TDCi Trend, (ZH20MEFI) 2.0 RS, Trend, ST170 (00-05)</p>
 <p>ID: 22</p>	<p>AR5189 Front Lower Control Arm Bush - Outer, Rear</p> <p>Ford Focus I (ZH16MEFI) 1.6 Ambiente, Trend, (F9DA) 1.8 TDCi Trend, (ZH20MEFI) 2.0 RS, Trend, ST170 (00-05)</p>
	<p>AR5190 Front Strut Mounting</p> <p>Ford Focus I (ZH16MEFI) 1.6 Ambiente, Trend, (F9DA) 1.8 TDCi Trend, (ZH20MEFI) 2.0 RS, Trend, ST170 (00-05)</p>
 <p>ID: 20.3, L: 32, H: 43.2, W: 46.2</p>	<p>AR5191 Rear Stabilizer Bar Bush</p> <p>Ford Focus I (ZH16MEFI) 1.6 Ambiente, Trend, (F9DA) 1.8 TDCi Trend, (ZH20MEFI) 2.0 RS, Trend, ST170 (00-05)</p>
	<p>AR5192 Transmission Mounting</p> <p>Mazda 323 FWD (E3) 1.3 S, L H/back, Sedan, (E/B3) 130 Hatch, Midge, Sting, Sedan, (E5) 1.5 GLC, L, SL, SLX, Sport Sedan, Hatchback (81-95) - Auto. Models</p>
	<p>AR5194 Engine Mounting - L/RHS</p> <p>Ford Husky (4G62) 1.8 1-Ton SWB P/up, P/van, Bus Pet., (4G63) 2.0 1-Ton SWB P/up, P/van, Bus Pet. (85-99); Mitsubishi L300 (4G32) 1.6 SWB Mini Bus, Van Pet., (4G62) 1.8 SWB/ LWB, D/S, P/U, P/up, P/van Pet., (4G62) 2.0 LWB P/up Pet. (82-01), Starwagon (4G62) 2.0 LWB S, SL, SLE P/van Pet. (82-01)</p>

ENGINE MOUNTING & RUBBER BUYERS GUIDE

215

	AR5195 Engine Mounting - L/RHS Hyundai Bakkie (4D56) 2.5i DT LWB P/up, P/van Dies., (4G54) 2.6i LWB P/van, P/up, Dropside Pet. (97-09)		AR5211 Shackle Bush - Rear Upper Mercedes-Benz Sprinter (BM903, BM904) 308D (OM601LA) SWB Bus, P/van Dies., 312D (OM6O2) LWB Bus, P/van Dies., 313 CDi (OM611) SWB/ LWB Bus, P/van Dies., 412D (OM602LA) LWB P/van Dies., 413 CDi (OM611DELA) SWB P/van Dies. (96-06) ID: 12, OD: 27, L: 134
	AR5196 Engine Mounting - LHS Mercedes-Benz (W203) C-Class C180 (M111.920) 1.8 Classic, C200 (M271.940) 2.0 Classic, S/W, C220 (OM611.962, OM646.963) 2.2 CDi Classic, S/W, Elegance, C230 2.3 Coupe (00-08)		AR5212 Shackle Bush - Rear Lower Mercedes-Benz Sprinter (BM903, BM904) 308D (OM601LA) SWB Bus, P/van Dies., 312D (OM6O2) LWB Bus, P/van Dies., 313 CDi (OM611) SWB/ LWB Bus, P/van Dies., 412D (OM602LA) LWB P/van Dies., 413 CDi (OM611DELA) SWB P/van Dies. (96-06)
	AR5198 Centre Bearing Rubber Mercedes-Benz (W210) E-Class E200K (M111.957) 2.0, E230 (M111.970) 2.3, E240 (M112.911) 2.4, E280 (M112.921) 2.8 V6, E320 (M104.995, M112.941) 3.2 V6, E430 (M113.940) 4.3 V8 (96-02) ID: 25		AR5213 Front Stabilizer Link Grommet Mercedes-Benz Sprinter (BM903, BM904) 308D (OM601LA) SWB Bus, P/van Dies., 312D (OM6O2) LWB Bus, P/van Dies., 313 CDi (OM611) SWB/ LWB Bus, P/van Dies., 412D (OM602LA) LWB P/van Dies., 413 CDi (OM611DELA) SWB P/van Dies. (96-06) ID: 13.5, OD: 26, W: 20
	AR5199 Engine Mounting - L/RHS Mercedes-Benz Sprinter (BM903, BM904) 308D (OM601LA) SWB Bus, P/van Dies. (96-06)		AR5214 Rear Stabilizer Link Grommet Mercedes-Benz Sprinter (BM903, BM904) 308D (OM601LA) SWB Bus, P/van Dies., 312D (OM6O2) LWB Bus, P/van Dies., 313 CDi (OM611) SWB/ LWB Bus, P/van Dies., 412D (OM602LA) LWB P/van Dies., 413 CDi (OM611DELA) SWB P/van Dies. (96-06), Sprinter (BM906) 309 CDi Bus, P/van, (OM646.985) 311 CDi LWB Bus, P/van, (OM646.990) 315 CDi Bus, P/van, (OM642.992) 318 CDi Bus, P/van, (OM646.984) 509 CDi Bus, P/van, (OM646.985) 511 CDi Bus, P/van, (OM646.986) 515 CDi Bus, P/van, (OM646.992) 518 CDi Bus, P/van (2006-), Sprinter (BM906) (OM646.984) 309 CDi P/van, 16-Seater, (OM646.989, 990) 315 CDi FC, 16-Seater, (OM642.992, 993, 896) 318 CDi P/van, (OM642.992, 896, 898) 319 CDi DC, FC, PV, XC, (OM646.992, 993, 896) 518 CDi FC, DC, PV, 22-Seater, (OM642.896, 898, 992) 519 CDi (2009-)
	AR5200 Transmission Mounting Mercedes-Benz Sprinter (BM903, BM904) 308D (OM601LA) SWB Bus, P/van Dies., 312D (OM6O2) LWB Bus, P/van Dies., 313 CDi (OM611) SWB/ LWB Bus, P/van Dies., 412D (OM602LA) LWB P/van Dies., 413 CDi (OM611DELA) SWB P/van Dies. (96-06)		AR5219 Front Stabilizer Bar Bush Mercedes-Benz Sprinter (BM903, BM904) 308D (OM601LA) SWB Bus, P/van Dies., 312D (OM6O2) LWB Bus, P/van Dies., 313 CDi (OM611) SWB/ LWB Bus, P/van Dies., 412D (OM602LA) LWB P/van Dies., 413 CDi (OM611DELA) SWB P/van Dies. (96-06) ID: 22, L: 31, H: 39, W: 31
	AR5201 Engine Mounting - L/RHS Mercedes-Benz Sprinter (BM903, BM904) 312D (OM6O2) LWB Bus, P/van Dies., 313 CDi (OM611) SWB/ LWB Bus, P/van Dies., 412D (OM602LA) LWB P/van Dies., 413 CDi (OM611DELA) SWB P/van Dies. (96-06)		AR5220 Front Lower Control Arm Bush - Inner Front & Outer Rear Mercedes-Benz Sprinter (BM903, BM904) 308D (OM601LA) SWB Bus, P/van Dies., 312D (OM6O2) LWB Bus, P/van Dies., 313 CDi (OM611) SWB/ LWB Bus, P/van Dies., 412D (OM602LA) LWB P/van Dies., 413 CDi (OM611DELA) SWB P/van Dies. (96-06)
	AR5204 Front Lower Control Arm Bush - Outer Rear Ford Mondeo (IS7G, CJBA, CJBB) 2.0 Ghia (02-06)		AR5221 Engine Mounting - Front Mazda 626 (FE) 2.0 EGI (83-93)
	AR5205 Centre Bearing Rubber Mercedes-Benz Sprinter (BM903, BM904) 308D (OM601LA) SWB Bus, P/van Dies., 312D (OM6O2) LWB Bus, P/van Dies., 313 CDi (OM611) SWB/ LWB Bus, P/van Dies., 412D (OM602LA) LWB P/van Dies., 413 CDi (OM611DELA) SWB P/van Dies. (96-06) ID: 45		AR5222 Shackle Bush - Front, Rear Upper & Lower Mercedes-Benz Sprinter (BM903, BM904) 308D (OM601LA) SWB Bus, P/van Dies., 312D (OM6O2) LWB Bus, P/van Dies., 313 CDi (OM611) SWB/ LWB Bus, P/van Dies., 412D (OM602LA) LWB P/van Dies., 413 CDi (OM611DELA) SWB P/van Dies. (96-06); Volkswagen Crafter (BJK, BJM) 2.5TDi 50 HR-Series LWB, XLWB P/van (2007-) ID: 16, OD: 38.5, L: 80
	AR5207 Engine Mounting - L/RHS Mazda 323 1.6 (79-81)		AR5223 Engine Mounting - L/RHS Hyundai H100 (4D56) 2.5i DT LWB P/up, Dropside Dies., (4G54) 2.6i LWB P/van, Dropside Pet. (98-09)
	AR5208 Front Strut Mounting - Upper Mercedes-Benz Sprinter (BM903, BM904) 308D (OM601LA) SWB Bus, P/van Dies., 312D (OM6O2) LWB Bus, P/van Dies., 313 CDi (OM611) SWB/ LWB Bus, P/van Dies., 412D (OM602LA) LWB P/van Dies., 413 CDi (OM611DELA) SWB P/van Dies. (96-06) ID: 16.2		AR5224 Engine Mounting - RHS Honda Ballade (SC9) (EV2) 130 "Flip-Up Lights" Man. (84-89)
	AR5209 Front Strut Mounting - Lower Mercedes-Benz Sprinter (BM903, BM904) 308D (OM601LA) SWB Bus, P/van Dies., 312D (OM6O2) LWB Bus, P/van Dies., 313 CDi (OM611) SWB/ LWB Bus, P/van Dies., 412D (OM602LA) LWB P/van Dies., 413 CDi (OM611DELA) SWB P/van Dies. (96-06)		
	AR5210 Shackle Bush - Front Mercedes-Benz Sprinter (BM903, BM904) 308D (OM601LA) SWB Bus, P/van Dies., 312D (OM6O2) LWB Bus, P/van Dies., 313 CDi (OM611) SWB/ LWB Bus, P/van Dies., 412D (OM602LA) LWB P/van Dies., 413 CDi (OM611DELA) SWB P/van Dies. (96-06) ID: 12, OD: 32, L: 80		

ENGINE MOUNTING & RUBBER BUYERS GUIDE

	AR5225 Engine Mounting - RHS Honda Ballade (SC9) (EV2) 130 "Flip-Up Lights" Auto., (EW) 150i "Flip-Up Lights" Auto., (ZC1) 160i DOHC Auto.(84-89)
 ID: 14	AR5237 Front Strut Mounting - Upper Mercedes-Benz Vito (W638) (OM611LA) 2.2 CDi LWB Crew Bus, Crew Cab P/van, High Roof P/van Dies. (03-06)
	AR5238 Front Strut Mounting - Lower Mercedes-Benz Vito (W638) (OM611LA) 2.2 CDi LWB Crew Bus, Crew Cab P/van, High Roof P/van Dies. (03-06)
	AR5239 Rear X-Member Bush - Front Mercedes-Benz Vito (W638) (OM611LA) 2.2 CDi LWB Crew Bus, Crew Cab P/van, High Roof P/van Dies. (03-06)
	AR5240 Rear X-Member Bush - Rear Mercedes-Benz Vito (W638) (OM611LA) 2.2 CDi LWB Crew Bus, Crew Cab P/van, High Roof P/van Dies. (03-06)
	AR5241 Transmission Mounting Mercedes-Benz Vito (W638) (OM611LA) 2.2 CDi LWB Crew Bus, Crew Cab P/van, High Roof P/van Dies. (03-06)
 ID: 14.2, OD: 41.5, L: 75	AR5242 Front Lower Control Arm Bush - Inner & Outer Mercedes-Benz Vito (W638) (OM611LA) 2.2 CDi LWB Crew Bus, Crew Cab P/van, High Roof P/van Dies. (03-06), (W639) Vito 113 CDi, (OM646.980/982) 115 CDi, (OM651.940) 116 CDi, 120 CDi, (OM642.890) 122 CDi (2004-)
	AR5244 Stabilizer Link - Rear Mercedes-Benz Vito (W638) (OM611LA) 2.2 CDi LWB Crew Bus, Crew Cab P/van, High Roof P/van Dies. (03-06)
 OD: 42, L: 42	AR5245 Exhaust Hanger - Middle Opel Kadett 1.2 L, 1.3 GL, GLS, 1.6 (80-85)
 ID: 25, L: 45.2, H: 53, W: 54	AR5248 Front & Rear Stabilizer Bar Bush Mercedes-Benz Vito (W638) (OM611LA) 2.2 CDi LWB Crew Bus, Crew Cab P/van, High Roof P/van Dies. (03-06), (W639) Vito 113 CDi, (OM646.980/982) 115 CDi, (OM651.940) 116 CDi, 120 CDi, (OM642.890) 122 CDi (2004-)
	AR5249 Trailing Arm Bush Mercedes-Benz Vito (W638) (OM611LA) 2.2 CDi LWB Crew Bus, Crew Cab P/van, High Roof P/van Dies. (03-06)
	AR5250 Engine Mounting - RHS Mercedes-Benz Vito (W638) (OM611LA) 2.2 CDi LWB Crew Bus, Crew Cab P/van, High Roof P/van Dies. (03-06)

	AR5262 Exhaust Hanger - Front, Middle, Rear Suzuki Swift (M16A) 1.6 (2010-); Toyota Conquest (EE80) (2E-L) 1.3 L, GL 12V 4-Spd. Man. (85-88), (AE92) (4A-GE) 1.6 RSi Twincam 5-Spd. Man. (88-93), (4A-F) 1.6 LS 3-Spd. Auto., (4A-F) 1.6 RS, Sport DOHC 5-Spd. Man. (88-93), Corolla (AE80) (2A-L) 1.3 FWD GL 8V 4-Spd. Man. (84-88), (AE82) (4A-GE) 1.6 L (84-88), (EE80) (2E-L) 1.3 FWD L, GL OHC 4-Spd. Man. (84-88), (AE92) (4A-F) 1.6 GL, GLS, Exec., Sprinter, GLE, Sport., (4A-GE) 1.6 DOHC, GLi, GLi Exec., (4A-F) 1.6 DOHC, 5-Spd. Man., 3-Spd. Auto., GL, GLX DOHC 4-Spd. Auto. (88-93), Cressida (GX71) (1G-E) 2.0 GLi6 5-Spd. Man., Executive DOHC, (1G-FE) I.R.S. 4-Spd. Auto. (86-92), (MX73) (5M-GE) 2.8i RSi, RSi Exec. DOHC 5-Spd. Man., 4-Spd. Auto., (MX75) 3.0 GLS 5-Spd. Man., (ECT) (7M-GE) 3.0i I.R.S. 24V DOHC 4-Spd. Auto. (86-92), (RX70) (21R) 2.0 GL, GLX, GL S/W, (RX72) (22R) 2.4 GLE, GL S/W, GLE S/W, (RX73) (22R) I.R.S. GL, GLE 4/5-Spd. Man./Auto. (87-92), (YX72) (3Y) 2.0 GS, GS Exec., GSE OHV 5-Spd. Man. (89-92), HiAce (YH50) (2Y) 1.8 SWB P/van 4-Spd. Man. Pet., (YH60) (2Y) 1.8 LWB LS Wagon, P/van 5-Spd. Man. Pet. (83-91), (YH53) (4Y) 2.2 SWB LS, GLX, GLX Exec. Wagon, Super10, (YH63) (4Y) 2.2 LWB Super16, Super16, P/van, Siyaya Pet. 5-Spd. Man., 4-Spd. Auto. (86-09), Hilux (LN50) (L) 2.2 SWB P/up Dies. 4-Spd. Man., (LN51) (2L) 2.4 SWB S D/cab, Raider P/up Dies., (LN55) (L) 2.2 LWB P/up Dies., (LN56) (2L) 2.4 LWB Raider, D/cab P/up Dies. (84-98), (YN58) (4Y) 2.2 LWB Raider, SRX P/up Pet. (84-98), (LN51) (2L) 2.4 SWB S D/cab, Raider P/up Dies. (84-98), (LN56) (2L) 2.4 LWB Raider, D/cab P/up Dies. (84-98), (LN57) (3L) 2.8 LWB Raider D/cab, P/up Dies. (95-05), (LN65) (2L) 2.4 LWB D/cab, Raider, D/cab Dies. (89-98), (LN67) (3L) 2.8 LWB P/up, Raider, D/cab Dies. (95-05), (LN140) (2L) 2.4 SWB DLX P/up Dies. (98-05), (LN145) 2.4 LWB P/up Dies. (98-05), (RN58) (22R) 2.4 LWB S, S D/cab, SR D/cab, SRX, Raider Pet. (84-98), (RN67) (22R) 2.4 LWB Raider, D/cab, Raider D/cab Pet. (89-98), (YN51) (2Y) 1.8 SWB S, SR, Raider P/up Pet., 5-Spd. Man. (86-98), (YN56) (2Y) 1.8 LWB P/up 4/5-Spd. Man. Pet. (86-98), (YN58) (4Y) 2.2 LWB Raider, SRX P/up Pet. (84-98), (YN67) (4Y) 2.2 LWB Raider D/cab, D/cab P/up Pet. (85-94), (YN140) (2Y) 1.8 SWB, LWB D/cab, Raider Pet. 5-Spd. Man. (98-05), Stallion (YF50) (2Y) 1.8 P/up, (2Y) 1.8 SR5 P/up, P/van, Pet., (LF50) (2L) 2400D P/up Dies. (91-04), Venture (YF50) (2Y) 1.8 P/van, 8/10-Seater Pet., 4/5-Spd. Man., (YF51) (4Y) 2.2 10-Seater, Getaway 5-Seater, GLE 9-Seater Pet. 5-Spd. Man., (LF50) (2L) 2.4 10-Seater Dies. 5-Spd. Man. (91-04)
	AR5269 Rear Axle Beam Bush Opel Meriva (Z14XEP) 1.4 Essentia MPV, (A14NEL, B14NEL) 1.4T, (Z16XE/P) 1.6 Club, Comfort, Enjoy MPV, (Z17DT/H/R) 1.7 CDTi Elegance, Enjoy, (Z18XE) 1.8 Elegance, Easytronic MPV (03-15)
	AR5270 Exhaust Hanger - Middle, Rear Isuzu KBD-Series KBD20/21 (C190) 2.0 SWB P/up Dies., KBD22 (C223) 2.2 LE SWB P/up Dies., KBD23 (4JA1) 2.5 LE SWB P/up Dies., KBD25/26 (C190) 2.0 LWB P/up Dies., KBD27 (C223) 2.2 LWB P/up Dies., KBD28 (4JA1) 2.5 LWB P/up Dies. (78-89), KB-Series KB21 (G180Z) 1.6 SWB, Fleetside, P/up Pet. (G161Z) 1.8 SWB, P/up Pet., KB22 (180Z) 1.8 SWB P/up Pet., KB23 (200Z) 2.0 SWB P/up Pet., KB24 (4ZD1) 2.3 LE SWB P/up Pet., KB26 (G161Z) 1.6 LWB P/up Pet., (G180Z) 1.8 LWB P/up Pet., KB27 (G180Z) 1.8 LWB P/up Pet., KB29 (4ZD1) 2.3 LWB P/up Pet. (81-89), KB-Series 4X4 KB40 (G161Z) SWB P/up Pet., KB41 (G161Z), SWB P/up Pet. (G180Z) SWB P/up Pet., KB42 (G180Z) SWB P/up, KB43 (G200Z) SWB P/up Pet., KB44 (4ZD1) LE SWB P/up Pet. (79-89), KBD-Series 4X4 KBD40 (C190) SWB P/up Dies., KBD41 (C190) Dies., KBD42 (C223) Dies. (79-89), KB-Series KB160 (4ZA1) 1.6 SWB, Fleetside P/up Pet., KB200 (ZC1) 2.0 SWB, LWB, D/cab, LE, Fleetside, P/up Pet., KB220 (C22NE) 2.2 LWB D/cab, LE P/up Pet., KB230 (4ZD1) 2.3 SWB, LWB, D/cab P/up Pet., KB250D (4JA1) 2.5 SWB, LWB D/cab, LE, Fleetside, P/up Dies., KB280DT (4JB1) 2.8 SWB, LWB LE, D/cab LE, Frontier LX P/up (89-04), KB-Series 4X4 KB220 (C22NE) LWB D/cab, LE, P/up Pet., KB230 (4ZD1) SWB P/up Pet., KB250D (4JA1) SWB, LWB, D/cab, LE, LE D/cab P/up Dies., KB260 (4ZE1) LWB D/cab, LE, LX D/cab P/up (89-04), KB-Series KB260 (4ZE1) 2.6 SWB, LWB LE, LX, D/cab P/up Pet. (92-04), Relay (4ZB1) 1.8 LWB Bus, P/van Pet., (4ZC1) 2.0 SWB Bus, P/van Pet. (83-95), WFR 11/12 FVX (83-95)

ENGINE MOUNTING & RUBBER BUYERS GUIDE

	AR5273 Engine Mounting - LHS Nissan Hardbody (QW/244) (TD27i) 2.7 SE, D/C, TD LWB, S/cab, D/cab, SE P/up Dies. (98-11), Hardbody (D22, QW/244) 4X4 (KA24E) 2.4i, LWB S/cab, SL D/cab, P/up Pet., (TD27i) 2.7D, LWB S/cab, SE, D/cab, P/up Dies. (98-10), Hardbody NP300 (D22) 4X4 (KA24DE) 2.4i LWB S/C, D/C Hi Rider P/up Pet. (2008-)
	AR5276 Engine Mounting - LHS Nissan Hardbody (D22, QW/244) (ZD30) 3.0D, TD LWB Hi Rider, KingCab, Hi Rider P/up Dies., (QD32) 3.2D LWB SE, SL, SLE, D/cab P/up Dies. (98-10), Hardbody (D22, QW/244) 4X4 (QD32) 3.2D LWB SL S/cab, SE D/cab P/up Dies. (99-10)
	AR5277 Engine Mounting - RHS Nissan Hardbody (D22, QW/244) (ZD30) 3.0D, TD LWB Hi Rider, KingCab, Hi Rider P/up Dies., (QD32) 3.2D LWB SE, SL, SLE, D/cab P/up Dies. (98-10), Hardbody (D22, QW/244) 4X4 (QD32) 3.2D LWB SL S/cab, SE D/cab P/up Dies. (99-10)
	AR5291 Exhaust Hanger - Middle, Rear Volkswagen Golf II 1.3 CL 4-Spd. Man., 1.6 CSL 5-Spd. Man., 1.8 GTS 16V, CSX, GTI 8V, 16V, 5-Spd. Man., 3-Spd. Auto., 2.0 GTI 8V, Exec. 16V 5-Spd. Man. (84-92), Jetta II 1.6 CSL 5-Spd. Man., 1.8 CLi, CLi Exec., Executive, CLX, CSX 5-Spd. Man., 3-Spd. Auto., 2.0 L 16V 5-Spd. Man. (85-92)
	AR5295 Centre Bearing Rubber Toyota Venture (YF50) (2Y) 1.8 P/van, 8/10-Seater Pet., 4/5-Spd. Man., (YF51) (4Y) 2.2 10-Seater, Getaway 5-Seater, GLE 9-Seater Pet. 5-Spd. Man., (LF50) (2L) 2.4 10-Seater Dies. 5-Spd. Man. (91-04)
	AR5296 Centre Bearing Rubber Toyota Corolla (TE72) (3T) 1.8 RWD GLS, SE OHV 5-Spd. Man., 3/4-Spd. Auto. (80-85)
	AR5298 Centre Bearing Rubber Toyota Cressida (RX70) (21R) 2.0 GL, GLX, GL S/W (87-92)
	AR5299 Centre Bearing Rubber Nissan 1-Tonner Hardbody (AW/D22) 4X4 (VG30E) 3.0 V6 LWB D/cab, Twincab, Patrol P/up Pet. (88-99), Patrol (Y60) 4X4 (VG30E) 3.0 V6 LWB Twin Cab S/W Pet. (90-94)
	AR5301 Centre Bearing Rubber Toyota Dyna (YU80) (3Y) 2.0, (YU81/2/5/210) (4Y) 2.2, (RU85) (22R) 2.4, (BU81, OWU90) (11B) 3.0, (BU101/41/211) (14B) 3.7, (OWU95) (ADE314N) 3.8, (CWU90/95) (ADE364C, NBU91/96, TBU91/96, ADE364C/N) 4.0 (85-01)
	AR5303 Engine Mounting - RHS Nissan Langley 1.3, 1.5, Exa Turbo (85-88), Pulsar 1.3, 1.5 (83-85)
	AR5304 Engine Mounting - Rear Nissan Langley 1.3, 1.5, Exa Turbo (85-88), Pulsar 1.3, 1.5 Man. (83-85)
	AR5306 Tension Rod Bush Nissan E20 (J16) 1.6 SWB Bus, Coach, P/van Pet., (L18) 1.8 SWB, LWB 10, 16-Seater Bus, Coach, Coach, GL, GLE, Econolux, Ekonovan, Ekonowagon Pet. (73-96)

	AR5308 Centre Bearing Rubber Nissan E20 (J16) 1.6 SWB Bus, Coach, P/van Pet., (L18) 1.8 SWB, LWB 10, 16-Seater Bus, Coach, Coach, GL, GLE, Econolux, Ekonovan, Ekonowagon Pet. (73-96), Hardbody (QW/244) (NA20S) 2.0 SWB, LWB SL P/up Pet., (KA20) 2.0i SWB, LWB S/cab, SL, S/cab P/up Pet., (KA24) 2.4i LWB S/cab, SL S/cab, D/cab, SL D/cab, Hi Rider S/cab, D/cab P/up Pet., (TD27i) 2.7 SE, D/C, TD LWB, S/cab, D/cab, SE P/up Dies. (98-11), Hardbody (D22, QW/244) (VG30E) 3.0i V6 LWB SL P/up Pet., (ZD30) 3.0D, TD LWB Hi Rider, KingCab, Hi Rider P/up Dies., (QD32) 3.2D LWB SE, SL, SLE, D/cab P/up Dies., (VG33E) 3.3 V6 LWB Hi Rider, S/cab, D/cab, KingCab P/up Pet. (98-10), Hardbody NP300 (D22) (KA20DE) 2.0i SWB, LWB S, SE P/up Pet., (KA24DE) 2.4i LWB D/cab, D/cab Hi Rider P/up Pet., (YD25DDTi) 2.5 TDi LWB S, SE, D/C, D/C Hi Rider, P/up Dies. (2008-), Murano (Z50) 4X4 (VQ35DE) 3.5i V6, X-Tronic SUV (05-10), (Z51) 4X4 (VQ35DE) 3.5i V6, X-Tronic SUV (09-15), (Y61) 4X4 (VG30E) 3.0 V6 LWB Y60 S/W Pet., 3.0Di 6-Cyl. LWB GRX, TDi GL S/W Dies., (TD42) 4.2 6-Cyl. LWB LDF P/up, S/W Dies., 4.5 6-Cyl. LWB P/up Dies., 4.8 6-Cyl. LWB GL, GRX P/up Dies. (95-04), Sani (AW) (Z24) 2.4 LWB D/cab, Hi Rider S/W Pet., (TD25i) 2.5D LWB Custom S/W, Dies., (TD27i) 2.7D LWB MKII, Exec. S/W Dies., (VG30E) 3.0 V6 LWB D/cab, MKII, Exec. S/W Pet. (88-99), Skyline (R31) (CA20, RB20E) 2.0 GL, GLE, SGI, SGLi, (RB30E) 3.0 6-Cyl. SGLi (87-92), Terrano II 4X4 (TD27) 2.7 Dies. (00-02)
	AR5309 Centre Bearing Rubber Nissan 1-Tonner Hardbody (AW/D22) (NA16S, L16SJ) 1.6 SWB P/up Pet., (L18SR) 1.8 SWB, LWB Custom, King Cab P/up Pet., (NA20) 2.0 SWB, LWB Custom P/up Pet., (Z24) 2.4 LWB Custom, Hi Rider, Twincab, SE, SE D/cab Pet. (88-98), 1-Tonner Hardbody (AW/D22) (TD25i) 2.5D SWB, LWB, Custom, D/cab, Hi Rider, Twin Cab P/up Dies., (TD27i) 2.7D SWB, LWB, Custom, D/cab, Hi Rider, Twincab, SE D/cab P/up Dies., (VG30E) 3.0 V6 LWB SE D/cab, Hi Rider P/up Pet. (88-98), Hardbody (D22, QW/244) 4X4 (KA24E) 2.4i, LWB S/cab, SL D/cab, P/up Pet., (TD27i) 2.7D, LWB S/cab, SE, D/cab, P/up Dies., (ZD30) 3.0 V6 LWB D/cab, SE, SE D/cab, SL P/up Pet. (98-10), Hardbody (D22, QW/244) 4X4 (ZD30) 3.0TD LWB D/cab, KingCab P/up Dies., (QD32) 3.2D LWB SL S/cab, SE D/cab P/up Dies., (VG33E) 3.3i V6 LWB D/cab, Hi Rider D/cab P/up Pet. (99-10), Hardbody NP300 (D22) 4X4 (KA24DE) 2.4i LWB S/C, D/C Hi Rider P/up Pet., (YD25DDTi) 2.5 TDi LWB S, SE, D/C, D/C Hi Rider P/up Dies. (2008-), Sani 4X4 (Z22) 2.2 LWB S/W Pet., (Z24) 2.4 LWB Patrol S/W Pet. (86-94), Sani (AW) (Z24) 2.4 LWB D/cab, Hi Rider S/W Pet., (TD25i) 2.5D LWB Custom S/W, Dies., (TD27i) 2.7D LWB MKII, Exec. S/W Dies., (VG30E) 3.0 V6 LWB D/cab, MKII, Exec. S/W Pet. (88-99)
	AR5310 Centre Bearing Rubber Toyota Hilux 1.5, 1.6, 2.0, 2.2 (69-86)
	AR5311 Centre Bearing Rubber GoNow X-Space 2.2i DC, DCext., 2.8 TDX DC (07-10); GWM Steed 2.2i D/cab Lux, Multi-Wagon (07-11); Toyota Hilux (LN50) (L) 2.2 SWB P/up Dies. 4-Spd. Man. (84-98), (LN51) (2L) 2.4 SWB S D/cab, Raider P/up Dies. (84-98), (LN55) (L) 2.2 LWB P/up Dies. (84-98), (LN56) (2L) 2.4 LWB Raider, D/cab P/up Dies. (84-98), (LN57) (3L) 2.8 LWB Raider D/cab, P/up Dies. (95-05), (LN65) (2L) 2.4 LWB D/cab, Raider, D/cab Dies. (89-98), (LN67) (3L) 2.8 LWB P/up, Raider, D/cab Dies. (95-05), (RN58) (22R) 2.4 LWB S, S D/cab, SR D/cab, SRX, Raider Pet. (84-98), (RN67) (22R) 2.4 LWB Raider, D/cab, Raider D/cab Pet. (89-98), (YN51) (2Y) 1.8 SWB S, SR, Raider P/up Pet., 5-Spd. Man. (86-98), (YN56) (2Y) 1.8 LWB P/up 4/5-Spd. Man. Pet. (86-98), (YN58) (4Y) 2.2 LWB Raider, SRX P/up Pet. (84-98)
	AR5312 Centre Bearing Rubber Toyota Cressida (GX71) (1G-E) 2.0 GLi6 5-Spd. Man., Executive DOHC, (1G-FE) I.R.S. 4-Spd. Auto. (86-92), (RX72) (22R) 2.4 GLE, GL S/W, GLE S/W, (RX73) (22R) I.R.S. GL, GLE 4/5-Spd. Man./Auto. (87-92), (YX72) (3Y) 2.0 GS, GS Exec., GSE OHV 5-Spd. Man. (89-92)

ENGINE MOUNTING & RUBBER BUYERS GUIDE

 ID: 30, OD: 110, L: 367, W: 58	AR5313 Centre Bearing Rubber GoNow X-Space 4X4 2.2 iL DC, XL DCext., 2.8 TDX DCext. (07-10); GWM Steed 4X4 2.2i D/cab Lux, Multi-Wagon (07-11); Toyota Hilux (YN67) (4Y) 2.2 LWB Raider D/cab, D/cab P/up Pet. (85-94)	 ID: 19, L: 31, H: 38, W: 43	AR5326 Front Stabilizer Bar Bush Ford Cortina MKIV 1.3 L Kent, 1.6 1-Tonner SWB P/up Kent Pet., 2.0 GL, GLE Koln, 3.0 V6 1-Tonner SWB P/up Essex Pet. (77-86), Cortina MKV 1.6 1-Tonner SWB P/up Kent Pet., 2.4D 1-Tonner SWB P/up York Pet., 3.0 V6 1-Tonner SWB, LWB P/up Essex Pet. (77-86), Escort MKI / II 1.1 300 SWB P/van Kent Pet., 1.3 30/35/45 SWB P/van Kent Pet., 1.6 45 P/van SWB P/van Kent Pet. (68-81)
 ID: 11, OD: 16, L: 10	AR5315 Gear Shift Bush Nissan 1400 (A14S) 1.4 SWB P/van, P/up Pet., B140 (A14S) 1.4 SWB Deluxe, Sport, Std., CHAMP P/up Pet. (80-08)	 ID: 33, L: 27, H: 70, W: 64	AR5327 Steering Rack Mounting - LHS Ford Cortina MKIII 1.6 L SWB P/up Kent Pet., 2.0 V4 SWB P/up Koln Pet., 2.5 V6 L SWB P/up Essex Pet., (EV30) 3.0 GT, L, XL, XLE "Big Six" Essex (71-77), Cortina MKIV 1.3 L Kent, 1.6 1-Tonner SWB P/up Kent Pet., 2.0 GL, GLE Koln, 3.0 V6 1-Tonner SWB P/up Essex Pet. (77-86), Cortina MKV 1.6 1-Tonner SWB P/up Kent Pet., 2.4D 1-Tonner SWB P/up York Pet., 3.0 V6 1-Tonner SWB, LWB P/up Essex Pet. (77-86)
 ID: 9, OD: 11, L: 10	AR5316 Gear Shift Grommet Nissan 1400 (A14S) 1.4 SWB P/van, P/up Pet., B140 (A14S) 1.4 SWB Deluxe, Sport, Std., CHAMP P/up Pet. (80-08)	 ID: 34, L: 27, H: 50.5, W: 50	AR5328 Steering Rack Mounting - RHS Ford Cortina MKIII 1.6 L SWB P/up Kent Pet., 2.0 V4 SWB P/up Koln Pet., 2.5 V6 L SWB P/up Essex Pet., (EV30) 3.0 GT, L, XL, XLE "Big Six" Essex (71-77), Cortina MKIV 1.3 L Kent, 1.6 1-Tonner SWB P/up Kent Pet., 2.0 GL, GLE Koln, 3.0 V6 1-Tonner SWB P/up Essex Pet. (77-86), Cortina MKV 1.6 1-Tonner SWB P/up Kent Pet., 2.4D 1-Tonner SWB P/up York Pet., 3.0 V6 1-Tonner SWB, LWB P/up Essex Pet. (77-86)
 ID: 18, OD: 35, L: 44	AR5317 Engine Mounting - RHS Volkswagen Kombi (T2, T3) 1.9 Microbus, P/van, 2.0 Microbus, P/van, L Exec. Bus, Kamper, P/up, 2.1 Fi Caravelle, Microbus (74-04), Kombi (T3) 4X4 (DJ) 2.1 Fi Syncro Pet. (89-93)	 ID: 31, L: 27, H: 41.5, W: 37	AR5329 Steering Rack Mounting - LHS Ford Escort MKI / II 1.1 300 SWB P/van Kent Pet., 1.3 30/35/45 SWB P/van Kent Pet., 1.6 45 P/van SWB P/van Kent Pet. (68-81)
 ID: 15.5, OD: 33.5, L: 37	AR5318 Engine Mounting - LHS Volkswagen Kombi (T2, T3) 1.9 Microbus, P/van, 2.0 Microbus, P/van, L Exec. Bus, Kamper, P/up, 2.1 Fi Caravelle, Microbus (74-04), Kombi (T3) 4X4 (DJ) 2.1 Fi Syncro Pet. (89-93)	 ID: 18, OD: 42, L: 36	AR5330 Front Lower Control Arm Bush - Outer Ford Escort MKI / II 1.1 300 SWB P/van Kent Pet., 1.3 30/35/45 SWB P/van Kent Pet., 1.6 45 P/van SWB P/van Kent Pet. (68-81)
 ID: 18, OD: 35, L: 44	AR5319 Shackle Bush - Front Upper, Rear Upper & Lower Toyota Land Cruiser (FJ62) 4X4 (3F) 4.0, GX P/up Pet. 5-Spd. Man., 4-Spd. Auto., (2F) 4.2 P/up, GX Pet. 5-Spd. Man., 4-Spd. Auto. (87-90), (FJ75) 4X4 (3F) 4.0 DLX P/up Petrol 5-Spd. Man. (85-92), (HJ60) 4X4 (2H) 4.0, GX P/up Dies., (12H) 4.0 4-Spd. Man. Turbo Dies. 4-Spd. Man., Auto. (87-90), (HJ62) 4X4 (2H) 4.0, GX P/up Dies., (12H) 4.0 4-Spd. Man. Turbo Dies. 4-Spd. Man., Auto. (87-90), (HJ75) 4X4 (3F) 4.0 DLX P/up Petrol 5-Spd. Man. (85-92), (PHJ75) 4X4 4.0 DLX 236 Perkins Dies. 4-Spd. Man. (85-91)	 ID: 18, L: 32, H: 30, W: 40	AR5331 Front Stabilizer Bar Bush Toyota Hilux (LN51) (2L) 2.4 SWB S D/cab, Raider P/up Dies. (84-98), (LN56) (2L) 2.4 LWB Raider, D/cab P/up Dies. (84-98), (YN58) (4Y) 2.2 SRX P/up Pet. (84-98), (YN58) (4Y) 2.2 SRX P/up Pet. (84-98)
 ID: 15.5, OD: 33.5, L: 37	AR5320 Shackle Bush - Rear Upper & Lower Nissan E20 (J16) 1.6 SWB Bus, Coach, P/van Pet., (L18) 1.8 SWB, LWB 10, 16-Seater Bus, Coach, Coach, GL, GLE, Econolux, Ekonovan, Ekonowagon Pet. (73-96)	 ID: 12.5, L: 32, H: 32, W: 39	AR5332 Front Stabilizer Bar Bush Toyota Corolla (TE72) (3T) 1.8 RWD GLS, SE OHV 5-Spd. Man., 3/4-Spd. Auto. (80-85), Land Cruiser (FJ62) 4X4 (3F) 4.0, GX P/up Pet. 5-Spd. Man., 4-Spd. Auto., (2F) 4.2 P/up, GX Pet. 5-Spd. Man., 4-Spd. Auto. (87-90)
 ID: 18, OD: 40, L: 45	AR5321 Shackle Bush - Front, Rear Upper & Lower Toyota Land Cruiser (FJ75) 4X4 (3F) 4.0 DLX P/up Petrol 5-Spd. Man. (85-92), (FZJ75) 4X4 (1FZ-F) 4.2 GX S/W Pet. 4-Spd. Man. (90-97), (HJ75) 4X4 (3F) 4.0 DLX P/up Petrol 5-Spd. Man. (85-92), (HZJ75) 4X4 (1HZ) 4.2 P/up Dies., 4-Spd. Man. (90-97), (PHJ75) 4X4 4.0 DLX 236 Perkins Dies. 4-Spd. Man. (85-91)	 ID: 42, L: 25, H: 56, W: 56	AR5334 Transmission Mounting Toyota HiAce 1.5, 1.6, 2.0 (69-84), Hilux 1.5, 1.6 (69-72)
 ID: 42, L: 25, H: 56, W: 56	AR5324 Steering Rack Mounting - RHS Ford Cortina MKV 1-Tonner 1.6, 2.4D, 3.0 (80-86)	 ID: 14, L: 26, H: 34, W: 37	AR5335 Engine & Transmission Mounting Toyota Hilux (LN50) (L) 2.2 SWB P/up Dies. 4-Spd. Man. (84-98), Stallion (YF50) (2Y) 1.8 P/up, (2Y) 1.8 SR5 P/up, P/van, Pet., (LF50) (2L) 2400D P/up Dies. (91-95), Venture (YF50) (2Y) 1.8 P/van, 8/10-Seater Pet., 4-Spd. Man. (91-04)
 ID: 14, L: 26, H: 34, W: 37	AR5325 Front Stabilizer Bar Bush Ford Cortina MKIII 1.6 L SWB P/up Kent Pet., 2.0 V4 SWB P/up Koln Pet., 2.5 V6 L SWB P/up Essex Pet., (EV30) 3.0 GT, L, XL, XLE "Big Six" Essex (71-77)	 ID: 14, L: 26, H: 34, W: 37	AR5336 Engine Mounting - L/RHS Toyota HiAce 1.5 Bus, P/van, 1.6 P/van, Bus, Super10 (69-76), Hilux 1.5, 1.6 (69-72)











ENGINE MOUNTING & RUBBER BUYERS GUIDE

	<p>AR5337 Engine Mounting - L/RHS C.A.M Inyathi (SF491QE) 2.2i Bus, P/van (2006-), Rhino (JM491QME) 2.2i (2007-); Foton Inkunzi (BJ491EQ1) 2.2 Taxi, View (BJ491EQ1) 2.2 Taxi (07-09); Jinbei Haise 2.4 H2L 16-Seater (2007-); Toyota Condor (2Y) 1.8 Estate, TE Estate MPV Pet. (00-05), HiAce (YH50) (2Y) 1.8 SWB P/van 4-Spd. Man. Pet. (83-91), Hilux (LN65) (2L) 2.4 LWB D/cab, Raider, D/cab Dies. (89-98), (RN58) (22R) 2.4 LWB S, S D/cab, SR D/cab, SRX, Raider Pet. (84-98), (RN67) (22R) 2.4 LWB Raider, D/cab, Raider D/cab Pet. (89-98), (RZN147) (1RZ-E) 2.0 LWB SR D/cab Pet. 5-Spd. Man., (1RZ-E) 2.0 SWB SR, DLX, S, Pet. 5-Spd. Man. (98-05), (YN51) (2Y) 1.8 SWB S, SR, Raider P/up Pet., 5-Spd. Man. (86-98), (YN56) (2Y) 1.8 LWB P/up 4/5-Spd. Man. Pet. (86-98), (YN140) (2Y) 1.8 SWB, LWB D/cab, Raider Pet. 5-Spd. Man. (98-05), Stallion (YF50) (2Y) 1.8 P/up, (2Y) 1.8 SR5 P/up, P/van, Pet. (91-04), Venture (YF50) (2Y) 1.8 P/van, 8/10-Seater Pet., 4/5-Spd. Man., (YF51) (4Y) 2.2 10-Seater, Getaway 5-Seater, GLE 9-Seater Pet. 5-Spd. Man. (91-04)</p>
	<p>AR5338 Transmission Mounting Toyota Corolla (TE72) (3T) 1.8 RWD GLS, SE OHV 5-Spd. Man. (80-85)</p>
	<p>AR5339 Transmission Mounting Toyota Corolla (TE72) (3T) 1.8 RWD GLS, SE OHV 3/4-Spd. Auto. (80-85), Cressida (GX71) (1G-E) 2.0 GLi6 5-Spd. Man., Executive DOHC, (1G-FE) I.R.S. 4-Spd. Auto. (86-92), (MX73) (5M-GE) 2.8i RSi, RSi Exec. DOHC 5-Spd. Man., 4-Spd. Auto. (86-92)</p>
	<p>AR5340 Engine & Transmission Mounting GoNow X-Space 2.2i DC, D/Cext., 2.8 TDX DC (07-10); GWM Steed 2.2i D/cab Lux, Multi-Wagon (07-11); Toyota Condor (2Y) 1.8 Estate, TE Estate MPV Pet., 2.0i Estate, TE, Estate MPV, (2RZ-E) 2.4i Estate, TE, TX Estate MPV Pet. (00-05), Condor 4X2, 4X4 (2RZ-E) 2.4i Estate, TX Estate MPV Pet., 5-Spd. Man., (5L) 3.0 SWB Estate, TX Estate MPV Dies., (5L) 3.0 Estate, TE Estate MPV Dies. 5-Spd. Man. (00-05), Cressida (RX70) (21R) 2.0 GL, GLX, GL S/W, (RX72) (22R) 2.4 GLE, GL S/W, GLE S/W, (RX73) (22R) I.R.S. GL, GLE 4/5-Spd. Man./Auto. (87-92), (YX72) (3Y) 2.0 GS, GS Exec., GSE OHV 5-Spd. Man. (89-92), Hilux (LN51) (2L) 2.4 SWB S D/cab, Raider P/up Dies. (84-98), (LN55) (L) 2.2 LWB P/up Dies. (84-98), (LN56) (2L) 2.4 LWB Raider, D/cab P/up Dies. (84-98), (LN57) (3L) 2.8 LWB Raider D/cab, P/up Dies. (95-05), (LN140) (2L) 2.4 SWB DLX P/up Dies. (98-05), (LN145) 2.4 LWB P/up Dies. (98-05), (RN58) (22R) 2.4 LWB S, S D/cab, SR D/cab, SRX, Raider Pet. (84-98), (RZN194) (3RZ-FE) 2.7i LWB Legend35, Raider, Raider D/cab, Raised Body Pet. 5-Spd. Man. (98-05), (YN51) (2Y) 1.8 SWB S, SR, Raider P/up Pet., 5-Spd. Man. (86-98), (YN56) (2Y) 1.8 LWB P/up 4/5-Spd. Man. Pet. (86-98), (YN58) (4Y) 2.2 LWB Raider, SRX P/up Pet. (84-98), (YN140) (2Y) 1.8 SWB, LWB D/cab, Raider Pet. 5-Spd. Man. (98-05), Stallion (KF50) (5K) 1.5 Commuter, P/up, SR5 P/up, Bus, P/van Pet., 4/5-Spd. Man. (87-91), (YF50) (2Y) 1.8 P/up, (2Y) 1.8 SR5 P/up, P/van, Pet., (LF50) (2L) 2400D P/up Dies. (95-04), Venture (YF50) (2Y) 1.8 P/van, 8/10-Seater Pet., 5-Spd. Man., (YF51) (4Y) 2.2 10-Seater, Getaway 5-Seater, GLE 9-Seater Pet. 5-Spd. Man., (LF50) (2L) 2.4 10-Seater Dies. 5-Spd. Man. (91-04)</p>

 <p>ID: 18, OD: 39.5, L: 39</p>	<p>AR5343 Shackle Bush - Front Nissan 1-Tonner Hardbody (AW/D22) (NA16S, L16SJ) 1.6 SWB P/up Pet., (L18SR) 1.8 SWB, LWB Custom, King Cab P/up Pet., (NA20) 2.0 SWB, LWB Custom P/up Pet., (Z24) 2.4 LWB Custom, Hi Rider, Twincab, SE, SE D/cab Pet. (88-98), 1-Tonner Hardbody (AW/D22) (TD25i) 2.5D SWB, LWB, Custom, D/cab, Hi Rider, Twin Cab P/up Dies., (TD27i) 2.7D SWB, LWB, Custom, D/cab, Hi Rider, Twincab, SE D/cab P/up Dies., (VG30E) 3.0 V6 LWB SE D/cab, Hi Rider P/up Pet. (88-98), 1-Tonner Hardbody (AW/D22) 4X4 (Z24S) 2.4 LWB Custom, Patrol, Tracker P/up Pet., (TD27i) 2.7D SWB, LWB Hi Rider, Twin Cab, SE, SE D/cab P/up Dies., (VG30E) 3.0 V6 LWB D/cab, Twincab, Patrol P/up Pet. (88-99), 680 (J15) 1.5 SWB P/up Pet., (SD22) 2.2 LWB P/up Dies. (73-80), Hardbody (QW/244) (NA20S) 2.0 SWB, LWB SL P/up Pet., (KA20) 2.0i SWB, LWB S/cab, SL, S/cab P/up Pet., (KA24) 2.4i LWB S/cab, SL S/cab, D/cab, SL D/cab, Hi Rider S/cab, D/cab P/up Pet., (TD27i) 2.7 SE, D/C, TD LWB, S/cab, D/cab, SE P/up Dies. (98-11), Hardbody (D22, QW/244) (VG30E) 3.0i V6 LWB SL P/up Pet., (ZD30) 3.0D, TD LWB Hi Rider, KingCab, Hi Rider P/up Dies., (QD32) 3.2D LWB SE, SL, SLE, D/cab P/up Dies., (VG33E) 3.3 V6 LWB Hi Rider, S/cab, D/cab, KingCab P/up Pet. (98-10), Hardbody NP300 (D22) (KA20DE) 2.0i SWB, LWB S, SE P/up Pet., (KA24DE) 2.4i LWB D/cab, D/cab Hi Rider P/up Pet., (YD25DDTi) 2.5 TDi LWB S, SE, D/C, D/C Hi Rider, P/up Dies. (2008-) - Standard Body Models, Patrol (Y60) 4X4 (VG30E) 3.0 V6 LWB Twin Cab S/W Pet. (90-94), (Y61) 4X4 (VG30E) 3.0 V6 LWB Y60 S/W Pet., 3.0Di 6-Cyl. LWB GRX, TDi GL S/W Dies., (TD42) 4.2 6-Cyl. LWB LDF P/up, S/W Dies., 4.5 6-Cyl. LWB P/up Dies., 4.8 6-Cyl. LWB GL, GRX P/up Dies. (95-98), Sani 4X4 (Z22) 2.2 LWB S/W Pet., (Z24) 2.4 LWB Patrol S/W Pet. (86-94), Sani (AW) (Z24) 2.4 LWB D/cab, Hi Rider S/W Pet., (TD25i) 2.5D LWB Custom S/W, Dies., (TD27i) 2.7D LWB MKII, Exec. S/W Dies., (VG30E) 3.0 V6 LWB D/cab, MKII, Exec. S/W Pet. (88-99), Terrano II 4X4 (TD27) 2.7 Dies. (00-02)</p>
 <p>ID: 18, OD: 36, L: 52.5</p>	<p>AR5345 Front Lower Control Arm Bush - Inner & Outer Mazda B-Series B1600, B2000, B2200 (83-86)</p>
 <p>ID: 20, L: 36, H: 40, W: 49</p>	<p>AR5346 Front Stabilizer Bar Bush Mazda 323 1.3 GLC Hatchback, 1.4, 1.6 (77-81), B-Series B1600, B1800, B2000, B2200 (77-86)</p>
 <p>ID: 18, OD: 36.5, L: 45</p>	<p>AR5348 Front Upper Control Arm Bush - Inner Front & Outer Rear Isuzu KBD-Series KBD22 (C223) 2.2 LE SWB P/up Dies., KBD23 (4JA1) 2.5 LE SWB P/up Dies., KBD26 (C190) 2.0 LWB P/up Dies., KBD27 (C223) 2.2 LWB P/up Dies., KBD28 (4JA1) 2.5 LWB P/up Dies. (78-89), KB-Series KB21 (G180Z) 1.6 SWB, Fleetside, P/up Pet. (G161Z) 1.8 SWB, P/up Pet., KB22 (180Z) 1.8 SWB P/up Pet., KB23 (200Z) 2.0 SWB P/up Pet., KB24 (4ZD1) 2.3 LE SWB P/up Pet., KB26 (G161Z) 1.6 LWB P/up Pet., (G180Z) 1.8 LWB P/up Pet., KB27 (G180Z) 1.8 LWB P/up Pet., KB29 (4ZD1) 2.3 LWB P/up Pet. (81-89), KB-Series 4X4 KB40 (G161Z) SWB P/up Pet., KB41 (G161Z), SWB P/up Pet. (G180Z) SWB P/up Pet., KB42 (G180Z) SWB P/up, KB43 (G200Z) SWB P/up Pet. (81-89), KB44 (4ZD1) LE SWB P/up Pet. (87-89), KBD-Series 4X4 KBD41 (C190) Dies., KBD42 (C223) Dies. (84-87), KB-Series KB230 (4ZD1) 2.3 SWB, LWB, D/cab P/up Pet. (89-04)</p>
 <p>ID: 14.2, OD: 36, L: 64</p>	<p>AR5349 Front Lower Control Arm Bush - Inner Isuzu KBD-Series KBD22 (C223) 2.2 LE SWB P/up Dies., KBD23 (4JA1) 2.5 LE SWB P/up Dies., KBD26 (C190) 2.0 LWB P/up Dies., KBD27 (C223) 2.2 LWB P/up Dies., KBD28 (4JA1) 2.5 LWB P/up Dies. (78-89), KB-Series KB21 (G180Z) 1.6 SWB, Fleetside, P/up Pet. (G161Z) 1.8 SWB, P/up Pet., KB22 (180Z) 1.8 SWB P/up Pet., KB23 (200Z) 2.0 SWB P/up Pet., KB24 (4ZD1) 2.3 LE SWB P/up Pet., KB26 (G161Z) 1.6 LWB P/up Pet., (G180Z) 1.8 LWB P/up Pet., KB27 (G180Z) 1.8 LWB P/up Pet., KB29 (4ZD1) 2.3 LWB P/up Pet. (81-89), KB-Series 4X4 KB41 (G161Z), SWB P/up Pet. (G180Z) SWB P/up Pet., KB42 (G180Z) SWB P/up, KB43 (G200Z) SWB P/up Pet. (81-89), KBD-Series 4X4 KBD41 (C190) Dies., KBD42 (C223) Dies. (84-87)</p>





ENGINE MOUNTING & RUBBER

BUYERS GUIDE

	<p>AR5357 Transmission Mounting Nissan 620 (J15) 1.5 SWB, LWB P/up Pet. (73-80), 680 (J15) 1.5 SWB P/up Pet., (SD22) 2.2 LWB P/up Dies. (73-80), E20 (J16) 1.6 SWB Bus, Coach, P/van Pet., (L18) 1.8 SWB, LWB 10, 16-Seater Bus, Coach, Coach, GL, GLE, Econolux, Ekonovan, Ekonowagon Pet. (73-96)</p>		<p>AR5366 Engine Mounting - L/RHS GoNow X-Space 2.2i DC, DCext. (07-10), X-Space 4X4 2.2 iL DC, XL DCext. (07-10); GWM Steed 2.2i D/cab Lux, Multi-Wagon (07-11), Steed 4X4 2.2i D/cab Lux, Multi-Wagon (07-11); Toyota Conдор (2RZ-E) 2.4i Estate, TE, TX Estate MPV Pet. (00-05), Hilux (YN58) (4Y) 2.2 LWB Raider, SRX P/up Pet. (84-98), (RZN169) (3RZ-FE) 2.7i LWB P/up, Raider, Raider D/C, SRX D/C, DLX S/C, Legend35, Legend35 D/C Pet. (98-05), (RZN194) (3RZ-FE) 2.7i LWB Legend35, Raider, Raider D/cab, Raised Body Pet. 5-Spd. Man. (98-05), (YN58) (4Y) 2.2 LWB Raider, SRX P/up Pet. (84-98), (YN67) (4Y) 2.2 LWB Raider D/cab, D/cab P/up Pet. (85-94), Land Cruiser Prado 90/95 4X4 (1KZ-TE) 3.0 GX, VX S/W Dies. 5-Spd. Man., Auto. (96-02), Prado 120 4X4 (1KZ-TE) 3.0TD, VX S/W Dies., 5-Spd. Man., 4-Spd. Auto. (02-09)</p>
 <p>ID: 17.5, OD: 32, L: 37</p>	<p>AR5359 Shackle Bush - Front Ford Courier (F6) 1.6 SWB P/up Pet., (F8) 1.8 SWB, LWB P/up Ch. Cab, Std., XLT Pet., (FE) 2.0 XLT LWB P/up Pet., 2.2 D/cab, Explorer, Std., XLT, Leisure SWB, LWB P/up (F2) Pet., (R2) Dies., (WL4) 2.5D TD, Leisure LWB P/up Dies., 3.0 V6 D/cab, Std., L, Leisure, Explorer SWB, LWB P/up, Essex Pet., 3.4 V6 Leisure, D/cab SWB, LWB P/up Pet. (86-00), Courier 4X4 (WL4) 2.5D TD V6 D/cab, Leisure LWB P/up Dies., 3.0 V6 Std., XLT, D/cab, Leisure, Explorer, Exec. LWB P/up Essex Pet., 3.4 V6 Leisure D/cab LWB P/up Pet. (90-00), Ranger 1.8, XL SWB, LWB P/up Pet., 2.2, XL SWB, LWB P/up Pet., (WL4) 2.5D, TD High Trail, High Trail XL, XL D/cab, XLT Hi Trail, Super Cab XLT Hi Trail SWB, LWB P/up Dies., 4.0 V6 SubCab XLT Hi Trail, Super Cab XLT, XLE D/C, Hi Trail SWB, LWB P/up Pet. (99-10), Ranger 4X4 2.5D, TD V6 XL D/cab, XLT, SubCab, XLT Hi Trail, Super Cab XLT LWB P/up Dies., 4.0 V6 D/cab XLE, SubCab XLT Hi Trail, Super Cab XLT LWB P/up Pet. (00-10); Mazda B-Series B2600 (4G54) LWB D/cab, Magnum, Drifter, P/up Pet., B2600i LWB D/cab, Drifter SLX P/up Pet. (86-02), B3000 V6 LWB D/cab, Magnum, Drifter P/up Essex Pet., B3400 V6 LWB D/cab, Magnum P/up Pet. (86-99), B-Series 4X4 B2600 (4G54) V6 LWB D/cab Magnum, Drifter P/up Pet. (86-95), B3000 V6 LWB D/cab, Magnum, Drifter P/up Essex Pet., B3400 V6 LWB D/cab Magnum P/up Pet. (86-99), B2500D (WL4) TD LWB, D/cab, Magnum, Drifter SLX P/up Dies., B2600i V6 LWB Drifter, D/cab Drifter, SLX P/up Pet. (96-07), Drifter 1.8 SWB, LWB XL P/up Pet., 2.2 SWB, LWB XL, (WL4) 2.5TD LWB Hi Ride, S/cab, SL Hi Ride, SLE, SLX, D/cab, LX Hi Ride, P/up Dies., 2.6i LWB SL Hi Ride S/cab, SLE D/C, SLX, Hi Ride, SLX Hi Ride D/cab (00-08), Drifter 4X4 (WL4) 2.5TD LWB S/cab, D/cab, SL S/cab, SLE, SLE D/cab, SLX S/cab, SLX, D/cab P/up Dies., 2.6i V6 LWB S/cab, SL S/cab, SLE, D/cab, SLX D/cab P/up Pet. (00-08), Etude 160i, iE, iSE, Sport, 180iSE, iSX, iSX Sport (99-04)</p>	 <p>ID: 40, OD: 110, T: 10, PCD: 78 6-HOLES</p>	<p>AR5367 Propshaft Coupling BMW 1-Series (E81, E87) 116i (N45) 1.6, 118i (N46) 2.0, 120i (N46) 2.0, 130i (N52) 3.0 (04-15), (E88) 120i (N46) 2.0 (04-15), (E82) 120d (N47) 2.0 (2005-), (E87) 118d (M47) 2.0, 120d (M47) 2.0 (2005-), (E82, E88) 125i (N52, N54, N55) 3.0 Convertible, Coupe, 135i (N54, N55) 3.0 Turbo (08-14), (F20, F21) 116i (N13B16A) 1.6, 118i (B38B15A) 1.5, (N13B16A) 1.6, 120d (B47D20A) 2.0, 120i (N13B16A) 1.6, (B48B20A) 2.0, 125i (B48B20B, N20B20A) 2.0, M135i (N55B30A) 3.0 (11-19), 2-Series (F22, F23) 220d (B47D20A) 2.0 Coupe, 220i (B48B20A, N20B20A/B) 2.0 Coupe, 228i (N20B20A, N26B20A) 2.0 Coupe, 230i (B46B20B, B48B20A) 2.0 Coupe, M235i (N55B30A) 3.0 Coupe, M240i (B58B30A) 3.0 Coupe (14-19), 3-Series (E30) 316 (M10) 1.8, 316i (M40) 1.6, (M40) 1.8 Cabriolet, 318i (M40) 1.8 Cabriolet (83-92), 320i (M20, M50) 2.0, 323i (M20) 2.3, 325i (M20B25) 2.5, (M20B27) 2.7 Shadowline, iS Shadowline, Cabriolet, 333i (M30) 3.3 6-Cyl. (83-92), (E36) 325i (M50) 2.5 Dolphin Convertible, 325tds (M51) 2.5 6-Cyl. Dies., 328i (M52T) 2.8 (92-99), (E36, E37) M-Coupe (S50B32) 3.2 6-Cyl. (93-05), Z3 (M52) 2.8 Roadster, (M54) 3.0 Roadster 6-Cyl. (97-03), (E36, E46) M3 (M54) 3.0, (S50B32/4) 3.2 Convertible (93-05), (E46) 318i (M43) 1.8, (M43) 2.0 Touring SW, (N42) 2.0, 318ti (M47B) 2.0 Compact, 320d (M47D) 2.0 (98-05), 320i (M52) 2.0, (M54) 2.2, 323Ci (M52) 2.5 Coupe, 323i (M52) 2.5, 325Ci (M54) 2.5 Coupe, 325i, 325ti (M50, M54) 2.5 Touring SW, Compact (99-05), 328i (M52TU) 2.8 Coupe, 330Ci (M54) 3.0 Convertible, 330d (M57) 3.0 Dies., 330i (M54) 3.0 (99-05), (E90) 320d (M47) 2.0, 320i (N46) 2.0, 323i (N52N) 2.5, 325i (N53) 2.5, 330i (N52, N53) 3.0, 330d (M57, N57) 3.0 (05-13), (E92) 320i (N44) 2.0, 325i (N53) 2.5, 335i (N54, N55) 3.0 (02-15), (E93) 330i (N52) 3.0, 335i (N54, N55) 3.0 (05-14), (F30, F31) 316i (N13B16A) 1.6, 318i (B38A15A) 1.6, 320d (N47D20A) 2.0, 320i (B48B20A, N20B20A/B/D) 2.0, 328i (N20B20A) 2.0, 330i (B46B20A, B48B20A) 2.0, 335i (N55B30A) 3.0 (12-19), (F34) 320d GT (B47D20A, N47D20C) 2.0, 320i GT (N20B20A/B) 2.0, 328i GT (N20B20A, N26B20A) 2.0 (2015-), 4-Series (F32) 420d (B47B20A, N47D20C) 2.0 Coupe, 420i (N20B20A/B) 2.0 Coupe, 428i (N20B20A, N26B20A) 2.0 Coupe, 430i (B46B20B, B48B20B) 2.0 Coupe (2014-), (F33) 420i (N20B20B) 2.0 Cabriolet, 428i (N20B20A, N26B20A) 2.0 Cabriolet, 430i (B48B20B) 2.0 Cabriolet (2014-), (F36) 420d (B47B20A, N47D20C) 2.0 Gran Coupe, 420i (N20B20B) 2.0 Gran Coupe, 428i (N20B20A, N26B20A) 2.0 Gran Coupe, 430i (B48B20B) 2.0 Gran Coupe, 435i (N55B30A) 3.0 Gran Coupe, 440i (B58B30A) 3.0 Gran Coupe (2014-), 5-Series (E28) 520i (M20B20) 2.0, M5 (MX30) 3.5 (85-89)</p>
	<p>AR5360 Engine Mounting - L/RHS Toyota Land Cruiser 3.9, 4.2 (69-79)</p>		
	<p>AR5361 Engine Mounting - L/RHS Toyota Land Cruiser 4.2 (80-87)</p>		
 <p>ID: 43, L: 26, H: 77, W: 67</p>	<p>AR5362 Steering Rack Mounting - LHS Ford Cortina MKIV 1.3 L Kent, 1.6 1-Tonner SWB P/up Kent Pet., 2.0 GL, GLE Koln, 3.0 V6 1-Tonner SWB P/up Essex Pet. (77-86), Cortina MKV 1.6 1-Tonner SWB P/up Kent Pet., 2.4D 1-Tonner SWB P/up York Pet., 3.0 V6 1-Tonner SWB, LWB P/up Essex Pet. (77-86)</p>		
	<p>AR5363 Transmission Mounting C.A.M Inyathi (SF491QE) 2.2i Bus, P/van (2006-), Rhino (JM491QME) 2.2i (2007-); Foton Inkunzi (BJ491EQ1) 2.2 Taxi, View (BJ491EQ1) 2.2 Taxi (07-09), Thunda (491EQ1) 2.2i Taxi (2010-); Jinbei Haise 2.4 H2L 16-Seater (2007-); Toyota HiAce (YH50) (2Y) 1.8 SWB P/van 4-Spd. Man. Pet., (YH60) (2Y) 1.8 LWB LS Wagon, P/van 5-Spd. Man. Pet. (83-91), (YH53) (4Y) 2.2 SWB LS, GLX, GLX Exec. Wagon, Super10, (YH63) (4Y) 2.2 LWB Super16, SuperT, P/van, Siyaya Pet. 5-Spd. Man., 4-Spd. Auto. (86-09)</p>	 <p>ID: 25, L: 32, H: 38.3, W: 47</p>	<p>AR5368 Front & Rear Stabilizer Bar Bush, Rear Stabilizer Link Grommet Toyota HiAce (YH50) (2Y) 1.8 SWB P/van 4-Spd. Man. Pet., (YH60) (2Y) 1.8 LWB LS Wagon, P/van 5-Spd. Man. Pet. (83-91), Land Cruiser (FJ75) 4X4 (3F) 4.0 DLX P/up Petrol 5-Spd. Man. (85-92), (FZJ80) 4X4 (1FZ-FE, 1HD) 4.5 Std., GX P/up, GX, VX S/W 12V Dies. 5-Spd. Man., 4-Spd. Auto. (90-98), (FZJ105) 4X4 (1FZ-FE) 4.2 Std., GX P/up Dies. Turbo 5-Spd. Man., 4-Spd. Auto. (98-06), (HDJ80) 4X4 (1FZ-FE, 1HD) 4.5 Std., GX P/up, GX, VX S/W 12V Dies. 5-Spd. Man., 4-Spd. Auto. (90-98), (HDJ100) 4X4 (1FZ-FE) 4.5 GX, VX S/W Dies. 5-Spd. Man., 4-Spd. Auto. (98-06), (HJ75) 4X4 (3F) 4.0 DLX P/up Petrol 5-Spd. Man. (85-92), (HZJ80) 4X4 (1HZ) 4.2 Std., GX 5-Spd. Man. Dies. 4-Spd. Auto., 5-Spd. Man. (92-95), (1HD-FT) 4.2 GX, VX Dies. 5-Spd. Man., 4-Spd. Auto. (96-98), (HZJ105) 4X4 (1HZ) 4.2 GX P/up Dies. Turbo 5-Spd. Man., Auto. (98-06), (PHJ75) 4X4 4.0 DLX 236 Perkins Dies. 4-Spd. Man. (87-91)</p>
	<p>AR5365 Transmission Mounting Toyota Cressida 2.0 (81-83)</p>		





ENGINE MOUNTING & RUBBER BUYERS GUIDE

	<p>AR5369 Engine Mounting - L/RHS Foton Thunda (491EQ1) 2.2i Taxi (2010-); Toyota Cressida (YX72) (3Y) 2.0 GS, GS Exec., GSE OHV 5-Spd. Man. (89-92), HiAce (YH60) (2Y) 1.8 LWB LS Wagon, P/van 5-Spd. Man. Pet. (83-91), (YH53) (4Y) 2.2 SWB LS, GLX, GLX Exec. Wagon, Super10, (YH63) (4Y) 2.2 LWB Super16, SuperT, P/van, Siyaya Pet. 5-Spd. Man., 4-Spd. Auto. (86-09)</p>
 <p>ID: 14, OD: 40, L: 69.5</p>	<p>AR5370 Shackle Bush - Front, Rear Lower C.A.M Inyathi (SF491QE) 2.2i Bus, P/van (2006-); Isuzu KB-Series KB160 (4ZA1) 1.6 SWB, Fleetside P/up Pet., KB200 (ZC1) 2.0 SWB, LWB, D/cab, LE, Fleetside, P/up Pet., KB220 (C22NE) 2.2 LWB D/cab, LE P/up Pet., KB230 (4ZD1) 2.3 SWB, LWB, D/cab P/up Pet., KB250D (4JA1) 2.5 SWB, LWB D/cab, LE, Fleetside, P/up Dies., KB280DT (4JB1) 2.8 SWB, LWB LE, D/cab LE, Frontier LX P/up (89-04), KB-Series 4X4 KB220 (C22NE) LWB D/cab, LE, P/up Pet., KB230 (4ZD1) SWB P/up Pet., KB250D (4JA1) SWB, LWB, D/cab, LE, LE D/cab P/up Dies., KB260 (4ZE1) LWB D/cab, LE, LX D/cab P/up, KB280DT (4JB1) SWB, LWB LE, LE D/cab, LX, LX D/cab, P/up (89-04), KB-Series KB260 (4ZE1) 2.6 SWB, LWB LE, LX, D/cab P/up Pet., KB320 (6VD1) 3.2 V6 SWB, LWB LE, LX, D/cab, Frontier, Reef, Blazer P/up Pet. (92-04), KB-Series 4X4 KB320 (6VD1) V6 SWB, LWB Frontier LX, LX, LX D/cab P/up Pet. (98-04); Toyota HiAce (YH50) (2Y) 1.8 SWB P/van 4-Spd. Man. Pet., (YH60) (2Y) 1.8 LWB LS Wagon, P/van 5-Spd. Man. Pet. (83-91), (YH53) (4Y) 2.2 SWB LS, GLX, GLX Exec. Wagon, Super10, (YH63) (4Y) 2.2 LWB Super16, SuperT, P/van, Siyaya Pet. 5-Spd. Man., 4-Spd. Auto. (86-09), Hilux (LN140) (2L) 2.4 SWB DLX P/up Dies. (98-05), (LN145) 2.4 LWB P/up Dies. (98-05), (LN192) (5L) 3.0D LWB D-E DLX, Raider D/cab Raised Body Dies., (KZ-TE) 3.0iD LWB D/cab Raider, Legend35 Raider, D/cab, Raider Dies. (98-05), (RZN147) (1RZ-E) 2.0 LWB SR D/cab Pet. 5-Spd. Man., (1RZ-E) 2.0 SWB SR, DLX, S, Pet. 5-Spd. Man. (98-05), (RZN169) (3RZ-FE) 2.7i LWB P/up, Raider, Raider D/C, SRX D/C, DLX S/C, Legend35, Legend35 D/C Pet. (98-05), (RZN194) (3RZ-FE) 2.7i LWB Legend35, Raider, Raider D/cab, Raised Body Pet. 5-Spd. Man. (98-05), Hilux "REVO" 4X2 (1GD-FTV) 2.8 GD-6 Raised Body, 4X4 (2GD-FTV) 2.4 GD-6 Raised Body, (1GD-FTV) 2.8 GD-6 Raised Body (2016-)</p>
 <p>ID: 14, OD: 30, L: 70</p>	<p>AR5371 Shackle Bush - Front, Rear Upper & Lower Land Rover 88-Series II, II A/B, III 2.25 SWB P/up Pet., Dies., (OHI) 2.6 LWB P/up 6-Cyl. SE Pet., 109-Series 2.25 SWB, LWB P/up Pet., Dies., (OHI) 2.6 LWB P/up 6-Cyl. SE Pet., 110-Series (R6) 2.6 LWB P/up 6-Cyl., (ADE236) 3.5 V8 LWB "PUP" P/up Pet. (58-96)</p>
 <p>ID: 18, OD: 49, L: 57</p>	<p>AR5375 Front Lower Control Arm Bush - Inner, Front Ford Bantam (B3) 1.3 130 Explorer SWB P/up Pet., (F6) 160i, Explorer, Leisure, Sport SWB P/up Pet. (94-03), Laser 1.3 Dash, GL, L, Tracer H/B, Sedan, Tonic (86-95), (CHV-FUA) 1.4 L, (E5) 1.5 GL, GLS, Sport (91-92), (B6, F6, CVH) 1.6 i, 16, GL, Sport, Tracer H/B, Sedan, Plus, TX3 (86-91), (FE) 2.0i RS (91-94), Meteor (B3, E3) 1.3 GL, L (86-95), (CVH) 1.4 LX, (E5) 1.5 GL, GLS (86-92), (B6, F6, CVH) 1.6 16, GL, GLE, GLi, Sport (86-91), (FE) 2.0 GLE, GLi (91-94), Tracer (B3, E3) 1.3 H/B, Sedan, Tonic, Plus (95-02), (B6, F6) 1.6i 16, Sedan, Hatchback, Plus, Sport, Tonic (95-02), 323 FWD (B3) 130 Hatch, Sedan (85-05), Midge / Sting (F6) 160 i, s, Hatch, Sedan, (B6) 1.6 EGi, S, SL Hatch, Sedan, Sport, (F6) 160, i, s, Hatch, Midge, Sting, Sedan, 2.0 EGi Hatch, SLE Hatch, SLi, Sedan, (FE-2000) 200e, i Sedan, Hatch DOHC 8/16 Valve (85-05), Rustler (B3) 130 SWB Drifter, Explorer P/up Pet., (B6i, F6) 160, i SWB Explorer, Drifter P/up Pet. (94-02)</p>

 <p>ID: 18, OD: 30, L: 55</p>	<p>AR5376 Shackle Bush - Rear Upper & Lower C.A.M Inyathi (SF491QE) 2.2i Bus, P/van (2006-); GoNow X-Space 4X4 2.2 iL DC, XL DCext., 2.8 TDX DCext. (07-10); GWM Steed 4X4 2.2i D/cab Lux, Multi-Wagon (07-11); Toyota HiAce (YH50) (2Y) 1.8 SWB P/van 4-Spd. Man. Pet., (YH60) (2Y) 1.8 LWB LS Wagon, P/van 5-Spd. Man. Pet. (83-91), (YH53) (4Y) 2.2 SWB LS, GLX, GLX Exec. Wagon, Super10, (YH63) (4Y) 2.2 LWB Super16, SuperT, P/van, Siyaya Pet. 5-Spd. Man., 4-Spd. Auto. (86-09), Hilux (LN57) (3L) 2.8 LWB Raider D/cab, P/up Dies. (95-05), (LN65) (2L) 2.4 LWB D/cab, Raider, D/cab Dies. (89-98), (LN67) (3L) 2.8 LWB P/up, Raider, D/cab Dies. (95-05), (RN67) (22R) 2.4 LWB Raider, D/cab, Raider D/cab Pet. (89-98), (YN67) (4Y) 2.2 LWB Raider D/cab, D/cab P/up Pet. (85-94), Quantum (2KD-FTV) 2.5D, "Family" Bus, 10/14 Seater MPV Dies., (2TR-FE) 2.7, "Family" Bus, 10/14/15 Seater, MPV, Ses'fikile Pet. (2005-)</p>
 <p>ID: 15, OD: 33, L: 36</p>	<p>AR5377 Shackle Bush - Rear Upper & Lower Nissan 680 (J15) 1.5 SWB P/up Pet., (SD22) 2.2 LWB P/up Dies. (73-80)</p>
 <p>ID: 20, OD: 33, L: 36</p>	<p>AR5379 Shackle Bush - Rear Upper & Lower Nissan 1-Tonner Hardbody (AW/D22) (NA16S, L16SJ) 1.6 SWB P/up Pet., (L18SR) 1.8 SWB, LWB Custom, King Cab P/up Pet., (NA20) 2.0 SWB, LWB Custom P/up Pet., (Z24) 2.4 LWB Custom, Hi Rider, Twincab, SE, SE D/cab Pet. (88-98), 1-Tonner Hardbody (AW/D22) (TD25i) 2.5D SWB, LWB, Custom, D/cab, Hi Rider, Twin Cab P/up Dies., (TD27i) 2.7D SWB, LWB, Custom, D/cab, Hi Rider, Twincab, SE D/cab P/up Dies., (VG30E) 3.0 V6 LWB SE D/cab, Hi Rider P/up Pet. (88-98), 1-Tonner Hardbody (AW/D22) 4X4 (Z24S) 2.4 LWB Custom, Patrol, Tracker P/up Pet., (TD27i) 2.7D SWB, LWB Hi Rider, Twin Cab, SE, SE D/cab P/up Dies., (VG30E) 3.0 V6 LWB D/cab, Twincab, Patrol P/up Pet. (88-99), Hardbody (QW/244) (NA20S) 2.0 SWB, LWB SL P/up Pet., (KA20) 2.0i SWB, LWB S/cab, SL, S/cab P/up Pet., (KA24) 2.4i LWB S/cab, SL S/cab, D/cab, SL D/cab, Hi Rider S/cab, D/cab P/up Pet., (TD27i) 2.7 SE, D/C, TD LWB, S/cab, D/cab, SE P/up Dies. (98-11), Hardbody (D22, QW/244) (VG30E) 3.0i V6 LWB SL P/up Pet., (ZD30) 3.0D, TD LWB Hi Rider, KingCab, Hi Rider P/up Dies., (QD32) 3.2D LWB SE, SL, SLE, D/cab P/up Dies., (VG33E) 3.3 V6 LWB Hi Rider, S/cab, D/cab, KingCab P/up Pet. (98-10), Hardbody (D22, QW/244) 4X4 (KA24E) 2.4i, LWB S/cab, SL D/cab, P/up Pet., (TD27i) 2.7D, LWB S/cab, SE, D/cab, P/up Dies., (ZD30) 3.0 V6 LWB D/cab, SE, SE D/cab, SL P/up Pet. (98-10), Hardbody (D22, QW/244) 4X4 (ZD30) 3.0TD LWB D/cab, KingCab P/up Dies., (QD32) 3.2D LWB SL S/cab, SE D/cab P/up Dies., (VG33E) 3.3i V6 LWB D/cab, Hi Rider D/cab P/up Pet. (99-10), Hardbody NP300 (D22) (KA20DE) 2.0i SWB, LWB S, SE P/up Pet., (KA24DE) 2.4i LWB D/cab, D/cab Hi Rider P/up Pet., (YD25DDTi) 2.5 TDi LWB S, SE, D/C, D/C Hi Rider P/up Dies. (2008-), Navara (D40) 4X2, 4X4 (YD25DDTi) 2.5dCi LWB D/cab LE, SE, XE P/up Dies., (V9X) 3.0dCi V6 LWB D/cab, P/up Dies., (VQ40DE) 4.0i V6 LWB LE D/cab P/up Pet. (2005-), Patrol (Y60) 4X4 (VG30E) 3.0 V6 LWB Twin Cab S/W Pet. (90-94), (Y61) 4X4 (VG30E) 3.0 V6 LWB Y60 S/W Pet., 3.0Di 6-Cyl. LWB GRX, TDi GL S/W Dies., (TD42) 4.2 6-Cyl. LWB LDF P/up, S/W Dies., 4.5 6-Cyl. LWB P/up Dies., 4.8 6-Cyl. LWB GL, GRX P/up Dies. (95-04), Sani 4X4 (Z22) 2.2 LWB S/W Pet., (Z24) 2.4 LWB Patrol S/W Pet. (86-94), Sani (AW) (Z24) 2.4 LWB D/cab, Hi Rider S/W Pet., (TD25i) 2.5D LWB Custom S/W, Dies., (TD27i) 2.7D LWB MKII, Exec. S/W Dies., (VG30E) 3.0 V6 LWB D/cab, MKII, Exec. S/W Pet. (88-99), Terrano II 4X4 (TD27) 2.7 Dies. (00-02)</p>
 <p>ID: 16, OD: 34, L: 25</p>	<p>AR5380 Tension Rod Bush Nissan 1400 (A14S) 1.4 SWB P/van, P/up Pet., B140 (A14S) 1.4 SWB Deluxe, Sport, Std., CHAMP P/up Pet. (80-08)</p>
 <p>NO PICTURE AVAILABLE AT TIME OF PRINT</p>	<p>AR5381 Transmission Mounting Nissan 1400 (A14S) 1.4 SWB P/van, P/up Pet., B140 (A14S) 1.4 SWB Deluxe, Sport, Std., CHAMP P/up Pet. (80-93)</p>

ENGINE MOUNTING & RUBBER BUYERS GUIDE

	<p>AR5382 Transmission Mounting</p> <p>Nissan 1400 (A14S) 1.4 SWB P/van, P/up Pet., B140 (A14S) 1.4 SWB Deluxe, Sport, Std., CHAMP P/up Pet. (93-04)</p>
	<p>AR5383 Front Lower Control Arm Bush - Inner</p> <p>Nissan Sabre (GA16DS) 160 GX, GXi, (SR20DE) 200 GXi (94-02), Sentra (E13S) 1.3 GL, SX, (E16E/S) 1.6 GL, GX, GXE, GXEi Coupe, SGLi (87-92), (CA18DE) 1.8i 16V T/cam Coupe, Sedan Exec. (89-92), (GA14DNE/DS) 140, GX, GXi, i, Si (92-02), (GA16DNE/S) 160, GSi, GX, GXi, SE, Si (92-02), (SR20DE) 200 GSi, STi (92-02)</p>
	<p>AR5384 Front Lower Control Arm Bush - Outer</p> <p>Nissan Sentra (E13S) 1.3 GL, SX, (E16E/S) 1.6 GL, GX, GXE, GXEi Coupe, SGLi (87-92), (CA18DE) 1.8i 16V T/cam Coupe, Sedan Exec. (89-92)</p>
	<p>AR5385 Front Lower Control Arm Bush - Inner</p> <p>Nissan Langley 1.3, 1.5, Exa Turbo (85-88), Pulsar 1.3, 1.5 (83-85)</p>
	<p>AR5386 Shackle Bush - Front Upper & Lower</p> <p>Nissan 1400 (A14S) 1.4 SWB P/van, P/up Pet., B140 (A14S) 1.4 SWB Deluxe, Sport, Std., CHAMP P/up Pet. (80-08), Tiida (HR16DE) 1.6 Visia, Visia +, Acenta, (MR18DE) 1.8 Acenta (06-13)</p>
	<p>AR5387 Front Upper Control Arm Bush - Inner Front & Outer Rear</p> <p>Nissan 1-Tonner Hardbody (AW/D22) (NA16S, L16SJ) 1.6 SWB P/up Pet., (L18SR) 1.8 SWB, LWB Custom, King Cab P/up Pet., (NA20) 2.0 SWB, LWB Custom P/up Pet., (Z24) 2.4 LWB Custom, Hi Rider, Twincab, SE, SE D/cab Pet. (88-98), 1-Tonner Hardbody (AW/D22) (TD25i) 2.5D SWB, LWB, Custom, D/cab, Hi Rider, Twin Cab P/up Dies., (TD27i) 2.7D SWB, LWB, Custom, D/cab, Hi Rider, Twincab, SE D/cab P/up Dies., (VG30E) 3.0 V6 LWB SE D/cab, Hi Rider P/up Pet. (88-98), 1-Tonner Hardbody (AW/D22) 4X4 (Z24S) 2.4 LWB Custom, Patrol, Tracker P/up Pet., (TD27i) 2.7D SWB, LWB Hi Rider, Twin Cab, SE, SE D/cab P/up Dies., (VG30E) 3.0 V6 LWB D/cab, Twincab, Patrol P/up Pet. (88-99), 680 (J15) 1.5 SWB P/up Pet., (SD22) 2.2 LWB P/up Dies. (73-80), Patrol (Y60) 4X4 (VG30E) 3.0 V6 LWB Twin Cab S/W Pet. (90-94), (Y61) 4X4 (VG30E) 3.0 V6 LWB Y60 S/W Pet., 3.0Di 6-Cyl. LWB GRX, TDi GL S/W Dies., (TD42) 4.2 6-Cyl. LWB LDF P/up, S/W Dies., 4.5 6-Cyl. LWB P/up Dies., 4.8 6-Cyl. LWB GL, GRX P/up Dies. (95-98), Sani 4X4 (Z22) 2.2 LWB S/W Pet., (Z24) 2.4 LWB Patrol S/W Pet. (86-94), Sani (AW) (Z24) 2.4 LWB D/cab, Hi Rider S/W Pet., (TD25i) 2.5D LWB Custom S/W, Dies., (TD27i) 2.7D LWB MKII, Exec. S/W Dies., (VG30E) 3.0 V6 LWB D/cab, MKII, Exec. S/W Pet. (88-99), Terrano II 4X4 (TD27) 2.7 Dies. (00-02)</p>
	<p>AR5388 Tension Rod Bush</p> <p>Nissan Skyline (R31) (CA20, RB20E) 2.0 GL, GLE, SGi, SGLi, (RB30E) 3.0 6-Cyl. SGLi (87-92)</p>
	<p>AR5391 Engine Mounting - Rear</p> <p>Honda Ballade (SA4) (EN4) 1300 (84-89), Ballade (SC9) (EV2) 130 "Flip-Up Lights", (ZC1) 160i DOHC (84-89)</p>

	<p>AR5392 Tension Rod Bush</p> <p>Isuzu KBD-Series KBD20/21 (C190) 2.0 SWB P/up Dies., KBD22 (C223) 2.2 LE SWB P/up Dies., KBD23 (4JA1) 2.5 LE SWB P/up Dies., KBD25/26 (C190) 2.0 LWB P/up Dies., KBD27 (C223) 2.2 LWB P/up Dies., KBD28 (4JA1) 2.5 LWB P/up Dies. (78-89), KB-Series KB21 (G180Z) 1.6 SWB, Fleetside, P/up Pet. (G161Z) 1.8 SWB, P/up Pet., KB22 (180Z) 1.8 SWB P/up Pet., KB23 (200Z) 2.0 SWB P/up Pet., KB24 (4ZD1) 2.3 LE SWB P/up Pet., KB26 (G161Z) 1.6 LWB P/up Pet., (G180Z) 1.8 LWB P/up Pet., KB27 (G180Z) 1.8 LWB P/up Pet., KB29 (4ZD1) 2.3 LWB P/up Pet. (81-89), KB-Series 4X4 KB40 (G161Z) SWB P/up Pet., KB41 (G161Z), SWB P/up Pet. (G180Z) SWB P/up Pet., KB42 (G180Z) SWB P/up, KB43 (G200Z) SWB P/up Pet., KB44 (4ZD1) LE SWB P/up Pet. (79-89), KBD-Series 4X4 KBD40 (C190) SWB P/up Dies., KBD41 (C190) Dies., KBD42 (C223) Dies. (79-89)</p>
	<p>AR5393 Engine Mounting - Rear</p> <p>Honda Ballade (SC9) (ZC1) 160i DOHC Man. (84-89)</p>
	<p>AR5394 Shackle Bush - Rear Upper</p> <p>Ford Courier (F6) 1.6 SWB P/up Pet., (F8) 1.8 SWB, LWB P/up Ch. Cab, Std., XLT Pet., (FE) 2.0 XLT LWB P/up Pet., 2.2 D/cab, Explorer, Std., XLT, Leisure SWB, LWB P/up (F2) Pet., (R2) Dies., (WL4) 2.5D TD, Leisure LWB P/up Dies., 3.0 V6 D/cab, Std., L, Leisure, Explorer SWB, LWB P/up, Essex Pet., 3.4 V6 Leisure, D/cab SWB, LWB P/up Pet. (86-00), Courier 4X4 (WL4) 2.5D TD V6 D/cab, Leisure LWB P/up Dies., 3.0 V6 Std., XLT, D/cab, Leisure, Explorer, Exec. LWB P/up Essex Pet., 3.4 V6 Leisure D/cab LWB P/up Pet. (90-00), Everest 4X2, 4X4 3.0 TDCi (09-15), Ranger 1.8, XL SWB, LWB P/up Pet., 2.2, XL SWB, LWB P/up Pet., (WL4) 2.5D, TD High Trail, High Trail XL, XL D/cab, XLT Hi Trail, Super Cab XLT Hi Trail SWB, LWB P/up Dies., 4.0 V6 SubCab XLT Hi Trail, Super Cab XLT, XLE D/C, Hi Trail SWB, LWB P/up Pet. (99-10), Ranger 4X4 2.5D, TD V6 XL D/cab, XLT, SubCab, XLT Hi Trail, Super Cab XLT LWB P/up Dies., 4.0 V6 D/cab XLE, SubCab XLT Hi Trail, Super Cab XLT LWB P/up Pet. (00-10), Ranger 2.5D TD XL D/cab, XLT, SubCab, XLT Hi Trail, Super Cab XLT LWB P/up Dies., 3.0 TDCi D/cab XLE, SubCab XLT, Hi Trail, Super Cab XLT LWB P/up Dies. (07-12), Ranger 4X4 2.5D TD XL D/cab, XLT, SubCab, XLT Hi Trail, Super Cab XLT LWB P/up Dies. (07-12); Mazda B-Series B2600 (4G54) LWB D/cab, Magnum, Drifter, P/up Pet., B2600i LWB D/cab, Drifter SLX P/up Pet. (86-02), B3000 V6 LWB D/cab, Magnum, Drifter P/up Essex Pet., B3400 V6 LWB D/cab, Magnum P/up Pet. (86-99), B-Series 4X4 B2600 (4G54) V6 LWB D/cab Magnum, Drifter P/up Pet. (86-95), B3000 V6 LWB D/cab, Magnum, Drifter P/up Essex Pet., B3400 V6 LWB D/cab Magnum P/up Pet. (86-99), B2500D (WL4) TD LWB, D/cab, Magnum, Drifter SLX P/up Dies., B2600i V6 LWB Drifter, D/cab Drifter, SLX P/up Pet. (96-07), BT-50 4X2, 4X4 2.5 TDi SLX D/cab P/up, 2.6 SLE D/cab, S/cab, P/up, (WLE7) 3.0 CRDi D/cab, SLE S/cab, CRDi SLX P/up (07-12), Drifter 1.8 SWB, LWB XL P/up Pet., 2.2 SWB, LWB XL, (WL4) 2.5TD LWB Hi Ride, S/cab, SL Hi Ride, SLE, SLX, D/cab, LX Hi Ride, P/up Dies., 2.6i LWB SL Hi Ride S/cab, SLE D/C, SLX, Hi Ride, SLX Hi Ride D/cab (00-08), Drifter 4X4 (WL4) 2.5TD LWB S/cab, D/cab, SL S/cab, SLE, SLE D/cab, SLX S/cab, SLX, D/cab P/up Dies., 2.6i V6 LWB S/cab, SL S/cab, SLE, D/cab, SLX D/cab P/up Pet. (00-08), Etude 160i, iE, iSE, iSE Sport, 180iSE, iSX, iSX Sport (99-04)</p>
	<p>AR5395 Engine Mounting - LHS</p> <p>Volkswagen Beetle 1.2, 1.3, 1.5, 1.6 (61-79)</p>
	<p>AR5396 Engine Mounting - RHS</p> <p>Volkswagen Beetle 1.2, 1.3, 1.5, 1.6 (61-79)</p>

ENGINE MOUNTING & RUBBER BUYERS GUIDE

 <p>OD: 90, W: 59</p>	<p>AR5398 Centre Bearing Rubber Only</p> <p>Isuzu KBD-Series KBD20/21 (C190) 2.0 SWB P/up Dies., KBD22 (C223) 2.2 LE SWB P/up Dies., KBD23 (4JA1) 2.5 LE SWB P/up Dies., KBD25/26 (C190) 2.0 LWB P/up Dies., KBD27 (C223) 2.2 LWB P/up Dies., KBD28 (4JA1) 2.5 LWB P/up Dies. (78-89), KB-Series KB21 (G180Z) 1.6 SWB, Fleetside, P/up Pet. (G161Z) 1.8 SWB, P/up Pet., KB22 (180Z) 1.8 SWB P/up Pet., KB23 (200Z) 2.0 SWB P/up Pet., KB24 (4ZD1) 2.3 LE SWB P/up Pet., KB26 (G161Z) 1.6 LWB P/up Pet., (G180Z) 1.8 LWB P/up Pet., KB27 (G180Z) 1.8 LWB P/up Pet., KB29 (4ZD1) 2.3 LWB P/up Pet. (81-89), KB-Series 4X4 KB40 (G161Z) SWB P/up Pet., KB41 (G161Z), SWB P/up Pet. (G180Z) SWB P/up Pet., KB42 (G180Z) SWB P/up, KB43 (G200Z) SWB P/up Pet., KB44 (4ZD1) LE SWB P/up Pet. (79-89), KBD-Series 4X4 KBD40 (C190) SWB P/up Dies., KBD41 (C190) Dies., KBD42 (C223) Dies. (79-89), KB-Series KB160 (4ZA1) 1.6 SWB, Fleetside P/up Pet., KB200 (ZC1) 2.0 SWB, LWB, D/cab, LE, Fleetside, P/up Pet., KB220 (C22NE) 2.2 LWB D/cab, LE P/up Pet., KB230 (4ZD1) 2.3 SWB, LWB, D/cab P/up Pet., KB250D (4JA1) 2.5 SWB, LWB D/cab, LE, Fleetside, P/up Dies., KB280DT (4JB1) 2.8 SWB, LWB LE, D/cab LE, Frontier LX P/up (89-04), KB-Series 4X4 KB220 (C22NE) LWB D/cab, LE, P/up Pet., KB230 (4ZD1) SWB P/up Pet., KB250D (4JA1) SWB, LWB, D/cab, LE, LE D/cab P/up Dies., KB260 (4ZE1) LWB D/cab, LE, LX D/cab P/up, KB280DT (4JB1) SWB, LWB LE, LE D/cab, LX, LX D/cab, P/up (-1998), KB-Series KB260 (4ZE1) 2.6 SWB, LWB LE, LX, D/cab P/up Pet., KB320 (6VD1) 3.2 V6 SWB, LWB LE, LX, D/cab, Frontier, Reef, Blazer P/up Pet. (92-98), Relay (4ZB1) 1.8 LWB Bus, P/van Pet., (4ZC1) 2.0 SWB Bus, P/van Pet. (83-95), WFR 11/12 FVX (83-95)</p>
 <p>ID: 25</p>	<p>AR5398B Centre Bearing Rubber - Complete</p> <p>Isuzu KBD-Series KBD20/21 (C190) 2.0 SWB P/up Dies., KBD22 (C223) 2.2 LE SWB P/up Dies., KBD23 (4JA1) 2.5 LE SWB P/up Dies., KBD25/26 (C190) 2.0 LWB P/up Dies., KBD27 (C223) 2.2 LWB P/up Dies., KBD28 (4JA1) 2.5 LWB P/up Dies. (78-89), KB-Series KB21 (G180Z) 1.6 SWB, Fleetside, P/up Pet. (G161Z) 1.8 SWB, P/up Pet., KB22 (180Z) 1.8 SWB P/up Pet., KB23 (200Z) 2.0 SWB P/up Pet., KB24 (4ZD1) 2.3 LE SWB P/up Pet., KB26 (G161Z) 1.6 LWB P/up Pet., (G180Z) 1.8 LWB P/up Pet., KB27 (G180Z) 1.8 LWB P/up Pet., KB29 (4ZD1) 2.3 LWB P/up Pet. (81-89), KB-Series 4X4 KB40 (G161Z) SWB P/up Pet., KB41 (G161Z), SWB P/up Pet. (G180Z) SWB P/up Pet., KB42 (G180Z) SWB P/up, KB43 (G200Z) SWB P/up Pet., KB44 (4ZD1) LE SWB P/up Pet. (79-89), KBD-Series 4X4 KBD40 (C190) SWB P/up Dies., KBD41 (C190) Dies., KBD42 (C223) Dies. (79-89), KB-Series KB160 (4ZA1) 1.6 SWB, Fleetside P/up Pet., KB200 (ZC1) 2.0 SWB, LWB, D/cab, LE, Fleetside, P/up Pet., KB220 (C22NE) 2.2 LWB D/cab, LE P/up Pet., KB230 (4ZD1) 2.3 SWB, LWB, D/cab P/up Pet., KB250D (4JA1) 2.5 SWB, LWB D/cab, LE, Fleetside, P/up Dies., KB280DT (4JB1) 2.8 SWB, LWB LE, D/cab LE, Frontier LX P/up (89-04), KB-Series 4X4 KB220 (C22NE) LWB D/cab, LE, P/up Pet., KB230 (4ZD1) SWB P/up Pet., KB250D (4JA1) SWB, LWB, D/cab, LE, LE D/cab P/up Dies., KB260 (4ZE1) LWB D/cab, LE, LX D/cab P/up, KB280DT (4JB1) SWB, LWB LE, LE D/cab, LX, LX D/cab, P/up (-1998), KB-Series KB260 (4ZE1) 2.6 SWB, LWB LE, LX, D/cab P/up Pet., KB320 (6VD1) 3.2 V6 SWB, LWB LE, LX, D/cab, Frontier, Reef, Blazer P/up Pet. (92-98), Relay (4ZB1) 1.8 LWB Bus, P/van Pet., (4ZC1) 2.0 SWB Bus, P/van Pet. (83-95), WFR 11/12 FVX (83-95)</p>
 <p>ID: 10, L: 29, W: 67.4</p>	<p>AR5399 Front Lower Control Arm Bush - Inner</p> <p>Nissan 1400 (A14S) 1.4 SWB P/van, P/up Pet., B140 (A14S) 1.4 SWB Deluxe, Sport, Std., CHAMP P/up Pet. (80-08)</p>
	<p>AR5406 Brake & Clutch Pedal Rubber</p> <p>Nissan 1400 (A14S) 1.4 SWB P/van, P/up Pet., B140 (A14S) 1.4 SWB Deluxe, Sport, Std., CHAMP P/up Pet. (80-08)</p>
	<p>AR5407 Brake & Clutch Pedal Rubber</p> <p>Ford Spectron (F2) 2.2 LWB Bus, P/van Pet. (91-04); Mazda Marathon (F2) 2.2 LWB Bus, P/van Pet. (91-04); Nissan E20 (J16) 1.6 SWB Bus, Coach, P/van Pet., (L18) 1.8 SWB, LWB 10, 16-Seater Bus, Coach, Coach, GL, GLE, Econolux, Ekonovan, Ekonowagon Pet. (73-96)</p>

	<p>AR5408 Engine Mounting - L/RHS</p> <p>GoNow X-Space 2.8 TDX DC (07-10), X-Space 4X4 2.8 TDX DCext. (07-10); Toyota Condor 4X2, 4X4 (2RZ-E) 2.4i Estate, TX Estate MPV Pet., 5-Spd. Man., (5L) 3.0 SWB Estate, TX Estate MPV Dies., (5L) 3.0 Estate, TE Estate MPV Dies. 5-Spd. Man. (00-05), Hilux (LN50) (L) 2.2 SWB P/up Dies. 4-Spd. Man. (84-98), (LN51) (2L) 2.4 SWB S D/cab, Raider P/up Dies. (84-98), (LN55) (L) 2.2 LWB P/up Dies. (84-98), (LN56) (2L) 2.4 LWB Raider, D/cab P/up Dies. (84-98), (LN57) (3L) 2.8 LWB Raider D/cab, P/up Dies. (95-05), (LN67) (3L) 2.8 LWB P/up, Raider, D/cab Dies. (95-05), (LN140) (2L) 2.4 SWB DLX P/up Dies. (98-05), (LN145) 2.4 LWB P/up Dies. (98-05), (LN192) (5L) 3.0D LWB D-E DLX, Raider D/cab Raised Body Dies., (KZ-TE) 3.0iD LWB D/cab Raider, Legend35 Raider, D/cab, Raider Dies. (98-05), Stallion (LF50) (2L) 2400D P/up Dies. (91-04), Venture (LF50) (2L) 2.4 10-Seater Dies. 5-Spd. Man. (91-04)</p>
	<p>AR5409 Accelerator Pedal Rubber</p> <p>Nissan E20 (J16) 1.6 SWB Bus, Coach, P/van Pet., (L18) 1.8 SWB, LWB 10, 16-Seater Bus, Coach, Coach, GL, GLE, Econolux, Ekonovan, Ekonowagon Pet. (73-96)</p>
 <p>ID: 8, L: 14, L: 10</p>	<p>AR5410 Gear Link Grommet</p> <p>Nissan E20 (J16) 1.6 SWB Bus, Coach, P/van Pet., (L18) 1.8 SWB, LWB 10, 16-Seater Bus, Coach, Coach, GL, GLE, Econolux, Ekonovan, Ekonowagon Pet. (73-96)</p>
 <p>ID: 8, OD: 15, L: 13</p>	<p>AR5411 Gear Link Grommet</p> <p>Toyota HiAce (YH50) (2Y) 1.8 SWB P/van 4-Spd. Man. Pet., (YH60) (2Y) 1.8 LWB LS Wagon, P/van 5-Spd. Man. Pet. (83-91), (YH53) (4Y) 2.2 SWB LS, GLX, GLX Exec. Wagon, Super10, (YH63) (4Y) 2.2 LWB Super16, SuperT, P/van, Siyaya Pet. 5-Spd. Man., 4-Spd. Auto. (86-09)</p>
 <p>ID: 12, OD: 22, L: 54</p>	<p>AR5413 Front Lower Control Arm Bush - Inner, Front</p> <p>Audi A1 (CHZB) 1.0, (CBZA) 1.2 TFSi, (CAVG, CAXA) 1.4 TFSi, (CAYC) 1.6 TDI Hatch 3-Dr, Sportback, (DAJB) 1.8 (11-18), A3 (AGN) 1.8, (AGU, BFU) 1.8T (98-04); Volkswagen Beetle (9C1, 9V1) (APH/ AWU) 1.8T Coupe, (1Y7) (AEG) 2.0i Cabriolet, Coupe, HighLine, (9C1) (AEG) 2.0i Cabriolet, Coupe, HighLine (00-12), Golf II 1.3 CL 4-Spd. Man., 1.6 CSL 5-Spd. Man., 1.8 GTS 16V, CSX, GTi 8V, 16V, 5-Spd. Man., 3-Spd. Auto., 2.0 GTi 8V, Exec. 16V 5-Spd. Man. (84-92), Golf III 1.6 GS 5-Spd. Man., 1.8 GSX, GTS 5-Spd. Man., 3-Spd. Auto., 2.0 GTi, 8V GTi Exec. 5-Spd. Man., 2.8 VR6, VR6 Exec. V6 5-Spd. Man., 4-Spd. Auto. (92-99), Golf IV 1.6i Comfortline, Std., Tiptronic, 1.8 GTi HighLine, 1.8T GTi, 1.9 TDi HighLine, Comfortline, DSG, 2.0i Cabrio, High-Line (99-04), Jetta II 1.6 CSL 5-Spd. Man., 1.8 CLi, CLi Exec., Executive, CLX, CSX 5-Spd. Man., 3-Spd. Auto., 2.0 L 16V 5-Spd. Man. (85-92), Jetta III 1.6 CSL 5-Spd. Man., 1.8 CLX, CSX 5-Spd. Man., 3-Spd. Auto., 2.0 CLi, CLi Exec. 5-Spd. Man., 2.8 VR6 Exec. V6 5-Spd. Man., 4-Spd. Auto. (92-99), Jetta IV 1.6i Comfortline Std. 5-Spd. Man., 4-Spd. Auto., 1.9 TDi HighLine 5-Spd. Man., 2.0i HighLine 5-Spd. Man., 2.3 V5 5-Spd. Man. (99-05), Polo (6N) 1.4i Classic, Playa, 1.6i Classic Lux, Classic, Playa, 1.8i Classic Lux, Playa 5-Spd. Man. (96-03), Polo (CBZB) 1.2 Trendline DSG Pet., (CBZC) 1.2 TSi Comfortline Man. Pet., (CFWA) 1.2 TDi Trendline, BlueMotion Man. DSL, (CGPA, CGPB) 1.2 Man., (CTHE) 1.4 TSi GTi DSG (2010-), Polo (6C) (CJZC, CJZD) 1.2 TSi, (CDDA, CGGB, CLPA) 1.4, (CUTA, CYZB) 1.4 TDi, (CWXC) 1.5 TDi, (CFNA, CLSA) 1.6, (DAJA) 1.8 TSi, GTi (2014-), Polo (CHYA, CHYB) 1.0 Comfortline, Trendline BlueMotion Hatch (2014-), Polo (GP) (CHZB) 1.0 TSi BlueMotion 5-dr, (CHZC) 1.0 TSi Comfortline, TSi-R-Line DSG (15-17), Polo (AW1, BZ1) 1.0 TSi GT (2018-), Up (CHYB) 1.0 (2015-)</p>

ENGINE MOUNTING & RUBBER BUYERS GUIDE

 <p>ID: 17, L: 60, L: 41</p>	<p>AR5414 Front Lower Control Arm Bush - Outer, Rear</p> <p>Volkswagen Golf II 1.3 CL 4-Spd. Man., 1.6 CSL 5-Spd. Man., 1.8 GTS 16V, CSX, GTI 8V, 16V, 5-Spd. Man., 3-Spd. Auto., 2.0 GTI 8V, Exec. 16V 5-Spd. Man. (84-92), Golf III 1.6 GS 5-Spd. Man., 1.8 GSX, GTS 5-Spd. Man., 3-Spd. Auto., 2.0 GTI, 8V GTI Exec. 5-Spd. Man., 2.8 VR6, VR6 Exec. V6 5-Spd. Man., 4-Spd. Auto. (92-99), Jetta II 1.6 CSL 5-Spd. Man., 1.8 CLi, CLi Exec., Executive, CLX, CSX 5-Spd. Man., 3-Spd. Auto., 2.0 L 16V 5-Spd. Man. (85-92), Jetta III 1.6 CSL 5-Spd. Man., 1.8 CLX, CSX 5-Spd. Man., 3-Spd. Auto., 2.0 CLi, CLi Exec. 5-Spd. Man., 2.8 VR6 Exec. V6 5-Spd. Man., 4-Spd. Auto. (92-99), Jetta IV 1.6i Comfortline Std. 5-Spd. Man., 4-Spd. Auto., 1.9 TDi HighLine 5-Spd. Man., 2.0i HighLine 5-Spd. Man., 2.3 V5 5-Spd. Man. (99-05), Polo (6N) 1.4i Classic, Playa, 1.6i Classic Lux, Classic, Playa, 1.8i Classic Lux, Playa 5-Spd. Man. (96-03), Polo (CBZB) 1.2 Trendline DSG Pet., (CBZC) 1.2 TSi Comfortline Man. Pet., (CFWA) 1.2 TDi Trendline, BlueMotion Man. DSL, (CGPA, CGPB) 1.2 Man., (CTHE) 1.4 TSi GTI DSG (2010-), Polo (6C) (CJZC, CJZD) 1.2 TSi, (CDDA, CGGB, CLPA) 1.4, (CUTA, CYZB) 1.4 TDi, (CWXC) 1.5 TDi, (CFNA, CLSA) 1.6, (DAJA) 1.8 TSi, GTI (2014-), Polo (CHYA, CHYB) 1.0 Comfortline, Trendline BlueMotion Hatch (2014-), Polo (GP) (CHZB) 1.0 TSi BlueMotion 5-dr, (CHZC) 1.0 TSi Comfortline, TSi-R-Line DSG (15-17), Polo (AW1, BZ1) 1.0 TSi GT (2018-)</p>
--	--

	<p>AR5418 Brake & Clutch Pedal Rubber</p> <p>Ford Courier (F6) 1.6 SWB P/up Pet., (F8) 1.8 SWB, LWB P/up Ch. Cab, Std., XLT Pet., (FE) 2.0 XLT LWB P/up Pet., 2.2 D/cab, Explorer, Std., XLT, Leisure SWB, LWB P/up (F2) Pet., (R2) Dies., (WL4) 2.5D TD, Leisure LWB P/up Dies., 3.0 V6 D/cab, Std., L, Leisure, Explorer SWB, LWB P/up, Essex Pet., 3.4 V6 Leisure, D/cab SWB, LWB P/up Pet. (86-00), Courier 4X4 (WL4) 2.5D TD V6 D/cab, Leisure LWB P/up Dies., 3.0 V6 Std., XLT, D/cab, Leisure, Explorer, Exec. LWB P/up Essex Pet., 3.4 V6 Leisure D/cab LWB P/up Pet. (90-00); Mazda B-Series B1600 (F6) SWB Magnum P/up Pet., B1800 (F8) S/LWB Magnum, Drifter P/up Pet., B2000 (FE) LWB Magnum, Drifter P/up Pet., B2200 SWB, LWB D/cab, Magnum, Drifter P/up (F2) Pet., (R2) Dies., B2500D (WL4), TD LWB Drifter, SLX P/up Dies. (82-00), B2600 (4G54) LWB D/cab, Magnum, Drifter, P/up Pet. (86-02), B3000 V6 LWB D/cab, Magnum, Drifter P/up Essex Pet., B3400 V6 LWB D/cab, Magnum P/up Pet. (86-99), B-Series 4X4 B2600 (4G54) V6 LWB D/cab Magnum, Drifter P/up Pet. (86-95), B3000 V6 LWB D/cab, Magnum, Drifter P/up Essex Pet., B3400 V6 LWB D/cab Magnum P/up Pet. (86-99), B2500D (WL4) TD LWB, D/cab, Magnum, Drifter SLX P/up Dies. (96-07)</p>
--	---

	<p>AR5419 Engine Mounting - L/RHS</p> <p>BMW 3-Series (E30) 316 (M10) 1.8, 316i (M40) 1.6, (M40) 1.8 Cabriolet, 318i (M40) 1.8 Cabriolet (83-92)</p>
--	--

	<p>AR5420 Transmission Mounting</p> <p>BMW 3-Series (E30) 316 (M10) 1.8 - Getrag 242 (83-92)</p>
--	--

 <p>THREAD: M8 x 1.25 ID: 39/50, L: 22/68</p>	<p>AR5421 Transmission Mounting</p> <p>BMW 3-Series (E30) (M20, M50) 320i 2.0 Man. (83-92), 5-Series (E28) 528i (M30B28) 2.8 Man., 535i (M30B35) 3.5 Man., M5 (MX30) 3.5 Man. (85-89)</p>
---	---

 <p>ID: 18, OD: 60, L: 33</p>	<p>AR5422 Front Lower Control Arm Bush - Inner, Rear</p> <p>BMW 3-Series (E30) 316 (M10) 1.8, 316i (M40) 1.6, (M40) 1.8 Cabriolet, 318i (M40) 1.8 Cabriolet (83-92), (M20, M50) 320i 2.0, 323i (M20) 2.3, 325i (M20B25) 2.5, (M20B27) 2.7 Shadowline, iS Shadowline, Cabriolet, 333i (M30) 3.3 6-Cyl. (83-92), (E36) 316i (M40) 1.8 Dolphin Shape, 318i (M40) 1.8 Motorsport I / II, (M42) 1.9 S, 320i (M50) 2.0, 323i (M52) 2.5, 325i (M50) 2.5 Dolphin Convertible, 325tds (M51) 2.5 6-Cyl. Dies., 328i (M52T) 2.8 (92-00), (E36, E37) 328i (M52TU) 2.8 Dolphin Convertible, Individual (95-00), Z3 (M52) 2.8 Roadster, (M54) 3.0 Roadster 6-Cyl. (97-03), M-Coupe (S50B32) 3.2 6-Cyl. (93-05), (E36, E46) M3 (M54) 3.0, (S50B32/4) 3.2 Convertible (93-05)</p>
---	--

	<p>AR5423 Brake & Clutch Pedal Rubber</p> <p>Ford Ranger 1.8, XL SWB, LWB P/up Pet., 2.2, XL SWB, LWB P/up Pet., (WL4) 2.5D, TD High Trail, High Trail XL, XL D/cab, XLT Hi Trail, Super Cab XLT Hi Trail SWB, LWB P/up Dies., 4.0 V6 SubCab XLT Hi Trail, Super Cab XLT, XLE D/C, Hi Trail SWB, LWB P/up Pet. (99-10), Ranger 4X4 2.5D, TD V6 XL D/cab, XLT, SubCab, XLT Hi Trail, Super Cab XLT LWB P/up Dies., 4.0 V6 D/cab XLE, SubCab XLT Hi Trail, Super Cab XLT LWB P/up Pet. (00-10), Ranger 4X4 2.5D TD XL D/cab, XLT, SubCab, XLT Hi Trail, Super Cab XLT LWB P/up Dies., 3.0 TDCi D/cab XLE, SubCab XLT, Hi Trail, Super Cab XLT LWB P/up Dies. (07-12); Mazda B-Series B2600i LWB D/cab, Drifter SLX P/up Pet. (86-02), B-Series 4X4 B2600i V6 LWB Drifter, D/cab Drifter, SLX P/up Pet. (96-07), Drifter 1.8 SWB, LWB XL P/up Pet., 2.2 SWB, LWB XL, (WL4) 2.5TD LWB Hi Ride, S/cab, SL Hi Ride, SLE, SLX, D/cab, LX Hi Ride, P/up Dies., 2.6i LWB SL Hi Ride S/cab, SLE D/C, SLX, Hi Ride, SLX Hi Ride D/cab (00-08), Drifter 4X4 (WL4) 2.5TD LWB S/cab, D/cab, SL S/cab, SLE, SLE D/cab, SLX S/cab, SLX, D/cab P/up Dies., 2.6i V6 LWB S/cab, SL S/cab, SLE, D/cab, SLX D/cab P/up Pet. (00-08)</p>
---	--

 <p>ID: 17.5, L: 38, H: 43, W: 45.5</p>	<p>AR5424 Front Stabilizer Bar Bush</p> <p>BMW 3-Series (E30) 316 (M10) 1.8, 316i (M40) 1.6, (M40) 1.8 Cabriolet, 318i (M40) 1.8 Cabriolet (83-92), (M20, M50) 320i 2.0, 323i (M20) 2.3, 325i (M20B25) 2.5, (M20B27) 2.7 Shadowline, iS Shadowline, Cabriolet, 333i (M30) 3.3 6-Cyl. (83-92)</p>
--	--

 <p>OD:36/50, L: 34/70</p>	<p>AR5426 Transmission Mounting - L/RHS</p> <p>BMW 1-Series (E81, E87) 116i (N45) 1.6, 118i (N46) 2.0, 120i (N46) 2.0, 130i (N52) 3.0 (04-15), (E88) 120i (N46) 2.0 (04-15), (E82) 120d (N47) 2.0 (2005-), (E87) 118d (M47) 2.0, 120d (M47) 2.0 (2005-), (E82, E88) 125i (N52, N54, N55) 3.0 Convertible, Coupe, 135i (N54, N55) 3.0 Turbo (08-14), (E82) M-Coupe (N54T) 3.0 (11-12), 3-Series (E30) 316i (M40) 1.6, 318i (M40) 1.8 Cabriolet (83-92), 323i (M20) 2.3, 325i (M20B25) 2.5, (M20B27) 2.7 Shadowline, iS Shadowline, Cabriolet, 333i (M30) 3.3 6-Cyl. (83-92) - Auto. Models, Getrag 260., (E36) 316i (M40) 1.8 Dolphin Shape, 318i (M40) 1.8 Motorsport I / II, (M42) 1.9 S, 320i (M50) 2.0, 323i (M52) 2.5, 325i (M50) 2.5 Dolphin Convertible, 325tds (M51) 2.5 6-Cyl. Dies., 328i (M52T) 2.8 (92-00), (E36) 328i (M52TU) 2.8 Dolphin Convertible, Individual (95-00), M-Coupe (S50B32) 3.2 6-Cyl. (93-05), M3 (M54) 3.0, (S50B32/4) 3.2 Convertible (93-05), Z3 (M52) 2.8 Roadster, (M54) 3.0 Roadster 6-Cyl. (97-03), (E46) 318i (M43) 1.8, (M43) 2.0 Touring SW, (N42) 2.0, (M47B) 318ti 2.0 Compact, (M47D) 320d 2.0 (98-05), 320i (M52) 2.0, (M54) 2.2, 323Ci (M52) 2.5 Coupe, 323i (M52) 2.5, 325Ci (M54) 2.5 Coupe, 325i, 325ti (M50, M54) 2.5 Touring SW, Compact (99-05), 328i (M52TU) 2.8 Coupe, 330Ci (M54) 3.0 Convertible, 330d (M57) 3.0 Dies., 330i (M54) 3.0 (99-05), (E90) (M47) 320d 2.0, (N46) 320i 2.0 (05-13), 320d (M47) 2.0, (N46) 320i 2.0 (05-13), 320d (N47) 2.0, 330d (N57) 3.0, 335i (N55) 3.0 (2007-), (E92) 320i (N44) 2.0, 325i (N53) 2.5, 335i (N54, N55) 3.0 (02-15), (E93) 330i (N52) 3.0, 335i (N54, N55) 3.0 (05-14), 5-Series (E34) 520i (M50B20) 2.0, 525i (M50B25) 2.5, M5 (M50B35) 3.5 6-Cyl., 530i (M60B30) 3.0 V8, 535i (M30B35) 3.5 6-Cyl., 540i (M60B40) 4.0 Edition V8 (89-96), (E39) 523i (M52) 2.5, 525i (M54) 2.5, 528i (M52) 2.8, 530d (M57) 3.0 Dies., 530i (M54) 3.0 (96-04), 540i (M62) 4.4, M5 (S38) 3.6 (98-04), (S62) 4.9 V8 (99-04), 7-Series (E23) 728i (M30B28) 2.8 (78-89), (E32) 740i (M60, M62) 4.0, 750iL (M70) 5.0 V12 (88-95)</p>
---	---

 <p>THREAD: M10 x 1.5 OD: 70, L: 46/105</p>	<p>AR5427 Engine Mounting - L/RHS</p> <p>BMW 3-Series (E30) (M20, M50) 320i 2.0, 323i (M20) 2.3, 325i (M20B25) 2.5, (M20B27) 2.7 Shadowline, iS Shadowline, Cabriolet, 333i (M30) 3.3 6-Cyl. (83-92), 5-Series (E28) 520i (M20B20) 2.0 (85-89)</p>
--	---

 <p>THREAD: M10 x 1.5 OD: 50, L: 31/86</p>	<p>AR5431 Transmission Mounting</p> <p>BMW 5-Series (E28) 520i (M20B20) 2.0, 525e (M30B27) 2.5 (85-89)</p>
---	---

ENGINE MOUNTING & RUBBER BUYERS GUIDE

225

	<p>AR5435 Front Stabilizer Bar Bush BMW 5-Series (E28) 520i (M20B20) 2.0, 525e (M30B27) 2.5, 528i (M30B28) 2.8, 535i (M30B35) 3.5, M535i (M90) 3.5 6-Cyl., M5 (MX30) 3.5 (85-89)</p>	 <p>AR5486 Engine Mounting - RHS Ford Bantam 1.3 SWB P/up Kent 2V Pet., (CVH) 1.6 Leisure SWB P/up Pet. (83-86), Escort MKIII FWD 1.3 GL, L Kent, (HL16CVH) 1.6 GLE, L Sport, XR3, i, (Endura DE) 1.8i GLi Pet. - Zetec, TD Dies. (81-86)</p>
 <p>ID: 7.5, OD: 26, L: 23</p>	<p>AR5436 Front & Rear Stabilizer Link Grommet BMW 3-Series (E36, E37) M-Coupe (S50B32) 3.2 6-Cyl. (93-05), (E36, E46) M3 (M54) 3.0, (S50B32/4) 3.2 Convertible (93-05), 5-Series (E28) 520i (M20B20) 2.0, 525e (M30B27) 2.5, 528i (M30B28) 2.8, 535i (M30B35) 3.5, M535i (M90) 3.5 6-Cyl. (85-89); Toyota Hilux (LN50) (L) 2.2 SWB P/up Dies. 4-Spd. Man. (84-98), (LN51) (2L) 2.4 SWB S D/cab, Raider P/up Dies. (84-98), (LN55) (L) 2.2 LWB P/up Dies. (84-98), (LN56) (2L) 2.4 LWB Raider, D/cab P/up Dies. (84-98), (LN57) (3L) 2.8 LWB Raider D/cab, P/up Dies. (95-05), (LN140) (2L) 2.4 SWB DLX P/up Dies. (98-05), (LN145) 2.4 LWB P/up Dies. (98-05), (RN58) (22R) 2.4 LWB S, S D/cab, SR D/cab, SRX, Raider Pet. (84-98), (RZN147) (1RZ-E) 2.0 LWB SR D/cab Pet. 5-Spd. Man., (1RZ-E) 2.0 SWB SR, DLX, S, Pet. 5-Spd. Man. (98-05), (YN51) (2Y) 1.8 SWB S, SR, Raider P/up Pet., 5-Spd. Man. (86-98), (YN56) (2Y) 1.8 LWB P/up 4/5-Spd. Man. Pet. (86-98), (YN140) (2Y) 1.8 SWB, LWB D/cab, Raider Pet. 5-Spd. Man. (98-05), Land Cruiser (FJ62) 4X4 (3F) 4.0, GX P/up Pet. 5-Spd. Man., 4-Spd. Auto., (2F) 4.2 P/up, GX Pet. 5-Spd. Man., 4-Spd. Auto. (87-90), (FJ75) 4X4 (3F) 4.0 DLX P/up Petrol 5-Spd. Man. (85-92), (FJ80) 4X4 (3F-E) 4.0 GX, VX P/up Pet., 4-Spd. Auto. (90-92), (FZJ80) 4X4 (1FZ-FE, 1HD) 4.5 Std., GX P/up, GX, VX S/W 12V Dies. 5-Spd. Man., 4-Spd. Auto. (90-98), (FZJ100) 4X4 (2UZ-FE) 4.7 VX V8 Petrol 5-Spd. Man., 4-Spd. Auto. (98-03), (FZJ105) 4X4 (1FZ-FE) 4.2 Std., GX P/up Dies. Turbo 5-Spd. Man., 4-Spd. Auto. (98-06), (HDJ80) 4X4 (1FZ-FE, 1HD) 4.5 Std., GX P/up, GX, VX S/W 12V Dies. 5-Spd. Man., 4-Spd. Auto. (90-98), (HDJ100) 4X4 (2UZ-FE) 4.7 VX V8 Petrol 5-Spd. Man., 4-Spd. Auto. (98-03), (1FZ-FE) 4.5 GX, VX S/W Dies. 5-Spd. Man., 4-Spd. Auto. (98-06), (HJ60) 4X4 (2H) 4.0, GX P/up Dies., (12H) 4.0 4-Spd. Man. Turbo Dies. 4-Spd. Man., Auto. (87-90), (HJ62) 4X4 (2H) 4.0, GX P/up Dies., (12H) 4.0 4-Spd. Man. Turbo Dies. 4-Spd. Man., Auto. (87-90), (HJ75) 4X4 (3F) 4.0 DLX P/up Petrol 5-Spd. Man. (85-92), (HZJ80) 4X4 (1HZ) 4.2 Std., GX 5-Spd. Man. Dies. 4-Spd. Auto., 5-Spd. Man. (90-95), (1HD-FT) 4.2 GX, VX Dies. 5-Spd. Man., 4-Spd. Auto. (90-95), (HZJ105) 4X4 (1HZ) 4.2 GX P/up Dies. Turbo 5-Spd. Man., Auto. (98-06), (PHJ75) 4X4 4.0 DLX 236 Perkins Dies. 4-Spd. Man. (85-90), (UZJ100) 4X4 (2UZ-FE) 4.7 VX V8 Petrol 5-Spd. Man., 4-Spd. Auto. (98-03)</p>	 <p>ID: 20, L: 22, H: 42, W: 47</p> <p>AR5487 Front Stabilizer Bar Bush Ford Escort MKIII FWD 1.3 GL, L Kent, (HL16CVH) 1.6 GLE, L Sport, XR3, i, (Endura DE) 1.8i GLi Pet. - Zetec, TD Dies. (81-86)</p>
		 <p>ID: 14, OD: 22, L: 35</p> <p>AR5488 Shackle Bush - Rear Upper Ford Bantam 1.3 SWB P/up Kent 2V Pet., (CVH) 1.6 Leisure SWB P/up Pet. (83-86), (CVH, FUA) 1.4 Leisure SWB P/up Pet., (CVH) 1.6 Leisure, Nite SWB P/up Pet. (86-94), Bantam 'Boet' (CLTA) 1.3i XL, XLS SWB P/up Pet., (Zetec) 1.6i XLE, XLT, SWB P/up Pet., 1.8di XL SWB P/up Dies. (02-12); Mazda Rustler 1.3 SWB P/up Kent 2V Pet., (CVH, FUA) 1.4 SWB P/up, (CVH, LUC) 1.6 LX (86-93)</p>
		 <p>ID: 10, OD: 28, L: 41</p> <p>AR5491 Front Stabilizer Link Grommet Ford Cortina MKIII 1.6 L SWB P/up Kent Pet., 2.0 V4 SWB P/up Koln Pet., 2.5 V6 L SWB P/up Essex Pet., (EV30) 3.0 GT, L, XL, XLE "Big Six" Essex (71-77), Cortina MKIV 1.3 L Kent, 1.6 1-Tonner SWB P/up Kent Pet., 2.0 GL, GLE Koln, 3.0 V6 1-Tonner SWB P/up Essex Pet. (77-86), Cortina MKV 1.6 1-Tonner SWB P/up Kent Pet., 2.4D 1-Tonner SWB P/up York Pet., 3.0 V6 1-Tonner SWB, LWB P/up Essex Pet. (77-86)</p>
		 <p>AR5498 Transmission Mounting Ford Bantam (B3) 1.3 130 Explorer SWB P/up Pet., (F6) 160i, Explorer, Leisure, Sport SWB P/up Pet. (94-03), Laser 1.3 Dash, GL, L, Tracer H/B, Sedan, Tonic (86-95), (CHV-FUA) 1.4 L, (E5) 1.5 GL, GLS, Sport (86-92), (B6, F6, CVH) 1.6 i, 16, GL, Sport, Tracer H/B, Sedan, Plus, TX3 (86-91), (FE) 2.0i RS (91-94), Meteor (B3, E3) 1.3 GL, L (86-95), (CVH) 1.4 LX, (E5) 1.5 GL, GLS (86-92), (B6, F6, CVH) 1.6 16, GL, GLE, GLi, Sport (86-91), (FE) 2.0 GLE, GLi (91-94), Tracer (B3, E3) 1.3 H/B, Sedan, Tonic, Plus (95-02), (B6, F6) 1.6i 16, Sedan, Hatchback, Plus, Sport, Tonic (95-02); Mazda 323 FWD (E3) 1.3 S, L H/back, Sedan, (E/B3) 130 Hatch, Midge, Sting, Sedan, (E5) 1.5 GLC, L, SL, SLX, Sport Sedan, Hatchback (83-95), (B3) 130 Hatch, Sedan (85-05), Midge / Sting (F6) 160 i, s, Hatch, Sedan, (B6) 1.6 EGi, S, SL Hatch, Sedan, Sport, (F6) 160, i, iS, Hatch, Midge, Sting, Sedan, 2.0 EGi Hatch, SLE Hatch, SLi, Sedan, (FE-2000) 200e, i Sedan, Hatch DOHC 8/16 Valve (85-05), Rustler (B3) 130 SWB Drifter, Explorer P/up Pet., (B6i, F6) 160, i SWB Explorer, Drifter P/up Pet. (94-02)</p>
	<p>AR5437 Trailing Arm Bush - Front & Rear BMW 3-Series (E36, E37) M-Coupe (S50B32) 3.2 6-Cyl. (93-05), Z3 (M52) 2.8 Roadster, (M54) 3.0 Roadster 6-Cyl. (97-03), 5-Series (E28) 520i (M20B20) 2.0, 525e (M30B27) 2.5, 528i (M30B28) 2.8, 535i (M30B35) 3.5, M535i (M90) 3.5 6-Cyl., M5 (MX30) 3.5 (85-89), 7-Series (E23) 728 (M30B28) 2.8, 728i (M30B28) 2.8, 730 (M30B28) 3.0, 733i (M30B32) 3.2, 735i (M30) 3.5, 745i (S38) 3.5 6-Cyl. (78-89)</p>	<p>AR5499 Engine Mounting - Front Ford Bantam (B3) 1.3 130 Explorer SWB P/up Pet., (F6) 160i, Explorer, Leisure, Sport SWB P/up Pet. (94-03), Laser (CHV-FUA) 1.4 L, (E5) 1.5 GL, GLS, Sport (86-92), (B6, F6, CVH) 1.6 i, 16, GL, Sport, Tracer H/B, Sedan, Plus, TX3 (86-91), (FE) 2.0i RS (91-94), Meteor (CVH) 1.4 LX, (E5) 1.5 GL, GLS (86-92), (B6, F6, CVH) 1.6 16, GL, GLE, GLi, Sport (86-91), Tracer (B6, F6) 1.6i 16, Sedan, Hatchback, Plus, Sport, Tonic (95-02); Mazda 323 FWD (B3) 130 Hatch, Sedan (85-05), Midge / Sting (F6) 160 i, s, Hatch, Sedan, (B6) 1.6 EGi, S, SL Hatch, Sedan, Sport, (F6) 160, i, iS, Hatch, Midge, Sting, Sedan, 2.0 EGi Hatch, SLE Hatch, SLi, Sedan, (FE-2000) 200e, i Sedan, Hatch DOHC 8/16 Valve (85-05), Rustler (B3) 130 SWB Drifter, Explorer P/up Pet., (B6i, F6) 160, i SWB Explorer, Drifter P/up Pet. (94-02)</p>
	<p>AR5438 Rear Stabilizer Bar Bush BMW 3-Series (E36, E37) M-Coupe (S50B32) 3.2 6-Cyl. (93-05), (E36, E46) M3 (M54) 3.0, (S50B32/4) 3.2 Convertible (93-05), 5-Series (E28) 520i (M20B20) 2.0, 525e (M30B27) 2.5, 528i (M30B28) 2.8, 535i (M30B35) 3.5, M535i (M90) 3.5 6-Cyl. (85-89)</p>	 <p>ID: 12, OD: 77, W: 54</p> <p>AR5499 Engine Mounting - Front Ford Bantam (B3) 1.3 130 Explorer SWB P/up Pet., (F6) 160i, Explorer, Leisure, Sport SWB P/up Pet. (94-03), Laser (CHV-FUA) 1.4 L, (E5) 1.5 GL, GLS, Sport (86-92), (B6, F6, CVH) 1.6 i, 16, GL, Sport, Tracer H/B, Sedan, Plus, TX3 (86-91), (FE) 2.0i RS (91-94), Meteor (CVH) 1.4 LX, (E5) 1.5 GL, GLS (86-92), (B6, F6, CVH) 1.6 16, GL, GLE, GLi, Sport (86-91), Tracer (B6, F6) 1.6i 16, Sedan, Hatchback, Plus, Sport, Tonic (95-02); Mazda 323 FWD (B3) 130 Hatch, Sedan (85-05), Midge / Sting (F6) 160 i, s, Hatch, Sedan, (B6) 1.6 EGi, S, SL Hatch, Sedan, Sport, (F6) 160, i, iS, Hatch, Midge, Sting, Sedan, 2.0 EGi Hatch, SLE Hatch, SLi, Sedan, (FE-2000) 200e, i Sedan, Hatch DOHC 8/16 Valve (85-05), Rustler (B3) 130 SWB Drifter, Explorer P/up Pet., (B6i, F6) 160, i SWB Explorer, Drifter P/up Pet. (94-02)</p>
	<p>AR5439 Transmission Mounting BMW 3-Series (E30) 316 (M10) 1.8 Auto. - Getrag 240 (86-88), 5-Series (E28) 528i (M30B28) 2.8 Auto., 535i (M30B35) 3.5 Auto. (85-89)</p>	 <p>ID: 12, OD: 82, W: 75</p> <p>AR5499W Engine Mounting - Front Ford Bantam (B3) 1.3 130 Explorer SWB P/up Pet., (F6) 160i, Explorer, Leisure, Sport SWB P/up Pet. (94-03), Laser (FE) 2.0i RS (91-94), Meteor (FE) 2.0 GLE, GLi (91-94); Mazda Midge / Sting 2.0 EGi Hatch, SLE Hatch, SLi, Sedan (85-05), Rustler (B3) 130 SWB Drifter, Explorer P/up Pet., (B6i, F6) 160, i SWB Explorer, Drifter P/up Pet. (94-02)</p>
	<p>AR5442 X-Member Bar Insulator Ford Sapphire 1.6 L Kent, 2.0 GL, GLE, 2.0i GLi, GLi Exec., GLEA Koln, 3.0 V6 Ghia, GLX Essex (89-93), Sierra 1.6 GL, L, SW Kent, 2.0 GL, GL S/W, GLE, GLEA, GLi, LX Sedan, SW Koln, (Cologne) 2.3 V6 GLE, SW, 3.0 V6 GLS, GLX, LX, RS, XR6, 3.0i V6 RS Essex (83-93)</p>	<p>AR5484 Engine Mounting - Front / LHS Ford Bantam 1.3 SWB P/up Kent 2V Pet., (CVH) 1.6 Leisure SWB P/up Pet. (83-86), Escort MKIII FWD 1.3 GL, L Kent, (HL16CVH) 1.6 GLE, L Sport, XR3, i, (Endura DE) 1.8i GLi Pet. - Zetec, TD Dies. (81-86)</p>

ENGINE MOUNTING & RUBBER BUYERS GUIDE

 <p>ID: 11, OD: 76, W: 75</p>	<p>AR5500 Engine Mounting - RHS, Rear</p> <p>Ford Bantam (B3) 1.3 130 Explorer SWB P/up Pet., (F6) 160i, Explorer, Leisure, Sport SWB P/up Pet. (94-03), Laser 1.3 Dash, GL, L, Tracer H/B, Sedan, Tonic (86-95), (CHV-FUA) 1.4 L, (E5) 1.5 GL, GLS, Sport (86-92), (B6, F6, CVH) 1.6 i, 16, GL, Sport, Tracer H/B, Sedan, Plus, TX3 (86-91), (FE) 2.0i RS (91-94), Meteor (B3, E3) 1.3 GL, L (86-95), (CVH) 1.4 LX, (E5) 1.5 GL, GLS (86-92), (B6, F6, CVH) 1.6 16, GL, GLE, GLi, Sport (86-91), (FE) 2.0 GLE, GLi (91-94), Tracer (B3, E3) 1.3 H/B, Sedan, Tonic, Plus (95-02); Mazda 323 FWD (E3) 1.3 S, L H/back, Sedan, (E/B3) 130 Hatch, Midge, Sting, Sedan, (E5) 1.5 GLC, L, SL, SLX, Sport Sedan, Hatchback (81-95), (B3) 130 Hatch, Sedan (85-05), Midge / Sting (F6) 160 i, s, Hatch, Sedan, (B6) 1.6 EGi, S, SL Hatch, Sedan, Sport, (F6) 160, i, s, Hatch, Midge, Sting, Sedan, 2.0 EGi Hatch, SLE Hatch, SLi, Sedan, (FE-2000) 200e, i Sedan, Hatch DOHC 8/16 Valve (85-05), Rustler (B3) 130 SWB Drifter, Explorer P/up Pet., (B6i, F6) 160, i SWB Explorer, Drifter P/up Pet. (94-02)</p>
---	---

 <p>ID: 12.2, OD: 33, L: 56</p>	<p>AR5502 Front Lower Control Arm Bush - Inner Front & Outer Rear</p> <p>Ford Bantam (B3) 1.3 130 Explorer SWB P/up Pet. (94-03), Laser 1.3 Dash, GL, L, Tracer H/B, Sedan, Tonic (86-95), (CHV-FUA) 1.4 L, (E5) 1.5 GL, GLS, Sport (86-92), (B6, F6, CVH) 1.6 i, 16, GL, Sport, Tracer H/B, Sedan, Plus, TX3 (86-91), (FE) 2.0i RS (91-94), Meteor (B3, E3) 1.3 GL, L (86-95), (CVH) 1.4 LX, (E5) 1.5 GL, GLS (86-92), (B6, F6, CVH) 1.6 16, GL, GLE, GLi, Sport (86-91), (FE) 2.0 GLE, GLi (91-94), Tracer (B3, E3) 1.3 H/B, Sedan, Tonic, Plus (95-02), (B6, F6) 1.6i 16, Sedan, Hatchback, Plus, Sport, Tonic (95-02); Mazda 323 FWD (E3) 1.3 S, L H/back, Sedan, (E/B3) 130 Hatch, Midge, Sting, Sedan, (E5) 1.5 GLC, L, SL, SLX, Sport Sedan, Hatchback (81-95), (B3) 130 Hatch, Sedan (85-05), Midge / Sting (F6) 160 i, s, Hatch, Sedan, (B6) 1.6 EGi, S, SL Hatch, Sedan, Sport, (F6) 160, i, s, Hatch, Midge, Sting, Sedan, 2.0 EGi Hatch, SLE Hatch, SLi, Sedan, (FE-2000) 200e, i Sedan, Hatch DOHC 8/16 Valve (85-05), Rustler (B3) 130 SWB Drifter, Explorer P/up Pet., (B6i, F6) 160, i SWB Explorer, Drifter P/up Pet. (94-02)</p>
---	--

 <p>ID: 12, OD: 77, W: 54</p>	<p>AR5503 Engine Mounting - Front</p> <p>Ford Bantam (B3) 1.3 130 Explorer SWB P/up Pet., (F6) 160i, Explorer, Leisure, Sport SWB P/up Pet. (94-03), Laser 1.3 Dash, GL, L, Tracer H/B, Sedan, Tonic (86-95), (E5) 1.5 GL, GLS, Sport (86-92), (B6, F6, CVH) 1.6 i, 16, GL, Sport, Tracer H/B, Sedan, Plus, TX3 (86-91), Meteor (B3, E3) 1.3 GL, L (86-95), (E5) 1.5 GL, GLS (86-92), (B6, F6, CVH) 1.6 16, GL, GLE, GLi, Sport (86-91), Tracer (B3, E3) 1.3 H/B, Sedan, Tonic, Plus (95-02), (B6, F6) 1.6i 16, Sedan, Hatchback, Plus, Sport, Tonic (95-02); Mazda 323 FWD (E3) 1.3 S, L H/back, Sedan, (E/B3) 130 Hatch, Midge, Sting, Sedan, (E5) 1.5 GLC, L, SL, SLX, Sport Sedan, Hatchback (81-95), (B3) 130 Hatch, Sedan (85-05), Midge / Sting (F6) 160 i, s, Hatch, Sedan, (B6) 1.6 EGi, S, SL Hatch, Sedan, Sport, (F6) 160, i, s, Hatch, Midge, Sting, Sedan, 2.0 EGi Hatch, SLE Hatch, SLi, Sedan, (FE-2000) 200e, i Sedan, Hatch DOHC 8/16 Valve (85-05), Rustler (B3) 130 SWB Drifter, Explorer P/up Pet., (B6i, F6) 160, i SWB Explorer, Drifter P/up Pet. (94-02)</p>
---	---

 <p>ID: 28, L: 24, H: 48, W: 43</p>	<p>AR5504 Front Stabilizer Bar Bush</p> <p>Ford Bantam (B3) 1.3 130 Explorer SWB P/up Pet., (F6) 160i, Explorer, Leisure, Sport SWB P/up Pet. (94-03), Laser 1.3 Dash, GL, L, Tracer H/B, Sedan, Tonic (86-95), (CHV-FUA) 1.4 L, (E5) 1.5 GL, GLS, Sport (86-92), (B6, F6, CVH) 1.6 i, 16, GL, Sport, Tracer H/B, Sedan, Plus, TX3 (86-91), (FE) 2.0i RS (91-94), Meteor (B3, E3) 1.3 GL, L (86-95), (CVH) 1.4 LX, (E5) 1.5 GL, GLS (86-92), (B6, F6, CVH) 1.6 16, GL, GLE, GLi, Sport (86-91), (FE) 2.0 GLE, GLi (91-94), Tracer (B3, E3) 1.3 H/B, Sedan, Tonic, Plus (95-02), (B6, F6) 1.6i 16, Sedan, Hatchback, Plus, Sport, Tonic (95-02); Mazda 323 FWD (E3) 1.3 S, L H/back, Sedan, (E/B3) 130 Hatch, Midge, Sting, Sedan, (E5) 1.5 GLC, L, SL, SLX, Sport Sedan, Hatchback (83-95), (B3) 130 Hatch, Sedan (85-05), Midge / Sting (F6) 160 i, s, Hatch, Sedan, (B6) 1.6 EGi, S, SL Hatch, Sedan, Sport, (F6) 160, i, s, Hatch, Midge, Sting, Sedan, 2.0 EGi Hatch, SLE Hatch, SLi, Sedan, (FE-2000) 200e, i Sedan, Hatch DOHC 8/16 Valve (85-05), Rustler (B3) 130 SWB Drifter, Explorer P/up Pet., (B6i, F6) 160, i SWB Explorer, Drifter P/up Pet. (94-02)</p>
---	---

	<p>AR5504A Front Stabilizer Bar Bush</p> <p>Mazda 323 FWD (E3) 1.3 S, L H/back, Sedan, (E/B3) 130 Hatch, Midge, Sting, Sedan, (E5) 1.5 GLC, L, SL, SLX, Sport Sedan, Hatchback (81-95)</p>
---	--

 <p>ID: 16, OD: 24, H: 30, W: 29</p>	<p>AR5505 Rear Stabilizer Bar Bush</p> <p>Ford Laser (B3, E3) 1.3 Dash, GL, L, Tracer H/B, Sedan, Tonic (86-95), (CHV-FUA) 1.4 L, (E5) 1.5 GL, GLS, Sport (86-92), (B6, F6, CVH) 1.6 i, 16, GL, Sport, Tracer H/B, Sedan, Plus, TX3 (86-91), (FE) 2.0i RS (91-94), Meteor (B3, E3) 1.3 GL, L (86-95), (CVH) 1.4 LX, (E5) 1.5 GL, GLS (86-92), (B6, F6, CVH) 1.6 16, GL, GLE, GLi, Sport (86-91), (FE) 2.0 GLE, GLi (91-94); Mazda 323 FWD (E3) 1.3 S, L H/back, Sedan, (E/B3) 130 Hatch, Midge, Sting, Sedan, (E5) 1.5 GLC, L, SL, SLX, Sport Sedan, Hatchback (81-95), (B3) 130 Hatch, Sedan (85-95), Midge / Sting (F6) 160 i, s, Hatch, Sedan, (B6) 1.6 EGi, S, SL Hatch, Sedan, Sport, (F6) 160, i, s, Hatch, Midge, Sting, Sedan, 2.0 EGi Hatch, SLE Hatch, SLi, Sedan, (FE-2000) 200e, i Sedan, Hatch DOHC 8/16 Valve (85-95), 626 (F6) 1.6 L Hatch, Sedan, S Sedan, SL Hatch Man., (F8) 1.8 L Hatch, Sedan Man., (FE) 2.0 SL Hatch, EGi, Sedan, SLi 16 Valve, SLE, 12 Valve, SLX Sedan, Hatch (83-93)</p>
---	---

	<p>AR5508 Transmission Mounting - Rear RHS</p> <p>BMW 5-Series (E34) 520i (M50B20) 2.0, 525i (M50B25) 2.5 (89-96)</p>
---	--

	<p>AR5509 Engine Mounting - LHS</p> <p>BMW 5-Series (E34) 530i (M60B30) 3.0 V8, 540i (M60B40) 4.0 Edition V8 (95-96), 7-Series (E32) 730i (M60) 3.0, 740i (M60, M62) 4.0, 750iL (M70) 5.0 V12 (87-96), 8-Series (E31) 850Ci (M70) 5.0 V12 (91-94)</p>
--	--

	<p>AR5511 Engine Mounting - RHS</p> <p>BMW 5-Series (E34) 530i (M60B30) 3.0 V8, 540i (M60B40) 4.0 Edition V8 (95-96), 7-Series (E32) 730i (M60) 3.0, 740i (M60, M62) 4.0, 750iL (M70) 5.0 V12 (87-96), 8-Series (E31) 850Ci (M70) 5.0 V12 (91-94)</p>
---	--

 <p>ID: 26, L: 44, H: 56, W: 61.5</p>	<p>AR5512 Front Stabilizer Bar Bush</p> <p>Ford Sapphire 1.6 L Kent, 2.0 GL, GLE, 2.0i GLi, GLi Exec., GLEA Koln, 3.0 V6 Ghia, GLX Essex (89-93), Sierra 1.6 GL, 2.0 GL (83-93), (Cologne) 2.3 V6 GLE, SW, 3.0 V6 GLS, GLX, LX, RS, XR6, 3.0i V6 RS Essex (83-89)</p>
--	--









	<p>AR5513 Rear Lower Control Arm Bush - Inner</p> <p>Ford Sapphire 1.6 L Kent, 2.0 GL, GLE, 2.0i GLi, GLi Exec., GLEA Koln, 3.0 V6 Ghia, GLX Essex (89-93), Sierra 1.6 GL, L, SW Kent, 2.0 GL, GL S/W, GLE, GLEA, GLi, LX Sedan, SW Koln, (Cologne) 2.3 V6 GLE, SW, 3.0 V6 GLS, GLX, LX, RS, XR6, 3.0i V6 RS Essex (83-93)</p>
---	---

	<p>AR5514 Rear Lower Control Arm Bush - Outer</p> <p>Ford Sapphire 1.6 L Kent, 2.0 GL, GLE, 2.0i GLi, GLi Exec., GLEA Koln, 3.0 V6 Ghia, GLX Essex (89-93), Sierra 1.6 GL, L, SW Kent, 2.0 GL, GL S/W, GLE, GLEA, GLi, LX Sedan, SW Koln, (Cologne) 2.3 V6 GLE, SW, 3.0 V6 GLS, GLX, LX, RS, XR6, 3.0i V6 RS Essex (83-93)</p>
---	---















 <p>ID: 28 & 14, OD: 129, L: 156, BOLT HOLES: 14</p>	<p>AR5522 Propshaft Coupling</p> <p>Ford Sapphire 1.6 L Kent, 2.0 GL, GLE, 2.0i GLi, GLi Exec., GLEA Koln, 3.0 V6 Ghia, GLX Essex (89-93), Sierra 1.6 GL, L, SW Kent, 2.0 GL, GL S/W, GLE, GLEA, GLi, LX Sedan, SW Koln, (Cologne) 2.3 V6 GLE, SW, 3.0 V6 GLS, GLX, LX, RS, XR6, 3.0i V6 RS Essex (83-93)</p>
---	--

	<p>AR5523 Engine Mounting - L/RHS</p> <p>Ford Sierra 1.6 GL, 2.0 GL, (Cologne) 2.3 V6 GLE, SW, 3.0 V6 GLS, GLX, LX, RS, XR6, 3.0i V6 RS Essex (83-89)</p>
---	---



ENGINE MOUNTING & RUBBER BUYERS GUIDE

 <p>ID: 27, L: 50.5, H: 58, W: 69</p>	<p>AR5531 Front Stabilizer Bar Bush</p> <p>Ford Sapphire 1.6 L Kent, 2.0 GL, GLE, 2.0i GLi, GLi Exec., GLEA Koln, 3.0 V6 Ghia, GLX Essex (89-93), Sierra 1.6 L, 2.0 GLE, GLEA, GLi, LX (83-93), (Cologne) 2.3 V6 GLE, SW, 3.0 V6 GLS, GLX, LX, RS, XR6, 3.0i V6 RS Essex (89-93)</p>	 <p>ID: 19.8</p>	<p>AR5539R Front Lower Control Arm Bush - Outer RHS</p> <p>Fiat Palio I / II (178B5.000) 1.2 ED, EL, Go!, Paint Ltd. M657.12T, (178B3.000) 1.6 EL, ELX, HL, Weekend SW (02-10), Siena I / II (178B5.000) 1.2 EL, EL+ M657.12T, (178B3.000) 1.6 EL+, HL, ELX (02-10) - P/S</p>
	<p>AR5535 Engine Mounting - L/RHS</p> <p>Ford Courier (F6) 1.6 SWB P/up Pet., (F8) 1.8 SWB, LWB P/up Ch. Cab, Std., XLT Pet., (FE) 2.0 XLT LWB P/up Pet., 2.2 D/cab, Explorer, Std., XLT, Leisure SWB, LWB P/up (F2) Pet., (R2) Dies., (WL4) 2.5D TD, Leisure LWB P/up Dies. (86-00), Courier 4X4 (WL4) 2.5D TD V6 D/cab, Leisure LWB P/up Dies., 3.0 V6 Std., XLT, D/cab, Leisure, Explorer, Exec. LWB P/up Essex Pet., 3.4 V6 Leisure D/cab LWB P/up Pet. (90-00), Ranger 1.8, XL SWB, LWB P/up Pet., 2.2, XL SWB, LWB P/up Pet., (WL4) 2.5D, TD High Trail, High Trail XL, XL D/cab, XLT Hi Trail, Super Cab XLT Hi Trail SWB, LWB P/up Dies., 4.0 V6 SubCab XLT Hi Trail, Super Cab XLT, XLE D/C, Hi Trail SWB, LWB P/up Pet. (99-10), Ranger 4X4 2.5D, TD V6 XL D/cab, XLT, SubCab, XLT Hi Trail, Super Cab XLT LWB P/up Dies., 4.0 V6 D/cab XLE, SubCab XLT Hi Trail, Super Cab XLT LWB P/up Pet. (00-10), Ranger 2.5D TD XL D/cab, XLT, SubCab, XLT Hi Trail, Super Cab XLT LWB P/up Dies. (07-12), Ranger 4X4 2.5D TD XL D/cab, XLT, SubCab, XLT Hi Trail, Super Cab XLT LWB P/up Dies. (07-12), Spectron (F2) 2.2 LWB Bus, P/van Pet. (91-04); Kia Sportage 4X4 (FE) 2.0 SWB SUV, Wagon Pet. (98-04); Mazda B-Series B1600 (F6) SWB Magnum P/up Pet., B1800 (F8) S/LWB Magnum, Drifter P/up Pet., B2000 (FE) LWB Magnum, Drifter P/up Pet., B2200 SWB, LWB D/cab, Magnum, Drifter P/up (F2) Pet., (R2) Dies., B2500D (WL4), TD LWB Drifter, SLX P/up Dies. (82-00), B2600i LWB D/cab, Drifter SLX P/up Pet. (86-02), B-Series 4X4 B2500D (WL4) TD LWB, D/cab, Magnum, Drifter SLX P/up Dies., B2600i V6 LWB Drifter, D/cab Drifter, SLX P/up Pet. (96-07), BT-50 4X2, 4X4 2.5 Di SLX D/cab P/up, 2.6 SLE D/cab, S/cab, P/up (07-12), Drifter 1.8 SWB, LWB XL P/up Pet., 2.2 SWB, LWB XL, (WL4) 2.5TD LWB Hi Ride, S/cab, SL Hi Ride, SLE, SLX, D/cab, LX Hi Ride, P/up Dies., 2.6i LWB SL Hi Ride S/cab, SLE D/C, SLX, Hi Ride, SLX Hi Ride D/cab (00-08), Drifter 4X4 (WL4) 2.5TD LWB S/cab, D/cab, SL S/cab, SLE, SLE D/cab, SLX S/cab, SLX, D/cab P/up Dies., 2.6i V6 LWB S/cab, SL S/cab, SLE, D/cab, SLX D/cab P/up Pet. (00-08), Marathon (F2) 2.2 LWB Bus, P/van Pet. (91-04)</p>	 <p>ID: 16, OD: 34, L: 66</p>	<p>AR5540 Front Lower Control Arm Bush - Inner Front & Outer Rear</p> <p>Ford Courier 4X4 (WL4) 2.5D TD V6 D/cab, Leisure LWB P/up Dies., 3.0 V6 Std., XLT, D/cab, Leisure, Explorer, Exec. LWB P/up Essex Pet., 3.4 V6 Leisure D/cab LWB P/up Pet. (90-00), Ranger 1.8, XL SWB, LWB P/up Pet., 2.2, XL SWB, LWB P/up Pet., (WL4) 2.5D, TD High Trail, High Trail XL, XL D/cab, XLT Hi Trail, Super Cab XLT Hi Trail SWB, LWB P/up Dies., 4.0 V6 SubCab XLT Hi Trail, Super Cab XLT, XLE D/C, Hi Trail SWB, LWB P/up Pet. (99-10), Ranger 4X4 2.5D, TD V6 XL D/cab, XLT, SubCab, XLT Hi Trail, Super Cab XLT LWB P/up Dies., 4.0 V6 D/cab XLE, SubCab XLT Hi Trail, Super Cab XLT LWB P/up Pet. (00-10), Ranger 4X4 2.5D TD XL D/cab, XLT, SubCab, XLT Hi Trail, Super Cab XLT LWB P/up Dies. (07-12); Mazda B-Series B2600i LWB D/cab, Drifter SLX P/up Pet. (86-02), B3000 V6 LWB D/cab, Magnum, Drifter P/up Essex Pet., B3400 V6 LWB D/cab, Magnum P/up Pet. (86-99), B-Series 4X4 B2600 (4G54) V6 LWB D/cab Magnum, Drifter P/up Pet. (86-95), B3000 V6 LWB D/cab, Magnum, Drifter P/up Essex Pet., B3400 V6 LWB, D/cab Magnum P/up Pet. (86-99), B2500D (WL4) TD LWB, D/cab, Magnum, Drifter SLX P/up Dies., B2600i V6 LWB Drifter, D/cab Drifter, SLX P/up Pet. (96-07), Drifter 1.8 SWB, LWB XL P/up Pet., 2.2 SWB, LWB XL, (WL4) 2.5TD LWB Hi Ride, S/cab, SL Hi Ride, SLE, SLX, D/cab, LX Hi Ride, P/up Dies., 2.6i LWB SL Hi Ride S/cab, SLE D/C, SLX, Hi Ride, SLX Hi Ride D/cab (00-08) - Hi Rider Models, Drifter 4X4 (WL4) 2.5TD LWB S/cab, D/cab, SL S/cab, SLE, SLE D/cab, SLX S/cab, SLX, D/cab P/up Dies., 2.6i V6 LWB S/cab, SL S/cab, SLE, D/cab, SLX D/cab P/up Pet. (00-08)</p>
 <p>ID: 12, OD: 30.4, L: 54.5</p>	<p>AR5536 Front Lower Control Arm Bush - Inner Front</p> <p>Fiat Palio I / II (178B5.000) 1.2 ED, EL, Go!, Paint Ltd. M657.12T, (178B3.000) 1.6 EL, ELX, HL, Weekend SW (00-10), Siena I / II (178B5.000) 1.2 EL, EL+ M657.12T, (178B3.000) 1.6 EL+, HL, ELX (00-10)</p>	 <p>ID: 18, OD: 36, L: 57</p>	<p>AR5541 Front Lower Control Arm Bush - Inner</p> <p>Ford Courier (F6) 1.6 SWB P/up Pet., (F8) 1.8 SWB, LWB P/up Ch. Cab, Std., XLT Pet., (FE) 2.0 XLT LWB P/up Pet., 2.2 D/cab, Explorer, Std., XLT, Leisure SWB, LWB P/up (F2) Pet., (R2) Dies., (WL4) 2.5D TD, Leisure LWB P/up Dies. (86-00); Mazda B-Series B1600 (F6) SWB Magnum P/up Pet., B1800 (F8) S/LWB Magnum, Drifter P/up Pet. (82-00)</p>
 <p>ID: 30</p>	<p>AR5537 Centre Bearing Rubber</p> <p>Mazda B-Series B1600 (F6) SWB Magnum P/up Pet., B2000 (FE) LWB Magnum, Drifter P/up Pet., B2200 SWB, LWB D/cab, Magnum, Drifter P/up (F2) Pet., (R2) Dies. (82-00)</p>		
 <p>ID: 25, OD: 129, L: 189, W: 59</p>	<p>AR5538 Centre Bearing Rubber</p> <p>Ford Courier (F6) 1.6 SWB P/up Pet., 2.2 D/cab, Explorer, Std., XLT, Leisure SWB, LWB P/up (F2) Pet., (R2) Dies., 3.0 V6 D/cab, Std., L, Leisure, Explorer SWB, LWB P/up, Essex Pet. (86-00), Ranger 1.8, XL SWB, LWB P/up Pet. (99-10) - Standard Body; Mazda B-Series B1600 (F6) SWB Magnum P/up Pet., B1800 (F8) S/LWB Magnum, Drifter P/up Pet., B2000 (FE) LWB Magnum, Drifter P/up Pet., B2200 SWB, LWB D/cab, Magnum, Drifter P/up (F2) Pet., (R2) Dies. (82-00), B3000 V6 LWB D/cab, Magnum, Drifter P/up Essex Pet., (86-99), Drifter 1.8 SWB, LWB XL P/up Pet., 2.6i LWB SL Hi Ride S/cab, SLE D/C, SLX, Hi Ride, SLX Hi Ride D/cab (00-08)</p>		
 <p>ID: 19.8</p>	<p>AR5539L Front Lower Control Arm Bush - Outer LHS</p> <p>Fiat Palio I / II (178B5.000) 1.2 ED, EL, Go!, Paint Ltd. M657.12T, (178B3.000) 1.6 EL, ELX, HL, Weekend SW (02-10), Siena I / II (178B5.000) 1.2 EL, EL+ M657.12T, (178B3.000) 1.6 EL+, HL, ELX (02-10) - P/S</p>		

ENGINE MOUNTING & RUBBER BUYERS GUIDE

 <p>ID: 16, OD: 28, L: 45</p>	<p>AR5553 Shackle Bush - Front, Rear Lower</p> <p>Ford Husky (4G62) 1.8 1-Ton SWB P/up, P/van, Bus Pet., (4G63) 2.0 1-Ton SWB P/up, P/van, Bus Pet. (85-99); Hyundai Bakkie (4D56) 2.5i DT LWB P/up, P/van Dies., (4G54) 2.6i LWB P/van, P/up, Droptside Pet. (97-09), H100 (4D56) 2.5i DT LWB P/up, Droptside Dies., (4G54) 2.6i LWB P/van, Droptside Pet. (98-04); Mitsubishi Colt LDV (4G32) 1.6 SWB/ LWB Lo-Line K01/11 P/up Pet., (4G63) 2.0 SWB/ LWB D/cab, Hi-Line, Lo-Line K12, P/up Pet., (4D56) 2.5D LWB Hi-Line, Lo-Line D/cab K14 P/up Dies., (4G54) 2.6 LWB Hi-Line K13, P/up (94-98), Colt LDV 4X4 (4D56) 2.5D LWB Hi-Line K34 P/up Dies., (4G54) 2.6 LWB Lo-/Hi-Line K33 P/up Pet., (6G72) 3.0 V6 LWB Lo-Line D/cab, Hi-Line Rodeo K36 Pet. (94-98), Colt LDV (4D56) 2.5D LWB Hi-Line K34 P/up Dies., (4G54) 2.6 LWB Lo-Line, Hi-Line K33 P/up Pet., (6G72) 3.0 V6 LWB Lo-Line, D/cab, Hi-Line Rodeo K36 Pet. (98-09), Colt LDV (K67/77T) 2.8D, TD LWB Std. S/cab, Hi-Line S/cab Hi Rider, Hi-Line Raised Body, Pioneer D/cab Hi Rider P/up Dies., (6G72) 3.0i V6 LWB ClubCab K76T P/up Pet. (01-09), Colt LDV 4X4 (K65/75T) 2.4i LWB S/cab, Hi-Line, D/cab, Trailbuster S/cab, P/up Pet., (K77T) 2.8D LWB S/cab, P/up Dies., (K77T) 2.8TD LWB Rodeo D/cab, P/up Turbo Dies., (6G72, K76T) 3.0i V6 LWB Rodeo D/cab, ClubCab, P/up Pet. (98-09), Colt LDV 2.0 LWB P/up, 2.0i LWB Hi-Line P/up (04-09), L300 (4G32) 1.6 SWB Mini Bus, Van Pet., (4G62) 1.8 SWB/ LWB, D/S, P/U, P/up, P/van Pet., (4G62) 2.0 LWB P/up Pet. (82-01), Starwagon (4G62) 2.0 LWB S, SL, SLE P/van Pet. (82-01), Pajero 4X4 (4G54) 2.6 SWB, LWB GLS, SJ25/26/45 SUV Pet. (83-94), (4M40) 2.8TDi LWB GLS SUV V23C Dies., (6G72) 3.0 6-Cyl. SWB GLS Wagon V43W, V64W Pet. (90-01), (6G74) 3.5 V6 LWB GLS SUV V25/45W Pet. (95-01), Triton 4X2, 4X4 2.4 MPI D/cab P/up, 2.5 Di-D Clubcab P/up, 3.2 Di-D D/cab P/up, 3.5 MPI Clubcab P/up (2007-)</p>	 <p>ID: 10, OD: 32, L: 52</p>	<p>AR5561 Front & Rear Lower Control Arm Bush - Inner</p> <p>Honda Ballade (SA4) (EN4) 1300 (82-89), Ballade (SH4) (D15B3) 150 16V SOHC, (D16A9) 160i 16V SOHC, DOHC (89-92)</p>
 <p>ID: 14, OD: 36, L: 81</p>	<p>AR5554 Shackle Bush - Front</p> <p>Hyundai Bakkie (4D56) 2.5i DT LWB P/up, P/van Dies., (4G54) 2.6i LWB P/van, P/up, Droptside Pet. (97-09), H100 (4D56) 2.5i DT LWB P/up, Droptside Dies., (4G54) 2.6i LWB P/van, Droptside Pet. (98-04); Mitsubishi Colt LDV (4G32) 1.6 SWB/ LWB Lo-Line K01/11 P/up Pet., (4G63) 2.0 SWB/ LWB D/cab, Hi-Line, Lo-Line K12, P/up Pet., (4D56) 2.5D LWB Hi-Line, Lo-Line D/cab K14 P/up Dies., (4G54) 2.6 LWB Hi-Line K13, P/up (94-98), Colt LDV 4X4 (4D56) 2.5D LWB Hi-Line K34 P/up Dies., (4G54) 2.6 LWB Lo- / Hi-Line K33 P/up Pet., (6G72) 3.0 V6 LWB Lo-Line D/cab, Hi-Line Rodeo K36 Pet. (94-98), Colt LDV (4D56) 2.5D LWB Hi-Line K34 P/up Dies., (4G54) 2.6 LWB Lo-Line, Hi-Line K33 P/up Pet., (6G72) 3.0 V6 LWB Lo-Line, D/cab, Hi-Line Rodeo K36 Pet. (98-09), Colt LDV (K67/77T) 2.8D, TD LWB Std. S/cab, Hi-Line S/cab Hi Rider, Hi-Line Raised Body, Pioneer D/cab Hi Rider P/up Dies., (6G72) 3.0i V6 LWB ClubCab K76T P/up Pet. (01-09), Colt LDV 4X4 (K65/75T) 2.4i LWB S/cab, Hi-Line, D/cab, Trailbuster S/cab, P/up Pet., (K77T) 2.8D LWB S/cab, P/up Dies., (K77T) 2.8TD LWB Rodeo D/cab, P/up Turbo Dies., (6G72, K76T) 3.0i V6 LWB Rodeo D/cab, ClubCab, P/up Pet. (98-09), Colt LDV 2.0 LWB P/up, 2.0i LWB Hi-Line P/up (04-09), L300 (4G32) 1.6 SWB Mini Bus, Van Pet., (4G62) 1.8 SWB/ LWB, D/S, P/U, P/up, P/van Pet., (4G62) 2.0 LWB P/up Pet. (82-01), Starwagon (4G62) 2.0 LWB S, SL, SLE P/van Pet. (82-01), Pajero 4X4 (4M40) 2.8TDi LWB GLS SUV V23C Dies., (6G72) 3.0 6-Cyl. SWB GLS Wagon V43W, V64W Pet. (90-01), (6G74) 3.5 V6 LWB GLS SUV V25/45W Pet. (95-01)</p>	 <p>ID: 12, OD: 35, L: 33.5</p>	<p>AR5562 Front Lower Control Arm Bush - Outer</p> <p>Honda Ballade (SA4) (EN4) 1300 (82-89)</p>
	<p>AR5556 Engine Mounting - L/RHS</p> <p>Honda Ballade (SA4) (EN4) 1300 (82-89)</p>		<p>AR5564 Rear Lower Control Arm Bush - Outer</p> <p>Honda Ballade (SA4) (EN4) 1300 (82-89)</p>
 <p>ID: 26, L: 24, H: 35, W: 46</p>	<p>AR5557 Front Stabilizer Bar Bush</p> <p>Ford Ranger 4X4 2.5D, TD V6 XL D/cab, XLT, SubCab, XLT Hi Trail, Super Cab XLT LWB P/up Dies., 4.0 V6 D/cab XLE, SubCab XLT Hi Trail, Super Cab XLT LWB P/up Pet. (00-10), Ranger 4X4 2.5D TD XL D/cab, XLT, SubCab, XLT Hi Trail, Super Cab XLT LWB P/up Dies., 3.0 TDCi D/cab XLE, SubCab XLT, Hi Trail, Super Cab XLT LWB P/up Dies. (07-12); Mazda Drifter 4X4 (WL4) 2.5TD LWB S/cab, D/cab, SL S/cab, SLE, SLE D/cab, SLX S/cab, SLX, D/cab P/up Dies., 2.6i V6 LWB S/cab, SL S/cab, SLE, D/cab, SLX D/cab P/up Pet. (00-08)</p>	 <p>ID: 10, OD: 34.5, L: 47</p>	<p>AR5567 Front Upper Control Arm Bush - Inner & Outer</p> <p>Honda Ballade (SO4) (D15Z4) 150i, Series, Encore, Luxline, Spreeline, Auto., (D16Y9, 16Z) 160i Luxline, Spreeline, (B18B4) 180i Luxline (96-00), Civic (SO3) (D15Z4) 150i Luxline, Spreeline, (D16Y9) 160i Luxline, (D16A6) 160i V-TEC (96-03), Civic (SO4) (D16Z) 160i V-TEC, (B18B4) 180i Luxline, Spreeline (96-03), CR-V 4X4 (B20Z1) 2.0 SWB SUV Pet. (97-05)</p>
	<p>AR5557 Front Stabilizer Bar Bush</p> <p>Ford Ranger 4X4 2.5D, TD V6 XL D/cab, XLT, SubCab, XLT Hi Trail, Super Cab XLT LWB P/up Dies., 4.0 V6 D/cab XLE, SubCab XLT Hi Trail, Super Cab XLT LWB P/up Pet. (00-10), Ranger 4X4 2.5D TD XL D/cab, XLT, SubCab, XLT Hi Trail, Super Cab XLT LWB P/up Dies., 3.0 TDCi D/cab XLE, SubCab XLT, Hi Trail, Super Cab XLT LWB P/up Dies. (07-12); Mazda Drifter 4X4 (WL4) 2.5TD LWB S/cab, D/cab, SL S/cab, SLE, SLE D/cab, SLX S/cab, SLX, D/cab P/up Dies., 2.6i V6 LWB S/cab, SL S/cab, SLE, D/cab, SLX D/cab P/up Pet. (00-08)</p>	 <p>ID: 14, OD: 37.5, L: 50</p>	<p>AR5568 Front Lower Control Arm Bush - Inner Front</p> <p>Honda Ballade (SO4) (D15Z4) 150i, Series, Encore, Luxline, Spreeline, Auto., (D16Y9, 16Z) 160i Luxline, Spreeline, (B18B4) 180i Luxline (96-00), Civic (SO3) (D15Z4) 150i Luxline, Spreeline, (D16Y9) 160i Luxline, (D16A6) 160i V-TEC (96-03), Civic (SO4) (D16Z) 160i V-TEC, (B18B4) 180i Luxline, Spreeline (96-03), CR-V 4X4 (B20Z1) 2.0 SWB SUV Pet. (97-05)</p>
 <p>ID: 12, OD: 40.5, L: 70.5</p>	<p>AR5559 Front Lower Control Arm Bush - Inner & Outer</p> <p>Honda Ballade (SO4) (D15Z4) 150i, Series, Encore, Luxline, Spreeline, Auto., (D16Y9, 16Z) 160i Luxline, Spreeline, (B18B4) 180i Luxline (96-00), Civic (SO3) (D15Z4) 150i Luxline, Spreeline, (D16Y9) 160i Luxline, (D16A6) 160i V-TEC (96-03), Civic (SO4) (D16Z) 160i V-TEC, (B18B4) 180i Luxline, Spreeline (96-03), CR-V 4X4 (B20Z1) 2.0 SWB SUV Pet. (97-05)</p>	 <p>ID: 18, OD: 32</p>	<p>AR5571 Front Stabilizer Bar Bush</p> <p>Honda Ballade (SC9) (EV2) 130 "Flip-Up Lights", (EW) 150 i "Flip-Up Lights", (ZC1) 160i DOHC (84-89)</p>
	<p>AR5572 Front Lower Control Arm Bush - Inner & Outer</p> <p>Honda Ballade (SC9) (EV2) 130 "Flip-Up Lights", (EW) 150 i "Flip-Up Lights", (ZC1) 160i DOHC (84-89)</p>	 <p>NO PICTURE AVAILABLE AT TIME OF PRINT</p>	<p>AR5573 Front & Rear Strut Mounting Kit</p> <p>Honda CR-V 4X4 (B20Z1) 2.0 SWB SUV Pet. (97-05)</p>

ENGINE MOUNTING & RUBBER BUYERS GUIDE

	<p>AR5574 Shock Rubber - Front</p> <p>Ford Ranger 1.8, XL SWB, LWB P/up Pet., 2.2, XL SWB, LWB P/up Pet., (WL4) 2.5D, TD High Trail, High Trail XL, XL D/cab, XLT Hi Trail, Super Cab XLT Hi Trail SWB, LWB P/up Dies., 4.0 V6 SubCab XLT Hi Trail, Super Cab XLT, XLE D/C, Hi Trail SWB, LWB P/up Pet. (99-10), Ranger 4X4 2.5D TD XL D/cab, XLT, SubCab, XLT Hi Trail, Super Cab XLT LWB P/up Dies., 3.0 TDCi D/cab XLE, SubCab XLT, Hi Trail, Super Cab XLT LWB P/up Dies. (07-12); Mazda B-Series B2600i LWB D/cab, Drifter SLX P/up Pet. (86-02), Drifter 1.8 SWB, LWB XL P/up Pet., 2.2 SWB, LWB XL, (WL4) 2.5TD LWB Hi Ride, S/cab, SL Hi Ride, SLE, SLX, D/cab, LX Hi Ride, P/up Dies., 2.6i LWB SL Hi Ride S/cab, SLE D/C, SLX, Hi Ride, SLX Hi Ride D/cab (00-08), Drifter 4X4 (WL4) 2.5TD LWB S/cab, D/cab, SL S/cab, SLE, SLE D/cab, SLX S/cab, SLX, D/cab P/up Dies., 2.6i V6 LWB S/cab, SL S/cab, SLE, D/cab, SLX D/cab P/up Pet. (00-08)</p>		<p>AR5608 Transmission Mounting</p> <p>Isuzu KBD-Series KBD22 (C223) 2.2 LE SWB P/up Dies., KBD23 (4JA1) 2.5 LE SWB P/up Dies., KBD26 (C190) 2.0 LWB P/up Dies., KBD27 (C223) 2.2 LWB P/up Dies., KBD28 (4JA1) 2.5 LWB P/up Dies. (78-89), KB-Series KB21 (G180Z) 1.6 SWB, Fleetside, P/up Pet. (G161Z) 1.8 SWB, P/up Pet., KB22 (180Z) 1.8 SWB P/up Pet., KB23 (200Z) 2.0 SWB P/up Pet., KB24 (4ZD1) 2.3 LE SWB P/up Pet., KB26 (G161Z) 1.6 LWB P/up Pet., (G180Z) 1.8 LWB P/up Pet., KB27 (G180Z) 1.8 LWB P/up Pet., KB29 (4ZD1) 2.3 LWB P/up Pet. (81-89), KB-Series 4X4 KB40 (G161Z) SWB P/up Pet., KB41 (G161Z), SWB P/up Pet. (G180Z) SWB P/up Pet., KB42 (G180Z) SWB P/up, KB43 (G200Z) SWB P/up Pet., KB44 (4ZD1) LE SWB P/up Pet. (84-87), KBD-Series 4X4 KBD41 (C190) Dies., KBD42 (C223) Dies. (84-87), KB-Series KB220 Fleetside P/up, KB240i LE, D/C LE, Fleetside P/up, KB250D, DC LE, D/C LE, Fleetside P/up, D-TEQ, KB300 TDC TDi LX, D/C LX, Fleetside P/up, Hi-Rider, D-MAX (04-13), KB-Series D-TEQ 4X4 KB240i LE, D/C LE, Fleetside P/up, KB250D LE, D/C LE, Fleetside P/up, KB300TDi LX, D/C LX, Fleetside, "GO Big" P/up Hi-Rider (04-12), Relay (4ZB1) 1.8 LWB Bus, P/van Pet., (4ZC1) 2.0 SWB Bus, P/van Pet. (83-86), WFR 11/12 FVX (83-86)</p>
 <p>ID: 22, OD: 47, L: 27.5</p>	<p>AR5575 Tension Rod Bush</p> <p>Ford Ranger 1.8, XL SWB, LWB P/up Pet., 2.2, XL SWB, LWB P/up Pet., (WL4) 2.5D, TD High Trail, High Trail XL, XL D/cab, XLT Hi Trail, Super Cab XLT Hi Trail SWB, LWB P/up Dies., 4.0 V6 SubCab XLT Hi Trail, Super Cab XLT, XLE D/C, Hi Trail SWB, LWB P/up Pet. (99-10); Mazda B-Series B2600i LWB D/cab, Drifter SLX P/up Pet. (86-02)</p>		<p>AR5609 Engine Mounting - RHS</p> <p>Isuzu KBD-Series KBD22 (C223) 2.2 LE SWB P/up Dies., KBD23 (4JA1) 2.5 LE SWB P/up Dies., KBD26 (C190) 2.0 LWB P/up Dies., KBD27 (C223) 2.2 LWB P/up Dies., KBD28 (4JA1) 2.5 LWB P/up Dies. (78-89), KBD-Series 4X4 KBD41 (C190) Dies., KBD42 (C223) Dies. (81-84)</p>
	<p>AR5577 Engine Mounting - RHS</p> <p>Kia Sephia (BFD) 1.5 LS, RS (98-04), Shuma (BFD) 1.5i LS, (TBD) 1.8i GS (98-04), Shuma II 1.6i, (T8) 1.8i GS (98-04)</p>		<p>AR5610 Engine Mounting - LHS</p> <p>Isuzu KBD-Series KBD22 (C223) 2.2 LE SWB P/up Dies., KBD23 (4JA1) 2.5 LE SWB P/up Dies., KBD26 (C190) 2.0 LWB P/up Dies., KBD27 (C223) 2.2 LWB P/up Dies., KBD28 (4JA1) 2.5 LWB P/up Dies. (78-89), KBD-Series 4X4 KBD41 (C190) Dies., KBD42 (C223) Dies. (81-84)</p>
	<p>AR5580 Rear Stabilizer Link Grommet</p> <p>Honda Ballade (SC9) (EV2) 130 "Flip-Up Lights", (EW) 150 i "Flip-Up Lights", (ZC1) 160i DOHC (84-89), Ballade (SH4) (D15B3) 150 16V SOHC, (D16A9) 160i 16V SOHC, DOHC (89-92)</p>		<p>AR5611 Engine Mounting - LHS</p> <p>Isuzu KB-Series KB160 (4ZA1) 1.6 SWB, Fleetside P/up Pet., KB200 (ZC1) 2.0 SWB, LWB, D/cab, LE, Fleetside, P/up Pet., KB220 (C22NE) 2.2 LWB D/cab, LE P/up Pet., KB230 (4ZD1) 2.3 SWB, LWB, D/cab P/up Pet., KB250D (4JA1) 2.5 SWB, LWB D/cab, LE, Fleetside, P/up Dies., KB280DT (4JB1) 2.8 SWB, LWB LE, D/cab LE, Frontier LX P/up (89-04), KB-Series 4X4 KB230 (4ZD1) SWB P/up Pet., KB260 (4ZE1) LWB D/cab, LE, LX D/cab P/up (89-04), KB-Series KB260 (4ZE1) 2.6 SWB, LWB LE, LX, D/cab P/up Pet. (92-04)</p>
 <p>ID: 10, OD: 31, L: 40</p>	<p>AR5590 Rear Upper Trailing Arm Bush - Outer</p> <p>Honda Ballade (SH4) (D15B3) 150 16V SOHC, (D16A9) 160i 16V SOHC, DOHC (89-92), Ballade (SR4) (D15B3) 150 Encore, Luxline, Spreeline, (D16A7) 160E, i, Luxline, Spreeline, (B18B3) 180E, i Luxline, Spreeline (92-98)</p>		<p>AR5612 Engine Mounting - RHS</p> <p>Isuzu KB-Series KB160 (4ZA1) 1.6 SWB, Fleetside P/up Pet., KB200 (ZC1) 2.0 SWB, LWB, D/cab, LE, Fleetside, P/up Pet., KB220 (C22NE) 2.2 LWB D/cab, LE P/up Pet., KB230 (4ZD1) 2.3 SWB, LWB, D/cab P/up Pet., KB250D (4JA1) 2.5 SWB, LWB D/cab, LE, Fleetside, P/up Dies., KB280DT (4JB1) 2.8 SWB, LWB LE, D/cab LE, Frontier LX P/up (89-04), KB-Series 4X4 KB230 (4ZD1) SWB P/up Pet., KB260 (4ZE1) LWB D/cab, LE, LX D/cab P/up (89-04), KB-Series KB260 (4ZE1) 2.6 SWB, LWB LE, LX, D/cab P/up Pet. (92-04)</p>
 <p>ID: 10, OD: 31.5, L: 50</p>	<p>AR5596 Rear Lower Control Arm Bush - Inner & Outer</p> <p>Honda Ballade (SH4) (D15B3) 150 16V SOHC, (D16A9) 160i 16V SOHC, DOHC (89-92)</p>		<p>AR5613 Transmission Mounting</p> <p>Foton Thunda (493ZQ) 2.8D Taxi (2010-); Isuzu KB-Series KB160 (4ZA1) 1.6 SWB, Fleetside P/up Pet., KB200 (ZC1) 2.0 SWB, LWB, D/cab, LE, Fleetside, P/up Pet., KB220 (C22NE) 2.2 LWB D/cab, LE P/up Pet., KB230 (4ZD1) 2.3 SWB, LWB, D/cab P/up Pet., KB250D (4JA1) 2.5 SWB, LWB D/cab, LE, Fleetside, P/up Dies., KB280DT (4JB1) 2.8 SWB, LWB LE, D/cab LE, Frontier LX P/up (89-04), KB-Series 4X4 KB230 (4ZD1) SWB P/up Pet., KB260 (4ZE1) LWB D/cab, LE, LX D/cab P/up (89-04), KB-Series KB260 (4ZE1) 2.6 SWB, LWB LE, LX, D/cab P/up Pet. (92-04)</p>
	<p>AR5599 Front Strut Bar Bush Kit</p> <p>Mitsubishi Colt LDV (4G63) 2.0, i LWB Std., Hi-Line S/cab, K62T P/up, Pet., 2.4i LWB Hi-Line, S/cab, D/cab, Hi Rider K65T, P/up Pet., (4D56) 2.5D LWB Hi-Line, Std., S/cab, K64T P/up Dies. (98-09), Colt LDV (K67/77T) 2.8D, TD LWB Std. S/cab, Hi-Line S/cab Hi Rider, Hi-Line Raised Body, Pioneer D/cab Hi Rider P/up Dies., (6G72) 3.0i V6 LWB ClubCab K76T P/up Pet. (01-09), Colt LDV 2.0 LWB P/up, 2.0i LWB Hi-Line P/up (04-09)</p>		<p>AR5614 Rear Strut Mounting</p> <p>Toyota Conquest (EE80) (2E-L) 1.3 L, GL 12V 4-Spd. Man. (85-88), Corolla (AE80) (2A-L) 1.3 FWD GL 8V 4-Spd. Man. (84-88), (AE82) (4A-GE) 1.6 L (84-88), (EE80) (2E-L) 1.3 FWD L, GL OHC 4-Spd. Man. (84-88)</p>
	<p>AR5603 Engine Mounting - L/RHS</p> <p>Isuzu KB-Series KB21 (G180Z) 1.6 SWB, Fleetside, P/up Pet., KB23 (200Z) 2.0 SWB P/up Pet., KB24 (4ZD1) 2.3 LE SWB P/up Pet., KB26 (G161Z) 1.6 LWB P/up Pet., KB29 (4ZD1) 2.3 LWB P/up Pet. (81-89), KB-Series 4X4 KB40 (G161Z) SWB P/up Pet., KB41 (G161Z), SWB P/up Pet. (G180Z) SWB P/up Pet., KB42 (G180Z) SWB P/up, KB43 (G200Z) SWB P/up Pet. (81-89), KB44 (4ZD1) LE SWB P/up Pet. (87-89), KBD-Series 4X4 KBD42 (C223) Dies. (84-87)</p>		<p>AR5604 Engine Mounting - L/RHS</p> <p>Isuzu KB-Series KB21 (G161Z) 1.8 SWB, P/up Pet., KB22 (180Z) 1.8 SWB P/up Pet., KB23 (200Z) 2.0 SWB P/up Pet., KB26 (G161Z) 1.6 LWB P/up Pet., (G180Z) 1.8 LWB P/up Pet., KB27 (G180Z) 1.8 LWB P/up Pet. (81-89), KB-Series 4X4 KB40 (G161Z) SWB P/up Pet., KB41 (G161Z), SWB P/up Pet. (G180Z) SWB P/up Pet., KB42 (G180Z) SWB P/up, KB43 (G200Z) SWB P/up Pet. (81-89), KB44 (4ZD1) LE SWB P/up Pet. (87-89), KBD-Series 4X4 KBD42 (C223) Dies. (84-87)</p>

ENGINE MOUNTING & RUBBER BUYERS GUIDE

	AR5615 Engine Mounting - Rear Toyota Corolla (AE92) (4A-F) 1.6 GLX DOHC 4-Spd. Auto. (88-93)
	AR5616 Rear X-Member Bush - Front Mercedes-Benz (W210) E-Class E200K (M111.957) 2.0, E230 (M111.970) 2.3, E240 (M112.911) 2.4, E280 (M112.921) 2.8 V6, E320 (M104.995, M112.941) 3.2 V6, E430 (M113.940) 4.3 V8 (96-02)
	AR5617 Rear X-Member Bush - Rear Mercedes-Benz (W210) E-Class E200K (M111.957) 2.0, E230 (M111.970) 2.3, E240 (M112.911) 2.4, E280 (M112.921) 2.8 V6, E320 (M104.995, M112.941) 3.2 V6, E430 (M113.940) 4.3 V8 (96-02)
	AR5618 Engine Mounting - RHS Isuzu KB-Series KB250D (4JA1) 2.5 SWB, LWB D/cab, LE, Fleetside, P/up Dies., KB280DT (4JB1) 2.8 SWB, LWB LE, D/cab LE, Frontier LX P/up (89-96), KB-Series 4X4 KB280DT (4JB1) SWB, LWB LE, LE D/cab, LX, LX D/cab, P/up (89-04)
	AR5619 Engine Mounting - LHS Isuzu KB-Series KB250D (4JA1) 2.5 SWB, LWB D/cab, LE, Fleetside, P/up Dies., KB280DT (4JB1) 2.8 SWB, LWB LE, D/cab LE, Frontier LX P/up (89-96), KB-Series 4X4 KB250D (4JA1) SWB, LWB, D/cab, LE, LE D/cab P/up Dies., KB280DT (4JB1) SWB, LWB LE, LE D/cab, LX, LX D/cab, P/up (92-96)
	AR5620 Transmission Mounting Isuzu KB-Series 4X4 KB280DT (4JB1) SWB, LWB LE, LE D/cab, LX, LX D/cab, P/up (89-04)
	AR5621 Engine Mounting - LHS Isuzu KBD-Series 4X4 KBD42 (C223) Dies. (87-89)
	AR5622 Engine Mounting - RHS Isuzu KBD-Series 4X4 KBD42 (C223) Dies. (87-89)
	AR5623 Engine Mounting - L/RHS Isuzu KB-Series 4X4 KB220 (C22NE) LWB D/cab, LE, P/up Pet. (89-04)
	AR5624 Engine Mounting - Rear Mazda 626 (F8) 1.8 L, Auto. Hatch, Sedan, (FE) 2.0 SL Auto. Hatch, EG (83-93)
	AR5625 Front Lower Control Arm Bush - Inner Mitsubishi Colt LDV (4G63) 2.0, i LWB Std., Hi-Line S/cab, K62T P/up, Pet., 2.4i LWB Hi-Line, S/cab, D/cab, Hi Rider K65T, P/up Pet., (4D56) 2.5D LWB Hi-Line, Std., S/cab, K64T P/up Dies. (98-09) - Standard Body Models, Colt LDV (K67/77T) 2.8D, TD LWB Std. S/cab, Hi-Line S/cab Hi Rider, Hi-Line Raised Body, Pioneer D/cab Hi Rider P/up Dies., (6G72) 3.0i V6 LWB ClubCab K76T P/up Pet. (01-09), Colt LDV 2.0 LWB P/up, 2.0i LWB Hi-Line P/up (04-09)
	AR5626 Engine Mounting - RHS Isuzu Relay (4ZB1) 1.8 LWB Bus, P/van Pet., (4ZC1) 2.0 SWB Bus, P/van Pet. (83-95), WFR 11/12 FVX (83-95)

	AR5627 Engine Mounting - LHS Isuzu Relay (4ZB1) 1.8 LWB Bus, P/van Pet., (4ZC1) 2.0 SWB Bus, P/van Pet. (83-95), WFR 11/12 FVX (83-95)
	AR5628 Transmission Mounting Isuzu Relay (4ZB1) 1.8 LWB Bus, P/van Pet., (4ZC1) 2.0 SWB Bus, P/van Pet. (83-95), WFR 11/12 FVX (83-95)
	AR5629 Front Stabilizer Link Grommet Isuzu KBD-Series KBD20 (C190) 2.0 SWB P/up Dies., KBD25 (C190) 2.0 LWB P/up Dies. (78-89), KB-Series KB29 (4ZD1) 2.3 LWB P/up Pet. (81-89), KB-Series 4X4 KB40 (G161Z) SWB P/up Pet., KB41 (G161Z), SWB P/up Pet. (G180Z) SWB P/up Pet., KB42 (G180Z) SWB P/up, KB43 (G200Z) SWB P/up Pet., KB44 (4ZD1) LE SWB P/up Pet. (79-89), KBD-Series 4X4 KBD40 (C190) SWB P/up Dies., KBD41 (C190) Dies., KBD42 (C223) Dies. (79-89)
	AR5630 Stabilizer Bar Bush Isuzu KBD-Series KBD20 (C190) 2.0 SWB P/up Dies., KBD25 (C190) 2.0 LWB P/up Dies. (78-89), KB-Series 4X4 KB40 (G161Z) SWB P/up Pet. (79-81), KBD-Series 4X4 KBD40 (C190) SWB P/up Dies. (79-81)
	AR5636 Front Lower Control Arm Bush - Inner Isuzu KB-Series 4X4 KB44 (4ZD1) LE SWB P/up Pet. (87-89), KBD-Series 4X4 KBD41 (C190) Dies., KBD42 (C223) Dies. (81-89)
	AR5638 Transmission Mounting Mitsubishi Colt LDV (4G63) 2.0, i LWB Std., Hi-Line S/cab, K62T P/up, Pet., 2.4i LWB Hi-Line, S/cab, D/cab, Hi Rider K65T, P/up Pet. (98-09), Colt LDV (K67/77T) 2.8D, TD LWB Std. S/cab, Hi-Line S/cab Hi Rider, Hi-Line Raised Body, Pioneer D/cab Hi Rider P/up Dies.. (01-09)
	AR5640 Front Stabilizer Bar Bush Isuzu KB-Series 4X4 KB44 (4ZD1) LE SWB P/up Pet. (79-89), KBD-Series 4X4 KBD41 (C190) Dies., KBD42 (C223) Dies. (79-89)
	AR5641 Front Lower Control Arm Bush - Inner Fiat Stilo (182B6000) 1.6 Actual, Active, Multi Wagon, Active, (192A1000, 937A7.000) 1.9 JTD Dynamic, Actual, Multi Wagon JTD Dynamic (03-07)
	AR5642 Front Lower Control Arm Bush - Outer Rear Fiat Stilo (182B6000) 1.6 Actual, Active, Multi Wagon, Active, (192A1000, 937A7.000) 1.9 JTD Dynamic, Actual, Multi Wagon JTD Dynamic (03-07)
	AR5644 Front Stabilizer Bar Bush Isuzu KBD-Series KBD20/21 (C190) 2.0 SWB P/up Dies., KBD22 (C223) 2.2 LE SWB P/up Dies., KBD23 (4JA1) 2.5 LE SWB P/up Dies., KBD25/26 (C190) 2.0 LWB P/up Dies., KBD27 (C223) 2.2 LWB P/up Dies., KBD28 (4JA1) 2.5 LWB P/up Dies. (78-89), KB-Series KB21 (G180Z) 1.6 SWB, Fleetside, P/up Pet. (G161Z) 1.8 SWB, P/up Pet., KB22 (180Z) 1.8 SWB P/up Pet., KB23 (200Z) 2.0 SWB P/up Pet., KB24 (4ZD1) 2.3 LE SWB P/up Pet., KB26 (G161Z) 1.6 LWB P/up Pet., (G180Z) 1.8 LWB P/up Pet., KB27 (G180Z) 1.8 LWB P/up Pet., KB29 (4ZD1) 2.3 LWB P/up Pet. (81-89), KB-Series 4X4 KB41 (G161Z), SWB P/up Pet. (G180Z) SWB P/up Pet., KB42 (G180Z) SWB P/up, KB43 (G200Z) SWB P/up Pet. (79-81)
	AR5645 Front Stabilizer Bar Bush Isuzu KB-Series KB230 (4ZD1) 2.3 SWB, LWB, D/cab P/up Pet., KB250D (4JA1) 2.5 SWB, LWB D/cab, LE, Fleetside, P/up Dies. (89-04), KB-Series 4X4 KB250D (4JA1) SWB, LWB, D/cab, LE, LE D/cab P/up Dies. (89-04)

ENGINE MOUNTING & RUBBER

BUYERS GUIDE

 <p>ID: 18.3, OD: 38, L: 45.2</p>	<p>AR5647 Front Upper Control Arm Bush - Inner Front & Outer Rear</p> <p>Isuzu KB-Series KB160 (4ZA1) 1.6 SWB, Fleetside P/up Pet., KB200 (ZC1) 2.0 SWB, LWB, D/cab, LE, Fleetside, P/up Pet., KB220 (C22NE) 2.2 LWB D/cab, LE P/up Pet., KB230 (4ZD1) 2.3 SWB, LWB, D/cab P/up Pet., KB250D (4JA1) 2.5 SWB, LWB D/cab, LE, Fleetside, P/up Dies., KB280DT (4JB1) 2.8 SWB, LWB LE, D/cab LE, Frontier LX P/up (89-04), KB-Series 4X4 KB220 (C22NE) LWB D/cab, LE, P/up Pet., KB230 (4ZD1) SWB P/up Pet., KB250D (4JA1) SWB, LWB, D/cab, LE, LE D/cab P/up Dies., KB260 (4ZE1) LWB D/cab, LE, LX D/cab P/up, KB280DT (4JB1) SWB, LWB LE, LE D/cab, LX, LX D/cab, P/up (89-04), KB-Series KB260 (4ZE1) 2.6 SWB, LWB LE, LX, D/cab P/up Pet., KB320 (6VD1) 3.2 V6 SWB, LWB LE, LX, D/cab, Frontier, Reef, Blazer P/up Pet. (92-04), KB-Series 4X4 KB320 (6VD1) V6 SWB, LWB Frontier LX, LX, LX D/cab P/up Pet. (98-04)</p>		<p>AR5661 Engine Mounting - Rear</p> <p>Mazda 626 (F6) 1.6 L Hatch, Sedan, S Sedan, SL Hatch Man., (F8) 1.8 L Hatch, Sedan Man., (FE) 2.0 SL Hatch, EGi, Sedan, SLI 16 Valve, SLE, 12 Valve, SLX Sedan, Hatch (83-93)</p>
 <p>ID: 24, L: 34, H: 41, W: 42</p>	<p>AR5648 Front Stabilizer Bar Bush</p> <p>Isuzu KB-Series KB160 (4ZA1) 1.6 SWB, Fleetside P/up Pet., KB200 (ZC1) 2.0 SWB, LWB, D/cab, LE, Fleetside, P/up Pet., KB220 (C22NE) 2.2 LWB D/cab, LE P/up Pet., KB280DT (4JB1) 2.8 SWB, LWB LE, D/cab LE, Frontier LX P/up (89-04), KB-Series 4X4 KB220 (C22NE) LWB D/cab, LE, P/up Pet., KB230 (4ZD1) SWB P/up Pet., KB250D (4JA1) SWB, LWB, D/cab, LE, LE D/cab P/up Dies., KB260 (4ZE1) LWB D/cab, LE, LX D/cab P/up (89-04), KB-Series KB260 (4ZE1) 2.6 SWB, LWB LE, LX, D/cab P/up Pet., (92-04)</p>	 <p>ID: 12.5, OD: 39, L: 61</p>	<p>AR5663 Front Lower Control Arm Bush - Inner, Front</p> <p>Mazda 626 (F6) 1.6 L Hatch, Sedan, S Sedan, SL Hatch Man., (F8) 1.8 L Hatch, Sedan Man., (FE) 2.0 SL Hatch, EGi, Sedan, SLI 16 Valve, SLE, 12 Valve, SLX Sedan, Hatch (83-93)</p>
 <p>ID: 18.5, OD: 44, L: 79</p>	<p>AR5649 Front Lower Control Arm Bush - Inner</p> <p>Isuzu KB-Series 4X4 KB280DT (4JB1) SWB, LWB LE, LE D/cab, LX, LX D/cab, P/up (92-96)</p>	 <p>ID: 18, L: 18, H: 34, W: 38</p>	<p>AR5665 Front Stabilizer Bar Bush</p> <p>Mazda 626 (F6) 1.6 L Hatch, Sedan, S Sedan, SL Hatch Man., (F8) 1.8 L Hatch, Sedan Man., (FE) 2.0 SL Hatch, EGi, Sedan, SLI 16 Valve, SLE, 12 Valve, SLX Sedan, Hatch (83-93)</p>
	<p>AR5650 Engine Mounting - L/RHS</p> <p>Mitsubishi Colt LDV (K67777) 2.8D, TD LWB Std. S/cab, Hi-Line S/cab Hi Rider, Hi-Line Raised Body, Pioneer D/cab Hi Rider P/up Dies., (6G72) 3.0i V6 LWB ClubCab K76T P/up Pet. (01-09), Colt LDV 4X4 (K65/75T) 2.4i LWB S/cab, Hi-Line, D/cab, Trailbuster S/cab, P/up Pet., (K77T) 2.8D LWB S/cab, P/up Dies., (K77T) 2.8TD LWB Rodeo D/cab, P/up Turbo Dies., (6G72, K76T) 3.0i V6 LWB Rodeo D/cab, ClubCab, P/up Pet. (98-09)</p>		<p>AR5690 Front Strut Mounting</p> <p>Ford Mondeo (Endura D18Ti) 1.8 TDi LX, (Zetec ZH18Efi) 1.8i LX B-P Pet., (Zetec ZH20Efi, ZH20HE) 2.0i Aspen, CLX, B-P, (Duratec M5) 2.5i V6 Si (97-01)</p>
	<p>AR5654 Front Stabilizer Bar Bush</p> <p>Isuzu Relay (4ZB1) 1.8 LWB Bus, P/van Pet., (4ZC1) 2.0 SWB Bus, P/van Pet. (83-95), WFR 11/12 FVX (83-95)</p>		<p>AR5694 Engine Mounting - L/RHS</p> <p>Mitsubishi Colt LDV (4G63) 2.0 SWB/ LWB D/cab Hi-Line, Lo-Line K12 P/up Pet., (4G54) 2.6 LWB Hi-Line K13, P/up (94-98), Colt LDV (4G63) 2.0, i LWB Std., Hi-Line S/cab, K62T P/up, Pet., 2.4i LWB Hi-Line, S/cab, D/cab, Hi Rider K65T, P/up Pet. (98-09), Colt LDV 4X4 (K65/75T) 2.4i LWB S/cab, Hi-Line, D/cab, Trailbuster S/cab, P/up Pet., (K77T) 2.8D LWB S/cab, P/up Dies., (K77T) 2.8TD LWB Rodeo D/cab, P/up Turbo Dies., (6G72, K76T) 3.0i V6 LWB Rodeo D/cab, ClubCab, P/up Pet. (98-09)</p>
	<p>AR5655 Shackle Bush - Rear Upper & Lower</p> <p>Isuzu Relay (4ZB1) 1.8 LWB Bus, P/van Pet., (4ZC1) 2.0 SWB Bus, P/van Pet. (83-95), WFR 11/12 FVX (83-95)</p>		<p>AR5695 Transmission Mounting</p> <p>Mitsubishi Colt LDV (4G32) 1.6 SWB/ LWB Lo-Line K01/11 P/up Pet., (4G63) 2.0 SWB/ LWB D/cab Hi-Line, Lo-Line K12 P/up Pet., (4D56) 2.5D LWB Hi-Line, Lo-Line D/cab K14 P/up Dies., (4G54) 2.6 LWB Hi-Line K13, P/up (94-98)</p>
	<p>AR5656 Engine Mounting - LHS</p> <p>Mazda 626 (F6) 1.6 L Hatch, Sedan, S Sedan, SL Hatch Man. (83-93)</p>		<p>AR5696 Engine Mounting - L/RHS</p> <p>Mitsubishi Colt LDV (4G32) 1.6 SWB/ LWB Lo-Line K01/11 P/up Pet. (94-98)</p>
	<p>AR5657 Transmission Mounting</p> <p>Mazda 626 (F6) 1.6 L Hatch, Sedan, S Sedan, SL Hatch Man., (F8) 1.8 L Hatch, Sedan Man., (FE) 2.0 SL Hatch, EGi, Sedan, SLI 16 Valve, SLE, 12 Valve, SLX Sedan, Hatch (83-93)</p>		<p>AR5698 Semi Trailing Arm Bush - Front L/RHS</p> <p>Ford Mondeo (Endura D18Ti) 1.8 TDi LX, (Zetec ZH18Efi) 1.8i LX B-P Pet., (Zetec ZH20Efi, ZH20HE) 2.0i Aspen, CLX, B-P, (Duratec M5) 2.5i V6 Si (97-01)</p>
	<p>AR5659 Engine Mounting - Front</p> <p>Mazda 626 (F8) 1.8 L Hatch, Sedan Man., (FE) 2.0 SL Hatch (83-93)</p>	 <p>ID: 20, L: 22, H: 41, W: 40</p>	<p>AR5702 Front Stabilizer Bar Bush</p> <p>Ford Mondeo (Endura D18Ti) 1.8 TDi LX, (Zetec ZH18Efi) 1.8i LX B-P Pet., (Zetec ZH20Efi, ZH20HE) 2.0i Aspen, CLX, B-P, (Duratec M5) 2.5i V6 Si (97-01)</p>
	<p>AR5660 Engine Mounting - RHS</p> <p>Mazda 626 (F8) 1.8 L Hatch, Sedan Man., (FE) 2.0 SL Hatch (83-93)</p>		<p>AR5707 Exhaust Hanger - Middle, Rear</p> <p>BMW 5-Series (E39) 523i (M52) 2.5, 525i (M54) 2.5, 528i (M52) 2.8, 530d (M57) 3.0 Dies., 530i (M54) 3.0 (96-04), 540i (M62) 4.4, M5 (S38) 3.6 (98-04), 7-Series (E38) 740i (M60) 4.0 V8, (M62) 4.4 V8, 750iL (M73) 5.4 V12 (96-03)</p>

ENGINE MOUNTING & RUBBER BUYERS GUIDE

 <p>ID: 53, T: 38, PCD: 105 6-HOLES</p>	<p>AR5709 Propshaft Coupling BMW 3-Series (E46) 330d (M57) 3.0 Dies. (99-05), 5-Series (E39) 530d (M57) 3.0 Dies. (96-04), 540i (M62) 4.4, M5 (S38) 3.6 (98-04), M5 (S62) 4.9 V8 (99-04), 7-Series (E32) 740i (M60, M62) 4.0, 750iL (M70) 5.0 V12 (88-95), (E38) 740i (M60) 4.0 V8, (M62) 4.4 V8, 750iL (M73) 5.4 V12 (96-03)</p>
 <p>PCD: 105 6-HOLES</p>	<p>AR5710 Propshaft Coupling BMW 3-Series (E46) 330d (M57) 3.0 Dies. (99-05), 5-Series (E39) 530d (M57) 3.0 Dies. (96-04)</p>
	<p>AR5714 Exhaust Hanger - Rear BMW X5 (E53) 4X4 (M57N) 3.0d Steptronic SUV Dies., (M54) 3.0i Steptronic SUV 6-Cyl. Pet., (M62) 4.4i Steptronic SUV Pet., (M62) 4.8i Steptronic SUV V8 Pet. (01-10)</p>
	<p>AR5715 Exhaust Hanger - Middle BMW X5 (E53) 4X4 (M57N) 3.0d Steptronic SUV Dies., (M54) 3.0i Steptronic SUV 6-Cyl. Pet. (01-10)</p>
	<p>AR5716 Trailing Arm BMW Mini Cooper (R50) Cooper (W10B16A) 1.6, (R52) Cooper (W10B16A, W11B16A) 1.6 Convertible, (R53) Cooper S (W11B16A) 1.6 (02-09), Cooper (R55) (N12B16A, N16B16A) 1.6 Clubman, (R56) (N12B16A, N16B16A) 1.6 Hatch, (R57) (N12B16A, N16B16A) 1.6 Convertible, (R58) (N16B16A) 1.6 Coupe, (R59) (N16B16A) 1.6 Roadster, (R60) (N16B16A) 1.6 Countryman, (R61) (N16B16A) 1.6 Paceman (2007-), Cooper S (R55) (N14B16A, N18B16A) 1.6 Clubman, (R56) (N14B16A, N18B16A) 1.6 Hatch, (R57) (N14B16A, N18B16A) 1.6 Convertible, (R58) (N18B16A) 1.6 Coupe, (R59) (N18B16A) 1.6 Roadster, (R60) (N18B16A) 1.6 Countryman, (R61) (N18B16A) 1.6 Paceman (2007-), Cooper S 4X4 (R60) (N18B16A) 1.6 Countryman, (R61) (N18B16A) 1.6 Paceman (2010-), Cooper John (R55) (N14B16C) 1.6 Clubman, (R56) (N14B16C, N18B16C) 1.6 Hatch, (R57) (N14B16C, N18B16C) 1.6 Convertible, (R58) (N14B16C, N18B16C) 1.6 Coupe, (R59) (N14B16C, N18B16C) 1.6 Roadster (2007-), Countryman JCW (R56) (N18B16C) 1.6 Hatch, (R60) (N18B16A) 1.6 Countryman (2007-), One (R56) (N16B16A) 1.6 Hatch, (R57) (N16B16A) 1.6 Convertible (2007-)</p>
	<p>AR5717 Trailing Arm Bush BMW Mini Cooper (R50) Cooper (W10B16A) 1.6, (R52) Cooper (W10B16A, W11B16A) 1.6 Convertible, (R53) Cooper S (W11B16A) 1.6 (02-09), Cooper (R55) (N12B16A, N16B16A) 1.6 Clubman, (R56) (N12B16A, N16B16A) 1.6 Hatch, (R57) (N12B16A, N16B16A) 1.6 Convertible, (R58) (N16B16A) 1.6 Coupe, (R59) (N16B16A) 1.6 Roadster, (R60) (N16B16A) 1.6 Countryman, (R61) (N16B16A) 1.6 Paceman (2007-), Cooper S (R55) (N14B16A, N18B16A) 1.6 Clubman, (R56) (N14B16A, N18B16A) 1.6 Hatch, (R57) (N14B16A, N18B16A) 1.6 Convertible, (R58) (N18B16A) 1.6 Coupe, (R59) (N18B16A) 1.6 Roadster, (R60) (N18B16A) 1.6 Countryman, (R61) (N18B16A) 1.6 Paceman (2007-), Cooper S 4X4 (R60) (N18B16A) 1.6 Countryman, (R61) (N18B16A) 1.6 Paceman (2010-), Cooper John (R55) (N14B16C) 1.6 Clubman, (R56) (N14B16C, N18B16C) 1.6 Hatch, (R57) (N14B16C, N18B16C) 1.6 Convertible, (R58) (N14B16C, N18B16C) 1.6 Coupe, (R59) (N14B16C, N18B16C) 1.6 Roadster (2007-), Countryman JCW (R56) (N18B16C) 1.6 Hatch, (R60) (N18B16A) 1.6 Countryman (2007-), One (R56) (N16B16A) 1.6 Hatch, (R57) (N16B16A) 1.6 Convertible (2007-)</p>

	<p>AR5718 Rear Strut Mounting BMW Mini Cooper (R55) (N12B16A, N16B16A) 1.6 Clubman, (R56) (N12B16A, N16B16A) 1.6 Hatch, (R57) (N12B16A, N16B16A) 1.6 Convertible, (R58) (N16B16A) 1.6 Coupe, (R59) (N16B16A) 1.6 Roadster, (R60) (N16B16A) 1.6 Countryman, (R61) (N16B16A) 1.6 Paceman (2007-), Cooper S (R55) (N14B16A, N18B16A) 1.6 Clubman, (R56) (N14B16A, N18B16A) 1.6 Hatch, (R57) (N14B16A, N18B16A) 1.6 Convertible, (R58) (N18B16A) 1.6 Coupe, (R59) (N18B16A) 1.6 Roadster, (R60) (N18B16A) 1.6 Countryman, (R61) (N18B16A) 1.6 Paceman (2007-), Cooper S 4X4 (R60) (N18B16A) 1.6 Countryman, (R61) (N18B16A) 1.6 Paceman (2010-), Cooper John (R55) (N14B16C) 1.6 Clubman, (R56) (N14B16C, N18B16C) 1.6 Hatch, (R57) (N14B16C, N18B16C) 1.6 Convertible, (R58) (N14B16C, N18B16C) 1.6 Coupe, (R59) (N14B16C, N18B16C) 1.6 Roadster (2007-), Countryman JCW (R56) (N18B16C) 1.6 Hatch, (R60) (N18B16A) 1.6 Countryman (2007-), One (R56) (N16B16A) 1.6 Hatch, (R57) (N16B16A) 1.6 Convertible (2007-)</p>
	<p>AR5720 Rear X-Member Bush - Front & Rear Mercedes-Benz (R170) SLK200 (M111.958) 2.0 Kompressor, SLK230 (M111.973, M111.978) 2.3 Kompressor (99-04), (W201) 190E (M102.920) 1.8, (M102.922) 2.0, (M102.983) 2.3 Sportline (93-94), (W202) C220 (M111.961) 2.2 Classic, Elegance, C230 (M111.974) 2.3 Classic, Elegance, Kompressor, Sport, C240 (M112.910) 2.4 Classic, Elegance, C250D, TD (M605.910) 2.5 5-Cyl., C280 (M104.941) 2.8 6-Cyl. Elegance (94-00), (W203) C-Class C180 (M111.920) 1.8 Classic, C200 (M271.940) 2.0 Classic, S/W, C220 (OM611.962, OM646.963) 2.2 CDI Classic, S/W, Elegance, C230 2.3 Coupe, C240 (M203.086) 2.6 V6 Elegance, S/W, Elegance S/W, C270 (OM612.962) 2.7 CDI 5-Cyl. Elegance, S/W, C320 (M111.946) 3.2 V6 Avantgarde Elegance, SW, (M271.946) C180K, (M271.940) C200K, (OM611.962, OM646.963) C220 CDI, (M271.948) C230K, (M112.912) C240/240T, (OM642.910) C320 CDI, (M272.960) C350 (00-11), (W208) CLK230 (M111.973/5) 2.3 Kompressor, CLK320 (M112.940) 3.2 V6 Cabrio (98-05), (W210) E-Class E200K (M111.957) 2.0, E230 (M111.970) 2.3, E240 (M112.911) 2.4, E280 (M112.921) 2.8 V6, E320 (M104.995, M112.941) 3.2 V6, E430 (M113.940) 4.3 V8 (96-02)</p>
	<p>AR5721 Engine Mounting - L/RHS Mitsubishi Colt LDV (K67/77T) 2.8D, TD LWB Std. S/cab, Hi-Line S/cab Hi Rider, Hi-Line Raised Body, Pioneer D/cab Hi Rider P/up Dies., (6G72) 3.0i V6 LWB ClubCab K76T P/up Pet. (01-09)</p>
	<p>AR5722 Engine Mounting - L/RHS Mitsubishi Colt LDV 4X4 (K65/75T) 2.4i LWB S/cab, Hi-Line, D/cab, Trailbuster S/cab, P/up Pet., (K77T) 2.8D LWB S/cab, P/up Dies., (K77T) 2.8TD LWB Rodeo D/cab, P/up Turbo Dies., (6G72, K76T) 3.0i V6 LWB Rodeo D/cab, ClubCab, P/up Pet. (98-09), Colt LDV 2.0 LWB P/up, 2.0i LWB Hi-Line P/up (04-09), Pajero 4X4 (4M40) 2.8TDi LWB GLS SUV V23C Dies. (90-01)</p>
	<p>AR5723 Engine Mounting - Rear RHS Mitsubishi Colt LDV 4X4 (K65/75T) 2.4i LWB S/cab, Hi-Line, D/cab, Trailbuster S/cab, P/up Pet., (K77T) 2.8D LWB S/cab, P/up Dies., (K77T) 2.8TD LWB Rodeo D/cab, P/up Turbo Dies., (6G72, K76T) 3.0i V6 LWB Rodeo D/cab, ClubCab, P/up Pet. (98-09)</p>
	<p>AR5724 Engine Mounting - Rear RHS Mitsubishi Colt LDV 4X4 (6G72, K76T) 3.0i V6 LWB Rodeo D/cab, ClubCab, P/up Pet. (98-09)</p>
	<p>AR5731 Transmission Mounting Mitsubishi Colt LDV (4D56) 2.5D LWB Hi-Line, Std., S/cab, K64T P/up Dies. (98-09)</p>
	<p>AR5733 Transmission Mounting Mitsubishi Colt LDV (K67/77T) 2.8D, TD LWB Std. S/cab, Hi-Line S/cab Hi Rider, Hi-Line Raised Body, Pioneer D/cab Hi Rider P/up Dies., (01-09)</p>

ENGINE MOUNTING & RUBBER BUYERS GUIDE

 <p>ID: 12, OD: 43.5, L: 60</p>	<p>AR5750 Front Lower Control Arm Bush - Inner Front & Outer Rear</p> <p>Opel Astra F (20SE) 200i, Estate, iE, (20XE) tS (93-99), Astra G (C16SEL) 1.6 Classic CD, Classic CDE, Comfort, CS, Elegance, (X18XE1) 1.8 Caravan CD S/W, Classic CDE, CSE, Elegance, Irmscher, Sport, (X20XE) 2.0 Classic CDX, Coupe', CSX (99-04), Kadett (20XE) 200 tS (93-99), Zafira I (X18XE1) 1.8i CD Elegance MPV, (X20XE) 2.0 OPC MPV, (Z22SE) 2.2i Elegance MPV (01-05)</p>
 <p>ID: 18, L: 40, H: 37, W: 32</p>	<p>AR5751 Front Stabilizer Bar Bush</p> <p>Opel Astra G (C16SEL) 1.6 Classic CD, Classic CDE, Comfort, CS, Elegance, (X18XE1) 1.8 Caravan CD S/W, Classic CDE, CSE, Elegance, Irmscher, Sport, (X20XE) 2.0 Classic CDX, Coupe', CSX (99-04), Corsa C (14NE) 140i Classic Comfort, Chill, Club, Sport, Lite, Lite+, S, Lite Sport, Sedan, Hatch, (16SE) 1.6i Elegance, Sport, Classic, Elegance Sedan, Hatch, (X17D) 1.7i DTi Hatch, Classic Elegance Sedan, Hatch Dies., 1.8i Hatch GSi, Classic Executive Sedan, Hatch (03-08), Corsa Combo P/Van (Z14XEP) 1.4i Pet. (05-12), Meriva (Z14XEP) 1.4 Essentia MPV, (A14NEL, B14NEL) 1.4T, (Z16XE/P) 1.6 Club, Comfort, Enjoy MPV, (Z17DT/H/R) 1.7 CDTi Elegance, Enjoy, (Z18XE) 1.8 Elegance, Easytronic MPV (03-15), Zafira I (X18XE1) 1.8i CD Elegance MPV (01-05)</p>
 <p>ID: 19</p>	<p>AR5752 Front Stabilizer Bar Bush</p> <p>Peugeot 206 (TU3JP) 1.4 Popart, X-Line, (TU5JP4) 1.6 CC, SW XS, XT, XT Premium 2A/C (01-08), (EW10J4) 2.0 CC, GTi, GTi 180 Pet., (DW10TD) XT HDi Dies. (01-08)</p>
 <p>ID: 18</p>	<p>AR5753 Front Stabilizer Bar Bush</p> <p>Peugeot 206 (TU3JP) 1.4 Popart, X-Line, (TU5JP4) 1.6 CC, SW XS, XT, XT Premium 2A/C (01-08), (EW10J4) 2.0 CC, GTi, GTi 180 Pet., (DW10TD) XT HDi Dies. (01-08)</p>
 <p>ID: 21</p>	<p>AR5754 Front Stabilizer Bar Bush</p> <p>Peugeot 307 (TU5JP4) 1.6 Estate, XR, XS HDi, XT, (EW10J4) 2.0 CC 100, CC,130, XS, Man., (DW10TD) XS HDi (01-07)</p>
 <p>ID: 20</p>	<p>AR5755 Front Stabilizer Bar Bush</p> <p>Citroen C4 (DV6TED4) 1.6 HDi, (EW10J4S) 2.0 VTS Coupe (05-10); Peugeot 307 (TU5JP4) 1.6 Estate, XR, XS HDi, XT, (EW10J4) 2.0 CC 100, CC,130, XS, Man., (DW10TD) XS HDi (01-07); 308 (EP6-DT/CDTX, DV6TED4) 1.6i,VTi, THP X-Line, XS, XT, CC, SW, Comfort, Premium, GTi, (DW10CTED4) 2.0 HDi CC, SW (2008-)</p>
	<p>AR5757 Shock Rubber - Front</p> <p>Mitsubishi Colt LDV (K67/77T) 2.8D, TD LWB Std. S/cab, Hi-Line S/cab Hi Rider, Hi-Line Raised Body, Pioneer D/cab Hi Rider P/up Dies., (6G72) 3.0i V6 LWB ClubCab K76T P/up Pet. (01-09), Colt LDV 4X4 (K65/75T) 2.4i LWB S/cab, Hi-Line, D/cab, Trailbuster S/cab, P/up Pet., (K77T) 2.8D LWB S/cab, P/up Dies., (K77T) 2.8TD LWB Rodeo D/cab, P/up Turbo Dies., (6G72, K76T) 3.0i V6 LWB Rodeo D/cab, ClubCab, P/up Pet. (98-09), Pajero 4X4 (4M40) 2.8TDi LWB GLS SUV V23C Dies., (6G72) 3.0 6-Cyl. SWB GLS Wagon V43W, V64W Pet. (90-01), (6G74) 3.5 V6 LWB GLS SUV V25/45W Pet. (95-01)</p>
 <p>ID: 18.5, OD: 47, L: 90</p>	<p>AR5759 Front Lower Control Arm Bush - Outer Rear</p> <p>Mitsubishi Colt LDV (4G63) 2.0, i LWB Std., Hi-Line S/cab, K62T P/up, Pet., 2.4i LWB Hi-Line, S/cab, D/cab, Hi Rider K65T, P/up Pet., (4D56) 2.5D LWB Hi-Line, Std., S/cab, K64T P/up Dies. (98-09), Colt LDV (6G72) 3.0i V6 LWB ClubCab K76T P/up Pet. (01-09) - Hi Rider, Colt LDV 4X4 (K65/75T) 2.4i LWB S/cab, Hi-Line, D/cab, Trailbuster S/cab, P/up Pet., (K77T) 2.8D LWB S/cab, P/up Dies., (K77T) 2.8TD LWB Rodeo D/cab, P/up Turbo Dies., (6G72, K76T) 3.0i V6 LWB Rodeo D/cab, ClubCab, P/up Pet. (98-09), Colt LDV 2.0 LWB P/up, 2.0i LWB Hi-Line P/up (04-09), Pajero 4X4 (4M40) 2.8TDi LWB GLS SUV V23C Dies., (6G72) 3.0 6-Cyl. SWB GLS Wagon V43W, V64W Pet. (90-01), (6G74) 3.5 V6 LWB GLS SUV V25/45W Pet. (95-01)</p>

 <p>ID: 20, L: 31, H: 46, W: 42</p>	<p>AR5760 Front Stabilizer Bar Bush - Outer</p> <p>Mitsubishi Colt LDV (K67/77T) 2.8D, TD LWB Std. S/cab, Hi-Line S/cab Hi Rider, Hi-Line Raised Body, Pioneer D/cab Hi Rider P/up Dies., (6G72) 3.0i V6 LWB ClubCab K76T P/up Pet. (01-09), Colt LDV 4X4 (K65/75T) 2.4i LWB S/cab, Hi-Line, D/cab, Trailbuster S/cab, P/up Pet., (K77T) 2.8D LWB S/cab, P/up Dies., (K77T) 2.8TD LWB Rodeo D/cab, P/up Turbo Dies., (6G72, K76T) 3.0i V6 LWB Rodeo D/cab, ClubCab, P/up Pet. (98-09)</p>
 <p>ID: 25, L: 31, H: 44, W: 40</p>	<p>AR5761 Front Stabilizer Bar Bush - Inner</p> <p>Mitsubishi Colt LDV (K67/77T) 2.8D, TD LWB Std. S/cab, Hi-Line S/cab Hi Rider, Hi-Line Raised Body, Pioneer D/cab Hi Rider P/up Dies. (01-09), Colt LDV 4X4 (K65/75T) 2.4i LWB S/cab, Hi-Line, D/cab, Trailbuster S/cab, P/up Pet., (K77T) 2.8D LWB S/cab, P/up Dies. (98-09), Colt LDV 2.0 LWB P/up, 2.0i LWB Hi-Line P/up (04-09)</p>
 <p>ID: 27, L: 31, H: 35, W: 40</p>	<p>AR5762 Front Stabilizer Bar Bush - Inner</p> <p>Mitsubishi Colt LDV (K67/77T) 2.8D, TD LWB Std. S/cab, Hi-Line S/cab Hi Rider, Hi-Line Raised Body, Pioneer D/cab Hi Rider P/up Dies., (6G72) 3.0i V6 LWB ClubCab K76T P/up Pet. (01-09), Colt LDV 4X4 (K77T) 2.8TD LWB Rodeo D/cab, P/up Turbo Dies., (6G72, K76T) 3.0i V6 LWB Rodeo D/cab, ClubCab, P/up Pet. (98-09)</p>
	<p>AR5763 Front Stabilizer Link Grommet</p> <p>Mitsubishi Colt LDV (K67/77T) 2.8D, TD LWB Std. S/cab, Hi-Line S/cab Hi Rider, Hi-Line Raised Body, Pioneer D/cab Hi Rider P/up Dies., (6G72) 3.0i V6 LWB ClubCab K76T P/up Pet. (01-09), Colt LDV 4X4 (K65/75T) 2.4i LWB S/cab, Hi-Line, D/cab, Trailbuster S/cab, P/up Pet., (K77T) 2.8D LWB S/cab, P/up Dies., (K77T) 2.8TD LWB Rodeo D/cab, P/up Turbo Dies., (6G72, K76T) 3.0i V6 LWB Rodeo D/cab, ClubCab, P/up Pet. (98-09), Colt LDV 2.0 LWB P/up, 2.0i LWB Hi-Line P/up (04-09), Pajero 4X4 (4M40) 2.8TDi LWB GLS SUV V23C Dies., (6G72) 3.0 6-Cyl. SWB GLS Wagon V43W, V64W Pet. (90-01), (6G74) 3.5 V6 LWB GLS SUV V25/45W Pet. (95-01)</p>
	<p>AR5765 Engine Mounting - RHS</p> <p>Mitsubishi Pajero 4X4 (4M40) 2.8TDi LWB GLS SUV V23C Dies. (90-01)</p>
	<p>AR5766 Transmission Mounting</p> <p>Mitsubishi Pajero 4X4 (4G54) 2.6 SWB, LWB GLS, SJ25/26/45 SUV Pet. (83-94)</p>
	<p>AR5767 Transmission Mounting</p> <p>Mitsubishi Pajero 4X4 (4G54) 2.6 SWB, LWB GLS, SJ25/26/45 SUV Pet. (83-94)</p>
 <p>ID: 23, L: 30, H: 37, W: 42</p>	<p>AR5768 Rear Stabilizer Bar Bush</p> <p>Mitsubishi Pajero 4X4 (4G54) 2.6 SWB, LWB GLS, SJ25/26/45 SUV Pet. (83-94)</p>
	<p>AR5769 Rear Stabilizer Link Assy.</p> <p>Mitsubishi Pajero 4X4 (4G54) 2.6 SWB, LWB GLS, SJ25/26/45 SUV Pet. (83-94)</p>
	<p>AR5771 Front Stabilizer Link Assy. - LHS</p> <p>Mitsubishi Pajero 4X4 (4G54) 2.6 SWB, LWB GLS, SJ25/26/45 SUV Pet. (83-94)</p>
	<p>AR5772 Front Stabilizer Link Assy. - RHS</p> <p>Mitsubishi Pajero 4X4 (4G54) 2.6 SWB, LWB GLS, SJ25/26/45 SUV Pet. (83-94)</p>



ENGINE MOUNTING & RUBBER BUYERS GUIDE

237

 ID: 21, L: 30.5, H: 36.5, W: 38	AR5802 Front Stabilizer Bar Bush Ford Spectron (F2) 2.2 LWB Bus, P/van Pet. (91-04); Mazda Marathon (F2) 2.2 LWB Bus, P/van Pet. (91-04)
	AR5804 Engine Mounting - RHS Peugeot 206 (TU3JP) 1.4 Popart, X-Line, (TU5JP4) 1.6 CC, SW XS, XT, XT Premium 2A/C (01-08), 206 (EW10J4) 2.0 CC, GTi, GTi 180 Pet., (DW10TD) XT HDi Dies. (01-08), 406 (ES9J4S) 3.0 V6 Coupe, ST, Executive, SV Auto. (96-05)
	AR5805 Engine Mounting - RHS Peugeot 306 (TU5JP) 1.6 XT S/W (95-03)
 ID: 17	AR5807 Front Stabilizer Bar Bush Peugeot 306 (TU5JP) 1.6 XT S/W, (XU10J2/K) 2.0 XSi, Cabrio OHC (95-03)
	AR5808 Accelerator Pedal Rubber Ford Spectron (F2) 2.2 LWB Bus, P/van Pet. (91-04); Mazda Marathon (F2) 2.2 LWB Bus, P/van Pet. (91-04)
	AR5809 Rear Strut Mounting Fiat Uno (156A2) 1.0 Cento, (160A3) 1.1 Fire, Mia, Rio, Tempo, Espresso P/van (90-05), (146C1) 1.4 Beat, Mia, Pacer, Pacer SX, Tempo SX, (146A) 1.4 Turbo (90-98)
	AR5810 Steering Coupling Ford Spectron (F2) 2.2 LWB Bus, P/van Pet. (91-04); Mazda Marathon (F2) 2.2 LWB Bus, P/van Pet. (91-04)
	AR5811 Engine Mounting - Front Fiat Uno (156A2) 1.0 Cento, (160A3) 1.1 Fire, Mia, Rio, Tempo, Espresso P/van (90-05)
	AR5812 Engine Mounting - RHS Fiat Uno (156A2) 1.0 Cento, (160A3) 1.1 Fire, Mia, Rio, Tempo, Espresso P/van (90-05)
 ID: 8.5	AR5813 Engine Mounting - LHS Fiat Uno (156A2) 1.0 Cento, (160A3) 1.1 Fire, Mia, Rio, Tempo, Espresso P/van (90-05)
	AR5815 Rear Axle Subframe Mounting - RHS Peugeot 306 (XU10J2/K) 2.0 XSi, Cabrio OHC (95-03)
	AR5816 Engine Mounting - RHS Fiat Uno (146C1) 1.4 Beat, Mia, Pacer, Pacer SX, Tempo SX, (146A) 1.4 Turbo (90-98)
	AR5817 Engine Mounting - Front Fiat Uno (146C1) 1.4 Beat, Mia, Pacer, Pacer SX, Tempo SX, (146A) 1.4 Turbo (90-98)

	AR5818 Engine Mounting - LHS Fiat Uno (146C1) 1.4 Beat, Mia, Pacer, Pacer SX, Tempo SX, (146A) 1.4 Turbo (90-98)
 ID: 26, OD: 70.5, L: 61/80	AR5820 Front Upper Control Arm Bush - Inner, Front Lower Control Arm Bush - Outer Mercedes-Benz (W203) C-Class C180 (M111.920) 1.8 Classic, C200 (M271.940) 2.0 Classic, S/W, C220 (OM611.962, OM646.963) 2.2 CDi Classic, S/W, Elegance, C230 2.3 Coupe, C240 (M203.086) 2.6 V6 Elegance, S/W, Elegance S/W, C270 (OM612.962) 2.7 CDi 5-Cyl. Elegance, S/W, C320 (M111.946) 3.2 V6 Avantgarde Elegance, SW, (M271.946) C180K, (M271.940) C200K, (OM611.962, OM646.963) C220 CDi, (M271.948) C230K, (M112.912) C240/240T, (OM642.910) C320 CDi, (M272.960) C350 (00-11), (W204) C-Class (M271.910, M271.952) C180K, (M271.950) C200K, (OM651.911) C220 CDi, (M272.947) C300, (OM642.960) C350 CDi, (M272.961) C350 (07-14), (W209) CLK320 (M112.940) 3.2 V6 Elegance, Cabrio (98-05)
	AR5821 Front Stabilizer Bar Bush Peugeot 306 (TU5JP) 1.6 XT S/W, (XU10J2/K) 2.0 XSi, Cabrio OHC (95-03)
 ID: 24, OD: 70.5, L: 45/80	AR5822 Front Lower Control Arm Bush - Inner Mercedes-Benz (W203) C-Class C180 (M111.920) 1.8 Classic, C200 (M271.940) 2.0 Classic, S/W, C220 (OM611.962, OM646.963) 2.2 CDi Classic, S/W, Elegance, C230 2.3 Coupe, C240 (M203.086) 2.6 V6 Elegance, S/W, Elegance S/W, C270 (OM612.962) 2.7 CDi 5-Cyl. Elegance, S/W, C320 (M111.946) 3.2 V6 Avantgarde Elegance, SW, (M271.946) C180K, (M271.940) C200K, (OM611.962, OM646.963) C220 CDi, (M271.948) C230K, (M112.912) C240/240T, (OM642.910) C320 CDi, (M272.960) C350 (00-11)
 ID: 12, OD: 32, L: 55	AR5823 Front Lower Control Arm Bush - Inner Front, L/RHS Fiat Seicento (176B2000) 1.1 S, Sporting (01-03), Uno (156A2) 1.0 Cento, (160A3) 1.1 Fire, Mia, Rio, Tempo, Espresso P/van (90-05), (146C1) 1.4 Beat, Mia, Pacer, Pacer SX, Tempo SX, (146A) 1.4 Turbo (90-98)
 ID: 19, OD: 41, L: 60	AR5824 Front Lower Control Arm Bush - Outer Rear, L/RHS Fiat Seicento (176B2000) 1.1 S, Sporting (01-03), Uno (156A2) 1.0 Cento, (160A3) 1.1 Fire, Mia, Rio, Tempo, Espresso P/van (90-05), (146C1) 1.4 Beat, Mia, Pacer, Pacer SX, Tempo SX, (146A) 1.4 Turbo (90-98)
 ID: 21	AR5825 Front Stabilizer Bar Bush Peugeot 306 (TU5JP) 1.6 XT S/W, (XU10J2/K) 2.0 XSi, Cabrio OHC (95-03), Partner 1.9D P/van, 2.0 Grand Raid HDi Dies. (03-10)
	AR5826 Front Strut Mounting Peugeot 306 (TU5JP) 1.6 XT S/W, (XU10J2/K) 2.0 XSi, Cabrio OHC (95-03)
	AR5827 Rear Axle Subframe Mounting - Rear Peugeot 306 (XU10J2/K) 2.0 XSi, Cabrio OHC (95-03)
	AR5828 Rear Axle Subframe Mounting - LHS Peugeot 306 (XU10J2/K) 2.0 XSi, Cabrio OHC (95-03)

ENGINE MOUNTING & RUBBER BUYERS GUIDE

	AR5831 Transmission Mounting Nissan 1400 (A14S) 1.4 SWB P/van, P/up Pet., B140 (A14S) 1.4 SWB Deluxe, Sport, Std., CHAMP P/up Pet. (80-93)		AR5864 Engine Mounting - L/RHS Nissan 1-Tonner Hardbody (AW/D22) (NA16S, L16SJ) 1.6 SWB P/up Pet., (L18SR) 1.8 SWB, LWB Custom, King Cab P/up Pet., (NA20) 2.0 SWB, LWB Custom P/up Pet., (Z24) 2.4 LWB Custom, Hi Rider, Twincab, SE, SE D/cab Pet. (88-98), (TD25i) 2.5D SWB, LWB, Custom, D/cab, Hi Rider, Twin Cab P/up Dies., (TD27i) 2.7D SWB, LWB, Custom, D/cab, Hi Rider, Twincab, SE D/cab P/up Dies. (88-98), 1-Tonner Hardbody (AW/D22) 4X4 (Z24S) 2.4 LWB Custom, Patrol, Tracker P/up Pet., (TD27i) 2.7D SWB, LWB Hi Rider, Twin Cab, SE, SE D/cab P/up Dies. (88-99), Hardbody (QW/244) (NA20S) 2.0 SWB, LWB SL P/up Pet., (KA20) 2.0i SWB, LWB S/cab, SL, S/cab P/up Pet., (KA24) 2.4i LWB S/cab, SL S/cab, D/cab, SL D/cab, Hi Rider S/cab, D/cab P/up Pet. (98-11), Hardbody NP300 (D22) (KA20DE) 2.0i SWB, LWB S, SE P/up Pet., (KA24DE) 2.4i LWB D/cab, D/cab Hi Rider P/up Pet. (2008-), Patrol (Y61) 4X4 (VG30E) 3.0 V6 LWB Y60 S/W Pet., 3.0Di 6-Cyl. LWB GRX, TDi GL S/W Dies., (TD42) 4.2 6-Cyl. LWB LDF P/up, S/W Dies., 4.5 6-Cyl. LWB P/up Dies., 4.8 6-Cyl. LWB GL, GRX P/up Dies. (95-04), Sani 4X4 (Z22) 2.2 LWB S/W Pet., (Z24) 2.4 LWB Patrol S/W Pet. (86-94), (TD27i) 2.7D LWB D/cab S/W, MKII, Exec. S/W Dies. (90-99), Sani (AW) (Z24) 2.4 LWB D/cab, Hi Rider S/W Pet., (TD25i) 2.5D LWB Custom S/W, Dies., (TD27i) 2.7D LWB MKII, Exec. S/W Dies. (88-99)
	AR5843 Engine Mounting - LHS Nissan Sentra (E13S) 1.3 GL, SX, (E16E/S) 1.6 GL, GX, GXE, GXEi Coupe, SGLi (87-92)		AR5844 Transmission Mounting Nissan Sentra (E13S) 1.3 GL, SX, (E16E/S) 1.6 GL, GX, GXE, GXEi Coupe, SGLi (87-92)
	AR5844 Transmission Mounting Nissan Sentra (E13S) 1.3 GL, SX, (E16E/S) 1.6 GL, GX, GXE, GXEi Coupe, SGLi (87-92)		AR5845 Engine Mounting - Front & Rear Nissan Sentra (E13S) 1.3 GL, SX, (E16E/S) 1.6 GL, GX, GXE, GXEi Coupe, SGLi (87-92), (CA18DE) 1.8i 16V T/cam Coupe, Sedan Exec. (89-92)
	AR5845 Engine Mounting - Front & Rear Nissan Sentra (E13S) 1.3 GL, SX, (E16E/S) 1.6 GL, GX, GXE, GXEi Coupe, SGLi (87-92), (CA18DE) 1.8i 16V T/cam Coupe, Sedan Exec. (89-92)		AR5847 Engine Mounting - LHS Nissan Sentra (CA18DE) 1.8i 16V T/cam Coupe, Sedan Exec. (89-92),
	AR5847 Engine Mounting - LHS Nissan Sentra (CA18DE) 1.8i 16V T/cam Coupe, Sedan Exec. (89-92),		AR5848 Transmission Mounting Nissan Sentra (CA18DE) 1.8i 16V T/cam Coupe, Sedan Exec. (89-92),
	AR5848 Transmission Mounting Nissan Sentra (CA18DE) 1.8i 16V T/cam Coupe, Sedan Exec. (89-92),		AR5852 Engine Mounting - L/RHS Nissan Skyline (R31) (CA20, RB20E) 2.0 GL, GLE, SGi, SGLi, (RB30E) 3.0 6-Cyl. SGLi (87-92)
	AR5852 Engine Mounting - L/RHS Nissan Skyline (R31) (CA20, RB20E) 2.0 GL, GLE, SGi, SGLi, (RB30E) 3.0 6-Cyl. SGLi (87-92)		AR5854 Transmission Mounting Nissan Skyline (R31) (CA20, RB20E) 2.0 Man. GL, GLE, SGi, SGLi, (RB30E) 3.0 6-Cyl. Man. SGLi (87-92)
	AR5854 Transmission Mounting Nissan Skyline (R31) (CA20, RB20E) 2.0 Man. GL, GLE, SGi, SGLi, (RB30E) 3.0 6-Cyl. Man. SGLi (87-92)		AR5855 Transmission Mounting Nissan Skyline (R31) (CA20, RB20E) 2.0 Auto. GL, GLE, SGi, SGLi, (RB30E) 3.0 6-Cyl. Auto. SGLi (87-92)
	AR5855 Transmission Mounting Nissan Skyline (R31) (CA20, RB20E) 2.0 Auto. GL, GLE, SGi, SGLi, (RB30E) 3.0 6-Cyl. Auto. SGLi (87-92)		AR5857 Engine Mounting - L/RHS Nissan 620 (J15) 1.5 SWB, LWB P/up Pet. (73-80), 680 (J15) 1.5 SWB P/up Pet., (SD22) 2.2 LWB P/up Dies. (73-80)
	AR5857 Engine Mounting - L/RHS Nissan 620 (J15) 1.5 SWB, LWB P/up Pet. (73-80), 680 (J15) 1.5 SWB P/up Pet., (SD22) 2.2 LWB P/up Dies. (73-80)		AR5866 Engine Mounting - L/RHS, Transmission Mounting Nissan 1-Tonner Hardbody (AW/D22) (VG30E) 3.0 V6 LWB SE D/cab, Hi Rider P/up Pet. (88-98), 1-Tonner Hardbody (AW/D22) 4X4 (VG30E) 3.0 V6 LWB D/cab, Twincab, Patrol P/up Pet. (88-99), Hardbody (D22, QW/244) (VG30E) 3.0i V6 LWB SL P/up Pet., (VG33E) 3.3 V6 LWB Hi Rider, S/cab, D/cab, KingCab P/up Pet. (98-10), Hardbody (D22, QW/244) 4X4 (ZD30) 3.0 V6 LWB D/cab, SE, SE D/cab, SL P/up Pet. (98-10), Patrol (Y60) 4X4 (VG30E) 3.0 V6 LWB Twin Cab S/W Pet. (90-94), Sani (AW) (VG30E) 3.0 V6 LWB D/cab, MKII, Exec. S/W Pet. (88-99), Sani 4X4 (VG30E) 3.0 V6 LWB D/cab, D/cab Exec., S/W, Mk II, Exec., S/W Pet. (90-99)

ENGINE MOUNTING & RUBBER BUYERS GUIDE

	<p>AR5867 Transmission Mounting Nissan 1-Tonner Hardbody (AW/D22) (VG30E) 3.0 V6 LWB SE D/cab, Hi Rider P/up Pet. (88-98), 1-Tonner Hardbody (AW/D22) 4X4 (Z24S) 2.4 LWB Custom, Patrol, Tracker P/up Pet., (TD27i) 2.7D SWB, LWB Hi Rider, Twin Cab, SE, SE D/cab P/up Dies., (VG30E) 3.0 V6 LWB D/cab, Twincab, Patrol P/up Pet. (88-99), Hardbody (D22, QW/244) (VG30E) 3.0i V6 LWB SL P/up Pet., (ZD30) 3.0D, TD LWB Hi Rider, KingCab, Hi Rider P/up Dies., (QD32) 3.2D LWB SE, SL, SLE, D/cab P/up Dies., (VG33E) 3.3 V6 LWB Hi Rider, S/cab, D/cab, KingCab P/up Pet. (98-10), Hardbody (D22, QW/244) 4X4 (KA24E) 2.4i, (ZD30) 3.0 V6 LWB D/cab, SE, SE D/cab, SL P/up Pet. (98-10), Hardbody (D22, QW/244) 4X4 (QD32) 3.2D LWB SL S/cab, SE D/cab P/up Dies. (99-10), Hardbody NP300 (D22) (YD25DDTi) 2.5 TDi LWB S, SE, D/C, Hi Rider, P/up Dies. (2008-), Hardbody NP300 (D22) 4X4 (KA24DE) 2.4i LWB S/C, D/C Hi Rider P/up Pet. (2008-), Patrol (Y60) 4X4 (VG30E) 3.0 V6 LWB Twin Cab S/W Pet. (90-94), Sani 4X4 (Z22) 2.2 LWB S/W Pet., (Z24) 2.4 LWB Patrol S/W Pet. (86-94), (TD27i) 2.7D LWB D/cab S/W, MKII, Exec. S/W Dies. (90-99), Sani (AW) (VG30E) 3.0 V6 LWB D/cab, MKII, Exec. S/W Pet. (88-99)</p>	 <p>ID: 16, OD: 41, L: 60</p>	<p>AR5890 Front Lower Control Arm Bush - Outer Nissan Langley 1.3, 1.5 Exa, Trebon (85-88), Pulsar 1.3, 1.5 (83-85)</p>
 <p>ID: 17, L: 36.5, H: 37, W: 29.5</p>	<p>AR5871 Front Stabilizer Bar Bush Nissan 1400 (A14S) 1.4 SWB P/van, P/up Pet., B140 (A14S) 1.4 SWB Deluxe, Sport, Std., CHAMP P/up Pet. (80-08)</p>		<p>AR5891 Engine Mounting - LHS Peugeot 406 (XU10J2TE) 2.0 ST, ST Comfort, ST Estate Auto., (8RHY/Z, DW10TD/ATED) 2.0 HDi, Comfort, Exec. Auto., (ES9J4S) 3.0 V6 Coupe', ST, Executive, SV Auto. (96-05), Expert 2.0 HDi (2008-)</p>
	<p>AR5872 Engine Mounting - Rear (Support Yoke Bush) Citroen Berlingo (XUD9A) 1.9D P/van Dies. (03-10); Peugeot 306 1.8 XT, (XU10J2/K) 2.0 XSi, Cabrio OHC (99-02), Partner 1.9D P/van, 2.0 Grand Raid HDi Dies. (03-10)</p>	 <p>ID: 10, OD: 46, L: 69</p>	<p>AR5893 Lower Control Arm Bush - Rear Outer Nissan Langley 1.3, 1.5 Exa (85-88), Pulsar 1.3, 1.5 (83-85)</p>
 <p>ID: 13, OD: 23, L: 46</p>	<p>AR5873 Shackle Bush - Front Upper Nissan 1400 (A14S) 1.4 SWB P/van, P/up Pet., B140 (A14S) 1.4 SWB Deluxe, Sport, Std., CHAMP P/up Pet. (80-08)</p>	 <p>ID: 23, L: 30, H: 42, W: 36</p>	<p>AR5900 Front Stabilizer Bar Bush Nissan Sentra (E13S) 1.3 GL, SX, (E16E/S) 1.6 GL, GX, GXE, GXEi Coupe, SGLi (87-92), (CA18DE) 1.8i 16V T/cam Coupe, Sedan Exec. (89-92)</p>
	<p>AR5883 Engine Mounting - RHS Peugeot 306 (XU10J2/K) 2.0 XSi, Cabrio OHC (95-03), 406 (XU10J2TE) 2.0 ST, ST Comfort, ST Estate, (8RHY/Z, DW10TD/ATED) 2.0 HDi, Comfort, Exec., (ES9J4S) 3.0 V6 Coupe', ST, Executive, SV Auto. (96-05), Partner 1.9D P/van, 2.0 Grand Raid HDi Dies. (03-09)</p>	 <p>ID: 14.5, OD: 35, L: 40</p>	<p>AR5901 Front & Rear Lateral Link Bush Nissan Sabre (GA16DS) 160 GX, GXi, (SR20DE) 200 GXi (94-02), Sentra (E13S) 1.3 GL, SX, (E16E/S) 1.6 GL, GX, GXE, GXEi Coupe, SGLi (87-92), (CA18DE) 1.8i 16V T/cam Coupe, Sedan Exec. (89-92), (GA14DNE/DS) 140, GX, GXi, i, Si, (GA16DNE/S) 160, GSi, GX, GXi, SE, Si, (SR20DE) 200 GSi, STi (92-02)</p>
	<p>AR5884 Front Lower Control Arm Bush - Inner, Front Citroen Berlingo (TU5JP4B) 1.6, (DV6TED4BU, DV6AUTED4) 1.6 HDi 90 16V (2011-), C4 (DV6TED4) 1.6 HDi, (EW10J4S) 2.0 VTS Coupe (05-10); Peugeot 307 (TU5JP4) 1.6 Estate, XR, XS HDi, XT, (EW10J4) 2.0 CC 100, CC,130, XS, Man., (DW10TD) XS HDi (01-07), 308 (EP6-DT/CDTX, DV6TED4) 1.6i,VTi, THP X-Line, XS, XT, CC, SW, Comfort, Premium, GTi, (DW10CTED4) 2.0 HDi CC, SW (2008-), 3008 (EP6-DT) 1.6i Exec., VTi Comfort, THP Premium, (DW10CTED4) 2.0 HDi Exec., Grip (2010-), Partner 1.6 HDi (08-18)</p>	 <p>ID: 19, OD: 42.4, L: 32</p>	<p>AR5904 Rear Stabilizer Link Grommet Nissan Sentra (E13S) 1.3 GL, SX, (E16E/S) 1.6 GL, GX, GXE, GXEi Coupe, SGLi (87-92), (CA18DE) 1.8i 16V T/cam Coupe, Sedan Exec. (89-92)</p>
	<p>AR5885 Front Strut Mounting Citroen Berlingo (TU5JP4B) 1.6, (DV6TED4BU, DV6AUTED4) 1.6 HDi 90 16V (2011-); Peugeot 307 (TU5JP4) 1.6 Estate, XR, XS HDi, XT, (EW10J4) 2.0 CC 100, CC,130, XS, Man., (DW10TD) XS HDi (01-07), Partner 1.6 HDi (08-18)</p>	 <p>ID: 23.5, L: 41, H: 53, W: 59</p>	<p>AR5905 Rear Stabilizer Bar Bush Nissan Sentra (E13S) 1.3 GL, SX, (E16E/S) 1.6 GL, GX, GXE, GXEi Coupe, SGLi (87-92), (CA18DE) 1.8i 16V T/cam Coupe, Sedan Exec. (89-92)</p>
	<p>AR5886 Engine Mounting - LHS Peugeot 306 1.8 XT (99-02), 406 2.0 HDi, Comfort, Exec. (96-05)</p>	 <p>ID: 12, OD: 62, L: 30.5</p>	<p>AR5910 Shock Rubber - Front, Shackle Bush - Rear Lower Nissan Sentra (E13S) 1.3 GL, SX, (E16E/S) 1.6 GL, GX, GXE, GXEi Coupe, SGLi (87-92), (CA18DE) 1.8i 16V T/cam Coupe, Sedan Exec. (89-92)</p>
	<p>AR5889 Engine Mounting - LHS Peugeot 406 (XU10J2TE) 2.0 ST, ST Comfort, ST Estate Man., (8RHY/Z, DW10TD/ATED) 2.0 HDi, Comfort, Exec. Man., (ES9J4S) 3.0 V6 Coupe', ST, Executive Man. (96-05)</p>	 <p>ID: 16, OD: 52, L: 33.5</p>	<p>AR5911 Tension Rod Bush Nissan 200 (78-80), 280 (79-80), Laurel 2.0, 2.8 (78-85), Skyline 1.8, 2.0, 2.8 (82-86)</p>
			<p>AR5914 Engine Mounting - RHS Peugeot 406 (XU10J2TE) 2.0 ST, ST Comfort, ST Estate, (8RHY/Z, DW10TD/ATED) 2.0 HDi, Comfort, Exec. (96-05)</p>
			<p>AR5919 Front Lower Control Arm Bush - Outer Rear Peugeot 406 (XU10J2TE) 2.0 ST, ST Comfort, ST Estate, (8RHY/Z, DW10TD/ATED) 2.0 HDi, Comfort, Exec., (ES9J4S) 3.0 V6 Coupe', ST, Executive, SV Auto. (96-05)</p>
			<p>AR5921 Steering Rack Mounting - RHS Ford Escort MKI / II 1.1 300 SWB P/van Kent Pet., 1.3 30/35/45 SWB P/van Kent Pet., 1.6 45 P/van SWB P/van Kent Pet. (68-81)</p>

ENGINE MOUNTING & RUBBER BUYERS GUIDE

 <p>ID: 22, L: 42, H: 43, W: 37</p>	<p>AR5922 Front Stabilizer Bar Bush Nissan Skyline (R31) (CA20, RB20E) 2.0 GL, GLE, SGI, SGLi, (RB30E) 3.0 6-Cyl. SGLi (87-92)</p>
	<p>AR5924 Engine / X-Member Mounting Nissan Skyline (R31) (CA20, RB20E) 2.0 GL, GLE, SGI, SGLi, (RB30E) 3.0 6-Cyl. SGLi (87-92)</p>
 <p>ID: 14, OD: 36, L: 66</p>	<p>AR5925 Rear Lower Control Arm Bush - Inner & Outer Nissan Skyline (R31) (CA20, RB20E) 2.0 GL, GLE, SGI, SGLi, (RB30E) 3.0 6-Cyl. SGLi (87-92)</p>
	<p>AR5928 Shock Rubber - Front Nissan Skyline (R31) (CA20, RB20E) 2.0 GL, GLE, SGI, SGLi, (RB30E) 3.0 6-Cyl. SGLi (87-92)</p>
 <p>ID: 14, OD: 40</p>	<p>AR5929 Rear Axle Subframe Support Bush Peugeot 406 (XU10J2TE) 2.0 ST, ST Comfort, ST Estate, (8RHY/Z, DW10TD/ATED) 2.0 HDi, Comfort, Exec., (ES9J4S) 3.0 V6 Coupe', ST, Executive, SV Auto. (96-05)</p>
 <p>ID: 14, OD: 37, L: 38/32</p>	<p>AR5931 Front Lower Control Arm Bush - Inner Front Peugeot 406 (XU10J2TE) 2.0 ST, ST Comfort, ST Estate, (8RHY/Z, DW10TD/ATED) 2.0 HDi, Comfort, Exec., (ES9J4S) 3.0 V6 Coupe', ST, Executive, SV Auto. (96-05)</p>
	<p>AR5934 Exhaust Hanger - Middle Nissan Hardbody (D22, QW/244) 4X4 (KA24E) 2.4i, LWB S/cab, SL D/cab, P/up Pet., (TD27i) 2.7D, LWB S/cab, SE, D/cab, P/up Dies., (ZD30) 3.0 V6 LWB D/cab, SE, SE D/cab, SL P/up Pet. (98-10), (ZD30) 3.0TD LWB D/cab, KingCab P/up Dies., (QD32) 3.2D LWB SL S/cab, SE D/cab P/up Dies., (VG33E) 3.3i V6 LWB D/cab, Hi Rider D/cab P/up Pet. (99-10), Hardbody NP300 (D22) 4X4 (KA24DE) 2.4i LWB S/C, D/C Hi Rider P/up Pet., (YD25DDTi) 2.5 TDi LWB S, SE, D/C, D/C Hi Rider P/up Dies. (2008-)</p>
 <p>ID: 14, OD: 45, L: 57</p>	<p>AR5935 Rear Lower Control Arm Bush - Outer Peugeot 406 (XU10J2TE) 2.0 ST, ST Comfort, ST Estate, (8RHY/Z, DW10TD/ATED) 2.0 HDi, Comfort, Exec., (ES9J4S) 3.0 V6 Coupe', ST, Executive, SV Auto. (96-05)</p>
 <p>ID: 20, OD: 37.5, L: 39.5</p>	<p>AR5936 Front Stabilizer Bar Bush Nissan 620 (J15) 1.5 SWB, LWB P/up Pet. (73-80), 680 (J15) 1.5 SWB P/up Pet., (SD22) 2.2 LWB P/up Dies. (73-80)</p>

	<p>AR5937 Exhaust Hanger - Front, Rear Nissan 1-Tonner Hardbody (AW/D22) (TD25i) 2.5D SWB, LWB, Custom, D/cab, Hi Rider, Twin Cab P/up Dies., (TD27i) 2.7D SWB, LWB, Custom, D/cab, Hi Rider, Twincab, SE D/cab P/up Dies., (VG30E) 3.0 V6 LWB SE D/cab, Hi Rider P/up Pet. (88-98), 1-Tonner Hardbody (AW/D22) 4X4 (Z24S) 2.4 LWB Custom, Patrol, Tracker P/up Pet., (TD27i) 2.7D SWB, LWB Hi Rider, Twin Cab, SE, SE D/cab P/up Dies., (VG30E) 3.0 V6 LWB D/cab, Twin Cab, Patrol P/up Pet. (88-99), Hardbody (QW/244) (NA20S) 2.0 SWB, LWB SL P/up Pet., (KA20) 2.0i SWB, LWB S/cab, SL, S/cab P/up Pet., (KA24) 2.4i LWB S/cab, SL S/cab, D/cab, SL D/cab, Hi Rider S/cab, D/cab P/up Pet., (TD27i) 2.7 SE, D/C, TD LWB, S/cab, D/cab, SE P/up Dies. (98-11), Hardbody (D22, QW/244) (VG30E) 3.0i V6 LWB SL P/up Pet., (ZD30) 3.0D, TD LWB Hi Rider, KingCab, Hi Rider P/up Dies., (QD32) 3.2D LWB SE, SL, SLE, D/cab P/up Dies., (VG33E) 3.3 V6 LWB Hi Rider, S/cab, D/cab, KingCab P/up Pet. (98-10), Hardbody (D22, QW/244) 4X4 (KA24E) 2.4i, LWB S/cab, SL D/cab, P/up Pet., (TD27i) 2.7D, LWB S/cab, SE, D/cab, P/up Dies., (ZD30) 3.0 V6 LWB D/cab, SE, SE D/cab, SL P/up Pet. (98-10), (ZD30) 3.0TD LWB D/cab, KingCab P/up Dies., (QD32) 3.2D LWB SL S/cab, SE D/cab P/up Dies., (VG33E) 3.3i V6 LWB D/cab, Hi Rider D/cab P/up Pet. (99-10), Sani 4X4 (Z22) 2.2 LWB S/W Pet., (Z24) 2.4 LWB Patrol S/W Pet. (86-94), Sani (AW) (Z24) 2.4 LWB D/cab, Hi Rider S/W Pet., (TD25i) 2.5D LWB Custom S/W, Dies., (TD27i) 2.7D LWB MKII, Exec. S/W Dies., (VG30E) 3.0 V6 LWB D/cab, MKII, Exec. S/W Pet. (88-99)</p>
	<p>AR5938 Exhaust Hanger - Middle Nissan 1-Tonner Hardbody (AW/D22) (NA16S, L16SJ) 1.6 SWB P/up Pet., (L18SR) 1.8 SWB, LWB Custom, King Cab P/up Pet., (NA20) 2.0 SWB, LWB Custom P/up Pet., (Z24) 2.4 LWB Custom, Hi Rider, Twincab, SE, SE D/cab Pet. (88-98), (TD25i) 2.5D SWB, LWB, Custom, D/cab, Hi Rider, Twin Cab P/up Dies., (TD27i) 2.7D SWB, LWB, Custom, D/cab, Hi Rider, Twincab, SE D/cab P/up Dies., (VG30E) 3.0 V6 LWB SE D/cab, Hi Rider P/up Pet. (88-98), 1-Tonner Hardbody (AW/D22) 4X4 (Z24S) 2.4 LWB Custom, Patrol, Tracker P/up Pet., (TD27i) 2.7D SWB, LWB Hi Rider, Twin Cab, SE, SE D/cab P/up Dies., (VG30E) 3.0 V6 LWB D/cab, SE, SE D/cab, SL P/up Pet. (88-99), Hardbody (QW/244) (NA20S) 2.0 SWB, LWB SL P/up Pet., (KA20) 2.0i SWB, LWB S/cab, SL, S/cab P/up Pet., (KA24) 2.4i LWB S/cab, SL S/cab, D/cab, SL D/cab, Hi Rider S/cab, D/cab P/up Pet., (TD27i) 2.7 SE, D/C, TD LWB, S/cab, D/cab, SE P/up Dies. (98-11), Hardbody (D22, QW/244) (VG30E) 3.0i V6 LWB SL P/up Pet., (ZD30) 3.0D, TD LWB Hi Rider, KingCab, Hi Rider P/up Dies., (QD32) 3.2D LWB SE, SL, SLE, D/cab P/up Dies., (VG33E) 3.3 V6 LWB Hi Rider, S/cab, D/cab, KingCab P/up Pet. (98-10), Hardbody (D22, QW/244) 4X4 (KA24E) 2.4i, LWB S/cab, SL D/cab, P/up Pet., (TD27i) 2.7D, LWB S/cab, SE, D/cab, P/up Dies., (ZD30) 3.0 V6 LWB D/cab, SE, SE D/cab, SL P/up Pet. (98-10), (ZD30) 3.0TD LWB D/cab, KingCab P/up Dies., (QD32) 3.2D LWB SL S/cab, SE D/cab P/up Dies., (VG33E) 3.3i V6 LWB D/cab, Hi Rider D/cab P/up Pet. (99-10), Sani 4X4 (Z22) 2.2 LWB S/W Pet., (Z24) 2.4 LWB Patrol S/W Pet. (86-94), Sani (AW) (Z24) 2.4 LWB D/cab, Hi Rider S/W Pet., (TD25i) 2.5D LWB Custom S/W, Dies., (TD27i) 2.7D LWB MKII, Exec. S/W Dies., (VG30E) 3.0 V6 LWB D/cab, MKII, Exec. S/W Pet. (88-99)</p>

ENGINE MOUNTING & RUBBER BUYERS GUIDE

AR5939 Shock Rubber - Rear



Nissan 1-Tonner Hardbody (AW/D22) (NA16S, L16SJ) 1.6 SWB P/up Pet., (L18SR) 1.8 SWB, LWB Custom, King Cab P/up Pet., (NA20) 2.0 SWB, LWB Custom P/up Pet., (Z24) 2.4 LWB Custom, Hi Rider, Twincab, SE, SE D/cab Pet. (88-98), (TD25i) 2.5D SWB, LWB, Custom, D/cab, Hi Rider, Twin Cab P/up Dies., (TD27i) 2.7D SWB, LWB, Custom, D/cab, Hi Rider, Twincab, SE D/cab P/up Dies., (VG30E) 3.0 V6 LWB SE D/cab, Hi Rider P/up Pet. (88-98), **1-Tonner Hardbody (AW/D22) 4X4** (Z24S) 2.4 LWB Custom, Patrol, Tracker P/up Pet., (TD27i) 2.7D SWB, LWB Hi Rider, Twin Cab, SE, SE D/cab P/up Dies., (VG30E) 3.0 V6 LWB D/cab, Twin Cab, Patrol P/up Pet. (88-99), **Hardbody (QW/244)** (NA20S) 2.0 SWB, LWB SL P/up Pet., (KA20) 2.0i SWB, LWB S/cab, SL, S/cab P/up Pet., (KA24) 2.4i LWB S/cab, SL S/cab, D/cab, SL D/cab, Hi Rider S/cab, D/cab P/up Pet., (TD27i) 2.7 SE, D/C, TD LWB, S/cab, D/cab, SE P/up Dies. (98-11), **Hardbody (D22, QW/244)** (VG30E) 3.0i V6 LWB SL P/up Pet., (ZD30) 3.0D, TD LWB Hi Rider, KingCab, Hi Rider P/up Dies., (QD32) 3.2D LWB SE, SL, SLE, D/cab P/up Dies., (VG33E) 3.3 V6 LWB Hi Rider, S/cab, D/cab, KingCab P/up Pet. (98-10), **Hardbody (D22, QW/244) 4X4** (KA24E) 2.4i, LWB S/cab, SL D/cab, P/up Pet., (TD27i) 2.7D, LWB S/cab, SE, D/cab, P/up Dies., (ZD30) 3.0 V6 LWB D/cab, SE, SE D/cab, SL P/up Pet. (98-10), (ZD30) 3.0TD LWB D/cab, KingCab P/up Dies., (QD32) 3.2D LWB SL S/cab, SE D/cab P/up Dies., (VG33E) 3.3i V6 LWB D/cab, Hi Rider D/cab P/up Pet. (99-10), **Sani (AW)** (Z24) 2.4 LWB D/cab, Hi Rider S/W Pet., (TD25i) 2.5D LWB Custom S/W, Dies., (TD27i) 2.7D LWB MKII, Exec. S/W Dies., (VG30E) 3.0 V6 LWB D/cab, MKII, Exec. S/W Pet. (88-99); **Toyota Cressida (YX72)** (3Y) 2.0 GS, GS Exec., GSE OHV 5-Spd. Man. (89-92), **Dyna (YU80)** (3Y) 2.0, (YU81/2/5/210) (4Y) 2.2, (RU85) (22R) 2.4, (BU81, OWU90) (11B) 3.0, (BU101/41/211) (14B) 3.7, (OWU95) (ADE314N) 3.8, (CWU90/95) (ADE364C, NBU91/96, TBU91/96, ADE364C/N) 4.0 (85-01), **Land Cruiser (FZJ75) 4X4** (1FZ-F) 4.2 GX S/W Pet. 4-Spd. Man. (90-97), (HZJ75) 4X4 (1HZ) 4.2 P/up Dies., 4-Spd. Man. (90-97), **Stallion (KF50)** (5K) 1.5 Commuter, P/up, SR5 P/up, Bus, P/van Pet., 4/5-Spd. Man. (87-91), (YF50) (2Y) 1.8 P/up, (2Y) 1.8 SR5 P/up, P/van, Pet., (LF50) (2L) 2400D P/up Dies. (91-04), **Venture (YF50)** (2Y) 1.8 P/van, 8/10-Seater Pet., 4/5-Spd. Man., (YF51) (4Y) 2.2 10-Seater, Getaway 5-Seater, GLE 9-Seater Pet. 5-Spd. Man. (91-04)

AR5940 Front Stabilizer Bar Bush



Nissan 1-Tonner Hardbody (AW/D22) (NA16S, L16SJ) 1.6 SWB P/up Pet., (L18SR) 1.8 SWB, LWB Custom, King Cab P/up Pet., (NA20) 2.0 SWB, LWB Custom P/up Pet., (Z24) 2.4 LWB Custom, Hi Rider, Twincab, SE, SE D/cab Pet. (88-98), **1-Tonner Hardbody (AW/D22)** (TD25i) 2.5D SWB, LWB, Custom, D/cab, Hi Rider, Twin Cab P/up Dies., (TD27i) 2.7D SWB, LWB, Custom, D/cab, Hi Rider, Twincab, SE D/cab P/up Dies., (VG30E) 3.0 V6 LWB SE D/cab, Hi Rider P/up Pet. (88-98), **1-Tonner Hardbody (AW/D22) 4X4** (Z24S) 2.4 LWB Custom, Patrol, Tracker P/up Pet., (TD27i) 2.7D SWB, LWB Hi Rider, Twin Cab, SE, SE D/cab P/up Dies., (VG30E) 3.0 V6 LWB D/cab, Twincab, Patrol P/up Pet. (88-99), **Patrol (Y60) 4X4** (VG30E) 3.0 V6 LWB Twin Cab S/W Pet. (90-94), (Y61) 4X4 (VG30E) 3.0 V6 LWB Y60 S/W Pet., 3.0Di 6-Cyl. LWB GRX, TDi GL S/W Dies., (TD42) 4.2 6-Cyl. LWB LDF P/up, S/W Dies., 4.5 6-Cyl. LWB P/up Dies., 4.8 6-Cyl. LWB GL, GRX P/up Dies. (95-04), **Sani 4X4** (Z22) 2.2 LWB S/W Pet., (Z24) 2.4 LWB Patrol S/W Pet. (86-94), **Sani (AW)** (Z24) 2.4 LWB D/cab, Hi Rider S/W Pet., (TD25i) 2.5D LWB Custom S/W, Dies., (TD27i) 2.7D LWB MKII, Exec. S/W Dies., (VG30E) 3.0 V6 LWB D/cab, MKII, Exec. S/W Pet. (88-99), **Terrano II 4X4** (TD27) 2.7 Dies. (00-02)

AR5941 Shackle Bush - Front



Nissan E20 (J16) 1.6 SWB Bus, Coach, P/van Pet., (L18) 1.8 SWB, LWB 10, 16-Seater Bus, Coach, Coach, GL, GLE, Econolux, Ekonovan, Ekonowagon Pet. (73-96)

AR5946 Front Lower Control Arm Bush - Inner & Outer



Nissan 1-Tonner Hardbody (AW/D22) (NA16S, L16SJ) 1.6 SWB P/up Pet., (L18SR) 1.8 SWB, LWB Custom, King Cab P/up Pet., (NA20) 2.0 SWB, LWB Custom P/up Pet., (Z24) 2.4 LWB Custom, Hi Rider, Twincab, SE, SE D/cab Pet. (88-98), **1-Tonner Hardbody (AW/D22)** (TD25i) 2.5D SWB, LWB, Custom, D/cab, Hi Rider, Twin Cab P/up Dies., (TD27i) 2.7D SWB, LWB, Custom, D/cab, Hi Rider, Twincab, SE D/cab P/up Dies., (VG30E) 3.0 V6 LWB SE D/cab, Hi Rider P/up Pet. (88-98), **1-Tonner Hardbody (AW/D22) 4X4** (Z24S) 2.4 LWB Custom, Patrol, Tracker P/up Pet., (TD27i) 2.7D SWB, LWB Hi Rider, Twin Cab, SE, SE D/cab P/up Dies., (VG30E) 3.0 V6 LWB D/cab, Twincab, Patrol P/up Pet. (88-99), **Hardbody (QW/244)** (NA20S) 2.0 SWB, LWB SL P/up Pet., (KA20) 2.0i SWB, LWB S/cab, SL, S/cab P/up Pet., (KA24) 2.4i LWB S/cab, SL S/cab, D/cab, SL D/cab, Hi Rider S/cab, D/cab P/up Pet., (TD27i) 2.7 SE, D/C, TD LWB, S/cab, D/cab, SE P/up Dies. (98-11), (VG30E) 3.0i V6 LWB SL P/up Pet., (ZD30) 3.0D, TD LWB Hi Rider, KingCab, Hi Rider P/up Dies., (QD32) 3.2D LWB SE, SL, SLE, D/cab P/up Dies., (VG33E) 3.3 V6 LWB Hi Rider, S/cab, D/cab, KingCab P/up Pet. (98-10), **Hardbody (D22, QW/244) 4X4** (KA24E) 2.4i, LWB S/cab, SL D/cab, P/up Pet., (TD27i) 2.7D, LWB S/cab, SE, D/cab, P/up Dies., (ZD30) 3.0 V6 LWB D/cab, SE, SE D/cab, SL P/up Pet. (98-10), (ZD30) 3.0TD LWB D/cab, KingCab P/up Dies., (QD32) 3.2D LWB SL S/cab, SE D/cab P/up Dies., (VG33E) 3.3i V6 LWB D/cab, Hi Rider D/cab P/up Pet. (99-10), **Hardbody NP300 (D22)** (KA20DE) 2.0i SWB, LWB S, SE P/up Pet., (KA24DE) 2.4i LWB D/cab, D/cab Hi Rider P/up Pet., (YD25DDTi) 2.5 TDi LWB S, SE, D/C, D/C Hi Rider, P/up Dies. (2008-), **Hardbody NP300 (D22) 4X4** (KA24DE) 2.4i LWB S/C, D/C Hi Rider P/up Pet., (YD25DDTi) 2.5 TDi LWB S, SE, D/C, D/C Hi Rider P/up Dies. (2008-), **Patrol (Y60) 4X4** (VG30E) 3.0 V6 LWB Twin Cab S/W Pet. (90-94), (Y61) 4X4 (VG30E) 3.0 V6 LWB Y60 S/W Pet., 3.0Di 6-Cyl. LWB GRX, TDi GL S/W Dies., (TD42) 4.2 6-Cyl. LWB LDF P/up, S/W Dies., 4.5 6-Cyl. LWB P/up Dies., 4.8 6-Cyl. LWB GL, GRX P/up Dies. (95-04), **Sani 4X4** (Z22) 2.2 LWB S/W Pet., (Z24) 2.4 LWB Patrol S/W Pet. (86-94), **Sani (AW)** (Z24) 2.4 LWB D/cab, Hi Rider S/W Pet., (TD25i) 2.5D LWB Custom S/W, Dies., (TD27i) 2.7D LWB MKII, Exec. S/W Dies., (VG30E) 3.0 V6 LWB D/cab, MKII, Exec. S/W Pet. (88-99), **Terrano II 4X4** (TD27) 2.7 Dies. (00-02)

AR5947 Tension Rod Bush



Nissan 1-Tonner Hardbody (AW/D22) (NA16S, L16SJ) 1.6 SWB P/up Pet., (L18SR) 1.8 SWB, LWB Custom, King Cab P/up Pet., (NA20) 2.0 SWB, LWB Custom P/up Pet., (Z24) 2.4 LWB Custom, Hi Rider, Twincab, SE, SE D/cab Pet. (88-98), **1-Tonner Hardbody (AW/D22)** (TD25i) 2.5D SWB, LWB, Custom, D/cab, Hi Rider, Twin Cab P/up Dies., (TD27i) 2.7D SWB, LWB, Custom, D/cab, Hi Rider, Twincab, SE D/cab P/up Dies., (VG30E) 3.0 V6 LWB SE D/cab, Hi Rider P/up Pet. (88-98), **1-Tonner Hardbody (AW/D22) 4X4** (Z24S) 2.4 LWB Custom, Patrol, Tracker P/up Pet., (TD27i) 2.7D SWB, LWB Hi Rider, Twin Cab, SE, SE D/cab P/up Dies., (VG30E) 3.0 V6 LWB D/cab, Twincab, Patrol P/up Pet. (88-99), **Hardbody (QW/244)** (NA20S) 2.0 SWB, LWB SL P/up Pet., (KA20) 2.0i SWB, LWB S/cab, SL, S/cab P/up Pet., (KA24) 2.4i LWB S/cab, SL S/cab, D/cab, SL D/cab, Hi Rider S/cab, D/cab P/up Pet., (TD27i) 2.7 SE, D/C, TD LWB, S/cab, D/cab, SE P/up Dies. (98-11), (VG30E) 3.0i V6 LWB SL P/up Pet., (ZD30) 3.0D, TD LWB Hi Rider, KingCab, Hi Rider P/up Dies., (QD32) 3.2D LWB SE, SL, SLE, D/cab P/up Dies., (VG33E) 3.3 V6 LWB Hi Rider, S/cab, D/cab, KingCab P/up Pet. (98-10), **Hardbody NP300 (D22)** (KA20DE) 2.0i SWB, LWB S, SE P/up Pet., (KA24DE) 2.4i LWB D/cab, D/cab Hi Rider P/up Pet., (YD25DDTi) 2.5 TDi LWB S, SE, D/C, D/C Hi Rider, P/up Dies. (2008-), **Patrol (Y60) 4X4** (VG30E) 3.0 V6 LWB Twin Cab S/W Pet. (90-94), (Y61) 4X4 (VG30E) 3.0 V6 LWB Y60 S/W Pet., 3.0Di 6-Cyl. LWB GRX, TDi GL S/W Dies., (TD42) 4.2 6-Cyl. LWB LDF P/up, S/W Dies., 4.5 6-Cyl. LWB P/up Dies., 4.8 6-Cyl. LWB GL, GRX P/up Dies. (95-04), **Sani 4X4** (Z22) 2.2 LWB S/W Pet., (Z24) 2.4 LWB Patrol S/W Pet. (86-94), **Sani (AW)** (Z24) 2.4 LWB D/cab, Hi Rider S/W Pet., (TD25i) 2.5D LWB Custom S/W, Dies., (TD27i) 2.7D LWB MKII, Exec. S/W Dies., (VG30E) 3.0 V6 LWB D/cab, MKII, Exec. S/W Pet. (88-99), **Terrano II 4X4** (TD27) 2.7 Dies. (00-02)

AR5948 Gear Lever Insulator



Nissan E20 (J16) 1.6 SWB Bus, Coach, P/van Pet., (L18) 1.8 SWB, LWB 10, 16-Seater Bus, Coach, Coach, GL, GLE, Econolux, Ekonovan, Ekonowagon Pet. (73-96)

ENGINE MOUNTING & RUBBER BUYERS GUIDE

 ID: 12, OD: 41, L: 41	AR5949 Rear Link Bush No.1 Peugeot 406 (XU10J2TE) 2.0 ST, ST Comfort, ST Estate, (8RHY/Z, DW10TD/ATED) 2.0 HDi, Comfort, Exec., (ES9J4S) 3.0 V6 Coupe', ST, Executive, SV Auto. (96-05)		AR5964 Transmission Mounting Peugeot Boxer (DJ5TED) 2.5TD 1.8 Ton Delivery Van Dies. (02-06)
	AR5950 Rear Axle Beam Bush Peugeot 406 (XU10J2TE) 2.0 ST, ST Comfort, ST Estate, (8RHY/Z, DW10TD/ATED) 2.0 HDi, Comfort, Exec., (ES9J4S) 3.0 V6 Coupe', ST, Executive, SV Auto. (96-05)	 ID: 12.4	AR5965 Engine Mounting - Front Toyota Corolla (AE80) (2A-L) 1.3 FWD GL 8V 4-Spd. Man. (84-88)
	AR5951 Front Lateral Link - RHS Mazda 626 (F6) 1.6 L Hatch, Sedan, S Sedan, SL Hatch Man., (F8) 1.8 L Hatch, Sedan Man., (FE) 2.0 SL Hatch, EG, Sedan, SLi 16 Valve, SLE, 12 Valve, SLX Sedan, Hatch (86-89)		AR5966 Engine Mounting - Rear Toyota Conquest (EE80) (2E-L) 1.3 L, GL 12V 4-Spd. Man. (85-88), Corolla (EE80) (2E-L) 1.3 FWD L, GL OHC 4-Spd. Man. (84-88)
	AR5952 Front Lateral Link - LHS Mazda 626 (F6) 1.6 L Hatch, Sedan, S Sedan, SL Hatch Man., (F8) 1.8 L Hatch, Sedan Man., (FE) 2.0 SL Hatch, EG, Sedan, SLi 16 Valve, SLE, 12 Valve, SLX Sedan, Hatch (86-89)		AR5967 Engine Mounting - LHS Toyota Conquest (EE80) (2E-L) 1.3 L, GL 12V 4-Spd. Man. (85-88), Corolla (AE82) (4A-GE) 1.6 L (84-88), (EE80) (2E-L) 1.3 FWD L, GL OHC 4-Spd. Man. (84-88)
	AR5953 Caliper Link Pin with Rubber Nissan E20 (L18) 1.8 SWB, LWB 10, 16-Seater Bus, Coach, Coach, GL, GLE, Econolux, Ekonovan, Ekonowagon Pet. (73-96)		AR5968 Engine Mounting - Front Toyota Conquest (EE80) (2E-L) 1.3 L, GL 12V 4-Spd. Man. (85-88), Corolla (EE80) (2E-L) 1.3 FWD L, GL OHC 4-Spd. Man. (84-88)
	AR5954 Caliper Link Pin w/o Rubber Nissan E20 (L18) 1.8 SWB, LWB 10, 16-Seater Bus, Coach, Coach, GL, GLE, Econolux, Ekonovan, Ekonowagon Pet. (73-96)		AR5969 Engine Mounting - RHS Toyota Conquest (EE80) (2E-L) 1.3 L, GL 12V 4-Spd. Man. (85-88), Corolla (EE80) (2E-L) 1.3 FWD L, GL OHC 4-Spd. Man. (84-88)
	AR5955 Rear Link Bush No.2 Peugeot 406 (XU10J2TE) 2.0 ST, ST Comfort, ST Estate, (8RHY/Z, DW10TD/ATED) 2.0 HDi, Comfort, Exec., (ES9J4S) 3.0 V6 Coupe', ST, Executive, SV Auto. (96-05)		AR5970 Engine Mounting - Front Toyota Conquest (EE90) (2E-L) 1.3 S, GS 12V 4-Spd. Man., (2E) 130 Zipp, Sport, Tazz, Sport 4-Spd., Tropique, Ruby, Edition, Mc Tazz, XE 12V 5-Spd. Man., (2E) 130 Carri P/van OHC 5-Spd. Man. (88-06), (AE92) (4A-GE) 1.6 RSi Twincam 5-Spd. Man. (88-93), (4A-F) 1.6 RS, Sport DOHC 5-Spd. Man. (88-93), (4A-FE) 160i RS DOHC 4-Spd. Auto. (93-94), Corolla (AE92) (4A-F) 1.6 GL, GLS, Exec., Sprinter, GLE, Sport. (88-93), (4A-FE) 160i GL, GLE, Sprinter, DOHC 4-Spd. Auto. (92-96), (AE93) (7A-FE) 180i FWD GL, GLE, Sprinter, GSE, GSX, DOHC Auto. (93-96), (EE90) (2E, 2E-L) 1.3 FWD L, GL, GLE, Sprinter OHC 4/5-Spd. Man. (88-96)
	AR5956 Rear Lower Control Arm Bush - Inner Peugeot 406 (XU10J2TE) 2.0 ST, ST Comfort, ST Estate, (8RHY/Z, DW10TD/ATED) 2.0 HDi, Comfort, Exec., (ES9J4S) 3.0 V6 Coupe', ST, Executive, SV Auto. (96-05)		AR5972 Engine Mounting - Front Toyota Conquest (AE92) (4A-F) 1.6 LS 3-Spd. Auto. (88-93), Corolla (AE92) (4A-GE) 1.6 DOHC, GLi, GLi Exec., (4A-F) 1.6 DOHC, 5-Spd. Man., 3-Spd. Auto., GL, GLX DOHC 4-Spd. Auto. (88-93), (AE111) (4A-FE) 160i GL, GLE DOHC, 5-Spd. Man., 4-Spd. Auto. (99-02), (AE112) (7A-FE) 180i GLE, GSE DOHC, 5-Spd. Man., 4-Spd. Auto. (99-02)
	AR5957 Front Strut Mounting Peugeot 406 (XU10J2TE) 2.0 ST, ST Comfort, ST Estate, (8RHY/Z, DW10TD/ATED) 2.0 HDi, Comfort, Exec. (96-05)		AR5973 Engine Mounting - RHS Toyota Conquest (AE92) (4A-GE) 1.6 RSi Twincam 5-Spd. Man. (88-93), Corolla (AE92) (4A-F) 1.6 GL, GLS, Exec., Sprinter, GLE, Sport., (4A-GE) 1.6 DOHC, GLi, GLi Exec., (4A-F) 1.6 DOHC, 5-Spd. Man., 3-Spd. Auto., GL, GLX DOHC 4-Spd. Auto. (88-89)
	AR5958 Engine Mounting - Rear Peugeot Boxer (DJ5TED) 2.5TD 1.8 Ton Delivery Van Dies. (02-06)		AR5974 Engine Mounting - Centre Toyota Conquest (AE92) (4A-GE) 1.6 RSi Twincam 5-Spd. Man. (88-93), Corolla (AE92) (4A-F) 1.6 GL, GLS, Exec., Sprinter, GLE, Sport., (4A-GE) 1.6 DOHC, GLi, GLi Exec., (4A-F) 1.6 DOHC, 5-Spd. Man., 3-Spd. Auto., GL, GLX DOHC 4-Spd. Auto. (88-93), (4A-FE) 160i GL, GLE, Sprinter, DOHC 5-Spd. Man., 4-Spd. Auto. (92-96)
	AR5959 Engine Mounting - LHS Peugeot Boxer (DJ5TED) 2.5TD 1.8 Ton Delivery Van Dies. (02-06)		AR5975 Engine Mounting - Rear Toyota Conquest (AE92) (4A-GE) 1.6 RSi Twincam 5-Spd. Man. (88-93), (4A-F) 1.6 RS, Sport DOHC 5-Spd. Man. (88-93), Corolla (AE92) (4A-F) 1.6 GLS, Exec., Sprinter, GLE, Sport. (88-93)
	AR5961 Engine Mounting - RHS Peugeot Boxer (DJ5TED) 2.5TD 1.8 Ton Delivery Van Dies. (02-06)		
	AR5963 Transmission Mounting Toyota Corolla (AE80) (2A-L) 1.3 FWD GL 8V 4-Spd. Man. (84-88)		

ENGINE MOUNTING & RUBBER BUYERS GUIDE

243

	<p>AR5976 Engine Mounting - RHS</p> <p>Toyota Conquest (EE90) (2E-L) 1.3 S, GS 12V 4-Spd. Man., (2E) 130 Zipp, Sport, Tazz, Sport 4-Spd., Tropicque, Ruby, Edition, Mc Tazz, XE 12V 5-Spd. Man., (2E) 130 Carri P/van OHC 5-Spd. Man. (88-06), Corolla (EE90) (2E, 2E-L) 1.3 FWD L, GL, GLE, Sprinter OHC 4/5-Spd. Man. (88-96)</p>		<p>AR5987 Engine Mounting - L/RHS</p> <p>Toyota Cressida (RX70) (21R) 2.0 GL, GLX, GL S/W, (RX72) (22R) 2.4 GLE, GL S/W, GLE S/W, (RX73) (22R) I.R.S. GL, GLE 4/5-Spd. Man./Auto. (87-92)</p>
	<p>AR5977 Engine Mounting - Centre</p> <p>Toyota Conquest (EE90) (2E-L) 1.3 S, GS 12V 4-Spd. Man., (2E) 130 Zipp, Sport, Tazz, Sport 4-Spd., Tropicque, Ruby, Edition, Mc Tazz, XE 12V 5-Spd. Man., (2E) 130 Carri P/van OHC 5-Spd. Man. (88-06), Corolla (EE90) (2E, 2E-L) 1.3 FWD L, GL, GLE, Sprinter OHC 4/5-Spd. Man. (88-96), (EE110) (2E) 130 FWD GLE OHC 5-Spd. Man. (96-02)</p>		<p>AR5989 Front Strut Mounting - LHS</p> <p>Peugeot Boxer (DJ5TED) 2.5TD 1.8 Ton Delivery Van Dies. (02-06)</p>
	<p>AR5978 Engine Mounting - Rear</p> <p>Toyota Conquest (EE90) (2E-L) 1.3 S, GS 12V 4-Spd. Man., (2E) 130 Zipp, Sport, Tazz, Sport 4-Spd., Tropicque, Ruby, Edition, Mc Tazz, XE 12V 5-Spd. Man., (2E) 130 Carri P/van OHC 5-Spd. Man. (88-06), (AE92) (4A-F) 1.6 LS 3-Spd. Auto. (88-93), (4A-FE) 160 i RS DOHC 4-Spd. Auto. (93-94), Corolla (AE92) (4A-F) 1.6 GL, (4A-GE) 1.6 DOHC, GLi, GLi Exec., (4A-F) 1.6 GL (88-93), (4A-FE) 160i GL, GLE, Sprinter, DOHC 4-Spd. Auto. (92-96), (AE93) (7A-FE) 180i FWD GL, GLE, Sprinter, GSE, GSX, DOHC Auto. (93-96), (EE90) (2E, 2E-L) 1.3 FWD L, GL, GLE, Sprinter OHC 4/5-Spd. Man. (88-96)</p>		<p>AR5992 Engine Mounting - L/RHS</p> <p>Toyota Corolla (TE72) (3T) 1.8 RWD GLS, SE OHV 5-Spd. Man., 3/4-Spd. Auto. (80-85)</p>
	<p>AR5979 Engine Mounting - RHS</p> <p>Toyota Conquest (AE92) (4A-F) 1.6 LS 3-Spd. Auto., (4A-F) 1.6 RS, Sport DOHC 5-Spd. Man. (88-93), Corolla (AE92) (4A-F) 1.6 GL, GLS, Exec., Sprinter, GLE, Sport., (4A-GE) 1.6 DOHC, GLi, GLi Exec., (4A-F) 1.6 DOHC, 5-Spd. Man., 3-Spd. Auto., GL, GLX DOHC 4-Spd. Auto. (88-93)</p>		<p>AR5997 Engine Mounting - L/RHS</p> <p>Toyota Land Cruiser (FJ62) 4X4 (3F) 4.0, GX P/up Pet. 5-Spd. Man., 4-Spd. Auto., (2F) 4.2 P/up, GX Pet. 5-Spd. Man., 4-Spd. Auto. (87-90), (FJ75) 4X4 (3F) 4.0 DLX P/up Petrol 5-Spd. Man. (85-90), (HJ75) 4X4 (3F) 4.0 DLX P/up Petrol 5-Spd. Man. (85-90)</p>
	<p>AR5980 Engine Mounting - LHS</p> <p>Toyota Corolla (AE111) (4A-FE) 160i GL, GLE DOHC, 5-Spd. Man. (99-02), (AE112) (7A-FE) 180i GLE, GSE DOHC, 5-Spd. Man. (98-02)</p>		<p>AR5998 Transmission Mounting</p> <p>Toyota Land Cruiser (FJ62) 4X4 (3F) 4.0, GX P/up Pet. 5-Spd., (2F) 4.2 P/up, GX Pet. 5-Spd. Man. (87-90), (FJ75) 4X4 (3F) 4.0 DLX P/up Petrol 5-Spd. Man. (85-92), (HJ60) 4X4 (2H) 4.0, GX P/up Dies., (12H) 4.0 4-Spd. Man. Turbo Dies. 4-Spd. Man. (87-90), (HJ62) 4X4 (2H) 4.0, GX P/up Dies., (12H) 4.0 4-Spd. Man. Turbo Dies. 4-Spd. Man. (87-90), (HJ75) 4X4 (3F) 4.0 DLX P/up Petrol 5-Spd. Man. (85-92), (PHJ75) 4X4 4.0 DLX 236 Perkins Dies. 4-Spd. Man. (1986)</p>
	<p>AR5981 Shackle Bush - Front, Rear Upper</p> <p>Peugeot Boxer (DJ5TED) 2.5TD 1.8 Ton Delivery Van Dies. (02-06)</p> <p>ID: 16, OD: 49.5, L: 87</p>		<p>AR5999 Engine Mounting - L/RHS</p> <p>Toyota Land Cruiser (HJ60) 4X4 (2H) 4.0, GX P/up Dies., (12H) 4.0 4-Spd. Man. Turbo Dies. 4-Spd. Man., Auto. (87-90), (HJ62) 4X4 (2H) 4.0, GX P/up Dies., (12H) 4.0 4-Spd. Man. Turbo Dies. 4-Spd. Man., Auto. (87-90)</p>
	<p>AR5983 Shackle Bush - Rear Lower</p> <p>Peugeot Boxer (DJ5TED) 2.5TD 1.8 Ton Delivery Van Dies. (02-06)</p> <p>ID: 16, OD: 40, L: 46</p>		
	<p>AR5984 Front Strut Mounting - RHS</p> <p>Peugeot Boxer (DJ5TED) 2.5TD 1.8 Ton Delivery Van Dies. (02-06)</p>		
	<p>AR5985 Engine Mounting - L/RHS</p> <p>Toyota Cressida (GX71) (1G-E) 2.0 GLi6 5-Spd. Man., Executive DOHC, (1G-FE) I.R.S. 4-Spd. Auto. (86-89)</p>		
	<p>AR5986 Engine Mounting - RHS</p> <p>Toyota Conquest (AE92) (4A-FE) 160 i RS DOHC 4-Spd. Auto. (93-94), (4A-FE) 160 i RS, Sport, RSE DOHC 5-Spd. Man., (4A-FE) 160 i RSE, XE DOHC 5-Spd. Man. (93-06), Tazz (4A-FE) 160 i RSE, XE DOHC 5-Spd. Man. (93-06), (AE93) (7A-FE) 180 i RS, RSi, Sport DOHC 5-Spd. Man. (93-96), Corolla (AE92) (4A-FE) 160i GL, GLE, Sprinter, DOHC 5-Spd. Man., 4-Spd. Auto. (92-96), (AE93) (7A-FE) 180i FWD GL, GLE, Sprinter, GSE, GSX, DOHC Man., Auto. (93-96)</p>		

ENGINE MOUNTING & RUBBER BUYERS GUIDE

 ID: 12, OD: 37, L: 22	AR6001 Front Stabilizer Link Grommet Peugeot Boxer (DJ5TED) 2.5TD 1.8 Ton Delivery Van Dies. (02-06), (P22DTE) 2.2 HDi "120" 4HU, (P22DTE) 2.2 HDi "130" 4HH, (F1CE0481D, F30DT) 3.0 HDi "130" (2007-)	 ID: 21, OD: 32, L: 60	AR6017 Front Lower Control Arm Bush - Inner Toyota Corolla (TE72) (3T) 1.8 RWD GLS, SE OHV 5-Spd. Man., 3/4-Spd. Auto. (80-85), Cressida (GX71) (1G-E) 2.0 GLi6 5-Spd. Man., Executive DOHC, (1G-FE) I.R.S. 4-Spd. Auto. (86-92), (MX73) (5M-GE) 2.8i RSi, RSi Exec. DOHC 5-Spd. Man., 4-Spd. Auto., (MX75) 3.0 GLS 5-Spd. Man., (ECT) (7M-GE) 3.0i I.R.S. 24V DOHC 4-Spd. Auto. (86-92), (RX70) (21R) 2.0 GL, GLX, GL S/W, (RX72) (22R) 2.4 GLE, GL S/W, GLE S/W, (RX73) (22R) I.R.S. GL, GLE 4/5-Spd. Man./Auto. (87-92), (YX72) (3Y) 2.0 GS, GS Exec., GSE OHV 5-Spd. Man. (89-92)
 OD: 45/56, L: 46	AR6002 Front Lower Control Arm Bush - Inner & Outer, Front & Rear Renault Clio II (D4F) 1.2 Authentique, Expression, Generation, Va Va Voom, (K4J) 1.4 16V, (K7J) 1.4 8V Alaise, Alize, Expression, Privilege, RT, Expression, Priviledge, Va Va Voom, (K9K) 1.5dCi Expression, (K7M) 1.6 Dynamique, Privilege, Sport, (F4R) 2.0 Sport (99-04), Kangoo (E7J780) 1.4 Multix Authentique MPV, Express Van Pet., (K9K) 1.5dCi Express Van Dies. (01-10), (K9K) 1.5dCi, (K7M) 1.6 (03-13), Twingo (D4F) 1.2 Dynamique, '+', (K4M) 1.6 RS, Gordini (08-13)	 ID: 20, OD: 45, L: 36	AR6019 Tension Rod Bush Toyota Conquest (EE80) (2E-L) 1.3 L, GL 12V 4-Spd. Man. (85-88)
	AR6003 Engine Mounting - RHS Renault Clio II (D4F) 1.2 Authentique, Expression, Generation, Va Va Voom, (K4J) 1.4 16V, (K7J) 1.4 8V Alaise, Alize, Expression, Privilege, RT, Expression, Priviledge, Va Va Voom, (K9K) 1.5dCi Expression, (K7M) 1.6 Dynamique, Privilege, Sport, (F4R) 2.0 Sport (99-04), Kangoo (E7J) 1.4 Multix Authentique MPV, Express Van Pet., (K9K) 1.5dCi Express Van Dies. (01-10), (K9K) 1.5dCi, (K7M) 1.6 (03-13), Twingo (K4M) 1.6 RS, Gordini (08-13)	 ID: 13, OD: 24, L: 30	AR6020 Shackle Bush - Rear Upper Toyota Corolla 1.2, 1.6 (75-82)
	AR6004 Engine Mounting - LHS Renault Clio II (D4F) 1.2 Authentique, Expression, Generation, Va Va Voom, (K4J) 1.4 16V, (K7J) 1.4 8V Alaise, Alize, Expression, Privilege, RT, Expression, Priviledge, Va Va Voom, (K9K) 1.5dCi Expression, (K7M) 1.6 Dynamique, Privilege, Sport, (F4R) 2.0 Sport (99-04), Kangoo (E7J) 1.4 Multix Authentique MPV, Express Van Pet., (K9K) 1.5dCi Express Van Dies. (01-10), (K9K) 1.5dCi, (K7M) 1.6 (03-13), Megane I (F3R) 2.0 Cabriolet, RSi Cabriolet, RXE Classic, (F3R, F7R) 2.0 Coupe 16V/8V, RSi Coupe, RXE (96-02), Scenic I 1.4 RTE MPV, 1.6 RT, RXE MPV, 2.0 RXE, RXi MPV (98-02)	 ID: 15, OD: 30, L: 31.5	AR6022 Shackle Bush - Rear Upper Toyota Corolla (TE72) (3T) 1.8 RWD GLS, SE OHV 5-Spd. Man., 3/4-Spd. Auto. (80-85)
	AR6005 Front Strut Mounting Renault Clio II (D4F) 1.2 Authentique, Expression, Generation, Va Va Voom, (K4J) 1.4 16V, (K7J) 1.4 8V Alaise, Alize, Expression, Privilege, RT, Expression, Priviledge, Va Va Voom, (K9K) 1.5dCi Expression, (K7M) 1.6 Dynamique, Privilege, Sport, (F4R) 2.0 Sport (99-04), Kangoo (E7J) 1.4 Multix Authentique MPV, Express Van Pet., (K9K) 1.5dCi Express Van Dies. (01-10), (K9K) 1.5dCi, (K7M) 1.6 (03-13), Twingo (D4F) 1.2 Dynamique, '+', (K4M) 1.6 RS, Gordini (08-13)		AR6022A Shackle Bush - Rear Lower Toyota Corolla (TE72) (3T) 1.8 RWD GLS, SE OHV 5-Spd. Man., 3/4-Spd. Auto. (80-85)
	AR6007 Transmission Mounting GoNow X-Space 4X4 2.2 iL DC, XL DCext. (07-10); GWM Steed 4X4 2.2i D/cab Lux, Multi-Wagon (07-11); Toyota Hilux (LN65) (2L) 2.4 LWB D/cab, Raider, D/Cab Dies. (89-98), (RN67) (22R) 2.4 LWB Raider, D/cab, Raider D/cab Pet. (89-98), (YN67) (4Y) 2.2 LWB Raider D/cab, D/cab P/up Pet. (85-94)		AR6023 Shackle Bush - Front Toyota Corolla (TE72) (3T) 1.8 RWD GLS, SE OHV 5-Spd. Man., 3/4-Spd. Auto. (80-85)
	AR6008 Transmission Mounting GoNow X-Space 4X4 2.8 TDX DCext. (07-10); Toyota Hilux (LN67) (3L) 2.8 LWB P/up, Raider, D/cab Dies. (95-05)	 ID: 18, L: 60, H: 52, W: 49.5	AR6026 Front Lower Control Arm Bush - Outer Rear Toyota Conquest (EE80) (2E-L) 1.3 L, GL 12V 4-Spd. Man. (85-88), Corolla (AE82) (4A-GE) 1.6 L (84-88), (EE80) (2E-L) 1.3 FWD L, GL OHC 4-Spd. Man. (84-88)
	AR6012 Engine Mounting - RHS Toyota Conquest 1.6 (85-88), Corolla 1.6 (86-88)		AR6027 Front Lower Control Arm Bush - Inner Kia Rio I (A3E) 1.3, RS, (A5D) 1.5, RS (00-05)
	AR6014 Engine Mounting - Rear Toyota Corolla (AE80) (2A-L) 1.3 FWD GL 8V 4-Spd. Man. (84-88)	 ID: 14, L: 31, H: 36, W: 32	AR6028 Rear Stabilizer Bar Bush Toyota Conquest (EE80) (2E-L) 1.3 L, GL 12V 4-Spd. Man. (85-88), Corolla (AE82) (4A-GE) 1.6 L (84-88), (EE80) (2E-L) 1.3 FWD L, GL OHC 4-Spd. Man. (84-88)
 ID: 21, L: 32, H: 39, W: 42	AR6016 Front Stabilizer Bar Bush Toyota Corolla (AE82) (4A-GE) 1.6 L (84-88), (EE80) (2E-L) 1.3 FWD L, GL OHC 4-Spd. Man. (84-88)		

ENGINE MOUNTING & RUBBER BUYERS GUIDE

 <p>ID: 14, L: 40, H: 34, W: 47</p>	<p>AR6029 Front Stabilizer Bar Bush</p> <p>Toyota Conquest (EE90) (2E-L) 1.3 S, GS 12V 4-Spd. Man., (2E) 130 Zipp, Sport, Tazz, Sport 4-Spd., Tropique, Ruby, Edition, Mc Tazz, XE 12V 5-Spd. Man., (2E) 130 Carri P/van OHC 5-Spd. Man. (88-06), (AE92) (4A-GE) 1.6 RSi Twincam 5-Spd. Man. (88-93), (4A-F) 1.6 LS 3-Spd. Auto., (4A-F) 1.6 RS, Sport DOHC 5-Spd. Man. (88-93), (4A-FE) 160 i RS DOHC 4-Spd. Auto. (93-94), (4A-FE) 160 i RS, Sport, RSE DOHC 5-Spd. Man., (4A-FE) 160 i RSE, XE DOHC 5-Spd. Man. (93-06), Tazz (4A-FE) 160 i RSE, XE DOHC 5-Spd. Man. (93-06), (AE93) (7A-FE) 180 i RS, RSi, Sport DOHC 5-Spd. Man. (93-96), Corolla (AE92) (4A-F) 1.6 GL, GLS, Exec., Sprinter, GLE, Sport., (4A-GE) 1.6 DOHC, GLi, GLi Exec., (4A-F) 1.6 DOHC, 5-Spd. Man., 3-Spd. Auto., GL, GLX DOHC 4-Spd. Auto. (88-93), (4A-FE) 160i GL, GLE, Sprinter, DOHC 5-Spd. Man., 4-Spd. Auto. (92-96), (AE93) (7A-FE) 180i FWD GL, GLE, Sprinter, GSE, GSX, DOHC Man., Auto. (93-96), (EE90) (2E, 2E-L) 1.3 FWD L, GL, GLE, Sprinter OHC 4/5-Spd. Man. (88-96)</p>
 <p>ID: 18.5, L: 60, W: 59</p>	<p>AR6030 Front Lower Control Arm Bush - Outer Rear</p> <p>Toyota Conquest (EE90) (2E-L) 1.3 S, GS 12V 4-Spd. Man., (2E) 130 Zipp, Sport, Tazz, Sport 4-Spd., Tropique, Ruby, Edition, Mc Tazz, XE 12V 5-Spd. Man., (2E) 130 Carri P/van OHC 5-Spd. Man. (88-06), (AE92) (4A-GE) 1.6 RSi Twincam 5-Spd. Man. (88-93), (4A-F) 1.6 LS 3-Spd. Auto., (4A-F) 1.6 RS, Sport DOHC 5-Spd. Man. (88-93), (4A-FE) 160 i RS DOHC 4-Spd. Auto. (93-94), (4A-FE) 160 i RS, Sport, RSE DOHC 5-Spd. Man., (4A-FE) 160 i RSE, XE DOHC 5-Spd. Man. (93-06), Tazz (4A-FE) 160 i RSE, XE DOHC 5-Spd. Man. (93-06), (AE93) (7A-FE) 180 i RS, RSi, Sport DOHC 5-Spd. Man. (93-96), Corolla (AE92) (4A-F) 1.6 GL, GLS, Exec., Sprinter, GLE, Sport., (4A-GE) 1.6 DOHC, GLi, GLi Exec., (4A-F) 1.6 DOHC, 5-Spd. Man., 3-Spd. Auto., GL, GLX DOHC 4-Spd. Auto. (88-93), (4A-FE) 160i GL, GLE, Sprinter, DOHC 5-Spd. Man., 4-Spd. Auto. (92-96), (AE93) (7A-FE) 180i FWD GL, GLE, Sprinter, GSE, GSX, DOHC Man., Auto. (93-96), (EE90) (2E, 2E-L) 1.3 FWD L, GL, GLE, Sprinter OHC 4/5-Spd. Man. (88-96)</p>
 <p>ID: 14, L: 28, H: 35, W: 36</p>	<p>AR6031 Rear Stabilizer Bar Bush</p> <p>Toyota Conquest (EE90) (2E-L) 1.3 S, GS 12V 4-Spd. Man., (2E) 130 Zipp, Sport, Tazz, Sport 4-Spd., Tropique, Ruby, Edition, Mc Tazz, XE 12V 5-Spd. Man., (2E) 130 Carri P/van OHC 5-Spd. Man. (88-06), (AE92) (4A-GE) 1.6 RSi Twincam 5-Spd. Man. (89-93), (4A-F) 1.6 LS 3-Spd. Auto., (4A-F) 1.6 RS, Sport DOHC 5-Spd. Man. (88-93), (4A-FE) 160 i RS, Sport, RSE DOHC 5-Spd. Man., (4A-FE) 160 i RSE, XE DOHC 5-Spd. Man. (93-06), Tazz (4A-FE) 160 i RSE, XE DOHC 5-Spd. Man. (93-06), (AE93) (7A-FE) 180 i RS, RSi, Sport DOHC 5-Spd. Man. (93-96), Corolla (AE92) (4A-F) 1.6 GL, GLS, Exec., Sprinter, GLE, Sport., (4A-GE) 1.6 DOHC, GLi, GLi Exec., (4A-F) 1.6 DOHC, 5-Spd. Man., 3-Spd. Auto., GL, GLX DOHC 4-Spd. Auto. (88-93), (4A-FE) 160i GL, GLE, Sprinter, DOHC 5-Spd. Man., 4-Spd. Auto. (92-96), (AE93) (7A-FE) 180i FWD GL, GLE, Sprinter, GSE, GSX, DOHC Man., Auto. (93-96), (AE111) (4A-FE) 160i GL, GLE P/S DOHC, 5-Spd. Man., 4-Spd. Auto., (4A-GE) 160i RSi, RXi DOHC 5/6-Spd. Man. (96-99), (4A-FE) 160i GL, GLE DOHC, 5-Spd. Man., 4-Spd. Auto., (4A-GE) 160i Si, RXi, DOHC 5/6-Spd. Man. (99-02), (AE112) (7A-FE) 180i GLE, GSE DOHC, 5-Spd. Man., 4-Spd. Auto. (96-02), (EE90) (2E, 2E-L) 1.3 FWD L, GL, GLE, Sprinter OHC 4/5-Spd. Man. (88-96), (EE110) (2E) 130 FWD GLE OHC 5-Spd. Man. (96-02)</p>
 <p>ID: 20, L: 31, H: 32, W: 40</p>	<p>AR6032 Front Stabilizer Bar Bush</p> <p>Toyota Cressida 1.8, 2.0 (77-81)</p>
 <p>ID: 21, L: 32, H: 38, W: 39.5</p>	<p>AR6036 Front Stabilizer Bar Bush</p> <p>Toyota Camry I (SXV10) (5S-FE) 220 Si, Sei 16V, (SXV11) (3S-FE) 200i, Si, 16V (92-97), (VCV10) (3VZ-FE) 300 SEi Quad Cam 5-Spd. (92-97), Stallion (YF50) (2Y) 1.8 P/up, (2Y) 1.8 SR5 P/up, P/van, Pet., (LF50) (2L) 2400D P/up Dies. (91-04), Venture (YF50) (2Y) 1.8 P/van, 8/10-Seater Pet., 4/5-Spd. Man., (YF51) (4Y) 2.2 10-Seater, Getaway 5-Seater, GLE 9-Seater Pet. 5-Spd. Man., (LF50) (2L) 2.4 10-Seater Dies. 5-Spd. Man. (91-04)</p>

 <p>ID: 11, OD: 22, L: 23.5</p>	<p>AR6037 Rear Stabilizer Link Grommet</p> <p>Toyota Conquest (EE80) (2E-L) 1.3 L, GL 12V 4-Spd. Man. (85-88), Corolla (AE82) (4A-GE) 1.6 L (84-88), (EE80) (2E-L) 1.3 FWD L, GL OHC 4-Spd. Man. (84-88), (AE82) (4A-GE) 1.6 L (84-88), (EE80) (2E-L) 1.3 FWD L, GL OHC 4-Spd. Man. (84-88), Cressida (YX72) (3Y) 2.0 GS, GS Exec., GSE OHV 5-Spd. Man. (89-92), Land Cruiser (FJ62) 4X4 (3F) 4.0, GX P/up Pet. 5-Spd. Man., 4-Spd. Auto., (2F) 4.2 P/up, GX Pet. 5-Spd. Man., 4-Spd. Auto. (87-90), (FZJ80) 4X4 (1FZ-FE, 1HD) 4.5 Std., GX P/up, GX, VX S/W 12V Dies. 5-Spd. Man., 4-Spd. Auto. (90-98), (FZJ100) 4X4 (2UZ-FE) 4.7 VX V8 Petrol 5-Spd. Man., 4-Spd. Auto. (98-03), (FZJ105) 4X4 (1FZ-FE) 4.2 Std., GX P/up Dies. Turbo 5-Spd. Man., 4-Spd. Auto. (98-06), (HDJ80) 4X4 (1FZ-FE, 1HD) 4.5 Std., GX P/up, GX, VX S/W 12V Dies. 5-Spd. Man., 4-Spd. Auto. (90-98), (HDJ100) 4X4 (2UZ-FE) 4.7 VX V8 Petrol 5-Spd. Man., 4-Spd. Auto. (98-03), (1FZ-FE) 4.5 GX, VX S/W Dies. 5-Spd. Man., 4-Spd. Auto. (98-06), (HJ60) 4X4 (2H) 4.0, GX P/up Dies., (12H) 4.0 4-Spd. Man. Turbo Dies. 4-Spd. Man., Auto. (87-90), (HJ62) 4X4 (2H) 4.0, GX P/up Dies., (12H) 4.0 4-Spd. Man. Turbo Dies. 4-Spd. Man., Auto. (87-90), (HZJ105) 4X4 (1HZ) 4.2 GX P/up Dies. Turbo 5-Spd. Man., Auto. (98-06), (UZJ100) 4X4 (2UZ-FE) 4.7 VX V8 Petrol 5-Spd. Man., 4-Spd. Auto. (98-03)</p>
	<p>AR6039 Front Strut Mounting - RHS</p> <p>Kia Rio I (A3E) 1.3, RS, (A5D) 1.5, RS (00-05)</p>
	<p>AR6041 Engine Mounting - RHS</p> <p>Renault Laguna (K4M) 1.6 RT, RTE (96-02), 2.0 RT, RT Estate, RXE (96-00)</p>
	<p>AR6042 Rear Lower Control Arm Bush - Inner & Outer</p> <p>Toyota Cressida (GX71) (1G-E) 2.0 GLi6 5-Spd. Man., Executive DOHC, (1G-FE) I.R.S. 4-Spd. Auto. (86-92), Cressida (MX73) (5M-GE) 2.8i RSi, RSi Exec. DOHC 5-Spd. Man., 4-Spd. Auto., (MX75) 3.0 GLS 5-Spd. Man., (ECT) (7M-GE) 3.0i I.R.S. 24V DOHC 4-Spd. Auto. (86-92), (RX72) (22R) 2.4 GLE, GL S/W, GLE S/W, (RX73) (22R) I.R.S. GL, GLE 4/5-Spd. Man./Auto. (87-92)</p>
	<p>AR6043 Rear Lower Control Arm Bush - Inner & Outer</p> <p>Toyota Cressida (GX71) (1G-E) 2.0 GLi6 5-Spd. Man., Executive DOHC, (1G-FE) I.R.S. 4-Spd. Auto. (86-92), (MX73) (5M-GE) 2.8i RSi, RSi Exec. DOHC 5-Spd. Man., 4-Spd. Auto., (MX75) 3.0 GLS 5-Spd. Man., (ECT) (7M-GE) 3.0i I.R.S. 24V DOHC 4-Spd. Auto. (86-92), (RX72) (22R) 2.4 GLE, GL S/W, GLE S/W, (RX73) (22R) I.R.S. GL, GLE 4/5-Spd. Man./Auto. (87-92)</p>
	<p>AR6047 Front Strut Mounting - LHS</p> <p>Kia Rio I (A3E) 1.3, RS, (A5D) 1.5, RS (00-05)</p>
	<p>AR6048 Brake & Clutch Pedal Rubber</p> <p>Toyota HiAce (YH50) (2Y) 1.8 SWB P/van 4-Spd. Man. Pet., (YH60) (2Y) 1.8 LWB LS Wagon, P/van 5-Spd. Man. Pet. (83-91), (YH53) (4Y) 2.2 SWB LS, GLX, GLX Exec. Wagon, Super10, (YH63) (4Y) 2.2 LWB Super16, SuperT, P/van, Siyaya Pet. 5-Spd. Man., 4-Spd. Auto. (86-09)</p>
	<p>AR6049 Accelerator Pedal Rubber</p> <p>Toyota HiAce (YH50) (2Y) 1.8 SWB P/van 4-Spd. Man. Pet., (YH60) (2Y) 1.8 LWB LS Wagon, P/van 5-Spd. Man. Pet. (83-91), (YH53) (4Y) 2.2 SWB LS, GLX, GLX Exec. Wagon, Super10, (YH63) (4Y) 2.2 LWB Super16, SuperT, P/van, Siyaya Pet. 5-Spd. Man., 4-Spd. Auto. (86-09)</p>
	<p>AR6050 Steering Coupling</p> <p>Toyota HiAce (YH50) (2Y) 1.8 SWB P/van 4-Spd. Man. Pet., (YH60) (2Y) 1.8 LWB LS Wagon, P/van 5-Spd. Man. Pet. (83-91), (YH53) (4Y) 2.2 SWB LS, GLX, GLX Exec. Wagon, Super10, (YH63) (4Y) 2.2 LWB Super16, SuperT, P/van, Siyaya Pet. 5-Spd. Man., 4-Spd. Auto. (86-09)</p>







ENGINE MOUNTING & RUBBER BUYERS GUIDE

 <p>ID: 20, OD: 48, L: 47</p>	<p>AR6051 Front Upper Control Arm Bush - Inner Front</p> <p>C.A.M Inyathi (SF491QE) 2.2i Bus, P/van (2006-); Toyota HiAce (YH50) (2Y) 1.8 SWB P/van 4-Spd. Man. Pet., (YH60) (2Y) 1.8 LWB LS Wagon, P/van 5-Spd. Man. Pet. (83-91), (YH53) (4Y) 2.2 SWB LS, GLX, GLX Exec. Wagon, Super10, (YH63) (4Y) 2.2 LWB Super16, SuperT, P/van, Siyaya Pet. 5-Spd. Man., 4-Spd. Auto. (86-09), Hilux (LN192) (5L) 3.0D LWB D-E DLX, Raider D/cab Raised Body Dies., (KZ-TE) 3.0iD LWB D/cab Raider, Legend35 Raider, D/cab, Raider Dies. (98-05), (RZN169) (3RZ-FE) 2.7i LWB P/up, Raider, Raider D/C, SRX D/C, DLX S/C, Legend35, Legend35 D/C Pet. (98-05), (RZN194) (3RZ-FE) 2.7i LWB Legend35, Raider, Raider D/cab, Raised Body Pet. 5-Spd. Man. (98-05)</p>
 <p>ID: 27, OD: 57, L: 74</p>	<p>AR6052 Front Upper Control Arm Bush - Outer Rear</p> <p>C.A.M Inyathi (SF491QE) 2.2i Bus, P/van (2006-); Toyota HiAce (YH50) (2Y) 1.8 SWB P/van 4-Spd. Man. Pet., (YH60) (2Y) 1.8 LWB LS Wagon, P/van 5-Spd. Man. Pet. (83-91), (YH53) (4Y) 2.2 SWB LS, GLX, GLX Exec. Wagon, Super10, (YH63) (4Y) 2.2 LWB Super16, SuperT, P/van, Siyaya Pet. 5-Spd. Man., 4-Spd. Auto. (86-09), Hilux (LN192) (5L) 3.0D LWB D-E DLX, Raider D/cab Raised Body Dies., (KZ-TE) 3.0iD LWB D/cab Raider, Legend35 Raider, D/cab, Raider Dies. (98-05), (RZN169) (3RZ-FE) 2.7i LWB P/up, Raider, Raider D/C, SRX D/C, DLX S/C, Legend35, Legend35 D/C Pet. (98-05), (RZN194) (3RZ-FE) 2.7i LWB Legend35, Raider, Raider D/cab, Raised Body Pet. 5-Spd. Man. (98-05)</p>
 <p>ID: 16.5, OD: 43/45, L: 70</p>	<p>AR6053 Front Lower Control Arm Bush - Inner</p> <p>C.A.M Inyathi (SF491QE) 2.2i Bus, P/van (2006-); Foton Inkunzi (BJ491EQ1) 2.2 Taxi, View (BJ491EQ1) 2.2 Taxi (07-09), Thunda (491EQ1) 2.2i Taxi, (493ZQ) 2.8D Taxi (2010-); Toyota HiAce (YH50) (2Y) 1.8 SWB P/van 4-Spd. Man. Pet., (YH60) (2Y) 1.8 LWB LS Wagon, P/van 5-Spd. Man. Pet. (83-91), (YH53) (4Y) 2.2 SWB LS, GLX, GLX Exec. Wagon, Super10, (YH63) (4Y) 2.2 LWB Super16, SuperT, P/van, Siyaya Pet. 5-Spd. Man., 4-Spd. Auto. (86-95)</p>
 <p>ID: 17.5, L: 31, H: 36, W: 38</p>	<p>AR6054 Front Stabilizer Bar Bush</p> <p>Toyota Stallion (KF50) (5K) 1.5 Commuter, P/up, SR5 P/up, Bus, P/van Pet., 4/5-Spd. Man. (87-91)</p>
 <p>ID: 23, OD: 43, L: 27.5</p>	<p>AR6055 Tension Rod Bush</p> <p>Ford Courier (F6) 1.6 SWB P/up Pet., (F8) 1.8 SWB, LWB P/up Ch. Cab, Std., XLT Pet., (FE) 2.0 XLT LWB P/up Pet., 2.2 D/cab, Explorer, Std., XLT, Leisure SWB, LWB P/up (F2) Pet., (R2) Dies., (WL4) 2.5D TD, Leisure LWB P/up Dies., 3.0 V6 D/cab, Std., L, Leisure, Explorer SWB, LWB P/up, Essex Pet., 3.4 V6 Leisure, D/cab SWB, LWB P/up Pet. (86-00), Courier 4X4 (WL4) 2.5D TD V6 D/cab, Leisure LWB P/up Dies., 3.0 V6 Std., XLT, D/cab, Leisure, Explorer, Exec. LWB P/up Essex Pet., 3.4 V6 Leisure D/cab LWB P/up Pet. (90-00), Ranger 4X4 2.5D TD XL D/cab, XLT, SubCab, XLT Hi Trail, Super Cab XLT LWB P/up Dies., 3.0 TDCi D/cab XLE, SubCab XLT, Hi Trail, Super Cab XLT LWB P/up Dies. (07-12); GoNow X-Space 2.2i DC, DCext. (07-10); GWM Steed 2.2i D/cab Lux, Multi-Wagon (07-11); Mazda B-Series B1600 (F6) SWB Magnum P/up Pet., B1800 (F8) S/LWB Magnum, Drifter P/up Pet., B2000 (FE) LWB Magnum, Drifter P/up Pet., B2200 SWB, LWB D/cab, Magnum, Drifter P/up (F2) Pet., (R2) Dies., B2500D (WL4), TD LWB Drifter, SLX P/up Dies. (82-00), B2600 (4G54) LWB D/cab, Magnum, Drifter, P/up Pet. (86-02), B3000 V6 LWB D/cab, Magnum, Drifter P/up Essex Pet., B3400 V6 LWB D/cab, Magnum P/up Pet. (86-99), B-Series 4X4 B2600 (4G54) V6 LWB D/cab Magnum, Drifter P/up Pet. (86-95), B3000 V6 LWB D/cab, Magnum, Drifter P/up Essex Pet., B3400 V6 LWB D/cab Magnum P/up Pet. (86-99); Toyota Hilux (LN140) (2L) 2.4 SWB DLX P/up Dies. (98-05), (LN145) 2.4 LWB P/up Dies. (98-05), (RN58) (22R) 2.4 LWB S, S D/cab, SR D/cab, SRX, Raider Pet. (84-98), (RZN147) (1RZ-E) 2.0 LWB SR D/cab Pet. 5-Spd. Man., (1RZ-E) 2.0 SWB SR, DLX, S, Pet. 5-Spd. Man. (98-05), (YN51) (2Y) 1.8 SWB S, SR, Raider P/up Pet., 5-Spd. Man. (86-98), (YN56) (2Y) 1.8 LWB P/up 4/5-Spd. Man. Pet. (86-98), (YN58) (4Y) 2.2 LWB Raider, SRX P/up Pet. (84-98), (YN140) (2Y) 1.8 SWB, LWB D/cab, Raider Pet. 5-Spd. Man. (98-05)</p>

	<p>AR6056 Front Strut Mounting - L/RHS</p> <p>Kia Rio I (A3E) 1.3, RS, (A5D) 1.5, RS (00-05)</p>
	<p>AR6057 Steering Coupling</p> <p>Toyota Hilux (LN50) (L) 2.2 SWB P/up Dies. 4-Spd. Man. (84-98), (LN51) (2L) 2.4 SWB S D/cab, Raider P/up Dies. (84-98), (LN55) (L) 2.2 LWB P/up Dies. (84-98), (LN56) (2L) 2.4 LWB Raider, D/cab P/up Dies. (84-98), (LN57) (3L) 2.8 LWB Raider D/cab, P/up Dies. (95-05), (LN65) (2L) 2.4 LWB D/cab, Raider, D/Cab Dies. (89-98), (LN67) (3L) 2.8 LWB P/up, Raider, D/cab Dies. (95-05), (LN140) (2L) 2.4 SWB DLX P/up Dies. (98-05), (LN145) 2.4 LWB P/up Dies. (98-05), (RN58) (22R) 2.4 LWB S, S D/cab, SR D/cab, SRX, Raider Pet. (84-98), (RN67) (22R) 2.4 LWB Raider, D/cab, Raider D/cab Pet. (89-98), (YN51) (2Y) 1.8 SWB S, SR, Raider P/up Pet., 5-Spd. Man. (86-91), (YN56) (2Y) 1.8 LWB P/up 4/5-Spd. Man. Pet. (86-98)</p>
 <p>ID: 22, OD: 50, L: 26</p>	<p>AR6058 Tension Rod Bush</p> <p>GoNow X-Space 2.2i DC, DCext., 2.8 TDX DC (07-10); Toyota Condor (2Y) 1.8 Estate, TE Estate MPV Pet., 2.0i Estate, TE, Estate MPV, (2RZ-E) 2.4i Estate, TE, TX Estate MPV Pet. (00-05), Condor 4X2, 4X4 (2RZ-E) 2.4i Estate, TX Estate MPV Pet., 5-Spd. Man., (5L) 3.0 SWB Estate, TX Estate MPV Dies., (5L) 3.0 Estate, TE Estate MPV Dies. 5-Spd. Man. (00-05), Hilux (LN50) (L) 2.2 SWB P/up Dies. 4-Spd. Man. (84-98), (LN51) (2L) 2.4 SWB S D/cab, Raider P/up Dies. (84-98), (LN55) (L) 2.2 LWB P/up Dies. (84-98), (LN56) (2L) 2.4 LWB Raider, D/cab P/up Dies. (84-98), (LN57) (3L) 2.8 LWB Raider D/cab, P/up Dies. (95-05), Stallion (KF50) (5K) 1.5 Commuter, P/up, SR5 P/up, Bus, P/van Pet., 4/5-Spd. Man. (87-91), (YF50) (2Y) 1.8 P/up, (2Y) 1.8 SR5 P/up, P/van, Pet., (LF50) (2L) 2400D P/up Dies. (91-04), Venture (YF50) (2Y) 1.8 P/van, 8/10-Seater Pet., 4/5-Spd. Man., (YF51) (4Y) 2.2 10-Seater, Getaway 5-Seater, GLE 9-Seater Pet. 5-Spd. Man. (91-04)</p>
 <p>ID: 18.5, OD: 40.5, L: 93</p>	<p>AR6059 Front Lower Control Arm Bush - Inner</p> <p>Ford Courier (FE) 2.0 XLT LWB P/up Pet., 2.2 D/cab, Explorer, Std., XLT, Leisure SWB, LWB P/up (F2) Pet., (R2) Dies., (WL4) 2.5D TD, Leisure LWB P/up Dies., 3.0 V6 D/cab, Std., L, Leisure, Explorer SWB, LWB P/up, Essex Pet., 3.4 V6 Leisure, D/cab SWB, LWB P/up Pet. (86-00), Courier 4X4 (WL4) 2.5D TD V6 D/cab, Leisure LWB P/up Dies., 3.0 V6 Std., XLT, D/cab, Leisure, Explorer, Exec. LWB P/up Essex Pet., 3.4 V6 Leisure D/cab LWB P/up Pet. (90-00); GoNow X-Space 2.2i DC, DCext., 2.8 TDX DC (07-10), X-Space 4X4 2.2 iL DC, XL DCext., 2.8 TDX DCext. (07-10); GWM Steed 2.2i D/cab Lux, Multi-Wagon (07-11), Steed 4X4 2.2i D/cab Lux, Multi-Wagon (07-11); Mazda B-Series B2000 (FE) LWB Magnum, Drifter P/up Pet., B2200 SWB, LWB D/cab, Magnum, Drifter P/up (F2) Pet., (R2) Dies., B2500D (WL4), TD LWB Drifter, SLX P/up Dies. (82-00), B2600 (4G54) LWB D/cab, Magnum, Drifter, P/up Pet. (86-02), B3000 V6 LWB D/cab, Magnum, Drifter P/up Essex Pet., B3400 V6 LWB D/cab, Magnum P/up Pet. (86-99), B-Series 4X4 B2600 (4G54) V6 LWB D/cab Magnum, Drifter P/up Pet. (86-95), B3000 V6 LWB D/cab, Magnum, Drifter P/up Essex Pet., B3400 V6 LWB D/cab Magnum P/up Pet. (86-99), Hilux (LN50) (L) 2.2 SWB P/up Dies. 4-Spd. Man. (84-98), (LN51) (2L) 2.4 SWB S D/cab, Raider P/up Dies. (84-98), (LN55) (L) 2.2 LWB P/up Dies. (84-98), (LN56) (2L) 2.4 LWB Raider, D/cab P/up Dies. (84-98), (LN57) (3L) 2.8 LWB Raider D/cab, P/up Dies. (95-05), (RN58) (22R) 2.4 LWB S, S D/cab, SR D/cab, SRX, Raider Pet. (84-98), (YN51) (2Y) 1.8 SWB S, SR, Raider P/up Pet., 5-Spd. Man. (86-98), (YN56) (2Y) 1.8 LWB P/up 4/5-Spd. Man. Pet. (86-98), (YN58) (4Y) 2.2 LWB Raider, SRX P/up Pet. (84-98)</p>

ENGINE MOUNTING & RUBBER BUYERS GUIDE

 <p>ID: 23, L: 30, H: 34, W: 39</p>	<p>AR6060 Front & Rear Stabilizer Bar Bush</p> <p>Ford Courier (F6) 1.6 SWB P/up Pet., (F8) 1.8 SWB, LWB P/up Ch. Cab, Std., XLT Pet., (FE) 2.0 XLT LWB P/up Pet., 2.2 D/cab, Explorer, Std., XLT, Leisure SWB, LWB P/up (F2) Pet., (R2) Dies., (WL4) 2.5D TD, Leisure LWB P/up Dies., 3.0 V6 D/cab, Std., L, Leisure, Explorer SWB, LWB P/up, Essex Pet., 3.4 V6 Leisure, D/cab SWB, LWB P/up Pet. (86-00), Courier 4X4 (WL4) 2.5D TD V6 D/cab, Leisure LWB P/up Dies., 3.0 V6 Std., XLT, D/cab, Leisure, Explorer, Exec. LWB P/up Essex Pet., 3.4 V6 Leisure D/cab LWB P/up Pet. (90-00); GoNow X-Space 2.2i DC, DCExt. (07-10); GWM Steed 2.2i D/cab Lux, Multi-Wagon (07-11); Mazda B-Series B1600 (F6) SWB Magnum P/up Pet., B1800 (F8) S/LWB Magnum, Drifter P/up Pet., B2000 (FE) LWB Magnum, Drifter P/up Pet., B2200 SWB, LWB D/cab, Magnum, Drifter P/up (F2) Pet., (R2) Dies., B2500D (WL4), TD LWB Drifter, SLX P/up Dies. (82-00), B2600 (4G54) LWB D/cab, Magnum, Drifter, P/up Pet. (86-02), B3000 V6 LWB D/cab, Magnum, Drifter P/up Essex Pet., B3400 V6 LWB D/cab, Magnum P/up Pet. (86-99), B-Series 4X4 B2600 (4G54) V6 LWB D/cab Magnum, Drifter P/up Pet. (86-95), B3000 V6 LWB D/cab, Magnum, Drifter P/up Essex Pet., B3400 V6 LWB D/cab Magnum P/up Pet. (86-99); Toyota Hilux (LN50) (L) 2.2 SWB P/up Dies. (84-98), (LN55) (L) 2.2 LWB P/up Dies. (84-98), (RN58) (22R) 2.4 LWB S, S D/cab, SR D/cab, SRX, Raider Pet. (84-98), (YN51) (2Y) 1.8 SWB S, SR, Raider P/up Pet., 5-Spd. Man. (86-98), (YN56) (2Y) 1.8 LWB P/up 4/5-Spd. Man. Pet. (86-98), Land Cruiser (FJ62) 4X4 (3F) 4.0, GX P/up Pet. 5-Spd. Man., 4-Spd. Auto., (2F) 4.2 P/up, GX Pet. 5-Spd. Man., 4-Spd. Auto. (87-90), (FJ75) 4X4 (3F) 4.0 DLX P/up Petrol 5-Spd. Man. (85-92), (HJ60) 4X4 (2H) 4.0, GX P/up Dies., (12H) 4.0 4-Spd. Man. Turbo Dies. 4-Spd. Man., Auto. (87-90), (HJ62) 4X4 (2H) 4.0, GX P/up Dies., (12H) 4.0 4-Spd. Man. Turbo Dies. 4-Spd. Man., Auto. (87-90), (HJ75) 4X4 (3F) 4.0 DLX P/up Petrol 5-Spd. Man. (85-92), (PHJ75) 4X4 4.0 DLX 236 Perkins Dies. 4-Spd. Man. (1985)</p>
	<p>AR6061 Engine Mounting - Rear</p> <p>Renault Laguna (K4M) 1.6 RT, RTE (99-00), 2.0 RT, RT Estate, RXE (96-00)</p>
 <p>ID: 18.5, OD: 38, L: 42</p>	<p>AR6062 Front Upper Control Arm Bush - Inner Front</p> <p>Toyota Stallion (KF50) (5K) 1.5 Commuter, P/up, SR5 P/up, Bus, P/van Pet., 4/5-Spd. Man. (87-91), (YF50) (2Y) 1.8 P/up, (2Y) 1.8 SR5 P/up, P/van, Pet., (LF50) (2L) 2400D P/up Dies. (91-04), Venture (YF50) (2Y) 1.8 P/van, 8/10-Seater Pet., 4/5-Spd. Man., (YF51) (4Y) 2.2 10-Seater, Getaway 5-Seater, GLE 9-Seater Pet. 5-Spd. Man., (LF50) (2L) 2.4 10-Seater Dies. 5-Spd. Man. (91-04)</p>
 <p>ID: 22.5, OD: 47, L: 74.5</p>	<p>AR6063 Front Upper Control Arm Bush - Outer Rear</p> <p>Toyota Stallion (KF50) (5K) 1.5 Commuter, P/up, SR5 P/up, Bus, P/van Pet., 4/5-Spd. Man. (87-91), (YF50) (2Y) 1.8 P/up, (2Y) 1.8 SR5 P/up, P/van, Pet., (LF50) (2L) 2400D P/up Dies. (91-04), Venture (YF50) (2Y) 1.8 P/van, 8/10-Seater Pet., 4/5-Spd. Man., (YF51) (4Y) 2.2 10-Seater, Getaway 5-Seater, GLE 9-Seater Pet. 5-Spd. Man., (LF50) (2L) 2.4 10-Seater Dies. 5-Spd. Man. (91-04)</p>
 <p>ID: 14.4, OD: 39, L: 67</p>	<p>AR6064 Front Lower Control Arm Bush - Inner</p> <p>Toyota Condor (2Y) 1.8 Estate, TE Estate MPV Pet., 2.0i Estate, TE, Estate MPV, (2RZ-E) 2.4i Estate, TE, TX Estate MPV Pet. (00-05), Condor 4X2 (2RZ-E) 2.4i Estate, TX Estate MPV Pet., 5-Spd. Man., (5L) 3.0 SWB Estate, TX Estate MPV Dies., (5L) 3.0 Estate, TE Estate MPV Dies. 5-Spd. Man. (00-05), Stallion (KF50) (5K) 1.5 Commuter, P/up, SR5 P/up, Bus, P/van Pet., 4/5-Spd. Man. (87-91), (YF50) (2Y) 1.8 P/up, (2Y) 1.8 SR5 P/up, P/van, Pet., (LF50) (2L) 2400D P/up Dies. (91-04)</p>
	<p>AR6065 Steering Coupling</p> <p>Toyota Stallion (KF50) (5K) 1.5 Commuter, P/up, SR5 P/up, Bus, P/van Pet., 4/5-Spd. Man. (90-91), Venture (LF50) (2L) 2.4 10-Seater Dies. 5-Spd. Man. (91-04)</p>

 <p>ID: 24, L: 31.5, H: 35, W: 40</p>	<p>AR6066 Front Stabilizer Bar Bush</p> <p>GoNow X-Space 2.2i DC, DCExt., 2.8 TDX DC (07-10); Toyota Hilux (LN57) (3L) 2.8 LWB Raider D/cab, P/up Dies. (95-05), (LN140) (2L) 2.4 SWB DLX P/up Dies. (98-05), (LN145) 2.4 LWB P/up Dies. (98-05), (LN192) (5L) 3.0D LWB D-E DLX, Raider D/cab Raised Body Dies., (KZ-TE) 3.0iD LWB D/cab Raider, Legend35 Raider, D/cab, Raider Dies. (98-05), (RZN147) (1RZ-E) 2.0 LWB SR D/cab Pet. 5-Spd. Man., (1RZ-E) 2.0 SWB SR, DLX, S, Pet. 5-Spd. Man. (98-05), (RZN169) (3RZ-FE) 2.7i LWB P/up, Raider, Raider D/C, SRX D/C, DLX S/C, Legend35, Legend35 D/C Pet. (98-05), (RZN194) (3RZ-FE) 2.7i LWB Legend35, Raider, Raider D/cab, Raised Body Pet. 5-Spd. Man. (98-05). (YN140) (2Y) 1.8 SWB, LWB D/cab, Raider Pet, 5-Spd. Man. (98-05), RAV4 I (SXA10) 4X4 (3S-FE) 2.0 3/5-Dr. SUV, DOHC, 5-Spd. Man., 4-Spd. Auto. (94-02), RAV4 I (SXA11) 4X4 (3S-FE) 2.0 3/5-Dr. SUV, DOHC, 5-Spd. Man., 4-Spd. Auto. (94-97)</p>
 <p>ID: 12.5, OD: 32.3, L: 50</p>	<p>AR6068 Rear Lower Control Arm Bush - Inner</p> <p>Toyota Conquest (AE92) (4A-F) 1.6 LS 3-Spd. Auto. (88-93), Corolla (AE82) (4A-GE) 1.6 L (84-88), (EE80) (2E-L) 1.3 FWD L, GL OHC 4-Spd. Man. (84-88)</p>
	<p>AR6069 Engine Mounting - Rear</p> <p>Renault Laguna (F3P/P6) 1.8 RN, RN Estate, RT (96-02), 2.0 RT, RT Estate, RXE (96-00)</p>
	<p>AR6070 Transmission Mounting</p> <p>Toyota Cressida (MX75) 3.0 GLS 5-Spd. Man., (ECT) (7M-GE) 3.0i I.R.S. 24V DOHC 4-Spd. Auto. (86-92)</p>
 <p>L: 34, H: 65, W: 55</p>	<p>AR6071 Steering Rack Mounting - RHS</p> <p>Toyota Conquest (EE80) (2E-L) 1.3 L, GL 12V 4-Spd. Man. (85-88), (EE90) (2E-L) 1.3 S, GS 12V 4-Spd. Man., (2E) 130 Zipp, Sport, Tazz, Sport 4-Spd., Tropique, Ruby, Edition, Mc Tazz, XE 12V 5-Spd. Man., (2E) 130 Carri P/van OHC 5-Spd. Man. (88-06), (AE92) (4A-GE) 1.6 RSi Twincam 5-Spd. Man. (88-93), (4A-F) 1.6 LS 3-Spd. Auto., (4A-F) 1.6 RS, Sport DOHC 5-Spd. Man. (88-93), (4A-FE) 160i RS DOHC 4-Spd. Auto. (93-94), (4A-FE) 160i RS, Sport, RSE DOHC 5-Spd. Man., (4A-FE) 160i RSE, XE DOHC 5-Spd. Man. (93-06), Tazz (4A-FE) 160i RSE, XE DOHC 5-Spd. Man. (93-06), (AE93) (7A-FE) 180i RS, RSi, Sport DOHC 5-Spd. Man. (93-96), Corolla (AE82) (4A-GE) 1.6 L (84-88), (EE80) (2E-L) 1.3 FWD L, GL OHC 4-Spd. Man. (84-88), (AE92) (4A-F) 1.6 GL, GLS, Exec., Sprinter, GLE, Sport., (4A-GE) 1.6 DOHC, GLi, GLi Exec., (4A-F) 1.6 DOHC, 5-Spd. Man., 3-Spd. Auto., GL, GLX DOHC 4-Spd. Auto. (88-93), (4A-FE) 160i GL, GLE, Sprinter, DOHC 5-Spd. Man., 4-Spd. Auto. (92-96), (AE93) (7A-FE) 180i FWD GL, GLE, Sprinter, GSE, GSX, DOHC Man., Auto. (93-96), (EE110) (2E) 130 FWD GLE OHC 5-Spd. Man. (96-02)</p>
 <p>ID: 48, L: 33, H: 79, W: 69</p>	<p>AR6072 Steering Rack Mounting - LHS</p> <p>Toyota Conquest (AE92) (4A-GE) 1.6 RSi Twincam 5-Spd. Man. (88-93), (4A-F) 1.6 LS 3-Spd. Auto., (4A-F) 1.6 RS, Sport DOHC 5-Spd. Man. (88-93), (4A-FE) 160i RS DOHC 4-Spd. Auto. (93-94), (AE93) (7A-FE) 180i RS, RSi, Sport DOHC 5-Spd. Man. (93-96) - P/S, Corolla (AE82) (4A-GE) 1.6 L (84-88), (EE80) (2E-L) 1.3 FWD L, GL OHC 4-Spd. Man. (84-88), (AE111) (4A-FE) 160i GL, GLE P/S DOHC, 5-Spd. Man., 4-Spd. Auto., (4A-GE) 160i RSi, RXi DOHC 5/6-Spd. Man. (96-99), (4A-FE) 160i GL, GLE DOHC, 5-Spd. Man., 4-Spd. Auto., (4A-GE) 160i Si, RXi, DOHC 5/6-Spd. Man. (99-02), (AE112) (7A-FE) 180i GLE, GSE DOHC, 5-Spd. Man., 4-Spd. Auto. (96-02)</p>
 <p>ID: 46, L: 31, H: 53, W: 60</p>	<p>AR6073 Steering Rack Mounting - RHS</p> <p>Toyota Cressida (YX72) (3Y) 2.0 GS, GS Exec., GSE OHV 5-Spd. Man. (89-92)</p>

ENGINE MOUNTING & RUBBER BUYERS GUIDE

 ID: 33, OD: 51, L: 38	AR6074 Steering Rack Mounting - LHS Toyota Cressida (YX72) (3Y) 2.0 GS, GS Exec., GSE OHV 5-Spd. Man. (89-92)		AR6089 Front Strut Mounting - LHS Renault Laguna (K4M) 1.6 RT, RTE, (F3P/P6) 1.8 RN, RN Estate, RT, (L7X700) 3.0 RXT V6 (96-02)
 ID: 12/18, L: 882	AR6075 Rear Lateral Link Kia Rio I (A3E) 1.3, RS, (A5D) 1.5, RS (00-05)		AR6090 Front Strut Mounting - RHS Renault Laguna (K4M) 1.6 RT, RTE, (F3P/P6) 1.8 RN, RN Estate, RT, (L7X700) 3.0 RXT V6 (96-02)
	AR6079 Propshaft Coupling Mercedes-Benz (W202) C-Class (M111.920/21) C180 1.8 Classic Man. (94-00)		AR6092 Propshaft Centering Bush Mercedes-Benz (R170) SLK200 (M111.958) 2.0 Kompressor, SLK230 (M111.973, M111.978) 2.3 Kompressor (99-04), (W124) 200, E, E200 (M102.922) 2.0, 220E, E220 (M111.960) 2.2, 230E, E230 (M102.982) 2.3, (M103.940) 260E 2.6 6-Cyl., (M104.942) 280E 2.8 6-Cyl., 300D 3.0 5-Cyl., 300E 3.0 6-Cyl., 320E, E320 (M104.992) 3.2 6-Cyl., Sportline (86-96), (W126) 280S, SE (M110.987/89) 2.8 6-Cyl., 300SE (M103.981) 3.0 6-Cyl., 380SE (M116.963) 3.8 V8, 420SE (M116.965) 4.2 V8, 500SE (M117.965) 5.0 V8 (86-93), (W140) S-Class S320 (M104.994) 3.2 6-Cyl., S420 (M119.971) 4.2 V8, S500 (M119.970) 5.0 8-Cyl. (93-99), (W201) 190E (M102.920) 1.8, (M102.922) 2.0, (M102.983) 2.3 Sportline (93-94), (W202) C-Class (M111.920/21) C180 1.8 Classic, (M111.941) C200 2.0 Classic, Elegance, C220 (M111.961) 2.2 Classic, Elegance, C230 (M111.974) 2.3 Classic, Elegance, Kompressor, Sport, C240 (M112.910) 2.4 Classic, Elegance, C250D, TD (M605.910) 2.5 5-Cyl., C280 (M104.941) 2.8 6-Cyl. Elegance (94-00), (W208) CLK230 (M111.973/5) 2.3 Kompressor, CLK320 (M112.940) 3.2 V6 Cabrio (98-05), (W209) CLK320 (M112.940) 3.2 V6 Elegance, Cabrio (98-05), (W210) E-Class E200K (M111.957) 2.0, E230 (M111.970) 2.3, E240 (M112.911) 2.4, E280 (M112.921) 2.8 V6, E320 (M104.995, M112.941) 3.2 V6, E430 (M113.940) 4.3 V8 (96-02)
 ID: 33, OD: 124, W: 24, PCD: 80 6-HOLES	AR6080 Propshaft Coupling Mercedes-Benz (W202) C-Class (M111.920/21) C180 1.8 Classic Auto. (94-00)		AR6093 Rear Axle Beam Bush - LHS Renault Laguna (F4P7) 1.8 Authentique, Expression, 1.9dCi Expression, 2.0 Expression, (L7X731) 3.0 Privilege (01-09)
 ID: 33, OD: 129, W: 24, PCD: 80 6-HOLES	AR6081 Propshaft Coupling Mercedes-Benz (W202) C-Class (M111.920/21) C180 1.8 Classic Auto. (94-00)		AR6094 Rear Axle Beam Bush - RHS Renault Laguna (F4P7) 1.8 Authentique, Expression, 1.9dCi Expression, 2.0 Expression, (L7X731) 3.0 Privilege (01-09)
 ID: 37, OD: 138, W: 44, PCD: 90 6-HOLES	AR6082 Propshaft Coupling Mercedes-Benz (W202) C-Class C200 (M111.941) 2.0 Auto. Classic, Elegance, C220 (M111.961) 2.2 Auto. Classic, Elegance, C230 (M111.974) 2.3 Auto. Classic, Elegance, Kompressor, Sport (94-00)		AR6095 Engine Mounting - Rear Renault Laguna 1.9dCi Expression, 2.0 Expression (01-09)
 ID: 41, OD: 150, W: 48, PCD: 100 6-HOLES	AR6084 Propshaft Coupling Mercedes-Benz (W202) C250D, TD (M605.910) 2.5 5-Cyl. Man. (94-00)		AR6096 Engine Mounting - RHS Renault Laguna 2.0 RT, RT Estate, RXE (96-00)
	AR6085 Transmission Mounting Renault Laguna (F3P/P6) 1.8 RN, RN Estate, RT (96-02), 2.0 RT, RT Estate, RXE (96-00), (F4P7) 1.8 Authentique, Expression (01-09)		AR6097 Engine Mounting - RHS Renault Laguna 2.0 RT, RT Estate, RXE (96-00)
	AR6086 Engine Mounting - RHS Renault Laguna (F3P/P6) 1.8 RN, RN Estate, RT (96-02), (F4P7) 1.8 Authentique, Expression (01-09)		AR6098 Front Lower Control Arm Bush - Inner & Outer, Rear Nissan Primaster (F9Q760) 1.9dCi Minibus (07-11); Opel Vivaro (F9Q760) 1.9 CDTi P/van, Enjoy Bus Dies., (F4R720) 2.0i P/van Pet. (06-15); Renault Laguna (F4P7) 1.8 Authentique, Expression, 1.9dCi Expression, 2.0 Expression, (L7X731) 3.0 Privilege (01-09), Traffic (F9Q760) 1.9dCi MPV, 100 Panel Van Dies. (05-07)
	AR6087 Engine Mounting - Rear Renault Laguna (K4M) 1.6 RT, RTE, (F3P/P6) 1.8 RN, RN Estate, RT, (L7X700) 3.0 RXT V6 (96-02), (F4P7) 1.8 Authentique, Expression (01-09)	 ID: 15, OD: 58, H: 30/54	AR6099 Front Lower Control Arm Bush - Outer Renault Laguna (F4P7) 1.8 Authentique, Expression, 1.9dCi Expression, 2.0 Expression, (L7X731) 3.0 Privilege (01-09)
 ID: 13, OD: 59, L: 56	AR6088 Front Lower Control Arm Bush - Inner Renault Laguna (K4M) 1.6 RT, RTE (99-00), 2.0 RT, RT Estate, RXE (96-00)	 ID: 18, OD: 55, L: 50	









ENGINE MOUNTING & RUBBER BUYERS GUIDE

 <p>ID: 12, OD: 60, H: 69.3</p>	<p>AR6102 Front Lower Control Arm Bush - Inner & Outer, Front</p> <p>Opel Corsa C (14NE) 140i Classic Comfort, Chill, Club, Sport, Lite, Lite+, S, Lite Sport, Sedan, Hatch, (16SE) 1.6i Elegance, Sport, Classic, Elegance Sedan, Hatch, (X17D) 1.7i DTi Hatch, Classic Eleganc Sedan, Hatch Dies., 1.8i Hatch GSi, Classic Executive Sedan, Hatch (03-08), Corsa LDV II (14XE) 1.4i Utility S, Sport, Club, P/up Pet., (Y17DT) 1.7D Utility, Sport, Club DTi P/up Dies., (Z18XEL) 1.8i Utility, Sport, Club, P/up (02-10), Corsa Combo P/ivan (Z14XEP) 1.4i Pet. (05-12), Meriva (Z14XEP) 1.4 Essentia MPV, (A14NEL, B14NEL) 1.4T, (Z16XE/P) 1.6 Club, Comfort, Enjoy MPV, (Z17DT/H/R) 1.7 CDTi Elegance, Enjoy, (Z18XE) 1.8 Elegance, Easytronic MPV (03-15)</p>	 <p>ID: 10, OD: 30, L: 62</p>	<p>AR6107 Front Lower Control Arm Bush - Inner Front</p> <p>Volkswagen Caddy (HM, HV, JK) 1.6, i P/up Dies., Pet. 4-Spd. Man., (HV) 1.8 L Sport, Sport, P/up (81-03), Citi Golf 1.3 L, Chico, L Shuttle 4-Spd. Man., Chico Lux, (HM) 1.6 L, Chico Lux, Deco, Designa, Blues, Ritz, Shuttle, Sonic, Sport Chico 4/5-Spd. Man., 3-Spd. Auto., (BZF) 1.8 CTi, Designa, L Sport, 5-Spd. Man. (83-02), 1.4 L, Chico, (AGY, BSY) 1.4i, L, Citi.com, VeloCiti, TenaCiti, CitiStorm, Sport, Rox, Rhythm Man., (AFX) 1.6i Life, Velociti, TenaCiti, CitiStorm, Sport, Rox 5-Spd. Man. (99-09), Fox 1.3 L, L Trippa 4-Spd. Man., 1.6 L 4/5-Spd. Man., 3-Spd. Auto., 1.8 L Sport 5-Spd. Man. (87-96)</p>
 <p>ID: 12.5, OD: 60, L: 27/45</p>	<p>AR6103 Front Lower Control Arm Bush - Inner & Outer, Rear</p> <p>Opel Corsa C (14NE) 140i Classic Comfort, Chill, Club, Sport, Lite, Lite+, S, Lite Sport, Sedan, Hatch, (16SE) 1.6i Elegance, Sport, Classic, Elegance Sedan, Hatch, (X17D) 1.7i DTi Hatch, Classic Eleganc Sedan, Hatch Dies., 1.8i Hatch GSi, Classic Executive Sedan, Hatch (03-08), Corsa LDV II (14XE) 1.4i Utility S, Sport, Club, P/up Pet., (Y17DT) 1.7D Utility, Sport, Club DTi P/up Dies., (Z18XEL) 1.8i Utility, Sport, Club, P/up (02-10), Corsa Combo P/ivan (Z14XEP) 1.4i Pet. (05-12), Meriva (Z14XEP) 1.4 Essentia MPV, (A14NEL, B14NEL) 1.4T, (Z16XE/P) 1.6 Club, Comfort, Enjoy MPV, (Z17DT/H/R) 1.7 CDTi Elegance, Enjoy, (Z18XE) 1.8 Elegance, Easytronic MPV (03-15)</p>	 <p>ID: 15, L: 31, H: 44, W: 33</p>	<p>AR6108 Front Stabilizer Bar Bush - Inner</p> <p>Volkswagen Caddy (HM, HV, JK) 1.6, i P/up Dies., Pet. 4-Spd. Man., (HV) 1.8 L Sport, Sport, P/up (81-03), Citi Golf 1.3 L, Chico, L Shuttle 4-Spd. Man., Chico Lux, (HM) 1.6 L, Chico Lux, Deco, Designa, Blues, Ritz, Shuttle, Sonic, Sport Chico 4/5-Spd. Man., 3-Spd. Auto., (BZF) 1.8 CTi, Designa, L Sport, 5-Spd. Man. (83-02), 1.4 L, Chico, (AGY, BSY) 1.4i, L, Citi.com, VeloCiti, TenaCiti, CitiStorm, Sport, Rox, Rhythm Man., (AFX) 1.6i Life, Velociti, TenaCiti, CitiStorm, Sport, Rox 5-Spd. Man. (99-09), Fox 1.3 L, L Trippa 4-Spd. Man., 1.6 L 4/5-Spd. Man., 3-Spd. Auto., 1.8 L Sport 5-Spd. Man. (87-96)</p>
 <p>ID: 11, OD: 74.6, L: 42.5</p>	<p>AR6104 Engine Mounting - RHS, Rear LHS</p> <p>Volkswagen Caddy (HM, HV, JK) 1.6, i P/up Dies., Pet. 4-Spd. Man., (HV) 1.8 L Sport, Sport, P/up (81-03), Citi Golf 1.3 L, Chico, L Shuttle 4-Spd. Man., Chico Lux, (HM) 1.6 L, Chico Lux, Deco, Designa, Blues, Ritz, Shuttle, Sonic, Sport Chico 4/5-Spd. Man., 3-Spd. Auto., (BZF) 1.8 CTi, Designa, L Sport, 5-Spd. Man. (83-02), 1.4 L, Chico, (AGY, BSY) 1.4i, L, Citi.com, VeloCiti, TenaCiti, CitiStorm, Sport, Rox, Rhythm Man., (AFX) 1.6i Life, Velociti, TenaCiti, CitiStorm, Sport, Rox 5-Spd. Man. (99-09), Fox 1.3 L, L Trippa 4-Spd. Man., 1.6 L 4/5-Spd. Man., 3-Spd. Auto., 1.8 L Sport 5-Spd. Man. (87-96)</p>	 <p>ID: 10, L: 19, H: 36.5, W: 36.5</p>	<p>AR6109 Front Stabilizer Bar Bush - Outer</p> <p>Volkswagen Caddy (HM, HV, JK) 1.6, i P/up Dies., Pet. 4-Spd. Man., (HV) 1.8 L Sport, Sport, P/up (81-03), Citi Golf 1.3 L, Chico, L Shuttle 4-Spd. Man., Chico Lux, (HM) 1.6 L, Chico Lux, Deco, Designa, Blues, Ritz, Shuttle, Sonic, Sport Chico 4/5-Spd. Man., 3-Spd. Auto., (BZF) 1.8 CTi, Designa, L Sport, 5-Spd. Man. (83-02), 1.4 L, Chico, (AGY, BSY) 1.4i, L, Citi.com, VeloCiti, TenaCiti, CitiStorm, Sport, Rox, Rhythm Man., (AFX) 1.6i Life, Velociti, TenaCiti, CitiStorm, Sport, Rox 5-Spd. Man. (99-09), Fox 1.3 L, L Trippa 4-Spd. Man., 1.6 L 4/5-Spd. Man., 3-Spd. Auto., 1.8 L Sport 5-Spd. Man. (87-96)</p>
 <p>ID: 10, OD: 64.4, L: 60</p>	<p>AR6104A Engine Mounting - LHS</p> <p>Volkswagen Caddy (HM, HV, JK) 1.6, i P/up Dies., Pet. 4-Spd. Man., (HV) 1.8 L Sport, Sport, P/up (81-96), Citi Golf 1.3 L, Chico, L Shuttle 4-Spd. Man., Chico Lux, (HM) 1.6 L, Chico Lux, Deco, Designa, Blues, Ritz, Shuttle, Sonic, Sport Chico 4/5-Spd. Man., 3-Spd. Auto., (BZF) 1.8 CTi, Designa, L Sport, 5-Spd. Man. (83-02), Fox 1.3 L, L Trippa 4-Spd. Man., 1.6 L 4/5-Spd. Man., 3-Spd. Auto., 1.8 L Sport 5-Spd. Man. (87-96)</p>	 <p>ID: 20, L: 30, H: 35, W: 50</p>	<p>AR6110 Rear Stabilizer Bar Bush - Inner</p> <p>Volkswagen Citi Golf 1.3 L, Chico, L Shuttle 4-Spd. Man., Chico Lux, (HM) 1.6 L, Chico Lux, Deco, Designa, Blues, Ritz, Shuttle, Sonic, Sport Chico 4/5-Spd. Man., 3-Spd. Auto., (BZF) 1.8 CTi, Designa, L Sport, 5-Spd. Man. (83-02), 1.4 L, Chico, (AGY, BSY) 1.4i, L, Citi.com, VeloCiti, TenaCiti, CitiStorm, Sport, Rox, Rhythm Man., (AFX) 1.6i Life, Velociti, TenaCiti, CitiStorm, Sport, Rox 5-Spd. Man. (99-09), Fox 1.3 L, L Trippa 4-Spd. Man., 1.6 L 4/5-Spd. Man., 3-Spd. Auto., 1.8 L Sport 5-Spd. Man. (87-96)</p>
 <p>ID: 21.5, OD: 46, L: 44</p>	<p>AR6105 Engine Mounting - Front</p> <p>Volkswagen Caddy (HM, HV, JK) 1.6, i P/up Dies., Pet. 4-Spd. Man., (HV) 1.8 L Sport, Sport, P/up (81-96), Citi Golf 1.3 L, Chico, L Shuttle 4-Spd. Man., Chico Lux, (HM) 1.6 L, Chico Lux, Deco, Designa, Blues, Ritz, Shuttle, Sonic, Sport Chico 4/5-Spd. Man., 3-Spd. Auto., (BZF) 1.8 CTi, Designa, L Sport, 5-Spd. Man. (83-02), Fox 1.3 L, L Trippa 4-Spd. Man., 1.6 L 4/5-Spd. Man., 3-Spd. Auto., 1.8 L Sport 5-Spd. Man. (87-96)</p>	 <p>ID: 18, L: 39, H: 38, W: 46</p>	<p>AR6111 Rear Stabilizer Bar Bush - Outer</p> <p>Volkswagen Citi Golf 1.3 L, Chico, L Shuttle 4-Spd. Man., Chico Lux, (HM) 1.6 L, Chico Lux, Deco, Designa, Blues, Ritz, Shuttle, Sonic, Sport Chico 4/5-Spd. Man., 3-Spd. Auto., (BZF) 1.8 CTi, Designa, L Sport, 5-Spd. Man. (83-02), 1.4 L, Chico, (AGY, BSY) 1.4i, L, Citi.com, VeloCiti, TenaCiti, CitiStorm, Sport, Rox, Rhythm Man., (AFX) 1.6i Life, Velociti, TenaCiti, CitiStorm, Sport, Rox 5-Spd. Man. (99-09), Fox 1.3 L, L Trippa 4-Spd. Man., 1.6 L 4/5-Spd. Man., 3-Spd. Auto., 1.8 L Sport 5-Spd. Man. (87-96)</p>
 <p>ID: 17, OD: 38, L: 55</p>	<p>AR6106 Front Lower Control Arm Bush - Outer Rear</p> <p>Volkswagen Caddy (HM, HV, JK) 1.6, i P/up Dies., Pet. 4-Spd. Man., (HV) 1.8 L Sport, Sport, P/up (81-03), Citi Golf 1.3 L, Chico, L Shuttle 4-Spd. Man., Chico Lux, (HM) 1.6 L, Chico Lux, Deco, Designa, Blues, Ritz, Shuttle, Sonic, Sport Chico 4/5-Spd. Man., 3-Spd. Auto., (BZF) 1.8 CTi, Designa, L Sport, 5-Spd. Man. (83-02), 1.4 L, Chico, (AGY, BSY) 1.4i, L, Citi.com, VeloCiti, TenaCiti, CitiStorm, Sport, Rox, Rhythm Man., (AFX) 1.6i Life, Velociti, TenaCiti, CitiStorm, Sport, Rox 5-Spd. Man. (99-09), Fox 1.3 L, L Trippa 4-Spd. Man., 1.6 L 4/5-Spd. Man., 3-Spd. Auto., 1.8 L Sport 5-Spd. Man. (87-96)</p>		<p>AR6112 Engine Mounting - LHS Rear</p> <p>Volkswagen Golf II 1.8 GTS 16V, CSX, GTi 8V, 16V, 5-Spd. Man., 3-Spd. Auto., 2.0 GTi 8V, Exec. 16V 5-Spd. Man. (84-92)</p>
	<p>AR6113 Engine Mounting - LHS Front</p> <p>Volkswagen Golf II 1.3 CL 4-Spd. Man., 1.6 CSL 5-Spd. Man., 1.8 GTS 16V, CSX, GTi 8V, 16V, 5-Spd. Man., 3-Spd. Auto. (84-92), Jetta II 1.6 CSL 5-Spd. Man., 1.8 CLI, CLI Exec., Executive, CLX, CSX 5-Spd. Man., 3-Spd. Auto., 2.0 L 16V 5-Spd. Man. (85-92)</p>		<p>AR6114 Engine Mounting - RHS</p> <p>Volkswagen Golf II 1.3 CL 4-Spd. Man., 1.6 CSL 5-Spd. Man., 1.8 GTS 16V, CSX, GTi 8V, 16V, 5-Spd. Man., 3-Spd. Auto., 2.0 GTi 8V, Exec. 16V 5-Spd. Man. (84-92), Jetta II 1.6 CSL 5-Spd. Man., 1.8 CLI, CLI Exec., Executive, CLX, CSX 5-Spd. Man., 3-Spd. Auto., 2.0 L 16V 5-Spd. Man. (85-92)</p>

ENGINE MOUNTING & RUBBER BUYERS GUIDE

	<p>AR6115 Rear Lateral Link - L/RHS</p> <p>Mazda 626 (F6) 1.6 L Hatch, Sedan, S Sedan, SL Hatch Man., (F8) 1.8 L Hatch, Sedan Man., (FE) 2.0 SL Hatch, EGi, Sedan, SLi 16 Valve, SLE, 12 Valve, SLX Sedan, Hatch (86-89)</p>		<p>AR6134 Rear Lower Control Arm Bush - Inner Front & Outer Rear</p> <p>Volkswagen Kombi (T2, T3) 1.8 Microbus, P/van, Volksiebus, 1.9 Microbus, P/van, 2.0 Microbus, P/van, L Exec. Bus, Kamper, P/up, 2.1 Fi Caravelle, Microbus, 2.3 Microbus, Volksiebus, 2.5i Caravelle, Microbus, 2.6i Caravelle, Microbus (74-04), Kombi (T3) 4X4 (DJ) 2.1 Fi Syncro Pet. (89-93), Kombi (T4) (AAB, ACV) 2.5TDi Microbus, Caravelle, Trend, High Dies. (99-03)</p>
	<p>AR6116 Front Stabilizer Bar Bush</p> <p>Volkswagen Golf II 1.3 CL 4-Spd. Man., 1.6 CSL 5-Spd. Man., 1.8 GTS 16V, CSX, GTi 8V, 16V, 5-Spd. Man., 3-Spd. Auto., 2.0 GTi 8V, Exec. 16V 5-Spd. Man. (84-92), Golf III 1.6 GS 5-Spd. Man., 1.8 GSX, GTS 5-Spd. Man., 3-Spd. Auto., 2.0 GTi, 8V GTi Exec. 5-Spd. Man., 2.8 VR6, VR6 Exec. V6 5-Spd. Man., 4-Spd. Auto. (92-99), Jetta II 1.6 CSL 5-Spd. Man., 1.8 CLi, CLi Exec., Executive, CLX, CSX 5-Spd. Man., 3-Spd. Auto., 2.0 L 16V 5-Spd. Man. (85-92), Jetta III 1.6 CSL 5-Spd. Man., 1.8 CLX, CSX 5-Spd. Man., 3-Spd. Auto., 2.0 CLi, CLi Exec. 5-Spd. Man., 2.8 VR6 Exec. V6 5-Spd. Man., 4-Spd. Auto. (92-99), Polo (6N) 1.4i Classic, Playa, 1.6i Classic Lux, Classic, Playa, 1.8i Classic Lux, Playa 5-Spd. Man. (96-03)</p>		<p>AR6135 Shackle Bush - Front</p> <p>Volkswagen Caddy (HM, HV, JK) 1.6, i P/up Dies., Pet. 4-Spd. Man., (HV) 1.8 L Sport, Sport, P/up (81-03)</p>
	<p>AR6117 Engine Mounting - Front</p> <p>Volkswagen Golf II 2.0 GTi 8V, Exec. 16V 5-Spd. Man. (84-92), Jetta II 2.0 L 16V 5-Spd. Man. (85-92)</p>		<p>AR6136 Engine Mounting - L/RHS</p> <p>Volkswagen Kombi (T2, T3) 1.8 Microbus, P/van (74-04)</p>
	<p>AR6128 Transmission Mounting</p> <p>Volkswagen Kombi (T2, T3) 1.8 Microbus, P/van, Volksiebus, 1.9 Microbus, P/van, 2.0 Microbus, P/van, L Exec. Bus, Kamper, P/up, 2.1 Fi Caravelle, Microbus, 2.3 Microbus, Volksiebus, 2.5i Caravelle, Microbus, 2.6i Caravelle, Microbus (74-04)</p>		<p>AR6137 Engine Mounting - Front</p> <p>Renault Megane I (K4M, K7M) 1.6 Classic RT, Classic RXE, Classic RXT, RN Hatch, RSi Coupe, RT Cabriolet, RT Coupe, RT Hatch, RXE, RXE Cab., RXi Cab., RXT (96-02), Scenic I 1.4 RTE MPV, 1.6 RT, RXE MPV (98-02)</p>
	<p>AR6129 Front Upper Control Arm Bush - Inner Front & Outer Rear</p> <p>Volkswagen Kombi (T2, T3) 1.8 Microbus, P/van, Volksiebus, 1.9 Microbus, P/van, 2.0 Microbus, P/van, L Exec. Bus, Kamper, P/up, 2.1 Fi Caravelle, Microbus, 2.3 Microbus, Volksiebus, 2.5i Caravelle, Microbus, 2.6i Caravelle, Microbus (74-04), Kombi (T3) 4X4 (DJ) 2.1 Fi Syncro Pet. (89-93)</p>		<p>AR6142 Engine Mounting - Rear</p> <p>Renault Megane I (K4M, K7M) 1.6 Classic RT, Classic RXE, Classic RXT, RN Hatch, RSi Coupe, RT Cabriolet, RT Coupe, RT Hatch, RXE, RXE Cab., RXi Cab., RXT (96-02), Scenic I 1.4 RTE MPV, 1.6 RT, RXE MPV (98-02)</p>
	<p>AR6130 Shackle Bush - Rear Upper & Lower, Front Lower Control Arm Bush - Inner</p> <p>Volkswagen Caddy (HM, HV, JK) 1.6, i P/up Dies., Pet. 4-Spd. Man., (HV) 1.8 L Sport, Sport, P/up (81-03), Kombi (T2, T3) 1.8 Microbus, P/van, Volksiebus, 1.9 Microbus, P/van, 2.0 Microbus, P/van, L Exec. Bus, Kamper, P/up, 2.1 Fi Caravelle, Microbus, 2.3 Microbus, Volksiebus, 2.5i Caravelle, Microbus, 2.6i Caravelle, Microbus (74-04), Kombi (T3) 4X4 (DJ) 2.1 Fi Syncro Pet. (89-93)</p>		<p>AR6144 Rear Trailing Link</p> <p>Ford Laser (B3, E3) 1.3 Dash, GL, L, Tracer H/B, Sedan, Tonic (86-95), (CHV-FUA) 1.4 L, (E5) 1.5 GL, GLS, Sport (86-92), (B6, F6, CVH) 1.6 i, 16, GL, Sport, Tracer H/B, Sedan, Plus, TX3 (86-91), (FE) 2.0i RS (91-94), Metecor (B3, E3) 1.3 GL, L (86-95), (CVH) 1.4 LX, (E5) 1.5 GL, GLS (86-92), (B6, F6, CVH) 1.6 16, GL, GLE, GLi, Sport (86-91), (FE) 2.0 GLE, GLi (91-94), Tracer (B3, E3) 1.3 H/B, Sedan, Tonic, Plus (95-02), (B6, F6) 1.6i 16, Sedan, Hatchback, Plus, Sport, Tonic (95-02); Mazda 323 FWD (E3) 1.3 S, L H/back, Sedan, (E/B3) 130 Hatch, Midge, Sting, Sedan, (E5) 1.5 GLC, L, SL, SLX, Sport Sedan, Hatchback (81-95), (B3) 130 Hatch, Sedan (85-05), Midge / Sting (F6) 160 i, s, Hatch, Sedan, (B6) 1.6 EGi, S, SL Hatch, Sedan, Sport, (F6) 160, i, s, Hatch, Midge, Sting, Sedan, 2.0 EGi Hatch, SLE Hatch, SLi, Sedan, (FE-2000) 200e, i Sedan, Hatch DOHC 8/16 Valve (85-05)</p>
	<p>AR6131 Front Stabilizer Bar Bush</p> <p>Volkswagen Kombi (T2, T3) 1.8 Microbus, P/van, Volksiebus, 1.9 Microbus, P/van, 2.0 Microbus, P/van, L Exec. Bus, Kamper, P/up, 2.1 Fi Caravelle, Microbus, 2.3 Microbus, Volksiebus, 2.5i Caravelle, Microbus, 2.6i Caravelle, Microbus (74-04), Kombi (T3) 4X4 (DJ) 2.1 Fi Syncro Pet. (89-93)</p>		<p>AR6145A Rear Lateral Link - Non-Adjustable</p> <p>Ford Laser (B3, E3) 1.3 Dash, GL, L, Tracer H/B, Sedan, Tonic (86-89), (CHV-FUA) 1.4 L, (E5) 1.5 GL, GLS, Sport (86-89), (B6, F6, CVH) 1.6 i, 16, GL, Sport, Tracer H/B, Sedan, Plus, TX3 (86-89), Metecor (B3, E3) 1.3 GL, L (86-89), (CVH) 1.4 LX, (E5) 1.5 GL, GLS (86-89), (B6, F6, CVH) 1.6 16, GL, GLE, GLi, Sport (86-89); Mazda 323 FWD (E3) 1.3 S, L H/back, Sedan, (E/B3) 130 Hatch, Midge, Sting, Sedan, (E5) 1.5 GLC, L, SL, SLX, Sport Sedan, Hatchback (81-95), (B3) 130 Hatch, Sedan (85-05), Midge / Sting (F6) 160 i, s, Hatch, Sedan, (B6) 1.6 EGi, S, SL Hatch, Sedan, Sport, (F6) 160, i, s, Hatch, Midge, Sting, Sedan, 2.0 EGi Hatch, SLE Hatch, SLi, Sedan, (FE-2000) 200e, i Sedan, Hatch DOHC 8/16 Valve (85-05)</p>
	<p>AR6132 Front Stabilizer Link Grommet</p> <p>Volkswagen Kombi (T2, T3) 1.8 Microbus, P/van, Volksiebus, 1.9 Microbus, P/van, 2.0 Microbus, P/van, L Exec. Bus, Kamper, P/up, 2.1 Fi Caravelle, Microbus, 2.3 Microbus, Volksiebus, 2.5i Caravelle, Microbus, 2.6i Caravelle, Microbus (74-04), Kombi (T3) 4X4 (DJ) 2.1 Fi Syncro Pet. (89-93)</p>		<p>AR6148A Rear Lateral Link - Adjustable</p> <p>Ford Laser (B3, E3) 1.3 Dash, GL, L, Tracer H/B, Sedan, Tonic (90-95), (CHV-FUA) 1.4 L, (E5) 1.5 GL, GLS, Sport (90-92), (B6, F6, CVH) 1.6 i, 16, GL, Sport, Tracer H/B, Sedan, Plus, TX3 (90-91), (FE) 2.0i RS (91-94), Metecor (B3, E3) 1.3 GL, L (90-95), (CVH) 1.4 LX, (E5) 1.5 GL, GLS (90-92), (B6, F6, CVH) 1.6 16, GL, GLE, GLi, Sport (90-91), (FE) 2.0 GLE, GLi (91-94), Tracer (B3, E3) 1.3 H/B, Sedan, Tonic, Plus (95-02), (B6, F6) 1.6i 16, Sedan, Hatchback, Plus, Sport, Tonic (95-02); Mazda 323 FWD (E3) 1.3 S, L H/back, Sedan, (E/B3) 130 Hatch, Midge, Sting, Sedan, (E5) 1.5 GLC, L, SL, SLX, Sport Sedan, Hatchback (81-95), 130 Hatch, Sedan (85-05), Midge / Sting (F6) 160 i, s, Hatch, Sedan, (B6) 1.6 EGi, S, SL Hatch, Sedan, Sport, (F6) 160, i, s, Hatch, Midge, Sting, Sedan, 2.0 EGi Hatch, SLE Hatch, SLi, Sedan, (FE-2000) 200e, i Sedan, Hatch DOHC 8/16 Valve (85-05)</p>
	<p>AR6133 Shock Rubber - Front, Stabilizer Link Grommet</p> <p>Volkswagen Kombi (T2, T3) 1.8 Microbus, P/van, Volksiebus, 1.9 Microbus, P/van, 2.0 Microbus, P/van, L Exec. Bus, Kamper, P/up, 2.1 Fi Caravelle, Microbus, 2.3 Microbus, Volksiebus, 2.5i Caravelle, Microbus, 2.6i Caravelle, Microbus (74-04), Kombi (T3) 4X4 (DJ) 2.1 Fi Syncro Pet. (89-93), Kombi (T4) (AAB, ACV) 2.5TDi Microbus, Caravelle, Trend, High Dies. (99-03)</p>		<p>AR6148A Rear Lateral Link - Adjustable</p> <p>Ford Laser (B3, E3) 1.3 Dash, GL, L, Tracer H/B, Sedan, Tonic (90-95), (CHV-FUA) 1.4 L, (E5) 1.5 GL, GLS, Sport (90-92), (B6, F6, CVH) 1.6 i, 16, GL, Sport, Tracer H/B, Sedan, Plus, TX3 (90-91), (FE) 2.0i RS (91-94), Metecor (B3, E3) 1.3 GL, L (90-95), (CVH) 1.4 LX, (E5) 1.5 GL, GLS (90-92), (B6, F6, CVH) 1.6 16, GL, GLE, GLi, Sport (90-91), (FE) 2.0 GLE, GLi (91-94), Tracer (B3, E3) 1.3 H/B, Sedan, Tonic, Plus (95-02), (B6, F6) 1.6i 16, Sedan, Hatchback, Plus, Sport, Tonic (95-02); Mazda 323 FWD (E3) 1.3 S, L H/back, Sedan, (E/B3) 130 Hatch, Midge, Sting, Sedan, (E5) 1.5 GLC, L, SL, SLX, Sport Sedan, Hatchback (81-95), 130 Hatch, Sedan (85-05), Midge / Sting (F6) 160 i, s, Hatch, Sedan, (B6) 1.6 EGi, S, SL Hatch, Sedan, Sport, (F6) 160, i, s, Hatch, Midge, Sting, Sedan, 2.0 EGi Hatch, SLE Hatch, SLi, Sedan, (FE-2000) 200e, i Sedan, Hatch DOHC 8/16 Valve (85-05)</p>

ENGINE MOUNTING & RUBBER BUYERS GUIDE

 ID: 20, OD: 99, L: 158, W: 38	AR6149 Centre Bearing Rubber BMW 5-Series (E28) 520i (M20B20) 2.0 Man., 525e (M30B27) 2.5 Man., 528i (M30B28) 2.8 Man., 535i (M30B35) 3.5 Man., M535i (M90) 3.5 6-Cyl. Man., M5 (MX30) 3.5 Man. (85-89), 7-Series (E23) 728 (M30B28) 2.8, 728i (M30B28) 2.8, 730 (M30B28) 3.0, 733i (M30B32) 3.2, 735i (M30) 3.5, 745i (S38) 3.5 6-Cyl. (78-89)
	AR6155 Engine Mounting - Rear Honda Ballade (SC9) (EW) 150 i "Flip-Up Lights" (84-89)
	AR6156 Rear Lateral Link - L/RHS Mazda 626 (FE) 2.0 SL Hatch, EGi, Sedan, SLi 16 Valve, SLE, 12 Valve, SLX Sedan, Hatch (86-89)
 ID: 14, L: 375	AR6158 Front Lateral Link - RHS Ford Laser (B3, E3) 1.3 Dash, GL, L, Tracer H/B, Sedan, Tonic (86-95), (CHV-FUA) 1.4 L, (E5) 1.5 GL, GLS, Sport (86-92), (B6, F6, CVH) 1.6 i, 16, GL, Sport, Tracer H/B, Sedan, Plus, TX3 (86-91), (FE) 2.0i RS (91-94), Meteor (B3, E3) 1.3 GL, L (86-95), (CVH) 1.4 LX, (E5) 1.5 GL, GLS (86-92), (B6, F6, CVH) 1.6 16, GL, GLE, GLi, Sport (86-91), (FE) 2.0 GLE, GLi (91-94), Tracer (B3, E3) 1.3 H/B, Sedan, Tonic, Plus (95-02), (B6, F6) 1.6i 16, Sedan, Hatchback, Plus, Sport, Tonic (95-02); Mazda 323 FWD (E3) 1.3 S, L H/back, Sedan, (E/B3) 130 Hatch, Midge, Sting, Sedan, (E5) 1.5 GLC, L, SL, SLX, Sport Sedan, Hatchback (83-95), (B3) 130 Hatch, Sedan (83-95), Midge / Sting (F6) 160 i, s, Hatch, Sedan, (B6) 1.6 EGi, S, SL Hatch, Sedan, Sport, (F6) 160, i, s, Hatch, Midge, Sting, Sedan, 2.0 EGi Hatch, SLE Hatch, SLi, Sedan, (FE-2000) 200e, i Sedan, Hatch DOHC 8/16 Valve (83-95)
 ID: 14, L: 372	AR6159 Front Lateral Link - LHS Ford Laser (B3, E3) 1.3 Dash, GL, L, Tracer H/B, Sedan, Tonic (86-95), (CHV-FUA) 1.4 L, (E5) 1.5 GL, GLS, Sport (86-92), (B6, F6, CVH) 1.6 i, 16, GL, Sport, Tracer H/B, Sedan, Plus, TX3 (86-91), (FE) 2.0i RS (91-94), Meteor (B3, E3) 1.3 GL, L (86-95), (CVH) 1.4 LX, (E5) 1.5 GL, GLS (86-92), (B6, F6, CVH) 1.6 16, GL, GLE, GLi, Sport (86-91), (FE) 2.0 GLE, GLi (91-94), Tracer (B3, E3) 1.3 H/B, Sedan, Tonic, Plus (95-02), (B6, F6) 1.6i 16, Sedan, Hatchback, Plus, Sport, Tonic (95-02); Mazda 323 FWD (E3) 1.3 S, L H/back, Sedan, (E/B3) 130 Hatch, Midge, Sting, Sedan, (E5) 1.5 GLC, L, SL, SLX, Sport Sedan, Hatchback (83-95), (B3) 130 Hatch, Sedan (83-95), Midge / Sting (F6) 160 i, s, Hatch, Sedan, (B6) 1.6 EGi, S, SL Hatch, Sedan, Sport, (F6) 160, i, s, Hatch, Midge, Sting, Sedan, 2.0 EGi Hatch, SLE Hatch, SLi, Sedan, (FE-2000) 200e, i Sedan, Hatch DOHC 8/16 Valve (83-95)
	AR6161 Engine Mounting - Front & Rear Ford Bantam (CVH, FUA) 1.4 Leisure SWB P/up Pet., (CVH) 1.6 Leisure, Nite SWB P/up Pet. (86-94); Mazda Rustler 1.3 SWB P/up Kent 2V Pet., (CVH, FUA) 1.4 SWB P/up, (CVH, LUC) 1.6 LX (86-02)
	AR6162 Rear Lateral Link - Adjustable Mazda 626 (F6) 1.6 L Hatch, Sedan, S Sedan, SL Hatch Man. (89-92)
	AR6165 Rear Trailing Link L/RHS Mazda 626 (F6) 1.6 L Hatch, Sedan, S Sedan, SL Hatch Man. (89-92)
	AR6166 Engine Mounting - RHS Opel Astra F (14NV) 140, i, s, (16NZ) 160, i, Estate, iE, iS OHC (93-99), Kadett (14NE) 140, S, (16NZ) 160i S (93-99)

 ID: 12, OD: 36, L: 60	AR6167 Front Lower Control Arm Bush - Inner Front Toyota Conquest (EE80) (2E-L) 1.3 L, GL 12V 4-Spd. Man. (85-88), Corolla (AE82) (4A-GE) 1.6 L (84-88), (EE80) (2E-L) 1.3 FWD L, GL OHC 4-Spd. Man. (84-88)
 ID: 12, OD: 36, L: 60	AR6168 Front Lower Control Arm Bush - Inner Front Toyota Conquest (EE90) (2E-L) 1.3 S, GS 12V 4-Spd. Man., (2E) 130 Zipp, Sport, Tazz, Sport 4-Spd., Tropique, Ruby, Edition, Mc Tazz, XE 12V 5-Spd. Man., (2E) 130 Carri P/van OHC 5-Spd. Man. (88-06), (AE92) (4A-GE) 1.6 RSi Twincam 5-Spd. Man. (88-93), (4A-F) 1.6 LS 3-Spd. Auto., (4A-F) 1.6 RS, Sport DOHC 5-Spd. Man. (88-93), (4A-FE) 160 i RS DOHC 4-Spd. Auto. (93-94), (4A-FE) 160 i RS, Sport, RSE DOHC 5-Spd. Man., (4A-FE) 160 i RSE, XE DOHC 5-Spd. Man. (93-06), Tazz (4A-FE) 160 i RSE, XE DOHC 5-Spd. Man. (93-06), (AE93) (7A-FE) 180 i RS, RSi, Sport DOHC 5-Spd. Man. (93-96), Corolla (AE92) (4A-F) 1.6 GL, GLS, Exec., Sprinter, GLE, Sport., (4A-GE) 1.6 DOHC, GLi, GLi Exec., (4A-F) 1.6 DOHC, 5-Spd. Man., 3-Spd. Auto., GL, GLX DOHC 4-Spd. Auto. (88-93), (4A-FE) 160i GL, GLE, Sprinter, DOHC 5-Spd. Man., 4-Spd. Auto. (92-96), (AE93) (7A-FE) 180i FWD GL, GLE, Sprinter, GSE, GSX, DOHC Man., Auto. (93-96), (AE111) (4A-FE) 160i GL, GLE P/S DOHC, 5-Spd. Man., 4-Spd. Auto., (4A-GE) 160i RSi, RXi DOHC 5/6-Spd. Man. (96-99), (4A-FE) 160i GL, GLE DOHC, 5-Spd. Man., 4-Spd. Auto., (4A-GE) 160i Si, RXi, DOHC 5/6-Spd. Man. (99-02), (AE112) (7A-FE) 180i GLE, GSE DOHC, 5-Spd. Man., 4-Spd. Auto. (96-02), (EE90) (2E, 2E-L) 1.3 FWD L, GL, GLE, Sprinter OHC 4/5-Spd. Man. (88-96), (EE110) (2E) 130 FWD GLE OHC 5-Spd. Man. (96-02)
 ID: 14, OD: 34, L: 61	AR6168A Front Lower Control Arm Bush - Inner Toyota Conquest (EE90) (2E-L) 1.3 S, GS 12V 4-Spd. Man., (2E) 130 Zipp, Sport, Tazz, Sport 4-Spd., Tropique, Ruby, Edition, Mc Tazz, XE 12V 5-Spd. Man., (2E) 130 Carri P/van OHC 5-Spd. Man. (88-06), (AE92) (4A-GE) 1.6 RSi Twincam 5-Spd. Man. (88-93), (4A-F) 1.6 LS 3-Spd. Auto., (4A-F) 1.6 RS, Sport DOHC 5-Spd. Man. (88-93), (4A-FE) 160 i RS DOHC 4-Spd. Auto. (93-94), (4A-FE) 160 i RS, Sport, RSE DOHC 5-Spd. Man., (4A-FE) 160 i RSE, XE DOHC 5-Spd. Man. (93-06), Tazz (4A-FE) 160 i RSE, XE DOHC 5-Spd. Man. (93-06), (AE93) (7A-FE) 180 i RS, RSi, Sport DOHC 5-Spd. Man. (93-96), Corolla (AE92) (4A-F) 1.6 GL, GLS, Exec., Sprinter, GLE, Sport., (4A-GE) 1.6 DOHC, GLi, GLi Exec., (4A-F) 1.6 DOHC, 5-Spd. Man., 3-Spd. Auto., GL, GLX DOHC 4-Spd. Auto. (88-93), (4A-FE) 160i GL, GLE, Sprinter, DOHC 5-Spd. Man., 4-Spd. Auto. (92-96), (AE93) (7A-FE) 180i FWD GL, GLE, Sprinter, GSE, GSX, DOHC Man., Auto. (93-96), (AE111) (4A-FE) 160i GL, GLE P/S DOHC, 5-Spd. Man., 4-Spd. Auto., (4A-GE) 160i RSi, RXi DOHC 5/6-Spd. Man. (96-99), (4A-FE) 160i GL, GLE DOHC, 5-Spd. Man., 4-Spd. Auto., (4A-GE) 160i Si, RXi, DOHC 5/6-Spd. Man. (99-02), (AE112) (7A-FE) 180i GLE, GSE DOHC, 5-Spd. Man., 4-Spd. Auto. (96-02), (EE90) (2E, 2E-L) 1.3 FWD L, GL, GLE, Sprinter OHC 4/5-Spd. Man. (88-96), (EE110) (2E) 130 FWD GLE OHC 5-Spd. Man. (96-02)
	AR6169 Rear Trailing Link Toyota Conquest (AE92) (4A-F) 1.6 LS 3-Spd. Auto., (4A-F) 1.6 RS, Sport DOHC 5-Spd. Man. (92-93), (AE93) (7A-FE) 180 RSi, Sport DOHC 5-Spd. Man. (93-96), Corolla (AE93) (7A-FE) 180i FWD GSX, DOHC Man., Auto. (93-96)
 ID: 22, OD: 53.5, L: 32	AR6170 Tension Rod Bush Isuzu KB-Series KB160 (4ZA1) 1.6 SWB, Fleetside P/up Pet., KB200 (ZC1) 2.0 SWB, LWB, D/cab, LE, Fleetside, P/up Pet., KB220 (C22NE) 2.2 LWB D/cab, LE P/up Pet., KB230 (4ZD1) 2.3 SWB, LWB, D/cab P/up Pet., KB250D (4JA1) 2.5 SWB, LWB D/cab, LE, Fleetside, P/up Dies., KB280DT (4JB1) 2.8 SWB, LWB LE, D/cab LE, Frontier LX P/up (89-04), KB-Series 4X4 KB220 (C22NE) LWB D/cab, LE, P/up Pet., KB230 (4ZD1) SWB P/up Pet., KB250D (4JA1) SWB/LWB, D/cab, LE, LE D/cab P/up Dies., KB260 (4ZE1) LWB D/cab, LE, LX D/cab P/up, KB280DT (4JB1) SWB, LWB LE, LE D/cab, LX, LX D/cab, P/up (89-04), KB-Series KB260 (4ZE1) 2.6 SWB/LWB LE, LX, D/cab P/up Pet., KB320 (6VD1) 3.2 V6 SWB, LWB LE, LX, D/cab, Frontier, Reef, Blazer P/up Pet. (92-04), KB-Series 4X4 KB320 (6VD1) V6 SWB, LWB Frontier LX, LX, LX D/cab P/up Pet. (98-04)

ENGINE MOUNTING & RUBBER BUYERS GUIDE

	<p>AR6171 Engine Mounting - Front</p> <p>Volkswagen Caddy (HM, HV, JK) 1.6, i P/up Dies., Pet. 4-Spd. Man., (HV) 1.8 L Sport, Sport, P/up (96-03), Citi Golf 1.4 L, Chico, (AGY, BSY) 1.4i, L, Citi.com, VeloCiti, TenaCiti, CitiStorm, Sport, Rox, Rhythm Man., (AFX) 1.6i Life, Velociti, TenaCiti, CitiStorm, Sport, Rox 5-Spd. Man. (99-09), Golf III 1.6 GS 5-Spd. Man., 1.8 GSX, GTS 5-Spd. Man., 3-Spd. Auto., 2.0 GTi, 8V GTi Exec. 5-Spd. Man., 2.8 VR6, VR6 Exec. V6 5-Spd. Man., 4-Spd. Auto. (92-99), Jetta III 1.6 CSL 5-Spd. Man., 1.8 CLX, CSX 5-Spd. Man., 3-Spd. Auto., 2.0 CLi, CLi Exec. 5-Spd. Man., 2.8 VR6 Exec. V6 5-Spd. Man., 4-Spd. Auto. (92-99), Polo (6N) 1.4i Classic, Playa, 1.6i Classic Lux, Playa 5-Spd. Man. (96-03)</p>
	<p>AR6172 Rear Trailing Link</p> <p>Toyota Conquest (AE93) (7A-FE) 180 i RS, RSi, Sport DOHC 5-Spd. Man. (93-96)</p>
 <p>ID: 30, OD: 96, L: 166, W: 30</p>	<p>AR6173 Centre Bearing Rubber</p> <p>BMW 3-Series (E30) 316 (M10) 1.8, 316i (M40) 1.6, (M40) 1.8 Cabriolet, 318i (M40) 1.8 Cabriolet (83-92), 320i (M20, M50) 2.0, 323i (M20) 2.3, 325i (M20B25) 2.5, (M20B27) 2.7 Shadowline, iS Shadowline, Cabriolet, 333i (M30) 3.3 6-Cyl. (83-92)</p>
 <p>ID: 30, OD: 99, L: 152, W: 36</p>	<p>AR6174 Centre Bearing Rubber</p> <p>BMW 3-Series (E30) 316 (M10) 1.8, 316i (M40) 1.6, (M40) 1.8 Cabriolet, 318i (M40) 1.8 Cabriolet (83-92), 320i (M20, M50) 2.0, 323i (M20) 2.3, 325i (M20B25) 2.5, (M20B27) 2.7 Shadowline, iS Shadowline, Cabriolet, 333i (M30) 3.3 6-Cyl. (83-92), 5-Series (E34) 530i (M60B30) 3.0 V8, 535i (M30B35) 3.5 6-Cyl. (95-96), 7-Series (E32) 730i (M30, M60) 3.0, 735i (M30) 3.5 6-Cyl. (87-96)</p>
 <p>ID: 11.5, L: 63</p>	<p>AR6175 Exhaust Hanger - Rear</p> <p>Toyota Corolla (AE92) (4A-F) 1.6 GL, GLS, Exec., Sprinter, GLE, Sport., (4A-GE) 1.6 DOHC, GLi, GLi Exec., (4A-F) 1.6 DOHC, 5-Spd. Man., 3-Spd. Auto., GL, GLX DOHC 4-Spd. Auto. (88-93), (4A-FE) 160i GL, GLE, Sprinter, DOHC 5-Spd. Man., 4-Spd. Auto. (92-96)</p>
 <p>ID: 14, OD: 58.2, L: 55.3</p>	<p>AR6177 Front Upper Control Arm Bush - Inner Rear</p> <p>BMW 5-Series (E34) 520i (M50B20) 2.0, 525i (M50B25) 2.5, M5 (M50B35) 3.5 6-Cyl., 530i (M60B30) 3.0 V8, 535i (M30B35) 3.5 6-Cyl., 540i (M60B40) 4.0 Edition V8 (89-96), 7-Series (E32) 730i (M30, M60) 3.0, 735i (M30) 3.5 6-Cyl., M60, M62 4.0, 750iL (M70) 5.0 V12 (87-96), 8-Series (E31) 850Ci (M70) 5.0 V12 (91-94)</p>
 <p>ID: 18, OD: 30, L: 47</p>	<p>AR6178 Shackle Bush - Front, Rear Upper</p> <p>GoNow X-Space 2.2i DC, DCext., 2.8 TDX DC (07-10), X-Space 4X4 2.2 iL DC, XL DCext., 2.8 TDX DCext. (07-10); GWM Steed 4X4 2.2i D/cab Lux, Multi-Wagon (07-11); Toyota Hilux (LN57) (3L) 2.8 LWB Raider D/cab, P/up Dies. (95-05), (LN65) (2L) 2.4 LWB D/cab, Raider, D/Cab Dies. (89-98), (LN67) (3L) 2.8 LWB P/up, Raider, D/cab Dies. (95-05), (LN140) (2L) 2.4 SWB DLX P/up Dies. (98-05), (LN145) 2.4 LWB P/up Dies. (98-05), (LN192) (5L) 3.0D LWB D-E DLX, Raider D/cab Raised Body Dies., (KZ-TE) 3.0iD LWB D/cab Raider, Legend35 Raider, D/cab, Raider Dies. (98-05), (RN58) (22R) 2.4 LWB S, S D/cab, SR D/cab, SRX, Raider Pet. (84-98), (RN67) (22R) 2.4 LWB Raider, D/cab, Raider D/cab Pet. (92-95), (RZN147) (1RZ-E) 2.0 LWB SR D/cab Pet. 5-Spd. Man., (1RZ-E) 2.0 SWB SR, DLX, S, Pet. 5-Spd. Man. (98-05), (RZN169) (3RZ-FE) 2.7i LWB P/up, Raider, Raider D/C, SRX D/C, DLX S/C, Legend35, Legend35 D/C Pet. (98-05), (RZN194) (3RZ-FE) 2.7i LWB Legend35, Raider, Raider D/cab, Raised Body Pet. 5-Spd. Man. (98-05), (YN51) (2Y) 1.8 SWB S, SR, Raider P/up Pet., 5-Spd. Man. (92-98), (YN56) (2Y) 1.8 LWB P/up 4/5-Spd. Man. Pet. (92-98), (YN67) (4Y) 2.2 LWB Raider D/cab, D/cab P/up Pet. (92-94)</p>
	<p>AR6179 Engine Mounting - RHS</p> <p>Ford Bantam (CVH, FUA) 1.4 Leisure SWB P/up Pet., (CVH) 1.6 Leisure, Nite SWB P/up Pet. (86-94); Mazda Rustler 1.3 SWB P/up Kent 2V Pet., (CVH, FUA) 1.4 SWB P/up, (CVH, LUC) 1.6 LX (86-02)</p>

 <p>ID: 26, OD: 97, L: 51</p>	<p>AR6180 Front Strut Mounting</p> <p>Volkswagen Golf III 1.6 GS 5-Spd. Man., 1.8 GSX, GTS 5-Spd. Man., 3-Spd. Auto., 2.0 GTi, 8V GTi Exec. 5-Spd. Man., 2.8 VR6, VR6 Exec. V6 5-Spd. Man., 4-Spd. Auto. (92-99), Jetta III 1.6 CSL 5-Spd. Man., 1.8 CLX, CSX 5-Spd. Man., 3-Spd. Auto., 2.0 CLi, CLi Exec. 5-Spd. Man., 2.8 VR6 Exec. V6 5-Spd. Man., 4-Spd. Auto. (92-99), Polo (6N) 1.4i Classic, Playa, 1.6i Classic Lux, Classic, Playa, 1.8i Classic Lux, Playa 5-Spd. Man. (96-03), Sharan (AJH, AWC) 1.8T MPV Man., (AMY, AAA) 2.8 VR6 (99-10)</p>
	<p>AR6181 Engine Mounting - Front</p> <p>Volkswagen Golf II 1.3 CL 4-Spd. Man., 1.6 CSL 5-Spd. Man., 1.8 GTS 16V, CSX, GTi 8V, 16V, 5-Spd. Man., 3-Spd. Auto. (84-92), Jetta II 1.6 CSL 5-Spd. Man., 1.8 CLi, CLi Exec., Executive, CLX, CSX 5-Spd. Man., 3-Spd. Auto. (85-92)</p>
 <p>ID: 26, T: 12/32 6-HOLES</p>	<p>AR6182 Propshaft Coupling</p> <p>BMW 5-Series (E60) 523i (M52, M53) 2.5, 525i (M54, N52) 2.5, 530d (M57) 3.0, 530i (M54, N52) 3.0, 545i (N62B44A) 4.4 V8 (04-10)</p>
	<p>AR6183 Engine Mounting - L/RHS</p> <p>Nissan 1-Tonner Hardbody (AW/D22) (TD25i) 2.5D SWB, LWB, Custom, D/cab, Hi Rider, Twin Cab P/up Dies., (TD27i) 2.7D SWB, LWB, Custom, D/cab, Hi Rider, Twincab, SE D/cab P/up Dies. (88-98), 1-Tonner Hardbody (AW/D22) 4X4 (TD27i) 2.7D SWB, LWB Hi Rider, Twin Cab, SE, SE D/cab P/up Dies. (88-99), Hardbody (QW/244) (TD27i) 2.7 SE, D/C, TD LWB, S/cab, D/cab, SE P/up Dies. (98-11), Hardbody (D22, QW/244) 4X4 (KA24E) 2.4i, LWB S/cab, SL D/cab, P/up Pet., (TD27i) 2.7D, LWB S/cab, SE, D/cab, P/up Dies. (98-10), Hardbody NP300 (D22) 4X4 (KA24DE) 2.4i LWB S/C, D/C Hi Rider P/up Pet. (2008-), Sani (AW) (TD25i) 2.5D LWB Custom S/W, Dies., (TD27i) 2.7D LWB MKII, Exec. S/W Dies. (88-99), Sani 4X4 (TD27i) 2.7D LWB D/cab S/W, MKII, Exec. S/W Dies. (90-99)</p>
 <p>ID: 28</p>	<p>AR6184 Centre Bearing Rubber</p> <p>Ford Courier (WL4) 2.5D TD, Leisure LWB P/up Dies., 3.4 V6 Leisure, D/cab SWB, LWB P/up Pet. (86-00), Ranger 2.2, XL SWB, LWB P/up Pet., (WL4) 2.5D, TD High Trail, High Trail XL, XL D/cab, XLT Hi Trail, Super Cab XLT Hi Trail SWB, LWB P/up Dies., 4.0 V6 SubCab XLT Hi Trail, Super Cab XLT, XLE D/C, Hi Trail SWB, LWB P/up Pet. (99-10); Mazda B-Series B2500D (WL4), TD LWB Drifter, SLX P/up Dies. (82-00), B2600i LWB D/cab, Drifter SLX P/up Pet. (86-02), B3400 V6 LWB D/cab, Magnum P/up Pet. (86-99), Drifter 2.2 SWB, LWB XL, (WL4) 2.5TD LWB Hi Ride, S/cab, SL Hi Ride, SLE, SLX, D/cab, LX Hi Ride, P/up Dies. (00-08)</p>
 <p>ID: 41, OD: 129, W: 26, PCD: 90 6-HOLES</p>	<p>AR6186 Propshaft Coupling</p> <p>Mercedes-Benz (W124) 200, E, E200 (M102.922) 2.0, 220E, E220 (M111.960) 2.2, 230E, E230 (M102.982) 2.3, (M103.940) 260E 2.6 6-Cyl., 300D 3.0 5-Cyl., 300E 3.0 6-Cyl. (86-96), (W201) 190E (M102.920) 1.8, (M102.922) 2.0, (M102.983) 2.3 Sportline (93-94), (W202) C-Class C200 (M111.941) 2.0 Classic, Elegance, C220 (M111.961) 2.2 Classic, Elegance, C250D, TD (M605.910) 2.5 5-Cyl. (94-00)</p>
 <p>ID: 57, OD: 128, W: 26, PCD: 90 6-HOLES</p>	<p>AR6187 Propshaft Coupling - Rear</p> <p>Mercedes-Benz (W126) 280S, SE (M110.987/89) 2.8 6-Cyl., 300SE (M103.981) 3.0 6-Cyl., 380SE (M116.963) 3.8 V8, 420SE (M116.965) 4.2 V8, 500SE (M117.965) 5.0 V8 (86-93)</p>

ENGINE MOUNTING & RUBBER BUYERS GUIDE

	<p>AR6188 Rear Strut Mounting</p> <p>BMW 3-Series (E30) 316 (M10) 1.8, 316i (M40) 1.6, (M40) 1.8 Cabriolet, 318i (M40) 1.8 Cabriolet (83-92), 320i (M20, M50) 2.0, 323i (M20) 2.3, 325i (M20B25) 2.5, (M20B27) 2.7 Shadowline, iS Shadowline, Cabriolet, 333i (M30) 3.3 6-Cyl. (83-92), (E36) 325i (M50) 2.5 Dolphin Convertible, 325tds (M51) 2.5 6-Cyl. Dies., 328i (M52T) 2.8 (92-99), (E36, E37) M-Coupe (S50B32) 3.2 6-Cyl. (93-05), Z3 (M52) 2.8 Roadster, (M54) 3.0 Roadster 6-Cyl. (97-03), (E36, E46) M3 (M54) 3.0, (S50B32/4) 3.2 Convertible (93-05), (E46) 318i (M43) 1.8, (M43) 2.0 Touring SW, (N42) 2.0, 318ti (M47B) 2.0 Compact, 320d (M47D) 2.0 (98-05), 320i (M52) 2.0, (M54) 2.2, 323Ci (M52) 2.5 Coupe, 323i (M52) 2.5, 325Ci (M54) 2.5 Coupe, 325i, 325ti (M50, M54) 2.5 Touring SW, Compact (99-05), 328i (M52TU) 2.8 Coupe, 330Ci (M54) 3.0 Convertible, 330d (M57) 3.0 Dies., 330i (M54) 3.0 (99-05)</p>
	<p>AR6189 Front Strut Mounting</p> <p>Opel Astra F (14NV) 140, i, iS, (16NZ) 160, i, Estate, iE, iS OHC, (18XE) 180i 18SE/XL iE OHC, (20SE) 200i, Estate, iE, (20XE) tS (93-99), Kadett (14NE) 140, S, (16NZ) 160i S, (18SE) 180i, iE, (20SE) 200iS, (20XE) tS (93-99)</p>
	<p>AR6190 Stabilizer Link Pin Kit</p> <p>Toyota Hilux (LN50) (L) 2.2 SWB P/up Dies. 4-Spd. Man. (84-98), (LN51) (2L) 2.4 SWB S D/cab, Raider P/up Dies. (84-98), (LN55) (L) 2.2 LWB P/up Dies. (84-98), (LN56) (2L) 2.4 LWB Raider, D/cab P/up Dies. (84-98), (LN57) (3L) 2.8 LWB Raider D/cab, P/up Dies. (95-05), (LN65) (2L) 2.4 LWB D/cab, Raider, D/Cab Dies. (89-98), (LN67) (3L) 2.8 LWB P/up, Raider, D/cab Dies. (95-05), (LN140) (2L) 2.4 SWB DLX P/up Dies. (98-05), (LN145) 2.4 LWB P/up Dies. (98-05), (LN192) (5L) 3.0D LWB D-E DLX, Raider D/cab Raised Body Dies., (KZ-TE) 3.0iD LWB D/cab Raider, Legend35 Raider, D/cab, Raider Dies. (98-05), (RN58) (22R) 2.4 LWB S, S D/cab, SR D/cab, SRX, Raider Pet. (84-98), (RN67) (22R) 2.4 LWB Raider, D/cab, Raider D/cab Pet. (89-98), (RZN147) (1RZ-E) 2.0 LWB SR D/cab Pet. 5-Spd. Man., (1RZ-E) 2.0 SWB SR, DLX, S, Pet. 5-Spd. Man. (98-05), (RZN169) (3RZ-FE) 2.7i LWB P/up, Raider, Raider D/C, SRX D/C, DLX S/C, Legend35, Legend35 D/C Pet. (98-05), (RZN194) (3RZ-FE) 2.7i LWB Legend35, Raider, Raider D/cab, Raised Body Pet. 5-Spd. Man. (98-05), (YN51) (2Y) 1.8 SWB S, SR, Raider P/up Pet., 5-Spd. Man. (86-98), (YN56) (2Y) 1.8 LWB P/up 4/5-Spd. Man. Pet. (86-98), (YN58) (4Y) 2.2 LWB Raider, SRX P/up Pet. (84-98), (YN67) (4Y) 2.2 LWB Raider D/cab, D/cab P/up Pet. (85-94), (YN140) (2Y) 1.8 SWB, LWB D/cab, Raider Pet, 5-Spd. Man. (98-05)</p>
	<p>AR6191 Stabilizer Link Pin Kit</p> <p>Toyota Hilux (LN50) (L) 2.2 SWB P/up Dies. 4-Spd. Man. (84-98), (LN51) (2L) 2.4 SWB S D/cab, Raider P/up Dies. (84-98), (LN55) (L) 2.2 LWB P/up Dies. (84-98), (LN56) (2L) 2.4 LWB Raider, D/cab P/up Dies. (84-98), (LN57) (3L) 2.8 LWB Raider D/cab, P/up Dies. (95-05), (LN65) (2L) 2.4 LWB D/cab, Raider, D/Cab Dies. (89-98), (LN67) (3L) 2.8 LWB P/up, Raider, D/cab Dies. (95-05), (LN140) (2L) 2.4 SWB DLX P/up Dies. (98-05), (LN145) 2.4 LWB P/up Dies. (98-05), (LN192) (5L) 3.0D LWB D-E DLX, Raider D/cab Raised Body Dies., (KZ-TE) 3.0iD LWB D/cab Raider, Legend35 Raider, D/cab, Raider Dies. (98-05), (RZN147) (1RZ-E) 2.0 LWB SR D/cab Pet. 5-Spd. Man., (1RZ-E) 2.0 SWB SR, DLX, S, Pet. 5-Spd. Man. (98-05), (RZN169) (3RZ-FE) 2.7i LWB P/up, Raider, Raider D/C, SRX D/C, DLX S/C, Legend35, Legend35 D/C Pet. (98-05), (RZN194) (3RZ-FE) 2.7i LWB Legend35, Raider, Raider D/cab, Raised Body Pet. 5-Spd. Man. (98-05), (YN51) (2Y) 1.8 SWB S, SR, Raider P/up Pet., 5-Spd. Man. (86-98), (YN56) (2Y) 1.8 LWB P/up 4/5-Spd. Man. Pet. (86-98), (YN58) (4Y) 2.2 LWB Raider, SRX P/up Pet. (84-98), (YN67) (4Y) 2.2 LWB Raider D/cab, D/cab P/up Pet. (85-94), (YN140) (2Y) 1.8 SWB, LWB D/cab, Raider Pet, 5-Spd. Man. (98-05)</p>

	<p>AR6192 Propshaft Coupling</p> <p>BMW 1-Series (F20, F21) 116i (N13B16A) 1.6, 118i (B38B15A) 1.5, (N13B16A) 1.6, 120i (N13B16A) 1.6 (11-19), 2-Series (F22, F23) 220i (B48B20A, N20B20A/B) 2.0 Coupe (14-19), 3-Series (E36) 316i (M40) 1.8 Dolphin Shape, 318i (M40) 1.8 Motorsport, (M42) 1.9 S, 320i (M50) 2.0, 323i (M52) 2.5, 325i (M50) 2.5, 325tds (M51) 2.5 6-Cyl. (93-99), 328i (M52TU) 2.8 Dolphin Convertible, Individual (95-00), (E36, E37) Z3 (M52) 2.8 Roadster, (M54) 3.0 Roadster 6-Cyl. (97-03), (E46) 318i (M43) 1.8, (M43) 2.0 Touring SW, (N42) 2.0, 318ti (M47B) 2.0 Compact, 320d (M47D) 2.0 (98-05), 320i (M52) 2.0, (M54) 2.2, 323Ci (M52) 2.5 Coupe, 323i (M52) 2.5, 325Ci (M54) 2.5 Coupe, 325i, 325ti (M50, M54) 2.5 Touring SW, Compact (99-05), (F30, F31) 316i (N13B16A) 1.6, 318i (B38A15A) 1.6, 320d (N47D20A) 2.0, 320i (B48B20A, N20B20A/B/D) 2.0, 328i (N20B20A) 2.0 (12-19), (F34) 320i GT (N20B20A/B) 2.0 (2015-), 4-Series (F33) 420i (N20B20B) 2.0 Cabriolet (2014-), 5-Series (E34) 520i (M50B20) 2.0 (86-96), (E39) 523i (M52) 2.5, 525i (M54) 2.5, 528i (M52) 2.8, 530d (M57) 3.0 Dies., 530i (M54) 3.0 (96-04), X1 (F48) xDrive20d (B47C20A/B) 2.0, xDrive20i (B48A20A/F) 2.0 (2015-), X2 (F39) xDrive20d (B47C20A/B) 2.0 (2018-)</p>
	<p>AR6193 Front Stabilizer Bar Bush</p> <p>Ford Bantam (CVH, FUA) 1.4 Leisure SWB P/up Pet., (CVH) 1.6 Leisure, Nite SWB P/up Pet. (86-94); Mazda Rustler 1.3 SWB P/up Kent 2V Pet., (CVH, FUA) 1.4 SWB P/up, (CVH, LUC) 1.6 LX (86-02)</p>
	<p>AR6194 Front Stabilizer Bar Bush</p> <p>Ford Bantam 1.3 SWB P/up Kent 2V Pet., (CVH) 1.6 Leisure SWB P/up Pet. (83-86)</p>
	<p>AR6195 Centre Bearing Rubber</p> <p>Toyota Hilux (LN140) (2L) 2.4 SWB DLX P/up Dies. (98-05), (LN145) 2.4 LWB P/up Dies. (98-05), (LN192) (5L) 3.0D LWB D-E DLX, Raider D/cab Raised Body Dies., (KZ-TE) 3.0iD LWB D/cab Raider, Legend35 Raider, D/cab, Raider Dies. (98-05), (RZN147) (1RZ-E) 2.0 LWB SR D/cab Pet. 5-Spd. Man., (1RZ-E) 2.0 SWB SR, DLX, S, Pet. 5-Spd. Man. (98-05), (RZN169) (3RZ-FE) 2.7i LWB P/up, Raider, Raider D/C, SRX D/C, DLX S/C, Legend35, Legend35 D/C Pet. (98-05), (RZN194) (3RZ-FE) 2.7i LWB Legend35, Raider, Raider D/cab, Raised Body Pet. 5-Spd. Man. (98-05), (YN140) (2Y) 1.8 SWB, LWB D/cab, Raider Pet, 5-Spd. Man. (98-05)</p>
	<p>AR6198 Centre Bearing Rubber</p> <p>Mitsubishi Colt LDV (4G32) 1.6 SWB/ LWB Lo-Line K01/11 P/up Pet., (4G63) 2.0 SWB/ LWB D/cab Hi-Line, Lo-Line K12 P/up Pet., (4D56) 2.5D LWB Hi-Line, Lo-Line D/cab K14 P/up Dies., (4G54) 2.6 LWB Hi-Line K13, P/up (94-98), Colt LDV (4G63) 2.0, i LWB Std., Hi-Line S/Cab, K62T P/up, Pet., 2.4i LWB Hi-Line, S/Cab, D/Cab, Hi Rider K65T, P/up Pet., (4D56) 2.5D LWB Hi-Line, Std., S/cab, K64T P/up Dies. (98-09) - Standard Body Models, Colt LDV (K67/77T) 2.8D, TD LWB Std. S/Cab (01-09), Colt LDV 2.0 LWB P/up, 2.0i LWB Hi-Line P/up (04-09), Pajero 4X4 (4G54) 2.6 SWB, LWB GLS, SJ25/26/45 SUV Pet. (83-94), (4M40) 2.8TDi LWB GLS SUV V23C Dies., (6G72) 3.0 6-Cyl. SWB GLS Wagon V43W, V64W Pet. (90-01), (6G74) 3.5 V6 LWB GLS SUV V25/45W Pet. (95-01)</p>
	<p>AR6199 Centre Bearing Rubber</p> <p>Mitsubishi Colt LDV 4X4 (4D56) 2.5D LWB Hi-Line K34 P/up Dies., (4G54) 2.6 LWB Lo-/Hi-Line K33 P/up Pet., (6G72) 3.0 V6 LWB Lo-Line, D/cab, Hi-Line Rodeo K36 Pet. (94-98), Colt LDV (4G63) 2.0, i LWB Std., Hi-Line S/Cab, K62T P/up, Pet., 2.4i LWB Hi-Line, S/Cab, D/Cab, Hi Rider K65T, P/up Pet., (4D56) 2.5D LWB Hi-Line, Std., S/cab, K64T P/up Dies. (98-09), Colt LDV (K67/77T) 2.8D, TD LWB S/Cab, Hi-Line S/Cab Hi Rider, Hi-Line Raised Body, Pioneer D/Cab Hi Rider P/up Dies., (6G72) 3.0i V6 LWB ClubCab K76T P/up Pet. (01-09), Colt LDV 4X4 (K65/75T) 2.4i LWB S/cab, Hi-Line, D/cab, Trailbuster S/cab, P/up Pet., (K77T) 2.8D LWB S/cab, P/up Dies., (K77T) 2.8TD LWB Rodeo D/cab, P/up Turbo Dies., (6G72, K76T) 3.0i V6 LWB Rodeo D/cab, ClubCab, P/up Pet. (98-09), Colt LDV 2.0 LWB P/up, 2.0i LWB Hi-Line P/up (04-09)</p>

ENGINE MOUNTING & RUBBER BUYERS GUIDE

 <p>ID: 17, L: 530</p>	<p>AR6204 Rear Lateral Link</p> <p>Toyota Conquest (EE90) (2E-L) 1.3 S, GS 12V 4-Spd. Man., (2E) 130 Zipp, Sport, Tazz, Sport 4-Spd., Tropique, Ruby, Edition, Mc Tazz, XE 12V 5-Spd. Man., (2E) 130 Carri P/van OHC 5-Spd. Man. (88-06), (AE92) (4A-GE) 1.6 RSi Twincam 5-Spd. Man. (88-93), (4A-F) 1.6 LS 3-Spd. Auto., (4A-F) 1.6 RS, Sport DOHC 5-Spd. Man. (88-93), (4A-FE) 160 i RS DOHC 4-Spd. Auto. (93-94), (4A-FE) 160 i RS, Sport, RSE DOHC 5-Spd. Man., (4A-FE) 160 i RSE, XE DOHC 5-Spd. Man. (93-06), Tazz (4A-FE) 160 i RSE, XE DOHC 5-Spd. Man. (93-06), (AE93) (7A-FE) 180 i RS, RSi, Sport DOHC 5-Spd. Man. (93-96), Corolla (AE92) (4A-F) 1.6 GL, GLS, Exec., Sprinter, GLE, Sport., (4A-GE) 1.6 DOHC, GLi, GLi Exec., (4A-F) 1.6 DOHC, 5-Spd. Man., 3-Spd. Auto., GL, GLX DOHC 4-Spd. Auto. (88-93), (4A-FE) 160i GL, GLE, Sprinter, DOHC 5-Spd. Man., 4-Spd. Auto. (92-96), (AE93) (7A-FE) 180i FWD GL, GLE, Sprinter, GSE, GSX, DOHC Man., Auto. (93-96), (EE90) (2E, 2E-L) 1.3 FWD L, GL, GLE, Sprinter OHC 4/5-Spd. Man. (88-96)</p>		<p>AR6208 Engine Mounting - LHS</p> <p>Toyota Corolla (AE82) 1.6 Auto. (84-86)</p>
 <p>ID: 11, L: 530</p>	<p>AR6205 Front Lateral Link</p> <p>Toyota Conquest (EE90) (2E-L) 1.3 S, GS 12V 4-Spd. Man., (2E) 130 Zipp, Sport, Tazz, Sport 4-Spd., Tropique, Ruby, Edition, Mc Tazz, XE 12V 5-Spd. Man., (2E) 130 Carri P/van OHC 5-Spd. Man. (88-06), (AE92) (4A-GE) 1.6 RSi Twincam 5-Spd. Man. (88-93), (4A-F) 1.6 LS 3-Spd. Auto., (4A-F) 1.6 RS, Sport DOHC 5-Spd. Man. (88-93), (4A-FE) 160 i RS DOHC 4-Spd. Auto. (93-94), (4A-FE) 160 i RS, Sport, RSE DOHC 5-Spd. Man., (4A-FE) 160 i RSE, XE DOHC 5-Spd. Man. (93-06), Tazz (4A-FE) 160 i RSE, XE DOHC 5-Spd. Man. (93-06), Corolla (AE92) (4A-F) 1.6 GL, GLS, Exec., Sprinter, GLE, Sport., (4A-GE) 1.6 DOHC, GLi, GLi Exec., (4A-F) 1.6 DOHC, 5-Spd. Man., 3-Spd. Auto., GL, GLX DOHC 4-Spd. Auto. (88-93), (4A-FE) 160i GL, GLE, Sprinter, DOHC 5-Spd. Man., 4-Spd. Auto. (92-96), (AE93) (7A-FE) 180i FWD GL, GLE, Sprinter, GSE, GSX, DOHC Man., Auto. (93-96), (EE90) (2E, 2E-L) 1.3 FWD L, GL, GLE, Sprinter OHC 4/5-Spd. Man. (88-96)</p>		<p>AR6209 Front Strut Mounting</p> <p>Mazda 626 (FS) 2.0i 4-Cyl. 16V Medium, High, (KF) 2.0i V6 24V High, (FS2B/D) 2.0i S/W, Sedan, (KL) 2.5i V6 Exec. (93-03), MX6 (KL) 2.5 V6 (93-03)</p>
 <p>ID: 12, L: 530</p>	<p>AR6206 Rear Trailing Link</p> <p>Toyota Conquest (EE90) (2E-L) 1.3 S, GS 12V 4-Spd. Man., (2E) 130 Zipp, Sport, Tazz, Sport 4-Spd., Tropique, Ruby, Edition, Mc Tazz, XE 12V 5-Spd. Man., (2E) 130 Carri P/van OHC 5-Spd. Man. (88-06), (AE92) (4A-GE) 1.6 RSi Twincam 5-Spd. Man. (88-93), (4A-F) 1.6 LS 3-Spd. Auto., (4A-F) 1.6 RS, Sport DOHC 5-Spd. Man. (88-93), (4A-FE) 160 i RS DOHC 4-Spd. Auto. (93-94), (4A-FE) 160 i RS, Sport, RSE DOHC 5-Spd. Man., (4A-FE) 160 i RSE, XE DOHC 5-Spd. Man. (93-06), Tazz (4A-FE) 160 i RSE, XE DOHC 5-Spd. Man. (93-06), (AE93) (7A-FE) 180 i RS, RSi, Sport DOHC 5-Spd. Man. (93-96), Corolla (AE92) (4A-F) 1.6 GL, GLS, Exec., Sprinter, GLE, Sport., (4A-GE) 1.6 DOHC, GLi, GLi Exec., (4A-F) 1.6 DOHC, 5-Spd. Man., 3-Spd. Auto., GL, GLX DOHC 4-Spd. Auto. (88-93), (4A-FE) 160i GL, GLE, Sprinter, DOHC 5-Spd. Man., 4-Spd. Auto. (92-96), (AE93) (7A-FE) 180i FWD GL, GLE, Sprinter, GSE, GSX, DOHC Man., Auto. (93-96), (EE90) (2E, 2E-L) 1.3 FWD L, GL, GLE, Sprinter OHC 4/5-Spd. Man. (88-96)</p>		<p>AR6210 Front Strut Mounting</p> <p>Ford Bantam (B3) 1.3 130 Explorer SWB P/up Pet., (F6) 160i, Explorer, Leisure, Sport SWB P/up Pet. (94-03), Laser (B3, E3) 1.3 Dash, GL, L, Tracer H/B, Sedan, Tonic (91-95), (CHV-FUA) 1.4 L, (E5) 1.5 GL, GLS, Sport (91-92), (B6, F6, CVH) 1.6 i, 16, GL, Sport, Tracer H/B, Sedan, Plus, TX3 (1991), (FE) 2.0i RS (91-94), Meteor (B3, E3) 1.3 GL, L (91-95), (CVH) 1.4 LX, (E5) 1.5 GL, GLS (91-92), (B6, F6, CVH) 1.6 16, GL, GLE, GLi, Sport (1991), (FE) 2.0 GLE, GLi (91-94), Tracer (B3, E3) 1.3 H/B, Sedan, Tonic, Plus (95-02), (B6, F6) 1.6i 16, Sedan, Hatchback, Plus, Sport, Tonic (95-02); Mazda 323 FWD (E3) 1.3 S, L H/back, Sedan, (E/B3) 130 Hatch, Midge, Sting, Sedan, (E5) 1.5 GLC, L, SL, SLX, Sport Sedan, Hatchback (91-95), Midge / Sting (F6) 160 i, s, Hatch, Sedan, (B6) 1.6 EGi, S, SL Hatch, Sedan, Sport, (F6) 160, i, iS, Hatch, Midge, Sting, Sedan, 2.0 EGi Hatch, SLE Hatch, SLi, Sedan, (FE-2000) 200e, i Sedan, Hatch DOHC 8/16 Valve (91-03), Rustler (B3) 130 SWB Drifter, Explorer P/up Pet., (B6i, F6) 160, i SWB Explorer, Drifter P/up Pet. (86-02)</p>
	<p>AR6206i Rear Trailing Link Bush (Insert)</p> <p>Toyota Conquest (EE90) (2E-L) 1.3 S, GS 12V 4-Spd. Man., (2E) 130 Zipp, Sport, Tazz, Sport 4-Spd., Tropique, Ruby, Edition, Mc Tazz, XE 12V 5-Spd. Man., (2E) 130 Carri P/van OHC 5-Spd. Man. (88-06), (AE92) (4A-GE) 1.6 RSi Twincam 5-Spd. Man. (88-93), (4A-F) 1.6 LS 3-Spd. Auto., (4A-F) 1.6 RS, Sport DOHC 5-Spd. Man. (88-93), (4A-FE) 160 i RS DOHC 4-Spd. Auto. (93-94), (4A-FE) 160 i RS, Sport, RSE DOHC 5-Spd. Man., (4A-FE) 160 i RSE, XE DOHC 5-Spd. Man. (93-06), Tazz (4A-FE) 160 i RSE, XE DOHC 5-Spd. Man. (93-06), (AE93) (7A-FE) 180 i RS, RSi, Sport DOHC 5-Spd. Man. (93-96), Corolla (AE92) (4A-F) 1.6 GL, GLS, Exec., Sprinter, GLE, Sport., (4A-GE) 1.6 DOHC, GLi, GLi Exec., (4A-F) 1.6 DOHC, 5-Spd. Man., 3-Spd. Auto., GL, GLX DOHC 4-Spd. Auto. (88-93), (4A-FE) 160i GL, GLE, Sprinter, DOHC 5-Spd. Man., 4-Spd. Auto. (92-96), (AE93) (7A-FE) 180i FWD GL, GLE, Sprinter, GSE, GSX, DOHC Man., Auto. (93-96), (EE90) (2E, 2E-L) 1.3 FWD L, GL, GLE, Sprinter OHC 4/5-Spd. Man. (88-96)</p>		<p>AR6211 Front Strut Mounting</p> <p>Nissan Sabre (GA16DS) 160 GX, GXi, (SR20DE) 200 GXi (94-02), Sentra (GA14DNE/DS) 140, GX, GXi, i, Si, (GA16DNE/S) 160, GSi, GX, GXi, SE, Si, (SR20DE) 200 GSi, STi (92-02)</p>
	<p>AR6207 Engine Mounting - LHS</p> <p>Toyota Corolla (EE110) (2E) 130 FWD GLE OHC 5-Spd. Man. (96-02)</p>		<p>AR6212 Transmission Mounting</p> <p>Mazda Astina (BPi) 180Se Sedan, Hatch Man. (95-00), Etude (B6i) 160, e, i, ie, Ise, Sport 16V Man., (BPi) 180e, iSe, Se, Sedan Man. (95-00)</p>
			<p>AR6213 Engine Mounting - Rear</p> <p>Mazda Astina (BPi) 180Se Sedan, Hatch (95-00), Etude (B6i) 160, e, i, ie, Ise, Sport 16V, (BPi) 180e, iSe, Se, Sedan (95-00)</p>
			<p>AR6214 Engine Mounting - LHS</p> <p>Mazda Astina (BPi) 180Se Sedan, Hatch (95-00), Etude (B6i) (BPi) 180e, iSe, Se, Sedan (95-00)</p>
			<p>AR6215 Transmission Mounting</p> <p>Mazda Astina (BPi) 180Se Sedan, Hatch Auto. (95-00), Etude (B6i) 160, e, i, ie, Ise, Sport 16V Auto., (BPi) 180e, iSe, Se, Sedan Auto. (95-00)</p>
		 <p>ID: 45, OD: 60, H: 37</p>	<p>AR6216 Steering Rack Mounting</p> <p>Nissan Sabre (GA16DS) 160 GX, GXi, (SR20DE) 200 GXi (97-02), Sentra (GA14DNE/DS) 140, GX, GXi, i, Si (92-97), (GA16DNE/S) 160, GSi, GX, GXi, SE, Si, (SR20DE) 200 GSi, STi (92-02)</p>
		 <p>ID: 43, L: 39, H: 58, W: 63</p>	<p>AR6217 Steering Rack Mounting</p> <p>Nissan Sabre (GA16DS) 160 GX, GXi, (SR20DE) 200 GXi (97-02), Sentra (GA14DNE/DS) 140, GX, GXi, i, Si (97-02), (GA16DNE/S) 160, GSi, GX, GXi, SE, Si, (SR20DE) 200 GSi, STi (92-02)</p>

ENGINE MOUNTING & RUBBER BUYERS GUIDE

255

 ID: 12, OD: 74, L: 61	AR6218 Engine Mounting - Rear Nissan Sentra (GA16DNE/S) 160, GSi, GX, GXi, SE, Si (92-02), Sentra (GA16DNE/S) 160, GSi, GX, GXi, SE, Si (92-02)
	AR6219 Engine Mounting - RHS Nissan Sabre (GA16DS) 160 GX, GXi, (SR20DE) 200 GXi (94-02), Sentra (SR20DE) 200 GSi, STi (92-97)
	AR6220 Engine Mounting - LHS Nissan Sentra (GA14DNE/DS) 140, GX, GXi, i, Si (92-02), Sentra (GA14DNE/DS) 140, GX, GXi, i, Si (92-02)
	AR6221 Engine Mounting - LHS Nissan Sentra (GA16DNE/S) 160, GSi, GX, GXi, SE, Si (92-02)
	AR6222 Engine Mounting - LHS Nissan Sabre (GA16DS) 160 GX, GXi, (SR20DE) 200 GXi (94-02), Sentra (GA16DNE/S) 160, GSi, GX, GXi, SE, Si (92-02)
	AR6223 Engine Mounting - Front Nissan Sabre (GA16DS) 160 GX, GXi (94-02), Sentra (GA14DNE/DS) 140, GX, GXi, i, Si, (GA16DNE/S) 160, GSi, GX, GXi, SE, Si, (SR20DE) 200 GSi, STi (92-02)
	AR6225 Engine Mounting - Rear Nissan Sabre (GA16DS) 160 GX, GXi, (SR20DE) 200 GXi (94-02), Sentra (GA14DNE/DS) 140, GX, GXi, i, Si, (GA16DNE/S) 160, GSi, GX, GXi, SE, Si, (SR20DE) 200 GSi, STi (92-02)
	AR6226 Engine Mounting - Front Toyota Corolla (AE111) (4A-FE) 160i GL, GLE P/S DOHC, 5-Spd. Man., 4-Spd. Auto., (4A-GE) 160i RSi, RXi DOHC 5/6-Spd. Man. (96-99), (AE112) (7A-FE) 180i GLE, GSE DOHC, 5-Spd. Man., 4-Spd. Auto. (96-99), (EE110) (2E) 130 FWD GLE OHC 5-Spd. Man. (96-02)
	AR6227 Engine Mounting - RHS Toyota Corolla (EE110) (2E) 130 FWD GLE OHC 5-Spd. Man. (96-02)
	AR6228 Engine Mounting - RHS Toyota Corolla (AE111) (4A-FE) 160i GL, GLE P/S DOHC, 5-Spd. Man., 4-Spd. Auto. (96-99), (4A-FE) 160i GL, GLE DOHC, 5-Spd. Man., 4-Spd. Auto. (99-02)
	AR6229 Engine Mounting - LHS Toyota Corolla (AE111) (4A-FE) 160i GL, GLE P/S DOHC, 5-Spd. Man., 4-Spd. Auto. (96-98), (AE112) (7A-FE) 180i GLE, GSE DOHC, 5-Spd. Man., 4-Spd. Auto. (96-98)
	AR6230 Engine Mounting - Rear Toyota Corolla (AE111) (4A-GE) 160i RSi, RXi DOHC 5/6-Spd. Man. (96-99), (4A-FE) 160i GL, GLE DOHC, 5-Spd. Man., (4A-GE) 160i Si, RXi, DOHC 5/6-Spd. Man. (99-02), (AE112) (7A-FE) 180i GLE, GSE DOHC, 5-Spd. Man., 4-Spd. Auto. (96-02), (EE110) (2E) 130 FWD GLE OHC 5-Spd. Man. (96-02)
	AR6231 Engine Mounting - Rear Toyota Corolla (AE111) (4A-FE) 160i GL, GLE P/S DOHC, 4-Spd. Auto. (96-99), (4A-FE) 160i GL, GLE DOHC, 4-Spd. (99-02)

	AR6232 Engine Mounting - LHS Toyota Conquest (EE90) (2E-L) 1.3 S, GS 12V 4-Spd. Man., (2E) 130 Zipp, Sport, Tazz, Sport 4-Spd., Tropicque, Ruby, Edition, Mc Tazz, XE 12V 5-Spd. Man., (2E) 130 Carri P/van OHC 5-Spd. Man. (88-06), (4A-F) 1.6 LS 3-Spd. Auto., (4A-F) 1.6 RS, Sport DOHC 5-Spd. Man. (88-93), Corolla (AE92) (4A-F) 1.6 GL, GLS, Exec. (88-93), (EE90) (2E, 2E-L) 1.3 FWD L, GL, GLE, Sprinter OHC 4/5-Spd. Man. (88-96)
 ID: 21, L: 28, H: 35, W: 44	AR6234 Front Stabilizer Bar Bush Honda Ballade (SO4) (D15Z4) 150i, Series, Encore, Luxline, Spreeline, Auto., (D16Y9, 16Z) 160i Luxline, Spreeline, (B18B4) 180i Luxline (96-00), Civic (SO3) (D15Z4) 150i Luxline, Spreeline, (D16Y9) 160i Luxline, (D16A6) 160i V-TEC (96-03), Civic (SO4) (D16Z) 160i V-TEC, (B18B4) 180i Luxline, Spreeline (96-03)
 ID: 25, L: 27, H: 35.5, W: 44	AR6235 Front Stabilizer Bar Bush Honda Civic (SO3) (D15Z4) 150i Luxline, Spreeline, (D16Y9) 160i Luxline, (D16A6) 160i V-TEC (96-03), Civic (SO4) (D16Z) 160i V-TEC, (B18B4) 180i Luxline, Spreeline (96-03), CR-V 4X4 (B20Z1) 2.0 SWB SUV Pet. (97-05)
	AR6236 Engine Mounting - RHS Honda Ballade (SR4) (D15B3) 150 Encore, Luxline, Spreeline Auto., (D16A7) 160E, i, Luxline, Spreeline Auto., (B18B3) 180E, i Luxline, Spreeline Auto. (92-98)
	AR6237 Engine Mounting - LHS Honda Ballade (SR4) (D15B3) 150 Encore, Luxline, Spreeline, (D16A7) 160i, Luxline, Spreeline, (B18B3) 180i Luxline, Spreeline (92-98)
	AR6238 Engine Mounting - Rear Honda Ballade (SH4) (D15B3) 150 16V SOHC Auto., (D16A9) 160i 16V SOHC, DOHC Auto. (89-92)
	AR6239 Engine Mounting - LHS Honda Ballade (SH4) (D15B3) 150 16V SOHC, (D16A9) 160i 16V SOHC, DOHC (89-92)
	AR6240 Engine Mounting - LHS Honda Ballade (SO4) (D15Z4) 150i, Series, Encore, Luxline, Spreeline, Auto., (D16Y9, 16Z) 160i Luxline, Spreeline, (B18B4) 180i Luxline (96-00), Civic (SO3) (D15Z4) 150i Luxline, Spreeline, (D16Y9) 160i Luxline, (D16A6) 160i V-TEC (96-03), Civic (SO4) (D16Z) 160i V-TEC, (B18B4) 180i Luxline, Spreeline (96-03)
	AR6241 Engine Mounting - LHS Honda Ballade (SR4) (D16A7) 160E, Luxline, Spreeline, (B18B3) 180E, Luxline, Spreeline (92-98)
	AR6242 Engine Mounting - RHS Honda Ballade (SH4) (D15B3) 150 16V SOHC Auto., (D16A9) 160i 16V SOHC, DOHC Auto. (89-92)
	AR6243 Engine Mounting - Front LHS Honda Ballade (SR4) (D15B3) 150 Encore, Luxline, Spreeline, (D16A7) 160E, i, Luxline, Spreeline, (B18B3) 180E, i Luxline, Spreeline (92-98), Ballade (SO4) (D15Z4) 150i, Series, Encore, Luxline, Spreeline, Auto., (D16Y9, 16Z) 160i Luxline, Spreeline, (B18B4) 180i Luxline (96-00), Civic (SO3) (D15Z4) 150i Luxline, Spreeline, (D16Y9) 160i Luxline, (D16A6) 160i V-TEC (96-03), Civic (SO4) (D16Z) 160i V-TEC, (B18B4) 180i Luxline, Spreeline (96-03)

ENGINE MOUNTING & RUBBER BUYERS GUIDE

	<p>AR6244 Engine Mounting - Front RHS</p> <p>Honda Ballade (SR4) (D15B3) 150 Encore, Luxline, Spreeline Auto., (D16A7) 160E, i, Luxline, Spreeline Auto., (B18B3) 180E, i Luxline, Spreeline Auto. (92-98), Ballade (SO4) (D15Z4) 150i, Series, Encore, Luxline, Spreeline, Auto., (D16Y9, 16Z) 160i Luxline, Spreeline Auto., (B18B4) 180i Luxline Auto. (96-00), Civic (SO3) (D15Z4) 150i Luxline, Spreeline Auto., (D16Y9) 160i Luxline Auto., (D16A6) 160i V-TEC Auto. (96-03), Civic (SO4) (D16Z) 160i V-TEC, (B18B4) 180i Luxline, Spreeline Auto. (96-03), CR-V 4X4 (B20Z1) 2.0 SWB SUV Pet. Auto. (97-05)</p>		<p>AR6253 Engine Mounting - LHS</p> <p>Opel Astra F (14NV) 140, i, S, (16NZ) 160, i, Estate, iE, iS OHC, (18XE) 180i 18SE/XL iE OHC, (20SE) 200i, Estate, iE, (20XE) tS (93-99), Kadett (14NE) 140, S, (16NZ) 160i S, (18SE) 180i, iE, (20SE) 200iS, (20XE) tS (93-99) - Vehicles without Aircon</p>
	<p>AR6245 Engine Mounting - Front</p> <p>Honda Ballade (SH4) (D15B3) 150 16V SOHC Man., (D16A9) 160i 16V SOHC, DOHC Man. (89-92)</p>		<p>AR6254 Engine Mounting - Rear</p> <p>Opel Astra F (14NV) 140, i, S, (16NZ) 160, i, Estate, iE, iS OHC, (20SE) 200i, Estate, iE, (20XE) tS (93-99)</p>
	<p>AR6246 Engine Mounting - Front</p> <p>Honda Ballade (SH4) (D15B3) 150 16V SOHC Auto., (D16A9) 160i 16V SOHC, DOHC Auto. (89-92)</p>		<p>AR6255 Engine Mounting - Rear</p> <p>Opel Astra F (18XE) 180i 18SE/XL iE OHC (93-99)</p>
	<p>AR6247 Front Stabilizer Bar Bush - Outer</p> <p>Fiat Uno (156A2) 1.0 Cento, (160A3) 1.1 Fire, Mia, Rio, Tempo, Espresso P/van (90-05), (146C1) 1.4 Beat, Mia, Pacer, Pacer SX, Tempo SX, (146A) 1.4 Turbo (90-98)</p>		<p>AR6256 Engine Mounting - Rear</p> <p>Opel Kadett (20SE) 200iS, (20XE) tS (93-99)</p>
	<p>AR6249 Front Strut Mounting</p> <p>Toyota Conquest (EE90) (2E-L) 1.3 S, GS 12V 4-Spd. Man., (2E) 130 Zipp, Sport, Tazz, Sport 4-Spd., Tropique, Ruby, Edition, Mc Tazz, XE 12V 5-Spd. Man., (2E) 130 Carri P/van OHC 5-Spd. Man. (88-06), (AE92) (4A-GE) 1.6 RSi Twincam 5-Spd. Man. (88-93), (4A-F) 1.6 LS 3-Spd. Auto., (4A-F) 1.6 RS, Sport DOHC 5-Spd. Man. (88-93), (4A-FE) 160 i RS DOHC 4-Spd. Auto. (93-94), (4A-FE) 160 i RS, Sport, RSE DOHC 5-Spd. Man., (4A-FE) 160 i RSE, XE DOHC 5-Spd. Man. (93-06), Tazz (4A-FE) 160 i RSE, XE DOHC 5-Spd. Man. (93-06), Corolla (AE92) (4A-F) 1.6 GL, GLS (88-93), (AE93) (7A-FE) 180i FWD GL, GLE, Sprinter, GSE, GSX, DOHC Man., Auto. (93-96), (AE93) (7A-FE) 180i FWD GL, GLE, Sprinter, GSE, GSX, DOHC Man., Auto. (93-96), (EE90) (2E, 2E-L) 1.3 FWD L, GL, GLE, Sprinter OHC 4/5-Spd. Man. (88-96)</p>		<p>AR6257 Engine Mounting - LHS</p> <p>Opel Astra F (14NV) 140, i, S, (16NZ) 160, i, Estate, iE, iS OHC, (18XE) 180i 18SE/XL iE OHC, (20SE) 200i, Estate, iE, (20XE) tS (93-99), Kadett (14NE) 140, S, (16NZ) 160i S, (18SE) 180i, iE (93-99) - Vehicles with Aircon</p>
	<p>AR6250 Front Strut Mounting</p> <p>Toyota Conquest (EE80) (2E-L) 1.3 L, GL 12V 4-Spd. Man. (85-88), Corolla (AE82) (4A-GE) 1.6 L (84-88), (EE80) (2E-L) 1.3 FWD L, GL OHC 4-Spd. Man. (84-88)</p>		<p>AR6258 Engine Mounting - LHS</p> <p>Chevrolet Corsa 1.4 AC, Club, Sport, 1.7 DTi, Club, Sport, 1.8 Club, Sport (2010-), Utility 1.3D AC, Club, Sport, 1.4 AC, Club, Sport, 1.8 AC, Club, Sport (2010-); Opel Corsa B (13NE) 130 i, Lite, i S, le Chill Sedan, Hatch, (14NE) 140i Classic, Active, Lite, Lite+ Sedan, Hatch, (16SE) 160 i Classic, Sport, S, GSi, GSi Ltd., Classic iE, CD, CDE, S, Sedan, Hatch (96-03), Corsa LDV I (13NE) 130i Utility P/up Pet., (14NE) 1.4i Utility, S P/up Pet., (16NE) 1.6i Utility, S, P/up Sport (97-04), Corsa Pronto P/van (3NE) 1.3i Pet. (99-00)</p>
	<p>AR6251 Engine Mounting - RHS</p> <p>Volkswagen Caddy (HM, HV, JK) 1.6, i P/up Dies., Pet. 4-Spd. Man., (HV) 1.8 L Sport, Sport, P/up (96-03), Citi Golf 1.4 L, Chico, (AGY, BSY) 1.4i, L, Citi.com, VeloCiti, TenaCiti, CitiStorm, Sport, Rox, Rhythm Man., (AFX) 1.6i Life, Velociti, TenaCiti, CitiStorm, Sport, Rox 5-Spd. Man. (99-09), Golf III 1.6 GS 5-Spd. Man., 1.8 GSX, GTS 5-Spd. Man., 3-Spd. Auto., 2.0 GTi, 8V GTi Exec. 5-Spd. Man., 2.8 VR6, VR6 Exec. V6 5-Spd. Man., 4-Spd. Auto. (92-99), Jetta III 1.6 CSL 5-Spd. Man., 1.8 CLX, CSX 5-Spd. Man., 3-Spd. Auto., 2.0 CLi, CLi Exec. 5-Spd. Man., 2.8 VR6 Exec. V6 5-Spd. Man., 4-Spd. Auto. (92-99), Polo (6N) 1.4i Classic, Playa, 1.6i Classic Lux, Classic, Playa, 1.8i Classic Lux, Playa 5-Spd. Man. (96-03)</p>		<p>AR6259 Engine Mounting - RHS</p> <p>Chevrolet Corsa 1.4 AC, Club, Sport, 1.7 DTi, Club, Sport, 1.8 Club, Sport (2010-), Utility 1.3D AC, Club, Sport, 1.4 AC, Club, Sport, 1.8 AC, Club, Sport (2010-); Opel Corsa B (13NE) 130 i, Lite, i S, le Chill Sedan, Hatch, (14NE) 140i Classic, Active, Lite, Lite+ Sedan, Hatch, (16SE) 160 i Classic, Sport, S, GSi, GSi Ltd., Classic iE, CD, CDE, S, Sedan, Hatch (96-03), Corsa LDV I (13NE) 130i Utility P/up Pet., (14NE) 1.4i Utility, S P/up Pet., (16NE) 1.6i Utility, S, P/up Sport (97-04), Corsa Pronto P/van (3NE) 1.3i Pet. (99-00)</p>
	<p>AR6252 Centre Bearing Rubber</p> <p>Isuzu KB-Series KB160 (4ZA1) 1.6 SWB, Fleetside P/up Pet., KB200 (ZC1) 2.0 SWB, LWB, D/cab, LE, Fleetside, P/up Pet., KB220 (C22NE) 2.2 LWB D/cab, LE P/up Pet., KB230 (4ZD1) 2.3 SWB, LWB, D/cab P/up Pet., KB250D (4JA1) 2.5 SWB, LWB D/cab, LE, Fleetside, P/up Dies., KB280DT (4JB1) 2.8 SWB, LWB LE, D/cab LE, Frontier LX P/up (98-04), KB-Series 4X4 KB220 (C22NE) LWB D/cab, LE, P/up Pet., KB230 (4ZD1) SWB P/up Pet., KB250D (4JA1) SWB/LWB, D/cab, LE, LE D/cab P/up Dies., KB260 (4ZE1) LWB D/cab, LE, LX D/cab P/up, KB280DT (4JB1) SWB, LWB LE, LE D/cab, LX, LX D/cab, P/up (98-04), KB-Series KB260 (4ZE1) 2.6 SWB/LWB LE, LX, D/cab P/up Pet., KB320 (6VD1) 3.2 V6 SWB, LWB LE, LX, D/cab, Frontier, Reef, Blazer P/up Pet. (98-04), KB-Series 4X4 KB320 (6VD1) V6 SWB, LWB Frontier LX, LX, LX D/cab P/up Pet. (98-04)</p>		<p>AR6260 Engine Mounting - Rear</p> <p>Chevrolet Corsa 1.4 AC, Club, Sport, 1.7 DTi, Club, Sport, 1.8 Club, Sport (2010-), Utility 1.3D AC, Club, Sport, 1.4 AC, Club, Sport, 1.8 AC, Club, Sport (2010-); Opel Corsa B (13NE) 130 i, Lite, i S, le Chill Sedan, Hatch, (14NE) 140i Classic, Active, Lite, Lite+ Sedan, Hatch, (16SE) 160 i Classic, Sport, S, GSi, GSi Ltd., Classic iE, CD, CDE, S, Sedan, Hatch (96-03), Corsa LDV I (13NE) 130i Utility P/up Pet., (14NE) 1.4i Utility, S P/up Pet., (16NE) 1.6i Utility, S, P/up Sport, (X17D) 1.7D Utility P/up Dies. (97-04), Corsa Pronto P/van (3NE) 1.3i Pet. (99-00)</p>
			<p>AR6261 Engine Mounting - LHS</p> <p>Opel Corsa LDV I (13NE) 130i Utility P/up Pet., (14NE) 1.4i Utility, S P/up Pet., (16NE) 1.6i Utility, S, P/up Sport, (X17D) 1.7D Utility P/up Dies. (97-04)</p>
			<p>AR6262 Engine Mounting - RHS</p> <p>Opel Corsa LDV I (X17D) 1.7D Utility P/up Dies. (97-04)</p>
			<p>AR6264 Engine Stabilizer Rubber</p> <p>Toyota Conquest (AE92) (4A-F) 1.6 LS 3-Spd. Auto., (4A-F) 1.6 RS, Sport DOHC 5-Spd. Man. (88-93), Corolla (AE92) (4A-F) 1.6 GL, DOHC 4-Spd. Auto. (88-93), (4A-FE) 160i GL, GLE, Sprinter, DOHC 4-Spd. Auto. (92-96)</p>

ENGINE MOUNTING & RUBBER BUYERS GUIDE

	<p>AR6265 Exhaust Hanger - Front, Rear</p> <p>Toyota Condor (2Y) 1.8 Estate, TE Estate MPV Pet., 2.0i Estate, TE, Estate MPV, (2RZ-E) 2.4i Estate, TE, TX Estate MPV Pet. (00-05), Condor 4X2, 4X4 (2RZ-E) 2.4i Estate, TX Estate MPV Pet., 5-Spd. Man., (5L) 3.0 SWB Estate, TX Estate MPV Dies., (5L) 3.0 Estate, TE Estate MPV Dies. 5-Spd. Man. (00-05), Hilux (LN50) (L) 2.2 SWB P/up Dies. 4-Spd. Man. (84-98), (LN51) (2L) 2.4 SWB S D/cab, Raider P/up Dies. (84-98), (LN55) (L) 2.2 LWB P/up Dies. (84-98), (LN56) (2L) 2.4 LWB Raider, D/cab P/up Dies. (84-98), (LN57) (3L) 2.8 LWB Raider D/cab, P/up Dies. (95-05), (LN65) (2L) 2.4 LWB D/cab, Raider, D/Cab Dies. (89-98), (LN67) (3L) 2.8 LWB P/up, Raider, D/cab Dies. (95-05), (LN140) (2L) 2.4 SWB DLX P/up Dies. (98-05), (LN145) 2.4 LWB P/up Dies. (98-05), (LN192) (5L) 3.0D LWB D-E DLX, Raider D/cab Raised Body Dies., (KZ-TE) 3.0iD LWB D/cab Raider, Legend35 Raider, D/cab, Raider Dies. (98-05), (RN58) (22R) 2.4 LWB S, S D/cab, SR D/cab, SRX, Raider Pet. (84-98), (RN67) (22R) 2.4 LWB Raider, D/cab, Raider D/cab Pet. (89-98), (RZN147) (1RZ-E) 2.0 LWB SR D/cab Pet. 5-Spd. Man., (1RZ-E) 2.0 SWB SR, DLX, S, Pet. 5-Spd. Man. (98-05), (RZN169) (3RZ-FE) 2.7i LWB P/up, Raider, Raider D/C, SRX D/C, DLX S/C, Legend35, Legend35 D/C Pet. (98-05), (RZN194) (3RZ-FE) 2.7i LWB Legend35, Raider, Raider D/cab, Raised Body Pet. 5-Spd. Man. (98-05), (YN51) (2Y) 1.8 SWB S, SR, Raider P/up Pet., 5-Spd. Man. (86-98), (YN56) (2Y) 1.8 LWB P/up 4/5-Spd. Man. Pet. (86-98), (YN58) (4Y) 2.2 LWB Raider, SRX P/up Pet. (84-98), (YN67) (4Y) 2.2 LWB Raider D/cab, D/cab P/up Pet. (85-94), (YN140) (2Y) 1.8 SWB, LWB D/cab, Raider Pet. 5-Spd. Man. (98-05), Land Cruiser (FZJ100) 4X4 (2UZ-FE) 4.7 VX V8 Petrol 5-Spd. Man., 4-Spd. Auto. (98-03), (FZJ105) 4X4 (1FZ-FE) 4.2 Std., GX P/up Dies. Turbo 5-Spd. Man., 4-Spd. Auto. (98-06), (HDJ100) 4X4 (2UZ-FE) 4.7 VX V8 Petrol 5-Spd. Man., 4-Spd. Auto. (98-03), (UZJ100) 4X4 (2UZ-FE) 4.7 VX V8 Petrol 5-Spd. Man., 4-Spd. Auto. (98-03), Stallion (YF50) (2Y) 1.8 P/up, (2Y) 1.8 SR5 P/up, P/van, Pet., (LF50) (2L) 2400D P/up Dies. (91-04), Venture (YF50) (2Y) 1.8 P/van, 8/10-Seater Pet., 4/5-Spd. Man., (YF51) (4Y) 2.2 10-Seater, Getaway 5-Seater, GLE 9-Seater Pet. 5-Spd. Man., (LF50) (2L) 2.4 10-Seater Dies. 5-Spd. Man. (91-04)</p>
 <p>ID: 16, L: 23, H: 30.5, W: 40</p>	<p>AR6266 Front Stabilizer Bar Bush</p> <p>Ford Bantam 'Boet' (CLTA) 1.3i XL, XLS SWB P/up Pet., (Zetec) 1.6i XLE, XLT, SWB P/up Pet., 1.8di XL SWB P/up Dies. (02-12), Escort MKVI FWD (CVH-PTE) 1.4i Hatchback, Sedan, (Zetec) 1.6i GL, GLE Hatchback, Sedan, (Zetec) 1.8i GLi Pet., (Endura Die) 1.8 TD Dies. (95-00), Ikon (CLTA) 1.3i LX, Low, (CLTA) 1.6i LX, CLX, High, Low (01-06)</p>
	<p>AR6267 Exhaust Hanger - Middle, Rear</p> <p>Daewoo Espero (C18LE) 1.8 CD, (C20LE) 2.0 CD (96-98); Opel Corsa LDV I (13NE) 130i Utility P/up Pet., (14NE) 1.4i Utility, S P/up Pet., (16NE) 1.6i Utility, S, P/up Sport. (X17D) 1.7D Utility P/up Dies. (97-04); Opel Kadett (16SV) 1.6 L, GL, GLS, GSE, Rebel, 160 Cub, 160 GSE, (16NZ) GSi, i, (16NZ) Aspen, L, (16SH) GL, 1.8 (18SV) GLX, (18E) GSi, (L18LV) SE, 2.0 SGi, 200 Boss, Super Boss, CD, (20SEH) GSi 8V, (20XE, 20SHE) GSi 16V (84-93), Monza (16SV) 160 CLS, GLS, (16SE) GSi, i Aspen, (18SV) 1.8 CLX, GLE, Convertible, (18SE) GLi, GLX, (20SV) 2.0 Cabrio, CLi, (20SE/SV) 2.0 XE CD, CLE, GLE, GLi (86-93)</p>
 <p>ID: 14</p>	<p>AR6268 Front Strut Mounting</p> <p>Daewoo Cielo 1.5 GL, GLX, GTX, 150i, L (96-99), Espero (C18LE) 1.8 CD, (C20LE) 2.0 CD (96-98); Opel Kadett (NV) 1.3 Cub, GL, LS, Rebel 5-Spd. Man., (14NV) 140 CL 5-Spd., Cub 4-Spd. Man. (80-93), (16SV) 1.6 L, GL, GLS, GSE, Rebel, 160 Cub, 160 GSE, (16NZ) GSi, i, (16NZ) Aspen, L, (16SH) GL, 1.8 (18SV) GLX, (18E) GSi, (L18LV) SE, 2.0 SGi, 200 Boss, Super Boss, CD, (20SEH) GSi 8V, (20XE, 20SHE) GSi 16V (84-93), Monza (16SV) 160 CLS, GLS, (16SE) GSi, i Aspen, (18SV) 1.8 CLX, GLE, Convertible, (18SE) GLi, GLX, (20SV) 2.0 Cabrio, CLi, (20SE/SV) 2.0 XE CD, CLE, GLE, GLi (86-93)</p>
	<p>AR6269 Engine Mounting - LHS</p> <p>Toyota RAV4 I (SXA10/11) 4X4 (3S-FE) 2.0 3/5-Dr. SUV, DOHC, 5-Spd. Man. (94-97)</p>

	<p>AR6270 Engine Mounting - LHS</p> <p>Toyota RAV4 I (SXA10/11) 4X4 (3S-FE) 2.0 3/5-Dr. SUV, DOHC, 4-Spd. Auto. (94-97)</p>
	<p>AR6271 Engine Mounting - RHS</p> <p>Toyota RAV4 I (SXA10/11) 4X4 (3S-FE) 2.0 3/5-Dr. SUV, DOHC, 5-Spd. Man., 4-Spd. Auto. (94-97)</p>
	<p>AR6272 Transmission Mounting</p> <p>Toyota Land Cruiser (FJ80) 4X4 (3F-E) 4.0 GX, VX P/up Pet., 4-Spd. Auto. (90-92), (FZJ75) 4X4 (1FZF) 4.2 GX S/W Pet. 4-Spd. Man. (90-97), (HZJ75) 4X4 (1HZ) 4.2 P/up Pet., 4-Spd. Man. (90-97), (HZJ80) 4X4 (1HZ) 4.2 Std., GX 5-Spd. Man. Dies. 4-Spd. Auto., 5-Spd. Man. (90-95)</p>
	<p>AR6273 Engine Mounting - Front</p> <p>Toyota RAV4 I (SXA10/11) 4X4 (3S-FE) 2.0 3/5-Dr. SUV, DOHC, 5-Spd. Man., 4-Spd. Auto. (94-02)</p>
	<p>AR6274 Transmission Mounting</p> <p>Toyota RAV4 I (SXA10/11) 4X4 (3S-FE) 2.0 3/5-Dr. SUV, DOHC, 4-Spd. Auto. (94-95)</p>
 <p>ID: 14.3, L: 56, L: 41.4</p>	<p>AR6275 Front Lower Control Arm Bush - Inner Front</p> <p>Toyota RAV4 I (SXA10/11) 4X4 (3S-FE) 2.0 3/5-Dr. SUV, DOHC, 5-Spd. Man., 4-Spd. Auto. (94-02), RAV4 II (A/ZCA20) 4X2 (1ZZ-FE) 1.8 SUV Pet. 5-Spd. Man., RAV4 II (A/ZCA20) 4X4 (1AZ-FE) 2.0 SUV 5-Spd. Man., 4-Spd. Auto. (02-06)</p>
	<p>AR6276 Transmission Mounting</p> <p>Toyota Hilux (RZN147) (1RZ-E) 2.0 LWB SR D/cab Pet. 5-Spd. Man., (1RZ-E) 2.0 SWB SR, DLX, S, Pet. 5-Spd. Man. (98-05), (RZN194) (3RZ-FE) 2.7i LWB Legend35, Raider, Raider D/cab, Raised Body Pet. 5-Spd. Man. (98-05)</p>
 <p>ID: 9.6/8.4, OD: 30, W: 21</p>	<p>AR6277 Shock Rubber - Front Lower & Rear</p> <p>Toyota Hilux (LN192) (5L) 3.0D LWB D-E DLX, Raider D/cab Raised Body Dies., (KZ-TE) 3.0iD LWB D/cab Raider, Legend35 Raider, D/cab, Raider Dies. (98-05), (RZN169) (3RZ-FE) 2.7i LWB P/up, Raider, Raider D/C, SRX D/C, DLX S/C, Legend35, Legend35 D/C Pet. (98-05), (RZN194) (3RZ-FE) 2.7i LWB Legend35, Raider, Raider D/cab, Raised Body Pet. 5-Spd. Man. (98-05), Land Cruiser (FZJ100) 4X4 4.2 VX TD P/up, S/W, GX DSL P/up AHC Diesel 5-Spd. Auto. (02-04), Prado 90/95 4X4 (1KZ-TE) 3.0 GX, VX S/W Dies. 5-Spd. Man., Auto., 3.4 GX, VX S/W Man., Auto., Pet. (96-02)</p>
	<p>AR6278 Transmission Mounting</p> <p>Toyota Condor 4X4 (2RZ-E) 2.4i Estate, TX Estate MPV Pet., 5-Spd. Man., (5L) 3.0 SWB Estate, TX Estate MPV Dies., (5L) 3.0 Estate, TE Estate MPV Dies. 5-Spd. Man. (00-05), Hilux (RZN169) (3RZ-FE) 2.7i LWB P/up, Raider, Raider D/C, SRX D/C, DLX S/C, Legend35, Legend35 D/C Pet. (98-05)</p>
	<p>AR6279 Engine Mounting - L/RHS</p> <p>Toyota Land Cruiser (FZJ75) 4X4 (1FZF) 4.2 GX S/W Pet. 4-Spd. Man. (90-97), (HZJ75) 4X4 (1HZ) 4.2 P/up Pet., 4-Spd. Man. (90-97)</p>
	<p>AR6281 Engine Mounting - Rear</p> <p>Honda Ballade (SC9) (EW) 150 i "Flip-Up Lights" (84-89)</p>
	<p>AR6283 Engine Mounting - RHS</p> <p>Land Cruiser (FJ75) 4X4 (3F) 4.0 DLX P/up Petrol 5-Spd. Man. (90-91), (HJ75) 4X4 (3F) 4.0 DLX P/up Petrol 5-Spd. Man. (90-91)</p>

ENGINE MOUNTING & RUBBER BUYERS GUIDE

	<p>AR6284L Rear Strut Mounting - LHS</p> <p>Toyota Conquest (EE90) (2E-L) 1.3 S, GS 12V 4-Spd. Man., (2E) 130 Zipp, Sport, Tazz, Sport 4-Spd., Tropicque, Ruby, Edition, Mc Tazz, XE 12V 5-Spd. Man., (2E) 130 Carri P/van OHC 5-Spd. Man. (88-06), (AE92) (4A-GE) 1.6 RSi Twincam 5-Spd. Man. (88-93), (4A-F) 1.6 LS 3-Spd. Auto., (4A-F) 1.6 RS, Sport DOHC 5-Spd. Man. (88-93), (4A-FE) 160i RS DOHC 4-Spd. Auto. (93-94), (4A-FE) 160i RS, Sport, RSE DOHC 5-Spd. Man., (4A-FE) 160i RSE, XE DOHC 5-Spd. Man. (93-06), Tazz (4A-FE) 160i RSE, XE DOHC 5-Spd. Man. (93-06), Corolla (AE92) (4A-F) 1.6 GL, GLS, Exec., Sprinter, GLE, Sport., (4A-GE) 1.6 DOHC, GLi, GLi Exec., (4A-F) 1.6 DOHC, 5-Spd. Man., 3-Spd. Auto., GL, GLX DOHC 4-Spd. Auto. (88-93), (4A-FE) 160i GL, GLE, Sprinter, DOHC 5-Spd. Man., 4-Spd. Auto. (92-96), (AE93) (7A-FE) 180i FWD GL, GLE, Sprinter, GSE, GSX, DOHC Man., Auto. (93-96), (AE112) (7A-FE) 180i GLE, GSE DOHC, 5-Spd. Man., 4-Spd. Auto. (96-02), (EE90) (2E, 2E-L) 1.3 FWD L, GL, GLE, Sprinter OHC 4/5-Spd. Man. (88-96)</p>
	<p>AR6284R Rear Strut Mounting - RHS</p> <p>Toyota Conquest (EE90) (2E-L) 1.3 S, GS 12V 4-Spd. Man., (2E) 130 Zipp, Sport, Tazz, Sport 4-Spd., Tropicque, Ruby, Edition, Mc Tazz, XE 12V 5-Spd. Man., (2E) 130 Carri P/van OHC 5-Spd. Man. (88-06), (AE92) (4A-GE) 1.6 RSi Twincam 5-Spd. Man. (88-93), (4A-F) 1.6 LS 3-Spd. Auto., (4A-F) 1.6 RS, Sport DOHC 5-Spd. Man. (88-93), (4A-FE) 160i RS DOHC 4-Spd. Auto. (93-94), (4A-FE) 160i RS, Sport, RSE DOHC 5-Spd. Man., (4A-FE) 160i RSE, XE DOHC 5-Spd. Man. (93-06), Tazz (4A-FE) 160i RSE, XE DOHC 5-Spd. Man. (93-06), Corolla (AE92) (4A-F) 1.6 GL, GLS, Exec., Sprinter, GLE, Sport., (4A-GE) 1.6 DOHC, GLi, GLi Exec., (4A-F) 1.6 DOHC, 5-Spd. Man., 3-Spd. Auto., GL, GLX DOHC 4-Spd. Auto. (88-93), (4A-FE) 160i GL, GLE, Sprinter, DOHC 5-Spd. Man., 4-Spd. Auto. (92-96), (AE93) (7A-FE) 180i FWD GL, GLE, Sprinter, GSE, GSX, DOHC Man., Auto. (93-96), (AE112) (7A-FE) 180i GLE, GSE DOHC, 5-Spd. Man., 4-Spd. Auto. (96-02), (EE90) (2E, 2E-L) 1.3 FWD L, GL, GLE, Sprinter OHC 4/5-Spd. Man. (88-96)</p>
	<p>AR6285 Transmission Mounting</p> <p>Toyota Land Cruiser (FZJ75) 4X4 (1FZF) 4.2 GX S/W Dies. 4-Spd. Man. (90-97), (HZJ75) 4X4 (1HZ) 4.2 P/up Dies., 4-Spd. Man. (90-97), (HZJ105) 4X4 (1HZ) 4.2 GX P/up Dies. Turbo 5-Spd. Man. (98-06)</p>
	<p>AR6286 Front Lower Control Arm Bush - Inner & Outer</p> <p>Toyota Hilux (LN192) (5L) 3.0D LWB D-E DLX, Raider D/cab Raised Body Dies., (KZ-TE) 3.0iD LWB D/cab Raider, Legend35 Raider, D/cab, Raider Dies. (98-05), (RZN169) (3RZ-FE) 2.7i LWB P/up, Raider, Raider D/C, SRX D/C, DLX S/C, Legend35, Legend35 D/C Pet. (98-05), (RZN194) (3RZ-FE) 2.7i LWB Legend35, Raider, Raider D/cab, Raised Body Pet. 5-Spd. Man. (98-05)</p>
	<p>AR6288 Engine Mounting - LHS</p> <p>Renault Megane I (K4M, K7M) 1.6 Classic RT, Classic RXE, Classic RXT, RN Hatch, RSi Coupe, RT Cabriolet, RT Coupe, RT Hatch, RXE, RXE Cab., RXi Cab., RXT (96-02), Scenic I 1.4 RTE MPV, 1.6 RT, RXE MPV (98-02)</p>
	<p>AR6289 Engine Mounting - LHS</p> <p>Toyota Conquest (AE92) (4A-FE) 160i RS, Sport, RSE DOHC 5-Spd. Man., (4A-FE) 160i RSE, XE DOHC 5-Spd. Man. (93-06), Tazz (4A-FE) 160i RSE, XE DOHC 5-Spd. Man. (93-06), (AE93) (7A-FE) 180i RS, RSi, Sport DOHC 5-Spd. Man. (93-96), Corolla (AE92) (4A-FE) 160i GL, GLE, Sprinter, DOHC 5-Spd. Man. (92-96), (AE93) (7A-FE) 180i FWD GL, GLE, Sprinter, GSE, GSX, DOHC Man. (93-96), (AE111) (4A-GE) 160i RSi, RXi DOHC 5/6-Spd. Man. (1997-)</p>
	<p>AR6290 Engine Mounting - Rear</p> <p>Toyota Conquest (AE92) (4A-FE) 160i RS, Sport, RSE DOHC 5-Spd. Man., (4A-FE) 160i RSE, XE DOHC 5-Spd. Man. (93-06), Tazz (4A-FE) 160i RSE, XE DOHC 5-Spd. Man. (93-06), (AE93) (7A-FE) 180i RS, RSi, Sport DOHC 5-Spd. Man. (93-96), Corolla (AE92) (4A-FE) 160i GL, GLE, Sprinter, DOHC 5-Spd. Man. (92-96), (AE93) (7A-FE) 180i FWD GL, GLE, Sprinter, GSE, GSX, DOHC Man. (93-96)</p>













	<p>AR6291 Engine Mounting - Front</p> <p>Toyota Conquest (AE92) (4A-FE) 160i RS, Sport, RSE DOHC 5-Spd. Man., (4A-FE) 160i RSE, XE DOHC 5-Spd. Man. (93-06), Tazz (4A-FE) 160i RSE, XE DOHC 5-Spd. Man. (93-06), (AE93) (7A-FE) 180i RS, RSi, Sport DOHC 5-Spd. Man. (93-96), Corolla (AE92) (4A-FE) 160i GL, GLE, Sprinter, DOHC 5-Spd. Man. (92-96), (AE93) (7A-FE) 180i FWD GL, GLE, Sprinter, GSE, GSX, DOHC Man. (93-96)</p>
	<p>AR6293 Front Strut Mounting</p> <p>Toyota Conquest (AE93) (7A-FE) 180i RS, RSi, Sport DOHC 5-Spd. Man. (93-96), Corolla (AE92) (4A-F) 1.6 Sprinter, GLE, Sport., (4A-GE) 1.6 DOHC, GLi, GLi Exec., (4A-F) 1.6 DOHC, 5-Spd. Man., 3-Spd. Auto., GL, GLX DOHC 4-Spd. Auto. (88-93), (AE93) (7A-FE) 180i FWD GSX, DOHC Man., Auto. (93-96), (AE111) (4A-FE) 160i GL, GLE P/S DOHC, 5-Spd. Man., 4-Spd. Auto. (96-99), (AE112) (7A-FE) 180i GLE, GSE DOHC, 5-Spd. Man., 4-Spd. Auto. (96-99), (EE110) (2E) 130 FWD GLE OHC 5-Spd. Man. (96-02)</p>
	<p>AR6294 Caliper Guide Pin & Bush</p> <p>Toyota HiAce (YH53) (4Y) 2.2 SWB LS, GLX, GLX Exec. Wagon, Super10, (YH63) (4Y) 2.2 LWB Super16, SuperT, P/van, Siyaya Pet. 5-Spd. Man., 4-Spd. Auto. (93-09)</p>
	<p>AR6295 Exhaust Hanger - Front, Middle</p> <p>Toyota Conquest (EE90) (2E-L) 1.3 S, GS 12V 4-Spd. Man., (2E) 130 Zipp, Sport, Tazz, Sport 4-Spd., Tropicque, Ruby, Edition, Mc Tazz, XE 12V 5-Spd. Man., (2E) 130 Carri P/van OHC 5-Spd. Man. (88-06), Corolla (EE90) (2E, 2E-L) 1.3 FWD L, GL, GLE, Sprinter OHC 4/5-Spd. Man. (88-96), RAV4 II (A/ZCA20) 4X2 (1ZZ-FE) 1.8 SUV Pet. 5-Spd. Man., RAV4 II (A/ZCA20) 4X4 (1AZ-FE) 2.0 SUV 5-Spd. Man., 4-Spd. Auto. (02-06)</p>
	<p>AR6296 Front Stabilizer Bar Bush</p> <p>Toyota Corolla (AE111) (4A-FE) 160i GL, GLE P/S DOHC, 5-Spd. Man., 4-Spd. Auto., (4A-GE) 160i RSi, RXi DOHC 5/6-Spd. Man. (96-99), (4A-FE) 160i GL, GLE DOHC, 5-Spd. Man., 4-Spd. Auto., (4A-GE) 160i Si, RXi, DOHC 5/6-Spd. Man. (99-02), (AE112) (7A-FE) 180i GLE, GSE DOHC, 5-Spd. Man., 4-Spd. Auto. (96-02), (EE110) (2E) 130 FWD GLE OHC 5-Spd. Man. (96-02)</p>
	<p>AR6297 Steering Rack Mounting</p> <p>Toyota Corolla (AE111) (4A-FE) 160i GL, GLE P/S DOHC, 5-Spd. Man., 4-Spd. Auto., (4A-GE) 160i RSi, RXi DOHC 5/6-Spd. Man. (96-99), (4A-FE) 160i GL, GLE DOHC, 5-Spd. Man., 4-Spd. Auto., (4A-GE) 160i Si, RXi, DOHC 5/6-Spd. Man. (99-02), (AE112) (7A-FE) 180i GLE, GSE DOHC, 5-Spd. Man., 4-Spd. Auto. (96-02)</p>
	<p>AR6300 Engine Mounting - Rear</p> <p>Toyota Camry I (SXV10) (5S-FE) 220 Si, Sei 16V Man., (SXV11) (3S-FE) 200i, Si, 16V Man. (92-01)</p>
	<p>AR6301 Engine Mounting - Front</p> <p>Toyota Camry I (SXV10) (5S-FE) 220 Si, Sei 16V Man., (SXV11) (3S-FE) 200i, Si, 16V Man. (92-01)</p>
	<p>AR6303 Engine Mounting - Rear</p> <p>Toyota Camry I (SXV10) (5S-FE) 220 Si, Sei 16V Auto., (SXV11) (3S-FE) 200i, Si, 16V Auto. (92-97)</p>
	<p>AR6304 Engine Mounting - Rear</p> <p>Toyota Camry I (VCV10) (3VZ-FE) 300 SEi Quad Cam 5-Spd. (92-97), (MCV10) (1MZ-FE) 300 V6 SEi Quad Cam, Aluminum (97-01)</p>
	<p>AR6306 Engine Mounting - Front</p> <p>Toyota Camry I (SXV10) (5S-FE) 220 Si Auto., (SXV11) (3S-FE) 200i, Si Auto. (92-01)</p>

ENGINE MOUNTING & RUBBER BUYERS GUIDE

	AR6307 Transmission Mounting Toyota Camry I (SXV10) (5S-FE) 220 Si, Sei 16V Man., (SXV11) (3S-FE) 200i, Si, 16V Man. (92-01)
	AR6308 Transmission Mounting Toyota Camry I (VCV10) (3VZ-FE) 300 SEi Quad Cam 5-Spd. Auto. (92-97)
	AR6310 Front Strut Mounting Toyota Camry I (SXV10) (5S-FE) 220 Si, Sei 16V, (SXV11) (3S-FE) 200i, Si, 16V (92-01), (VCV10) (3VZ-FE) 300 SEi Quad Cam 5-Spd. (92-97), (MCV10) (1MZ-FE) 300 V6 SEi Quad Cam, Aluminum (97-01)
	AR6311L Rear Strut Mounting - LHS Toyota Camry I (SXV10) (5S-FE) 220 Si, Sei 16V, (SXV11) (3S-FE) 200i, Si, 16V (92-01), (VCV10) (3VZ-FE) 300 SEi Quad Cam 5-Spd. (92-97), (MCV10) (1MZ-FE) 300 V6 SEi Quad Cam, Aluminum (97-01)
	AR6311R Rear Strut Mounting - RHS Toyota Camry I (SXV10) (5S-FE) 220 Si, Sei 16V, (SXV11) (3S-FE) 200i, Si, 16V (92-01), (VCV10) (3VZ-FE) 300 SEi Quad Cam 5-Spd. (92-97), (MCV10) (1MZ-FE) 300 V6 SEi Quad Cam, Aluminum (97-01)
	AR6312 Engine Mounting, Stabilizer Link Toyota Camry I (SXV10) (5S-FE) 220 Si, Sei 16V Man., (SXV11) (3S-FE) 200i, Si, 16V Man. (92-01)
	AR6313 Engine Stabilizer Rubber Toyota Camry I (SXV10) (5S-FE) 220 Si Auto., (SXV11) (3S-FE) 200i, Si Auto. (92-01)
	AR6314 Rear Adjustable Lateral Link Bush - Inner Toyota Camry I (SXV10) (5S-FE) 220 Si, Sei 16V, (SXV11) (3S-FE) 200i, Si, 16V (92-01), (VCV10) (3VZ-FE) 300 SEi Quad Cam 5-Spd. (92-97), (MCV10) (1MZ-FE) 300 V6 SEi Quad Cam, Aluminum (97-01)
	AR6315 Centre Bearing Rubber BMW 1-Series (E81) 116i (N45) 1.6, 120d (N47) 2.0, 120i (N46) 2.0, 130i (N52) 3.0 (06-11), (E82) 120d (N47) 2.0, 125i (N52) 3.0, 135i (N54, N55) 3.0 (07-13), (E88) 125i (N52) 3.0, 135i (N54, N55) 3.0 (07-13), (F20) 116i (N13B16A) 1.6, 118i (N13B16A) 1.6, 120d (N47) 2.0 (11-15), 3-Series (E36) 325i (M50) 2.5 Dolphin Convertible, 325tds (M51) 2.5 6-Cyl. Dies., 328i (M52T) 2.8 (92-99), 328i (M52TU) 2.8 Dolphin Convertible, Individual (95-00), M3 (M54) 3.0, (S50B32/4) 3.2 Convertible (93-05), (E90) 320d (N47) 2.0, 320i (N46) 2.0, 323i (N52) 2.5, 325i (N52, N53) 2.5, 330i (N52, N53) 3.0, 335i (N54, N55) 3.0 (05-13), 5-Series (E39) 523i (M52) 2.5, 525i (M54) 2.5, 528i (M52) 2.8, 530d (M57) 3.0 Dies., 530i (M54) 3.0 (96-04), M5 (S62) 4.9 V8 (99-04)
	AR6316 Front Strut Mounting Opel Corsa B (13NE) 130 i, Lite, i S, le Chill Sedan, Hatch, (14NE) 140i Classic, Active, Lite, Lite+ Sedan, Hatch, (16SE) 160 i Classic, Sport, S, GSi, GSi Ltd., Classic iE, CD, CDE, S, Sedan, Hatch (96-03), Corsa LDV I (13NE) 130i Utility P/up Pet., (14NE) 1.4i Utility, S P/up Pet., (16NE) 1.6i Utility, S, P/up Sport, (X17D) 1.7D Utility P/up Dies. (97-04), Corsa Pronto P/van (3NE) 1.3i Pet. (99-00)

	AR6318 Exhaust Hanger - Front, Middle, Rear Mazda Drifter 1.8 SWB, LWB XL P/up Pet., 2.2 SWB, LWB XL, (WL4) 2.5TD LWB Hi Ride, S/cab, SL Hi Ride, SLE, SLX, D/cab, LX Hi Ride, P/up Dies., 2.6i LWB SL Hi Ride S/cab, SLE D/C, SLX, Hi Ride, SLX Hi Ride D/cab (00-08); Toyota Land Cruiser (FZJ80) 4X4 (1FZ-FE, 1HD) 4.5 Std., GX P/up, GX, VX S/W 12V Dies. 5-Spd. Man., 4-Spd. Auto. (90-98), (FZJ105) 4X4 (1FZ-FE) 4.2 Std., GX P/up Dies. Turbo 5-Spd. Man., 4-Spd. Auto. (98-06), 4.5 GX S/W Dies. 5-Spd. Man., 4-Spd. Auto., 4.7 VX S/W V8 Petrol (03-08), (HDJ80) 4X4 (1FZ-FE, 1HD) 4.5 Std., GX P/up, GX, VX S/W 12V Dies. 5-Spd. Man., 4-Spd. Auto. (90-98), (HDJ100) 4X4 (1FZ-FE) 4.5 GX, VX S/W Dies. 5-Spd. Man., 4-Spd. Auto. (98-06), (HZJ105) 4X4 (1HZ) 4.2 GX P/up Dies. Turbo 5-Spd. Man., Auto. (98-06), (UZJ105) 4X4 4.5 GX S/W Dies. 5-Spd. Man., 4-Spd. Auto., 4.7 VX S/W V8 Petrol (03-08), RAV4 I (SXA10/11) 4X4 (3S-FE) 2.0 3/5-Dr. SUV, DOHC, 5-Spd. Man., 4-Spd. Auto. (94-02)
	AR6319 Exhaust Hanger - Front, Middle & Rear Toyota Camry I (SXV10) (5S-FE) 220 Si, Sei 16V, (SXV11) (3S-FE) 200i, Si, 16V (92-01), (VCV10) (3VZ-FE) 300 SEi Quad Cam 5-Spd. (92-97), (MCV10) (1MZ-FE) 300 V6 SEi Quad Cam, Aluminum (97-01), Land Cruiser (FZJ100) 4X4 (2UZ-FE) 4.7 VX V8 Petrol 5-Spd. Man., 4-Spd. Auto. (98-03), 4.2 VX TD P/up, S/W, GX DSL P/up AHC Diesel 5-Spd. Auto. (02-04), (FZJ105) 4X4 (1FZ-FE) 4.2 Std., GX P/up Dies. Turbo 5-Spd. Man., 4-Spd. Auto. (98-06), (HDJ100) 4X4 (2UZ-FE) 4.7 VX V8 Petrol 5-Spd. Man., 4-Spd. Auto. (98-03), (UZJ100) 4X4 (2UZ-FE) 4.7 VX V8 Petrol 5-Spd. Man., 4-Spd. Auto. (98-03)
	AR6320 Centre Bearing Rubber Isuzu KB-Series KB200 (ZC1) 2.0 SWB, LWB, D/cab, LE, Fleetside, P/up Pet. (98-04), KB-Series 4X4 KB220 (C22NE) LWB D/cab, LE, P/up Pet. (1998-), KB250D (4JA1) SWB/LWB, D/cab, LE, LE D/cab P/up Dies., KB280DT (4JB1) SWB, LWB LE, LE D/cab, LX, LX D/cab, P/up (98-04), KB-Series KB320 (6VD1) 3.2 V6 SWB, LWB LE, LX, D/cab, Frontier, Reef, Blazer P/up Pet. (98-04), KB-Series KB300 TDC TDi LX, D/C LX, Fleetside P/up, Hi-Rider, D-MAX (04-13)
	AR6326 Front & Rear Stabilizer Link Grommet Toyota Corolla (TE72) (3T) 1.8 RWD GLS, SE OHV 5-Spd. Man., 3/4-Spd. Auto. (80-85), Cressida (GX71) (1G-E) 2.0 GLi6 5-Spd. Man., Executive DOHC, (1G-FE) I.R.S. 4-Spd. Auto. (86-92), (RX70) (21R) 2.0 GL, GLX, GL S/W, (RX72) (22R) 2.4 GLE, GL S/W, GLE S/W, (RX73) (22R) I.R.S. GL, GLE 4/5-Spd. Man./Auto. (87-92), (YX72) (3Y) 2.0 GS, GS Exec., GSE OHV 5-Spd. Man. (89-92)
	AR6327 Front Strut Mounting Toyota Corolla (TE72) (3T) 1.8 RWD GLS, SE OHV 5-Spd. Man., 3/4-Spd. Auto. (80-85)
	AR6328 Tension Rod Bush Toyota Corolla (TE72) (3T) 1.8 RWD GLS, SE OHV 5-Spd. Man., 3/4-Spd. Auto. (1980); Volkswagen Kombi (T2, T3) 2.3 Microbus, Volksiebus, 2.5i Caravelle, Microbus, 2.6i Caravelle, Microbus (74-04)
	AR6329 Tension Rod Bush Toyota Corolla (TE72) (3T) 1.8 RWD GLS, SE OHV 5-Spd. Man., 3/4-Spd. Auto. (81-85), Corolla (AE82) (4A-GE) 1.6 L (84-88), (EE80) (2E-L) 1.3 FWD L, GL OHC 4-Spd. Man. (84-88)

ENGINE MOUNTING & RUBBER BUYERS GUIDE

	<p>AR6331 Centre Bearing Rubber</p> <p>Isuzu KB-Series KB160 (4ZA1) 1.6 SWB, Fleetside P/up Pet., KB200 (ZC1) 2.0 SWB, LWB, D/cab, LE, Fleetside, P/up Pet., KB220 (C22NE) 2.2 LWB D/cab, LE P/up Pet., KB230 (4ZD1) 2.3 SWB, LWB, D/cab P/up Pet., KB250D (4JA1) 2.5 SWB, LWB D/cab, LE, Fleetside, P/up Dies., KB280DT (4JB1) 2.8 SWB, LWB LE, D/cab LE, Frontier LX P/up (98-04), KB-Series 4X4 KB220 (C22NE) LWB D/cab, LE, P/up Pet., KB230 (4ZD1) SWB P/up Pet., KB250D (4JA1) SWB/LWB, D/cab, LE, LE D/cab P/up Dies., KB260 (4ZE1) LWB D/cab, LE, LX D/cab P/up, KB280DT (4JB1) SWB, LWB LE, LE D/cab, LX, LX D/cab, P/up (98-04), KB-Series KB260 (4ZE1) 2.6 SWB/LWB LE, LX, D/cab P/up Pet., KB320 (6VD1) 3.2 V6 SWB, LWB LE, LX, D/cab, Frontier, Reef, Blazer P/up Pet. (98-04)</p>		<p>AR6348 Steering Rack Mounting</p> <p>Mercedes-Benz (W203) C-Class C180 (M111.920) 1.8 Classic, C200 (M271.940) 2.0 Classic, S/W, C220 (OM611.962, OM646.963) 2.2 CDi Classic, S/W, Elegance, C230 2.3 Coupe, C240 (M203.086) 2.6 V6 Elegance, S/W, Elegance S/W, C270 (OM612.962) 2.7 CDi 5-Cyl. Elegance, S/W, C320 (M111.946) 3.2 V6 Avantgarde Elegance, SW, (M271.946) C180K, (M271.940) C200K, (OM611.962, OM646.963) C220 CDi, (M271.948) C230K, (M112.912) C240/240T, (OM642.910) C320 CDi, (M272.960) C350 (00-11), (W209) CLK320 (M112.940) 3.2 V6 Elegance, Cabrio (98-05)</p>
 <p>ID: 51, L: 26, H: 67, W: 69</p>	<p>AR6332 Steering Rack Mounting - LHS</p> <p>Toyota Conquest (EE90) (2E-L) 1.3 S, GS 12V 4-Spd. Man., (2E) 130 Zipp, Sport, Tazz, Sport 4-Spd., Tropique, Ruby, Edition, Mc Tazz, XE 12V 5-Spd. Man., (2E) 130 Carri P/van OHC 5-Spd. Man. (88-06), (4A-FE) 160 i RS, Sport, RSE DOHC 5-Spd. Man., (4A-FE) 160 i RSE, XE DOHC 5-Spd. Man. (93-06), Tazz (4A-FE) 160 i RSE, XE DOHC 5-Spd. Man. (93-06), (AE93) (7A-FE) 180 i RS, RSi, Sport DOHC 5-Spd. Man. (93-96), Corolla (AE92) (4A-F) 1.6 GL, GLS, Exec., Sprinter, GLE, Sport., (4A-GE) 1.6 DOHC, GLi, GLi Exec., (4A-F) 1.6 DOHC, 5-Spd. Man., 3-Spd. Auto., GL, GLX DOHC 4-Spd. Auto. (88-93), (4A-FE) 160i GL, GLE, Sprinter, DOHC 5-Spd. Man., 4-Spd. Auto. (92-96), (AE93) (7A-FE) 180i FWD GL, GLE, Sprinter, GSE, GSX, DOHC Man., Auto. (93-96), (EE110) (2E) 130 FWD GLE OHC 5-Spd. Man. (96-02)</p>		<p>AR6349 Engine Mounting - LHS</p> <p>Toyota Corolla (AE111) (4A-GE) 160i RSi, Rxi DOHC 5/6-Spd. Man. (1998-), (4A-GE) 160i Si, Rxi, DOHC 5/6-Spd. Man. (1999-)</p>
	<p>AR6333 Propshaft Coupling</p> <p>BMW 5-Series (E60) 530d (M57) 3.0 (04-10)</p>		<p>AR6350 Engine Mounting - LHS</p> <p>Toyota Corolla (AE111) (4A-FE) 160i GL, GLE DOHC, 5-Spd. Man., 4-Spd. Auto., (4A-GE) 160i Si, Rxi, DOHC 5/6-Spd. Man. (1999-)</p>
 <p>ID: 15</p>	<p>AR6336 Front Strut Mounting</p> <p>Toyota Corolla (AE111) (4A-GE) 160i RSi, Rxi DOHC 5/6-Spd. Man. (96-99), (4A-FE) 160i GL, GLE DOHC, 5-Spd. Man., 4-Spd. Auto., (4A-GE) 160i Si, Rxi, DOHC 5/6-Spd. Man. (99-02), (AE112) (7A-FE) 180i GLE, GSE DOHC, 5-Spd. Man., 4-Spd. Auto. (99-02)</p>		<p>AR6351 Engine Mounting - RHS</p> <p>Toyota Corolla (AE111) (4A-GE) 160i RSi, Rxi DOHC 5/6-Spd. Man. (96-99), (4A-GE) 160i Si, Rxi, DOHC 5/6-Spd. Man. (99-02), (AE112) (7A-FE) 180i GLE, GSE DOHC, 5-Spd. Man., 4-Spd. Auto. (96-02), (EE110) (2E) 130 FWD GLE OHC 5-Spd. Man. (96-02)</p>
	<p>AR6337 Engine Mounting - RHS</p> <p>Toyota Corolla (AE80) (2A-L) 1.3 FWD GL 8V 4-Spd. Man. (84-88)</p>	 <p>ID: 12, OD: 45, L: 46</p>	<p>AR6353 Front Lower Control Arm Bush - Inner Front & Outer Rear</p> <p>Renault Megane I (K4M, K7M) 1.6 Classic RT, Classic RXE, Classic RXT, RN Hatch, RSi Coupe, RT Cabriolet, RT Coupe, RT Hatch, RXE, RXE Cab., Rxi Cab., RXT, (F3R) 2.0 Cabriolet, RSi Cabriolet, RXE Classic, (F3R, F7R) 2.0 Coupe 16V/8V, RSi Coupe, RXE (96-02), Scenic I 1.4 RTE MPV, 1.6 RT, RXE MPV, 2.0 RXE, Rxi MPV (98-02)</p>
 <p>ID: 24, L: 31, H: 39, W: 47</p>	<p>AR6341 Front Stabilizer Bar Bush</p> <p>Toyota Cressida (GX71) (1G-E) 2.0 GLi6 5-Spd. Man., Executive DOHC, (1G-FE) I.R.S. 4-Spd. Auto. (86-92), Cressida (MX73) (5M-GE) 2.8i RSi, RSi Exec. DOHC 5-Spd. Man., 4-Spd. Auto., (MX75) 3.0 GLS 5-Spd. Man., (ECT) (7M-GE) 3.0i I.R.S. 24V DOHC 4-Spd. Auto. (86-92), Cressida (RX72) (22R) 2.4 GLE, GL S/W, GLE S/W, (RX73) (22R) I.R.S. GL, GLE 4/5-Spd. Man./Auto. (87-92), Cressida (YX72) (3Y) 2.0 GS, GS Exec., GSE OHV 5-Spd. Man. (89-92)</p>	 <p>ID: 25</p>	<p>AR6358 Centre Bearing Rubber</p> <p>Mercedes-Benz (W202) C-Class (M111.920/21) C180 1.8 Classic, (M111.941) C200 2.0 Classic, Elegance, C220 (M111.961) 2.2 Classic, Elegance, C230 (M111.974) 2.3 Classic, Elegance, Kompressor, Sport, C240 (M112.910) 2.4 Classic, Elegance, C250D, TD (M605.910) 2.5 5-Cyl., C280 (M104.941) 2.8 6-Cyl. Elegance (94-00)</p>
	<p>AR6342 Engine Mounting - LHS</p> <p>Toyota Corolla (AE92) (4A-F) 1.6 GLX DOHC 4-Spd. Auto. (88-93)</p>	 <p>ID: 14</p>	<p>AR6359 Front Strut Mounting</p> <p>Mercedes-Benz (W203) C-Class C180 (M111.920) 1.8 Classic, C200 (M271.940) 2.0 Classic, S/W, C220 (OM611.962, OM646.963) 2.2 CDi Classic, S/W, Elegance, C230 2.3 Coupe, C240 (M203.086) 2.6 V6 Elegance, S/W, Elegance S/W, C270 (OM612.962) 2.7 CDi 5-Cyl. Elegance, S/W, C320 (M111.946) 3.2 V6 Avantgarde Elegance, SW, (M271.946) C180K, (M271.940) C200K, (OM611.962, OM646.963) C220 CDi, (M271.948) C230K, (M112.912) C240/240T, (OM642.910) C320 CDi, (M272.960) C350 (00-11)</p>
	<p>AR6343 Engine Mounting - LHS</p> <p>Toyota Conquest (AE92) (4A-GE) 1.6 RSi Twincam 5-Spd. Man. (88-93), Corolla (AE92) (4A-F) 1.6 Sprinter, GLE, Sport., (4A-GE) 1.6 DOHC, GLi, GLi Exec., (4A-F) 1.6 DOHC, 5-Spd. Man., 3-Spd. Auto., GL, DOHC 4-Spd. Auto. (88-93)</p>		<p>AR6363 Engine Mounting - RHS</p> <p>Toyota Corolla (AE92) (4A-F) 1.6 GL, GLS, Exec., Sprinter, GLE, Sport., (4A-GE) 1.6 DOHC, GLi, GLi Exec., (4A-F) 1.6 DOHC, 5-Spd. Man., 3-Spd. Auto., GL, GLX DOHC 4-Spd. Auto. (88-93)</p>
	<p>AR6347 Engine Mounting - LHS</p> <p>Toyota Corolla (AE111) (4A-FE) 160i GL, GLE DOHC, 4-Spd. Auto. (99-02), (AE112) (7A-FE) 180i GLE, GSE DOHC, 4-Spd. Auto. (99-02)</p>	 <p>ID: 20, OD: 46, L: 31</p>	<p>AR6365 Tension Rod Bush</p> <p>Toyota Cressida TX62, YX70 1.8 L, LS, RX60, RX62 2.0 GL, S/W, GLE, GX60 GLi6, GLX, MX63 2.8i (81-89)</p>
	<p>AR6347 Engine Mounting - LHS</p> <p>Toyota Corolla (AE111) (4A-FE) 160i GL, GLE P/S DOHC, 5-Spd. Man., 4-Spd. Auto., (4A-GE) 160i RSi, Rxi DOHC 5/6-Spd. Man. (96-99), (4A-FE) 160i GL, GLE DOHC, 5-Spd. Man., 4-Spd. Auto., (4A-GE) 160i Si, Rxi, DOHC 5/6-Spd. Man. (99-02), (EE110) (2E) 130 FWD GLE OHC 5-Spd. Man. (96-02)</p>		<p>AR6366 Exhaust Hanger - Middle, Rear</p> <p>Toyota Corolla (AE111) (4A-FE) 160i GL, GLE P/S DOHC, 5-Spd. Man., 4-Spd. Auto., (4A-GE) 160i RSi, Rxi DOHC 5/6-Spd. Man. (96-99), (4A-FE) 160i GL, GLE DOHC, 5-Spd. Man., 4-Spd. Auto., (4A-GE) 160i Si, Rxi, DOHC 5/6-Spd. Man. (99-02), (EE110) (2E) 130 FWD GLE OHC 5-Spd. Man. (96-02)</p>

ENGINE MOUNTING & RUBBER BUYERS GUIDE

261

	AR6367 Rear Lateral Control Arm Bush - Outer Toyota Cressida (YX72) (3Y) 2.0 GS, GS Exec., GSE OHV 5-Spd. Man. (89-92)		AR6383 Front Lower Control Arm Bush - Inner Front Opel Astra F (14NV) 140, i, iS, (16NZ) 160, i, Estate, iE, iS OHC, (18XE) 180i 18SE/XL iE OHC, (20SE) 200i, Estate, iE, (20XE) tS (93-99), Kadett (14NE) 140, S, (16NZ) 160i S, (18SE) 180i, iE, (20SE) 200iS, (20XE) tS (93-99)
	AR6368 Rear Lateral Control Arm Bush - Outer Toyota Cressida (YX72) (3Y) 2.0 GS, GS Exec., GSE OHV 5-Spd. Man. (89-92)		AR6384 Engine Mounting - LHS Foton Thunda (493ZQ) 2.8D Taxi (2010-); Isuzu KB-Series 4X4 KB280DT (4JB1) SWB, LWB LE, LE D/cab, LX, LX D/cab, P/up (96-04)
	AR6370 Engine Mounting - Rear Nissan Sentra (E13S) 1.3 GL, SX, (E16E/S) 1.6 GL, GX, GXE, GXEi Coupe, SGLi (87-92)		AR6385 Engine Mounting - RHS Foton Thunda (493ZQ) 2.8D Taxi (2010-); Isuzu KB-Series 4X4 KB280DT (4JB1) SWB, LWB LE, LE D/cab, LX, LX D/cab, P/up (96-04)
	AR6372 Rear Lateral Control Arm Bush - Inner Toyota Cressida (YX72) (3Y) 2.0 GS, GS Exec., GSE OHV 5-Spd. Man. (89-92)		AR6386 Engine Mounting - LHS Honda Ballade (SC9) (EV2) 130 Man. "Flip-Up Lights", (EW) 150 i Man. "Flip-Up Lights", (ZC1) 160i DOHC Man. (84-89)
	AR6373 Rear Stabilizer Link Grommet Toyota Cressida (MX73) (5M-GE) 2.8i RSi, RSi Exec. DOHC 5-Spd. Man., 4-Spd. Auto. (86-92)		AR6387 Engine Mounting - LHS Honda Ballade (SC9) (EW) 150 i Man. "Flip-Up Lights" (84-89)
	AR6375 Front Strut Mounting Toyota Cressida (GX71) (1G-E) 2.0 GLi6 5-Spd. Man., Executive DOHC, (1G-FE) I.R.S. 4-Spd. Auto. (86-92), Cressida (MX73) (5M-GE) 2.8i RSi, RSi Exec. DOHC 5-Spd. Man., 4-Spd. Auto., (MX75) 3.0 GLS 5-Spd. Man., (ECT) (7M-GE) 3.0i I.R.S. 24V DOHC 4-Spd. Auto. (86-92), (RX70) (21R) 2.0 GL, GLX, GL S/W, (RX72) (22R) 2.4 GLE, GL S/W, GLE S/W, (RX73) (22R) I.R.S. GL, GLE 4/5-Spd. Man./Auto. (87-92), (YX72) (3Y) 2.0 GS, GS Exec., GSE OHV 5-Spd. Man. (89-92)		AR6388 Transmission Mounting Toyota Hilux (KZ-TE) 3.0D (00-05)
	AR6376 Front Strut Mounting - RHS Toyota Cressida 1.8 L, LS, 2.0 GL, S/W, GLE, GLi6, 2.8i (83-86)		AR6389 Rear Lower Control Arm Bush - Outer Toyota Camry I (SXV10) (5S-FE) 220 Si, Sei 16V, (SXV11) (3S-FE) 200i, Si, 16V (92-01), (VCV10) (3VZ-FE) 300 SEi Quad Cam 5-Spd. (92-97), (MCV10) (1MZ-FE) 300 V6 SEi Quad Cam, Aluminum (97-01)
	AR6377 Front Strut Mounting - LHS Toyota Cressida 1.8 L, LS, 2.0 GL, S/W, GLE, GLi6, 2.8i (83-86)		AR6390 Rear Stabilizer Bar Bush Toyota Camry I (SXV10) (5S-FE) 220 Si, Sei 16V, (SXV11) (3S-FE) 200i, Si, 16V (92-01), (VCV10) (3VZ-FE) 300 SEi Quad Cam 5-Spd. (92-97)
	AR6379 Steering Coupling Toyota Camry I (SXV10) (5S-FE) 220 Si, Sei 16V, (SXV11) (3S-FE) 200i, Si, 16V (92-01), (VCV10) (3VZ-FE) 300 SEi Quad Cam 5-Spd. (92-97), (MCV10) (1MZ-FE) 300 V6 SEi Quad Cam, Aluminum (97-01)		AR6391 Engine Mounting - Front Support Mazda 626 (FE) 2.0 SL Hatch, EGi (83-93)
	AR6380 Front Stabilizer Bar Bush Toyota Camry I (SXV10) (5S-FE) 220 Si, Sei 16V, (SXV11) (3S-FE) 200i, Si, 16V (97-01), (MCV10) (1MZ-FE) 300 V6 SEi Quad Cam, Aluminum (97-01)		AR6394 Transmission Mounting Toyota Camry I (SXV10) (5S-FE) 220 Si Auto., (SXV11) (3S-FE) 200i, Si Auto. (92-01)
	AR6381 Steering Rack Mounting Toyota Camry I (SXV10) (5S-FE) 220 Si, Sei 16V, (SXV11) (3S-FE) 200i, Si, 16V (92-97), (VCV10) (3VZ-FE) 300 SEi Quad Cam 5-Spd. (92-97)		AR6396 Steering Rack Mounting Toyota Camry I (SXV10) (5S-FE) 220 Si, Sei 16V, (SXV11) (3S-FE) 200i, Si, 16V (97-01), (MCV10) (1MZ-FE) 300 V6 SEi Quad Cam, Aluminum (97-01)
	AR6382 Engine Mounting - Rear Volkswagen Kombi (T2, T3) 2.3 Microbus, Volksiebus, 2.5i Caravelle, Microbus, 2.6i Caravelle, Microbus (74-04)		AR6400 Transmission Mounting Toyota Camry I (VCV10) (3VZ-FE) 300 SEi Quad Cam 5-Spd. Man. (92-97)
	AR6401 Engine Mounting - Front Toyota Camry I (VCV10) (3VZ-FE) 300 SEi Quad Cam 5-Spd. Auto. (92-95)		AR6401 Engine Mounting - Front Toyota Camry I (VCV10) (3VZ-FE) 300 SEi Quad Cam 5-Spd. Auto. (92-95)

ENGINE MOUNTING & RUBBER BUYERS GUIDE

	AR6402 Engine Mounting - Front Toyota Camry I (VCV10) (3VZ-FE) 300 SEi Quad Cam 5-Spd. Auto. (92-97)		AR6413 Shackle Bush - Front Nissan Hardbody (QW/244) (NA20S) 2.0 SWB, LWB SL P/up Pet., (KA20) 2.0i SWB, LWB S/Cab, SL, S/cab P/up Pet., (KA24) 2.4i LWB S/cab, SL S/cab, D/cab, SL D/cab, Hi Rider S/Cab, D/cab P/up Pet., (TD27i) 2.7 SE, D/C, TD LWB, S/cab, D/cab, SE P/up Dies. (98-11), Hardbody (D22, QW/244) (VG30E) 3.0i V6 LWB SL P/up Pet., (ZD30) 3.0D, TD LWB Hi Rider, KingCab, Hi Rider P/up Dies., (QD32) 3.2D LWB SE, SL, SLE, D/cab P/up Dies., (VG33E) 3.3 V6 LWB Hi Rider, S/cab, D/cab, KingCab P/up Pet. (98-10), Hardbody (D22, QW/244) 4X4 (KA24E) 2.4i LWB S/cab, SL D/cab, P/up Pet., (TD27i) 2.7D, LWB S/cab, SE, D/cab, P/up Dies., (ZD30) 3.0 V6 LWB D/cab, SE, SE D/cab, SL P/up Pet. (98-10), (ZD30) 3.0TD LWB D/cab, KingCab P/up Dies., (QD32) 3.2D LWB SL S/cab, SE D/cab P/up Dies., (VG33E) 3.3i V6 LWB D/cab, Hi Rider D/cab P/up Pet. (99-10), Hardbody NP300 (D22) (KA20DE) 2.0i SWB, LWB S, SE P/up Pet., (KA24DE) 2.4i LWB D/cab, D/cab Hi Rider P/up Pet., (YD25DDTi) 2.5 TDi LWB S, SE, D/C, D/C Hi Rider, P/up Dies. (2008-), Hardbody NP300 (D22) 4X4 (KA24DE) 2.4i LWB S/C, D/C Hi Rider P/up Pet., (YD25DDTi) 2.5 TDi LWB S, SE, D/C, D/C Hi Rider P/up Dies. (2008-), Patrol (Y61) 4X4 (VG30E) 3.0 V6 LWB Y60 S/W Pet., 3.0Di 6-Cyl. LWB GRX, TDi GL S/W Dies., (TD42) 4.2 6-Cyl. LWB LDF P/up, S/W Dies., 4.5 6-Cyl. LWB P/up Dies., 4.8 6-Cyl. LWB GL, GRX P/up Dies. (98-03), Sani (AW) (TD25i) 2.5D LWB Custom S/W, Dies., (TD27i) 2.7D LWB MKII, Exec. S/W Dies. (88-99), Sani 4X4 (TD27i) 2.7D LWB D/cab S/W, MKII, Exec. S/W Dies. (90-99)
	AR6404 Engine Stabilizer Link Toyota Camry I (VCV10) (3VZ-FE) 300 SEi Quad Cam 5-Spd. (92-97)		AR6414 Shackle Bush - Rear Upper Nissan Hardbody (QW/244) (NA20S) 2.0 SWB, LWB SL P/up Pet., (KA20) 2.0i SWB, LWB S/Cab, SL, S/cab P/up Pet., (KA24) 2.4i LWB S/cab, SL S/cab, D/cab, SL D/cab, Hi Rider S/Cab, D/cab P/up Pet., (TD27i) 2.7 SE, D/C, TD LWB, S/cab, D/cab, SE P/up Dies. (98-11), Hardbody (D22, QW/244) (VG30E) 3.0i V6 LWB SL P/up Pet., (ZD30) 3.0D, TD LWB Hi Rider, KingCab, Hi Rider P/up Dies., (QD32) 3.2D LWB SE, SL, SLE, D/cab P/up Dies., (VG33E) 3.3 V6 LWB Hi Rider, S/cab, D/cab, KingCab P/up Pet. (98-10), Hardbody NP300 (D22) (KA20DE) 2.0i SWB, LWB S, SE P/up Pet., (KA24DE) 2.4i LWB D/cab, D/cab Hi Rider P/up Pet., (YD25DDTi) 2.5 TDi LWB S, SE, D/C, D/C Hi Rider, P/up Dies. (2008-)
	AR6404A Engine Stabilizer Rod (Insert) Toyota Camry I (SXV10) (5S-FE) 220 Si, Sei 16V, (SXV11) (3S-FE) 200i, Si, 16V (92-01), (VCV10) (3VZ-FE) 300 SEi Quad Cam 5-Spd. (92-97)		AR6415 Tension Rod Bush Toyota HiAce (YH50) (2Y) 1.8 SWB P/van 4-Spd. Man. Pet., (YH60) (2Y) 1.8 LWB LS Wagon, P/van 5-Spd. Man. Pet. (83-91), (YH53) (4Y) 2.2 SWB LS, GLX, GLX Exec. Wagon, Super10, (YH63) (4Y) 2.2 LWB Super16, SuperT, P/van, Siyaya Pet. 5-Spd. Man., 4-Spd. Auto. (86-88)
	AR6405 Engine Mounting - L/RHS Toyota Hilux (KZ-TE) 3.0iD LWB D/cab Raider, Legend35 Raider, D/cab, Raider Dies. (98-05)		AR6416 Tension Rod Bush Toyota HiAce (YH53) (4Y) 2.2 SWB LS, GLX, GLX Exec. Wagon, Super10, (YH63) (4Y) 2.2 LWB Super16, SuperT, P/van, Siyaya Pet. 5-Spd. Man., 4-Spd. Auto. (88-09)
	AR6406 Front Lower Control Arm Bush - Outer Rear Opel Astra F (14NV) 140, i, iS, (16NZ) 160, i, Estate, iE, iS OHC, (18XE) 180i 18SE/XL iE OHC, (20SE) 200i, Estate, iE (93-99), Kadett (14NE) 140, S, (16NZ) 160i S, (18SE) 180i, iE, (20SE) 200iS (93-99)		AR6417 Front Lower Control Arm Bush - Outer Rear Audi A1 (CHZB) 1.0, (CBZA) 1.2 TFSi, (CAVG, CAXA) 1.4 TFSi, (CAYC) 1.6 Tdi Hatch 3-Dr, Sportback, (DAJB) 1.8 (11-18), A3 (AGN) 1.8, (AGU, BFU) 1.8T (98-04); Volkswagen Beetle (9C1, 9V1) (APH/AWU) 1.8T Coupe, (1Y7) (AEG) 2.0i Cabriolet, Coupe, HighLine, (9C1) (AEG) 2.0i Cabriolet, Coupe, HighLine (00-12), Golf II 1.3 CL 4-Spd. Man., 1.6 CSL 5-Spd. Man., 1.8 GTS 16V, CSX, GTi 8V, 16V, 5-Spd. Man., 3-Spd. Auto., 2.0 GTi 8V, Exec. 16V 5-Spd. Man. (84-92), Golf III 1.6 GS 5-Spd. Man., 1.8 GSX, GTS 5-Spd. Man., 3-Spd. Auto., 2.0 GTi, 8V GTi Exec. 5-Spd. Man., 2.8 VR6, VR6 Exec. V6 5-Spd. Man., 4-Spd. Auto. (92-99), Golf IV 1.6i Comfortline, Std., Tiptronic, 1.8 GTi HighLine, 1.8T GTi, 1.9 TDi HighLine, Comfortline, DSG, 2.0i Cabrio, HighLine (99-04), Jetta II 1.6 CSL 5-Spd. Man., 1.8 CLi, CLi Exec., Executive, CLX, CSX 5-Spd. Man., 3-Spd. Auto., 2.0 L 16V 5-Spd. Man. (85-92), Jetta III 1.6 CSL 5-Spd. Man., 1.8 CLX, CSX 5-Spd. Man., 3-Spd. Auto., 2.0 CLi, CLi Exec. 5-Spd. Man., 2.8 VR6 Exec. V6 5-Spd. Man., 4-Spd. Auto. (92-99), Jetta IV 1.6i Comfortline Std. 5-Spd. Man., 4-Spd. Auto., 1.9 TDi HighLine 5-Spd. Man., 2.0i HighLine 5-Spd. Man., 2.3 V5 5-Spd. Man. (99-05), Polo Vivo (CFWA) 1.2 TDi, (CLPA, CLPB) 1.4i Trendline, (CLSA) 1.6i Trendline (2010-), Up (CHYB) 1.0 (2015-)
	AR6407 Engine Mounting - Front Toyota Camry I (MCV10) (1MZ-FE) 300 V6 SEi Quad Cam, Aluminum (97-01)		
	AR6409 Transmission Mounting Toyota Camry I (MCV10) (1MZ-FE) 300 V6 SEi Quad Cam, Aluminum (97-01)		
	AR6410 Engine Stabilizer Link Toyota Camry I (MCV10) (1MZ-FE) 300 V6 SEi Quad Cam, Aluminum (97-01), Camry II (MCV10) (1MZ-FE) 3.0 GLX Sedan V6 Quad Cam, Aluminum (01-06)		
	AR6412 Exhaust Hanger - Front, Middle, Rear Toyota Stallion (KF50) (5K) 1.5 Commuter, P/up, SR5 P/up, Bus, P/van Pet., 4/5-Spd. Man. (87-91)		

ENGINE MOUNTING & RUBBER BUYERS GUIDE

 ID: 26, L: 32, H: 47, W: 51	AR6419 Front Stabilizer Bar Bush C.A.M Inyathi (SF491QE) 2.2i Bus, P/van (2006-); Toyota HiAce (YH53) (4Y) 2.2 SWB LS, GLX, GLX Exec. Wagon, Super10, (YH63) (4Y) 2.2 LWB Super16, SuperT, P/van, Siyaya Pet. 5-Spd. Man., 4-Spd. Auto. (92-97)
 ID: 22	AR6422 Front Stabilizer Bar Bush Mercedes-Benz (W203) C-Class C180 (M111.920) 1.8 Classic, C200 (M271.940) 2.0 Classic, S/W, C220 (OM611.962, OM646.963) 2.2 CDI Classic, S/W, Elegance, C230 2.3 Coupe, C240 (M203.086) 2.6 V6 Elegance, S/W, Elegance S/W, C270 (OM612.962) 2.7 CDI 5-Cyl. Elegance, S/W, C320 (M111.946) 3.2 V6 Avantgarde Elegance, SW, (M271.946) C180K , (M271.940) C200K , (OM611.962, OM646.963) C220 CDI , (M271.948) C230K , (M112.912) C240/240T , (OM642.910) C320 CDI , (M272.960) C350 (00-11), (W209) CLK320 (M112.940) 3.2 V6 Elegance, Cabrio (98-05)
 ID: 16, OD: 43/45, L: 69	AR6425 Front Lower Control Arm Bush - Inner C.A.M Inyathi (SF491QE) 2.2i Bus, P/van (2006-); Foton Inkunzi (BJ491EQ1) 2.2 Taxi, View (BJ491EQ1) 2.2 Taxi (07-09), Thunda (491EQ1) 2.2i Taxi, (493ZQ) 2.8D Taxi (2010-); Toyota HiAce (YH53) (4Y) 2.2 SWB LS, GLX, GLX Exec. Wagon, Super10, (YH63) (4Y) 2.2 LWB Super16, SuperT, P/van, Siyaya Pet. 5-Spd. Man., 4-Spd. Auto. (95-09), Quantum (2KD-FTV) 2.5D, "Family" Bus, 10/14 Seater MPV Dies., (2TR-FE) 2.7, "Family" Bus, 10/14/15 Seater, MPV, Ses' fikile Pet. (2005-)
 ID: 47/55	AR6426 Steering Rack Mounting - LHS Toyota HiAce (YH53) (4Y) 2.2 SWB LS, GLX, GLX Exec. Wagon, Super10, (YH63) (4Y) 2.2 LWB Super16, SuperT, P/van, Siyaya Pet. 5-Spd. Man., 4-Spd. Auto. (92-09)
	AR6427 Steering Rack Mounting - RHS Toyota HiAce (YH53) (4Y) 2.2 SWB LS, GLX, GLX Exec. Wagon, Super10, (YH63) (4Y) 2.2 LWB Super16, SuperT, P/van, Siyaya Pet. 5-Spd. Man., 4-Spd. Auto. (92-09)
 ID: 20, OD: 53.5, L: 60.3	AR6428 Steering Rack Mounting - RHS Toyota HiAce (YH53) (4Y) 2.2 SWB LS, GLX, GLX Exec. Wagon, Super10, (YH63) (4Y) 2.2 LWB Super16, SuperT, P/van, Siyaya Pet. 5-Spd. Man., 4-Spd. Auto. (86-09) - P/S
 ID: 26, L: 31, H: 49, W: 39	AR6430 Front Stabilizer Bar Bush Honda Ballade (SA4) (EN4) 1300 (84-89); Toyota HiAce (YH53) (4Y) 2.2 SWB LS, GLX, GLX Exec. Wagon, Super10, (YH63) (4Y) 2.2 LWB Super16, SuperT, P/van, Siyaya Pet. 5-Spd. Man., 4-Spd. Auto. (97-09)
	AR6431 Steering Rack Mounting - LHS Toyota Conquest (EE80) (2E-L) 1.3 L, GL 12V 4-Spd. Man. (85-88)
	AR6433 Engine Mounting - RHS Opel Astra F (18XE) 180i 18SE/XL iE OHC, (20SE) 200i, Estate, iE, (20XE) tS (93-99), Kadett (18SE) 180i, iE, (20SE) 200iS, (20XE) tS (93-99)
 ID: 18, OD: 39.5, L: 93	AR6435 Front Lower Control Arm Bush - Inner Toyota Hilux (LN140) (2L) 2.4 SWB DLX P/up Dies. (98-05), (LN145) 2.4 LWB P/up Dies. (98-05), (RZN147) (1RZ-E) 2.0 LWB SR D/cab Pet. 5-Spd. Man., (1RZ-E) 2.0 SWB SR, DLX, S, Pet. 5-Spd. Man. (98-05), (YN140) (2Y) 1.8 SWB, LWB D/cab, Raider Pet, 5-Spd. Man. (98-05)
	AR6440 Front Stabilizer Link Pin Kit Nissan 1400 (A14S) 1.4 SWB P/van, P/up Pet., B140 (A14S) 1.4 SWB Deluxe, Sport, Std., CHAMP P/up Pet. (80-93)

	AR6442 Front Stabilizer Bar Bush Toyota Cressida (RX70) (21R) 2.0 GL, GLX, GL S/W (87-92)
 ID: 18, OD: 38.5, L: 50	AR6450 Front Upper Control Arm Bush - Inner Front & Outer Rear Ford Ranger 1.8, XL SWB, LWB P/up Pet., 2.2, XL SWB, LWB P/up Pet., (WL4) 2.5D, TD High Trail, High Trail XL, XL D/cab, XLT Hi Trail, Super Cab XLT Hi Trail SWB, LWB P/up Dies., 4.0 V6 SubCab XLT Hi Trail, Super Cab XLT, XLE D/C, Hi Trail SWB, LWB P/up Pet. (99-10), Ranger 4X4 2.5D, TD V6 XL D/cab, XLT, SubCab, XLT Hi Trail, Super Cab XLT LWB P/up Dies., 4.0 V6 D/cab XLE, SubCab XLT Hi Trail, Super Cab XLT LWB P/up Pet. (00-10), Ranger 4X4 2.5D TD XL D/cab, XLT, SubCab, XLT Hi Trail, Super Cab XLT LWB P/up Dies., 3.0 TDCi D/cab XLE, SubCab XLT, Hi Trail, Super Cab XLT LWB P/up Dies. (07-12); Mazda B-Series B2600i LWB D/cab, Drifter SLX P/up Pet. (86-02), Drifter 1.8 SWB, LWB XL P/up Pet., 2.2 SWB, LWB XL, (WL4) 2.5TD LWB Hi Ride, S/cab, SL Hi Ride, SLE, SLX, D/cab, LX Hi Ride, P/up Dies., 2.6i LWB SL Hi Ride S/cab, SLE D/C, SLX, Hi Ride, SLX Hi Ride D/cab (00-08), Drifter 4X4 (WL4) 2.5TD LWB S/cab, Dcab, SL S/cab, SLE, SLE D/cab, SLX S/cab, SLX, D/cab P/up Dies., 2.6i V6 LWB S/cab, SL S/cab, SLE, D/Cab, SLX D/cab P/up Pet. (00-08)
	AR6451 Steering Coupling Toyota Hilux (YN67) (4Y) 2.2 LWB Raider D/cab, D/cab P/up Pet. (1985)
	AR6452 Steering Coupling Toyota Hilux (YN51) (2Y) 1.8 SWB S, SR, Raider P/up Pet., 5-Spd. Man. (91-98), (YN56) (2Y) 1.8 LWB P/up 4/5-Spd. Man. Pet. (91-98)
 ID: 20, OD: 53.5, L: 60.3	AR6455 Front Lower Control Arm Bush - Outer Rear Toyota Corolla (AE111) (4A-FE) 160i GL, GLE P/S DOHC, 5-Spd. Man., 4-Spd. Auto., (4A-GE) 160i RSi, RXi DOHC 5/6-Spd. Man. (96-99), (4A-FE) 160i GL, GLE DOHC, 5-Spd. Man., 4-Spd. Auto., (4A-GE) 160i Si, RXi, DOHC 5/6-Spd. Man. (99-02), (AE112) (7A-FE) 180i GLE, GSE DOHC, 5-Spd. Man., 4-Spd. Auto. (96-02), (EE110) (2E) 130 FWD GLE OHC 5-Spd. Man. (96-02)
 NO PICTURE AVAILABLE AT TIME OF PRINT	AR6460 Front Lower Control Arm Bush - Inner Land Rover Freelander I 4X4 (L314) (18K4F) 1.8 5-Spd. Man., (20T2N) 2.0TD 5-Spd. Man., (M47) 2.0 TD4 5-Spd. Man., (25K4F) 2.5 5-Spd. Auto. (98-06)
	AR6461 Front Lower Control Arm Bush - Outer Land Rover Freelander I 4X4 (L314) (18K4F) 1.8 5-Spd. Man., (20T2N) 2.0TD 5-Spd. Man., (M47) 2.0 TD4 5-Spd. Man., (25K4F) 2.5 5-Spd. Auto. (98-06)
 NO PICTURE AVAILABLE AT TIME OF PRINT	AR6462 Front Stabilizer Bar Bush Land Rover Freelander I 4X4 (L314) (18K4F) 1.8 5-Spd. Man., (20T2N) 2.0TD 5-Spd. Man., (M47) 2.0 TD4 5-Spd. Man., (25K4F) 2.5 5-Spd. Auto. (98-06)
	AR6463 Front Strut Mounting Land Rover Freelander I 4X4 (L314) (18K4F) 1.8 5-Spd. Man., (20T2N) 2.0TD 5-Spd. Man., (M47) 2.0 TD4 5-Spd. Man., (25K4F) 2.5 5-Spd. Auto. (98-06)
 NO PICTURE AVAILABLE AT TIME OF PRINT	AR6464 Rear Trailing Link Bush Land Rover Freelander I 4X4 (L314) (18K4F) 1.8 5-Spd. Man., (20T2N) 2.0TD 5-Spd. Man., (M47) 2.0 TD4 5-Spd. Man., (25K4F) 2.5 5-Spd. Auto. (98-06)

ENGINE MOUNTING & RUBBER BUYERS GUIDE

	AR6466 Rear Lower Link Bush - Inner Land Rover Freelander I 4X4 (L314) (18K4F) 1.8 5-Spd. Man., (20T2N) 2.0TD 5-Spd. Man., (M47) 2.0 TD4 5-Spd. Man., (25K4F) 2.5 5-Spd. Auto. (98-06)		AR6498 Front Strut Mounting (Excluding Bearing) Ford Bantam 'Boet' (CLTA) 1.3i XL, XLS SWB P/up Pet., (Zetec) 1.6i XLE, XLT, SWB P/up Pet., 1.8di XL SWB P/up Dies. (02-12), Fiesta I (Endura EM5) 1.3i Flair, Flite, Fun Play, (CVH, PTE) 1.4i Flair, Flite, Fun, (Rocam) 1.6i Flair, Forte, RSi, Sport (97-04), Ikon (CLTA) 1.3i LX, Low, (CLTA) 1.6i LX, CLX, High, Low (01-06), KA (A9A/B) 1.3i Low, LX, Ambiente, Trend, Collection (05-09); Mazda 121 Soho (Endura - EM5) 1.3, i Hatch, (CVH/PTE) 1.4, i Hatch (97-99)
	AR6467 Rear Lower Link Bush - Outer Land Rover Freelander I 4X4 (L314) (18K4F) 1.8 5-Spd. Man., (20T2N) 2.0TD 5-Spd. Man., (M47) 2.0 TD4 5-Spd. Man., (25K4F) 2.5 5-Spd. Auto. (98-06)	ID: 23, OD: 105, L: 50	
	AR6468 Rear Strut Mounting Land Rover Freelander I 4X4 (L314) (18K4F) 1.8 5-Spd. Man., (20T2N) 2.0TD 5-Spd. Man., (M47) 2.0 TD4 5-Spd. Man., (25K4F) 2.5 5-Spd. Auto. (98-06)		AR6498C Front Strut Mounting (with Bearing) Ford Bantam 'Boet' (CLTA) 1.3i XL, XLS SWB P/up Pet., (Zetec) 1.6i XLE, XLT, SWB P/up Pet., 1.8di XL SWB P/up Dies. (02-12), Fiesta I (Endura EM5) 1.3i Flair, Flite, Fun Play, (CVH, PTE) 1.4i Flair, Flite, Fun, (Rocam) 1.6i Flair, Forte, RSi, Sport (97-04), Ikon (CLTA) 1.3i LX, Low, (CLTA) 1.6i LX, CLX, High, Low (01-06), KA (A9A/B) 1.3i Low, LX, Ambiente, Trend, Collection (05-09); Mazda 121 Soho (Endura - EM5) 1.3, i Hatch, (CVH/PTE) 1.4, i Hatch (97-99)
	AR6472 Rear Wishbone Repair Kit - Inner Mercedes-Benz (W168) A-Class A160 (M166.940) 1.6 Classic, Elegance, A190 (M167.690) 1.9 Elegance (00-05)		AR6499 Exhaust Hanger - Middle, Rear Ford Fiesta I (Endura EM5) 1.3i Flair, Flite, Fun Play, (CVH, PTE) 1.4i Flair, Flite, Fun, (Rocam) 1.6i Flair, Forte, RSi, Sport (97-04); Mazda 121 Soho (Endura - EM5) 1.3, i Hatch, (CVH/PTE) 1.4, i Hatch (97-99)
	AR6476 Transmission Mounting Ford Bantam 'Boet' (CLTA) 1.3i XL, XLS SWB P/up Pet., (Zetec) 1.6i XLE, XLT, SWB P/up Pet., 1.8di XL SWB P/up Dies. (02-12), Fiesta I (Endura EM5) 1.3i Flair, Flite, Fun Play, (CVH, PTE) 1.4i Flair, Flite, Fun, (Rocam) 1.6i Flair, Forte, RSi, Sport (97-04), Ikon (CLTA) 1.3i LX, Low, (CLTA) 1.6i LX, CLX, High, Low (01-06); Mazda 121 Soho (Endura - EM5) 1.3, i Hatch, (CVH/PTE) 1.4, i Hatch (97-99)		AR6505 Centre Bearing Rubber Mercedes-Benz 200, 230E, 230S, 240D, 250, 280E, 300D (77-86), (C107) 450 SL, SLC (76-80)
	AR6480 Engine Mounting - Front RHS Ford Fiesta I (Endura EM5) 1.3i Flair, Flite, Fun Play, (CVH, PTE) 1.4i Flair, Flite, Fun (97-04); Mazda 121 Soho (Endura - EM5) 1.3, i Hatch, (CVH/PTE) 1.4, i Hatch (97-99)	ID: 30	
	AR6487 Engine Mounting - Rear Ford Bantam 'Boet' (CLTA) 1.3i XL, XLS SWB P/up Pet., (Zetec) 1.6i XLE, XLT, SWB P/up Pet., 1.8di XL SWB P/up Dies. (02-12), Fiesta I (Endura EM5) 1.3i Flair, Flite, Fun Play, (CVH, PTE) 1.4i Flair, Flite, Fun, (Rocam) 1.6i Flair, Forte, RSi, Sport (97-04), Ikon (CLTA) 1.3i LX, Low, (CLTA) 1.6i LX, CLX, High, Low (01-06); Mazda 121 Soho (Endura - EM5) 1.3, i Hatch, (CVH/PTE) 1.4, i Hatch (97-99)		AR6507 Rear Subframe Link Bush Mercedes-Benz (R170) SLK200 (M111.958) 2.0 Kompressor, SLK230 (M111.973, M111.978) 2.3 Kompressor (99-04), (W124) 200, E, E200 (M102.922) 2.0, 220E, E220 (M111.960) 2.2, 230E, E230 (M102.982) 2.3, (M103.940) 260E 2.6 6-Cyl., (M104.942) 280E 2.8 6-Cyl., 300D 3.0 5-Cyl., 300E 3.0 6-Cyl., 320E, E320 (M104.992) 3.2 6-Cyl., Sportline (86-96), (W201) 190E (M102.920) 1.8, (M102.922) 2.0, (M102.983) 2.3 Sportline (93-94), (W202) C-Class (M111.920/21) C180 1.8 Classic, (M111.941) C200 2.0 Classic, Elegance, C220 (M111.961) 2.2 Classic, Elegance, C230 (M111.974) 2.3 Classic, Elegance, Kompressor, Sport, C240 (M112.910) 2.4 Classic, Elegance, C250D, TD (M605.910) 2.5 5-Cyl., C280 (M104.941) 2.8 6-Cyl. Elegance (94-00), (W203) C-Class C180 (M111.920) 1.8 Classic, C200 (M271.940) 2.0 Classic, S/W, C220 (OM611.962, OM646.963) 2.2 CDI Classic, S/W, Elegance, C230 2.3 Coupe, C240 (M203.086) 2.6 V6 Elegance, S/W, Elegance S/W, C270 (OM612.962) 2.7 CDI 5-Cyl. Elegance, S/W, C320 (M111.946) 3.2 V6 Avantgarde Elegance, SW, (M271.946) C180K , (M271.940) C200K , (OM611.962, OM646.963) C220 CDI , (M271.948) C230K , (M112.912) C240/240T , (OM642.910) C320 CDI , (M272.960) C350 (00-11), (W208) CLK230 (M111.973/5) 2.3 Kompressor, CLK320 (M112.940) 3.2 V6 Cabrio (98-05), (W209) CLK320 (M112.940) 3.2 V6 Elegance, Cabrio (98-05), (W210) E-Class E200K (M111.957) 2.0, E230 (M111.970) 2.3, E240 (M112.911) 2.4, E280 (M112.921) 2.8 V6, E320 (M104.995, M112.941) 3.2 V6, E430 (M113.940) 4.3 V8 (96-02), (W220) S-Class S320 (M613.960) 3.2 CDI 6-Cyl., S500 (M113.960) 5.0 V8, S600L (M137.960) 5.5 V12 (99-04)
	AR6496 Front Lower Control Arm Bush - Outer Rear Ford Bantam 'Boet' (CLTA) 1.3i XL, XLS SWB P/up Pet., (Zetec) 1.6i XLE, XLT, SWB P/up Pet., 1.8di XL SWB P/up Dies. (02-12), Fiesta I (Endura EM5) 1.3i Flair, Flite, Fun Play, (CVH, PTE) 1.4i Flair, Flite, Fun, (Rocam) 1.6i Flair, Forte, RSi, Sport (97-04), Ikon (CLTA) 1.3i LX, Low, (CLTA) 1.6i LX, CLX, High, Low (01-06); Mazda 121 Soho (Endura - EM5) 1.3, i Hatch, (CVH/PTE) 1.4, i Hatch (97-99)		AR6508 Rear Stabilizer Link Assembly Mercedes-Benz (R170) SLK200 (M111.958) 2.0 Kompressor, SLK230 (M111.973, M111.978) 2.3 Kompressor (99-04), (W124) 200, E, E200 (M102.922) 2.0, 220E, E220 (M111.960) 2.2, 230E, E230 (M102.982) 2.3, (M103.940) 260E 2.6 6-Cyl., (M104.942) 280E 2.8 6-Cyl., 300D 3.0 5-Cyl., 300E 3.0 6-Cyl., 320E, E320 (M104.992) 3.2 6-Cyl., Sportline (86-96), (W201) 190E (M102.920) 1.8, (M102.922) 2.0, (M102.983) 2.3 Sportline (93-94), (W210) E-Class E200K (M111.957) 2.0, E230 (M111.970) 2.3, E240 (M112.911) 2.4, E280 (M112.921) 2.8 V6, E320 (M104.995, M112.941) 3.2 V6, E430 (M113.940) 4.3 V8 (96-02), (W220) S-Class S320 (M613.960) 3.2 CDI 6-Cyl., S500 (M113.960) 5.0 V8, S600L (M137.960) 5.5 V12 (99-04)
	AR6497 Front Stabilizer Bar Bush Ford Bantam 'Boet' (CLTA) 1.3i XL, XLS SWB P/up Pet., (Zetec) 1.6i XLE, XLT, SWB P/up Pet., 1.8di XL SWB P/up Dies. (02-12), Fiesta I (Endura EM5) 1.3i Flair, Flite, Fun Play, (CVH, PTE) 1.4i Flair, Flite, Fun, (Rocam) 1.6i Flair, Forte, RSi, Sport (97-04), Ikon (CLTA) 1.3i LX, Low, (CLTA) 1.6i LX, CLX, High, Low (01-06), KA (A9A/B) 1.3i Low, LX, Ambiente, Trend, Collection (05-09); Mazda 121 Soho (Endura - EM5) 1.3, i Hatch, (CVH/PTE) 1.4, i Hatch (97-99)	ID: 16, L: 23, H: 31, W: 40	

ENGINE MOUNTING & RUBBER BUYERS GUIDE

 ID: 23, L: 24, H: 45	AR6509 Front Stabilizer Bar Bush - Inner Mercedes-Benz (W202) C-Class (M111.920/21) C180 1.8 Classic, (M111.941) C200 2.0 Classic, Elegance (94-00), (W202) C-Class (M111.920/21) C180 1.8 Classic, (M111.941) C200 2.0 Classic, Elegance, C220 (M111.961) 2.2 Classic, Elegance, C230 (M111.974) 2.3 Classic, Elegance, Kompressor, Sport, C240 (M112.910) 2.4 Classic, Elegance, C250D , TD (M605.910) 2.5 5-Cyl., C280 (M104.941) 2.8 6-Cyl. Elegance (94-00)
 ID: 15, OD: 66, L: 29	AR6510 Rear Axle X-Member Diff. Bush Mercedes-Benz (W203) C-Class C180 (M111.920) 1.8 Classic, C200 (M271.940) 2.0 Classic, S/W, C220 (OM611.962, OM646.963) 2.2 CDi Classic, S/W, Elegance, C230 2.3 Coupe (00-08), (W210) E-Class E200K (M111.957) 2.0, E230 (M111.970) 2.3, E240 (M112.911) 2.4, E280 (M112.921) 2.8 V6, E320 (M104.995, M112.941) 3.2 V6, E430 (M113.940) 4.3 V8 (96-02)
	AR6511 Front Lower Control Arm Bush - Inner Front & Rear Repair Kit Mercedes-Benz (R170) SLK200 (M111.958) 2.0 Kompressor, SLK230 (M111.973, M111.978) 2.3 Kompressor (99-04), (W202) C-Class (M111.920/21) C180 1.8 Classic, (M111.941) C200 2.0 Classic, Elegance (94-00), (W202) C-Class (M111.920/21) C180 1.8 Classic, (M111.941) C200 2.0 Classic, Elegance, C220 (M111.961) 2.2 Classic, Elegance, C230 (M111.974) 2.3 Classic, Elegance, Kompressor, Sport, C240 (M112.910) 2.4 Classic, Elegance, C250D , TD (M605.910) 2.5 5-Cyl., C280 (M104.941) 2.8 6-Cyl. Elegance (94-00), (W208) CLK230 (M111.973/5) 2.3 Kompressor, CLK320 (M112.940) 3.2 V6 Cabrio (98-05), (W209) CLK320 (M112.940) 3.2 V6 Elegance, Cabrio (98-05)
 ID: 26.5, L: 38, H: 45	AR6512 Front Stabilizer Bar Bush - Inner Mercedes-Benz (W124) 200, E, E200 (M102.922) 2.0, 220E, E220 (M111.960) 2.2, 230E, E230 (M102.982) 2.3, (M103.940) 260E 2.6 6-Cyl., (M104.942) 280E 2.8 6-Cyl., 300D 3.0 5-Cyl., 300E 3.0 6-Cyl., 320E, E320 (M104.992) 3.2 6-Cyl., Sportline (86-96), (W202) C-Class (M111.920/21) C180 1.8 Classic, (M111.941) C200 2.0 Classic, Elegance (94-00), (W202) C-Class (M111.920/21) C180 1.8 Classic, (M111.941) C200 2.0 Classic, Elegance, C220 (M111.961) 2.2 Classic, Elegance, C230 (M111.974) 2.3 Classic, Elegance, Kompressor, Sport, C240 (M112.910) 2.4 Classic, Elegance, C250D , TD (M605.910) 2.5 5-Cyl., C280 (M104.941) 2.8 6-Cyl. Elegance (94-00)
 ID: 30	AR6513 Centre Bearing Rubber Mercedes-Benz (W126) 280S, SE (M110.987/89) 2.8 6-Cyl., 300SE (M103.981) 3.0 6-Cyl., 380SE (M116.963) 3.8 V8 (86-93)
	AR6514 Axle Subframe Bush Kit Mercedes-Benz (W126) 280S, SE (M110.987/89) 2.8 6-Cyl., 300SE (M103.981) 3.0 6-Cyl., 380SE (M116.963) 3.8 V8, 420SE (M116.965) 4.2 V8, 500SE (M117.965) 5.0 V8 (86-93)
	AR6516 Front Lower Control Arm Bush - Inner, Support Link Bush - Outer Mercedes-Benz (W126) 280S, SE (M110.987/89) 2.8 6-Cyl., 300SE (M103.981) 3.0 6-Cyl., 380SE (M116.963) 3.8 V8, 420SE (M116.965) 4.2 V8, 500SE (M117.965) 5.0 V8 (86-93)
	AR6517 Support Link Bush - Inner Mercedes-Benz (W126) 280S, SE (M110.987/89) 2.8 6-Cyl., 300SE (M103.981) 3.0 6-Cyl., 380SE (M116.963) 3.8 V8, 420SE (M116.965) 4.2 V8, 500SE (M117.965) 5.0 V8 (86-93)
 ID: 12, OD: 63.2, L: 70	AR6523 Rear Axle Carrier Bush Ford Bantam 'Boet' (CLTA) 1.3i XL, XLS SWB P/up Pet., (Zetec) 1.6i XLE, XLT, SWB P/up Pet., 1.8di XL SWB P/up Dies. (02-12), Fiesta I (Endura EM5) 1.3i Flair, Flite, Fun Play, (CVH, PTE) 1.4i Flair, Flite, Fun, (Rocam) 1.6i Flair, Forte, RSi, Sport (97-04), Ikon (CLTA) 1.3i LX, Low, (CLTA) 1.6i LX, CLX, High, Low (01-06); Mazda 121 Soho (Endura - EM5) 1.3, i Hatch, (CVH/PTE) 1.4, i Hatch (97-99)













 ID: 10, OD: 26, L: 55	AR6525 Front Lower Control Arm Bush - Inner Mazda 323 1.3, 1.4, 1.6 (79-81)
 ID: 15, OD: 30, L: 30	AR6528 Front Lower Control Arm Bush - Outer Mazda 323 1.3, 1.4, 1.6 (79-81)
	AR6529 Transmission Mounting Mazda Etude 160i, iE, iSE, iSE Sport, 180iSE, iSX, iSX Sport (99-04)
 ID: 43, L: 30, H: 50, W: 59	AR6530 Steering Rack Mounting - RHS Ford Bantam 1.3 SWB P/up Kent 2V Pet., (CVH) 1.6 Leisure SWB P/up Pet. (83-86), (CVH, FUA) 1.4 Leisure SWB P/up Pet., (CVH) 1.6 Leisure, Nite SWB P/up Pet. (86-94), (B3) 1.3 130 Explorer SWB P/up Pet., (F6) 160i, Explorer, Leisure, Sport SWB P/up Pet. (94-03), Laser (B3, E3) 1.3 Dash, GL, L, Tracer H/B, Sedan, Tonic (91-95), (CHV-FUA) 1.4 L, (E5) 1.5 GL, GLS, Sport (91-92), (B6, F6, CVH) 1.6 i, 16, GL, Sport, Tracer H/B, Sedan, Plus, TX3 (86-91), (FE) 2.0i RS (91-94), Meteor (B3, E3) 1.3 GL, L (91-95), (CVH) 1.4 LX, (E5) 1.5 GL, GLS (91-92), (B6, F6, CVH) 1.6 16, GL, GLE, GLi, Sport (86-91), (FE) 2.0 GLE, GLi (91-94), Tracer (B3, E3) 1.3 H/B, Sedan, Tonic, Plus (95-02), (B6, F6) 1.6i 16, Sedan, Hatchback, Plus, Sport, Tonic (95-02), Spectron (F2) 2.2 LWB Bus, P/van Pet. (91-04); Mazda Marathon (F2) 2.2 LWB Bus, P/van Pet. (91-04), Rustler (B3) 130 SWB Drifter, Explorer P/up Pet., (B6i, F6) 160, i SWB Explorer, Drifter P/up Pet., 1.3 SWB P/up Kent 2V Pet., (CVH, FUA) 1.4 SWB P/up, (CVH, LUC) 1.6 LX (86-02)
 ID: 43, L: 31, H: 50, W: 54	AR6531 Steering Rack Mounting - LHS Ford Bantam (CVH, FUA) 1.4 Leisure SWB P/up Pet., (CVH) 1.6 Leisure, Nite SWB P/up Pet. (86-94), (B3) 1.3 130 Explorer SWB P/up Pet., (F6) 160i, Explorer, Leisure, Sport SWB P/up Pet. (94-03), Laser (B3, E3) 1.3 Dash, GL, L, Tracer H/B, Sedan, Tonic (91-95), (CHV-FUA) 1.4 L, (E5) 1.5 GL, GLS, Sport (91-92), (B6, F6, CVH) 1.6 i, 16, GL, Sport, Tracer H/B, Sedan, Plus, TX3 (86-91), (FE) 2.0i RS (91-94), Meteor (B3, E3) 1.3 GL, L (91-95), (CVH) 1.4 LX, (E5) 1.5 GL, GLS (91-92), (B6, F6, CVH) 1.6 16, GL, GLE, GLi, Sport (86-91), (FE) 2.0 GLE, GLi (91-94), Tracer (B3, E3) 1.3 H/B, Sedan, Tonic, Plus (95-02), (B6, F6) 1.6i 16, Sedan, Hatchback, Plus, Sport, Tonic (95-02), Spectron (F2) 2.2 LWB Bus, P/van Pet. (91-04); Mazda Marathon (F2) 2.2 LWB Bus, P/van Pet. (91-04), Rustler (B3) 130 SWB Drifter, Explorer P/up Pet., (B6i, F6) 160, i SWB Explorer, Drifter P/up Pet., 1.3 SWB P/up Kent 2V Pet., (CVH, FUA) 1.4 SWB P/up, (CVH, LUC) 1.6 LX (86-02)
	AR6532 Front Strut Mounting Ford Laser (B3, E3) 1.3 Dash, GL, L, Tracer H/B, Sedan, Tonic (86-95), (CHV-FUA) 1.4 L, (E5) 1.5 GL, GLS, Sport (86-92), (B6, F6, CVH) 1.6 i, 16, GL, Sport, Tracer H/B, Sedan, Plus, TX3 (86-91), Meteor (B3, E3) 1.3 GL, L (86-95), (CVH) 1.4 LX, (E5) 1.5 GL, GLS (86-92), (B6, F6, CVH) 1.6 16, GL, GLE, GLi, Sport (86-91), Tracer (B3, E3) 1.3 H/B, Sedan, Tonic, Plus (95-02); Mazda 323 FWD (E3) 1.3 S, L H/back, Sedan, (E/B3) 130 Hatch, Midge, Sting, Sedan, (E5) 1.5 GLC, L, SL, SLX, Sport Sedan, Hatchback (84-91), (B3) 130 Hatch, Sedan (85-91), Midge / Sting (F6) 160 i, s, Hatch, Sedan, (B6) 1.6 EG i, S, SL Hatch, Sedan, Sport, (F6) 160, i, s, Hatch, Midge, Sting, Sedan, 2.0 EG i Hatch, SLE Hatch, SLi, Sedan, (FE-2000) 200e, i Sedan, Hatch DOHC 8/16 Valve (85-91)

ENGINE MOUNTING & RUBBER BUYERS GUIDE





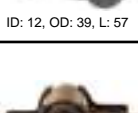









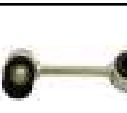







 <p>ID: 11/15</p>	<p>AR6533 Rear Strut Mounting</p> <p>Ford Laser (B3, E3) 1.3 Dash, GL, L, Tracer H/B, Sedan, Tonic (86-95), (CHV-FUA) 1.4 L, (E5) 1.5 GL, GLS, Sport (86-92), (B6, F6, CVH) 1.6 i, 16, GL, Sport, Tracer H/B, Sedan, Plus, TX3 (86-91), (FE) 2.0i RS (91-94), Meteor (B3, E3) 1.3 GL, L (86-95), (CVH) 1.4 LX, (E5) 1.5 GL, GLS (86-92), (B6, F6, CVH) 1.6 16, GL, GLE, GLi, Sport (86-91), (FE) 2.0 GLE, GLi (91-94), Tracer (B3, E3) 1.3 H/B, Sedan, Tonic, Plus (95-02), (B6, F6) 1.6i 16, Sedan, Hatchback, Plus, Sport, Tonic (95-02); Mazda 323 FWD (E3) 1.3 S, L H/back, Sedan, (E/B3) 130 Hatch, Midge, Sting, Sedan, (E5) 1.5 GLC, L, SL, SLX, Sport Sedan, Hatchback (81-95), (B3) 130 Hatch, Sedan (85-05), Midge / Sting (F6) 160 i, s, Hatch, Sedan, (B6) 1.6 EGi, S, SL Hatch, Sedan, Sport, (F6) 160, i, iS, Hatch, Midge, Sting, Sedan, 2.0 EGi Hatch, SLE Hatch, SLi, Sedan, (FE-2000) 200e, i Sedan, Hatch DOHC 8/16 Valve (85-05)</p>		<p>AR6543 Engine Mounting - LHS</p> <p>Ford Telstar (FS) 2.0 4-Cyl. Man. GL, GLE, (KF) 2.0 V6 GLi, Mystique, (KL) 2.5i Man. V6 Ghia, GLi, (KL) TX5 2.5 Man. V6 RSi (92-99); Mazda 626 (FS) 2.0i 4-Cyl. Man. 16V Medium, High, (KF) 2.0i Man. V6 24V High, (FS2B/-D) 2.0i Man. S/W, Sedan, (KL) 2.5i Man. V6 Exec. (93-03), MX6 (KL) 2.5 Man. V6 (93-03)</p>
	<p>AR6536 Engine Mounting - LHS</p> <p>Mazda Etude 160i, iE, iSE, iSE Sport, 180iSE, iSX, iSX Sport (99-04)</p>		<p>AR6544 Engine Mounting - LHS</p> <p>Ford Telstar (FS) 2.0 4-Cyl. Auto. GL, GLE, (KF) 2.0 Auto. V6 GLi, Mystique, (KL) 2.5i Auto. V6 Ghia, GLi, (KL) TX5 2.5 Auto. V6 RSi (92-99); Mazda 626 (FS) 2.0i 4-Cyl. Auto. 16V Medium, High, (KF) 2.0i Auto. V6 24V High, (FS2B/-D) 2.0i Auto. S/W, Sedan, (KL) 2.5i Auto. V6 Exec. (93-03), MX6 (KL) 2.5 Auto. V6 (93-03)</p>
 <p>NO PICTURE AVAILABLE AT TIME OF PRINT</p>	<p>AR6538 Accelerator Pedal Rubber</p> <p>Ford Laser (B3, E3) 1.3 Dash, GL, L, Tracer H/B, Sedan, Tonic (86-95), (CHV-FUA) 1.4 L, (E5) 1.5 GL, GLS, Sport (86-92), (B6, F6, CVH) 1.6 i, 16, GL, Sport, Tracer H/B, Sedan, Plus, TX3 (86-91), (FE) 2.0i RS (91-94), Meteor (B3, E3) 1.3 GL, L (86-95), (CVH) 1.4 LX, (E5) 1.5 GL, GLS (86-92), (B6, F6, CVH) 1.6 16, GL, GLE, GLi, Sport (86-91), (FE) 2.0 GLE, GLi (91-94), Tracer (B3, E3) 1.3 H/B, Sedan, Tonic, Plus (95-02), (B6, F6) 1.6i 16, Sedan, Hatchback, Plus, Sport, Tonic (95-02); Mazda 323 FWD (E3) 1.3 S, L H/back, Sedan, (E/B3) 130 Hatch, Midge, Sting, Sedan, (E5) 1.5 GLC, L, SL, SLX, Sport Sedan, Hatchback (81-95), (B3) 130 Hatch, Sedan (85-05), Midge / Sting (F6) 160 i, s, Hatch, Sedan, (B6) 1.6 EGi, S, SL Hatch, Sedan, Sport, (F6) 160, i, iS, Hatch, Midge, Sting, Sedan, 2.0 EGi Hatch, SLE Hatch, SLi, Sedan, (FE-2000) 200e, i Sedan, Hatch DOHC 8/16 Valve (85-05)</p>		<p>AR6545 Engine Mounting - RHS</p> <p>Ford Telstar (FS) 2.0 4-Cyl. GL, GLE, (KF) 2.0 V6 GLi, Mystique, (KL) 2.5i V6 Ghia, GLi, (KL) TX5 2.5 V6 RSi (92-99); Kia Carnival (KRVT) 2.5 V6 LS MPV, (J3) 2.9 CRDi MPV (00-04); Mazda 626 (FS) 2.0i 4-Cyl. 16V Medium, High, (KF) 2.0i V6 24V High, (FS2B/-D) 2.0i S/W, Sedan, (KL) 2.5i V6 Exec. (93-03), MX6 (KL) 2.5 V6 (93-03)</p>
	<p>AR6539 Brake & Clutch Pedal Rubber</p> <p>Ford Laser (B3, E3) 1.3 Dash, GL, L, Tracer H/B, Sedan, Tonic (86-95), (CHV-FUA) 1.4 L, (E5) 1.5 GL, GLS, Sport (86-92), (B6, F6, CVH) 1.6 i, 16, GL, Sport, Tracer H/B, Sedan, Plus, TX3 (86-91), (FE) 2.0i RS (91-94), Meteor (B3, E3) 1.3 GL, L (86-95), (CVH) 1.4 LX, (E5) 1.5 GL, GLS (86-92), (B6, F6, CVH) 1.6 16, GL, GLE, GLi, Sport (86-91), (FE) 2.0 GLE, GLi (91-94), Tracer (B3, E3) 1.3 H/B, Sedan, Tonic, Plus (95-02), (B6, F6) 1.6i 16, Sedan, Hatchback, Plus, Sport, Tonic (95-02); Mazda 323 FWD (E3) 1.3 S, L H/back, Sedan, (E/B3) 130 Hatch, Midge, Sting, Sedan, (E5) 1.5 GLC, L, SL, SLX, Sport Sedan, Hatchback (81-95), (B3) 130 Hatch, Sedan (85-05), Midge / Sting (F6) 160 i, s, Hatch, Sedan, (B6) 1.6 EGi, S, SL Hatch, Sedan, Sport, (F6) 160, i, iS, Hatch, Midge, Sting, Sedan, 2.0 EGi Hatch, SLE Hatch, SLi, Sedan, (FE-2000) 200e, i Sedan, Hatch DOHC 8/16 Valve (85-05)</p>		<p>AR6546 X-Member Mounting</p> <p>Ford Telstar (FS) 2.0 4-Cyl. Man. GL, GLE, (KF) 2.0 Man. V6 GLi, Mystique, (KL) 2.5i Man. V6 Ghia, GLi, (KL) TX5 2.5 Man. V6 RSi (92-99); Mazda 626 (FS) 2.0i 4-Cyl. Man. 16V Medium, High, (KF) 2.0i Man. V6 24V High, (FS2B/-D) 2.0i Man. S/W, Sedan, (KL) 2.5i Man. V6 Exec. (93-03), MX6 (KL) 2.5 Man. V6 (93-03)</p>
	<p>AR6540 Engine Mounting - RHS</p> <p>Mazda Etude 160i, iE, iSE, iSE Sport (99-00)</p>		<p>AR6547 X-Member Mounting</p> <p>Ford Telstar (FS) 2.0 4-Cyl. Auto. GL, GLE, (KF) 2.0 Auto. V6 GLi, Mystique, (KL) 2.5i Auto. V6 Ghia, GLi, (KL) TX5 2.5 Auto. V6 RSi (92-99); Mazda 626 (FS) 2.0i 4-Cyl. Auto. 16V Medium, High, (KF) 2.0i Auto. V6 24V High, (FS2B/-D) 2.0i Auto. S/W, Sedan, (KL) 2.5i Auto. V6 Exec. (93-03), MX6 (KL) 2.5 Auto. V6 (93-03)</p>
	<p>AR6541 Engine Mounting - Rear</p> <p>Ford Telstar (FS) 2.0 4-Cyl. Man., (KF) 2.0 V6 GLi, Mystique, Man. (92-99); Mazda 626 (FS2B/-D) 2.0i Man. S/W, Sedan (93-03)</p>		<p>AR6548 Damper Dynamic</p> <p>Ford Telstar (FS) 2.0 4-Cyl. (92-99); Mazda 626 (FS) 2.0i 4-Cyl. 16V Medium, High (93-03)</p>
	<p>AR6542 Engine Mounting - Rear</p> <p>Ford Telstar (FS) 2.0 4-Cyl. Auto., (KF) 2.0 V6 GLi, Mystique, Auto. (92-99); Mazda 626 (FS) 2.0i Auto. 4-Cyl. 16V Medium, High, (KF) Auto. 2.0i V6 24V High, (FS2B/-D) 2.0i Auto. S/W, Sedan (93-03)</p>		<p>AR6549 Engine Mounting - RHS</p> <p>Mazda Etude 160i, iE, iSE, iSE Sport (00-04)</p>
	<p>AR6540 Engine Mounting - RHS</p> <p>Mazda Etude 160i, iE, iSE, iSE Sport (99-00)</p>		<p>AR6550 Transmission Mounting</p> <p>Ford Telstar (FS) 2.0 4-Cyl. GL, GLE, (KF) 2.0 V6 GLi, Mystique, (KL) 2.5i V6 Ghia, GLi, (KL) TX5 2.5 V6 RSi (92-99); Mazda 626 (FS) 2.0i 4-Cyl. 16V Medium, High, (KF) 2.0i V6 24V High, (FS2B/-D) 2.0i S/W, Sedan, (KL) 2.5i V6 Exec. (93-03), MX6 (KL) 2.5 V6 (93-03)</p>
	<p>AR6541 Engine Mounting - Rear</p> <p>Ford Telstar (FS) 2.0 4-Cyl. Man., (KF) 2.0 V6 GLi, Mystique, Man. (92-99); Mazda 626 (FS2B/-D) 2.0i Man. S/W, Sedan (93-03)</p>		<p>AR6551 Engine Mounting - Rear</p> <p>Mazda Etude 160i, iE, iSE, iSE Sport (99-04)</p>
	<p>AR6542 Engine Mounting - Rear</p> <p>Ford Telstar (FS) 2.0 4-Cyl. Auto., (KF) 2.0 V6 GLi, Mystique, Auto. (92-99); Mazda 626 (FS) 2.0i Auto. 4-Cyl. 16V Medium, High, (KF) Auto. 2.0i V6 24V High, (FS2B/-D) 2.0i Auto. S/W, Sedan (93-03)</p>	 <p>ID: 12, OD: 34, L: 59</p>	<p>AR6552 Front Lower Control Arm Bush - Outer Rear</p> <p>Mazda 626 (F6) 1.6 L Hatch, Sedan, S Sedan, SL Hatch Man., (F8) 1.8 L Hatch, Sedan Man. (83-93)</p>
	<p>AR6542 Engine Mounting - Rear</p> <p>Ford Telstar (FS) 2.0 4-Cyl. Auto., (KF) 2.0 V6 GLi, Mystique, Auto. (92-99); Mazda 626 (FS) 2.0i Auto. 4-Cyl. 16V Medium, High, (KF) Auto. 2.0i V6 24V High, (FS2B/-D) 2.0i Auto. S/W, Sedan (93-03)</p>		<p>AR6553 Engine Mounting - Rear</p> <p>Ford Telstar (KF) 2.0 Auto. V6 GLi, Mystique, (KL) 2.5i Auto. V6 Ghia, GLi (92-99); Mazda 626 (FS) 2.0i 4-Cyl. Auto. 16V Medium, High, (KF) 2.0i Auto. V6 24V High, (FS2B/-D) 2.0i Auto. S/W, Sedan, (KL) 2.5i Auto. V6 Exec. (93-03), MX6 (KL) 2.5 Auto. V6 (93-03)</p>

ENGINE MOUNTING & RUBBER BUYERS GUIDE

	AR6554 Engine Mounting - Rear Ford Telstar (KF) 2.0 Auto. V6 GLi, Mystique, (KL) 2.5i Auto. V6 Ghia, GLi (92-99); Mazda 626 (FS) 2.0i 4-Cyl. Auto. 16V Medium, High, (KF) 2.0i Auto. V6 24V High, (FS2B/-D) 2.0i Auto. S/W, Sedan, (KL) 2.5i Auto. V6 Exec. (93-03), MX6 (KL) 2.5 Auto. V6 (93-03)
 ID: 22, L: 24, H: 39.5, W: 43	AR6555 Front Stabilizer Bar Bush Ford Telstar (FS) 2.0 4-Cyl. GL, GLE, (KF) 2.0 V6 GLi, Mystique, (KL) 2.5i V6 Ghia, GLi, (KL) TX5 2.5 V6 RSi (92-99)
 ID: 18, OD: 61, L: 71	AR6556 Front Lower Control Arm Bush - Outer Rear RHS Ford Telstar (FS) 2.0 4-Cyl. GL, GLE, (KF) 2.0 V6 GLi, Mystique, (KL) 2.5i V6 Ghia, GLi, (KL) TX5 2.5 V6 RSi (92-99); Mazda 626 (FS) 2.0i 4-Cyl. 16V Medium, High, (KF) 2.0i V6 24V High, (FS2B/-D) 2.0i S/W, Sedan, (KL) 2.5i V6 Exec. (93-03), MX6 (KL) 2.5 V6 (93-03)
 ID: 18, OD: 61, L: 71	AR6557 Front Lower Control Arm Bush - Outer Rear LHS Ford Telstar (FS) 2.0 4-Cyl. GL, GLE, (KF) 2.0 V6 GLi, Mystique, (KL) 2.5i V6 Ghia, GLi, (KL) TX5 2.5 V6 RSi (92-99); Mazda 626 (FS) 2.0i 4-Cyl. 16V Medium, High, (KF) 2.0i V6 24V High, (FS2B/-D) 2.0i S/W, Sedan, (KL) 2.5i V6 Exec. (93-03), MX6 (KL) 2.5 V6 (93-03)
 ID: 12, OD: 41, L: 61	AR6558 Front Lower Control Arm Bush - Inner Front Ford Telstar (FS) 2.0 4-Cyl. GL, GLE, (KF) 2.0 V6 GLi, Mystique, (KL) 2.5i V6 Ghia, GLi, (KL) TX5 2.5 V6 RSi (92-99); Mazda 626 (FS) 2.0i 4-Cyl. 16V Medium, High, (KF) 2.0i V6 24V High, (FS2B/-D) 2.0i S/W, Sedan, (KL) 2.5i V6 Exec. (93-03), MX6 (KL) 2.5 V6 (93-03)
 ID: 12, L: 24, H: 28, W: 35	AR6560 Rear Stabilizer Bar Bush Ford Telstar (FS) 2.0 4-Cyl. GL, GLE, (KF) 2.0 V6 GLi, Mystique, (KL) 2.5i V6 Ghia, GLi, (KL) TX5 2.5 V6 RSi (92-99); Mazda 626 (FS) 2.0i 4-Cyl. 16V Medium, High, (KF) 2.0i V6 24V High, (FS2B/-D) 2.0i S/W, Sedan, (KL) 2.5i V6 Exec. (93-03), MX6 (KL) 2.5 V6 (93-03)
	AR6561 Rear Trailing Link - L/RHS Ford Telstar (FS) 2.0 4-Cyl. GL, GLE, (KF) 2.0 V6 GLi, Mystique, (KL) 2.5i V6 Ghia, GLi, (KL) TX5 2.5 V6 RSi (92-99); Mazda 626 (FS) 2.0i 4-Cyl. 16V Medium, High, (KF) 2.0i V6 24V High, (FS2B/-D) 2.0i S/W, Sedan, (KL) 2.5i V6 Exec. (93-03), MX6 (KL) 2.5 V6 (93-03)
	AR6562 Rear Lateral Link - RHS Ford Telstar (FS) 2.0 4-Cyl. GL, GLE, (KF) 2.0 V6 GLi, Mystique, (KL) 2.5i V6 Ghia, GLi, (KL) TX5 2.5 V6 RSi (92-99); Mazda 626 (FS) 2.0i 4-Cyl. 16V Medium, High, (KF) 2.0i V6 24V High, (FS2B/-D) 2.0i S/W, Sedan, (KL) 2.5i V6 Exec. (93-03), MX6 (KL) 2.5 V6 (93-03)
	AR6563 Rear Lateral Link - LHS Ford Telstar (FS) 2.0 4-Cyl. GL, GLE, (KF) 2.0 V6 GLi, Mystique, (KL) 2.5i V6 Ghia, GLi, (KL) TX5 2.5 V6 RSi (92-99); Mazda 626 (FS) 2.0i 4-Cyl. 16V Medium, High, (KF) 2.0i V6 24V High, (FS2B/-D) 2.0i S/W, Sedan, (KL) 2.5i V6 Exec. (93-03), MX6 (KL) 2.5 V6 (93-03)
 ID: 18, OD: 52, L: 64	AR6564 Rear Lateral Link - RHS Ford Telstar (FS) 2.0 4-Cyl. GL, GLE, (KF) 2.0 V6 GLi, Mystique, (KL) 2.5i V6 Ghia, GLi, (KL) TX5 2.5 V6 RSi (92-99); Mazda 626 (FS) 2.0i 4-Cyl. 16V Medium, High, (KF) 2.0i V6 24V High, (FS2B/-D) 2.0i S/W, Sedan, (KL) 2.5i V6 Exec. (93-03), MX6 (KL) 2.5 V6 (93-03)
 ID: 18, OD: 52, L: 64	AR6565 Rear Lateral Link - LHS Ford Telstar (FS) 2.0 4-Cyl. GL, GLE, (KF) 2.0 V6 GLi, Mystique, (KL) 2.5i V6 Ghia, GLi, (KL) TX5 2.5 V6 RSi (92-99); Mazda 626 (FS) 2.0i 4-Cyl. 16V Medium, High, (KF) 2.0i V6 24V High, (FS2B/-D) 2.0i S/W, Sedan, (KL) 2.5i V6 Exec. (93-03), MX6 (KL) 2.5 V6 (93-03)

 NO PICTURE AVAILABLE AT TIME OF PRINT	AR6566 Steering Coupling Ford Telstar (FS) 2.0 4-Cyl. GL, GLE, (KF) 2.0 V6 GLi, Mystique, (KL) 2.5i V6 Ghia, GLi, (KL) TX5 2.5 V6 RSi (92-99); Mazda 626 (FS) 2.0i 4-Cyl. 16V Medium, High, (KF) 2.0i V6 24V High, (KL) 2.5i V6 Exec. (93-03), MX6 (KL) 2.5 V6 (93-03)
	AR6568 Lateral Link Bush Daewoo Nubira I (616L, A16DM) 1.6 SX, (C20SED, X20S) 2.0 CDX (97-03)
	AR6569 Lateral Link Bush Daewoo Nubira I (616L, A16DM) 1.6 SX, (C20SED, X20S) 2.0 CDX (97-03)
	AR6570 Front Strut Mounting Mazda 626 (F6) 1.6 L Hatch, Sedan, S Sedan, SL Hatch Man., (F8) 1.8 L Hatch, Sedan Man., (FE) 2.0 SL Hatch, EGi, Sedan, SLi 16 Valve, SLE, 12 Valve, SLX Sedan, Hatch (83-93)
	AR6571 Front Strut Mounting Mazda 626 (F8) 1.8 L Hatch, Sedan Man., (FE) 2.0 SL Hatch, EGi, Sedan, SLi 16 Valve, SLE, 12 Valve, SLX Sedan, Hatch Auto. (83-93)
	AR6574 Rear Strut Mounting - LHS Ford Telstar (FS) 2.0 4-Cyl. (92-99); Mazda 626 (FS) 2.0i 4-Cyl. (93-03)
	AR6575 Rear Strut Mounting - RHS Ford Telstar (FS) 2.0 4-Cyl. (92-99); Mazda 626 (FS) 2.0i 4-Cyl. (93-03)
	AR6578 Engine Mounting - RHS Mazda Astina (BPI) 180Se Sedan, Hatch (95-00), Etude (B6i) 160, e, i, ie, Ise, Sport 16V, (BPI) 180e, iSe, Se, Sedan (95-00)
	AR6580 Engine Mounting - LHS Mazda Etude (B6i) 160, e, i, ie, Ise, Sport 16V (95-00)
 ID: 12, OD: 39, L: 57	AR6582 Front Lower Control Arm Bush - Inner Front Mazda Astina (BPI) 180Se Sedan, Hatch (95-00), Etude (B6i) 160, e, i, ie, Ise, Sport 16V, (BPI) 180e, iSe, Se, Sedan (95-00)
 ID: 18, OD: 52, L: 64	AR6583 Front Lower Control Arm Bush - Outer Rear RHS Mazda Astina (BPI) 180Se Sedan, Hatch (95-00), Etude (B6i) 160, e, i, ie, Ise, Sport 16V, (BPI) 180e, iSe, Se, Sedan (95-00)
 ID: 18, OD: 52, L: 64	AR6584 Front Lower Control Arm Bush - Outer Rear LHS Mazda Astina (BPI) 180Se Sedan, Hatch (95-00), Etude (B6i) 160, e, i, ie, Ise, Sport 16V, (BPI) 180e, iSe, Se, Sedan (95-00)

ENGINE MOUNTING & RUBBER BUYERS GUIDE

 ID: 23, L: 25, H: 35, W: 36	AR6586 Front Stabilizer Bar Bush Mazda Astina (BPi) 180Se Sedan, Hatch (95-00), Etude (B6i) 160, e, i, ie, Ise, Sport 16V, (BPi) 180e, iSe, Se, Sedan (95-00)	 ID: 12.3, OD: 30.8, L: 61	AR6603 Front Lower Control Arm Bush - Inner Front Mazda Etude 160i, iE, iSE, iSE Sport, 180iSE, iSX, iSX Sport (99-02)
	AR6587 Front Stabilizer Link Grommet Mazda Astina (BPi) 180Se Sedan, Hatch (95-00), Etude (B6i) 160, e, i, ie, Ise, Sport 16V, (BPi) 180e, iSe, Se, Sedan (95-00)	 ID: 12.3, OD: 30.8, L: 61	AR6604 Front Lower Control Arm Bush - Inner Front Mazda Etude 160i, iE, iSE, iSE Sport, 180iSE, iSX, iSX Sport (02-04)
 ID: 50, L: 34.5, H: 57, W: 60	AR6588 Steering Rack Mounting - LHS Mazda Astina (BPi) 180Se Sedan, Hatch (95-00), Etude (B6i) 160, e, i, ie, Ise, Sport 16V, (BPi) 180e, iSe, Se, Sedan (95-00)	 ID: 12.4/18, L: 115	AR6605 Front Stabilizer Link Assy. - RHS Mercedes-Benz (W210) E-Class E200K (M111.957) 2.0, E230 (M111.970) 2.3, E240 (M112.911) 2.4, E280 (M112.921) 2.8 V6, E320 (M104.995, M112.941) 3.2 V6, E430 (M113.940) 4.3 V8 (96-02)
 ID: 11	AR6590 Front Strut Mounting Mazda 626 (FS2B/-D) 2.0i S/W, Sedan (93-03), Astina (BPi) 180Se Sedan, Hatch (95-00), Etude (B6i) 160, e, i, ie, Ise, Sport 16V, (BPi) 180e, iSe, Se, Sedan (95-00)	 ID: 12.4/18, L: 115	AR6606 Front Stabilizer Link Assy. - LHS Mercedes-Benz (W210) E-Class E200K (M111.957) 2.0, E230 (M111.970) 2.3, E240 (M112.911) 2.4, E280 (M112.921) 2.8 V6, E320 (M104.995, M112.941) 3.2 V6, E430 (M113.940) 4.3 V8 (96-02)
 ID: 12/14, L: 632	AR6595 Front Lateral Link - L/RHS Mazda Astina (BPi) 180Se Sedan, Hatch (95-00), Etude (B6i) 160, e, i, ie, Ise, Sport 16V, (BPi) 180e, iSe, Se, Sedan (95-00)	 ID: 16, OD: 48, L: 48.5	AR6607 Front Lower Control Arm Bush - Outer Rear Mazda Etude 160i, iE, iSE, iSE Sport, 180iSE, iSX, iSX Sport (99-04)
	AR6596 Front Lateral Link - L/RHS Mazda 626 (FS2B/-D) 2.0i S/W, Sedan (93-03), Astina (BPi) 180Se Sedan, Hatch (95-00), Etude (B6i) 160, e, i, ie, Ise, Sport 16V, (BPi) 180e, iSe, Se, Sedan (95-00)	 ID: 20, L: 34, H: 36, W: 69	AR6608 Front Stabilizer Bar Bush Mazda Etude 160i, iE, iSE, iSE Sport, 180iSE, iSX, iSX Sport (99-04)
 ID: 12/14, L: 658	AR6597 Rear Lateral Link - L/RHS Mazda Astina (BPi) 180Se Sedan, Hatch (95-00), Etude (B6i) 160, e, i, ie, Ise, Sport 16V, (BPi) 180e, iSe, Se, Sedan (95-00)	 NO PICTURE AVAILABLE AT TIME OF PRINT	AR6609 Steering Rack Mounting Mazda Etude 160i, iE, iSE, iSE Sport, 180iSE, iSX, iSX Sport (99-04)
 ID: 12/14, L: 658	AR6598 Rear Lateral Link - L/RHS Mazda 626 (FS2B/-D) 2.0i S/W, Sedan (93-03), Astina (BPi) 180Se Sedan, Hatch (95-00), Etude (B6i) 160, e, i, ie, Ise, Sport 16V, (BPi) 180e, iSe, Se, Sedan (95-00)		AR6610 Steering Rack Mounting Mazda Etude 160i, iE, iSE, iSE Sport, 180iSE, iSX, iSX Sport (99-04)
 ID: 12, L: 636	AR6599 Rear Trailing Link Mazda Astina (BPi) 180Se Sedan, Hatch (95-00), Etude (B6i) 160, e, i, ie, Ise, Sport 16V, (BPi) 180e, iSe, Se, Sedan (95-00)		AR6611 Front Strut Mounting Mazda Etude 160i, iE, iSE, iSE Sport, 180iSE, iSX, iSX Sport (99-04)
 ID: 12, L: 642	AR6600 Rear Trailing Link - RHS Mazda 626 (FS2B/-D) 2.0i S/W, Sedan (93-03), Astina (BPi) 180Se Sedan, Hatch (95-00), Etude (B6i) 160, e, i, ie, Ise, Sport 16V, (BPi) 180e, iSe, Se, Sedan (95-00)		AR6614L Front Lower Control Arm Bush - Outer Rear LHS Mazda 626 (FS2B/-D) 2.0i S/W, Sedan (93-03)
 ID: 12.2, L: 641	AR6601 Rear Trailing Link - LHS Mazda 626 (FS2B/-D) 2.0i S/W, Sedan (93-03), Astina (BPi) 180Se Sedan, Hatch (95-00), Etude (B6i) 160, e, i, ie, Ise, Sport 16V, (BPi) 180e, iSe, Se, Sedan (95-00)		AR6615R Front Lower Control Arm Bush - Outer Rear RHS Mazda 626 (FS2B/-D) 2.0i S/W, Sedan (93-03)
 ID: 55, OD: 91, L: 45	AR6602 Front Strut Mounting Ford Bantam (CVH, FUA) 1.4 Leisure SWB P/up Pet., (CVH) 1.6 Leisure, Nite SWB P/up Pet. (86-94), Rustler 1.3 SWB P/up Kent 2V Pet., (CVH, FUA) 1.4 SWB P/up, (CVH, LUC) 1.6 LX (86-02)		





ENGINE MOUNTING & RUBBER BUYERS GUIDE

	<p>AR6616 Rear Strut Link Mercedes-Benz (R170) SLK200 (M111.958) 2.0 Kompressor, SLK230 (M111.973, M111.978) 2.3 Kompressor (99-04), (W124) 200, E, E200 (M102.922) 2.0, 220E, E220 (M111.960) 2.2, 230E, E230 (M102.982) 2.3, (M103.940) 260E 2.6 6-Cyl., (M104.942) 280E 2.8 6-Cyl., 300D 3.0 5-Cyl., 300E 3.0 6-Cyl., 320E, E320 (M104.992) 3.2 6-Cyl., Sportline (86-96), (W201) 190E (M102.920) 1.8, (M102.922) 2.0, (M102.983) 2.3 Sportline (93-94), (W202) C-Class (M111.920/21) C180 1.8 Classic, (M111.941) C200 2.0 Classic, Elegance, C220 (M111.961) 2.2 Classic, Elegance, C230 (M111.974) 2.3 Classic, Elegance, Kompressor, Sport, C240 (M112.910) 2.4 Classic, Elegance, C250D, TD (M605.910) 2.5 5-Cyl., C280 (M104.941) 2.8 6-Cyl. Elegance (94-00), (W203) C-Class C180 (M111.920) 1.8 Classic, C200 (M271.940) 2.0 Classic, S/W, C220 (OM611.962, OM646.963) 2.2 CDi Classic, S/W, Elegance, C230 2.3 Coupe, C240 (M203.086) 2.6 V6 Elegance, S/W, Elegance S/W, C270 (OM612.962) 2.7 CDi 5-Cyl. Elegance, S/W, C320 (M111.946) 3.2 V6 Avantgarde Elegance, SW, (M271.946) C180K, (M271.940) C200K, (OM611.962, OM646.963) C220 CDi, (M271.948) C230K, (M112.912) C240/240T, (OM642.910) C320 CDi, (M272.960) C350 (00-11), (W210) E-Class E200K (M111.957) 2.0, E230 (M111.970) 2.3, E240 (M112.911) 2.4, E280 (M112.921) 2.8 V6, E320 (M104.995, M112.941) 3.2 V6, E430 (M113.940) 4.3 V8 (96-02)</p>
	<p>AR6617 Rear Camber Strut Mercedes-Benz (R170) SLK200 (M111.958) 2.0 Kompressor, SLK230 (M111.973, M111.978) 2.3 Kompressor (99-04), (W124) 200, E, E200 (M102.922) 2.0, 220E, E220 (M111.960) 2.2, 230E, E230 (M102.982) 2.3, (M103.940) 260E 2.6 6-Cyl., (M104.942) 280E 2.8 6-Cyl., 300D 3.0 5-Cyl., 300E 3.0 6-Cyl., 320E, E320 (M104.992) 3.2 6-Cyl., Sportline (86-96), (W201) 190E (M102.920) 1.8, (M102.922) 2.0, (M102.983) 2.3 Sportline (93-94), (W202) C-Class (M111.920/21) C180 1.8 Classic, (M111.941) C200 2.0 Classic, Elegance, C220 (M111.961) 2.2 Classic, Elegance, C230 (M111.974) 2.3 Classic, Elegance, Kompressor, Sport, C240 (M112.910) 2.4 Classic, Elegance, C250D, TD (M605.910) 2.5 5-Cyl., C280 (M104.941) 2.8 6-Cyl. Elegance (94-00), (W203) C-Class C180 (M111.920) 1.8 Classic, C200 (M271.940) 2.0 Classic, S/W, C220 (OM611.962, OM646.963) 2.2 CDi Classic, S/W, Elegance, C230 2.3 Coupe, C240 (M203.086) 2.6 V6 Elegance, S/W, Elegance S/W, C270 (OM612.962) 2.7 CDi 5-Cyl. Elegance, S/W, C320 (M111.946) 3.2 V6 Avantgarde Elegance, SW, (M271.946) C180K, (M271.940) C200K, (OM611.962, OM646.963) C220 CDi, (M271.948) C230K, (M112.912) C240/240T, (OM642.910) C320 CDi, (M272.960) C350 (00-11), (W210) E-Class E200K (M111.957) 2.0, E230 (M111.970) 2.3, E240 (M112.911) 2.4, E280 (M112.921) 2.8 V6, E320 (M104.995, M112.941) 3.2 V6, E430 (M113.940) 4.3 V8 (96-02)</p>
	<p>AR6618 Engine Mounting - L/RHS Mazda B-Series 4X4 B2600 (4G54) V6 LWB D/cab Magnum, Drifter P/up Pet. (86-95)</p>
	<p>AR6619 Transmission Mounting Ford Courier 4X4 3.0 V6 Std., XLT, D/cab, Leisure, Explorer, Exec. LWB P/up Essex Pet., 3.4 V6 Leisure D/cab LWB P/up Pet. (90-00); Mazda B-Series 4X4 B2600 (4G54) V6 LWB D/cab Magnum, Drifter P/up Pet. (86-95), B3400 V6 LWB D/cab Magnum P/up Pet. (86-99)</p>
	<p>AR6620 Transmission Mounting Mercedes-Benz (W126) 280S, SE (M110.987/89) 2.8 6-Cyl., 380SE (M116.963) 3.8 V8, 420SE (M116.965) 4.2 V8, 500SE (M117.965) 5.0 V8 (86-93)</p>

	<p>AR6622 Transmission Mounting Ford Courier 4X4 (WL4) 2.5D TD V6 D/cab, Leisure LWB P/up Dies. (90-00), Ranger 1.8, XL SWB, LWB P/up Pet., 2.2, XL SWB, LWB P/up Pet., (WL4) 2.5D, TD High Trail, High Trail XL, XL D/cab, XLT Hi Trail, Super Cab XLT Hi Trail SWB, LWB P/up Dies., 4.0 V6 SubCab XLT Hi Trail, Super Cab XLT, XLE D/C, Hi Trail SWB, LWB P/up Pet. (01-10), Ranger 4X4 2.5D, TD V6 XL D/cab, XLT, SubCab, XLT Hi Trail, Super Cab XLT LWB P/up Dies., 4.0 V6 D/cab XLE, SubCab XLT Hi Trail, Super Cab XLT LWB P/up Pet. (00-10), Ranger 2.5D TD XL D/cab, XLT, SubCab, XLT Hi Trail, Super Cab XLT LWB P/up Dies., 3.0 TDCi D/cab XLE, SubCab XLT, Hi Trail, Super Cab XLT LWB P/up Dies. (07-12) - Man. Models; Mazda B-Series B2500D (WL4), TD LWB Drifter, SLX P/up Dies. (82-00), B2600i LWB D/cab, Drifter SLX P/up Pet. (86-02) - Man. Models, BT-50 4X2 2.5 TDi SLX D/cab P/up, 2.6 SLE D/cab, S/cab, P/up, (WLE7) 3.0 CRDi D/cab, SLE S/cab, CRDi SLX P/up (07-12) - Man. Models, Drifter 1.8 SWB, LWB XL P/up Pet., 2.2 SWB, LWB XL, (WL4) 2.5TD LWB Hi Ride, S/cab, SL Hi Ride, SLE, SLX, D/cab, LX Hi Ride, P/up Dies., 2.6i LWB SL Hi Ride S/cab, SLE D/C, SLX, Hi Ride, SLX Hi Ride D/cab (01-05) - Man. Models</p>
	<p>AR6625 Engine Mounting - RHS Mercedes-Benz (W123) 230S, 250, 280E, 300D (77-86)</p>
	<p>AR6626 Engine Mounting - LHS Mercedes-Benz (W123) 230S, 250, 280E, 300D (77-86)</p>
	<p>AR663 Transmission Mounting Ford Escort MKI / II 1.1 300 SWB P/van Kent Pet., 1.3 30/35/45 SWB P/van Kent Pet., 1.6 45 P/van SWB P/van Kent Pet. (68-81)</p>
 <p>ID: 12, OD: 44, H: 33</p>	<p>AR6630 Front Upper Control Arm Bush - Inner Mercedes-Benz (W123) 200, 230E, 230S, 240D, 250, 280E, 300D (77-86)</p>
 <p>ID: 16, OD: 41, H: 30</p>	<p>AR6631 Front Upper Control Arm Bush - Outer Mercedes-Benz (W126) 280S, SE (M110.987/89) 2.8 6-Cyl., 300SE (M103.981) 3.0 6-Cyl., 380SE (M116.963) 3.8 V8, 420SE (M116.965) 4.2 V8, 500SE (M117.965) 5.0 V8 (86-93)</p>
 <p>ID: 30, OD: 93, L: 139, W: 21</p>	<p>AR6632 Centre Bearing Rubber Mercedes-Benz (W124) (M103.940) 260E 2.6 6-Cyl., (M104.942) 280E 2.8 6-Cyl., 300D 3.0 5-Cyl., 300E 3.0 6-Cyl., 320E, E320 (M104.992) 3.2 6-Cyl., Sportline (86-96), (W126) 420SE (M116.965) 4.2 V8, 500SE (M117.965) 5.0 V8 (86-93)</p>
	<p>AR6635 Engine Mounting - L/RHS Mercedes-Benz (W124) 200, E, E200 (M102.922) 2.0, 220E, E220 (M111.960) 2.2, 230E, E230 (M102.982) 2.3, (M103.940) 260E 2.6 6-Cyl., (M104.942) 280E 2.8 6-Cyl., 300D 3.0 5-Cyl., 300E 3.0 6-Cyl., 320E, E320 (M104.992) 3.2 6-Cyl., Sportline (86-96), (W201) 190E (M102.920) 1.8, (M102.922) 2.0, (M102.983) 2.3 Sportline (93-94)</p>
 <p>ID: 25</p>	<p>AR6638 Centre Bearing Rubber Mercedes-Benz (W124) 200, E, E200 (M102.922) 2.0, 220E, E220 (M111.960) 2.2, 230E, E230 (M102.982) 2.3 (86-96)</p>

ENGINE MOUNTING & RUBBER BUYERS GUIDE

	<p>AR6640 Transmission Mounting</p> <p>Mercedes-Benz (W124) 200, E, E200 (M102.922) 2.0, 220E, E220 (M111.960) 2.2, 230E, E230 (M102.982) 2.3, (M103.940) 260E 2.6 6-Cyl., (M104.942) 280E 2.8 6-Cyl., 300D 3.0 5-Cyl., 300E 3.0 6-Cyl., 320E, E320 (M104.992) 3.2 6-Cyl., Sportline (86-96), (W126) 300SE (M103.981) 3.0 6-Cyl. (86-93), (W201) 190E (M102.920) 1.8, (M102.922) 2.0, (M102.983) 2.3 Sportline (93-94) - Man. Models, (W202) C-Class (M111.920/21) C180 1.8 Classic, (M111.941) C200 2.0 Classic, Elegance (94-00) - Man. Models</p>
 <p>ID: 14.3/16, OD: 50, H: 48</p>	<p>AR6642 Front Lower Control Arm Bush - Inner Repair Kit</p> <p>Mercedes-Benz (W201) 190E (M102.920) 1.8, (M102.922) 2.0 (93-94)</p>
 <p>ID: 24, OD: 51.5, L: 35.5</p>	<p>AR6645 Front Stabilizer Bar Bush - Inner & Outer</p> <p>Mercedes-Benz (W124) 200, E, E200 (M102.922) 2.0, 220E, E220 (M111.960) 2.2, 230E, E230 (M102.982) 2.3 (86-96)</p>
 <p>ID: 14</p>	<p>AR6645A Front Stabilizer Bar Bush - Inner</p> <p>Mercedes-Benz (W124) 200, E, E200 (M102.922) 2.0, 220E, E220 (M111.960) 2.2, 230E, E230 (M102.982) 2.3 (86-96)</p>
 <p>ID: 24</p>	<p>AR6645B Front Stabilizer Bar Bush - Inner</p> <p>Mercedes-Benz (R170) SLK200 (M111.958) 2.0 Kompressor, SLK230 (M111.973, M111.978) 2.3 Kompressor (99-04), (W124) (M103.940) 260E 2.6 6-Cyl., (M104.942) 280E 2.8 6-Cyl., 300D 3.0 5-Cyl., 300E 3.0 6-Cyl., 320E, E320 (M104.992) 3.2 6-Cyl., Sportline (86-96), (W201) 190E (M102.920) 1.8, (M102.922) 2.0, (M102.983) 2.3 Sportline (93-94), (W202) C-Class (M111.920/21) C180 1.8 Classic, (M111.941) C200 2.0 Classic, Elegance, C220 (M111.961) 2.2 Classic, Elegance, C230 (M111.974) 2.3 Classic, Elegance, Kompressor, Sport, C240 (M112.910) 2.4 Classic, Elegance, C250D, TD (M605.910) 2.5 5-Cyl., C280 (M104.941) 2.8 6-Cyl. Elegance (94-00)</p>
 <p>ID: 18</p>	<p>AR6646 Front Stabilizer Bar Bush - Outer</p> <p>Mercedes-Benz (R170) SLK200 (M111.958) 2.0 Kompressor, SLK230 (M111.973, M111.978) 2.3 Kompressor (99-04), (W124) 200, E, E200 (M102.922) 2.0, 220E, E220 (M111.960) 2.2, 230E, E230 (M102.982) 2.3, (M103.940) 260E 2.6 6-Cyl., (M104.942) 280E 2.8 6-Cyl., 300D 3.0 5-Cyl., 300E 3.0 6-Cyl., 320E, E320 (M104.992) 3.2 6-Cyl., Sportline (86-96), (W202) C-Class (M111.920/21) C180 1.8 Classic, (M111.941) C200 2.0 Classic, Elegance, C220 (M111.961) 2.2 Classic, Elegance, C230 (M111.974) 2.3 Classic, Elegance, Kompressor, Sport, C240 (M112.910) 2.4 Classic, Elegance, C250D, TD (M605.910) 2.5 5-Cyl., C280 (M104.941) 2.8 6-Cyl. Elegance (94-00)</p>
 <p>ID: 14.5, OD: 59, H: 130</p>	<p>AR6647 Front Strut Mounting</p> <p>Mercedes-Benz (W124) 200, E, E200 (M102.922) 2.0, 220E, E220 (M111.960) 2.2, 230E, E230 (M102.982) 2.3, (M103.940) 260E 2.6 6-Cyl., (M104.942) 280E 2.8 6-Cyl., 300D 3.0 5-Cyl., 300E 3.0 6-Cyl., 320E, E320 (M104.992) 3.2 6-Cyl., Sportline (86-96)</p>



















 <p>ID: 12, OD: 33, L: 58</p>	<p>AR6652 Rear Lower Control Arm Bush - Inner & Outer</p> <p>Mercedes-Benz (R170) SLK200 (M111.958) 2.0 Kompressor, SLK230 (M111.973, M111.978) 2.3 Kompressor (99-04), (W124) 200, E, E200 (M102.922) 2.0, 220E, E220 (M111.960) 2.2, 230E, E230 (M102.982) 2.3, (M103.940) 260E 2.6 6-Cyl., (M104.942) 280E 2.8 6-Cyl., 300D 3.0 5-Cyl., 300E 3.0 6-Cyl., 320E, E320 (M104.992) 3.2 6-Cyl., Sportline (86-96), (W126) 280S, SE (M110.987/89) 2.8 6-Cyl., 300SE (M103.981) 3.0 6-Cyl., 380SE (M116.963) 3.8 V8, 420SE (M116.965) 4.2 V8, 500SE (M117.965) 5.0 V8 (86-93), (W201) 190E (M102.920) 1.8, (M102.922) 2.0, (M102.983) 2.3 Sportline (93-94), (W202) C-Class (M111.920/21) C180 1.8 Classic, (M111.941) C200 2.0 Classic, Elegance, C220 (M111.961) 2.2 Classic, Elegance, C230 (M111.974) 2.3 Classic, Elegance, Kompressor, Sport, C240 (M112.910) 2.4 Classic, Elegance, C250D, TD (M605.910) 2.5 5-Cyl., C280 (M104.941) 2.8 6-Cyl. Elegance (94-00), (W203) C-Class C180 (M111.920) 1.8 Classic, C200 (M271.940) 2.0 Classic, S/W, C220 (OM611.962, OM646.963) 2.2 CDi Classic, S/W, Elegance, C230 2.3 Coupe, C240 (M203.086) 2.6 V6 Elegance, S/W, Elegance S/W, C270 (OM612.962) 2.7 CDi 5-Cyl. Elegance, S/W, C320 (M111.946) 3.2 V6 Avantgarde Elegance, SW, (M271.946) C180K, (M271.940) C200K, (OM611.962, OM646.963) C220 CDi, (M271.948) C230K, (M112.912) C240/240T, (OM642.910) C320 CDi, (M272.960) C350 (00-11), (W208) CLK230 (M111.973/5) 2.3 Kompressor, CLK320 (M112.940) 3.2 V6 Cabrio (98-05), (W209) CLK320 (M112.940) 3.2 V6 Elegance, Cabrio (98-05), (W210) E-Class E200K (M111.957) 2.0, E230 (M111.970) 2.3, E240 (M112.911) 2.4, E280 (M112.921) 2.8 V6, E320 (M104.995, M112.941) 3.2 V6, E430 (M113.940) 4.3 V8 (96-02), (W220) S-Class S320 (M613.960) 3.2 CDi 6-Cyl., S500 (M113.960) 5.0 V8, S600L (M137.960) 5.5 V12 (99-04)</p>
	<p>AR6654 Rear Axle Front Lower Thrust Arm</p> <p>Mercedes-Benz (R170) SLK200 (M111.958) 2.0 Kompressor, SLK230 (M111.973, M111.978) 2.3 Kompressor (99-04), (W124) 200, E, E200 (M102.922) 2.0, 220E, E220 (M111.960) 2.2, 230E, E230 (M102.982) 2.3, (M103.940) 260E 2.6 6-Cyl., (M104.942) 280E 2.8 6-Cyl., 300D 3.0 5-Cyl., 300E 3.0 6-Cyl., 320E, E320 (M104.992) 3.2 6-Cyl., Sportline (86-96), (W126) 280S, SE (M110.987/89) 2.8 6-Cyl., 300SE (M103.981) 3.0 6-Cyl., 380SE (M116.963) 3.8 V8, 420SE (M116.965) 4.2 V8, 500SE (M117.965) 5.0 V8 (86-93), (W201) 190E (M102.920) 1.8, (M102.922) 2.0, (M102.983) 2.3 Sportline (93-94), (W202) C-Class (M111.920/21) C180 1.8 Classic, (M111.941) C200 2.0 Classic, Elegance, C220 (M111.961) 2.2 Classic, Elegance, C230 (M111.974) 2.3 Classic, Elegance, Kompressor, Sport, C240 (M112.910) 2.4 Classic, Elegance, C250D, TD (M605.910) 2.5 5-Cyl., C280 (M104.941) 2.8 6-Cyl. Elegance (94-00), (W203) C-Class C180 (M111.920) 1.8 Classic, C200 (M271.940) 2.0 Classic, S/W, C220 (OM611.962, OM646.963) 2.2 CDi Classic, S/W, Elegance, C230 2.3 Coupe, C240 (M203.086) 2.6 V6 Elegance, S/W, Elegance S/W, C270 (OM612.962) 2.7 CDi 5-Cyl. Elegance, S/W, C320 (M111.946) 3.2 V6 Avantgarde Elegance, SW, (M271.946) C180K, (M271.940) C200K, (OM611.962, OM646.963) C220 CDi, (M271.948) C230K, (M112.912) C240/240T, (OM642.910) C320 CDi, (M272.960) C350 (00-11), (W208) CLK230 (M111.973/5) 2.3 Kompressor, CLK320 (M112.940) 3.2 V6 Cabrio (98-05), (W209) CLK320 (M112.940) 3.2 V6 Elegance, Cabrio (98-05), (W210) E-Class E200K (M111.957) 2.0, E230 (M111.970) 2.3, E240 (M112.911) 2.4, E280 (M112.921) 2.8 V6, E320 (M104.995, M112.941) 3.2 V6, E430 (M113.940) 4.3 V8 (96-02), (W220) S-Class S320 (M613.960) 3.2 CDi 6-Cyl., S500 (M113.960) 5.0 V8, S600L (M137.960) 5.5 V12 (99-04)</p>
	<p>AR6655 Engine Mounting - RHS</p> <p>Mercedes-Benz (W126) 300SE (M103.981) 3.0 6-Cyl. (86-93)</p>
	<p>AR6656 Transmission Mounting</p> <p>Mercedes-Benz (W126) 300SE (M103.981) 3.0 6-Cyl. (86-93), (W201) 190E (M102.920) 1.8, (M102.922) 2.0, (M102.983) 2.3 Sportline (93-94) - Auto. Models, (W202) C-Class (M111.920/21) C180 1.8 Classic, (M111.941) C200 2.0 Classic, Elegance (94-00) - Auto. Models</p>

ENGINE MOUNTING & RUBBER BUYERS GUIDE

	<p>AR6659 Transmission Mounting</p> <p>Mercedes-Benz (W210) E-Class E200K (M111.957) 2.0, E230 (M111.970) 2.3, E240 (M112.911) 2.4, E280 (M112.921) 2.8 V6, E320 (M104.995, M112.941) 3.2 V6, E430 (M113.940) 4.3 V8 (96-02) - Auto. Models, (W211) E-Class E220 CDi (OM646.961) 2.2, E240 (M112.913) 2.6, E280 (M272.943) 3.0, E320 (M112.949) 3.2 (02-10) - Auto. Models</p>
 ID: 37, OD: 138, PCD: 90 6-HOLES	<p>AR6660 Propshaft Coupling - Front</p> <p>Mercedes-Benz (W124) 200, E, E200 (M102.922) 2.0, 220E, E220 (M111.960) 2.2, 230E, E230 (M102.982) 2.3, 300D 3.0 5-Cyl., 300E 3.0 6-Cyl. (86-96), (W126) 280S, SE (M110.987/89) 2.8 6-Cyl., 300SE (M103.981) 3.0 6-Cyl., 380SE (M116.963) 3.8 V8, 420SE (M116.965) 4.2 V8, 500SE (M117.965) 5.0 V8 (86-93), (W201) 190E (M102.920) 1.8, (M102.922) 2.0, (M102.983) 2.3 Sportline (93-94)</p>
	<p>AR6661 Engine Mounting - L/RHS</p> <p>Mercedes-Benz (R170) SLK200 (M111.958) 2.0 Kompressor, SLK230 (M111.973, M111.978) 2.3 Kompressor (99-04), (W202) C-Class (M111.920/21) C180 1.8 Classic, (M111.941) C200 2.0 Classic, Elegance, C220 (M111.961) 2.2 Classic, Elegance, C230 (M111.974) 2.3 Classic, Elegance, Kompressor, Sport, C240 (M112.910) 2.4 Classic, Elegance, C250D, TD (M605.910) 2.5 5-Cyl., C280 (M104.941) 2.8 6-Cyl. Elegance (94-00), (W203) C-Class C180 (M111.920) 1.8 Classic, C200 (M271.940) 2.0 Classic, S/W, C220 (OM611.962, OM646.963) 2.2 CDi Classic, S/W, Elegance, C230 2.3 Coupe, (M271.946) C180K, (M271.940) C200K, (M271.948) C230K (00-11), (W208) CLK230 (M111.973/5) 2.3 Kompressor (98-05), (W210) E-Class E200K (M111.957) 2.0, E230 (M111.970) 2.3, E240 (M112.911) 2.4, E280 (M112.921) 2.8 V6, E320 (M104.995, M112.941) 3.2 V6, E430 (M113.940) 4.3 V8 (96-02), (W211) E-Class E220 CDi (OM646.961) 2.2 (02-10)</p>
 ID: 41, OD: 128, W: 20, PCD: 90 6-HOLES	<p>AR6664 Propshaft Coupling - Front</p> <p>Mercedes-Benz (W202) C-Class C200 (M111.941) 2.0 Classic, Elegance, C220 (M111.961) 2.2 Classic, Elegance (94-00) - Man. Models, (W210) E-Class E200K (M111.957) 2.0, E230 (M111.970) 2.3, E240 (M112.911) 2.4, E280 (M112.921) 2.8 V6, E320 (M104.995, M112.941) 3.2 V6, E430 (M113.940) 4.3 V8 (96-02)</p>
	<p>AR6665 Transmission Mounting</p> <p>Mercedes-Benz (W202) C-Class C220 (M111.961) 2.2 Classic, Elegance, C230 (M111.974) 2.3 Classic, Elegance, Kompressor, Sport, C240 (M112.910) 2.4 Classic, Elegance, C250D, TD (M605.910) 2.5 5-Cyl., C280 (M104.941) 2.8 6-Cyl. Elegance (94-00) - Man. Models</p>
	<p>AR6666 Transmission Mounting</p> <p>Mercedes-Benz (R170) SLK200 (M111.958) 2.0 Kompressor, SLK230 (M111.973, M111.978) 2.3 Kompressor (99-04), (W140) S-Class S320 (M104.994) 3.2 6-Cyl., S420 (M119.971) 4.2 V8, S500 (M119.970) 5.0 8-Cyl. (93-99), (W202) C-Class C220 (M111.961) 2.2 Classic, Elegance, C230 (M111.974) 2.3 Classic, Elegance, Kompressor, Sport, C240 (M112.910) 2.4 Classic, Elegance, C250D, TD (M605.910) 2.5 5-Cyl., C280 (M104.941) 2.8 6-Cyl. Elegance (94-00) - Auto. Models, (W203) C-Class C180 (M111.920) 1.8 Classic, C200 (M271.940) 2.0 Classic, S/W, C220 (OM611.962, OM646.963) 2.2 CDi Classic, S/W, Elegance, C230 2.3 Coupe, C240 (M203.086) 2.6 V6 Elegance, S/W, Elegance S/W, C270 (OM612.962) 2.7 CDi 5-Cyl. Elegance, S/W, C320 (M111.946) 3.2 V6 Avantgarde Elegance, SW, (M271.946) C180K, (M271.940) C200K, (OM611.962, OM646.963) C220 CDi, (M271.948) C230K, (M112.912) C240/240T, (OM642.910) C320 CDi, (M272.960) C350 (00-11), (W208) CLK230 (M111.973/5) 2.3 Kompressor, CLK320 (M112.940) 3.2 V6 Cabrio (98-05), (W209) CLK320 (M112.940) 3.2 V6 Elegance, Cabrio (98-05), (W210) E-Class E200K (M111.957) 2.0, E230 (M111.970) 2.3, E240 (M112.911) 2.4, E280 (M112.921) 2.8 V6, E320 (M104.995, M112.941) 3.2 V6, E430 (M113.940) 4.3 V8 (96-02) - Man. Models, (W211) E-Class E220 CDi (OM646.961) 2.2, E240 (M112.913) 2.6, E280 (M272.943) 3.0, E320 (M112.949) 3.2 (02-10) - Man. Models, (W211) E-Class (M271.941/956) E200K, (OM647.961) E270 CDi, (M112.949) E320, (OM642.920) E320 CDi, (M272.964) E350, (M113.967) E500 (02-10), (W220) S-Class S320 (M613.960) 3.2 CDi 6-Cyl., S500 (M113.960) 5.0 V8, S600L (M137.960) 5.5 V12 (99-04)</p>







 ID: 20, OD: 60.5, L: 87	<p>AR6667 Front Lower Control Arm Bush - Inner</p> <p>Mercedes-Benz (W202) C-Class (M111.920/21) C180 1.8 Classic, (M111.941) C200 2.0 Classic, Elegance (94-00), (W202) C-Class (M111.920/21) C180 1.8 Classic, (M111.941) C200 2.0 Classic, Elegance, C220 (M111.961) 2.2 Classic, Elegance, C230 (M111.974) 2.3 Classic, Elegance, Kompressor, Sport, C240 (M112.910) 2.4 Classic, Elegance, C250D, TD (M605.910) 2.5 5-Cyl., C280 (M104.941) 2.8 6-Cyl. Elegance (94-00), (W208) CLK230 (M111.973/5) 2.3 Kompressor, CLK320 (M112.940) 3.2 V6 Cabrio (98-05), (W209) CLK320 (M112.940) 3.2 V6 Elegance, Cabrio (98-05)</p>
 ID: 16, OD: 61, L: 58	<p>AR6670 Rear X-Member Bush Kit - Front</p> <p>Mercedes-Benz (R170) SLK200 (M111.958) 2.0 Kompressor, SLK230 (M111.973, M111.978) 2.3 Kompressor (00-04), (W124) 300D 3.0 5-Cyl. (86-96), (W201) 190E (M102.920) 1.8, (M102.922) 2.0, (M102.983) 2.3 Sportline (93-94), (W202) C-Class (M111.920/21) C180 1.8 Classic, (M111.941) C200 2.0 Classic, Elegance, C220 (M111.961) 2.2 Classic, Elegance, C230 (M111.974) 2.3 Classic, Elegance, Kompressor, Sport, C240 (M112.910) 2.4 Classic, Elegance, C250D, TD (M605.910) 2.5 5-Cyl., C280 (M104.941) 2.8 6-Cyl. Elegance (94-00)</p>
 ID: 30	<p>AR6671 Centre Bearing Rubber</p> <p>Mercedes-Benz (R170) SLK200 (M111.958) 2.0 Kompressor, SLK230 (M111.973, M111.978) 2.3 Kompressor (99-04), (W201) 190E (M102.920) 1.8, (M102.922) 2.0, (M102.983) 2.3 Sportline (93-94), (W202) C-Class (M111.920/21) C180 1.8 Classic, (M111.941) C200 2.0 Classic, Elegance, C220 (M111.961) 2.2 Classic, Elegance, C230 (M111.974) 2.3 Classic, Elegance, Kompressor, Sport, C240 (M112.910) 2.4 Classic, Elegance, C250D, TD (M605.910) 2.5 5-Cyl., C280 (M104.941) 2.8 6-Cyl. Elegance (94-00)</p>
 ID: 18, OD: 80, L: 95	<p>AR6673 Rear X-Member Bush Kit - Rear</p> <p>Mercedes-Benz (R170) SLK200 (M111.958) 2.0 Kompressor, SLK230 (M111.973, M111.978) 2.3 Kompressor (99-04), (W201) 190E (M102.920) 1.8, (M102.922) 2.0, (M102.983) 2.3 Sportline (93-94), (W202) C-Class (M111.920/21) C180 1.8 Classic, (M111.941) C200 2.0 Classic, Elegance, C220 (M111.961) 2.2 Classic, Elegance, C230 (M111.974) 2.3 Classic, Elegance, Kompressor, Sport, C240 (M112.910) 2.4 Classic, Elegance, C250D, TD (M605.910) 2.5 5-Cyl., C280 (M104.941) 2.8 6-Cyl. Elegance (94-00), (W208) CLK230 (M111.973/5) 2.3 Kompressor, CLK320 (M112.940) 3.2 V6 Cabrio (98-05), (W209) CLK320 (M112.940) 3.2 V6 Elegance, Cabrio (98-05)</p>
 ID: 40, OD: 115, W: 22.5, PCD: 80 6-HOLES	<p>AR6674 Propshaft Coupling - Rear</p> <p>Mercedes-Benz (W202) C-Class (M111.920/21) C180 1.8 Classic (94-00)</p>
 ID: 20, L: 43.5, H: 42, W: 44.5	<p>AR6677 Front Stabilizer Bar Bush</p> <p>Mercedes-Benz (W203) C-Class C180 (M111.920) 1.8 Classic, C200 (M271.940) 2.0 Classic, S/W, C220 (OM611.962, OM646.963) 2.2 CDi Classic, S/W, Elegance, C230 2.3 Coupe, C240 (M203.086) 2.6 V6 Elegance, S/W, Elegance S/W, C270 (OM612.962) 2.7 CDi 5-Cyl. Elegance, S/W, C320 (M111.946) 3.2 V6 Avantgarde Elegance, SW, (M271.946) C180K, (M271.940) C200K, (OM611.962, OM646.963) C220 CDi, (M271.948) C230K, (M112.912) C240/240T, (OM642.910) C320 CDi, (M272.960) C350 (00-11), (W209) CLK320 (M112.940) 3.2 V6 Elegance, Cabrio (98-05)</p>
	<p>AR6680 Rear Lateral Link - L/RHS</p> <p>Mazda Etude 160i, iE, iSE, iSE Sport, 180iSE, iSX, iSX Sport (99-00)</p>
 ID: 12/14, L: 625	<p>AR6681 Rear Lateral Link - L/RHS</p> <p>Mazda Etude 160i, iE, iSE, iSE Sport, 180iSE, iSX, iSX Sport (00-04)</p>

ENGINE MOUNTING & RUBBER BUYERS GUIDE

	AR6682 Front Lateral Link - L/RHS Mazda Etude 160i, iE, iSE, iSE Sport, 180iSE, iSX, iSX Sport (99-00)		AR6694 Engine Mounting - L/RHS Mercedes-Benz (W168) A-Class A160 (M166.940) 1.6 Classic, Elegance, A190 (M167.690) 1.9 Elegance (00-05)
 ID: 12/14, L: 597	AR6683 Front Lateral Link - L/RHS Mazda Etude 160i, iE, iSE, iSE Sport, 180iSE, iSX, iSX Sport (00-04)	 ID: 16, OD: 48.5, W: 48.5	AR6695 Front Lower Control Arm Bush - Inner Repair Kit Mercedes-Benz (W124) 200, E, E200 (M102.922) 2.0, 220E, E220 (M111.960) 2.2, 230E, E230 (M102.982) 2.3, (M103.940) 260E 2.6 6-Cyl., (M104.942) 280E 2.8 6-Cyl., 300D 3.0 5-Cyl., 300E 3.0 6-Cyl., 320E, E320 (M104.992) 3.2 6-Cyl., Sportline (86-96), (W201) 190E (M102.983) 2.3 Sportline (93-94)
	AR6684 Rear Trailing Link - LHS Mazda Etude 160i, iE, iSE, iSE Sport, 180iSE, iSX, iSX Sport (99-00)		AR6696 Rear Axle Frame Diff. Mounting Mercedes-Benz (W124) 200, E, E200 (M102.922) 2.0, 220E, E220 (M111.960) 2.2, 230E, E230 (M102.982) 2.3, (M103.940) 260E 2.6 6-Cyl., (M104.942) 280E 2.8 6-Cyl., 300D 3.0 5-Cyl., 300E 3.0 6-Cyl., 320E, E320 (M104.992) 3.2 6-Cyl., Sportline (86-96)
	AR6685 Rear Trailing Link - RHS Mazda Etude 160i, iE, iSE, iSE Sport, 180iSE, iSX, iSX Sport (99-00)		AR6697 Rear Axle Frame Diff. Mounting Mercedes-Benz (W124) 200, E, E200 (M102.922) 2.0, 220E, E220 (M111.960) 2.2, 230E, E230 (M102.982) 2.3, (M103.940) 260E 2.6 6-Cyl., (M104.942) 280E 2.8 6-Cyl., 300D 3.0 5-Cyl., 300E 3.0 6-Cyl., 320E, E320 (M104.992) 3.2 6-Cyl., Sportline (86-96)
 ID: 12/20, L: 655	AR6686 Rear Trailing Link - LHS Mazda Etude 160i, iE, iSE, iSE Sport, 180iSE, iSX, iSX Sport (00-04)		AR6698 Rear Subframe Bush Kit - Front Mercedes-Benz (R170) SLK200 (M111.958) 2.0 Kompressor, SLK230 (M111.973, M111.978) 2.3 Kompressor (97-00), (W124) (M103.940) 260E 2.6 6-Cyl., (M104.942) 280E 2.8 6-Cyl., 300E 3.0 6-Cyl., 320E, E320 3.2 6-Cyl., Sportline (M104.992) (86-96)
 ID: 12/20, L: 655	AR6687 Rear Trailing Link - RHS Mazda Etude 160i, iE, iSE, iSE Sport, 180iSE, iSX, iSX Sport (00-04)		AR6699 Rear Subframe Bush - Rear Mercedes-Benz (W124) 200, E, E200 (M102.922) 2.0, 220E, E220 (M111.960) 2.2, 230E, E230 (M102.982) 2.3, (M103.940) 260E 2.6 6-Cyl., (M104.942) 280E 2.8 6-Cyl., 300D 3.0 5-Cyl., 300E 3.0 6-Cyl., 320E, E320 (M104.992) 3.2 6-Cyl., Sportline (86-96)
	AR6688 Engine Mounting - RHS Mazda Etude 180iSE, iSX, iSX Sport (99-04)		AR6701 Rear Axle Lower Wheel Bearing Housing - L/RHS Mercedes-Benz (R170) SLK200 (M111.958) 2.0 Kompressor, SLK230 (M111.973, M111.978) 2.3 Kompressor (99-04), (W124) 200, E, E200 (M102.922) 2.0, 220E, E220 (M111.960) 2.2, 230E, E230 (M102.982) 2.3, (M103.940) 260E 2.6 6-Cyl., (M104.942) 280E 2.8 6-Cyl., 300D 3.0 5-Cyl., 300E 3.0 6-Cyl., 320E, E320 (M104.992) 3.2 6-Cyl., Sportline (86-96), (W201) 190E (M102.920) 1.8, (M102.922) 2.0, (M102.983) 2.3 Sportline (93-94), (W202) C-Class (M111.920/21) C180 1.8 Classic, (M111.941) C200 2.0 Classic, Elegance, C220 (M111.961) 2.2 Classic, Elegance, C230 (M111.974) 2.3 Classic, Elegance, Kompressor, Sport, C240 (M112.910) 2.4 Classic, Elegance, C250D, TD (M605.910) 2.5 5-Cyl., C280 (M104.941) 2.8 6-Cyl. Elegance (94-00), (W208) CLK230 (M111.973/5) 2.3 Kompressor, CLK320 (M112.940) 3.2 V6 Cabrio (98-05), (W209) CLK320 (M112.940) 3.2 V6 Elegance, Cabrio (98-05)
	AR6689 Engine Mounting - Rear Mazda Etude 180iSE, iSX, iSX Sport (99-04)	 ID: 14, OD: 40, L: 48	AR6690 Steering Arm Repair Kit Mercedes-Benz (R170) SLK200 (M111.958) 2.0 Kompressor, SLK230 (M111.973, M111.978) 2.3 Kompressor (99-04), (W202) C-Class (M111.920/21) C180 1.8 Classic, (M111.941) C200 2.0 Classic, Elegance, C220 (M111.961) 2.2 Classic, Elegance, C230 (M111.974) 2.3 Classic, Elegance, Kompressor, Sport, C240 (M112.910) 2.4 Classic, Elegance, C250D, TD (M605.910) 2.5 5-Cyl., C280 (M104.941) 2.8 6-Cyl. Elegance (94-00), (W208) CLK230 (M111.973/5) 2.3 Kompressor, CLK320 (M112.940) 3.2 V6 Cabrio (98-05), (W209) CLK320 (M112.940) 3.2 V6 Elegance, Cabrio (98-05)
	AR6691 Engine Mounting - LHS Mercedes-Benz (W126) 300SE (M103.981) 3.0 6-Cyl. (86-93)		AR6692 Engine Mounting - L/RHS Mercedes-Benz (W126) 280S, SE (M110.987/89) 2.8 6-Cyl., 380SE (M116.963) 3.8 V8, 420SE (M116.965) 4.2 V8, 500SE (M117.965) 5.0 V8 (86-93)
	AR6692 Engine Mounting - L/RHS Mercedes-Benz (W126) 280S, SE (M110.987/89) 2.8 6-Cyl., 380SE (M116.963) 3.8 V8, 420SE (M116.965) 4.2 V8, 500SE (M117.965) 5.0 V8 (86-93)		AR6703 Engine Mounting - L/RHS Mercedes-Benz (W210) E-Class E280 (M112.921) 2.8 V6, E320 (M104.995, M112.941) 3.2 V6, E430 (M113.940) 4.3 V8 (96-02), (W211) E-Class E280 (M272.943) 3.0 (02-10)
	AR6693 Transmission Mounting Mercedes-Benz (W168) A-Class A160 (M166.940) 1.6 Classic, Elegance, A190 (M167.690) 1.9 Elegance (00-05)		

ENGINE MOUNTING & RUBBER BUYERS GUIDE

273

 <small>ID: 15, OD: 37, L: 80</small>	<p>AR6705 Front Lower Control Arm Bush - inner Front & Outer Rear</p> <p>Ford Husky (4G62) 1.8 1-Ton SWB P/up, P/van, Bus Pet., (4G63) 2.0 1-Ton SWB P/up, P/van, Bus Pet. (85-99); Mitsubishi L300 (4G32) 1.6 SWB Mini Bus, Van Pet., (4G62) 1.8 SWB/ LWB, D/S, P/U, P/up, P/van Pet., (4G62) 2.0 LWB P/up Pet. (82-01), Starwagon (4G62) 2.0 LWB S, SL, SLE P/van Pet. (82-01)</p>		<p>AR6716 Transmission Mounting - Extension Housing</p> <p>Mitsubishi Colt LDV 4X4 (4G54) 2.6 LWB Lo-/Hi-Line K33 P/up Pet. (94-98)</p>
	<p>AR6706 Gear Rod Rubber Mounting</p> <p>Mercedes-Benz (W168) A-Class A160 (M166.940) 1.6 Classic, Elegance, A190 (M167.690) 1.9 Elegance (00-05)</p>		<p>AR6717 Transmission Mounting - Extension Housing</p> <p>Mitsubishi Colt LDV 4X4 (4D56) 2.5D LWB Hi-Line K34 P/up Dies., (6G72) 3.0 V6 LWB Lo-Line, D/cab, Hi-Line Rodeo K36 Pet. (94-98)</p>
 <small>ID: 13, OD: 60, L: 53</small>	<p>AR6707 Front Lower Control Arm Bush - Inner</p> <p>Mercedes-Benz (W168) A-Class A160 (M166.940) 1.6 Classic, Elegance, A190 (M167.690) 1.9 Elegance (00-05)</p>	 <small>ID: 17, OD: 38, H: 45</small>	<p>AR6718 Front Lower Control Arm Bush - Inner Front & Outer Rear</p> <p>Mitsubishi Colt LDV (4G32) 1.6 SWB/ LWB Lo-Line K01/11 P/up Pet., (4G63) 2.0 SWB/ LWB D/cab Hi-Line, Lo-Line K12 P/up Pet., (4D56) 2.5D LWB Hi-Line, Lo-Line D/cab K14 P/up Dies., (4G54) 2.6 LWB Hi-Line K13, P/up (94-98)</p>
 <small>ID: 12, OD: 40.5, L: 70.5</small>	<p>AR6708 Front Lower Control Arm Bush - Outer Rear</p> <p>Mercedes-Benz (W168) A-Class A160 (M166.940) 1.6 Classic, Elegance, A190 (M167.690) 1.9 Elegance (00-05)</p>	 <small>ID: 14, OD: 40, H: 65</small>	<p>AR6719 Front Lower Control Arm Bush - Inner Front</p> <p>Mitsubishi Colt LDV 4X4 (4D56) 2.5D LWB Hi-Line K34 P/up Dies., (4G54) 2.6 LWB Lo-/Hi-Line K33 P/up Pet., (6G72) 3.0 V6 LWB Lo-Line, D/cab, Hi-Line Rodeo K36 Pet. (94-98), Colt LDV (4G63) 2.0, i LWB Std., Hi-Line S/Cab, K62T P/up, Pet., 2.4i LWB Hi-Line, S/Cab, D/Cab, Hi Rider K65T, P/up Pet., (4D56) 2.5D LWB Hi-Line, Std., S/cab, K64T P/up Dies. (98-09) - Hi Rider Models, Colt LDV (6G72) 3.0i V6 LWB ClubCab K76T P/up Pet. (01-09), Colt LDV 4X4 (K65/75T) 2.4i LWB S/cab, Hi-Line, D/cab, Trailbuster S/cab, P/up Pet., (K77T) 2.8D LWB S/cab, P/up Dies., (K77T) 2.8TD LWB Rodeo D/cab, P/up Turbo Dies., (6G72, K76T) 3.0i V6 LWB Rodeo D/cab, ClubCab, P/up Pet. (98-09), Pajero 4X4 (4G54) 2.6 SWB, LWB GLS, SJ25/26/45 SUV Pet. (83-94), (4M40) 2.8TDi LWB GLS SUV V23C Dies., (6G72) 3.0 6-Cyl. SWB GLS Wagon V43W, V64W Pet. (90-01), (6G74) 3.5 V6 LWB GLS SUV V25/45W Pet. (95-01)</p>
	<p>AR6709 Engine Mounting - L/RHS</p> <p>Mitsubishi Colt LDV (4D56) 2.5D LWB Hi-Line, Lo-Line D/cab K14 P/up Dies. (94-98), Colt LDV 4X4 (4D56) 2.5D LWB Hi-Line K34 P/up Dies., (6G72) 3.0 V6 LWB Lo-Line, D/cab, Hi-Line Rodeo K36 Pet. (94-98), Colt LDV (4D56) 2.5D LWB Hi-Line, Std., S/cab, K64T P/up Dies. (98-09), Colt LDV (6G72) 3.0i V6 LWB ClubCab K76T P/up Pet. (01-09), Colt LDV 4X4 (6G72, K76T) 3.0i V6 LWB Rodeo D/cab, ClubCab, P/up Pet. (98-09), Pajero 4X4 (4G54) 2.6 SWB, LWB GLS, SJ25/26/45 SUV Pet. (83-94), (6G72) 3.0 6-Cyl. SWB GLS Wagon V43W, V64W Pet. (90-01), (6G74) 3.5 V6 LWB GLS SUV V25/45W Pet. (95-01)</p>	 <small>OD: 72, L: 50/95</small>	<p>AR672 Engine Mounting - L/RHS</p> <p>Toyota Conquest 1.6 (85-88), Corolla 1.6 (86-88)</p>
	<p>AR6710 Engine Mounting - LHS</p> <p>Mitsubishi Colt LDV (4G54) 2.6 LWB Hi-Line K13, P/up (94-98)</p>		<p>AR6720 Front Lower Control Arm Bush - Inner, Outer Rear</p> <p>Hyundai Bakkie (4D56) 2.5i DT LWB P/up, P/van Dies., (4G54) 2.6i LWB P/van, P/up, Droptside Pet. (97-09), H100 (4D56) 2.5i DT LWB P/up, Droptside Dies., (4G54) 2.6i LWB P/van, Droptside Pet. (98-09); Mitsubishi Colt LDV 4X4 (4D56) 2.5D LWB Hi-Line K34 P/up Dies., (4G54) 2.6 LWB Lo-/Hi-Line K33 P/up Pet., (6G72) 3.0 V6 LWB Lo-Line, D/cab, Hi-Line Rodeo K36 Pet. (94-98), Pajero 4X4 (4G54) 2.6 SWB, LWB GLS, SJ25/26/45 SUV Pet. (83-94)</p>
	<p>AR6711 Engine Mounting - LHS</p> <p>Mitsubishi Colt LDV (4D56) 2.5D LWB Hi-Line, Lo-Line D/cab K14 P/up Dies. (94-98)</p>	 <small>ID: 19, OD: 40, L: 90</small>	<p>AR6721 Rear Axle Bush Body Mounting</p> <p>Mercedes-Benz (W168) A-Class A160 (M166.940) 1.6 Classic, Elegance, A190 (M167.690) 1.9 Elegance (00-05)</p>
	<p>AR6712 Engine Mounting - LHS</p> <p>Mitsubishi Colt LDV 4X4 2.6 LWB Lo-/Hi-Line (94-98)</p>		<p>AR6722 Front Stabilizer Bar Bush</p> <p>Mitsubishi Colt LDV (4G32) 1.6 SWB/ LWB Lo-Line K01/11 P/up Pet., (4G63) 2.0 SWB/ LWB D/cab Hi-Line, Lo-Line K12 P/up Pet., (4D56) 2.5D LWB Hi-Line, Lo-Line D/cab K14 P/up Dies., (4G54) 2.6 LWB Hi-Line K13, P/up (94-98)</p>
	<p>AR6713 Rear Axle Bush Body Mounting - Front L/RHS</p> <p>Mercedes-Benz (W168) A-Class A160 (M166.940) 1.6 Classic, Elegance, A190 (M167.690) 1.9 Elegance (00-05)</p>	 <small>THREAD: M10 x 1.5 ID: 25, L: 30, H: 37, W: 38</small>	<p>AR6723 Front Stabilizer Bar Bush</p> <p>Hyundai Bakkie (4D56) 2.5i DT LWB P/up, P/van Dies., (4G54) 2.6i LWB P/van, P/up, Droptside Pet. (97-09), H100 (4D56) 2.5i DT LWB P/up, Droptside Dies., (4G54) 2.6i LWB P/van, Droptside Pet. (97-04); Mitsubishi Colt LDV 4X4 (4D56) 2.5D LWB Hi-Line K34 P/up Dies., (6G72) 3.0 V6 LWB Lo-Line, D/cab, Hi-Line Rodeo K36 Pet. (94-98)</p>
	<p>AR6714 Engine Mounting - Rear</p> <p>Hyundai Bakkie (4G54) 2.6i LWB P/van, P/up, Droptside Pet. (97-09), H100 (4G54) 2.6i LWB P/van, Droptside Pet. (97-04); Mitsubishi Colt LDV 4X4 (4G54) 2.6 LWB Lo-/Hi-Line K33 P/up Pet. (94-98)</p>	 <small>ID: 22, L: 30, H: 44, W: 39</small>	<p>AR6723 Front Stabilizer Bar Bush</p> <p>Hyundai Bakkie (4D56) 2.5i DT LWB P/up, P/van Dies., (4G54) 2.6i LWB P/van, P/up, Droptside Pet. (97-09), H100 (4D56) 2.5i DT LWB P/up, Droptside Dies., (4G54) 2.6i LWB P/van, Droptside Pet. (97-04); Mitsubishi Colt LDV 4X4 (4D56) 2.5D LWB Hi-Line K34 P/up Dies., (4G54) 2.6 LWB Lo-/Hi-Line K33 P/up Pet., (6G72) 3.0 V6 LWB Lo-Line, D/cab, Hi-Line Rodeo K36 Pet. (94-98)</p>
	<p>AR6715 Engine Mounting - Rear</p> <p>Hyundai Bakkie (4D56) 2.5i DT LWB P/up, P/van Dies. (97-09), H100 (4D56) 2.5i DT LWB P/up, Droptside Dies. (97-04); Mitsubishi Colt LDV 4X4 (4D56) 2.5D LWB Hi-Line K34 P/up Dies., (6G72) 3.0 V6 LWB Lo-Line, D/cab, Hi-Line Rodeo K36 Pet. (94-98)</p>		<p>AR6723 Front Stabilizer Bar Bush</p> <p>Hyundai Bakkie (4D56) 2.5i DT LWB P/up, P/van Dies., (4G54) 2.6i LWB P/van, P/up, Droptside Pet. (97-09), H100 (4D56) 2.5i DT LWB P/up, Droptside Dies., (4G54) 2.6i LWB P/van, Droptside Pet. (97-04); Mitsubishi Colt LDV 4X4 (4D56) 2.5D LWB Hi-Line K34 P/up Dies., (4G54) 2.6 LWB Lo-/Hi-Line K33 P/up Pet., (6G72) 3.0 V6 LWB Lo-Line, D/cab, Hi-Line Rodeo K36 Pet. (94-98)</p>

ENGINE MOUNTING & RUBBER BUYERS GUIDE

	<p>AR6724 Steering Coupling Mitsubishi Colt LDV (4G32) 1.6 SWB/ LWB Lo-Line K01/11 P/up Pet., (4G63) 2.0 SWB/ LWB D/cab Hi-Line, Lo-Line K12 P/up Pet., (4D56) 2.5D LWB Hi-Line, Lo-Line D/cab K14 P/up Dies., (4G54) 2.6 LWB Hi-Line K13, P/up (94-98)</p>		<p>AR6750 Front Strut Mounting Nissan Maxima (GV) (VG30E) 300SE 6-Cyl. (91-97)</p>
 <p>NO PICTURE AVAILABLE AT TIME OF PRINT THREAD: M8 x 1.25</p>	<p>AR674 Engine Mounting - L/RHS Nissan 1400 (A14S) 1.4 SWB P/van, P/up Pet., B140 (A14S) 1.4 SWB Deluxe, Sport, Std., CHAMP P/up Pet. (80-93)</p>		<p>AR6752 Rear Wishbone Repair Kit - Outer Mercedes-Benz (W168) A-Class A160 (M166.940) 1.6 Classic, Elegance, A190 (M167.690) 1.9 Elegance (00-05)</p>
	<p>AR6740 Engine Mounting - Front Nissan Maxima (GV) (VG30E) 300SE 6-Cyl. (91-97)</p>		<p>AR6759 Engine Mounting - Front Nissan Primera (SR16DE) 160 SE, Si (98-02)</p>
	<p>AR6741 Engine Mounting - RHS Nissan Maxima (GV) (VG30E) 300SE 6-Cyl. (91-97)</p>		<p>AR6760 Front Strut Mounting Mercedes-Benz (W168) A-Class A160 (M166.940) 1.6 Classic, Elegance, A190 (M167.690) 1.9 Elegance (00-05)</p>
 <p>ID: 10, OD: 49, L: 100</p>	<p>AR6744 Front Upper Control Arm Bush - Inner Front & Rear Mercedes-Benz (R170) SLK200 (M111.958) 2.0 Kompressor, SLK230 (M111.973, M111.978) 2.3 Kompressor (-2000), (W202) C-Class (M111.920/21) C180 1.8 Classic, (M111.941) C200 2.0 Classic, Elegance, C220 (M111.961) 2.2 Classic, Elegance, C230 (M111.974) 2.3 Classic, Elegance, Kompressor, Sport, C240 (M112.910) 2.4 Classic, Elegance, C250D, TD (M605.910) 2.5 5-Cyl., C280 (M104.941) 2.8 6-Cyl. Elegance (94-00), (W208) CLK230 (M111.973/5) 2.3 Kompressor, CLK320 (M112.940) 3.2 V6 Cabrio (98-05), (W209) CLK320 (M112.940) 3.2 V6 Elegance, Cabrio (98-05), (W210) E-Class E200K (M111.957) 2.0, E230 (M111.970) 2.3, E240 (M112.911) 2.4, E280 (M112.921) 2.8 V6, E320 (M104.995, M112.941) 3.2 V6, E430 (M113.940) 4.3 V8 (96-02)</p>		<p>AR6762 Engine Mounting - RHS Nissan Primera (SR16DE) 160 SE, Si (98-02)</p>
 <p>ID: 18, OD: 38, L: 50</p>	<p>AR6745 Front Lower Control Arm Bush - Inner Front Nissan Maxima (GV) (VG30E) 300SE 6-Cyl. (91-97)</p>		<p>AR6763 Engine Mounting - RHS Nissan Primera (SR20DE) 200 GSi, Si, STi, Elegance, Luxury (98-02)</p>
 <p>ID: 21, L: 50.5, H: 56, W: 52.5</p>	<p>AR6746 Front Lower Control Arm Bush - Outer Rear Nissan Maxima (GV) (VG30E) 300SE 6-Cyl. (91-97)</p>		<p>AR6764 Engine Mounting - LHS Nissan Primera (SR20DE) 200 GSi, Si, STi, Elegance, Luxury Man. (98-02)</p>
 <p>ID: 32, L: 30, H: 54, W: 52</p>	<p>AR6747 Front Stabilizer Bar Bush Nissan Maxima (GV) (VG30E) 300SE 6-Cyl. (91-97)</p>		<p>AR6765 Front Strut Mounting Renault Megane I (K4M, K7M) 1.6 Classic RT, Classic RXE, Classic RXT, RN Hatch, RSi Coupe, RT Cabriolet, RT Coupe, RT Hatch, RXE, RXE Cab., RXi Cab., RXT, (F3R) 2.0 Cabriolet, RSi Cabriolet, RXE Classic, (F3R, F7R) 2.0 Coupe 16V/8V, RSi Coupe, RXE (96-02), Scenic I 1.4 RTE MPV, 1.6 RT, RXE MPV, 2.0 RXE, RXi MPV (98-02)</p>
 <p>ID: 43, L: 33, H: 58, W: 67</p>	<p>AR6748 Steering Rack Mounting - RHS Nissan Maxima (GV) (VG30E) 300SE 6-Cyl. (91-97)</p>		<p>AR6766 Engine Mounting - Front Nissan Primera (SR20DE) 200 GSi, Si, STi, Elegance, Luxury (98-02) - Man. Models</p>
 <p>ID: 43, L: 33, H: 58, W: 67</p>	<p>AR6749 Steering Rack Mounting - LHS Nissan Maxima (GV) (VG30E) 300SE 6-Cyl. (91-97)</p>		<p>AR6767 Engine Mounting - Front Nissan Primera (SR20DE) 200 GSi, Si, STi, Elegance, Luxury (98-02) - Auto. Models</p>
 <p>ID: 20, L: 24, H: 43.5, W: 40</p>	<p>AR6772 Front Stabilizer Bar Bush Nissan Primera (SR16DE) 160 SE, Si, (SR20DE) 200 GSi, Si, STi, Elegance, Luxury (98-02)</p>		<p>AR6768 Engine Mounting - Rear Nissan Primera (SR16DE) 160 SE, Si Auto. (98-02), (SR20DE) 200 GSi, Si, STi, Elegance, Luxury Auto. (98-02)</p>
	<p>AR6769 Engine Mounting - LHS Nissan Primera (SR16DE) 160 SE, Si Auto. (98-02), (SR20DE) 200 GSi, Si, STi, Elegance, Luxury Auto. (98-02)</p>		<p>AR6772 Front Stabilizer Bar Bush Nissan Primera (SR16DE) 160 SE, Si, (SR20DE) 200 GSi, Si, STi, Elegance, Luxury (98-02)</p>

ENGINE MOUNTING & RUBBER

BUYERS GUIDE

	<p>AR6818 Engine Mounting - Rear</p> <p>Renault Kangoo (E7J) 1.4 Multix Authentique MPV, Express Van Pet. (01-10)</p>		<p>AR6840 Engine Mounting - LHS</p> <p>Opel Astra G (C16SEL) 1.6 Classic CD, Classic CDE, Comfort, CS, Elegance, (X18XE1) 1.8 Caravan CD S/W, Classic CDE, CSE, Elegance, Irmscher, Sport (99-04), Zafira I (X18XE1) 1.8i CD Elegance MPV (01-05)</p>
	<p>AR6819 Front Lower Control Arm Bush - Outer Rear</p> <p>Renault Clio IV (H4B) 0.9T TCe 90, (D4F, H5F) 1.2, (M5M) 1.6 RS (2013-), Kangoo (K7M) 1.6 (03-13), Megane II (E7J, K4J) 1.4 Authentique, (K9K) 1.5dCi Authentique, Shake It!, (K4M) 1.6, CC Dynamique, Expression, Cabrio, Coupe, Privilege, (K4M) 1.6 Authentique, Shake It!, (K4M) 1.6 Classic, Expression, Privilege, (F9Q) 1.9dCi, CC Dynamique, DCi Privilege, Dynamique, '+', 2.0, CC Privilege, Classic Dynamique, (F7R) 2.0T Sport, F1 Team (02-10), Megane III 2.0i Coupe RS250 Cup, Sport, (F4R) 2.0 RS265, 2.0 RB7 (2010-), Scenic II (K4J) 1.4 Authentique, (K4M) 1.6 Authentique, Expression, (F9Q) 1.9dCi Expression, Dynamique Dies., (F4R) 2.0 Dynamique, Privilege MPV (02-10), Grand Scenic II (F9Q740) 1.9dCi Privilege JA05, (F4R) 2.0 Expression MPV (05-10)</p>		<p>AR6841 Engine Mounting - RHS</p> <p>Opel Astra G (C16SEL) 1.6 Classic CD, Classic CDE, Comfort, CS, Elegance, (X18XE1) 1.8 Caravan CD S/W, Classic CDE, CSE, Elegance, Irmscher, Sport, (X20XEV) 2.0 Classic CDX, Coupe', CSX (99-04), Zafira I (X18XE1) 1.8i CD Elegance MPV, (X20XEV) 2.0 OPC MPV, (Z22SE) 2.2i Elegance MPV (01-05)</p>
	<p>AR6820 Front Stabilizer Bar Bush</p> <p>Opel Astra H (Z14XEP) 1.4 Essentia, (Z16XEP) 1.6 Enjoy, Essentia, (Z18XER) 1.8 Enjoy, Sport, GTC, GTC, Sport, (Z19DT) 1.9 CDTi Enjoy, GTC, Sport, (Z20LER) 2.0 Coupe' Turbo, GSi, GTC Turbo, OPC, Turbo Sport, GTC Turbo Sport (04-10), Zafira II (Z16XEP) 1.6 Essentia MPV, (Z18XEP) 1.8i Enjoy, CD, Elegance MPV, (Z20LEX) 2.0 OPC MPV, 2.2i Enjoy, Elegance MPV (05-09)</p>		<p>AR6842 Engine Mounting - Front</p> <p>Opel Astra G (X20XEV) 2.0 Classic CDX, Coupe', CSX (99-04), Zafira I (X18XE1) 1.8i CD Elegance MPV, (X20XEV) 2.0 OPC MPV, (Z22SE) 2.2i Elegance MPV (01-05)</p>
	<p>AR6828 Front Stabilizer Bar Bush</p> <p>Opel Astra F (14NV) 140, i, iS, (16NZ) 160, i, Estate, iE, iS OHC, (18XE) 180i 18SE/XL iE OHC (93-99), Kadett (14NE) 140, S, (16NZ) 160i S, (18SE) 180i, iE (93-99)</p>		<p>AR6843 Engine Mounting - LHS</p> <p>Opel Astra G (X20XEV) 2.0 Classic CDX, Coupe', CSX (99-04), Zafira I (X20XEV) 2.0 OPC MPV, (Z22SE) 2.2i Elegance MPV (01-05)</p>
	<p>AR6834 Rear Axle Beam / Carrier Bush</p> <p>Daewoo Cielo 1.5 GL, GLX, GTX, 150i, L (96-99), Espero (C18LE) 1.8 CD, (C20LE) 2.0 CD (96-98), Lanos (C14L) 1.3i S SOHC, (616L, Y6) 1.6 SX DOHC (97-03), Lanos II 1.4 S SOHC, 1.6 SX DOHC (97-03); Opel Astra F (14NV) 140, i, iS, (16NZ) 160, i, Estate, iE, iS OHC, (18XE) 180i 18SE/XL iE OHC, (20SE) 200i, Estate, iE, (20XE) tS (93-99), Kadett (NV) 1.3 Cub, GL, LS, Rebel 5-Spd. Man., (14NV) 140 CL 5-Spd., Cub 4-Spd. Man. (80-93), (16SV) 1.6 L, GL, GLS, GSE, Rebel, 160 Cub, 160 GSE, (16NZ) GSi, i, (16NZ) Aspen, L, (16SH) GL, 1.8 (18SV) GLX, (18E) GSi, (L18LV) SE, 2.0 GSi, 200 Boss, Super Boss, CD, (20SEH) GSi 8V, (20XE, 20SHE) GSi 16V (84-93), Kadett (14NE) 140, S, (16NZ) 160i S, (18SE) 180i, iE, (20SE) 200iS, (20XE) tS (93-99), Monza (16SV) 160 CLS, GLS, (16SE) GSi, i Aspen, (18SV) 1.8 CLX, GLE, Convertible, (18SE) GLi, GLX, (20SV) 2.0 Cabrio, CLi, (20SE/SV) 2.0 XE CD, CLE, GLE, GLi (86-93)</p>		<p>AR6846 Front Lower Control Arm Bush - Outer Rear</p> <p>Opel Astra G (C16SEL) 1.6 Classic CD, Classic CDE, Comfort, CS, Elegance, (X18XE1) 1.8 Caravan CD S/W, Classic CDE, CSE, Elegance, Irmscher, Sport, (X20XEV) 2.0 Classic CDX, Coupe', CSX (99-04), Zafira I (X18XE1) 1.8i CD Elegance MPV, (X20XEV) 2.0 OPC MPV, (Z22SE) 2.2i Elegance MPV (01-05)</p>
	<p>AR6837 Front Stabilizer Bar Bush</p> <p>Opel Kadett (20SE) 200iS, (20XE) tS (93-99)</p>		<p>AR6848 Front Strut Mounting (without Bearing)</p> <p>Opel Astra G (C16SEL) 1.6 Classic CD, Classic CDE, Comfort, CS, Elegance, (X18XE1) 1.8 Caravan CD S/W, Classic CDE, CSE, Elegance, Irmscher, Sport, (X20XEV) 2.0 Classic CDX, Coupe', CSX (99-04), Corsa C (14NE) 140i Classic Comfort, Chill, Club, Sport, Lite, Lite+, S, Lite Sport, Sedan, Hatch, (16SE) 1.6i Elegance, Sport, Classic, Elegance Sedan, Hatch, (X17D) 1.7i DTi Hatch, Classic Elegance Sedan, Hatch Dies., 1.8i Hatch GSi, Classic Executive Sedan, Hatch (03-08), Corsa LDV II (14XE) 1.4i Utility S, Sport, Club, P/up Pet., (Y17DT) 1.7D Utility, Sport, Club DTi P/up Dies., (Z18XEL) 1.8i Utility, Sport, Club, P/up (02-10), Corsa Combo P/van (Z14XEP) 1.4i Pet. (05-12), Corsa Combo P/van (Z14XEP) 1.4i Pet. (05-12), Meriva (Z14XEP) 1.4 Essentia MPV, (A14NEL, B14NEL) 1.4T, (Z16XE/P) 1.6 Club, Comfort, Enjoy MPV, (Z17DT/H/R) 1.7 CDTi Elegance, Enjoy, (Z18XE) 1.8 Elegance, Easytronic MPV (03-15), Zafira I (X18XE1) 1.8i CD Elegance MPV, (X20XEV) 2.0 OPC MPV, (Z22SE) 2.2i Elegance MPV (01-05)</p>
	<p>AR6838 Engine Mounting - Front</p> <p>Opel Astra G (C16SEL) 1.6 Classic CD, Classic CDE, Comfort, CS, Elegance, (X18XE1) 1.8 Caravan CD S/W, Classic CDE, CSE, Elegance, Irmscher, Sport, (X20XEV) 2.0 Classic CDX, Coupe', CSX (99-04)</p>		<p>AR6848B Front Strut Mounting (with Bearing)</p> <p>Opel Astra G (C16SEL) 1.6 Classic CD, Classic CDE, Comfort, CS, Elegance, (X18XE1) 1.8 Caravan CD S/W, Classic CDE, CSE, Elegance, Irmscher, Sport, (X20XEV) 2.0 Classic CDX, Coupe', CSX (99-04), Corsa C (14NE) 140i Classic Comfort, Chill, Club, Sport, Lite, Lite+, S, Lite Sport, Sedan, Hatch, (16SE) 1.6i Elegance, Sport, Classic, Elegance Sedan, Hatch, (X17D) 1.7i DTi Hatch, Classic Elegance Sedan, Hatch Dies., 1.8i Hatch GSi, Classic Executive Sedan, Hatch (03-08), Corsa LDV II (14XE) 1.4i Utility S, Sport, Club, P/up Pet., (Y17DT) 1.7D Utility, Sport, Club DTi P/up Dies., (Z18XEL) 1.8i Utility, Sport, Club, P/up (02-10), Corsa Combo P/van (Z14XEP) 1.4i Pet. (05-12), Corsa Combo P/van (Z14XEP) 1.4i Pet. (05-12), Meriva (Z14XEP) 1.4 Essentia MPV, (A14NEL, B14NEL) 1.4T, (Z16XE/P) 1.6 Club, Comfort, Enjoy MPV, (Z17DT/H/R) 1.7 CDTi Elegance, Enjoy, (Z18XE) 1.8 Elegance, Easytronic MPV (03-15), Zafira I (X18XE1) 1.8i CD Elegance MPV, (X20XEV) 2.0 OPC MPV, (Z22SE) 2.2i Elegance MPV (01-05)</p>
	<p>AR6839 Engine Mounting - Rear</p> <p>Opel Astra G (C16SEL) 1.6 Classic CD, Classic CDE, Comfort, CS, Elegance, (X18XE1) 1.8 Caravan CD S/W, Classic CDE, CSE, Elegance, Irmscher, Sport, (X20XEV) 2.0 Classic CDX, Coupe', CSX (99-04), Astra H (Z14XEP) 1.4 Essentia, (Z16XEP) 1.6 Enjoy, Essentia, (Z18XER) 1.8 Enjoy, Sport, GTC, GTC, Sport, (Z19DT) 1.9 CDTi Enjoy, GTC, Sport, (Z20LER) 2.0 Coupe' Turbo, GSi, GTC Turbo, OPC, Turbo Sport, GTC Turbo Sport (04-10), Zafira I (X18XE1) 1.8i CD Elegance MPV, (X20XEV) 2.0 OPC MPV, (Z22SE) 2.2i Elegance MPV (01-05), Zafira II (Z16XEP) 1.6 Essentia MPV, (Z18XEP) 1.8i Enjoy, CD, Elegance MPV, (Z20LEX) 2.0 OPC MPV, 2.2i Enjoy, Elegance MPV (05-09)</p>		<p>AR6850 Front X-Member Bush</p> <p>Opel Astra G (C16SEL) 1.6 Classic CD, Classic CDE, Comfort, CS, Elegance, (X18XE1) 1.8 Caravan CD S/W, Classic CDE, CSE, Elegance, Irmscher, Sport, (X20XEV) 2.0 Classic CDX, Coupe', CSX (99-04), Zafira I (X18XE1) 1.8i CD Elegance MPV, (X20XEV) 2.0 OPC MPV, (Z22SE) 2.2i Elegance MPV (01-05)</p>

ENGINE MOUNTING & RUBBER BUYERS GUIDE

	<p>AR6851 Exhaust Hanger - Middle, Rear</p> <p>Opel Astra G (C16SEL) 1.6 Classic CD, Classic CDE, Comfort, CS, Elegance, (X18XE1) 1.8 Caravan CD S/W, Classic CDE, CSE, Elegance, Irmscher, Sport, (X20XE1) 2.0 Classic CDX, Coupe', CSX (99-04), Corsa C (14NE) 140i Classic Comfort, Chill, Club, Sport, Lite, Lite+, S, Lite Sport, Sedan, Hatch, (16SE) 1.6i Elegance, Sport, Classic, Elegance Sedan, Hatch, (X17D) 1.7i DTi Hatch, Classic Elegance Sedan, Hatch Dies., 1.8i Hatch GSi, Classic Executive Sedan, Hatch (03-08), Corsa Pronto P/van (3NE) 1.3i Pet. (99-00), Combo P/van (Z14XEP) 1.4i Pet. (05-12), Omega 2.2i, 2.6i V6 (01-04), Zafira I (X20XE1) 2.0 OPC MPV, (Z22SE) 2.2i Elegance MPV (01-05), Zafira II (Z16XEP) 1.6 Essential MPV, (Z18XEP) 1.8i Enjoy, CD, Elegance MPV, (Z20LEX) 2.0 OPC MPV, 2.2i Enjoy, Elegance MPV (05-09)</p>	 <p>ID: 10, OD: 33.2, L: 82</p>	<p>AR6863 Shackle Bush - Rear Lower</p> <p>Opel Corsa LDV I (13NE) 130i Utility P/up Pet., (14NE) 1.4i Utility, S P/up Pet., (16NE) 1.6i Utility, S, P/up Sport, (X17D) 1.7D Utility P/up Dies. (97-04)</p>
 <p>ID: 12.2, OD: 60/75, H: 90</p>	<p>AR6854 Rear Axle Beam / Carrier Bush</p> <p>Opel Astra G (C16SEL) 1.6 Classic CD, Classic CDE, Comfort, CS, Elegance, (X18XE1) 1.8 Caravan CD S/W, Classic CDE, CSE, Elegance, Irmscher, Sport, (X20XE1) 2.0 Classic CDX, Coupe', CSX (99-04), Corsa Combo P/van (Z14XEP) 1.4i Pet. (05-12), Zafira I (X18XE1) 1.8i CD Elegance MPV, (X20XE1) 2.0 OPC MPV, (Z22SE) 2.2i Elegance MPV (01-05)</p>	 <p>ID: 39, L: 24, H: 48, W: 60</p>	<p>AR6864 Rear Stabilizer Bar Bush</p> <p>Opel Corsa B (13NE) 130 i, Lite, i S, le Chill Sedan, Hatch, (14NE) 140i Classic, Active, Lite, Lite+ Sedan, Hatch, (16SE) 160 i Classic, Sport, S, GSi, GSi Ltd., Classic iE, CD, CDE, S, Sedan, Hatch (96-03), Corsa LDV I (13NE) 130i Utility P/up Pet., (14NE) 1.4i Utility, S P/up Pet., (16NE) 1.6i Utility, S, P/up Sport, (X17D) 1.7D Utility P/up Dies. (97-04)</p>
 <p>ID: 10, OD: 38, L: 52</p>	<p>AR6855 Front Lower Control Arm Bush - Inner Front & Outer Rear</p> <p>Chevrolet Corsa 1.4 AC, Club, Sport, 1.7 DTi, Club, Sport, 1.8 Club, Sport (2010-), Utility 1.3D AC, Club, Sport, 1.4 AC, Club, Sport, 1.8 AC, Club, Sport (2010-); Opel Corsa B (13NE) 130 i, Lite, i S, le Chill Sedan, Hatch, (14NE) 140i Classic, Active, Lite, Lite+ Sedan, Hatch, (16SE) 160 i Classic, Sport, S, GSi, GSi Ltd., Classic iE, CD, CDE, S, Sedan, Hatch (96-03), Corsa LDV I (13NE) 130i Utility P/up Pet., (14NE) 1.4i Utility, S P/up Pet., (16NE) 1.6i Utility, S, P/up Sport, (X17D) 1.7D Utility P/up Dies. (97-04), Corsa Pronto P/van (3NE) 1.3i Pet. (99-00)</p>	 <p>ID: 39, L: 25, H: 48, W: 58</p>	<p>AR6866 Steering Rack Mounting - LHS</p> <p>Opel Corsa B (13NE) 130 i, Lite, i S, le Chill Sedan, Hatch, (14NE) 140i Classic, Active, Lite, Lite+ Sedan, Hatch, (16SE) 160 i Classic, Sport, S, GSi, GSi Ltd., Classic iE, CD, CDE, S, Sedan, Hatch (96-03), Corsa LDV I (13NE) 130i Utility P/up Pet., (14NE) 1.4i Utility, S P/up Pet., (16NE) 1.6i Utility, S, P/up Sport, (X17D) 1.7D Utility P/up Dies. (97-04), Corsa LDV II (14XE) 1.4i Utility S, Sport, Club, P/up Pet., (Y17DT) 1.7D Utility, Sport, Club DTi P/up Dies., (Z18XEL) 1.8i Utility, Sport, Club, P/up (02-10)</p>
 <p>ID: 21, L: 29, H: 32, W: 37.5</p>	<p>AR6856 Front Stabilizer Bar Bush</p> <p>Opel Corsa B (13NE) 130 i, Lite, i S, le Chill Sedan, Hatch, (14NE) 140i Classic, Active, Lite, Lite+ Sedan, Hatch, (16SE) 160 i Classic, Sport, S, GSi, GSi Ltd., Classic iE, CD, CDE, S, Sedan, Hatch (96-03), Corsa LDV I (13NE) 130i Utility P/up Pet., (14NE) 1.4i Utility, S P/up Pet., (16NE) 1.6i Utility, S, P/up Sport, (X17D) 1.7D Utility P/up Dies. (97-04), Corsa Pronto P/van (3NE) 1.3i Pet. (99-00)</p>		<p>AR6867 Steering Rack Mounting - RHS</p> <p>Opel Corsa B (13NE) 130 i, Lite, i S, le Chill Sedan, Hatch, (14NE) 140i Classic, Active, Lite, Lite+ Sedan, Hatch, (16SE) 160 i Classic, Sport, S, GSi, GSi Ltd., Classic iE, CD, CDE, S, Sedan, Hatch (96-03), Corsa LDV I (13NE) 130i Utility P/up Pet., (14NE) 1.4i Utility, S P/up Pet., (16NE) 1.6i Utility, S, P/up Sport, (X17D) 1.7D Utility P/up Dies. (97-04), Corsa LDV II (14XE) 1.4i Utility S, Sport, Club, P/up Pet., (Y17DT) 1.7D Utility, Sport, Club DTi P/up Dies., (Z18XEL) 1.8i Utility, Sport, Club, P/up (02-10)</p>
 <p>ID: 14, OD: 37.4, L: 40</p>	<p>AR6857 Tension Rod Bush</p> <p>Opel Corsa B (13NE) 130 i, Lite, i S, le Chill Sedan, Hatch, (14NE) 140i Classic, Active, Lite, Lite+ Sedan, Hatch, (16SE) 160 i Classic, Sport, S, GSi, GSi Ltd., Classic iE, CD, CDE, S, Sedan, Hatch (96-03), Corsa LDV I (13NE) 130i Utility P/up Pet., (14NE) 1.4i Utility, S P/up Pet., (16NE) 1.6i Utility, S, P/up Sport, (X17D) 1.7D Utility P/up Dies. (97-04) - Pre-Lotus, Corsa Pronto P/van (3NE) 1.3i Pet. (99-00)</p>		<p>AR6868 Steering Rack Mounting - RHS</p> <p>Opel Corsa LDV I (X17D) 1.7D Utility P/up Dies. (97-04)</p>
	<p>AR6858 Exhaust Hanger - Middle</p> <p>Opel Corsa B (13NE) 130 i, Lite, i S, le Chill Sedan, Hatch, (14NE) 140i Classic, Active, Lite, Lite+ Sedan, Hatch, (16SE) 160 i Classic, Sport, S, GSi, GSi Ltd., Classic iE, CD, CDE, S, Sedan, Hatch (96-03)</p>		<p>AR6869 Engine Mounting - LHS</p> <p>Opel Zafira I (Z22SE) 2.2i Elegance MPV Auto. (01-05)</p>
	<p>AR6859 Exhaust Hanger - Rear</p> <p>Opel Corsa B (13NE) 130 i, Lite, i S, le Chill Sedan, Hatch, (14NE) 140i Classic, Active, Lite, Lite+ Sedan, Hatch, (16SE) 160 i Classic, Sport, S, GSi, GSi Ltd., Classic iE, CD, CDE, S, Sedan, Hatch (96-03)</p>		<p>AR6870 Steering Rack Mounting - LHS</p> <p>Opel Kadett 1.8 (18SV) GLX, (18E) GSi, (L18LV) SE, 2.0 SGi, 200 Boss, Super Boss, CD, (20SEH) GSi 8V, (20XE, 20SHE) GSi 16V (84-93), Monza (20SV) 2.0 Cabrio, CLi, (20SE/SV) 2.0 XE CD, CLE, GLE, GLi (86-93) - Vehicles with P/S</p>
 <p>NO PICTURE AVAILABLE AT TIME OF PRINT</p>	<p>AR6861 Exhaust Hanger - Rear</p> <p>Opel Corsa LDV I (13NE) 130i Utility P/up Pet., (14NE) 1.4i Utility, S P/up Pet., (16NE) 1.6i Utility, S, P/up Sport, (X17D) 1.7D Utility P/up Dies. (97-04)</p>		<p>AR6871 Steering Rack Mounting - RHS</p> <p>Opel Kadett 1.8 (18SV) GLX, (18E) GSi, (L18LV) SE, 2.0 SGi, 200 Boss, Super Boss, CD, (20SEH) GSi 8V, (20XE, 20SHE) GSi 16V (84-93), Monza (20SV) 2.0 Cabrio, CLi, (20SE/SV) 2.0 XE CD, CLE, GLE, GLi (86-93) - Vehicles with P/S</p>
 <p>ID: 12, OD: 22, L: 45</p>	<p>AR6862 Shackle Bush - Rear Upper</p> <p>Opel Corsa LDV I (13NE) 130i Utility P/up Pet., (14NE) 1.4i Utility, S P/up Pet., (16NE) 1.6i Utility, S, P/up Sport, (X17D) 1.7D Utility P/up Dies. (97-04)</p>		

ENGINE MOUNTING & RUBBER BUYERS GUIDE

AR6873 Rear Lower Control Arm Bush - Inner

Audi A3 (BVZ) 2.0 FSi, (BMM, CLJA) 2.0 TDi (03-13), (CBFA, CCZA) 2.0 TFSi, (BUB) 3.2 Quattro (04-13); **Seat Altea** (BVG, BVZ) 2.0 FSi, (BMM) 2.0 TDi MPV (06-09); **Leon** (BLR, BLY, BVZ) 2.0 FSi, (BKD, BMM, CFHC, CLCB) 2.0 TDi, (BWA, BWJ, CDLD) 2.0T, FSi (06-09); **Volkswagen Golf V** (BGU) 1.6i Comfortline, Tiptronic, Trendline, (BLS, BXE) 1.9 TDi Comfortline, DSG, (BKD) 2.0 TDi DSG Sport, Sport Tiptronic, Sport 5-Spd. Man., 6-Spd. Auto., (BLX) 2.0i Trendline, GTi DSG, Comfortline, GTi 5-Spd. Man., 6-Spd. Auto., (BLY) 2.0 FSi Sport, Sport Tiptronic 6-Spd. Man., Auto. (04-09); **Golf VI** (CAXA, CAVD) 1.4 TSi Trendline, Comfortline, HighLine, (BSE, BSF, CCSA) 1.6i Trendline, (CAYC) 1.6 TDi Comfortline, DSG, Bluemotion, (CBAB, CFFB) 2.0 TDi HighLine, (CCZB) 2.0 GTi DSG, 2.0 TSi-R 4-Motion, DSG (09-13); **Jetta V** (CAVD, CAXA) 1.4 TSi Trendline, Comfortline, DSG, HighLine, (CAYC) 1.6 TDi Comfortline, DSG (09-11), 1.6i Comfortline, Tiptronic, Trendline, (BKC) 1.9 TDi Comfortline, DSG, (BHY) 2.0i Trendline, DSG, Comfortline, 5-Spd. Man., 6-Spd. Auto., 2.0 FSi, TFSi, Sportline, Tiptronic 6-Spd. Man./Auto. (05-11), (AZV, BKD, BMM) 2.0 TDi Sportline, Tiptronic, HighLine 5-Spd. Man., 6-Spd. Auto., 2.0 TSi HighLine (2005-); **Jetta VI** (CBZB) 1.2 TSi, (CAVD, CAXA) 1.4 TSi, (CAYC) 1.6 TDi, (CFHC, CJAA, CLCB) 2.0 TDi (2011-); **Scirocco** (CAVD) 1.4 TSi, (CDLF) 2.0 TSi, DSG, R (2009-); **Tiguan 4X2, 4X4** (BWK, CAVA) 1.4 TSi Trend&Fun, Track&Field, (CBAB) 2.0 TDi Track&Field, Sport&Style, Trend&Fun, (CCZA) 2.0 TSi Track&Field, Sport&Style, 4-Motion (08-11), (CAXA) 1.4 TSi, (CAVD, CTHD) 1.4 TSi 4-Motion, (CFFD) 2.0 Tdi, (CCZB) 2.0 TSi 4-Motion (11-17); **Touran** (BGU, BSE, BSF) 1.6 5-Spd. Man., (BKC, BLS, BXE) 1.9 TDi MPV TrendLine, DSG, (AZV) 2.0 TDi MPV Comfortline, HighLine, DSG, (BLY) 2.0 FSi MPV HighLine (04-11), (CBZB) 1.2 TSi, (CAVC, CTHC) 1.4 TSi, (CFHF, CLCA) 2.0 TDi (2011-)



ID: 12.2

AR6874 Rear Offset Carrier Bush

Daewoo Cielo 1.5 GL, GLX, GTX, 150i, L (96-99); **Espero** (C18LE) 1.8 CD, (C20LE) 2.0 CD (96-98); **Lanos** (C14L) 1.3i S SOHC, (616L, Y6) 1.6 SX DOHC (97-03); **Lanos II** 1.4 S SOHC, 1.6 SX DOHC (97-03); **Opel Kadett** (NV) 1.3 Cub, GL, LS, Rebel 5-Spd. Man., (14NV) 140 CL 5-Spd., Cub 4-Spd. Man. (80-93), (16SV) 1.6 L, GL, GLS, GSE, Rebel, 160 Cub, 160 GSE, (16NZ) GSi, i, (16NZ) Aspen, L, (16SH) GL, 1.8 (18SV) GLX, (18E) GSi, (L18LV) SE, 2.0 SGi, 200 Boss, Super Boss, CD, (20SEH) GSi 8V, (20XE, 20SHE) GSi 16V (84-93); **Monza** (16SV) 160 CLS, GLS, (16SE) GSi, i Aspen, (18SV) 1.8 CLX, GLE, Convertible, (18SE) GLi, GLX, (20SV) 2.0 Cabrio, CLi, (20SE/SV) 2.0 XE CD, CLE, GLE, GLi (86-93)



AR6883



Front Lower Control Arm Bush - Outer Rear LHS

Audi A3 (BVZ) 2.0 FSi, (BMM, CLJA) 2.0 TDi (03-13), (CBFA, CCZA) 2.0 TFSi, (BUB) 3.2 Quattro (04-13), (CMSA) 1.4 TFSi, (CAYC) 1.6 TDi (08-13); **S3** (CDLC) 2.0 TFSi (07-13); **Seat Altea** (BVG, BVZ) 2.0 FSi, (BMM) 2.0 TDi MPV (06-09); **Leon** (BLR, BLY, BVZ) 2.0 FSi, (BKD, BMM, CFHC, CLCB) 2.0 TDi, (BWA, BWJ, CDLD) 2.0T, FSi (06-09); **Volkswagen Caddy** (BGU) 1.6i Life Van, MPV, (BJB) 1.9 TDi, Life Van, MPV, (BDJ) 2.0 SDi Van (04-16), (CLCA) 2.0 TDi 5-Spd. Man., (CFHC, CLCB) 2.0 TDi (2010-); **CC** (CFGB) 2.0 TDi, (CCZB) 2.0 TSi, (BWS) 3.6 FSi V6 4-Motion (2009-); **Golf V** (BGU) 1.6i Comfortline, Tiptronic, Trendline, (BLS, BXE) 1.9 TDi Comfortline, DSG, (BKD) 2.0 TDi DSG Sport, Sport Tiptronic, Sport 5-Spd. Man., 6-Spd. Auto., (BLX) 2.0i Trendline, GTi DSG, Comfortline, GTi 5-Spd. Man., 6-Spd. Auto., (BLY) 2.0 FSi Sport, Sport Tiptronic 6-Spd. Man., Auto. (04-09); **Golf VI** (CAXA, CAVD) 1.4 TSi Trendline, Comfortline, HighLine, (BSE, BSF, CCSA) 1.6i Trendline, (CAYC) 1.6 TDi Comfortline, DSG, Bluemotion, (CBAB, CFFB) 2.0 TDi HighLine, (CCZB) 2.0 GTi DSG, 2.0 TSi-R 4-Motion, DSG (09-13); **Golf VII** (CJZA) 1.2 TSi, (CMBA, CPVA, CXSA) 1.4 TSi, (CHPA, CPTA) 1.4 TSi, (CRVA, CYKB) 2.0 TDi, (CRBC, CRLB, CRMB, CRUA) 2.0 TDi (2013-); **Jetta V** (CAVD, CAXA) 1.4 TSi Trendline, Comfortline, DSG, HighLine, (CAYC) 1.6 TDi Comfortline, DSG (09-11), 1.6i Comfortline, Tiptronic, Trendline, (BKC) 1.9 TDi Comfortline, DSG, (BHY) 2.0i Trendline, DSG, Comfortline, 5-Spd. Man., 6-Spd. Auto., (BHY) 2.0i Trendline, DSG, Comfortline, 5-Spd. Man., 6-Spd. Auto., 2.0 FSi, TFSi, Sportline, Tiptronic 6-Spd. Man./Auto. (05-11), (AZV, BKD, BMM) 2.0 TDi Sportline, Tiptronic, HighLine 5-Spd. Man., 6-Spd. Auto., 2.0 TSi HighLine (2005-); **Jetta VI** (CBZB) 1.2 TSi, (CAVD, CAXA) 1.4 TSi, (CAYC) 1.6 TDi, (CFHC, CJAA, CLCB) 2.0 TDi (2011-); **Scirocco** (CAVD) 1.4 TSi, (CDLF) 2.0 TSi, DSG, R (2009-); **Tiguan 4X2, 4X4** (BWK, CAVA) 1.4 TSi Trend&Fun, Track&Field, (CBAB) 2.0 TDi Track&Field, Sport&Style, Trend&Fun, (CCZA) 2.0 TSi Track&Field, Sport&Style, 4-Motion (08-11), (CAXA) 1.4 TSi, (CAVD, CTHD) 1.4 TSi 4-Motion, (CFFD) 2.0 Tdi, (CCZB) 2.0 TSi 4-Motion (11-17); **Touran** (BGU, BSE, BSF) 1.6 5-Spd. Man., (BKC, BLS, BXE) 1.9 TDi MPV TrendLine, DSG, (AZV) 2.0 TDi MPV Comfortline, HighLine, DSG, (BLY) 2.0 FSi MPV HighLine (04-11), (CBZB) 1.2 TSi, (CAVC, CTHC) 1.4 TSi, (CFHF, CLCA) 2.0 TDi (2011-)





ID: 22

ENGINE MOUNTING & RUBBER BUYERS GUIDE

 <p>ID: 22</p>	<p>AR6884 Front Lower Control Arm Bush - Outer Rear RHS</p> <p>Audi A3 (BVZ) 2.0 FSi, (BMM, CLJA) 2.0 TDi (03-13), (CBFA, CCZA) 2.0 TFSi, (BUB) 3.2 Quattro (04-13), (CMSA) 1.4 TFSi, (CAYC) 1.6 TDi (08-13), S3 (CDLC) 2.0 TFSi (07-13); Seat Altea (BVY, BVZ) 2.0 FSi, (BMM) 2.0 TDi MPV (06-09), Leon (BLR, BLY, BVZ) 2.0 FSi, (BKD, BMM, CFHC, CLCB) 2.0 TDi, (BWA, BWJ, CDLD) 2.0T, FSi (06-09); Volkswagen Caddy (BGU) 1.6i Life Van, MPV, (BJB) 1.9 TDi, Life Van, MPV, (BDJ) 2.0 SDi Van (04-16), (CLCA) 2.0 TDi 5-Spd. Man., (CFHC, CLCB) 2.0 TDi (2010-), CC (CFGB) 2.0 TDi, (CCZB) 2.0 TSi, (BWS) 3.6 FSi V6 4-Motion (2009-), Golf V (BGU) 1.6i Comfortline, Tiptronic, Trendline, (BLS, BXE) 1.9 TDi Comfortline, DSG, (BKD) 2.0 TDi DSG Sport, Sport Tiptronic, Sport 5-Spd. Man., 6-Spd. Auto., (BLX) 2.0i Trendline, GTi DSG, Comfortline, GTi 5-Spd. Man., 6-Spd. Auto., (BLY) 2.0 FSi Sport, Sport Tiptronic 6-Spd. Man., Auto. (04-09), Golf VI (CAXA, CAVD) 1.4 TSi Trendline, Comfortline, HighLine, (BSE, BSF, CCSA) 1.6i Trendline, (CAYC) 1.6 TDi Comfortline, DSG, Bluemotion, (CBAB, CFFB) 2.0 TDi HighLine, (CCZB) 2.0 GTi DSG, 2.0 TSi-R 4-Motion, DSG (09-13), Golf VII (CJZA) 1.2 TSi, (CMBA, CPVA, CXSA) 1.4 TSi, (CHPA, CPTA) 1.4 TSi, (CRVA, CYKB) 2.0 TDi, (CRBC, CRLB, CRMB, CRUA) 2.0 TDi (2013-), Jetta V (CAVD, CAXA) 1.4 TSi Trendline, Comfortline, DSG, HighLine, (CAYC) 1.6 TDi Comfortline, DSG (09-11), 1.6i Comfortline, Tiptronic, Trendline, (BKC) 1.9 TDi Comfortline, DSG, (BHY) 2.0i Trendline, DSG, Comfortline, 5-Spd. Man., 6-Spd. Auto., (BHY) 2.0i Trendline, DSG, Comfortline, 5-Spd. Man., 6-Spd. Auto., 2.0 FSi, TFSi, Sportline, Tiptronic 6-Spd. Man./Auto. (05-11), (AZV, BKD, BMM) 2.0 TDi Sportline, Tiptronic, HighLine 5-Spd. Man., 6-Spd. Auto., 2.0 TSi HighLine (2005-), Jetta VI (CBZB) 1.2 TSi, (CAVD, CAXA) 1.4 TSi, (CAYC) 1.6 TDi, (CFHC, CJAA, CLCB) 2.0 TDi (2011-), Scirocco (CAVD) 1.4 TSi, (CDLF) 2.0 TSi, DSG, R (2009-), Tiguan 4X2, 4X4 (BWK, CAVA) 1.4 TSi Trend&Fun, Track&Field, (CBAB) 2.0 TDi Track&Field, Sport&Style, Trend&Fun, (CCZA) 2.0 TSi Track&Field, Sport&Style, 4-Motion (08-11), (CAXA) 1.4 TSi, (CAVD, CTHD) 1.4 TSi 4-Motion, (CFFD) 2.0 TDi, (CCZB) 2.0 TSi 4-Motion (11-17), Touran (BGU, BSE, BSF) 1.6 5-Spd. Man., (BKC, BLS, BXE) 1.9 TDi MPV TrendLine, DSG, (AZV) 2.0 TDi MPV Comfortline, HighLine, DSG, (BLY) 2.0 FSi MPV HighLine (04-11), (CBZB) 1.2 TSi, (CAVC, CTHC) 1.4 TSi, (CFHF, CLCA) 2.0 TDi (2011-)</p>
	<p>AR6895 Transmission Mounting - LHS</p> <p>Seat Altea (BVY, BVZ) 2.0 FSi, (BMM) 2.0 TDi MPV Auto. (06-09), Leon (BLR, BLY, BVZ) 2.0 FSi Auto., (BKD, BMM, CFHC, CLCB) 2.0 TDi Auto., (BWA, BWJ, CDLD) 2.0T, FSi Auto. (06-09)</p>
	<p>AR6896 Engine Mounting - Rear Support</p> <p>Audi A3 (BVZ) 2.0 FSi Man., (BMM, CLJA) 2.0 TDi Man. (03-13), (CBFA, CCZA) 2.0 TFSi Man., (BUB) 3.2 Quattro Man. (04-13), (CJZA, CCJZ) 1.2 TFSi, (CXSA) 1.4 TFSi (12-17), (CZCA, CZE) 1.4 TFSi, (CRFC) 2.0 TDi (13-17); Seat Altea (BVY, BVZ) 2.0 FSi Man., (BMM) 2.0 TDi MPV Man. (06-09), Leon (BLR, BLY, BVZ) 2.0 FSi Man., (BKD, BMM, CFHC, CLCB) 2.0 TDi Man., (BWA, BWJ, CDLD) 2.0T, FSi Man. (06-09); Volkswagen Beetle (CBZB) 1.2 TSi, (CZDA) 1.4 TSi (2012-), Caddy (BGU) 1.6i Life Van, MPV, (BJB) 1.9 TDi, Life Van, MPV (04-16), Golf V (BGU) 1.6i Comfortline, Tiptronic, Trendline, (BLS, BXE) 1.9 TDi Comfortline, DSG, (BKD) 2.0 TDi DSG Sport, Sport Tiptronic, Sport 5-Spd. Man., (BLX) 2.0i Trendline, GTi DSG, Comfortline, GTi 5-Spd. Man., (BLY) 2.0 FSi Sport, Sport Tiptronic 6-Spd. Man. (04-09), Golf VI (CAXA, CAVD) 1.4 TSi Trendline, Comfortline, HighLine, Man. (09-13), Jetta V (CAVD, CAXA) 1.4 TSi Trendline, Comfortline, DSG, HighLine, (CAYC) 1.6 TDi Comfortline, DSG (09-11), 1.6i Comfortline, Tiptronic, Trendline, (BKC) 1.9 TDi Comfortline, DSG, Man., (BHY) 2.0i Trendline, DSG, Comfortline, 5-Spd. Man., (BHY) 2.0i Trendline, DSG, Comfortline, 5-Spd. Man., 6-Spd. 2.0 FSi, TFSi, Sportline, Tiptronic 6-Spd. Man. (05-11), (AZV, BKD, BMM) 2.0 TDi Sportline, Tiptronic, HighLine 5-Spd. Man. (2005-), Jetta VI (CBZB) 1.2 TSi (2011-), Passat V (BZB, CDAA) 1.8 TSi Comfortline, DSG, HighLine, (BKC, BLS, BXE) 1.9 TDi Comfortline, DSG, HighLine, (AXX, BLR, BLY, BPY, BVY, BVZ, BWA, CAWB, CBFA, CCZ/TA) 2.0 FSi, TFSi Comfortline, HighLine, (BMP) 2.0 TDi Comfortline, HighLine, DSG, (AXZ) 3.2 FSi Sportline, DSG (05-11) - Man. Models, Scirocco (CAVD) 1.4 TSi (2009-), Tiguan 4X2, 4X4 (BWK, CAVA) 1.4 TSi Trend&Fun, Track&Field (08-11), Touran (BGU, BSE, BSF) 1.6 5-Spd. Man., (BKC, BLS, BXE) 1.9 TDi MPV TrendLine, Man., (AZV) 2.0 TDi MPV Comfortline, HighLine, Man., (BLY) 2.0 FSi Man. MPV HighLine (04-11), (CBZB) 1.2 TSi, (CAVC, CTHC) 1.4 TSi (2011-)</p>

	<p>AR6898 Engine Mounting - Rear Support</p> <p>Audi A3 (BVZ) 2.0 FSi, (BMM, CLJA) 2.0 TDi (03-13), (CBFA, CCZA) 2.0 TFSi, (BUB) 3.2 Quattro (04-13) - Auto. Models, 1.6 TDi, (CDAA) 1.8 TFSi (08-13), (CJSA, CJSB) 1.8 TFSi (12-17), S3 (CDLC) 2.0 TFSi (07-13); Seat Altea (BVY, BVZ) 2.0 FSi, (BMM) 2.0 TDi MPV (06-09) - Auto. Models, Leon (BLR, BLY, BVZ) 2.0 FSi, (BKD, BMM, CFHC, CLCB) 2.0 TDi, (BWA, BWJ, CDLD) 2.0T, FSi (06-09) - Auto. Models, Volkswagen Caddy (BGU) 1.6i Life Van, MPV, (BJB) 1.9 TDi, Life Van, MPV (04-16), (CLCA) 2.0 TDi 5-Spd. Man., (CFHC, CLCB) 2.0 TDi (2010-), CC (CFGB) 2.0 TDi, (CCZB) 2.0 TSi, (BWS) 3.6 FSi V6 4-Motion (2009-), Golf V (BGU) 1.6i Comfortline, Tiptronic, Trendline, (BLS, BXE) 1.9 TDi Comfortline, DSG, (BKD) 2.0 TDi DSG Sport, Sport Tiptronic, Sport, 6-Spd. Auto., (BLX) 2.0i Trendline, GTi DSG, Comfortline, GTi, 6-Spd. Auto., (BLY) 2.0 FSi Sport, Sport Tiptronic 6-Spd. Auto. (04-09), Golf VI (BSE, BSF, CCSA) 1.6i Trendline Auto., (CAYC) 1.6 TDi Comfortline, DSG, Bluemotion, Auto., (CCZB) 2.0 GTi DSG, 2.0 TSi-R 4-Motion, DSG (09-13), Golf VII (CRVA, CYKB) 2.0 TDi, (CRBC, CRLB, CRMB, CRUA) 2.0 TDi (2013-), Jetta V (CAYC) 1.6 TDi Comfortline, DSG (09-11), 1.6i Comfortline, Tiptronic, Trendline, (BKC) 1.9 TDi Comfortline, DSG, (BHY) 2.0i Trendline, DSG, Comfortline, 6-Spd. Auto., 2.0 FSi, Sportline, Tiptronic 6-Spd. Auto., 2.0 TFSi, Sportline, Tiptronic 6-Spd. Auto. (05-11), (AZV, BKD, BMM) 2.0 TDi Sportline, Tiptronic, HighLine 6-Spd. Auto., 2.0 TSi HighLine (2005-), Jetta VI (CAVD, CAXA) 1.4 TSi, (CAYC) 1.6 TDi, (CFHC, CJAA, CLCB) 2.0 TDi (2011-), Passat V (BZB, CDAA) 1.8 TSi Comfortline, DSG, HighLine, (BKC, BLS, BXE) 1.9 TDi Comfortline, DSG, HighLine, (AXX, BLR, BLY, BPY, BVY, BVZ, BWA, CAWB, CBFA, CCZ/TA) 2.0 FSi, TFSi Comfortline, HighLine, (BMP) 2.0 TDi Comfortline, HighLine, DSG, (AXZ) 3.2 FSi Sportline, DSG (05-11) - Auto. Models, Scirocco (CDLF) 2.0 TSi, DSG, R (2009-), Tiguan 4X2, 4X4 (CBAB) 2.0 TDi Track&Field, Sport&Style, Trend&Fun, (CCZA) 2.0 TSi Track&Field, Sport&Style, 4-Motion (08-11), Touran (BGU, BSE, BSF) 1.6, (BKC, BLS, BXE) 1.9 TDi MPV TrendLine, DSG, (AZV) 2.0 TDi MPV Comfortline, HighLine, DSG, (BLY) 2.0 FSi MPV HighLine (04-11) - Auto. Models, (CFHF, CLCA) 2.0 TDi (2011-)</p>
---	--

ENGINE MOUNTING & RUBBER BUYERS GUIDE

 <p>ID: 12, OD: 40, L: 54</p>	<p>AR6899 Front Lower Control Arm Bush - Inner Front</p> <p>Audi A3 (BVZ) 2.0 FSi, (BMM, CLJA) 2.0 TDi (03-13), (CBFA, CCZA) 2.0 TFSi, (BUB) 3.2 Quattro (04-13), (CMSA) 1.4 TFSi, (CAYC) 1.6 TDi (08-13), (CJZA, CCJZ) 1.2 TFSi, (CXSA) 1.4 TFSi, (CLHA) 1.6 TDi, (CJSA, CJSB) 1.8 TFSi, (DAGA) 2.0 TDi (12-17), (CZCA, CZEA) 1.4 TFSi, (CRFC) 2.0 TDi (13-17), S3 (CDLC) 2.0 TFSi (07-13), (CJXB) 2.0 TFSi (13-17); Seat Altea (BVY, BVZ) 2.0 FSi, (BMM) 2.0 TDi MPV (06-09), Leon (BLR, BLY, BVZ) 2.0 FSi, (BKD, BMM, CFHC, CLCB) 2.0 TDi, (BWA, BWJ, CDLD) 2.0T, FSi (06-09); Volkswagen Beetle (CBZB) 1.2 TSi, (CZDA) 1.4 TSi (2012-), Caddy (BGU) 1.6i Life Van, MPV, (BJB) 1.9 TDi, Life Van, MPV, (BDJ) 2.0 SDi Van (04-16), (CLCA) 2.0 TDi 5-Spd. Man., (CFHC, CLCB) 2.0 TDi (2010-), CC (CFGB) 2.0 TDi, (CCZB) 2.0 TSi, (BWS) 3.6 FSi V6 4-Motion (2009-), Golf V (BGU) 1.6i Comfortline, Tiptronic, Trendline, (BLS, BXE) 1.9 TDi Comfortline, DSG, (BKD) 2.0 TDi DSG Sport, Sport Tiptronic, Sport 5-Spd. Man., 6-Spd. Auto., (BLX) 2.0i Trendline, GTi DSG, Comfortline, GTi 5-Spd. Man., 6-Spd. Auto., (BLY) 2.0 FSi Sport, Sport Tiptronic 6-Spd. Man., Auto. (04-09), Golf VI (CAXA, CAVD) 1.4 TSi Trendline, Comfortline, HighLine, (BSE, BSF, CCSA) 1.6i Trendline, (CAYC) 1.6 TDi Comfortline, DSG, Bluemotion, (CBAB, CFFB) 2.0 TDi HighLine, (CCZB) 2.0 GTi DSG, 2.0 TSi-R 4-Motion, DSG (09-13), Golf VII (CJZA) 1.2 TSi, (CMBA, CPVA, CXSA) 1.4 TSi, (CHPA, CPTA) 1.4 TSi, (CRVA, CYKB) 2.0 TDi, (CRBC, CRLB, CRMB, CRUA) 2.0 TDi (2013-), Jetta V (CAVD, CAXA) 1.4 TSi Trendline, Comfortline, DSG, HighLine, (CAYC) 1.6 TDi Comfortline, DSG (09-11), 1.6i Comfortline, Tiptronic, Trendline, (BKC) 1.9 TDi Comfortline, DSG, (BHY) 2.0i Trendline, DSG, Comfortline, 5-Spd. Man., 6-Spd. Auto., (BHY) 2.0i Trendline, DSG, Comfortline, 5-Spd. Man., 6-Spd. Auto., 2.0 FSi, TFSi, Sportline, Tiptronic 6-Spd. Man./Auto. (05-11), (AZV, BKD, BMM) 2.0 TDi Sportline, Tiptronic, HighLine 5-Spd. Man., 6-Spd. Auto., 2.0 TSi HighLine (2005-), Jetta VI (CBZB) 1.2 TSi, (CAVD, CAXA) 1.4 TSi, (CAYC) 1.6 TDi, (CFHC, CJAA, CLCB) 2.0 TDi (2011-), Passat V (BZB, CDA) 1.8 TSi Comfortline, DSG, HighLine, (BKC, BLS, BXE) 1.9 TDi Comfortline, DSG, HighLine, (AXX, BLR, BLY, BPY, BVZ, BWA, CAWB, CBFA, CCZ/TA) 2.0 FSi, TFSi Comfortline, HighLine, (BMP) 2.0 TDi Comfortline, HighLine, DSG, (AXZ) 3.2 FSi Sportline, DSG (05-11), Passat (CDA) 1.8 TSi, (CFFB) 2.0 TDi (11-16), Scirocco (CAVD) 1.4 TSi, (CDLF) 2.0 TSi, DSG, R (2009-), Tiguan 4X2, 4X4 (BWK, CAVA) 1.4 TSi Trend&Fun, Track&Field, (CBAB) 2.0 TDi Track&Field, Sport&Style, Trend&Fun, (CCZA) 2.0 TSi Track&Field, Sport&Style, 4-Motion (08-11), (CAXA) 1.4 TSi, (CAVD, CTHD) 1.4 TSi 4-Motion, (CFFD) 2.0 TDi, (CCZB) 2.0 TSi 4-Motion (11-17), Touran (BGU, BSE, BSF) 1.6 5-Spd. Man., (BKC, BLS, BXE) 1.9 TDi MPV TrendLine, DSG, (AZV) 2.0 TDi MPV Comfortline, HighLine, DSG, (BLY) 2.0 FSi MPV HighLine (04-11), (CBZB) 1.2 TSi, (CAVC, CTHC) 1.4 TSi, (CFHF, CLCA) 2.0 TDi (2011-)</p>
	<p>AR6900 Steering Coupling</p> <p>Toyota Stallion (KF50) (5K) 1.5 Commuter, P/up, SR5 P/up, Bus, P/van Pet., 4/5-Spd. Man. (87-90)</p>

 <p>ID: 12, OD: 37.8, W: 50</p>	<p>AR6901 Rear Lower Control Arm Bush - Outer</p> <p>Audi A3 (BVZ) 2.0 FSi, (BMM, CLJA) 2.0 TDi (03-13), (CBFA, CCZA) 2.0 TFSi, (BUB) 3.2 Quattro (04-13), (CMSA) 1.4 TFSi, (CAYC) 1.6 TDi, (CDA) 1.8 TFSi, (BXE) 1.9 TDi, (CLJA) 2.0 TDi (08-13); Seat Altea (BVY, BVZ) 2.0 FSi, (BMM) 2.0 TDi MPV (06-09), Leon (BLR, BLY, BVZ) 2.0 FSi, (BKD, BMM, CFHC, CLCB) 2.0 TDi, (BWA, BWJ, CDLD) 2.0T, FSi (06-09); Volkswagen Golf V (BGU) 1.6i Comfortline, Tiptronic, Trendline, (BLS, BXE) 1.9 TDi Comfortline, DSG, (BKD) 2.0 TDi DSG Sport, Sport Tiptronic, Sport 5-Spd. Man., 6-Spd. Auto., (BLX) 2.0i Trendline, GTi DSG, Comfortline, GTi 5-Spd. Man., 6-Spd. Auto., (BLY) 2.0 FSi Sport, Sport Tiptronic 6-Spd. Man., Auto. (04-09), Golf VI (CAXA, CAVD) 1.4 TSi Trendline, Comfortline, HighLine, (BSE, BSF, CCSA) 1.6i Trendline, (CAYC) 1.6 TDi Comfortline, DSG, Bluemotion, (CBAB, CFFB) 2.0 TDi HighLine, (CCZB) 2.0 GTi DSG, 2.0 TSi-R 4-Motion, DSG (09-13), Jetta V (CAVD, CAXA) 1.4 TSi Trendline, Comfortline, DSG, HighLine, (CAYC) 1.6 TDi Comfortline, DSG (09-11), 1.6i Comfortline, Tiptronic, Trendline, (BKC) 1.9 TDi Comfortline, DSG, (BHY) 2.0i Trendline, DSG, Comfortline, 5-Spd. Man., 6-Spd. Auto., (BHY) 2.0i Trendline, DSG, Comfortline, 5-Spd. Man., 6-Spd. Auto., 2.0 FSi, TFSi, Sportline, Tiptronic 6-Spd. Man./Auto. (05-11), (AZV, BKD, BMM) 2.0 TDi Sportline, Tiptronic, HighLine 5-Spd. Man., 6-Spd. Auto., 2.0 TSi HighLine (2005-), Jetta VI (CBZB) 1.2 TSi, (CAVD, CAXA) 1.4 TSi, (CAYC) 1.6 TDi, (CFHC, CJAA, CLCB) 2.0 TDi (2011-), Scirocco (CAVD) 1.4 TSi, (CDLF) 2.0 TSi, DSG, R (2009-), Tiguan 4X2, 4X4 (BWK, CAVA) 1.4 TSi Trend&Fun, Track&Field, (CBAB) 2.0 TDi Track&Field, Sport&Style, Trend&Fun, (CCZA) 2.0 TSi Track&Field, Sport&Style, 4-Motion (08-11), (CAXA) 1.4 TSi, (CAVD, CTHD) 1.4 TSi 4-Motion, (CFFD) 2.0 TDi, (CCZB) 2.0 TSi 4-Motion (11-17), Touran (BGU, BSE, BSF) 1.6 5-Spd. Man., (BKC, BLS, BXE) 1.9 TDi MPV TrendLine, DSG, (AZV) 2.0 TDi MPV Comfortline, HighLine, DSG, (BLY) 2.0 FSi MPV HighLine (04-11), (CBZB) 1.2 TSi, (CAVC, CTHC) 1.4 TSi, (CFHF, CLCA) 2.0 TDi (2011-)</p>
 <p>ID: 49, L: 37, H: 61, W: 50</p>	<p>AR6902 Steering Rack Mounting - RHS</p> <p>Toyota Stallion (YF50) (2Y) 1.8 P/up, (2Y) 1.8 SR5 P/up, P/van, Pet., (LF50) (2L) 2400D P/up Dies. (91-04) - M/S, Venture (YF50) (2Y) 1.8 P/van, 8/10-Seater Pet., 4/5-Spd. Man., (YF51) (4Y) 2.2 10-Seater, Getaway 5-Seater, GLE 9-Seater Pet. 5-Spd. Man., (LF50) (2L) 2.4 10-Seater Dies. 5-Spd. Man. (91-04) - M/S</p>
 <p>ID: 47, L: 33, H: 67, W: 71</p>	<p>AR6903 Steering Rack Mounting - LHS</p> <p>Toyota Stallion (YF50) (2Y) 1.8 P/up, (2Y) 1.8 SR5 P/up, P/van, Pet., (LF50) (2L) 2400D P/up Dies. (91-04) - M/S, Venture (YF50) (2Y) 1.8 P/van, 8/10-Seater Pet., 4/5-Spd. Man., (YF51) (4Y) 2.2 10-Seater, Getaway 5-Seater, GLE 9-Seater Pet. 5-Spd. Man., (LF50) (2L) 2.4 10-Seater Dies. 5-Spd. Man. (91-04) - M/S</p>
 <p>ID: 50, L: 31, H: 60, W: 66</p>	<p>AR6905 Steering Rack Mounting - L/RHS</p> <p>Toyota Condor (2Y) 1.8 Estate, TE Estate MPV Pet., 2.0i Estate, TE, Estate MPV, (2RZ-E) 2.4i Estate, TE, TX Estate MPV Pet. (00-05), Condor 4X2, 4X4 (2RZ-E) 2.4i Estate, TX Estate MPV Pet., 5-Spd. Man., (5L) 3.0 SWB Estate, TX Estate MPV Dies., (5L) 3.0 Estate, TE Estate MPV Dies. 5-Spd. Man. (00-05), Stallion (YF50) (2Y) 1.8 P/up, (2Y) 1.8 SR5 P/up, P/van, Pet., (LF50) (2L) 2400D P/up Dies. (91-04) - P/S, Venture (YF50) (2Y) 1.8 P/van, 8/10-Seater Pet., 4/5-Spd. Man., (YF51) (4Y) 2.2 10-Seater, Getaway 5-Seater, GLE 9-Seater Pet. 5-Spd. Man., (LF50) (2L) 2.4 10-Seater Dies. 5-Spd. Man. (91-04) - P/S</p>
 <p>ID: 15 NO THREAD</p>	<p>AR6906 Lower Subframe Bush / Mounting</p> <p>Seat Altea (BVY, BVZ) 2.0 FSi, (BMM) 2.0 TDi MPV Man. (06-09), Leon (BLR, BLY, BVZ) 2.0 FSi Man., (BKD, BMM, CFHC, CLCB) 2.0 TDi Man., (BWA, BWJ, CDLD) 2.0T, FSi Man. (06-09)</p>
	<p>AR6907 Transmission Mounting - LHS</p> <p>Seat Altea (BMM) 2.0 TDi MPV Man. (06-09), Leon (BKD, BMM, CFHC, CLCB) 2.0 TDi Man. (06-09)</p>

ENGINE MOUNTING & RUBBER BUYERS GUIDE

	AR6908 Upper Subframe Bush / Mounting
 <p>WITH THREAD</p>	<p>Audi A3 (BVZ) 2.0 FSi, (BMM, CLJA) 2.0 TDi (03-13), (CBFA, CCZA) 2.0 TFSi, (BUB) 3.2 Quattro (04-13), (CJZA, CCJZ) 1.2 TFSi, (CXSA) 1.4 TFSi, (CLHA) 1.6 TDi, (CJSA, CJSB) 1.8 TFSi, (DAGA) 2.0 TDi (12-17), (CZCA, CZEA) 1.4 TFSi, (CRFC) 2.0 TDi (13-17), S3 (CDLC) 2.0 TFSi (07-13); Seat Altea (BVY, BVZ) 2.0 FSi, (BMM) 2.0 TDi MPV (06-09), Leon (BLR, BLY, BVZ) 2.0 FSi, (BKD, BMM, CFHC, CLCB) 2.0 TDi, (BWA, BWJ, CDLD) 2.0T, FSi (06-09) - Auto. Models; Volkswagen Beetle (CBZB) 1.2 TSi, (CZDA) 1.4 TSi (2012-), Caddy (BGU) 1.6i Life Van, MPV, (BJB) 1.9 TDi, Life Van, MPV, (BDJ) 2.0 SDi Van (04-16), (CLCA) 2.0 TDi 5-Spd. Man., (CFHC, CLCB) 2.0 TDi (2010-), CC (CFGB) 2.0 TDi, (CCZB) 2.0 TSi, (BWS) 3.6 FSi V6 4-Motion (2009-), Golf V (BGU) 1.6i Comfortline, Tiptronic, Trendline, (BLS, BXE) 1.9 TDi Comfortline, DSG, (BKD) 2.0 TDi DSG Sport, Sport Tiptronic, Sport 5-Spd. Man., 6-Spd. Auto., (BLX) 2.0i Trendline, GTi DSG, Comfortline, GTi 5-Spd. Man., 6-Spd. Auto., (BLY) 2.0 FSi Sport, Sport Tiptronic 6-Spd. Man., Auto. (04-09), Golf VI (CAXA, CAVD) 1.4 TSi Trendline, Comfortline, HighLine, (BSE, BSF, CCSA) 1.6i Trendline, (CAYC) 1.6 TDi Comfortline, DSG, Bluemotion, (CBAB, CFFB) 2.0 TDi HighLine, (CCZB) 2.0 GTi DSG, 2.0 TSi-R 4-Motion, DSG (09-13), Golf VII (CJZA) 1.2 TSi, (CMBA, CPVA, CXSA) 1.4 TSi, (CHPA, CPTA) 1.4 TSi, (CRVA, CYKB) 2.0 TDi, (CRBC, CRLB, CRMB, CRUA) 2.0 TDi (2013-), Jetta V (CAVD, CAXA) 1.4 TSi Trendline, Comfortline, DSG, HighLine, (CAYC) 1.6 TDi Comfortline, DSG (09-11), 1.6i Comfortline, Tiptronic, Trendline, (BKC) 1.9 TDi Comfortline, DSG, (BHY) 2.0i Trendline, DSG, Comfortline, 5-Spd. Man., 6-Spd. Auto., (BHY) 2.0i Trendline, DSG, Comfortline, 5-Spd. Man., 6-Spd. Auto., 2.0 FSi, TFSi, Sportline, Tiptronic 6-Spd. Man./Auto. (05-11), (AZV, BKD, BMM) 2.0 TDi Sportline, Tiptronic, HighLine 5-Spd. Man., 6-Spd. Auto., 2.0 TSi HighLine (2005-), Jetta VI (CBZB) 1.2 TSi, (CAVD, CAXA) 1.4 TSi, (CAYC) 1.6 TDi, (CFHC, CJAA, CLCB) 2.0 TDi (2011-), Passat V (BZB, CDA) 1.8 TSi Comfortline, DSG, HighLine, (BKC, BLS, BXE) 1.9 TDi Comfortline, DSG, HighLine, (AXX, BLR, BLY, BPY, BVY, BVZ, BWA, CAWB, CBFA, CCZ/TA) 2.0 FSi, TFSi Comfortline, HighLine, (BMP) 2.0 TDi Comfortline, HighLine, DSG, (AXZ) 3.2 FSi Sportline, DSG (05-11), Passat (CDA) 1.8 TSi, (CFFB) 2.0 TDi (11-16), Scirocco (CAVD) 1.4 TSi, (CDLF) 2.0 TSi, DSG, R (2009-), Tiguan 4X2, 4X4 (BWK, CAVA) 1.4 TSi Trend&Fun, Track&Field, (CBAB) 2.0 TDi Track&Field, Sport&Style, Trend&Fun, (CCZA) 2.0 TSi Track&Field, Sport&Style, 4-Motion (08-11), (CAXA) 1.4 TSi, (CAVD, CTHD) 1.4 TSi 4-Motion, (CFFD) 2.0 TDi, (CCZB) 2.0 TSi 4-Motion (11-17), Touran (BGU, BSE, BSF) 1.6 5-Spd. Man., (BKC, BLS, BXE) 1.9 TDi MPV TrendLine, DSG, (AZV) 2.0 TDi MPV Comfortline, HighLine, DSG, (BLY) 2.0 FSi MPV HighLine (04-11)</p>

	AR6909 Lower Subframe Bush / Mounting
 <p>ID: 15, OD: 93, H: 35.5</p>	<p>Audi A3 (BVZ) 2.0 FSi, (BMM, CLJA) 2.0 TDi (03-13), (CBFA, CCZA) 2.0 TFSi, (BUB) 3.2 Quattro (04-13), (CJZA, CCJZ) 1.2 TFSi, (CXSA) 1.4 TFSi, (CLHA) 1.6 TDi, (CJSA, CJSB) 1.8 TFSi, (DAGA) 2.0 TDi (12-17), (CZCA, CZEA) 1.4 TFSi, (CRFC) 2.0 TDi (13-17), S3 (CDLC) 2.0 TFSi (07-13); Seat Altea (BVY, BVZ) 2.0 FSi, (BMM) 2.0 TDi MPV (06-09), Leon (BLR, BLY, BVZ) 2.0 FSi, (BKD, BMM, CFHC, CLCB) 2.0 TDi, (BWA, BWJ, CDLD) 2.0T, FSi (06-09) - Auto. Models; Volkswagen Beetle (CBZB) 1.2 TSi, (CZDA) 1.4 TSi (2012-), Caddy (BGU) 1.6i Life Van, MPV, (BJB) 1.9 TDi, Life Van, MPV, (BDJ) 2.0 SDi Van (04-16), (CLCA) 2.0 TDi 5-Spd. Man., (CFHC, CLCB) 2.0 TDi (2010-), CC (CFGB) 2.0 TDi, (CCZB) 2.0 TSi, (BWS) 3.6 FSi V6 4-Motion (2009-), Golf V (BGU) 1.6i Comfortline, Tiptronic, Trendline, (BLS, BXE) 1.9 TDi Comfortline, DSG, (BKD) 2.0 TDi DSG Sport, Sport Tiptronic, Sport 5-Spd. Man., 6-Spd. Auto., (BLX) 2.0i Trendline, GTi DSG, Comfortline, GTi 5-Spd. Man., 6-Spd. Auto., (BLY) 2.0 FSi Sport, Sport Tiptronic 6-Spd. Man., Auto. (04-09), Golf VI (CAXA, CAVD) 1.4 TSi Trendline, Comfortline, HighLine, (BSE, BSF, CCSA) 1.6i Trendline, (CAYC) 1.6 TDi Comfortline, DSG, Bluemotion, (CBAB, CFFB) 2.0 TDi HighLine, (CCZB) 2.0 GTi DSG, 2.0 TSi-R 4-Motion, DSG (09-13), Golf VII (CJZA) 1.2 TSi, (CMBA, CPVA, CXSA) 1.4 TSi, (CHPA, CPTA) 1.4 TSi, (CRVA, CYKB) 2.0 TDi, (CRBC, CRLB, CRMB, CRUA) 2.0 TDi (2013-), Jetta V (CAVD, CAXA) 1.4 TSi Trendline, Comfortline, DSG, HighLine, (CAYC) 1.6 TDi Comfortline, DSG (09-11), 1.6i Comfortline, Tiptronic, Trendline, (BKC) 1.9 TDi Comfortline, DSG, (BHY) 2.0i Trendline, DSG, Comfortline, 5-Spd. Man., 6-Spd. Auto., (BHY) 2.0i Trendline, DSG, Comfortline, 5-Spd. Man., 6-Spd. Auto., 2.0 FSi, TFSi, Sportline, Tiptronic 6-Spd. Man./Auto. (05-11), (AZV, BKD, BMM) 2.0 TDi Sportline, Tiptronic, HighLine 5-Spd. Man., 6-Spd. Auto., 2.0 TSi HighLine (2005-), Jetta VI (CBZB) 1.2 TSi, (CAVD, CAXA) 1.4 TSi, (CAYC) 1.6 TDi, (CFHC, CJAA, CLCB) 2.0 TDi (2011-), Passat V (BZB, CDA) 1.8 TSi Comfortline, DSG, HighLine, (BKC, BLS, BXE) 1.9 TDi Comfortline, DSG, HighLine, (AXX, BLR, BLY, BPY, BVY, BVZ, BWA, CAWB, CBFA, CCZ/TA) 2.0 FSi, TFSi Comfortline, HighLine, (BMP) 2.0 TDi Comfortline, HighLine, DSG, (AXZ) 3.2 FSi Sportline, DSG (05-11), Passat (CDA) 1.8 TSi, (CFFB) 2.0 TDi (11-16), Scirocco (CAVD) 1.4 TSi, (CDLF) 2.0 TSi, DSG, R (2009-), Tiguan 4X2, 4X4 (BWK, CAVA) 1.4 TSi Trend&Fun, Track&Field, (CBAB) 2.0 TDi Track&Field, Sport&Style, Trend&Fun, (CCZA) 2.0 TSi Track&Field, Sport&Style, 4-Motion (08-11), (CAXA) 1.4 TSi, (CAVD, CTHD) 1.4 TSi 4-Motion, (CFFD) 2.0 TDi, (CCZB) 2.0 TSi 4-Motion (11-17), Touran (BGU, BSE, BSF) 1.6 5-Spd. Man., (BKC, BLS, BXE) 1.9 TDi MPV TrendLine, DSG, (AZV) 2.0 TDi MPV Comfortline, HighLine, DSG, (BLY) 2.0 FSi MPV HighLine (04-11)</p>

	AR6910 Front Strut Mounting
	<p>Seat Ibiza (BXW) 1.4 Sport, (BAH) 1.6, 1.9 TDi, Cupra (BPX), 96/118 (ASZ, BLT, BUK) (06-09), Ibiza (BBU) 1.8T, 2.0 (06-09); Volkswagen Polo (9N) (BBY, BKY, BLM) 1.4i, Classic, Trendline, Comfortline, (AMF) 1.4 TDi, Classic, (BAH) 1.6i, Classic Lux, Comfortline, Trendline, SE, (ATD) 1.9 TDi, HighLine, Classic, HighLine, Sportline, (BBU, BJX) 1.8T GTi Classic, Trendline, (ASZ, BBX) 2.0i HighLine, Classic HighLine (02-10), Cross Polo 1.6 TDi, 1.9 TDi (07-10), Polo Vivo (CFWA) 1.2 TDi, (CLPA, CLPB) 1.4i Trendline, (CLSA) 1.6i Trendline (2010-), Polo (6R) (CAVE, CDDA, CGGB, CLPA) 1.4i Trendline, Comfortline, GTi, (CFNA, CLSA) 1.6i Comfortline, Trendline, Tiptronic, (CAYC) 1.6 TDi Comfortline (10-15)</p>

	AR6911 Front Lower Control Arm Bush - Inner Front
 <p>ID: 12.2, OD: 32.5, L: 54</p>	<p>Seat Ibiza (BXW) 1.4 Sport, (BAH) 1.6, 1.9 TDi, Cupra (BPX), 96/118 (ASZ, BLT, BUK) (06-09), Ibiza (BBU) 1.8T, 2.0 (06-09); Volkswagen Polo (9N) (BBY, BKY, BLM) 1.4i, Classic, Trendline, Comfortline, (AMF) 1.4 TDi, Classic, (BAH) 1.6i, Classic Lux, Comfortline, Trendline, SE, (ATD) 1.9 TDi, HighLine, Classic, HighLine, Sportline, (BBU, BJX) 1.8T GTi Classic, Trendline, (ASZ, BBX) 2.0i HighLine, Classic HighLine (02-10), Cross Polo 1.6 TDi, 1.9 TDi (07-10), Polo Vivo (CFWA) 1.2 TDi, (CLPA, CLPB) 1.4i Trendline, (CLSA) 1.6i Trendline (2010-), Polo (6R) (CAVE, CDDA, CGGB, CLPA) 1.4i Trendline, Comfortline, GTi, (CFNA, CLSA) 1.6i Comfortline, Trendline, Tiptronic, (CAYC) 1.6 TDi Comfortline (10-15)</p>

ENGINE MOUNTING & RUBBER

BUYERS GUIDE

 <p>WITH THREAD</p>	<p>AR6912 Upper Subframe Bush / Mounting</p> <p>Seat Altea (BVY, BVZ) 2.0 FSi, (BMM) 2.0 TDi MPV Man. (06-09), Leon (BLR, BLY, BVZ) 2.0 FSi, (BKD, BMM, CFHC, CLCB) 2.0 TDi Man., (BWA, BWJ, CDLD) 2.0T, FSi Man. (06-09)</p>		<p>AR6923 Engine Mounting - RHS</p> <p>Seat Altea (BMM) 2.0 TDi MPV (06-09), Leon (BKD, BMM, CFHC, CLCB) 2.0 TDi (06-09); Volkswagen Golf V (BKD) 2.0 TDi DSG Sport, Sport Tiptronic, Sport 5-Spd. Man., 6-Spd. Auto. (04-09), Golf VI (CBAB, CFFB) 2.0 TDi HighLine, (CCZB) 2.0 GTi DSG, 2.0 TSi-R 4-Motion, DSG (09-13), Jetta V (AZV, BKD, BMM) 2.0 TDi Sportline, Tiptronic, HighLine 5-Spd. Man., 6-Spd. Auto. (2005-), Passat V (BMP) 2.0 TDi Comfortline, HighLine, DSG (05-11), Tiguan 4X2, 4X4 (CBAB) 2.0 TDi Track&Field, Sport&Style, Trend&Fun (08-11), Touran (AZV) 2.0 TDi MPV Comfortline, HighLine, DSG (04-11)</p>
 <p>ID: 21, OD: 64.5, L: 51.5</p>	<p>AR6913 Front Lower Control Arm Bush - Outer Rear (Insert)</p> <p>Seat Ibiza (BXW) 1.4 Sport, (BAH) 1.6, 1.9 TDi, Cupra (BPX), 96/118 (ASZ, BLT, BUK) (06-09), Ibiza (BBU) 1.8T, 2.0 (06-09); Volkswagen Passat V (BZB, CDA) 1.8 TSi Comfortline, DSG, HighLine, (BKC, BLS, BXE) 1.9 TDi Comfortline, DSG, HighLine, (AXX, BLR, BLY, BPY, BVY, BVZ, BWA, CAWB, CBFA, CCZTA) 2.0 FSi, TFSi Comfortline, HighLine, (BMP) 2.0 TDi Comfortline, HighLine, DSG, (AXZ) 3.2 FSi Sportline, DSG (05-11), Passat (CDA) 1.8 TSi, (CFFB) 2.0 TDi (11-16), Polo (9N) (BBY, BKY, BLM) 1.4i, Classic, Trendline, Comfortline, (AMF) 1.4 TDi, Classic, (BAH) 1.6i, Classic Lux, Comfortline, Trendline, SE, (ATD) 1.9 TDi, HighLine, Classic, HighLine, Sportline, (BBU, BJX) 1.8T GTi Classic, Trendline, (ASZ, BBX) 2.0i HighLine, Classic HighLine (02-10), Cross Polo 1.6 TDi, 1.9 TDi (07-10), Polo (6R) (CAVE, CDDA, CGGB, CLPA) 1.4i Trendline, Comfortline, GTi, (CFNA, CLSA) 1.6i Comfortline, Trendline, Tiptronic, (CAYC) 1.6 TDi Comfortline (10-15)</p>		<p>AR6929 Engine Mounting - RHS</p> <p>Audi A3 (BMM, CLJA) 2.0 TDi (03-13), (CMSA) 1.4 TFSi (08-13), (CZCA, CZIA) 1.4 TFSi, (CRFC) 2.0 TDi (13-17); Volkswagen Beetle (CBZB) 1.2 TSi, (CZDA) 1.4 TSi (2012-), Caddy (BGU) 1.6i Life Van, MPV, (BJB) 1.9 TDi, Life Van, MPV, (BDJ) 2.0 SDi Van (04-16), Golf V (BGU) 1.6i Comfortline, Tiptronic, Trendline (04-09), Golf VI (CAXA, CAVD) 1.4 TSi Trendline, Comfortline, HighLine, (BSE, BSF, CCSA) 1.6i Trendline, (CAYC) 1.6 TDi Comfortline, DSG, Bluemotion (09-13), Jetta V (CAVD, CAXA) 1.4 TSi Trendline, Comfortline, DSG, HighLine, (CAYC) 1.6 TDi Comfortline, DSG (09-11), 1.6i Comfortline, Tiptronic, Trendline (05-11), Jetta VI (CAVD, CAXA) 1.4 TSi (2011-), Scirocco (CAVD) 1.4 TSi (2009-), Tiguan 4X2, 4X4 (BWK, CAVA) 1.4 TSi Trend&Fun, Track&Field (08-11), (CAXA) 1.4 TSi, (CAVD, CTHD) 1.4 TSi 4-Motion (11-17), (CBZB) 1.2 TSi, (CAVC, CTHC) 1.4 TSi (2011-)</p>
	<p>AR6914 Engine Bracket Support Bush</p> <p>BMW Mini Cooper (R50) Cooper (W10B16A) 1.6, (R52) Cooper (W10B16A, W11B16A) 1.6 Convertible, (R53) Cooper S (W11B16A) 1.6 (02-09)</p>	 <p>ID: 12, OD: 40, L: 60</p>	<p>AR6930 Rear Axle Upper Arm Bush - Inner L/RHS</p> <p>Audi A1 (CHZB) 1.0, (CBZA) 1.2 TFSi, (CAVG, CAXA) 1.4 TFSi, (CAYC) 1.6 TDi Hatch 3-Dr, Sportback, (DAJB) 1.8 (11-18), A3 (BVZ) 2.0 FSi, (BMM, CLJA) 2.0 TDi (03-13), (CBFA, CCZA) 2.0 TFSi, (BUB) 3.2 Quattro (04-13); Seat Altea (BVY, BVZ) 2.0 FSi, (BMM) 2.0 TDi MPV (06-09), Leon (BLR, BLY, BVZ) 2.0 FSi, (BKD, BMM, CFHC, CLCB) 2.0 TDi, (BWA, BWJ, CDLD) 2.0T, FSi (06-09); Volkswagen Golf V (BGU) 1.6i Comfortline, Tiptronic, Trendline, (BLS, BXE) 1.9 TDi Comfortline, DSG, (BKD) 2.0 TDi DSG Sport, Sport Tiptronic, Sport 5-Spd. Man., 6-Spd. Auto., (BLX) 2.0i Trendline, GTi DSG, Comfortline, GTi 5-Spd. Man., 6-Spd. Auto., (BLY) 2.0 FSi Sport, Sport Tiptronic 6-Spd. Man., Auto. (04-09), Golf VI (CAXA, CAVD) 1.4 TSi Trendline, Comfortline, HighLine, (BSE, BSF, CCSA) 1.6i Trendline, (CAYC) 1.6 TDi Comfortline, DSG, Bluemotion, (CBAB, CFFB) 2.0 TDi HighLine, (CCZB) 2.0 GTi DSG, 2.0 TSi-R 4-Motion, DSG (09-13), Jetta V (CAVD, CAXA) 1.4 TSi Trendline, Comfortline, DSG, HighLine, (CAYC) 1.6 TDi Comfortline, DSG (09-11), 1.6i Comfortline, Tiptronic, Trendline, (BKC) 1.9 TDi Comfortline, DSG, (BHY) 2.0i Trendline, DSG, Comfortline, 5-Spd. Man., 6-Spd. Auto., (BHY) 2.0i Trendline, DSG, Comfortline, 5-Spd. Man., 6-Spd. Auto., 2.0 FSi, TFSi, Sportline, Tiptronic 6-Spd. Man./Auto. (05-11), (AZV, BKD, BMM) 2.0 TDi Sportline, Tiptronic, HighLine 5-Spd. Man., 6-Spd. Auto., 2.0 TSi HighLine (2005-), Jetta VI (CBZB) 1.2 TSi, (CAVD, CAXA) 1.4 TSi, (CAYC) 1.6 TDi, (CFHC, CJAA, CLCB) 2.0 TDi (2011-), Scirocco (CAVD) 1.4 TSi, (CDLF) 2.0 TSi, DSG, R (2009-), Tiguan 4X2, 4X4 (BWK, CAVA) 1.4 TSi Trend&Fun, Track&Field, (CBAB) 2.0 TDi Track&Field, Sport&Style, Trend&Fun, (CCZA) 2.0 TSi Track&Field, Sport&Style, 4-Motion (08-11), Touran (BGU, BSE, BSF) 1.6 5-Spd. Man., (BKC, BLS, BXE) 1.9 TDi MPV TrendLine, DSG, (AZV) 2.0 TDi MPV Comfortline, HighLine, DSG, (BLY) 2.0 FSi MPV HighLine (04-11), (CBZB) 1.2 TSi, (CAVC, CTHC) 1.4 TSi, (CFHF, CLCA) 2.0 TDi (2011-)</p>
	<p>AR6915 Transmission Mounting</p> <p>Volkswagen Polo (6N) 1.4i Classic, Playa (96-03)</p>		<p>AR6916 Transmission Mounting</p> <p>Audi A1 (CHZB, DKLD) 1.0 TFSi, Sportback 70kw 5-Spd. Man., 6-Spd. Auto., (CBZA) 1.2 TFSi, Sportback 63kw 5-Spd. Man., (CAXA) 1.4 TFSi, Sportback 90kw 6-Spd. Man., 7-Spd. S-Tronic, (CAVG) 1.4 TFSi, Sportback 136kw 7-Spd. S-Tronic, (CZCA, CZDD) 1.4 TFSi, SE, Sportback 92kw 5-Spd. Man., 6-Spd. Auto., 7-Spd. S-Tronic, (CAYC) 1.6 TDi 77kw 5-Spd. Man., (DAJB) 1.8 TFSi Sport 141kw 7-Spd. S-Tronic (11-18); Seat Ibiza III (BXW) 1.4, (BAH) 1.6, (ASZ, BLT) 1.9 TDi 96kw, (BPX, BUK) 1.9 TDi Cupra 118kw (2006-); Volkswagen Polo (9N) (AXU) 1.4 62kw 5-Spd. Man., (AMF, BAY) 1.4 TDi 55kw 5-Spd. Man., (BAH) 1.6 74kw 5-Spd. Man., (BMS, BNV) 1.4 TDi 59kw 5-Spd. Man., (BTS) 1.6 77kw 5-Spd. Man., (BJX) 1.8 TSi GTi 110kw 6-Spd. Man., (ATD, AXR) 1.9 TDi 74kw 5-Spd. Man., (ASZ, BLT) 1.9 TDi 96kw 6-Spd. Man., (BBX) 2.0 85kw 5-Spd. Man. (2002-), Polo (6R) (CGGB) 1.4 63kw 5-Spd. Man., (CLPA) 1.4 63kw 5-Spd. Man., (CAYC, CLNA) 1.6 TDi 77kw 5-Spd. Man., (CLSA) 1.6 77kw 5-Spd. Man. (2010-), Polo (6C) (CGGB) 1.4 63kw 5-Spd. Man., (CLPA) 1.4 63kw 5-Spd. Man., (CUSA, CYZB) 1.4 TDi 55kw 5-Spd. Man., (CUTA, CYZA) 1.4 TDi 77kw 5-Spd. Man., (CLSA) 1.6 77kw 5-Spd. Man. (2016-), Polo (6C, GP) (CHZB) 1.0 TSi 70kw 5-Spd. Man., (CHZC) 1.0 TSi R-Line 81kw 7-Spd. DSG, (CJZC) 1.2 TSi 66kw 5-Spd. Man., (CJZD) 1.2 TSi 81kw 5-Spd. Man., 7-Spd. DSG, (CGGB) 1.4 63kw 5-Spd. Man., (CLPA) 1.4 63kw 5-Spd. Man., (CLSA) 1.6 77kw 5-Spd. Man., 6-Spd. Auto., (DAJA) 1.8 TSi GTi 141kw 6-Spd. Man., (DAJB) 1.8 TSi GTi 141kw 7-Spd. DSG (2014-), Polo Vivo I (CLPA) 1.4 63kw 5-Spd. Man. (CLPB) 1.4 55kw 5-Spd. Man., (CLPA) 1.4 63kw 5-Spd. Man., (CLSA) 1.6 77kw 5-Spd. Man. (2010-), Polo Vivo II (CHZC) 1.0 TSi GT 81kw 6-Spd. Man., (CLPB) 1.4 55kw 5-Spd. Man., (CLPA) 1.4 63kw 5-Spd. Man., (CLSA) 1.6 77kw 5-Spd. Man., 6-Spd. Auto. (2018-)</p>
	<p>AR6918 Transmission Mounting - LHS</p> <p>Volkswagen Caddy (BGU) 1.6i Life Van, MPV (04-16)</p>		
	<p>AR6919 Engine Mounting - RHS</p> <p>Volkswagen Beetle (9C1, 9V1) (APH/AWU) 1.8T Coupe, (1Y7) (AEG) 2.0i Cabriolet, Coupe, HighLine, (9C1) (AEG) 2.0i Cabriolet, Coupe, HighLine (00-12)</p>		

ENGINE MOUNTING & RUBBER BUYERS GUIDE



 <p>ID: 12, OD: 40, L: 60</p>	<p>AR6931 Rear Axle Upper Arm Bush - Outer L/RHS</p> <p>Audi A1 (CHZB) 1.0, (CBZA) 1.2 TFSi, (CAVG, CAXA) 1.4 TFSi, (CAYC) 1.6 TDi Hatch 3-Dr, Sportback, (DAJB) 1.8 (11-18), A3 (BVZ) 2.0 FSi, (BMM, CLJA) 2.0 TDi (03-13), (CBFA, CCZA) 2.0 TFSi, (BUB) 3.2 Quattro (04-13); Seat Altea (BVB, BVZ) 2.0 FSi, (BMM) 2.0 TDi MPV (06-09), Leon (BLR, BLY, BVZ) 2.0 FSi, (BKD, BMM, CFHC, CLCB) 2.0 TDi, (BWA, BWJ, CDLD) 2.0T, FSi (06-09); Volkswagen Golf V (BGU) 1.6i Comfortline, Tiptronic, Trendline, (BLS, BXE) 1.9 TDi Comfortline, DSG, (BKD) 2.0 TDi DSG Sport, Sport Tiptronic, Sport 5-Spd. Man., 6-Spd. Auto., (BLX) 2.0i Trendline, GTi DSG, Comfortline, GTi 5-Spd. Man., 6-Spd. Auto., (BLY) 2.0 FSi Sport, Sport Tiptronic 6-Spd. Man., Auto. (04-09), Golf VI (CAXA, CAVD) 1.4 TSi Trendline, Comfortline, HighLine, (BSE, BSF, CCSA) 1.6i Trendline, (CAYC) 1.6 TDi Comfortline, DSG, Bluemotion, (CBAB, CFFB) 2.0 TDi HighLine, (CCZB) 2.0 GTi DSG, 2.0 TSi-R 4-Motion, DSG (09-13), Jetta V (CAVD, CAXA) 1.4 TSi Trendline, Comfortline, DSG, HighLine, (CAYC) 1.6 TDi Comfortline, DSG (09-11), 1.6i Comfortline, Tiptronic, Trendline, (BKC) 1.9 TDi Comfortline, DSG, (BHY) 2.0i Trendline, DSG, Comfortline, 5-Spd. Man., 6-Spd. Auto., (BHY) 2.0i Trendline, DSG, Comfortline, 5-Spd. Man., 6-Spd. Auto., 2.0 FSi, TFSi, Sportline, Tiptronic 6-Spd. Man./Auto. (05-11), (AZV, BKD, BMM) 2.0 TDi Sportline, Tiptronic, HighLine 5-Spd. Man., 6-Spd. Auto., 2.0 TSi HighLine (2005-), Jetta VI (CBZB) 1.2 TSi, (CAVD, CAXA) 1.4 TSi, (CAYC) 1.6 TDi, (CFHC, CJAA, CLCB) 2.0 TDi (2011-), Scirocco (CAVD) 1.4 TSi, (CDLF) 2.0 TSi, DSG, R (2009-), Tiguan 4X2, 4X4 (BWK, CAVA) 1.4 TSi Trend&Fun, Track&Field, (CBAB) 2.0 TDi Track&Field, Sport&Style, Trend&Fun, (CCZA) 2.0 TSi Track&Field, Sport&Style, 4-Motion (08-11), Touran (BGU, BSE, BSF) 1.6 5-Spd. Man., (BKC, BLS, BXE) 1.9 TDi MPV TrendLine, DSG, (AZV) 2.0 TDi MPV Comfortline, HighLine, DSG, (BLY) 2.0 FSi MPV HighLine (04-11), (CBZB) 1.2 TSi, (CAVC, CTHC) 1.4 TSi, (CFHF, CLCA) 2.0 TDi (2011-)</p>
	<p>AR6932 Transmission Mounting</p> <p>Toyota RAV4 I (SXA10/11) 4X4 (3S-FE) 2.0 3/5-Dr. SUV, DOHC, 5-Spd. Man. (94-95); Volkswagen Tiguan 4X2, 4X4 (BWK, CAVA) 1.4 TSi Trend&Fun, Track&Field, (CBAB) 2.0 TDi Track&Field, Sport&Style, Trend&Fun, (CCZA) 2.0 TSi Track&Field, Sport&Style, 4-Motion (08-11)</p>
	<p>AR6934 Transmission Mounting</p> <p>Toyota RAV4 I (SXA10/11) 4X4 (3S-FE) 2.0 3/5-Dr. SUV, DOHC, 4-Spd. Auto. (95-97)</p>
 <p>ID: 23, OD: 29, H: 12</p>	<p>AR6935 Front Lower Control Arm Bush - Outer Rear</p> <p>Toyota RAV4 I (SXA10/11) 4X4 (3S-FE) 2.0 3/5-Dr. SUV, DOHC, 5-Spd. Man., 4-Spd. Auto. (94-02), RAV4 II (A/ZCA20) 4X2 (1ZZ-FE) 1.8 SUV Pet. 5-Spd. Man., RAV4 II (A/ZCA20) 4X4 (1AZ-FE) 2.0 SUV 5-Spd. Man., 4-Spd. Auto. (02-06)</p>
 <p>ID: 20, OD: 53, L: 60</p>	<p>AR6937 Front & Rear Stabilizer Link Grommet</p> <p>Toyota Land Cruiser 76-Series 4X4 (1HZ) 4.2D P/up, S/W Dies. 5-Spd. Man. (2009-), 77-Series 4X4 (1HZ) 4.2D P/up, S/W Dies. 5-Spd. Man. (2009-), 79-Series 4X4 (1GR-FE) 4.0 P/up Pet. 5-Spd. Man., (1HZ) 4.2D P/up, S/W Dies. 5-Spd. Man. (2009-), RAV4 I (SXA10) 4X4 (3S-FE) 2.0 3/5-Dr. SUV, DOHC, 5-Spd. Man., 4-Spd. Auto. (94-02), RAV4 I (SXA11) 4X4 (3S-FE) 2.0 3/5-Dr. SUV, DOHC, 5-Spd. Man., 4-Spd. Auto. (94-97)</p>
	<p>AR6938 Steering Rack Mounting</p> <p>Toyota RAV4 I (SXA10/11) 4X4 (3S-FE) 2.0 3/5-Dr. SUV, DOHC, 5-Spd. Man., 4-Spd. Auto. (94-02)</p>
	<p>AR6939 Front Strut Mounting</p> <p>Toyota RAV4 I (SXA10/11) 4X4 (3S-FE) 2.0 3/5-Dr. SUV, DOHC, 5-Spd. Man., 4-Spd. Auto. (94-02), RAV4 II (A/ZCA20) 4X2 (1ZZ-FE) 1.8 SUV Pet. 5-Spd. Man., RAV4 II (A/ZCA20) 4X4 (1AZ-FE) 2.0 SUV 5-Spd. Man., 4-Spd. Auto. (02-06)</p>
 <p>ID: 17, OD: 59, H: 56</p>	<p>AR6940 Rear Lower Control Arm Bush - Outer Rear</p> <p>Toyota RAV4 I (SXA10/11) 4X4 (3S-FE) 2.0 3/5-Dr. SUV, DOHC, 5-Spd. Man., 4-Spd. Auto. (94-02)</p>
 <p>ID: 30</p>	<p>AR6942 Centre Bearing Rubber</p> <p>Toyota RAV4 I (SXA10/11) 4X4 (3S-FE) 2.0 3/5-Dr. SUV, DOHC, 5-Spd. Man., 4-Spd. Auto. (94-02)</p>
	<p>AR6947 Engine Mounting - LHS</p> <p>Toyota RAV4 I (SXA10/11) 4X4 (3S-FE) 2.0 3/5-Dr. SUV, DOHC, 5-Spd. Man., 4-Spd. Auto. (97-02)</p>
	<p>AR6949 Engine Mounting - RHS</p> <p>Toyota RAV4 I (SXA10/11) 4X4 (3S-FE) 2.0 3/5-Dr. SUV, DOHC, 5-Spd. Man., 4-Spd. Auto. (97-02)</p>
 <p>ID: 25, L: 32, H: 38, W: 39</p>	<p>AR6950 Front Stabilizer Bar Bush</p> <p>Toyota RAV4 I (SXA11) 4X4 (3S-FE) 2.0 3/5-Dr. SUV, DOHC, 5-Spd. Man., 4-Spd. Auto. (97-02)</p>
 <p>ID: 24, OD: 35, H: 12</p>	<p>AR6952 Stabilizer Link Assembly bush - Front</p> <p>Toyota RAV4 I (SXA11) 4X4 (3S-FE) 2.0 3/5-Dr. SUV, DOHC, 5-Spd. Man., 4-Spd. Auto. (97-02)</p>
	<p>AR6953 Transmission Mounting</p> <p>BMW Mini Cooper (R50) Cooper (W10B16A) 1.6, (R52) Cooper (W10B16A, W11B16A) 1.6 Convertible, (R53) Cooper S (W11B16A) 1.6 (02-09) - Auto. Models</p>
	<p>AR6954 Engine Mounting - LHS</p> <p>Toyota Land Cruiser (FJ75) 4X4 (3F) 4.0 DLX P/up Petrol 5-Spd. Man. (85-92), (HJ75) 4X4 (3F) 4.0 DLX P/up Petrol 5-Spd. Man. (85-92)</p>

ENGINE MOUNTING & RUBBER

BUYERS GUIDE

 <p>ID: 14, OD: 38</p>	<p>AR6957 Rear Axle Lateral Link Bush - Outer</p> <p>Audi A1 (CHZB) 1.0, (CBZA) 1.2 TFSi, (CAVG, CAXA) 1.4 TFSi, (CAYC) 1.6 TDi Hatch 3-Dr, Sportback, (DAJB) 1.8 (11-18), A3 (BVZ) 2.0 FSi, (BMM, CLJA) 2.0 TDi (03-13), (CBFA, CCZA) 2.0 TFSi, (BUB) 3.2 Quattro (04-13), (CMSA) 1.4 TFSi, (CAYC) 1.6 TDi, (CDA) 1.8 TFSi, (BXE) 1.9 TDi, (CLJA) 2.0 TDi (08-13), (CJZA, CCJZ) 1.2 TFSi, (CXSA) 1.4 TFSi, (CLHA) 1.6 TDi, (CJSA, CJSB) 1.8 TFSi, (DAGA) 2.0 TDi (12-17), (CZCA, CZEA) 1.4 TFSi, (CRFC) 2.0 TDi (13-17), S3 (CDLC) 2.0 TFSi (07-13), (CJXB) 2.0 TFSi (13-17); Seat Altea (BVY, BVZ) 2.0 FSi, (BMM) 2.0 TDi MPV (06-09), Leon (BLR, BLY, BVZ) 2.0 FSi, (BKD, BMM, CFHC, CLCB) 2.0 TDi, (BWA, BWJ, CDLD) 2.0T, FSi (06-09); Volkswagen Golf V (BGU) 1.6i Comfortline, Tiptronic, Trendline, (BLS, BXE) 1.9 TDi Comfortline, DSG, (BKD) 2.0 TDi DSG Sport, Sport Tiptronic, Sport 5-Spd. Man., 6-Spd. Auto., (BLX) 2.0i Trendline, GTi DSG, Comfortline, GTi 5-Spd. Man., 6-Spd. Auto., (BLY) 2.0 FSi Sport, Sport Tiptronic 6-Spd. Man., Auto. (04-09), Golf VI (CAXA, CAVD) 1.4 TSi Trendline, Comfortline, HighLine, (BSE, BSF, CCSA) 1.6i Trendline, (CAYC) 1.6 TDi Comfortline, DSG, Bluemotion, (CBAB, CFFB) 2.0 TDi HighLine, (CCZB) 2.0 GTi DSG, 2.0 TSi-R 4-Motion, DSG (09-13), Jetta V (CAVD, CAXA) 1.4 TSi Trendline, Comfortline, DSG, HighLine, (CAYC) 1.6 TDi Comfortline, DSG (09-11), 1.6i Comfortline, Tiptronic, Trendline, (BKC) 1.9 TDi Comfortline, DSG, (BHY) 2.0i Trendline, DSG, Comfortline, 5-Spd. Man., 6-Spd. Auto., (BHY) 2.0i Trendline, DSG, Comfortline, 5-Spd. Man., 6-Spd. Auto., 2.0 FSi, TFSi, Sportline, Tiptronic 6-Spd. Man./Auto. (05-11), (AZV, BKD, BMM) 2.0 TDi Sportline, Tiptronic, HighLine 5-Spd. Man., 6-Spd. Auto., 2.0 TSi HighLine (2005-), Jetta VI (CBZB) 1.2 TSi, (CAVD, CAXA) 1.4 TSi, (CAYC) 1.6 TDi, (CFHC, CJAA, CLCB) 2.0 TDi (2011-), Scirocco (CAVD) 1.4 TSi, (CDLF) 2.0 TSi, DSG, R (2009-), Tiguan 4X2, 4X4 (BWK, CAVA) 1.4 TSi Trend&Fun, Track&Field, (CBAB) 2.0 TDi Track&Field, Sport&Style, Trend&Fun, (CCZA) 2.0 TSi Track&Field, Sport&Style, 4-Motion (08-11), Touran (BGU, BSE, BSF) 1.6 5-Spd. Man., (BKC, BLS, BXE) 1.9 TDi MPV TrendLine, DSG, (AZV) 2.0 TDi MPV Comfortline, HighLine, DSG, (BLY) 2.0 FSi MPV HighLine (04-11), (CBZB) 1.2 TSi, (CAVC, CTHC) 1.4 TSi, (CFHF, CLCA) 2.0 TDi (2011-)</p>
--	--

 <p>ID: 12, OD: 38</p>	<p>AR6958 Rear Axle Lateral Link Bush - Inner</p> <p>Audi A1 (CHZB) 1.0, (CBZA) 1.2 TFSi, (CAVG, CAXA) 1.4 TFSi, (CAYC) 1.6 TDi Hatch 3-Dr, Sportback, (DAJB) 1.8 (11-18), A3 (BVZ) 2.0 FSi, (BMM, CLJA) 2.0 TDi (03-13), (CBFA, CCZA) 2.0 TFSi, (BUB) 3.2 Quattro (04-13), (CMSA) 1.4 TFSi, (CAYC) 1.6 TDi, (CDA) 1.8 TFSi, (BXE) 1.9 TDi, (CLJA) 2.0 TDi (08-13), (CJZA, CCJZ) 1.2 TFSi, (CXSA) 1.4 TFSi, (CLHA) 1.6 TDi, (CJSA, CJSB) 1.8 TFSi, (DAGA) 2.0 TDi (12-17), (CZCA, CZEA) 1.4 TFSi, (CRFC) 2.0 TDi (13-17), S3 (CDLC) 2.0 TFSi (07-13), (CJXB) 2.0 TFSi (13-17); Seat Altea (BVY, BVZ) 2.0 FSi, (BMM) 2.0 TDi MPV (06-09), Leon (BLR, BLY, BVZ) 2.0 FSi, (BKD, BMM, CFHC, CLCB) 2.0 TDi, (BWA, BWJ, CDLD) 2.0T, FSi (06-09); Volkswagen Golf V (BGU) 1.6i Comfortline, Tiptronic, Trendline, (BLS, BXE) 1.9 TDi Comfortline, DSG, (BKD) 2.0 TDi DSG Sport, Sport Tiptronic, Sport 5-Spd. Man., 6-Spd. Auto., (BLX) 2.0i Trendline, GTi DSG, Comfortline, GTi 5-Spd. Man., 6-Spd. Auto., (BLY) 2.0 FSi Sport, Sport Tiptronic 6-Spd. Man., Auto. (04-09), Golf VI (CAXA, CAVD) 1.4 TSi Trendline, Comfortline, HighLine, (BSE, BSF, CCSA) 1.6i Trendline, (CAYC) 1.6 TDi Comfortline, DSG, Bluemotion, (CBAB, CFFB) 2.0 TDi HighLine, (CCZB) 2.0 GTi DSG, 2.0 TSi-R 4-Motion, DSG (09-13), Jetta V (CAVD, CAXA) 1.4 TSi Trendline, Comfortline, DSG, HighLine, (CAYC) 1.6 TDi Comfortline, DSG (09-11), 1.6i Comfortline, Tiptronic, Trendline, (BKC) 1.9 TDi Comfortline, DSG, (BHY) 2.0i Trendline, DSG, Comfortline, 5-Spd. Man., 6-Spd. Auto., (BHY) 2.0i Trendline, DSG, Comfortline, 5-Spd. Man., 6-Spd. Auto., 2.0 FSi, TFSi, Sportline, Tiptronic 6-Spd. Man./Auto. (05-11), (AZV, BKD, BMM) 2.0 TDi Sportline, Tiptronic, HighLine 5-Spd. Man., 6-Spd. Auto., 2.0 TSi HighLine (2005-), Jetta VI (CBZB) 1.2 TSi, (CAVD, CAXA) 1.4 TSi, (CAYC) 1.6 TDi, (CFHC, CJAA, CLCB) 2.0 TDi (2011-), Scirocco (CAVD) 1.4 TSi, (CDLF) 2.0 TSi, DSG, R (2009-), Tiguan 4X2, 4X4 (BWK, CAVA) 1.4 TSi Trend&Fun, Track&Field, (CBAB) 2.0 TDi Track&Field, Sport&Style, Trend&Fun, (CCZA) 2.0 TSi Track&Field, Sport&Style, 4-Motion (08-11), Touran (BGU, BSE, BSF) 1.6 5-Spd. Man., (BKC, BLS, BXE) 1.9 TDi MPV TrendLine, DSG, (AZV) 2.0 TDi MPV Comfortline, HighLine, DSG, (BLY) 2.0 FSi MPV HighLine (04-11), (CBZB) 1.2 TSi, (CAVC, CTHC) 1.4 TSi, (CFHF, CLCA) 2.0 TDi (2011-)</p>
--	--

	<p>AR6960 Engine Mounting - L/RHS</p> <p>Toyota Land Cruiser (FZJ75) 4X4 (1FZ-F) 4.2 GX S/W Dies. 4-Spd. Man. (90-97), (HZJ75) 4X4 (1HZ) 4.2 P/up Dies., 4-Spd. Man. (90-97)</p>
	<p>AR6961 Transmission Mounting</p> <p>Toyota Land Cruiser (FJ62) 4X4 (3F) 4.0, GX P/up Pet. 4-Spd. Auto. (87-90)</p>

 <p>ID: 12, OD: 61, W: 64</p>	<p>AR6962 Rear Axle Trailing Link Bush - L/RHS</p> <p>Audi A1 (CHZB) 1.0, (CBZA) 1.2 TFSi, (CAVG, CAXA) 1.4 TFSi, (CAYC) 1.6 TDi Hatch 3-Dr, Sportback, (DAJB) 1.8 (11-18), A3 (BVZ) 2.0 FSi, (BMM, CLJA) 2.0 TDi (03-13), (CBFA, CCZA) 2.0 TFSi, (BUB) 3.2 Quattro (04-13), A3 (CMSA) 1.4 TFSi, (CAYC) 1.6 TDi, (CDA) 1.8 TFSi, (BXE) 1.9 TDi, (CLJA) 2.0 TDi (08-13), (CJZA, CCJZ) 1.2 TFSi, (CXSA) 1.4 TFSi, (CLHA) 1.6 TDi, (CJSA, CJSB) 1.8 TFSi, (DAGA) 2.0 TDi (12-17), S3 (CDLC) 2.0 TFSi (07-13); Seat Altea (BVY, BVZ) 2.0 FSi, (BMM) 2.0 TDi MPV (06-09), Leon (BLR, BLY, BVZ) 2.0 FSi, (BKD, BMM, CFHC, CLCB) 2.0 TDi, (BWA, BWJ, CDLD) 2.0T, FSi (06-09), CC (CFGB) 2.0 TDi, (CCZB) 2.0 TSi, (BWS) 3.6 FSi V6 4-Motion (2009-); Volkswagen Golf V (BGU) 1.6i Comfortline, Tiptronic, Trendline, (BLS, BXE) 1.9 TDi Comfortline, DSG, (BKD) 2.0 TDi DSG Sport, Sport Tiptronic, Sport 5-Spd. Man., 6-Spd. Auto., (BLX) 2.0i Trendline, GTi DSG, Comfortline, GTi 5-Spd. Man., 6-Spd. Auto., (BLY) 2.0 FSi Sport, Sport Tiptronic 6-Spd. Man., Auto. (04-09), Golf VI (CAXA, CAVD) 1.4 TSi Trendline, Comfortline, HighLine, (BSE, BSF, CCSA) 1.6i Trendline, (CAYC) 1.6 TDi Comfortline, DSG, Bluemotion, (CBAB, CFFB) 2.0 TDi HighLine, (CCZB) 2.0 GTi DSG, 2.0 TSi-R 4-Motion, DSG (09-13), Jetta V (CAVD, CAXA) 1.4 TSi Trendline, Comfortline, DSG, HighLine, (CAYC) 1.6 TDi Comfortline, DSG (09-11), 1.6i Comfortline, Tiptronic, Trendline, (BKC) 1.9 TDi Comfortline, DSG, (BHY) 2.0i Trendline, DSG, Comfortline, 5-Spd. Man., 6-Spd. Auto., (BHY) 2.0i Trendline, DSG, Comfortline, 5-Spd. Man., 6-Spd. Auto., 2.0 FSi, TFSi, Sportline, Tiptronic 6-Spd. Man./Auto. (05-11), (AZV, BKD, BMM) 2.0 TDi Sportline, Tiptronic, HighLine 5-Spd. Man., 6-Spd. Auto., 2.0 TSi HighLine (2005-), Jetta VI (CBZB) 1.2 TSi, (CAVD, CAXA) 1.4 TSi, (CAYC) 1.6 TDi, (CFHC, CJAA, CLCB) 2.0 TDi (2011-), Passat V (BZB, CDA) 1.8 TSi Comfortline, DSG, HighLine, (BKC, BLS, BXE) 1.9 TDi Comfortline, DSG, HighLine, (AXX, BLR, BLY, BPY, BVY, BVZ, BWA, CAWB, CBFA, CCZ/TA) 2.0 FSi, TFSi Comfortline, HighLine, (BMP) 2.0 TDi Comfortline, HighLine, DSG, (AXZ) 3.2 FSi Sportline, DSG (05-11), Scirocco (CAVD) 1.4 TSi, (CDLF) 2.0 TSi, DSG, R (2009-), Tiguan 4X2, 4X4 (BWK, CAVA) 1.4 TSi Trend&Fun, Track&Field, (CBAB) 2.0 TDi Track&Field, Sport&Style, Trend&Fun, (CCZA) 2.0 TSi Track&Field, Sport&Style, 4-Motion (08-11), Touran (BGU, BSE, BSF) 1.6 5-Spd. Man., (BKC, BLS, BXE) 1.9 TDi MPV TrendLine, DSG, (AZV) 2.0 TDi MPV Comfortline, HighLine, DSG, (BLY) 2.0 FSi MPV HighLine (04-11), (CBZB) 1.2 TSi, (CAVC, CTHC) 1.4 TSi, (CFHF, CLCA) 2.0 TDi (2011-), (CBZB) 1.2 TSi, (CAVC, CTHC) 1.4 TSi, (CFHF, CLCA) 2.0 TDi (2011-)</p>
---	---

	<p>AR6964 Engine Mounting - L/RHS</p> <p>Toyota Land Cruiser (FZJ80) 4X4 (1FZ-FE, 1HD) 4.5 Std., GX P/up, GX, VX S/W 12V Dies. 5-Spd. Man., 4-Spd. Auto. (95-98), (FZJ105) 4X4 (1FZ-FE) 4.2 Std., GX P/up Dies. Turbo 5-Spd. Man., 4-Spd. Auto. (98-06), (HDJ80) 4X4 (1FZ-FE, 1HD) 4.5 Std., GX P/up, GX, VX S/W 12V Dies. 5-Spd. Man., 4-Spd. Auto. (90-98), (HZJ80) 4X4 (1HZ) 4.2 Std., GX 5-Spd. Man. Dies. 4-Spd. Auto., 5-Spd. Man. (90-93), (1HD-FT) 4.2 GX, VX Dies., 4-Spd. Auto. (96-98), (HZJ105) 4X4 (1HZ) 4.2 GX P/up Dies. Turbo 5-Spd. Man., Auto. (98-06)</p>
---	--

	<p>AR6965 Engine Mounting - L/RHS</p> <p>Toyota Land Cruiser (HDJ80) 4X4 (1FZ-FE, 1HD) 4.5 Std., GX P/up, GX, VX S/W 12V Dies. 5-Spd. Man., 4-Spd. Auto. (90-98), (HDJ100) 4X4 (1FZ-FE) 4.5 GX, VX S/W Dies. 5-Spd. Man., 4-Spd. Auto. (98-06), (HZJ80) 4X4 (1HZ) 4.2 Std., GX 5-Spd. Man. Dies. 4-Spd. Auto., 5-Spd. Man. (93-95)</p>
---	--

ENGINE MOUNTING & RUBBER BUYERS GUIDE

	<p>AR6966 Transmission Mounting</p> <p>Toyota Land Cruiser (FZJ80) 4X4 (1FZ-FE, 1HD) 4.5 Std., GX P/up, GX, VX S/W 12V Dies. 5-Spd. Man. (90-98), (HDJ80) 4X4 (1FZ-FE, 1HD) 4.5 Std., GX P/up, GX, VX S/W 12V Dies. 5-Spd. Man. (90-98), (HDJ100) 4X4 (1FZ-FE) 4.5 GX, VX S/W Dies. 5-Spd. Man. (98-06)</p>
	<p>AR6967 Front Lower Control Arm Bush - Inner</p> <p>Toyota Land Cruiser (FJ62) 4X4 (3F) 4.0, GX P/up Pet. 5-Spd. Man., 4-Spd. Auto. (87-90), (FZJ80) 4X4 (1FZ-FE, 1HD) 4.5 Std., GX P/up, GX, VX S/W 12V Dies. 5-Spd. Man., 4-Spd. Auto. (90-98), (FZJ105) 4X4 (1FZ-FE) 4.2 Std., GX P/up Dies. Turbo 5-Spd. Man., 4-Spd. Auto. (98-06), (HDJ80) 4X4 (1FZ-FE, 1HD) 4.5 Std., GX P/up, GX, VX S/W 12V Dies. 5-Spd. Man., 4-Spd. Auto. (90-98), (HDJ100) 4X4 (1FZ-FE) 4.5 GX, VX S/W Dies. 5-Spd. Man., 4-Spd. Auto. (98-06), (HZJ80) 4X4 (1HZ) 4.2 Std., GX 5-Spd. Man. Dies. 4-Spd. Auto., 5-Spd. Man. (90-95), (HZJ80) 4X4 (1HD-FT) 4.2 GX, VX Dies. 5-Spd. Man., 4-Spd. Auto. (96-98), (HZJ105) 4X4 (1HZ) 4.2 GX P/up Dies. Turbo 5-Spd. Man., Auto. (98-06)</p> <p>ID: 18, OD: 54, H: 60</p>
	<p>AR6968 Front Lower Control Arm Bush - Outer</p> <p>Toyota Land Cruiser (FJ62) 4X4 (3F) 4.0, GX P/up Pet. 5-Spd. Man., 4-Spd. Auto. (87-90), (FZJ80) 4X4 (1FZ-FE, 1HD) 4.5 Std., GX P/up, GX, VX S/W 12V Dies. 5-Spd. Man., 4-Spd. Auto. (90-98), (FZJ105) 4X4 (1FZ-FE) 4.2 Std., GX P/up Dies. Turbo 5-Spd. Man., 4-Spd. Auto. (98-06), (HDJ80) 4X4 (1FZ-FE, 1HD) 4.5 Std., GX P/up, GX, VX S/W 12V Dies. 5-Spd. Man., 4-Spd. Auto. (90-98), (HDJ100) 4X4 (1FZ-FE) 4.5 GX, VX S/W Dies. 5-Spd. Man., 4-Spd. Auto. (98-06), (HZJ80) 4X4 (1HZ) 4.2 Std., GX 5-Spd. Man. Dies. 4-Spd. Auto., 5-Spd. Man. (90-95), (HZJ80) 4X4 (1HD-FT) 4.2 GX, VX Dies. 5-Spd. Man., 4-Spd. Auto. (96-98), (HZJ105) 4X4 (1HZ) 4.2 GX P/up Dies. Turbo 5-Spd. Man., Auto. (98-06)</p> <p>ID: 16.5, OD: 60.5, H: 60</p>
	<p>AR6970 Transmission Mounting</p> <p>BMW Mini Cooper (R50) Cooper (W10B16A) 1.6, (R52) Cooper (W10B16A, W11B16A) 1.6 Convertible, Man., (R53) Cooper S (W11B16A) 1.6 Man. (02-09); Toyota Land Cruiser (FJ80) 4X4 (3F-E) 4.0 GX, VX P/up Pet., 4-Spd. Auto. (90-92)</p>
	<p>AR6971 Front Stabilizer Bar Bush</p> <p>Toyota Land Cruiser (FJ80) 4X4 (3F-E) 4.0 GX, VX P/up Pet., 4-Spd. Auto. (91-92), (FZJ80) 4X4 (1FZ-FE, 1HD) 4.5 Std., GX P/up, GX, VX S/W 12V Dies. 5-Spd. Man., 4-Spd. Auto. (92-95), (HDJ80) 4X4 (1FZ-FE, 1HD) 4.5 Std., GX P/up, GX, VX S/W 12V Dies. 5-Spd. Man., 4-Spd. Auto. (92-95), (HZJ80) 4X4 (1HZ) 4.2 Std., GX 5-Spd. Man. Dies. 4-Spd. Auto., 5-Spd. Man. (92-95), (HZJ80) 4X4 (1HD-FT) 4.2 GX, VX Dies. 5-Spd. Man., 4-Spd. Auto. (90-92)</p> <p>ID: 26, L: 33, H: 39, W: 47</p>
	<p>AR6972 Front Stabilizer Bar Bush</p> <p>Toyota Land Cruiser (FZJ80) 4X4 (1FZ-FE, 1HD) 4.5 Std., GX P/up, GX, VX S/W 12V Dies. 5-Spd. Man., 4-Spd. Auto. (96-98), (HDJ80) 4X4 (1FZ-FE, 1HD) 4.5 Std., GX P/up, GX, VX S/W 12V Dies. 5-Spd. Man., 4-Spd. Auto. (96-98), (HZJ80) 4X4 (1HD-FT) 4.2 GX, VX Dies. 5-Spd. Man., 4-Spd. Auto. (92-95)</p> <p>ID: 29, L: 32, H: 37, W: 48</p>
	<p>AR6974 Steering Coupling</p> <p>Toyota Land Cruiser (FJ80) 4X4 (3F-E) 4.0 GX, VX P/up Pet., 4-Spd. Auto. (90-92), (FZJ105) 4X4 (1FZ-FE) 4.2 Std., GX P/up Dies. Turbo 5-Spd. Man., 4-Spd. Auto. (98-06), (HZJ80) 4X4 (1HZ) 4.2 Std., GX 5-Spd. Man. Dies. 4-Spd. Auto., 5-Spd. Man. (90-95), (1HD-FT) 4.2 GX, VX Dies. 5-Spd. Man., 4-Spd. Auto. (96-98), (HZJ105) 4X4 (1HZ) 4.2 GX P/up Dies. Turbo 5-Spd. Man., Auto. (98-06)</p>
	<p>AR6976 Engine Mounting - RHS</p> <p>BMW Mini Cooper (R50) Cooper (W10B16A) 1.6, (R52) Cooper (W10B16A, W11B16A) 1.6 Convertible, (R53) Cooper S (W11B16A) 1.6 (02-09)</p>
	<p>AR6978 Engine Mounting - LHS</p> <p>BMW Mini Cooper (R50) Cooper (W10B16A) 1.6, (R52) Cooper (W10B16A, W11B16A) 1.6 Convertible, (R53) Cooper S (W11B16A) 1.6 (02-09)</p>



	<p>AR6979 Rear Upper Control Arm Bush</p> <p>Toyota Land Cruiser (FJ80) 4X4 (3F-E) 4.0 GX, VX P/up Pet., 4-Spd. Auto. (90-92), (FZJ80) 4X4 (1FZ-FE, 1HD) 4.5 Std., GX P/up, GX, VX S/W 12V Dies. 5-Spd. Man., 4-Spd. Auto. (90-98), (FZJ100) 4X4 (2UZ-FE) 4.7 VX V8 Petrol 5-Spd. Man., 4-Spd. Auto. (98-03), (FZJ105) 4X4 (1FZ-FE) 4.2 Std., GX P/up Dies. Turbo 5-Spd. Man., 4-Spd. Auto. (98-06), (HDJ80) 4X4 (1FZ-FE, 1HD) 4.5 Std., GX P/up, GX, VX S/W 12V Dies. 5-Spd. Man., 4-Spd. Auto. (90-98), (HDJ100) 4X4 (2UZ-FE) 4.7 VX V8 Petrol 5-Spd. Man., 4-Spd. Auto. (98-03), (1FZ-FE) 4.5 GX, VX S/W Dies. 5-Spd. Man., 4-Spd. Auto. (98-06), (HZJ80) 4X4 (1HZ) 4.2 Std., GX 5-Spd. Man. Dies. 4-Spd. Auto., 5-Spd. Man. (90-95), (HZJ80) (1HD-FT) 4.2 GX, VX Dies. 5-Spd. Man., 4-Spd. Auto. (96-98), (HZJ105) 4X4 (1HZ) 4.2 GX P/up Dies. Turbo 5-Spd. Man., Auto. (98-06), (UZJ100) 4X4 (2UZ-FE) 4.7 VX V8 Petrol 5-Spd. Man., 4-Spd. Auto. (98-03)</p> <p>ID: 18, OD: 50, H: 60</p>
	<p>AR6980 Rear Lower Control Arm Bush</p> <p>Toyota Land Cruiser (FJ80) 4X4 (3F-E) 4.0 GX, VX P/up Pet., 4-Spd. Auto. (90-92), (FZJ80) 4X4 (1FZ-FE, 1HD) 4.5 Std., GX P/up, GX, VX S/W 12V Dies. 5-Spd. Man., 4-Spd. Auto. (90-98), (FZJ100) 4X4 (2UZ-FE) 4.7 VX V8 Petrol 5-Spd. Man., 4-Spd. Auto. (98-03), (FZJ105) 4X4 (1FZ-FE) 4.2 Std., GX P/up Dies. Turbo 5-Spd. Man., 4-Spd. Auto. (98-06), (HDJ80) 4X4 (1FZ-FE, 1HD) 4.5 Std., GX P/up, GX, VX S/W 12V Dies. 5-Spd. Man., 4-Spd. Auto. (90-98), (HDJ100) 4X4 (2UZ-FE) 4.7 VX V8 Petrol 5-Spd. Man., 4-Spd. Auto. (98-03), (1FZ-FE) 4.5 GX, VX S/W Dies. 5-Spd. Man., 4-Spd. Auto. (98-06), (HZJ80) 4X4 (1HZ) 4.2 Std., GX 5-Spd. Man. Dies. 4-Spd. Auto., 5-Spd. Man. (90-95), (1HD-FT) 4.2 GX, VX Dies. 5-Spd. Man., 4-Spd. Auto. (96-98), (HZJ105) 4X4 (1HZ) 4.2 GX P/up Dies. Turbo 5-Spd. Man., Auto. (98-06), (UZJ100) 4X4 (2UZ-FE) 4.7 VX V8 Petrol 5-Spd. Man., 4-Spd. Auto. (98-03)</p> <p>ID: 18, OD: 55, H: 60</p>
	<p>AR6981 Rear Lateral Centre Rod Bush</p> <p>Toyota Land Cruiser (FJ80) 4X4 (3F-E) 4.0 GX, VX P/up Pet., 4-Spd. Auto. (90-92), (FZJ80) 4X4 (1FZ-FE, 1HD) 4.5 Std., GX P/up, GX, VX S/W 12V Dies. 5-Spd. Man., 4-Spd. Auto. (90-98), (FZJ100) 4X4 (2UZ-FE) 4.7 VX V8 Petrol 5-Spd. Man., 4-Spd. Auto. (98-03), (FZJ105) 4X4 (1FZ-FE) 4.2 Std., GX P/up Dies. Turbo 5-Spd. Man., 4-Spd. Auto. (98-06), (HDJ80) 4X4 (1FZ-FE, 1HD) 4.5 Std., GX P/up, GX, VX S/W 12V Dies. 5-Spd. Man., 4-Spd. Auto. (90-98), (HDJ100) 4X4 (2UZ-FE) 4.7 VX V8 Petrol 5-Spd. Man., 4-Spd. Auto. (98-03), (1FZ-FE) 4.5 GX, VX S/W Dies. 5-Spd. Man., 4-Spd. Auto. (98-06), (HZJ80) 4X4 (1HD-FT) 4.2 GX, VX Dies. 5-Spd. Man., 4-Spd. Auto. (96-98), (HZJ105) 4X4 (1HZ) 4.2 GX P/up Dies. Turbo 5-Spd. Man., Auto. (98-06), (UZJ100) 4X4 (2UZ-FE) 4.7 VX V8 Petrol 5-Spd. Man., 4-Spd. Auto. (98-03)</p> <p>ID: 18, OD: 40, H: 50</p>
	<p>AR6982 Front Lateral Control Rod Bush</p> <p>Toyota Land Cruiser (FJ80) 4X4 (3F-E) 4.0 GX, VX P/up Pet., 4-Spd. Auto. (90-92), (FZJ80) 4X4 (1FZ-FE, 1HD) 4.5 Std., GX P/up, GX, VX S/W 12V Dies. 5-Spd. Man., 4-Spd. Auto. (90-98), (FZJ105) 4X4 (1FZ-FE) 4.2 Std., GX P/up Dies. Turbo 5-Spd. Man., 4-Spd. Auto. (98-06), (HDJ80) 4X4 (1FZ-FE, 1HD) 4.5 Std., GX P/up, GX, VX S/W 12V Dies. 5-Spd. Man., 4-Spd. Auto. (90-98), (HDJ100) 4X4 (1FZ-FE) 4.5 GX, VX S/W Dies. 5-Spd. Man., 4-Spd. Auto. (98-06), (HZJ80) 4X4 (1HZ) 4.2 Std., GX 5-Spd. Man. Dies. 4-Spd. Auto., 5-Spd. Man. (90-95), (1HD-FT) 4.2 GX, VX Dies. 5-Spd. Man., 4-Spd. Auto. (96-98), (HZJ105) 4X4 (1HZ) 4.2 GX P/up Dies. Turbo 5-Spd. Man., Auto. (98-06), (UZJ100) 4X4 (2UZ-FE) 4.7 VX V8 Petrol 5-Spd. Man., 4-Spd. Auto. (98-03)</p>
	<p>AR6984 Front Stabilizer Bar Bush</p> <p>Toyota Land Cruiser (FJ80) 4X4 (3F-E) 4.0 GX, VX P/up Pet., 4-Spd. Auto. (90-91)</p> <p>ID: 28, L: 33, H: 35, W: 39</p>
	<p>AR6985 Engine Mounting - L/RHS</p> <p>Toyota Land Cruiser (FZJ80) 4X4 (1FZ-FE, 1HD) 4.5 Std., GX P/up, GX, VX S/W 12V Dies. 5-Spd. Man., 4-Spd. Auto. (92-95)</p>

ENGINE MOUNTING & RUBBER BUYERS GUIDE

	<p>AR7000 Steering Coupling Toyota Land Cruiser (FZJ100) 4X4 (2UZ-FE) 4.7 VX V8 Petrol 5-Spd. Man., 4-Spd. Auto. (98-03), (FZJ105) 4X4 (1FZ-FE) 4.2 Std., GX P/up Dies. Turbo 5-Spd. Man., 4-Spd. Auto. (98-06), (HDJ100) 4X4 (2UZ-FE) 4.7 VX V8 Petrol 5-Spd. Man., 4-Spd. Auto. (98-03), (UZJ100) 4X4 (2UZ-FE) 4.7 VX V8 Petrol 5-Spd. Man., 4-Spd. Auto. (98-03)</p>
 <p>ID: 59, L: 30, H: 70, W: 86</p>	<p>AR7001 Steering Rack Mounting Toyota Land Cruiser (FZJ100) 4X4 (2UZ-FE) 4.7 VX V8 Petrol 5-Spd. Man., 4-Spd. Auto. (98-03), (FZJ105) 4X4 (1FZ-FE) 4.2 Std., GX P/up Dies. Turbo 5-Spd. Man., 4-Spd. Auto. (98-06), (HDJ100) 4X4 (2UZ-FE) 4.7 VX V8 Petrol 5-Spd. Man., 4-Spd. Auto. (98-03), (UZJ100) 4X4 (2UZ-FE) 4.7 VX V8 Petrol 5-Spd. Man., 4-Spd. Auto. (98-03), 100-Series 4X4 4.2D 5-Spd. Man., 4.2D 4-Spd. Auto., 4.7 V8 5-Spd. Auto. (02-07)</p>
 <p>ID: 14.5, OD: 52, H: 67.5</p>	<p>AR7002 Front Upper Control Arm Bush - Inner & Outer Toyota Land Cruiser (FZJ100) 4X4 (2UZ-FE) 4.7 VX V8 Petrol 5-Spd. Man., 4-Spd. Auto. (98-03), (FZJ105) 4X4 (1FZ-FE) 4.2 Std., GX P/up Dies. Turbo 5-Spd. Man., 4-Spd. Auto. (98-06), (HDJ100) 4X4 (2UZ-FE) 4.7 VX V8 Petrol 5-Spd. Man., 4-Spd. Auto. (98-03), (UZJ100) 4X4 (2UZ-FE) 4.7 VX V8 Petrol 5-Spd. Man., 4-Spd. Auto. (98-03), 100-Series 4X4 4.2D 5-Spd. Man., 4.2D 4-Spd. Auto., 4.7 V8 5-Spd. Auto. (02-07)</p>
 <p>ID: 10, OD: 30, H: 25</p>	<p>AR7003 Lateral Control Rod Bush Toyota Land Cruiser (FZJ100) 4X4 (2UZ-FE) 4.7 VX V8 Petrol 5-Spd. Man., 4-Spd. Auto. (98-03), (FZJ105) 4X4 (1FZ-FE) 4.2 Std., GX P/up Dies. Turbo 5-Spd. Man., 4-Spd. Auto. (98-06), (HDJ100) 4X4 (2UZ-FE) 4.7 VX V8 Petrol 5-Spd. Man., 4-Spd. Auto. (98-03), (UZJ100) 4X4 (2UZ-FE) 4.7 VX V8 Petrol 5-Spd. Man., 4-Spd. Auto. (98-03)</p>
	<p>AR7005 Exhaust Hanger - Rear (Bracket) Audi A3 (AGN) 1.8, (AGU, BFU) 1.8T (98-04); Volkswagen Beetle (9C1, 9V1) (APH/ AWU) 1.8T Coupe, (1Y7) (AEG) 2.0i Cabriolet, Coupe, HighLine, (9C1) (AEG) 2.0i Cabriolet, Coupe, HighLine (00-12), Golf IV 1.6i Comfortline, Std., Tiptronic, 1.8 GTi HighLine, 1.8T GTi, 1.9 TDi HighLine, Comfortline, DSG, 2.0i Cabrio, HighLine (99-04), Jetta IV 1.6i Comfortline Std. 5-Spd. Man., 4-Spd. Auto., 1.9 TDi HighLine 5-Spd. Man., 2.0i HighLine 5-Spd. Man., 2.3 V5 5-Spd. Man. (99-05)</p>
	<p>AR7006 Shock Bush - Rear Lower Toyota Land Cruiser (FZJ100) 4X4 (2UZ-FE) 4.7 VX V8 Petrol 5-Spd. Man., 4-Spd. Auto. (98-03), (FZJ105) 4X4 (1FZ-FE) 4.2 Std., GX P/up Dies. Turbo 5-Spd. Man., 4-Spd. Auto. (98-06), (HDJ100) 4X4 (2UZ-FE) 4.7 VX V8 Petrol 5-Spd. Man., 4-Spd. Auto. (98-03), (UZJ100) 4X4 (2UZ-FE) 4.7 VX V8 Petrol 5-Spd. Man., 4-Spd. Auto. (98-03)</p>
 <p>ID: 21.5, L: 41, H: 31, W: 44</p>	<p>AR7007 Front & Rear Stabilizer Bar Bush Toyota Corolla Verso (3ZZ-FE) 1.6S, SX, TX MPV 5/6-Spd. Man., (1ZZ-FE) 1.8 SX, TX MPV 5/6-Spd. Man., (1CD-FTV) 2.0D-4D TX MPV, 6-Spd. Man. (04-09), Land Cruiser 100-Series 4X4 4.2D 5-Spd. Man., 4.2D 4-Spd. Auto., 4.7 V8 5-Spd. Auto. (02-07)</p>
	<p>AR7008 Engine Mounting - RHS Seat Ibiza III (BAH) 1.6 (2006-); Volkswagen Polo (6C, GP) (CGGB) 1.4 63kw 5-Spd. Man., (CLPA) 1.4 63kw 5-Spd. Man., (CLSA) 1.6 77kw 5-Spd. Man., 6-Spd. Auto. (2014-), Polo Vivo I (CLPB) 1.4 55kw 5-Spd. Man., (CLPA) 1.4 63kw 5-Spd. Man., 6-Spd. Auto., (CLSA) 1.6 77kw 5-Spd. Man. (2010-), Polo Vivo II (CLPB) 1.4 55kw 5-Spd. Man., (CLPA) 1.4 63kw 5-Spd. Man., (CLSA) 1.6 77kw 5-Spd. Man., 6-Spd. Auto. (2018-)</p>

 <p>ID: 18, L: 34.5, H: 35, W: 35</p>	<p>AR7009 Front Stabilizer Bar Bush Audi A1 (CHZB) 1.0, (CBZA) 1.2 TFSi, (CAVG, CAXA) 1.4 TFSi, (CAYC) 1.6 TDi Hatch 3-Dr. Sportback, (DAJB) 1.8 (11-18); Seat Ibiza (BXW) 1.4 Sport, (BAH) 1.6, 1.9 TDi, Cupra (BPX), 96/118 (ASZ, BLT, BUK) (06-09), (BBU) 1.8T, 2.0 (06-09); Volkswagen Polo (9N) (BBY, BKY, BLM) 1.4i, Classic, Trendline, Comfortline, (AMF) 1.4 TDi, Classic, (BAH) 1.6i, Classic Lux, Comfortline, Trendline, SE, (ATD) 1.9 TDi, HighLine, Classic, HighLine, Sportline, (BBU, BJX) 1.8T GTi Classic, Trendline, (ASZ, BBX) 2.0i HighLine, Classic HighLine (02-10), Cross Polo 1.6 TDi, 1.9 TDi (07-10), Polo (CBZB) 1.2 Trendline DSG Pet., (CBZC) 1.2 TSi Comfortline Man. Pet., (CFWA) 1.2 TDi Trendline, BlueMotion Man. DSL, (CGPA, CGPB) 1.2 Man., (CTHE) 1.4 TSi GTi DSG (2010-), Polo Vivo (CFWA) 1.2 TDi, (CLPA, CLPB) 1.4i Trendline, (CLSA) 1.6i Trendline (2010-), Polo (6R) (CAVE, CDDA, CGGB, CLPA) 1.4i Trendline, Comfortline, GTi, (CFNA, CLSA) 1.6i Comfortline, Trendline, Tiptronic, (CAYC) 1.6 TDi Comfortline (10-15), Polo (6C) (CJZC, CJZD) 1.2 TSi, (CDDA, CGGB, CLPA) 1.4, (CUTA, CYZB) 1.4 TDi, (CWXC) 1.5 TDi, (CFNA, CLSA) 1.6, (DAJA) 1.8 TSi, GTi (2014-), Polo (CHYA, CHYB) 1.0 Comfortline, Trendline BlueMotion Hatch (2014-), Polo (GP) (CHZB) 1.0 TSi BlueMotion 5-dr, (CHZC) 1.0 TSi Comfortline, TSi-R-Line DSG (15-17), Polo (AW1, BZ1) 1.0 TSi GT (2018-)</p>
	<p>AR7010 Transmission Mounting - LHS Audi A3 (BMM, CLJA) 2.0 TDi (03-13), (BUB) 3.2 Quattro (04-13), (CDA) 1.8 TFSi (08-13), (CJSA, CJSB) 1.8 TFSi (12-17), S3 (CDLC) 2.0 TFSi (07-13); Seat Altea (BMM) 2.0 TDi MPV Man. (06-09), Leon (BKD, BMM, CFHC, CLCB) 2.0 TDi Man. (06-09); Volkswagen Golf V (BKD) 2.0 TDi DSG Sport, Sport Tiptronic, Sport 5-Spd. Man. (04-09), Golf VI (CAXA, CAVD) 1.4 TSi Trendline, Comfortline, HighLine, (BSE, BSF, CCSA) 1.6i Trendline, (CAYC) 1.6 TDi Comfortline, DSG, Bluemotion, (CBAB, CFFB) 2.0 TDi HighLine, (CCZB) 2.0 GTi DSG, 2.0 TSi-R 4-Motion, DSG (09-13), Jetta V (AZV, BKD, BMM) 2.0 TDi Sportline, Tiptronic, HighLine 5-Spd. Man. (2005-), Jetta VI (CFHC, CJAA, CLCB) 2.0 TDi Man. (2011-), Passat V (BMP) 2.0 TDi Comfortline, HighLine, DSG, (AXZ) 3.2 FSi Sportline, DSG (05-11), Passat (CFFB) 2.0 TDi (11-16), Tiguan 4X2, 4X4 (CBAB) 2.0 TDi Man. Track&Field, Sport&Style, Trend&Fun (08-11), (CAXA) 1.4 TSi, (CAVD, CTHD) 1.4 TSi 4-Motion, (CFFD) 2.0 TDi, (CCZB) 2.0 TSi 4-Motion (11-17), Touran (AZV) 2.0 TDi MPV Comfortline, HighLine, Man. (04-11), (CFHF, CLCA) 2.0 TDi (2011-)</p>
 <p>ID: 18, L: 46, H: 47, W: 38</p>	<p>AR7011 Front Stabilizer Bar Bush Ford Fiesta II (Zetec) 1.4i Trend, (Rocam, Zetec) 1.6i Ambiente, Ghia, Trend, 2.0i ST150, ST (04-09), Figo 1.4 TDCi Ambiente, (FXJA, FXJB) 1.4i Ambiente, Trend (10-16), Ikon 1.4. 1.4 TDCi. 1.6, i (07-11)</p>
 <p>ID: 12</p>	<p>AR7012 Front Lower Control Arm Bush - Inner Front Ford Fiesta II (Zetec) 1.4i Trend, (Rocam, Zetec) 1.6i Ambiente, Ghia, Trend, 2.0i ST150, ST (04-09), Figo 1.4 TDCi Ambiente, (FXJA, FXJB) 1.4i Ambiente, Trend (10-16), Ikon 1.4. 1.4 TDCi. 1.6, i (07-11); Mazda 2 (DE) (ZJ-VE) 1.3, (ZY-DE/VE) 1.5 (07-15)</p>
 <p>ID: 22</p>	<p>AR7013 Front Lower Control Arm Bush - Outer Rear Ford Fiesta II (Zetec) 1.4i Trend, (Rocam, Zetec) 1.6i Ambiente, Ghia, Trend, 2.0i ST150, ST (04-09), Figo 1.4 TDCi Ambiente, (FXJA, FXJB) 1.4i Ambiente, Trend (10-16), Ikon 1.4. 1.4 TDCi. 1.6, i (07-11); Mazda 2 (DE) (ZJ-VE) 1.3, (ZY-DE/VE) 1.5 (07-15)</p>

ENGINE MOUNTING & RUBBER BUYERS GUIDE

	<p>AR7014 Engine Mounting - RHS (No Bracket)</p> <p>Audi A1 (CBZA) 1.2 TFSi, Sportback 63kw 5-Spd. Man., (CAXA) 1.4 TFSi, Sportback 90kw 6-Spd. Man., 7-Spd. S-Tronic, (CAVG) 1.4 TFSi, Sportback 136kw 7-Spd. S-Tronic (11-18); Seat Ibiza III (BXW) 1.4, (BAH) 1.6 (2006-); Volkswagen Polo (9N) (AXU) 1.4 62kw 5-Spd. Man., (AMF, BAY) 1.4 TDi 55kw 5-Spd. Man., (BMS, BNV) 1.4 TDi 59kw 5-Spd. Man., (BTS) 1.6 77kw 5-Spd. Man., (BJX) 1.8 TSi GTi 110kw 6-Spd. Man., (ATD, AXR) 1.9 TDi 74kw 5-Spd. Man., (ASZ, BLT) 1.9 TDi 96kw 6-Spd. Man., (BBX) 2.0 85kw 5-Spd. Man. (2002-), Polo (6R) (CGGB) 1.4 63kw 5-Spd. Man., (CLPA) 1.4 63kw 5-Spd. Man., (CAYC, CLNA) 1.6 TDi 77kw 5-Spd. Man., (CLSA) 1.6 77kw 5-Spd. Man. (2010-), Polo (6C) (CGGB) 1.4 63kw 5-Spd. Man., (CLPA) 1.4 63kw 5-Spd. Man., (CLSA) 1.6 77kw 5-Spd. Man. (2016-), Polo (6C, GP) (CJZC) 1.2 TSi 66kw 5-Spd. Man., (CJZD) 1.2 TSi 81kw 5-Spd. Man., 7-Spd. DSG (2014-), Polo Vivo I (CLPB) 1.4 55kw 5-Spd. Man., 1.4 63kw 5-Spd. Man., (CLSA) 1.6 77kw 5-Spd. Man. (2010-)</p>	 <p>ID: 20, L: 29, H: 34, W: 34</p>	<p>AR7023 Front Stabilizer Bar Bush</p> <p>Audi A3 (AGN) 1.8, (AGU, BFU) 1.8T (98-04) - from 8L-W-001 702; Seat Altea (BVG, BVZ) 2.0 FSi, (BMM) 2.0 TDi MPV (06-09), Leon (BLR, BLY, BVZ) 2.0 FSi, (BKD, BMM, CFHC, CLCB) 2.0 TDi, (BWA, BWJ, CDLD) 2.0T, FSi (06-09); Volkswagen Beetle (9C1, 9V1) (APH/AWU) 1.8T Coupe, (1Y7) (AEG) 2.0i Cabriolet, Coupe, HighLine, (9C1) (AEG) 2.0i Cabriolet, Coupe, HighLine (00-12), Golf IV 1.6i Comfortline, Std., Tiptronic, 1.8 GTi HighLine, 1.8T GTi, 1.9 TDi HighLine, Comfortline, DSG, 2.0i Cabrio, HighLine (99-04), Golf V (BGU) 1.6i Comfortline, Tiptronic, Trendline, (BLS, BXE) 1.9 TDi Comfortline, DSG, (BKD) 2.0 TDi DSG Sport, Sport Tiptronic, Sport 5-Spd. Man., 6-Spd. Auto., (BLX) 2.0i Trendline, GTi DSG, Comfortline, GTi 5-Spd. Man., 6-Spd. Auto., (BLY) 2.0 FSi Sport, Sport Tiptronic 6-Spd. Man., Auto. (04-09), Golf VI (CAXA, CAVD) 1.4 TSi Trendline, Comfortline, HighLine, (BSE, BSF, CCSA) 1.6i Trendline, (CAYC) 1.6 TDi Comfortline, DSG, Bluemotion, (CBAB, CFFB) 2.0 TDi HighLine, (CCZB) 2.0 GTi DSG, 2.0 TSi-R 4-Motion, DSG (09-13), Jetta IV 1.6i Comfortline Std. 5-Spd. Man., 4-Spd. Auto., 1.9 TDi HighLine 5-Spd. Man., 2.0i HighLine 5-Spd. Man., 2.3 V5 5-Spd. Man. (99-05), Jetta V (CAVD, CAXA) 1.4 TSi Trendline, Comfortline, DSG, HighLine, (CAYC) 1.6 TDi Comfortline, DSG (09-11), 1.6i Comfortline, Tiptronic, Trendline, (BKC) 1.9 TDi Comfortline, DSG, (BHY) 2.0i Trendline, DSG, Comfortline, 5-Spd. Man., 6-Spd. Auto., (BHY) 2.0i Trendline, DSG, Comfortline, 5-Spd. Man., 6-Spd. Auto., 2.0 FSi, TFSi, Sportline, Tiptronic 6-Spd. Man./Auto. (05-11), (AZV, BKD, BMM) 2.0 TDi Sportline, Tiptronic, HighLine 5-Spd. Man., 6-Spd. Auto., 2.0 TSi HighLine (2005-), Jetta VI (CBZB) 1.2 TSi, (CAVD, CAXA) 1.4 TSi, (CAYC) 1.6 TDi, (CFHC, CJAA, CLCB) 2.0 TDi (2011-), Scirocco (CAVD) 1.4 TSi, (CDLF) 2.0 TSi, DSG, R (2009-), Tiguan 4X2, 4X4 (BWK, CAVA) 1.4 TSi Trend&Fun, Track&Field, (CBAB) 2.0 TDi Track&Field, Sport&Style, Trend&Fun, (CCZA) 2.0 TSi Track&Field, Sport&Style, 4-Motion (08-11)</p>
	<p>AR7015 Engine Mounting - LHS</p> <p>Ford Fiesta I (Endura EM5) 1.3i Flair, Flite, Fun Play, (CVH, PTE) 1.4i Flair, Flite, Fun, (Rocam) 1.6i Flair, Forte, RSi, Sport (97-04), Fiesta II (Zetec) 1.4i Trend, (Rocam, Zetec) 1.6i Ambiente, Ghia, Trend, 2.0i ST150, ST (04-09), Ikon 1.4. 1.4 TDCi. 1.6, i (07-11)</p>		<p>AR7024 Steering Rack Mounting</p> <p>Audi A3 (AGN) 1.8, (AGU, BFU) 1.8T (98-04); Volkswagen Beetle (9C1, 9V1) (APH/AWU) 1.8T Coupe, (1Y7) (AEG) 2.0i Cabriolet, Coupe, HighLine, (9C1) (AEG) 2.0i Cabriolet, Coupe, HighLine (00-12)</p>
	<p>AR7017 Transmission Mounting</p> <p>Ford Fiesta II (Zetec) 1.4i Trend, (Rocam, Zetec) 1.6i Ambiente, Ghia, Trend, 2.0i ST150, ST (04-09), Figio 1.4 TDCi Ambiente, (FXJA, FXJB) 1.4i Ambiente, Trend (10-16), Ikon 1.4. 1.4 TDCi. 1.6, i (07-11)</p>		<p>AR7025 Front Strut Mounting</p> <p>Audi A1 (CHZB) 1.0, (CBZA) 1.2 TFSi, (CAVG, CAXA) 1.4 TFSi, (CAYC) 1.6 TDi Hatch 3-Dr, Sportback, (DAJB) 1.8 (11-18), A3 (AGN) 1.8, (AGU, BFU) 1.8T (98-04); Volkswagen Beetle (9C1, 9V1) (APH/AWU) 1.8T Coupe, (1Y7) (AEG) 2.0i Cabriolet, Coupe, HighLine, (9C1) (AEG) 2.0i Cabriolet, Coupe, HighLine (00-12), Golf IV 1.6i Comfortline, Std., Tiptronic, 1.8 GTi HighLine, 1.8T GTi, 1.9 TDi HighLine, Comfortline, DSG, 2.0i Cabrio, HighLine (99-04), Jetta IV 1.6i Comfortline Std. 5-Spd. Man., 4-Spd. Auto., 1.9 TDi HighLine 5-Spd. Man., 2.0i HighLine 5-Spd. Man., 2.3 V5 5-Spd. Man. (99-05), Polo (CBZB) 1.2 Trendline DSG Pet., (CBZC) 1.2 TSi Comfortline Man. Pet., (CFWA) 1.2 TDi Trendline, BlueMotion Man. DSL, (CGPA, CGPB) 1.2 Man., (CTHE) 1.4 TSi GTi DSG (2010-), Polo (6C) (CJZC, CJZD) 1.2 TSi, (CDDA, CGGB, CLPA) 1.4, (CUTA, CYZB) 1.4 TDi, (CWXC) 1.5 TDi, (CFNA, CLSA) 1.6, (DAJA) 1.8 TSi, GTi (2014-), Polo (CHYA, CHYB) 1.0 Comfortline, Trendline BlueMotion Hatch (2014-), Polo (GP) (CHZB) 1.0 TSi BlueMotion 5-dr, (CHZC) 1.0 TSi Comfortline, TSi-R-Line DSG (15-17), Polo (AW1, BZ1) 1.0 TSi GT (2018-), Up (CHYB) 1.0 (2015-)</p>
 <p>ID: 12,5</p>	<p>AR7018 Front Strut Mounting (without Bearing)</p> <p>Ford Fiesta II (Zetec) 1.4i Trend, (Rocam, Zetec) 1.6i Ambiente, Ghia, Trend, 2.0i ST150, ST (04-09), Figio 1.4 TDCi Ambiente, (FXJA, FXJB) 1.4i Ambiente, Trend (10-16), Ikon 1.4. 1.4 TDCi. 1.6, i (07-11)</p>		<p>AR7026 Engine Mounting - Front</p> <p>Audi A3 (CMSA) 1.4 TFSi, (CAYC) 1.6 TDi, (CDA) 1.8 TFSi, (BXE) 1.9 TDi, (CLJA) 2.0 TDi (08-13), A4 (8D2, B5) (APU) 1.8T Avant, Multitronic, SW (95-01), (CAEB, CDNC, CGLC, CMGB) 2.0 TFSi, Quattro, 2.0 TFSi Multitronic, Quattro (08-14), A6 (AGA, ALF, AMC, APS, ARJ, BDV, BDW) 2.4, (ACK) 2.8 Avant Quattro, (ARS) 4.2 V8 Quattro, Tiptronic (97-05)</p>
 <p>ID: 26, OD: 68, L: 46</p>	<p>AR7018B Front Strut Mounting (with Bearing)</p> <p>Ford Fiesta II (Zetec) 1.4i Trend, (Rocam, Zetec) 1.6i Ambiente, Ghia, Trend, 2.0i ST150, ST (04-09), Figio 1.4 TDCi Ambiente, (FXJA, FXJB) 1.4i Ambiente, Trend (10-16), Ikon 1.4. 1.4 TDCi. 1.6, i (07-11)</p>	 <p>ID: 28, OD: 80, L: 52</p>	<p>AR7021 Transmission Mounting</p> <p>Audi A3 (AGN) 1.8, (AGU, BFU) 1.8T (98-04); Volkswagen Beetle (9C1, 9V1) (APH/AWU) 1.8T Coupe, (1Y7) (AEG) 2.0i Cabriolet, Coupe, HighLine, (9C1) (AEG) 2.0i Cabriolet, Coupe, HighLine (00-12), Golf IV 1.6i Comfortline, Std., Tiptronic, 1.8 GTi HighLine, 1.8T GTi, 1.9 TDi HighLine, Comfortline, DSG, 2.0i Cabrio, HighLine (99-04), Jetta IV 1.6i Comfortline Std. 5-Spd. Man., 4-Spd. Auto., 1.9 TDi HighLine 5-Spd. Man., 2.0i HighLine 5-Spd. Man., 2.3 V5 5-Spd. Man. (99-05)</p>
	<p>AR7019 Engine Mounting - RHS</p> <p>Audi A3 (AGN) 1.8, (AGU, BFU) 1.8T (98-04); Volkswagen Beetle (9C1, 9V1) (APH/AWU) 1.8T Coupe, (1Y7) (AEG) 2.0i Cabriolet, Coupe, HighLine, (9C1) (AEG) 2.0i Cabriolet, Coupe, HighLine (00-12), Golf IV 1.6i Comfortline, Std., Tiptronic, 1.8 GTi HighLine, 1.8T GTi, 1.9 TDi HighLine, Comfortline, DSG, 2.0i Cabrio, HighLine (99-04), Jetta IV 1.6i Comfortline Std. 5-Spd. Man., 4-Spd. Auto., 1.9 TDi HighLine 5-Spd. Man., 2.0i HighLine 5-Spd. Man., 2.3 V5 5-Spd. Man. (99-05)</p>	 <p>ID: 17, L: 20, H: 34, W: 38</p>	<p>AR7022 Front Stabilizer Bar Bush</p> <p>Audi A3 (AGN) 1.8, (AGU, BFU) 1.8T (98-04) - to 8L-W-001 701, (BVZ) 2.0 FSi, (BMM, CLJA) 2.0 TDi (03-13); Volkswagen Beetle (9C1, 9V1) (APH/AWU) 1.8T Coupe, (1Y7) (AEG) 2.0i Cabriolet, Coupe, HighLine, (9C1) (AEG) 2.0i Cabriolet, Coupe, HighLine (00-12)</p>
 <p>ID: 26, OD: 68, L: 46</p>	<p>AR7020 Engine Mounting - Front</p> <p>Audi A3 (CMSA) 1.4 TFSi, (CAYC) 1.6 TDi, (CDA) 1.8 TFSi, (BXE) 1.9 TDi, (CLJA) 2.0 TDi (08-13), A4 (8D2, B5) (APU) 1.8T Avant, Multitronic, SW (95-01), (CAEB, CDNC, CGLC, CMGB) 2.0 TFSi, Quattro, 2.0 TFSi Multitronic, Quattro (08-14), A6 (AGA, ALF, AMC, APS, ARJ, BDV, BDW) 2.4, (ACK) 2.8 Avant Quattro, (ARS) 4.2 V8 Quattro, Tiptronic (97-05)</p>		<p>AR7022 Front Stabilizer Bar Bush</p> <p>Audi A3 (AGN) 1.8, (AGU, BFU) 1.8T (98-04) - to 8L-W-001 701, (BVZ) 2.0 FSi, (BMM, CLJA) 2.0 TDi (03-13); Volkswagen Beetle (9C1, 9V1) (APH/AWU) 1.8T Coupe, (1Y7) (AEG) 2.0i Cabriolet, Coupe, HighLine, (9C1) (AEG) 2.0i Cabriolet, Coupe, HighLine (00-12)</p>

ENGINE MOUNTING & RUBBER BUYERS GUIDE

	<p>AR7026 Rear Strut Mounting</p> <p>Audi A1 (CHZB) 1.0, (CBZA) 1.2 TFSi, (CAVG, CAXA) 1.4 TFSi, (CAYC) 1.6 TDi Hatch 3-Dr, Sportback, (DAJB) 1.8 (11-18); Volkswagen Golf IV 1.6i Comfortline, Std., Tiptronic, 1.8 GTi HighLine, 1.8T GTi, 1.9 TDi HighLine, Comfortline, DSG, 2.0i Cabrio, HighLine (99-04), Polo (9N) (BBY, BKY, BLM) 1.4i, Classic, Trendline, Comfortline, (AMF) 1.4 TDi, Classic, (BAH) 1.6i, Classic Lux, Comfortline, Trendline, SE, (ATD) 1.9 TDi, HighLine, Classic, HighLine, Sportline, (BBU, BJX) 1.8T GTi Classic, Trendline, (ASZ, BBX) 2.0i HighLine, Classic HighLine (02-10), Cross Polo 1.6 TDi, 1.9 TDi (07-10), Polo (CBZB) 1.2 Trendline DSG Pet., (CBZC) 1.2 TSi Comfortline Man. Pet., (CFWA) 1.2 TDi Trendline, BlueMotion Man. DSL, (CGPA, CGPB) 1.2 Man., (CTHE) 1.4 TSi GTi DSG (2010-), Polo (6R) (CAVE, CDDA, CGGB, CLPA) 1.4i Trendline, Comfortline, GTi, (CFNA, CLSA) 1.6i Comfortline, Trendline, Tiptronic, (CAYC) 1.6 TDi Comfortline (10-15), Polo (6C) (CJZC, CJZD) 1.2 TSi, (CDDA, CGGB, CLPA) 1.4, (CUTA, CYZB) 1.4 TDi, (CWXC) 1.5 TDi, (CFNA, CLSA) 1.6, (DAJA) 1.8 TSi, GTi (2014-), Polo (CHYA, CHYB) 1.0 Comfortline, Trendline BlueMotion Hatch (2014-), Polo (GP) (CHZB) 1.0 TSi BlueMotion 5-dr, (CHZC) 1.0 TSi Comfortline, TSi-R-Line DSG (15-17)</p>	<p>AR7033 Steering Rack Mounting</p> <p>Volkswagen Caddy (HM, HV, JK) 1.6, i P/up Dies., Pet. 4-Spd. Man., (HV) 1.8 L Sport, Sport, P/up (96-03), Citi Golf 1.4 L, Chico, (AGY, BSY) 1.4i, L, Citi.com, VeloCiti, TenaCiti, CitiStorm, Sport, Rox, Rhythm Man., (AFX) 1.6i Life, Velociti, TenaCiti, CitiStorm, Sport, Rox 5-Spd. Man. (99-09), Golf II 1.3 CL 4-Spd. Man., 1.6 CSL 5-Spd. Man., 1.8 GTS 16V, CSX, GTi 8V, 16V, 5-Spd. Man., 3-Spd. Auto., 2.0 GTi 8V, Exec. 16V 5-Spd. Man. (84-92) - M/S, Golf III 1.6 GS 5-Spd. Man., 1.8 GSX, GTS 5-Spd. Man., 3-Spd. Auto., 2.0 GTi, 8V GTi Exec. 5-Spd. Man., 2.8 VR6, VR6 Exec. V6 5-Spd. Man., 4-Spd. Auto. (92-99) - M/S, Jetta II 1.6 CSL 5-Spd. Man., 1.8 CLi, CLi Exec., Executive, CLX, CSX 5-Spd. Man., 3-Spd. Auto., 2.0 L 16V 5-Spd. Man. (85-92) - M/S, Jetta III 1.6 CSL 5-Spd. Man., 1.8 CLX, CSX 5-Spd. Man., 3-Spd. Auto., 2.0 CLi, CLi Exec. 5-Spd. Man., 2.8 VR6 Exec. V6 5-Spd. Man., 4-Spd. Auto. (92-99) - M/S, Polo (6N) 1.4i Classic, Playa, 1.6i Classic Lux, Classic, Playa, 1.8i Classic Lux, Playa 5-Spd. Man. (96-03) - M/S</p> <p>ID: 50.5, L: 20, H: 73, W: 28</p>
	<p>AR7027 Rear Strut Mounting</p> <p>Audi A3 (AGN) 1.8, (AGU, BFU) 1.8T (98-04); Seat Ibiza (BXW) 1.4 Sport, (BAH) 1.6, 1.9 TDi, Cupra (BPX), 96/118 (ASZ, BLT, BUK) (06-09), Ibiza (BBU) 1.8T, 2.0 (06-09); Volkswagen Polo (AW1, BZ1) 1.0 TSi GT (2018-)</p>	<p>AR7034 Rear Axle Carrier Bush - Rear Inner LHS</p> <p>BMW 3-Series (E46) 318i (M43) 1.8, (M43) 2.0 Touring SW, (N42) 2.0, 318ti (M47B) 2.0 Compact, 320d (M47D) 2.0 (98-05), 320i (M52) 2.0, (M54) 2.2, 323Ci (M52) 2.5 Coupe, 323i (M52) 2.5, 325Ci (M54) 2.5 Coupe, 325i, 325ti (M50, M54) 2.5 Touring SW, Compact (99-05), 328i (M52TU) 2.8 Coupe, 330Ci (M54) 3.0 Convertible, 330d (M57) 3.0 Dies., 330i (M54) 3.0 (99-05)</p> <p>ID: 15, OD: 69, L: 61</p>
	<p>AR7028 Rear Stabilizer Bar Bush</p> <p>Audi A3 (AGN) 1.8, (AGU, BFU) 1.8T (98-04); Volkswagen Beetle (9C1, 9V1) (APH/ AWU) 1.8T Coupe, (1Y7) (AEG) 2.0i Cabriolet, Coupe, HighLine, (9C1) (AEG) 2.0i Cabriolet, Coupe, HighLine (00-12), Golf III 1.6 GS 5-Spd. Man., 1.8 GSX, GTS 5-Spd. Man., 3-Spd. Auto., 2.0 GTi, 8V GTi Exec. 5-Spd. Man., 2.8 VR6, VR6 Exec. V6 5-Spd. Man., 4-Spd. Auto. (92-99), Golf IV 1.6i Comfortline, Std., Tiptronic, 1.8 GTi HighLine, 1.8T GTi, 1.9 TDi HighLine, Comfortline, DSG, 2.0i Cabrio, HighLine (99-04), Jetta III 1.6 CSL 5-Spd. Man., 1.8 CLX, CSX 5-Spd. Man., 3-Spd. Auto., 2.0 CLi, CLi Exec. 5-Spd. Man., 2.8 VR6 Exec. V6 5-Spd. Man., 4-Spd. Auto. (92-99), Jetta IV 1.6i Comfortline Std. 5-Spd. Man., 4-Spd. Auto., 1.9 TDi HighLine 5-Spd. Man., 2.0i HighLine 5-Spd. Man., 2.3 V5 5-Spd. Man. (99-05), Polo (CBZB) 1.2 Trendline DSG Pet., (CBZC) 1.2 TSi Comfortline Man. Pet., (CFWA) 1.2 TDi Trendline, BlueMotion Man. DSL, (CGPA, CGPB) 1.2 Man., (CTHE) 1.4 TSi GTi DSG (2010-), Polo (CHYA, CHYB) 1.0 Comfortline, Trendline BlueMotion Hatch (2014-), Polo (GP) (CHZB) 1.0 TSi BlueMotion 5-dr, (CHZC) 1.0 TSi Comfortline, TSi-R-Line DSG (15-17)</p>	<p>AR7037 Rear Strut Mounting - Upper</p> <p>Volkswagen Citi Golf 1.3 L, Chico, L Shuttle 4-Spd. Man., Chico Lux, (HM) 1.6 L, Chico Lux, Deco, Designa, Blues, Ritz, Shuttle, Sonic, Sport Chico 4/5-Spd. Man., 3-Spd. Auto., (BZF) 1.8 CTi, Designa, L Sport, 5-Spd. Man. (83-02), 1.4 L, Chico, (AGY, BSY) 1.4i, L, Citi.com, VeloCiti, TenaCiti, CitiStorm, Sport, Rox, Rhythm Man., (AFX) 1.6i Life, Velociti, TenaCiti, CitiStorm, Sport, Rox 5-Spd. Man. (99-09), Fox 1.3 L, L Trippa 4-Spd. Man., 1.6 L 4/5-Spd. Man., 3-Spd. Auto., 1.8 L Sport 5-Spd. Man. (87-96), Golf II 1.3 CL 4-Spd. Man., 1.6 CSL 5-Spd. Man., 1.8 GTS 16V, CSX, GTi 8V, 16V, 5-Spd. Man., 3-Spd. Auto., 2.0 GTi 8V, Exec. 16V 5-Spd. Man. (84-92), Golf III 1.6 GS 5-Spd. Man., 1.8 GSX, GTS 5-Spd. Man., 3-Spd. Auto., 2.0 GTi, 8V GTi Exec. 5-Spd. Man., 2.8 VR6, VR6 Exec. V6 5-Spd. Man., 4-Spd. Auto. (92-99), Jetta II 1.6 CSL 5-Spd. Man., 1.8 CLi, CLi Exec., Executive, CLX, CSX 5-Spd. Man., 3-Spd. Auto., 2.0 L 16V 5-Spd. Man. (85-92), Jetta III 1.6 CSL 5-Spd. Man., 1.8 CLX, CSX 5-Spd. Man., 3-Spd. Auto., 2.0 CLi, CLi Exec. 5-Spd. Man., 2.8 VR6 Exec. V6 5-Spd. Man., 4-Spd. Auto. (92-99), Polo (6N) 1.4i Classic, Playa, 1.6i Classic Lux, Classic, Playa, 1.8i Classic Lux, Playa 5-Spd. Man. (96-03)</p> <p>ID: 31, L: 32, H: 38, W: 48</p>
	<p>AR7029 Front Axle X-Member Bush</p> <p>Audi A3 (AGN) 1.8, (AGU, BFU) 1.8T (98-04); Volkswagen Beetle (9C1, 9V1) (APH/ AWU) 1.8T Coupe, (1Y7) (AEG) 2.0i Cabriolet, Coupe, HighLine, (9C1) (AEG) 2.0i Cabriolet, Coupe, HighLine (00-12), Golf IV 1.6i Comfortline, Std., Tiptronic, 1.8 GTi HighLine, 1.8T GTi, 1.9 TDi HighLine, Comfortline, DSG, 2.0i Cabrio, HighLine (99-04), Jetta IV 1.6i Comfortline Std. 5-Spd. Man., 4-Spd. Auto., 1.9 TDi HighLine 5-Spd. Man., 2.0i HighLine 5-Spd. Man., 2.3 V5 5-Spd. Man. (99-05)</p>	<p>AR7038 Rear Strut Mounting - Lower</p> <p>Volkswagen Citi Golf 1.3 L, Chico, L Shuttle 4-Spd. Man., Chico Lux, (HM) 1.6 L, Chico Lux, Deco, Designa, Blues, Ritz, Shuttle, Sonic, Sport Chico 4/5-Spd. Man., 3-Spd. Auto., (BZF) 1.8 CTi, Designa, L Sport, 5-Spd. Man. (83-02), 1.4 L, Chico, (AGY, BSY) 1.4i, L, Citi.com, VeloCiti, TenaCiti, CitiStorm, Sport, Rox, Rhythm Man., (AFX) 1.6i Life, Velociti, TenaCiti, CitiStorm, Sport, Rox 5-Spd. Man. (99-09), Fox 1.3 L, L Trippa 4-Spd. Man., 1.6 L 4/5-Spd. Man., 3-Spd. Auto., 1.8 L Sport 5-Spd. Man. (87-96), Golf II 1.3 CL 4-Spd. Man., 1.6 CSL 5-Spd. Man., 1.8 GTS 16V, CSX, GTi 8V, 16V, 5-Spd. Man., 3-Spd. Auto., 2.0 GTi 8V, Exec. 16V 5-Spd. Man. (84-92), Golf III 1.6 GS 5-Spd. Man., 1.8 GSX, GTS 5-Spd. Man., 3-Spd. Auto., 2.0 GTi, 8V GTi Exec. 5-Spd. Man., 2.8 VR6, VR6 Exec. V6 5-Spd. Man., 4-Spd. Auto. (92-99), Jetta II 1.6 CSL 5-Spd. Man., 1.8 CLi, CLi Exec., Executive, CLX, CSX 5-Spd. Man., 3-Spd. Auto., 2.0 L 16V 5-Spd. Man. (85-92), Jetta III 1.6 CSL 5-Spd. Man., 1.8 CLX, CSX 5-Spd. Man., 3-Spd. Auto., 2.0 CLi, CLi Exec. 5-Spd. Man., 2.8 VR6 Exec. V6 5-Spd. Man., 4-Spd. Auto. (92-99), Polo (6N) 1.4i Classic, Playa, 1.6i Classic Lux, Classic, Playa, 1.8i Classic Lux, Playa 5-Spd. Man. (96-03)</p>
 <p>ID: 42, L: 20, H: 58, W: 59</p>	<p>AR7030 Steering Rack Mounting - LHS</p> <p>Volkswagen Caddy (HM, HV, JK) 1.6, i P/up Dies., Pet. 4-Spd. Man., (HV) 1.8 L Sport, Sport, P/up (81-86), Fox 1.3 L, L Trippa 4-Spd. Man., 1.6 L 4/5-Spd. Man., 3-Spd. Auto., 1.8 L Sport 5-Spd. Man. (87-96)</p>	<p>AR7031 Steering Rack Mounting - RHS</p> <p>Volkswagen Caddy (HM, HV, JK) 1.6, i P/up Dies., Pet. 4-Spd. Man., (HV) 1.8 L Sport, Sport, P/up (81-96), Fox 1.3 L, L Trippa 4-Spd. Man., 1.6 L 4/5-Spd. Man., 3-Spd. Auto., 1.8 L Sport 5-Spd. Man. (87-96)</p> <p>ID: 36, L: 20, H: 58, W: 61</p>

ENGINE MOUNTING & RUBBER BUYERS GUIDE

	<p>AR7039 Engine Mounting - LHS Front, Transmission Mounting</p> <p>Volkswagen Caddy (HM, HV, JK) 1.6, i P/up Dies., Pet. 4-Spd. Man., (HV) 1.8 L Sport, Sport, P/up (96-03), Citi Golf 1.4 L, Chico, (AGY, BSY) 1.4i, L, Citi.com, VeloCiti, TenaCiti, CitiStorm, Sport, Rox, Rhythm Man., (AFX) 1.6i Life, Velociti, TenaCiti, CitiStorm, Sport, Rox 5-Spd. Man. (99-09), Golf III 1.6 GS 5-Spd. Man., 1.8 GSX, GTS 5-Spd. Man., 3-Spd. Auto., 2.0 GTI, 8V GTI Exec. 5-Spd. Man. (92-99), Jetta III 1.6 CSL 5-Spd. Man., 1.8 CLX, CSX 5-Spd. Man., 3-Spd. Auto., 2.0 CLi, CLi Exec. 5-Spd. Man., 2.8 VR6 Exec. V6 5-Spd. Man., 4-Spd. Auto. (92-99), Polo (6N) 1.6i Classic Lux, Classic, Playa, 1.8i Classic Lux, Playa 5-Spd. Man. (96-03)</p>	 <p>AR7044 Engine Mounting - Rear Support</p> <p>Audi A3 (AGN) 1.8, (AGU, BFU) 1.8T (98-04); Volkswagen Beetle (9C1, 9V1) (APH/AWU) 1.8T Coupe, (1Y7) (AEG) 2.0i Cabriolet, Coupe, HighLine, (9C1) (AEG) 2.0i Cabriolet, Coupe, HighLine (00-12), Golf IV 1.6i Comfortline, Std., Tiptronic, 1.8 GTI HighLine, 1.8T GTI, 1.9 TDi HighLine, Comfortline, DSG, 2.0i Cabrio, HighLine (99-04) - Man. Models, Jetta IV 1.6i Comfortline Std. 5-Spd. Man., 4-Spd. Auto., 1.9 TDi HighLine 5-Spd. Man., 2.0i HighLine 5-Spd. Man., 2.3 V5 5-Spd. Man. (99-05)</p>
 <p>ID: 14, OD: 62, H: 67</p>	<p>AR7040 Engine Mounting - LHS Front, Transmission Mounting</p> <p>Volkswagen Golf III 2.8 VR6, VR6 Exec. V6 5-Spd. Man., 4-Spd. Auto. (92-99), Jetta III 2.8 VR6 Exec. V6 5-Spd. Man., 4-Spd. Auto. (92-99)</p>	 <p>ID: 22</p> <p>AR7045 Rear Stabilizer Bar Bush</p> <p>Volkswagen Golf IV 1.6i Comfortline, Std., Tiptronic, 1.8 GTI HighLine, 1.8T GTI, 1.9 TDi HighLine, Comfortline, DSG, 2.0i Cabrio, HighLine (99-04), Jetta IV 1.6i Comfortline Std. 5-Spd. Man., 4-Spd. Auto., 1.9 TDi HighLine 5-Spd. Man., 2.0i HighLine 5-Spd. Man., 2.3 V5 5-Spd. Man. (99-05)</p>
 <p>ID: 23, L: 22, H: 37.5, W: 36</p>	<p>AR7041 Front Stabilizer Bar Bush</p> <p>Seat Altea (BVY, BVZ) 2.0 FSi, (BMM) 2.0 TDi MPV (06-09), Leon (BLR, BLY, BVZ) 2.0 FSi, (BKD, BMM, CFHC, CLCB) 2.0 TDi, (BWA, BWJ, CDLD) 2.0T, FSi (06-09); Volkswagen Beetle (9C1, 9V1) (APH/AWU) 1.8T Coupe, (1Y7) (AEG) 2.0i Cabriolet, Coupe, HighLine, (9C1) (AEG) 2.0i Cabriolet, Coupe, HighLine (00-12), Caddy (BGU) 1.6i Life Van, MPV, (BJB) 1.9 TDi, Life Van, MPV, (BDJ) 2.0 SDi Van (04-16), Golf IV 1.6i Comfortline, Std., Tiptronic, 1.8 GTI HighLine, 1.8T GTI, 1.9 TDi HighLine, Comfortline, DSG, 2.0i Cabrio, HighLine (99-04), Golf V (BGU) 1.6i Comfortline, Tiptronic, Trendline, (BLS, BXE) 1.9 TDi Comfortline, DSG, (BKD) 2.0 TDi DSG Sport, Sport Tiptronic, Sport 5-Spd. Man., 6-Spd. Auto., (BLX) 2.0i Trendline, GTI DSG, Comfortline, GTI 5-Spd. Man., 6-Spd. Auto., (BLY) 2.0 FSi Sport, Sport Tiptronic 6-Spd. Man., Auto. (04-09), Golf VI (CAXA, CAVD) 1.4 TSi Trendline, Comfortline, HighLine, (BSE, BSF, CCSA) 1.6i Trendline, (CAYC) 1.6 TDi Comfortline, DSG, Bluemotion, (CBAB, CFFB) 2.0 TDi HighLine, (CCZB) 2.0 GTI DSG, 2.0 TSi-R 4-Motion, DSG (09-13), Jetta IV 1.6i Comfortline Std. 5-Spd. Man., 4-Spd. Auto., 1.9 TDi HighLine 5-Spd. Man., 2.0i HighLine 5-Spd. Man., 2.3 V5 5-Spd. Man. (99-05), Jetta V (CAVD, CAXA) 1.4 TSi Trendline, Comfortline, DSG, HighLine, (CAYC) 1.6 TDi Comfortline, DSG (09-11), 1.6i Comfortline, Tiptronic, Trendline, (BKC) 1.9 TDi Comfortline, DSG, (BHY) 2.0i Trendline, DSG, Comfortline, 5-Spd. Man., 6-Spd. Auto., (BHY) 2.0i Trendline, DSG, Comfortline, 5-Spd. Man., 6-Spd. Auto., 2.0 FSi, TFSi, Sportline, Tiptronic 6-Spd. Man./Auto. (05-11), (AZV, BKD, BMM) 2.0 TDi Sportline, Tiptronic, HighLine 5-Spd. Man., 6-Spd. Auto., 2.0 TSi HighLine (2005-), Jetta VI (CBZB) 1.2 TSi, (CAVD, CAXA) 1.4 TSi, (CAYC) 1.6 TDi, (CFHC, CJAA, CLCB) 2.0 TDi (2011-), Passat V (BZB, CDAA) 1.8 TSi Comfortline, DSG, HighLine, (BKC, BLS, BXE) 1.9 TDi Comfortline, DSG, HighLine, (AXX, BLR, BLY, BPY, BVY, BVZ, BWA, CAWB, CBFA, CCZ/TA) 2.0 FSi, TFSi Comfortline, HighLine, (BMP) 2.0 TDi Comfortline, HighLine, DSG, (AXZ) 3.2 FSi Sportline, DSG (05-11), Scirocco (CAVD) 1.4 TSi, (CDLF) 2.0 TSi, DSG, R (2009-), Tiguan 4X2, 4X4 (BWK, CAVA) 1.4 TSi Trend&Fun, Track&Field, (CBAB) 2.0 TDi Track&Field, Sport&Style, Trend&Fun, (CCZA) 2.0 TSi Track&Field, Sport&Style, 4-Motion (08-11), Touran (BGU, BSE, BSF) 1.6 5-Spd. Man., (BKC, BLS, BXE) 1.9 TDi MPV TrendLine, DSG, (AZV) 2.0 TDi MPV Comfortline, HighLine, DSG, (BLY) 2.0 FSi MPV HighLine (04-11), (CBZB) 1.2 TSi, (CAVC, CTHC) 1.4 TSi, (CFHF, CLCA) 2.0 TDi (2011-)</p>	 <p>L: 26</p> <p>AR7047 Gear Shift Bush</p> <p>BMW 1-Series (E81, E87) 116i (N45) 1.6, 118i (N46) 2.0, 120i (N46) 2.0, 130i (N52) 3.0 (04-15), (E88) 120i (N46) 2.0 (04-15), 3-Series (E36) 316i (M40) 1.8 Dolphin Shape, 318i (M40) 1.8 Motorsport I / II, (M42) 1.9 S, 320i (M50) 2.0, 323i (M52) 2.5 (92-00), 328i (M52TU) 2.8 Dolphin Convertible, Individual (95-00), (E36, E37) M-Coupe (S50B32) 3.2 6-Cyl. (93-05), (E36, E46) M3 (M54) 3.0, (S50B32/4) 3.2 Convertible (93-05), (E46) 318i (M43) 1.8, (M43) 2.0 Touring SW, (N42) 2.0, 318ti (M47B) 2.0 Compact, 320d (M47D) 2.0 (98-05), 320i (M52) 2.0, (M54) 2.2, 323Ci (M52) 2.5 Coupe, 323i (M52) 2.5, 325Ci (M54) 2.5 Coupe, 325i, 325ti (M50, M54) 2.5 Touring SW, Compact (99-05), 328i (M52TU) 2.8 Coupe, 330Ci (M54) 3.0 Convertible, 330d (M57) 3.0 Dies., 330i (M54) 3.0 (99-05), 5-Series (E28) 520i (M20B20) 2.0, 525e (M30B27) 2.5, 528i (M30B28) 2.8, 535i (M30B35) 3.5, M535i (M90) 3.5 6-Cyl., M5 (MX30) 3.5 (85-89), (E34) 530i (M60B30) 3.0 V8, 535i (M30B35) 3.5 6-Cyl., 540i (M60B40) 4.0 Edition V8 (95-96), M5 (M50B35) 3.5 6-Cyl. (92-94), (E39) 523i (M52) 2.5, 525i (M54) 2.5, 528i (M52) 2.8, 530d (M57) 3.0 Dies., 530i (M54) 3.0 (96-04), 7-Series (E23) 728 (M30B28) 2.8, 728i (M30B28) 2.8, 730 (M30B28) 3.0, 733i (M30B32) 3.2, 735i (M30) 3.5, 745i (S38) 3.5 6-Cyl. (78-89), (E32) 730i (M30, M60) 3.0, 735i (M30) 3.5 6-Cyl. (87-96)</p>
 <p>ID: 15, OD: 35, L: 24</p>	<p>AR7042 Front Stabilizer Link Grommet</p> <p>Volkswagen Golf IV 1.6i Comfortline, Std., Tiptronic, 1.8 GTI HighLine, 1.8T GTI, 1.9 TDi HighLine, Comfortline, DSG, 2.0i Cabrio, HighLine (99-04), Jetta IV 1.6i Comfortline Std. 5-Spd. Man., 4-Spd. Auto., 1.9 TDi HighLine 5-Spd. Man., 2.0i HighLine 5-Spd. Man., 2.3 V5 5-Spd. Man. (99-05)</p>	 <p>AR7048 Engine Mounting - LHS</p> <p>Volkswagen Passat 1.5, 1.6 Auto. (74-85)</p>
 <p>ID: 12.3, OD: 56, L: 101.5</p>	<p>AR7043 Rear Axle Beam Bush</p> <p>Audi A3 (CMSA) 1.4 TFSi, (CAYC) 1.6 TDi, (CDAA) 1.8 TFSi, (BXE) 1.9 TDi, (CLJA) 2.0 TDi (08-13), A4 (8D2, B5) (APU) 1.8T Avant, Multitronic, SW (95-01)</p>	 <p>ID: 26.5, OD: 50.5, L: 44.5</p> <p>AR7049 Front Stabilizer Bar Bush</p> <p>Audi A6 (AGA, ALF, AMC, APS, ARJ, BDV, BDW) 2.4, (ACK) 2.8 Avant Quattro, (ARS) 4.2 V8 Quattro, Tiptronic (97-05), (AJK, ARE, BES) 2.7T Quattro, (ASB) 3.0 TDi Quattro (00-09)</p>
	<p>AR7050 Engine Mounting - Rear Support</p> <p>Seat Ibiza III (BXW) 1.4, (BAH) 1.6 (2006-); Volkswagen Polo (9N) (AXU) 1.4 62kw 5-Spd. Man., (BAH) 1.6 74kw 5-Spd. Man., (BTS) 1.6 77kw 5-Spd. Man. (2002-), Polo (6R) (CGGB, CLPA) 1.4 63kw 5-Spd. Man., (CLSA) 1.6 77kw 5-Spd. Man. (10-15), Polo (6C) (CGGB, CLPA) 1.4 63kw 5-Spd. Man., (CLSA) 1.6 77kw 5-Spd. Man. (2016-), Polo Vivo I (CLPB) 1.4 55kw 5-Spd. Man., (CLPA) 1.4 63kw 5-Spd. Man., (CLSA) 1.6 77kw 5-Spd. Man. (10-17)</p>	<p>AR7050 Engine Mounting - Rear Support</p> <p>Seat Ibiza III (BXW) 1.4, (BAH) 1.6 (2006-); Volkswagen Polo (9N) (AXU) 1.4 62kw 5-Spd. Man., (BAH) 1.6 74kw 5-Spd. Man., (BTS) 1.6 77kw 5-Spd. Man. (2002-), Polo (6R) (CGGB, CLPA) 1.4 63kw 5-Spd. Man., (CLSA) 1.6 77kw 5-Spd. Man. (10-15), Polo (6C) (CGGB, CLPA) 1.4 63kw 5-Spd. Man., (CLSA) 1.6 77kw 5-Spd. Man. (2016-), Polo Vivo I (CLPB) 1.4 55kw 5-Spd. Man., (CLPA) 1.4 63kw 5-Spd. Man., (CLSA) 1.6 77kw 5-Spd. Man. (10-17)</p>
	<p>AR7051 Engine Mounting - Rear Support</p> <p>Seat Ibiza III (BXW) 1.4, (BAH) 1.6 (2006-); Volkswagen Polo (9N) (AXU) 1.4 62kw 5-Spd. Man., (BAH) 1.6 74kw 5-Spd. Man., (BTS) 1.6 77kw 5-Spd. Man. (2002-), Polo (6R) (CGGB, CLPA) 1.4 63kw 5-Spd. Man., (CLSA) 1.6 77kw 5-Spd. Man. (10-15), Polo (6C) (CGGB, CLPA) 1.4 63kw 5-Spd. Man., (CLSA) 1.6 77kw 5-Spd. Man. (2016-), Polo Vivo I (CLPB) 1.4 55kw 5-Spd. Man., (CLPA) 1.4 63kw 5-Spd. Man., (CLSA) 1.6 77kw 5-Spd. Man. (10-17)</p>	<p>AR7051 Engine Mounting - Rear Support</p> <p>Seat Ibiza III (BXW) 1.4, (BAH) 1.6 (2006-); Volkswagen Polo (9N) (AXU) 1.4 62kw 5-Spd. Man., (BAH) 1.6 74kw 5-Spd. Man., (BTS) 1.6 77kw 5-Spd. Man. (2002-), Polo (6R) (CGGB, CLPA) 1.4 63kw 5-Spd. Man., (CLSA) 1.6 77kw 5-Spd. Man. (10-15), Polo (6C) (CGGB, CLPA) 1.4 63kw 5-Spd. Man., (CLSA) 1.6 77kw 5-Spd. Man. (2016-), Polo Vivo I (CLPB) 1.4 55kw 5-Spd. Man., (CLPA) 1.4 63kw 5-Spd. Man., (CLSA) 1.6 77kw 5-Spd. Man. (10-17)</p>

ENGINE MOUNTING & RUBBER BUYERS GUIDE

 <p>ID: 30</p>	<p>AR7053 Centre Bearing Rubber</p> <p>BMW 1-Series (E81, E87) 116i (N45) 1.6, 118i (N46) 2.0, 120i (N46) 2.0, 130i (N52) 3.0 (04-15), (E88) 120i (N46) 2.0 (04-15), (E82) 120d (N47) 2.0 (2005-), (E87) 118d (M47) 2.0, 120d (M47) 2.0 (2005-), (E82, E88) 125i (N52, N54, N55) 3.0 Convertible, Coupe, 135i (N54, N55) 3.0 Turbo (08-14), (F20, F21) 118i (B38A15A) 1.5 (2015-), 3-Series (E90) 320d (M47) 2.0, 320i (N46) 2.0, 323i (N52N) 2.5, 325i (N53) 2.5, 330i (N52, N53) 3.0, 330d (M57, N57) 3.0 (05-13), (E92) 320i (N44) 2.0, 325i (N53) 2.5, 335i (N54, N55) 3.0 (02-15), (E93) 330i (N52) 3.0, 335i (N54, N55) 3.0 (05-14), (F30, F31) 316i (N13B16A) 1.6, 318i (B38A15A) 1.6, 320d (N47D20A) 2.0, 320i (B48B20A, N20B20A/B/D) 2.0, 328i (N20B20A) 2.0, 330i (B46B20A, B48B20A) 2.0, 335i (N55B30A) 3.0 (12-19), (F34) 320d GT (N47D20C) 2.0 (2013-), 4-Series (F32) 420d (B47B20A, N47D20C) 2.0 Coupe, 420i (N20B20A/B) 2.0 Coupe, 428i (N20B20A, N26B20A) 2.0 Coupe, 430i (B46B20B, B48B20B) 2.0 Coupe (2014-), (F33) 420i (N20B20B) 2.0 Cabriolet, 428i (N20B20A, N26B20A) 2.0 Cabriolet, 430i (B48B20B) 2.0 Cabriolet, 435i (N55B30A) 3.0 Auto. Cabriolet, 440i (B58B30A) 3.0 Auto. Cabriolet (2014-), (F36) 420d (B47B20A, N47D20C) 2.0 Gran Coupe, 420i (N20B20B) 2.0 Gran Coupe, 428i (N20B20A, N26B20A) 2.0 Gran Coupe, 430i (B48B20B) 2.0 Gran Coupe, 435i (N55B30A) 3.0 Gran Coupe (2014-)</p>
	<p>AR7054 Engine Mounting - Rear</p> <p>BMW Mini Cooper (R50) Cooper (W10B16A) 1.6, (R52) Cooper (W10B16A, W11B16A) 1.6 Convertible, (R53) Cooper S (W11B16A) 1.6 (02-09)</p>
 <p>W: 55, T: 90</p>	<p>AR7058 Transmission Mounting - LHS</p> <p>Audi A3 (CMSA) 1.4 TFSi, (CAYC) 1.6 TDi, (CDA) 1.8 TFSi, (BXE) 1.9 TDi, (CLJA) 2.0 TDi (08-13) - Man. Models, A4 (8E2, B6) (APU) 1.8T Avant, Multitronic, SW (95-01); Volkswagen Passat IV 1.8T 5-Spd. Man., 5-Spd. Auto., 2.8 V6 Quattro, Quattro Tiptronic 5-Spd. Man., 5-Spd. Auto. (99-05)</p>
	<p>AR7060 Engine Mounting - L/RHS</p> <p>Audi A4 (8D2, B5) (APU) 1.8T Avant, Multitronic, SW (95-01); Volkswagen Passat IV 1.8T 5-Spd. Man., 5-Spd. Auto. (99-05)</p>
	<p>AR7065 Transmission Mounting - L/RHS</p> <p>Audi A3 (CMSA) 1.4 TFSi, (CAYC) 1.6 TDi, (CDA) 1.8 TFSi, (BXE) 1.9 TDi, (CLJA) 2.0 TDi (08-13), A4 (8D2, B5) (APU) 1.8T Avant, Multitronic, SW (95-01), A6 (AGA, ALF, AMC, APS, ARJ, BDV, BDW) 2.4, (ACK) 2.8 Avant Quattro, (ARS) 4.2 V8 Quattro, Tiptronic (97-05) - to 4B-X-100 000; Volkswagen Passat IV 1.8T 5-Spd. Man., 5-Spd. Auto., 2.8 V6 Quattro, Quattro Tiptronic 5-Spd. Man., 5-Spd. Auto. (99-05)</p>
	<p>AR7066 Engine Mounting - Rear Support</p> <p>Audi A1 (CAVG, CTHG) 1.4 TFSi, Sportback 136kw 7-Spd. S-Tronic, (CAYC) 1.6 TDi, Sportback 77kw 5-Spd. Man. (11-18); Seat Ibiza III (BBU) 1.8T Cupra (2006-); Volkswagen Polo (9N) (AMF, BAY) 1.4 TDi 55kw 5-Spd. Man., (BMS, BNV) 1.4 TDi 59kw 5-Spd. Man., (BJX) 1.8 TSi GTI 110kw 6-Spd. Man., (ATD, AXR) 1.9 TDi 74kw 5-Spd. Man. (2003-), Polo (6R) (CAVE) 1.4 TSi GTI 132kw 7-Spd. DSG, (CAYC, CLNA) 1.6 TDi 77kw 5-Spd. Man. (2011-)</p>
	<p>AR7067 Transmission Mounting - L/RHS</p> <p>Audi A6 (AGA, ALF, AMC, APS, ARJ, BDV, BDW) 2.4, (ACK) 2.8 Avant Quattro, (ARS) 4.2 V8 Quattro, Tiptronic (97-05) - 4B-X-100 000 on; Volkswagen Passat IV 1.8T 5-Spd. Auto., 2.8 V6 Quattro, Quattro Tiptronic 5-Spd. Auto. (99-05)</p>

 <p>ID: 12, OD: 50.5, L: 60</p>	<p>AR7068 Front Lower Control Arm Bush - Inner Front</p> <p>Audi A3 (CMSA) 1.4 TFSi, (CAYC) 1.6 TDi, (CDA) 1.8 TFSi, (BXE) 1.9 TDi, (CLJA) 2.0 TDi (08-13), A4 (8D2, B5) (APU) 1.8T Avant, Multitronic, SW (95-01), (8E2/5, B6) (BFB) 1.8T Avant, Multitronic, SW, (AVF, AWX) 1.9 TDi Avant, (ALT) 2.0 Executive (BGB) 2.0 TFSi, (BLB) 2.0 TDi (00-08), (CABA/B, CDHA/B, CJEB) 1.8 TFSi, (BRD, CAGA, CJCA, CMEA, CMFA) 2.0 TDi, (CABE, CDNC, CGLC, CMGB) 2.0 TFSi, (CDNC, CPMA) 2.0 TFSi Quattro (08-14), A6 (AGA, ALF, AMC, APS, ARJ, BDV, BDW) 2.4, (ACK) 2.8 Avant Quattro, (ARS) 4.2 V8 Quattro, Tiptronic (97-05), (AJK, ARE, BES) 2.7T Quattro, (ASB) 3.0 TDi Quattro (00-09), (BDX, CCEA) 2.8 FSi 7-Spd. Auto. (07-09), (BPJ) 2.0 TFSi 7-Spd. Auto. Pet., (BPP, CANA) 2.7 TDi 7-Spd. Auto., (CCEA) 2.8 FSi 7-Spd. Auto. (09-11); Volkswagen Passat IV 1.8T 5-Spd. Man., 5-Spd. Auto., 2.8 V6 Quattro, Quattro Tiptronic 5-Spd. Man., 5-Spd. Auto. (99-05)</p>
 <p>ID: 12, OD: 65, L: 80</p>	<p>AR7069 Front Lower Control Arm Bush - Inner Rear</p> <p>Audi A3 (CMSA) 1.4 TFSi, (CAYC) 1.6 TDi, (CDA) 1.8 TFSi, (BXE) 1.9 TDi, (CLJA) 2.0 TDi (08-13), A4 (8D2, B5) (APU) 1.8T Avant, Multitronic, SW (95-01), (8E2/5, B6) (BFB) 1.8T Avant, Multitronic, SW, (AVF, AWX) 1.9 TDi Avant, (ALT) 2.0 Executive (BGB) 2.0 TFSi, (BLB) 2.0 TDi (00-08), (CABA/B, CDHA/B, CJEB) 1.8 TFSi, (BRD, CAGA, CJCA, CMEA, CMFA) 2.0 TDi, (CABE, CDNC, CGLC, CMGB) 2.0 TFSi, (CDNC, CPMA) 2.0 TFSi Quattro (08-14), A6 (AGA, ALF, AMC, APS, ARJ, BDV, BDW) 2.4, (ACK) 2.8 Avant Quattro, (ARS) 4.2 V8 Quattro, Tiptronic (97-05), (AJK, ARE, BES) 2.7T Quattro, (ASB) 3.0 TDi Quattro (00-09), (BDX, CCEA) 2.8 FSi 7-Spd. Auto. (07-09), (BPJ) 2.0 TFSi 7-Spd. Auto. Pet., (BPP, CANA) 2.7 TDi 7-Spd. Auto., (CCEA) 2.8 FSi 7-Spd. Auto. (09-11) (09-11); Volkswagen Passat IV 1.8T 5-Spd. Man., 5-Spd. Auto., 2.8 V6 Quattro, Quattro Tiptronic 5-Spd. Man., 5-Spd. Auto. (99-05)</p>
 <p>OD: 63</p>	<p>AR7070 Front Upper Control Arm Bush - Inner Front</p> <p>Audi A8 (AQQ) 3.7 Tiptronic, (AQF, AUW, AUX) 4.2 V8 Quattro (95-02)</p>
	<p>AR7071 Front Strut Mounting</p> <p>Audi A4 (8D2, B5) (APU) 1.8T Avant, Multitronic, SW (95-01), A6 (AGA, ALF, AMC, APS, ARJ, BDV, BDW) 2.4, (ACK) 2.8 Avant Quattro, (ARS) 4.2 V8 Quattro, Tiptronic (97-05), A8 (AQQ) 3.7 Tiptronic, (AQF, AUW, AUX) 4.2 V8 Quattro (95-02); Volkswagen Passat IV 1.8T 5-Spd. Man., 5-Spd. Auto., 2.8 V6 Quattro, Quattro Tiptronic 5-Spd. Man., 5-Spd. Auto. (99-05)</p>
 <p>ID: 10, OD: 46, L: 40</p>	<p>AR7072 Front Upper Control Arm Bush - Inner Front & Rear</p> <p>Audi A3 (CMSA) 1.4 TFSi, (CAYC) 1.6 TDi, (CDA) 1.8 TFSi, (BXE) 1.9 TDi, (CLJA) 2.0 TDi (08-13), A4 (8D2, B5) (APU) 1.8T Avant, Multitronic, SW (95-01), A8 (AQQ) 3.7 Tiptronic, (AQF, AUW, AUX) 4.2 V8 Quattro (95-02); Volkswagen Passat IV 1.8T 5-Spd. Man., 5-Spd. Auto., 2.8 V6 Quattro, Quattro Tiptronic 5-Spd. Man., 5-Spd. Auto. (99-05)</p>
 <p>ID: 12, OD: 45</p>	<p>AR7074 Rear Lower Control Arm Bush - Outer</p> <p>Volkswagen Passat IV 1.8T 5-Spd. Man., 5-Spd. Auto., 2.8 V6 Quattro, Quattro Tiptronic 5-Spd. Man., 5-Spd. Auto. (99-05)</p>
	<p>AR7075 Rear Lower Control Arm Bush - Inner</p> <p>Volkswagen Passat IV 1.8T 5-Spd. Man., 5-Spd. Auto., 2.8 V6 Quattro, Quattro Tiptronic 5-Spd. Man., 5-Spd. Auto. (99-05)</p>
 <p>NO PICTURE AVAILABLE AT TIME OF PRINT</p>	<p>AR7078 Rear Lateral Link Bush</p> <p>Audi A8 (AQQ) 3.7 Tiptronic, (AQF, AUW, AUX) 4.2 V8 Quattro (95-02); Volkswagen Passat IV 1.8T 5-Spd. Man., 5-Spd. Auto., 2.8 V6 Quattro, Quattro Tiptronic 5-Spd. Man., 5-Spd. Auto. (99-05) - to job 3BX 560 000</p>

ENGINE MOUNTING & RUBBER BUYERS GUIDE

	<p>AR7079 Rear Lateral Link Bush</p> <p>Audi A8 (AQG) 3.7 Tiptronic, (AQF, AUW, AUX) 4.2 V8 Quattro (95-02); Volkswagen Passat IV 1.8T 5-Spd. Man., 5-Spd. Auto., 2.8 V6 Quattro, Quattro Tiptronic 5-Spd. Man., 5-Spd. Auto. (99-05) - from job 3BX 560 001</p>		<p>AR7090 Engine Stabilizer Mounting</p> <p>Volkswagen Kombi (T2, T3) 1.8 Microbus, P/van, Volksiebus, 1.9 Microbus, P/van, 2.0 Microbus, P/van, L Exec. Bus, Kamper, P/up, 2.1 Fi Caravelle, Microbus, 2.3 Microbus, Volksiebus, 2.5i Caravelle, Microbus, 2.6i Caravelle, Microbus (74-04)</p> <p>ID: 12, OD: 56, H: 90</p>
	<p>AR7080 Engine Mounting - L/RHS</p> <p>Audi A6 (AGA, ALF, AMC, APS, ARJ, BDV, BDW) 2.4, (ACK) 2.8 Avant Quattro, (ARS) 4.2 V8 Quattro, Tiptronic (97-05)</p>		<p>AR7093 Steering Rack Mounting</p> <p>Volkswagen Kombi (T2, T3) 1.8 Microbus, P/van, Volksiebus, 1.9 Microbus, P/van, 2.0 Microbus, P/van, L Exec. Bus, Kamper, P/up, 2.1 Fi Caravelle, Microbus, 2.3 Microbus, Volksiebus, 2.5i Caravelle, Microbus, 2.6i Caravelle, Microbus (74-04), Kombi (T3) 4X4 (DJ) 2.1 Fi Syncro Pet. (89-93), Kombi (T4) (AAB, ACV) 2.5TDi Microbus, Caravelle, Trend, High Dies. (99-03)</p> <p>ID: 8.5, OD: 27.5, L: 33</p>
	<p>AR7081 Transmission Mounting</p> <p>BMW Mini Cooper (R53) Cooper S (W11B16A) 1.6 (02-09)</p>		<p>AR7094 Tension Rod Bush - Rear</p> <p>Volkswagen Kombi (T2, T3) 1.8 Microbus, P/van, Volksiebus, 1.9 Microbus, P/van, 2.0 Microbus, P/van, L Exec. Bus, Kamper, P/up, 2.1 Fi Caravelle, Microbus, 2.3 Microbus, Volksiebus, 2.5i Caravelle, Microbus, 2.6i Caravelle, Microbus (74-04)</p> <p>ID: 24, OD: 61, L: 32</p>
	<p>AR7082 Exhaust Hanger - Front, Middle, Rear</p> <p>Ford Fiesta III (M1JE) 1.0 Ecoboost, Titanium, Trend, 1.4i Ambiente, Trend, Titanium, 1.6i Ambiente, Trend, Sport, Titanium, TDCi (2008-); Volkswagen Golf III 1.6 GS 5-Spd. Man., 1.8 GSX, GTS 5-Spd. Man., 3-Spd. Auto., 2.0 GTi, 8V GTi Exec. 5-Spd. Man., 2.8 VR6, VR6 Exec. V6 5-Spd. Man., 4-Spd. Auto. (92-99), Golf IV 1.6i Comfortline, Std., Tiptronic, 1.8 GTi HighLine, 1.8T GTi, 1.9 TDi HighLine, Comfortline, DSG, 2.0i Cabrio, HighLine (99-04), Golf IV 1.6i Comfortline, Std., Tiptronic, 1.8 GTi HighLine, 1.8T GTi, 1.9 TDi HighLine, Comfortline, DSG, 2.0i Cabrio, HighLine (99-04), Jetta III 1.6 CSL 5-Spd. Man., 1.8 CLX, CSX 5-Spd. Man., 3-Spd. Auto., 2.0 CLi, CLi Exec. 5-Spd. Man., 2.8 VR6 Exec. V6 5-Spd. Man., 4-Spd. Auto. (92-99), Jetta IV 1.6i Comfortline Std. 5-Spd. Man., 4-Spd. Auto., 1.9 TDi HighLine 5-Spd. Man., 2.0i HighLine 5-Spd. Man., 2.3 V5 5-Spd. Man. (99-05), Jetta IV 1.6i Comfortline Std. 5-Spd. Man., 4-Spd. Auto., 1.9 TDi HighLine 5-Spd. Man., 2.0i HighLine 5-Spd. Man., 2.3 V5 5-Spd. Man. (99-05), Sharan (AJH, AWC) 1.8T MPV Man., (AMY, AAA) 2.8 VR6 (99-10)</p>		<p>AR7095 Tension Rod Bush - Front</p> <p>Volkswagen Kombi (T2, T3) 1.8 Microbus, P/van, Volksiebus, 1.9 Microbus, P/van, 2.0 Microbus, P/van, L Exec. Bus, Kamper, P/up, 2.1 Fi Caravelle, Microbus, 2.3 Microbus, Volksiebus, 2.5i Caravelle, Microbus, 2.6i Caravelle, Microbus (74-04)</p> <p>ID: 25, OD: 61.5, L: 38.5</p>
	<p>AR7083 Transmission Mounting</p> <p>BMW Mini Cooper (R53) Cooper S (W11B16A) 1.6 Man. (02-09)</p>		<p>AR7096 Rear Axle Beam Bush</p> <p>Volkswagen Golf II 1.3 CL 4-Spd. Man., 1.6 CSL 5-Spd. Man., 1.8 GTS 16V, CSX, GTi 8V, 16V, 5-Spd. Man., 3-Spd. Auto., 2.0 GTi 8V, Exec. 16V 5-Spd. Man. (84-92), Jetta II 1.6 CSL 5-Spd. Man., 1.8 CLi, CLi Exec., Executive, CLX, CSX 5-Spd. Man., 3-Spd. Auto., 2.0 L 16V 5-Spd. Man. (85-92)</p> <p>ID: 12, OD: 44.5, L: 90</p>
	<p>AR7084 Rear Axle Beam Bush</p> <p>Volkswagen Polo (6N) 1.4i Classic, Playa, 1.6i Classic Lux, Classic, Playa, 1.8i Classic Lux, Playa 5-Spd. Man. (96-03)</p> <p>ID: 10, OD: 58, L: 58</p>		<p>AR7097 Steering Coupling</p> <p>Volkswagen Kombi (T2, T3) 1.8 Microbus, P/van, Volksiebus, 1.9 Microbus, P/van, 2.0 Microbus, P/van, L Exec. Bus, Kamper, P/up, 2.1 Fi Caravelle, Microbus, 2.3 Microbus, Volksiebus, 2.5i Caravelle, Microbus, 2.6i Caravelle, Microbus (74-04), Kombi (T3) 4X4 (DJ) 2.1 Fi Syncro Pet. (89-93)</p> <p>ID: 23, OD: 72, L: 12</p>
	<p>AR7085 Rear Axle Beam Bush</p> <p>Volkswagen Citi Golf 1.3 L, Chico, L Shuttle 4-Spd. Man., Chico Lux, (HM) 1.6 L, Chico Lux, Deco, Designa, Blues, Ritz, Shuttle, Sonic, Sport Chico 4/5-Spd. Man., 3-Spd. Auto., (BZF) 1.8 CTi, Designa, L Sport, 5-Spd. Man. (83-02), 1.4 L, Chico, (AGY, BSY) 1.4i, L, Citi.com, VeloCiti, TenaCiti, CitiStorm, Sport, Rox, Rhythm Man., (AFX) 1.6i Life, Velociti, TenaCiti, CitiStorm, Sport, Rox 5-Spd. Man. (99-09), Fox 1.3 L, L Trippa 4-Spd. Man., 1.6 L 4/5-Spd. Man., 3-Spd. Auto., 1.8 L Sport 5-Spd. Man. (87-96)</p> <p>ID: 11</p>		<p>AR7099 Engine Mounting - RHS</p> <p>Volkswagen Kombi (T4) (AAB, ACV) 2.5TDi Microbus, Caravelle, Trend, High Dies. Auto. (99-03)</p>
	<p>AR7087 Rear Axle Beam Bush</p> <p>Volkswagen Golf III 1.6 GS 5-Spd. Man., 1.8 GSX, GTS 5-Spd. Man., 3-Spd. Auto., 2.0 GTi, 8V GTi Exec. 5-Spd. Man., 2.8 VR6, VR6 Exec. V6 5-Spd. Man., 4-Spd. Auto. (92-99), Jetta III 1.6 CSL 5-Spd. Man., 1.8 CLX, CSX 5-Spd. Man., 3-Spd. Auto., 2.0 CLi, CLi Exec. 5-Spd. Man., 2.8 VR6 Exec. V6 5-Spd. Man., 4-Spd. Auto. (92-99)</p> <p>ID: 12, OD: 57, L: 90</p>		<p>AR7101 Gearbox Pendulum Rod Bush</p> <p>Volkswagen Kombi (T2, T3) 1.8 Microbus, P/van, Volksiebus, 1.9 Microbus, P/van, 2.0 Microbus, P/van, L Exec. Bus, Kamper, P/up, 2.1 Fi Caravelle, Microbus, 2.3 Microbus, Volksiebus, 2.5i Caravelle, Microbus, 2.6i Caravelle, Microbus (74-04), Kombi (T4) (AAB, ACV) 2.5TDi Microbus, Caravelle, Trend, High Dies. (99-03)</p> <p>ID: 13, OD: 34, L: 62</p>
	<p>AR7088 Transmission Mounting</p> <p>Volkswagen Kombi (T4) (AAB, ACV) 2.5TDi Microbus, Caravelle, Trend, High Dies. (99-03) - Vehicles with Mechanical Clutch</p>		
	<p>AR7089 Transmission Mounting</p> <p>Volkswagen Kombi (T4) (AAB, ACV) 2.5TDi Microbus, Caravelle, Trend, High Dies. (99-03) - Vehicles with Hydraulic Clutch</p>		

ENGINE MOUNTING & RUBBER BUYERS GUIDE

 <p>ID: 12, OD: 72, L: 90</p>	<p>AR7102 Rear Axle Beam Bush</p> <p>Audi A3 (AGN) 1.8, (AGU, BFU) 1.8T (98-04); Seat Ibiza (BXW) 1.4 Sport, (BAH) 1.6, 1.9 TDi, Cupra (BPX), 96/118 (ASZ, BLT, BUK) (06-09), Ibiza (BBU) 1.8T, 2.0 (06-09); Volkswagen Beetle (9C1, 9V1) (APH/ AWU) 1.8T Coupe, (1Y7) (AEG) 2.0i Cabriolet, Coupe, HighLine, (9C1) (AEG) 2.0i Cabriolet, Coupe, HighLine (00-12), Golf IV 1.6i Comfortline, Std., Tiptronic, 1.8 GTi HighLine, 1.8T GTi, 1.9 TDi HighLine, Comfortline, DSG, 2.0i Cabrio, HighLine (99-04), Jetta IV 1.6i Comfortline Std. 5-Spd. Man., 4-Spd. Auto., 1.9 TDi HighLine 5-Spd. Man., 2.0i HighLine 5-Spd. Man., 2.3 V5 5-Spd. Man. (99-05), Polo (9N) (BBY, BKY, BLM) 1.4i, Classic, Trendline, Comfortline, (AMF) 1.4 TDi, Classic, (BAH) 1.6i, Classic Lux, Comfortline, Trendline, SE, (ATD) 1.9 TDi, HighLine, Classic, HighLine, Sportline, (BBU, BJX) 1.8T GTi Classic, Trendline, (ASZ, BBX) 2.0i HighLine, Classic HighLine (02-10), Cross Polo 1.6 TDi, 1.9 TDi (07-10), Polo (CBZB) 1.2 Trendline DSG Pet., (CBZC) 1.2 TSi Comfortline Man. Pet., (CFWA) 1.2 TDi Trendline, BlueMotion Man. DSL, (CGPA, CGPB) 1.2 Man., (CTHE) 1.4 TSi GTi DSG (2010-), Polo Vivo (CFWA) 1.2 TDi, (CLPA, CLPB) 1.4i Trendline, (CLSA) 1.6i Trendline (2010-), Polo (6R) (CAVE, CDDA, CGGB, CLPA) 1.4i Trendline, Comfortline, GTi, (CFNA, CLSA) 1.6i Comfortline, Trendline, Tiptronic, (CAYC) 1.6 TDi Comfortline (10-15), Polo (6C) (CJZC, CJZD) 1.2 TSi, (CDDA, CGGB, CLPA) 1.4, (CUTA, CYZB) 1.4 TDi, (CWXC) 1.5 TDi, (CFNA, CLSA) 1.6, (DAJA) 1.8 TSi, GTi (2014-), Polo (CHYA, CHYB) 1.0 Comfortline, Trendline BlueMotion Hatch (2014-), Polo (GP) (CHZB) 1.0 TSi BlueMotion 5-dr, (CHZC) 1.0 TSi Comfortline, TSi-R-Line DSG (15-17), Polo (AW1, BZ1) 1.0 TSi GT (2018-)</p>		<p>AR7118 Engine Mounting - LHS</p> <p>Volkswagen Sharan (AMY, AAA) 2.8 VR6 Auto. (99-01)</p>
 <p>ID: 14, OD: 50</p>	<p>AR7104 Front Lower Control Arm Bush - Outer</p> <p>Volkswagen Kombi (T4) (AAB, ACV) 2.5TDi Microbus, Caravelle, Trend, High Dies. (99-03)</p>		<p>AR7119 Engine Mounting - LHS</p> <p>Volkswagen Sharan (AMY, AAA) 2.8 VR6 Man. (99-01)</p>
 <p>ID: 27, H: 35, W: 30</p>	<p>AR7106 Front Stabilizer Bar Bush</p> <p>Volkswagen Kombi (T4) (AAB, ACV) 2.5TDi Microbus, Caravelle, Trend, High Dies. (99-03)</p>		<p>AR7120 Engine Mounting - RHS</p> <p>Volkswagen Sharan (AMY, AAA) 2.8 VR6 Auto. (99-01)</p>
 <p>ID: 12, OD: 35, L: 60</p>	<p>AR7107 Front Upper Control Arm Bush - Outer Rear</p> <p>Volkswagen Kombi (T4) (AAB, ACV) 2.5TDi Microbus, Caravelle, Trend, High Dies. (99-03)</p>		<p>AR7121 Engine Mounting - RHS</p> <p>Volkswagen Sharan (AMY, AAA) 2.8 VR6 Man. (99-01)</p>
 <p>ID: 23.5</p>	<p>AR7108A Front Stabilizer Link Grommet</p> <p>Volkswagen Kombi (T4) (AAB, ACV) 2.5TDi Microbus, Caravelle, Trend, High Dies. (99-03)</p>	 <p>ID: 14, OD: 35, L: 60</p>	<p>AR7122 Front & Rear Lower Control Arm Bush - Inner Front & Rear</p> <p>Volkswagen Sharan (AJH, AWC) 1.8T MPV Man., (AMY, AAA) 2.8 VR6 (99-10)</p>
	<p>AR7109 Engine Mounting - RHS</p> <p>Volkswagen Kombi (T4) (AAB, ACV) 2.5TDi Microbus, Caravelle, Trend, High Dies. Man. (99-03)</p>	 <p>ID: 18, OD: 60, L: 50</p>	<p>AR7123 Front Lower Control Arm Bush - Outer Rear</p> <p>Volkswagen Sharan (AJH, AWC) 1.8T MPV Man., (AMY, AAA) 2.8 VR6 (99-10)</p>
	<p>AR7112 Transmission Mounting</p> <p>Volkswagen Kombi (T3) 4X4 (DJ) 2.1 Fi Syncro Pet. (89-93)</p>	 <p>ID: 17</p>	<p>AR7124 Front Stabilizer Bar Bush</p> <p>Volkswagen Sharan (AJH, AWC) 1.8T MPV Man., (AMY, AAA) 2.8 VR6 (99-10)</p>
	<p>AR7114 Engine Mounting - LHS</p> <p>Volkswagen Sharan (AJH, AWC) 1.8T MPV Man. (99-01)</p>	 <p>ID: 50, W: 30</p>	<p>AR7125 Steering Rack Mounting</p> <p>Volkswagen Sharan (AJH, AWC) 1.8T MPV Man., (AMY, AAA) 2.8 VR6 (99-10)</p>
	<p>AR7116 Engine Mounting - RHS</p> <p>Volkswagen Sharan (AJH, AWC) 1.8T MPV Man. (99-01)</p>	<p>AR7126 Front Stabilizer Bar Bush</p> <p>Seat Altea (BVY, BVZ) 2.0 FSi, (BMM) 2.0 TDi MPV (06-09), Leon (BLR, BLY, BVZ) 2.0 FSi, (BKD, BMM, CFHC, CLCB) 2.0 TDi, (BWA, BWJ, CDLD) 2.0T, FSi (06-09); Volkswagen Golf V (BGU) 1.6i Comfortline, Tiptronic, Trendline, (BLS, BXE) 1.9 TDi Comfortline, DSG, (BKD) 2.0 TDi DSG Sport, Sport Tiptronic, Sport 5-Spd. Man., 6-Spd. Auto., (BLX) 2.0i Trendline, GTi DSG, Comfortline, GTi 5-Spd. Man., 6-Spd. Auto., (BLY) 2.0 FSi Sport, Sport Tiptronic 6-Spd. Man., Auto. (04-09), Jetta V 1.6i Comfortline, Tiptronic, Trendline, (BKC) 1.9 TDi Comfortline, DSG, (BHY) 2.0i Trendline, DSG, Comfortline, 5-Spd. Man., 6-Spd. Auto., (BHY) 2.0i Trendline, DSG, Comfortline, 5-Spd. Man., 6-Spd. Auto., 2.0 FSi, TFSi, Sportline, Tiptronic 6-Spd. Man./Auto. (05-11), (AZV, BKD, BMM) 2.0 TDi Sportline, Tiptronic, HighLine 5-Spd. Man., 6-Spd. Auto. (2005-)</p>	
	<p>AR7127 Centre Bearing Rubber</p> <p>Volkswagen Sharan (AJH, AWC) 1.8T MPV Man., (AMY, AAA) 2.8 VR6 (99-10)</p>		
	<p>AR7128 Rear Lower Control Arm Bush - Outer</p> <p>Volkswagen Sharan (AJH, AWC) 1.8T MPV Man., (AMY, AAA) 2.8 VR6 (99-10)</p>		

ENGINE MOUNTING & RUBBER BUYERS GUIDE

 <p>ID: 14</p>	<p>AR7129 Front Strut Mounting (without Bearing)</p> <p>Audi A3 (BVZ) 2.0 FSi, (BMM, CLJA) 2.0 TDi (03-13), (CBFA, CCZA) 2.0 TFSi, (BUB) 3.2 Quattro (04-13), S3 (CDLC) 2.0 TFSi (07-13); Seat Altea (BVY, BVZ) 2.0 FSi, (BMM) 2.0 TDi MPV (06-09), Leon (BLR, BLY, BVZ) 2.0 FSi, (BKD, BMM, CFHC, CLCB) 2.0 TDi, (BWA, BWJ, CDLD) 2.0T, FSi (06-09); Volkswagen Beetle (CBZB) 1.2 TSi, (CZDA) 1.4 TSi (2012-), Caddy (BGU) 1.6i Life Van, MPV, (BJB) 1.9 TDi, Life Van, MPV, (BDJ) 2.0 SDi Van (04-16), CC (CFGB) 2.0 TDi, (CCZB) 2.0 TSi, (BWS) 3.6 FSi V6 4-Motion (2009-), Golf V (BGU) 1.6i Comfortline, Tiptronic, Trendline, (BLS, BXE) 1.9 TDi Comfortline, DSG, (BKD) 2.0 TDi DSG Sport, Sport Tiptronic, Sport 5-Spd. Man., 6-Spd. Auto., (BLX) 2.0i Trendline, GTi DSG, Comfortline, GTi 5-Spd. Man., 6-Spd. Auto., (BLY) 2.0 FSi Sport, Sport Tiptronic 6-Spd. Man., Auto. (04-09), Golf VI (CAXA, CAVD) 1.4 TSi Trendline, Comfortline, HighLine, (BSE, BSF, CCSA) 1.6i Trendline, (CAYC) 1.6 TDi Comfortline, DSG, Bluemotion, (CBAB, CFFB) 2.0 TDi HighLine, (CCZB) 2.0 GTi DSG, 2.0 TSi-R 4-Motion, DSG (09-13), Jetta V (CAVD, CAXA) 1.4 TSi Trendline, Comfortline, DSG, HighLine, (CAYC) 1.6 TDi Comfortline, DSG (09-11), 1.6i Comfortline, Tiptronic, Trendline, (BKC) 1.9 TDi Comfortline, DSG, (BHY) 2.0i Trendline, DSG, Comfortline, 5-Spd. Man., 6-Spd. Auto., (BHY) 2.0i Trendline, DSG, Comfortline, 5-Spd. Man., 6-Spd. Auto., 2.0 FSi, TFSi, Sportline, Tiptronic 6-Spd. Man./Auto. (05-11), (AZV, BKD, BMM) 2.0 TDi Sportline, Tiptronic, HighLine 5-Spd. Man., 6-Spd. Auto., 2.0 TSi HighLine (2005-), Jetta VI (CBZB) 1.2 TSi, (CAVD, CAXA) 1.4 TSi, (CAYC) 1.6 TDi, (CFHC, CJAA, CLCB) 2.0 TDi (2011-), Passat V (BZB, CDAA) 1.8 TSi Comfortline, DSG, HighLine, (BKC, BLS, BXE) 1.9 TDi Comfortline, DSG, HighLine, (AXX, BLR, BLY, BPY, BVY, BVZ, BWA, CAWB, CBFA, CCZ/TA) 2.0 FSi, TFSi Comfortline, HighLine, (BMP) 2.0 TDi Comfortline, HighLine, DSG, (AXZ) 3.2 FSi Sportline, DSG (05-11), Scirocco (CAVD) 1.4 TSi, (CDLF) 2.0 TSi, DSG, R (2009-), Tiguan 4X2, 4X4 (BWK, CAVA) 1.4 TSi Trend&Fun, Track&Field, (CBAB) 2.0 TDi Track&Field, Sport&Style, Trend&Fun, (CCZA) 2.0 TSi Track&Field, Sport&Style, 4-Motion (08-11), (CAXA) 1.4 TSi, (CAVD, CTHD) 1.4 TSi 4-Motion, (CFFD) 2.0 TDi, (CCZB) 2.0 TSi 4-Motion (11-17), Touran (BGU, BSE, BSF) 1.6 5-Spd. Man., (BKC, BLS, BXE) 1.9 TDi MPV TrendLine, DSG, (AZV) 2.0 TDi MPV Comfortline, HighLine, DSG, (BLY) 2.0 FSi MPV HighLine (04-11), (CBZB) 1.2 TSi, (CAVC, CTHC) 1.4 TSi, (CFHF, CLCA) 2.0 TDi (2011-)</p>
--	--

	<p>AR7129B Front Strut Mounting (with Bearing)</p> <p>Audi A3 (BVZ) 2.0 FSi, (BMM, CLJA) 2.0 TDi (03-13), (CBFA, CCZA) 2.0 TFSi, (BUB) 3.2 Quattro (04-13), S3 (CDLC) 2.0 TFSi (07-13); Seat Altea (BVY, BVZ) 2.0 FSi, (BMM) 2.0 TDi MPV (06-09), Leon (BLR, BLY, BVZ) 2.0 FSi, (BKD, BMM, CFHC, CLCB) 2.0 TDi, (BWA, BWJ, CDLD) 2.0T, FSi (06-09); Volkswagen Beetle (CBZB) 1.2 TSi, (CZDA) 1.4 TSi (2012-), Caddy (BGU) 1.6i Life Van, MPV, (BJB) 1.9 TDi, Life Van, MPV, (BDJ) 2.0 SDi Van (04-16), CC (CFGB) 2.0 TDi, (CCZB) 2.0 TSi, (BWS) 3.6 FSi V6 4-Motion (2009-), Golf V (BGU) 1.6i Comfortline, Tiptronic, Trendline, (BLS, BXE) 1.9 TDi Comfortline, DSG, (BKD) 2.0 TDi DSG Sport, Sport Tiptronic, Sport 5-Spd. Man., 6-Spd. Auto., (BLX) 2.0i Trendline, GTi DSG, Comfortline, GTi 5-Spd. Man., 6-Spd. Auto., (BLY) 2.0 FSi Sport, Sport Tiptronic 6-Spd. Man., Auto. (04-09), Golf VI (CAXA, CAVD) 1.4 TSi Trendline, Comfortline, HighLine, (BSE, BSF, CCSA) 1.6i Trendline, (CAYC) 1.6 TDi Comfortline, DSG, Bluemotion, (CBAB, CFFB) 2.0 TDi HighLine, (CCZB) 2.0 GTi DSG, 2.0 TSi-R 4-Motion, DSG (09-13), Jetta V (CAVD, CAXA) 1.4 TSi Trendline, Comfortline, DSG, HighLine, (CAYC) 1.6 TDi Comfortline, DSG (09-11), 1.6i Comfortline, Tiptronic, Trendline, (BKC) 1.9 TDi Comfortline, DSG, (BHY) 2.0i Trendline, DSG, Comfortline, 5-Spd. Man., 6-Spd. Auto., (BHY) 2.0i Trendline, DSG, Comfortline, 5-Spd. Man., 6-Spd. Auto., 2.0 FSi, TFSi, Sportline, Tiptronic 6-Spd. Man./Auto. (05-11), (AZV, BKD, BMM) 2.0 TDi Sportline, Tiptronic, HighLine 5-Spd. Man., 6-Spd. Auto., 2.0 TSi HighLine (2005-), Jetta VI (CBZB) 1.2 TSi, (CAVD, CAXA) 1.4 TSi, (CAYC) 1.6 TDi, (CFHC, CJAA, CLCB) 2.0 TDi (2011-), Passat V (BZB, CDAA) 1.8 TSi Comfortline, DSG, HighLine, (BKC, BLS, BXE) 1.9 TDi Comfortline, DSG, HighLine, (AXX, BLR, BLY, BPY, BVY, BVZ, BWA, CAWB, CBFA, CCZ/TA) 2.0 FSi, TFSi Comfortline, HighLine, (BMP) 2.0 TDi Comfortline, HighLine, DSG, (AXZ) 3.2 FSi Sportline, DSG (05-11), Scirocco (CAVD) 1.4 TSi, (CDLF) 2.0 TSi, DSG, R (2009-), Tiguan 4X2, 4X4 (BWK, CAVA) 1.4 TSi Trend&Fun, Track&Field, (CBAB) 2.0 TDi Track&Field, Sport&Style, Trend&Fun, (CCZA) 2.0 TSi Track&Field, Sport&Style, 4-Motion (08-11), (CAXA) 1.4 TSi, (CAVD, CTHD) 1.4 TSi 4-Motion, (CFFD) 2.0 TDi, (CCZB) 2.0 TSi 4-Motion (11-17), Touran (BGU, BSE, BSF) 1.6 5-Spd. Man., (BKC, BLS, BXE) 1.9 TDi MPV TrendLine, DSG, (AZV) 2.0 TDi MPV Comfortline, HighLine, DSG, (BLY) 2.0 FSi MPV HighLine (04-11), (CBZB) 1.2 TSi, (CAVC, CTHC) 1.4 TSi, (CFHF, CLCA) 2.0 TDi (2011-)</p>
---	--

 <p>OD: 97</p>	<p>AR7130 Propshaft Coupling - Front</p> <p>Volkswagen Sharan (AJH, AWC) 1.8T MPV Man., (AMY, AAA) 2.8 VR6 (99-10)</p>
---	--

	<p>AR7131 Propshaft Coupling - Rear</p> <p>Volkswagen Sharan (AJH, AWC) 1.8T MPV Man., (AMY, AAA) 2.8 VR6 (99-10)</p>
---	---

	<p>AR7136 Engine Mounting - RHS</p> <p>BMW 1-Series (E81, E87) 116i (N45) 1.6, 118i (N46) 2.0, 120i (N46) 2.0, 130i (N52) 3.0 (04-15), (E88) 120i (N46) 2.0 (04-15), 3-Series (E90) 320i (N46) 2.0 (05-13), (E92) 320i (N44) 2.0 (02-15)</p>
---	--

	<p>AR7137 Engine Mounting - LHS</p> <p>BMW 1-Series (E81, E87) 116i (N45) 1.6, 118i (N46) 2.0, 120i (N46) 2.0, 130i (N52) 3.0 (04-15), (E88) 120i (N46) 2.0 (04-15), 3-Series (E90) 320i (N46) 2.0 (05-13), (E92) 320i (N44) 2.0 (02-15)</p>
---	--

	<p>AR7138 Engine Mounting - LHS</p> <p>BMW 1-Series (E82) 120d (N47) 2.0 (2005-), (E87) 118d (M47) 2.0, 120d (M47) 2.0 (2005-), 3-Series (E90) 320d (M47) 2.0 (05-13)</p>
---	--

	<p>AR7139 Engine Mounting - RHS</p> <p>BMW 1-Series (E82) 120d (N47) 2.0 (2005-), (E87) 118d (M47) 2.0, 120d (M47) 2.0 (2005-), 3-Series (E90) 320d (M47) 2.0 (05-13), (E90) 320d (N47) 2.0 (2007-)</p>
---	---

ENGINE MOUNTING & RUBBER BUYERS GUIDE

 <p>OD: 50, L: 30</p>	<p>AR7141 Front Stabilizer Bar Bush</p> <p>Renault Megane II (E7J, K4J) 1.4 Authentique, (K9K) 1.5dCi Authentique, Shake It!, (K4M) 1.6, CC Dynamique, Expression, Cabrio, Coupe, Privilège, (K4M) 1.6 Authentique, Shake It!, (K4M700) 1.6 Classic, Expression, Privilège, (F9Q) 1.9dCi, CC Dynamique, DCi Privilège, Dynamique, '+', 2.0, CC Privilège, Classic Dynamique, (F7R) 2.0T Sport, F1 Team (02-10), Scenic II (K4J) 1.4 Authentique, (K4M) 1.6 Authentique, Expression, (F9Q812) 1.9dCi Expression, Dynamique Dies., (F4R) 2.0 Dynamique, Privilège MPV (02-10), Grand Scenic II (F9Q740) 1.9dCi Privilège JA05, (F4R) 2.0 Expression MPV (05-10)</p>	 <p>ID: 16, OD: 62.3, L: 25</p>	<p>AR7149 Front Lower Control Arm Bush - Outer</p> <p>Audi A6 (ABC) 2.6, (AAH) 2.8 (94-97)</p>
	<p>AR7142 Engine Mounting - L/RHS</p> <p>BMW 1-Series (E81, E87) 130i (N52) 3.0 (04-15), (E82, E88) 125i (N52, N54, N55) 3.0 Convertible, Coupe, 135i (N54, N55) 3.0 Turbo (08-14), (E82) M-Coupe (N54T) 3.0 (11-12), 3-Series (E90) 323i (N52N) 2.5, 325i (N53) 2.5, 330i (N52, N53) 3.0, 330d (M57, N57) 3.0 (05-13), 330d (N57) 3.0 (2007-), (E92) 335i (N54, N55) 3.0 (02-15), (E93) 330i (N52) 3.0, 335i (N54, N55) 3.0 (05-14)</p>	 <p>ID: 16, OD: 62.3, L: 57</p>	<p>AR7150 Rear Axle Beam Bush</p> <p>Audi A6 (ABC) 2.6, (AAH) 2.8 (94-97), (AGA, ALF, AMC, APS, ARJ, BDV, BDW) 2.4, (ACK) 2.8 Avant Quattro, (ARS) 4.2 V8 Quattro, Tiptronic (97-05), (AJK, ARE, BES) 2.7T Quattro, (ASB) 3.0 TDi Quattro (00-09), A8 (AQQ) 3.7 Tiptronic, (AQF, AUW, AUX) 4.2 V8 Quattro (95-02)</p>
 <p>ID: 126, PCD: 96 6-HOLES</p>	<p>AR7143 Proshaft Coupling - Rear</p> <p>BMW 1-Series (F20, F21) 116i (N13B16A) 1.6, 118i (B38B15A) 1.5, (N13B16A) 1.6, 120d (B47D20A) 2.0, 120i (N13B16A) 1.6, (B48B20A) 2.0, 125i (B48B20B, N20B20A) 2.0, M135i (N55B30A) 3.0 (11-19), 2-Series (F22, F23) 220d (B47D20A) 2.0 Coupe, 330i (B48B20A, N20B20A/B) 2.0 Coupe, 228i (N20B20A, N26B20A) 2.0 Coupe, 230i (B46B20B, B48B20A) 2.0 Coupe, M235i (N55B30A) 3.0 Coupe, M240i (B58B30A) 3.0 Coupe (14-19), 3-Series (E90) 320d (M47) 2.0, 320i (N46) 2.0, 323i (N52N) 2.5, 325i (N53) 2.5, 330i (N52, N53) 3.0, 330d (M57, N57) 3.0 (05-13), (E93) 330i (N52) 3.0, 335i (N54, N55) 3.0 (05-14), (F30, F31) 316i (N13B16A) 1.6, 318i (B38A15A) 1.6, 320d (N47D20A) 2.0, 320i (B48B20A, N20B20A/B/D) 2.0, 328i (N20B20A) 2.0, 330i (B46B20A, B48B20A) 2.0, 335i (N55B30A) 3.0 (12-19), (F34) 320d GT (B47D20A, N47D20C) 2.0, 320i GT (N20B20A/B) 2.0, 328i GT (N20B20A, N26B20A) 2.0 (2015-), 4-Series (F32) 420d (B47B20A, N47D20C) 2.0 Coupe, 420i (N20B20A/B) 2.0 Coupe, 428i (N20B20A, N26B20A) 2.0 Coupe, 430i (B46B20B, B48B20B) 2.0 Coupe (2014-), (F33) 420i (N20B20B) 2.0 Cabriolet, 428i (N20B20A, N26B20A) 2.0 Cabriolet, 430i (B48B20B) 2.0 Cabriolet (2014-), (F36) 420d (B47B20A, N47D20C) 2.0 Gran Coupe, 420i (N20B20B) 2.0 Gran Coupe, 428i (N20B20A, N26B20A) 2.0 Gran Coupe, 430i (B48B20B) 2.0 Gran Coupe (2014-)</p>	 <p>ID: 12</p>	<p>AR7152 Panhard Rod Bush</p> <p>Audi A6 (ABC) 2.6, (AAH) 2.8 (94-97), (AGA, ALF, AMC, APS, ARJ, BDV, BDW) 2.4, (ACK) 2.8 Avant Quattro, (ARS) 4.2 V8 Quattro, Tiptronic (97-05), (AJK, ARE, BES) 2.7T Quattro, (ASB) 3.0 TDi Quattro (00-09), A8 (AQQ) 3.7 Tiptronic, (AQF, AUW, AUX) 4.2 V8 Quattro (95-02)</p>
 <p>ID: 12, OD: 45, L: 57</p>	<p>AR7145 Rear Trailing Arm Bush - Upper L/RHS</p> <p>BMW 3-Series (E36) 316i (M40) 1.8 Dolphin Shape, 318i (M40) 1.8 Motorsport I / II, (M42) 1.9 S, 320i (M50) 2.0, 323i (M52) 2.5, 325i (M50) 2.5 Dolphin Convertible, 325tds (M51) 2.5 6-Cyl. Dies., 328i (M52T) 2.8 (92-00), (E36, E37) M-Coupe (S50B32) 3.2 6-Cyl. (93-05), (E36, E46) M3 (M54) 3.0, (S50B32/4) 3.2 Convertible (93-05), (E46) 318i (M43) 1.8, (M43) 2.0 Touring SW, (N42) 2.0, 318ti (M47B) 2.0 Compact, 320d (M47D) 2.0 (98-05), 320i (M52) 2.0, (M54) 2.2, 323Ci (M52) 2.5 Coupe, 323i (M52) 2.5, 325Ci (M54) 2.5 Coupe, 325i, 325ti (M50, M54) 2.5 Touring SW, Compact (99-05), 328i (M52TU) 2.8 Coupe, 330Ci (M54) 3.0 Convertible, 330d (M57) 3.0 Dies., 330i (M54) 3.0 (99-05)</p>		<p>AR7155 Engine Mounting - LHS</p> <p>Audi A6 (ABC) 2.6, (AAH) 2.8 (94-97), (AJK, ARE, BES) 2.7T Quattro, (ASB) 3.0 TDi Quattro (00-09)</p>
 <p>ID: 26.5</p>	<p>AR7146 Front Stabilizer Bar Bush</p> <p>BMW 1-Series (E81, E87) 116i (N45) 1.6, 118i (N46) 2.0, 120i (N46) 2.0, 130i (N52) 3.0 (04-15), (E88) 120i (N46) 2.0 (04-15), (E82) 120d (N47) 2.0 (2005-), (E87) 118d (M47) 2.0, 120d (M47) 2.0 (2005-) - Vehicles with Standard Suspension, 3-Series (E90) 320d (M47) 2.0, 320i (N46) 2.0, 323i (N52N) 2.5, 325i (N53) 2.5, 330i (N52, N53) 3.0, 330d (M57, N57) 3.0 (05-13), 320d (N47) 2.0, 330d (N57) 3.0, 335i (N55) 3.0 (2007-), (E92) 320i (N44) 2.0, 325i (N53) 2.5, 335i (N54, N55) 3.0 (02-15), (E93) 330i (N52) 3.0, 335i (N54, N55) 3.0 (05-14)</p>		<p>AR7156 Engine Mounting - RHS</p> <p>Audi A6 (ABC) 2.6, (AAH) 2.8 (94-97), (AJK, ARE, BES) 2.7T Quattro, (ASB) 3.0 TDi Quattro (00-09)</p>
 <p>ID: 16, OD: 80/86, L: 78</p>	<p>AR7147 Rear Axle Carrier Bush - Front Outer L/RHS</p> <p>BMW 1-Series (E81, E87) 116i (N45) 1.6, 118i (N46) 2.0, 120i (N46) 2.0, 130i (N52) 3.0 (04-15), (E88) 120i (N46) 2.0 (04-15), (E82) 120d (N47) 2.0 (2005-), (E87) 118d (M47) 2.0, 120d (M47) 2.0 (2005-), (E82, E88) 125i (N52, N54, N55) 3.0 Convertible, Coupe, 135i (N54, N55) 3.0 Turbo (08-14), 3-Series (E90) 320d (M47) 2.0, 320i (N46) 2.0, 323i (N52N) 2.5, 325i (N53) 2.5, 330i (N52, N53) 3.0, 330d (M57, N57) 3.0 (05-13), 320d (N47) 2.0, 330d (N57) 3.0, 335i (N55) 3.0 (2007-), (E92) 320i (N44) 2.0, 325i (N53) 2.5, 335i (N54, N55) 3.0 (02-15), (E93) 330i (N52) 3.0, 335i (N54, N55) 3.0 (05-14)</p>		<p>AR7159 Engine Mounting - RHS</p> <p>Ford Focus I (ZH16MEFI) 1.6 Ambiente, Trend, (ZH20MEFI) 2.0 RS, Trend, ST170 (00-03)</p>
		 <p>ID: 12, OD: 56, W: 60</p>	<p>AR7163 Subframe Mounting Bush - Front L/RHS</p> <p>Audi A6 (ABC) 2.6, (AAH) 2.8 (94-97), (AJK, ARE, BES) 2.7T Quattro, (ASB) 3.0 TDi Quattro (00-09)</p>
			<p>AR7164 Rear Subframe Mounting - LHS</p> <p>Audi A6 (AJK, ARE, BES) 2.7T Quattro, (ASB) 3.0 TDi Quattro (00-09)</p>
			<p>AR7165 Rear Subframe Mounting - RHS</p> <p>Audi A6 (AJK, ARE, BES) 2.7T Quattro, (ASB) 3.0 TDi Quattro (00-09)</p>
			<p>AR7166 Transmission Mounting</p> <p>Audi 100 2.1 5E, 5S (78-84), 500 2.1E, 2.2, SE, Turbo (83-93)</p>
			<p>AR7167 Front Strut Mounting</p> <p>BMW 7-Series (E38) 740i (M60) 4.0 V8, (M62) 4.4 V8, 750iL (M73) 5.4 V12 (96-03)</p>
			<p>AR7168 Rear Axle Diff. Bush</p> <p>BMW 3-Series (E36) 316i (M40) 1.8 Dolphin Shape, 318i (M40) 1.8 Motorsport I / II, (M42) 1.9 S, 320i (M50) 2.0, 323i (M52) 2.5 (92-00)</p>

ENGINE MOUNTING & RUBBER BUYERS GUIDE

	<p>AR7169 Front Lower Control Arm Bush - Inner Rear</p> <p>BMW Mini Cooper (R50) Cooper (W10B16A) 1.6, (R52) Cooper (W10B16A, W11B16A) 1.6 Convertible, (R53) Cooper S (W11B16A) 1.6 (02-09), Cooper (R55) (N12B16A, N16B16A) 1.6 Clubman, (R56) (N12B16A, N16B16A) 1.6 Hatch, (R57) (N12B16A, N16B16A) 1.6 Convertible, (R58) (N16B16A) 1.6 Coupe, (R59) (N16B16A) 1.6 Roadster, (R60) (N16B16A) 1.6 Countryman, (R61) (N16B16A) 1.6 Paceman (2007-), Cooper S (R55) (N14B16A, N18B16A) 1.6 Clubman, (R56) (N14B16A, N18B16A) 1.6 Hatch, (R57) (N14B16A, N18B16A) 1.6 Convertible, (R58) (N16B16A) 1.6 Coupe, (R59) (N18B16A) 1.6 Roadster, (R60) (N18B16A) 1.6 Countryman, (R61) (N18B16A) 1.6 Paceman (2007-), Cooper S 4X4 (R60) (N18B16A) 1.6 Countryman, (R61) (N18B16A) 1.6 Paceman (2010-), Cooper John (R55) (N14B16C) 1.6 Clubman, (R56) (N14B16C, N18B16C) 1.6 Hatch, (R57) (N14B16C, N18B16C) 1.6 Convertible, (R58) (N14B16C, N18B16C) 1.6 Coupe, (R59) (N14B16C, N18B16C) 1.6 Roadster (2007-), Countryman JCW (R56) (N18B16C) 1.6 Hatch, (R60) (N18B16A) 1.6 Countryman (2007-), One (R56) (N16B16A) 1.6 Hatch, (R57) (N16B16A) 1.6 Convertible (2007-)</p>
	<p>AR7170 Rear Lower Control Arm Bush - Outer, Wheel Carrier Bush Bottom</p> <p>BMW 3-Series (E36) 328i (M52TU) 2.8 Dolphin Convertible, Individual (95-00), (E36, E46) M3 (M54) 3.0, (S50B32/4) 3.2 Convertible (93-05), 5-Series (E39) 523i (M52) 2.5, 525i (M54) 2.5, 528i (M52) 2.8, 530d (M57) 3.0 Dies., 530i (M54) 3.0 (96-04), 540i (M62) 4.4, M5 (S38) 3.6 (98-04), (S62) 4.9 V8 (99-04), (E60) 523i (M52, M53) 2.5, 525i (M54, N52) 2.5, 530d (M57) 3.0, 530i (M54, N52) 3.0, 545i (N62B44A) 4.4 V8 (04-10), 6-Series (E63, E64) 645Ci 4.4 (04-08), 7-Series (E38) 740i (M60) 4.0 V8, (M62) 4.4 V8, 750iL (M73) 5.4 V12 (96-03), X5 (E53) 4X4 (M57N) 3.0d Steptronic SUV Dies., (M54) 3.0i Steptronic SUV 6-Cyl. Pet., (M62) 4.4i Steptronic SUV Pet., (N62) 4.8iS Steptronic SUV V8 Pet. (01-10)</p>
	<p>AR7173 Rear Axle Carrier Bush - Front LHS</p> <p>BMW 3-Series (E46) 318i (M43) 1.8, (M43) 2.0 Touring SW, (N42) 2.0, 318ti (M47B) 2.0 Compact, 320d (M47D) 2.0 (98-05)</p>
	<p>AR7174 Front Stabilizer Bar Bush</p> <p>Audi A3 (CMSA) 1.4 TFSi, (CAYC) 1.6 TDi, (CDA) 1.8 TFSi, (BXE) 1.9 TDi, (CLJA) 2.0 TDi (08-13), A4 (8D2, B5) (APU) 1.8T Avant, Multitronic, SW (95-01), (CABA/B, CDHA/B, CJEB) 1.8 TFSi, (BRD, CAGA, C/JCA, CMEA, CMFA) 2.0 TDi, (CABE, CDNC, CGLC, CMGB) 2.0 TFSi, (CDNC, CPMA) 2.0 TFSi Quattro (08-14), A4 / A5 (CAPA, CCWA, CDUC, CKVB) 3.0 TDi Quattro, S-Tronic, Tiptronic, A4 (CALA) 3.2 FSi Quattro S-Tronic, A5 (CMUA) 3.0 TFSi Quattro S-Tronic, (CALA) 3.2 FSi Quattro S-Tronic (08-14), A6 (CGLC, CMGM) 2.0 TDi 8-Spd. Diesel Auto., (CDNB) 2.0 FSi 8-Spd. Petrol Auto. (11-15); Volkswagen Passat IV 1.8T 5-Spd. Man., 5-Spd. Auto., 2.8 V6 Quattro, Quattro Tiptronic 5-Spd. Man., 5-Spd. Auto. (99-05)</p>
	<p>AR7176 Rear Axle Carrier Bush - Front RHS</p> <p>BMW 3-Series (E46) 318i (M43) 1.8, (M43) 2.0 Touring SW, (N42) 2.0, 318ti (M47B) 2.0 Compact, 320d (M47D) 2.0 (98-05)</p>
	<p>AR7177 Front Lower Control Arm Bush - Outer Front</p> <p>Audi A3 (CMSA) 1.4 TFSi, (CAYC) 1.6 TDi, (CDA) 1.8 TFSi, (BXE) 1.9 TDi, (CLJA) 2.0 TDi (08-13), A4 (8D2, B5) (APU) 1.8T Avant, Multitronic, SW (95-01), A6 (AGA, ALF, AMC, APS, ARJ, BDV, BDW) 2.4, (ACK) 2.8 Avant Quattro, (ARS) 4.2 V8 Quattro, Tiptronic (97-05), (AJK, ARE, BES) 2.7T Quattro, (ASB) 3.0 TDi Quattro (00-09), A8 (AQQ) 3.7 Tiptronic, (AQF, AUW, AUX) 4.2 V8 Quattro (95-02); Volkswagen Passat IV 1.8T 5-Spd. Man., 5-Spd. Auto., 2.8 V6 Quattro, Quattro Tiptronic 5-Spd. Man., 5-Spd. Auto. (99-05)</p>

	<p>AR7178 Rear Axle Carrier Diff. Bush - L/RHS</p> <p>BMW 3-Series (E46) 318i (M43) 1.8, (M43) 2.0 Touring SW, (N42) 2.0, 318ti (M47B) 2.0 Compact, 320d (M47D) 2.0 (98-05)</p>
	<p>AR7180 Rear Axle Carrier Bush - Rear L/RHS</p> <p>BMW 3-Series (E46) 318i (M43) 1.8, (M43) 2.0 Touring SW, (N42) 2.0, 318ti (M47B) 2.0 Compact, 320d (M47D) 2.0 (98-05)</p>
	<p>AR7181 Front Stabilizer Bar Bush</p> <p>Audi A6 (ABC) 2.6, (AAH) 2.8 (94-97)</p>
	<p>AR7182 Rear Stabilizer Link Assy.</p> <p>BMW 3-Series (E46) 318i (M43) 1.8, (M43) 2.0 Touring SW, (N42) 2.0, 318ti (M47B) 2.0 Compact, 320d (M47D) 2.0 (98-05), 320i (M52) 2.0, (M54) 2.2, 323Ci (M52) 2.5 Coupe, 323i (M52) 2.5, 325Ci (M54) 2.5 Coupe, 325i, 325ti (M50, M54) 2.5 Touring SW, Compact (99-05), 328i (M52TU) 2.8 Coupe, 330Ci (M54) 3.0 Convertible, 330d (M57) 3.0 Dies., 330i (M54) 3.0 (99-05)</p>
	<p>AR7185 Rear Stabilizer Link Assy.</p> <p>BMW 5-Series (E34) 520i (M50B20) 2.0, 525i (M50B25) 2.5, 530i (M60B30) 3.0 V8, 535i (M30B35) 3.5 6-Cyl., 540i (M60B40) 4.0 Edition V8 (89-96), 7-Series (E32) 730i (M30, M60) 3.0, 735i (M30) 3.5 6-Cyl., 740i (M60, M62) 4.0, 750iL (M70) 5.0 V12 (87-96)</p>
	<p>AR7186 Transmission Mounting</p> <p>Volkswagen Passat IV 1.8T 5-Spd. Man., 2.8 V6 Quattro, Quattro Tiptronic 5-Spd. Man. (99-05)</p>
	<p>AR7188 Front Subframe Bush - Front & Rear</p> <p>Audi A4 (8D2, B5) (APU) 1.8T Avant, Multitronic, SW (95-01), (N42) 2.0, A6 (AGA, ALF, AMC, APS, ARJ, BDV, BDW) 2.4, (ACK) 2.8 Avant Quattro, (ARS) 4.2 V8 Quattro, Tiptronic (97-05), A8 (AQQ) 3.7 Tiptronic, (AQF, AUW, AUX) 4.2 V8 Quattro (95-02); Volkswagen Passat IV 1.8T 5-Spd. Man., 5-Spd. Auto., 2.8 V6 Quattro, Quattro Tiptronic 5-Spd. Man., 5-Spd. Auto. (99-05)</p>
	<p>AR7189 Front Subframe Bush - Front & Rear</p> <p>Audi A4 (8D2, B5) (APU) 1.8T Avant, Multitronic, SW (95-01), (8E2/5, B6) (BFB) 1.8T Avant, Multitronic, SV, (ALT) 2.0 Executive (BGB) 2.0 TFSi, (BLB) 2.0 TDi (00-08), A6 (AGA, ALF, AMC, APS, ARJ, BDV, BDW) 2.4, (ACK) 2.8 Avant Quattro, (ARS) 4.2 V8 Quattro, Tiptronic (97-05), A8 (AQQ) 3.7 Tiptronic, (AQF, AUW, AUX) 4.2 V8 Quattro (95-02); Volkswagen Passat IV 1.8T 5-Spd. Man., 5-Spd. Auto., 2.8 V6 Quattro, Quattro Tiptronic 5-Spd. Man., 5-Spd. Auto. (99-05)</p>
	<p>AR7190 Front Upper Control Arm Bush - Inner</p> <p>BMW 5-Series (E28) 520i (M20B20) 2.0, 525e (M30B27) 2.5, 528i (M30B28) 2.8, 535i (M30B35) 3.5, M535i (M90) 3.5 6-Cyl., M5 (MX30) 3.5 (85-89)</p>
	<p>AR7191 Upper Control Arm Bush - Front Inner</p> <p>BMW 5-Series (E39) M5 (S62) 4.9 V8 (99-04), 7-Series (E38) 740i (M60) 4.0 V8, (M62) 4.4 V8, 750iL (M73) 5.4 V12 (96-03)</p>
	<p>AR7192 Transmission Mounting</p> <p>BMW 7-Series (E32) 730i (M30, M60) 3.0, 735i (M30) 3.5 6-Cyl. (87-96), 8-Series (E31) 850Ci (M70) 5.0 V12 (91-94)</p>







ENGINE MOUNTING & RUBBER BUYERS GUIDE

	<p>AR7194 Diff. Mounting</p> <p>BMW 5-Series (E34) 530i (M60B30) 3.0 V8, 535i (M30B35) 3.5 6-Cyl., 540i (M60B40) 4.0 Edition V8 (95-96), M5 (M50B35) 3.5 6-Cyl. (92-94), 7-Series (E32) 730i (M30, M60) 3.0, 735i (M30) 3.5 6-Cyl., 740i (M60, M62) 4.0, 750iL (M70) 5.0 V12 (87-96)</p>	 <p>ID: 35</p>	<p>AR7201 Centre Bearing Rubber</p> <p>BMW 5-Series (E34) 540i (M60B40) 4.0 Edition V8 (95-96), M5 (M50B35) 3.5 6-Cyl. (92-94), 7-Series (E32) 740i (M60, M62) 4.0, 750iL (M70) 5.0 V12 (88-95), 8-Series (E31) 850Ci (M70) 5.0 V12 (91-94)</p>
	<p>AR7196 Front Strut Mounting</p> <p>BMW 1-Series (E81, E87) 116i (N45) 1.6, 118i (N46) 2.0, 120i (N46) 2.0, 130i (N52) 3.0 (04-15), (E88) 120i (N46) 2.0 (04-15), (E82) 120d (N47) 2.0 (2005-), (E87) 118d (M47) 2.0, 120d (M47) 2.0 (2005-), (E82, E88) 125i (N52, N54, N55) 3.0 Convertible, Coupe, 135i (N54, N55) 3.0 Turbo (08-14), (E82) M-Coupe (N54T) 3.0 (11-12), 3-Series (E36, E37) M-Coupe (S50B32) 3.2 6-Cyl. (93-05), (E46) 318i (M43) 1.8, (M43) 2.0 Touring SW, (N42) 2.0, 318ti (M47B) 2.0 Compact, 320d (M47D) 2.0 (98-05), 320i (M52) 2.0, (M54) 2.2, 323Ci (M52) 2.5 Coupe, 323i (M52) 2.5, 325Ci (M54) 2.5 Coupe, 325i, 325ti (M50, M54) 2.5 Touring SW, Compact (99-05), 328i (M52TU) 2.8 Coupe, 330Ci (M54) 3.0 Convertible, 330d (M57) 3.0 Dies., 330i (M54) 3.0 (99-05), (E90) 320d (M47) 2.0, 320i (N46) 2.0, 323i (N52N) 2.5, 325i (N53) 2.5, 330i (N52, N53) 3.0, 330d (M57, N57) 3.0 (05-13), 320d (N47) 2.0, 330d (N57) 3.0, 335i (N55) 3.0 (2007-), (E92) 320i (N44) 2.0, 325i (N53) 2.5, 335i (N54, N55) 3.0 (02-15), (E93) 330i (N52) 3.0, 335i (N54, N55) 3.0 (05-14), 5-Series (E39) 523i (M52) 2.5, 525i (M54) 2.5, 528i (M52) 2.8, 530d (M57) 3.0 Dies., 530i (M54) 3.0 (96-04), (E60) 523i (M52, M53) 2.5, 525i (M54, N52) 2.5, 530d (M57) 3.0, 530i (M54, N52) 3.0, 545i (N62B44A) 4.4 V8 (04-10), 6-Series (E63, E64) 645Ci 4.4 (04-08), X3 (E83) 4X4 (M54, N52N) 2.5i SUV, LCi SUV, (M57N2) 3.0d SUV, (N52N) 3.0si (04-07), (M47N2) 2.0d Steptronic SUV Dies. (04-10), (M47N2) 2.0d Steptronic SUV Dies., (N46) 2.0i (06-10)</p>		<p>AR7202 Engine Mounting L/RHS</p> <p>BMW 3-Series (E36) 316i (M40) 1.8 Dolphin Shape, 318i (M40) 1.8 Motorsport I / II, (M42) 1.9 S, 320i (M50) 2.0, 323i (M52) 2.5, 325i (M50) 2.5 Dolphin Convertible, 325tds (M51) 2.5 6-Cyl. Dies., 328i (M52T) 2.8 (92-00), 320i (M52) 2.0, (M54) 2.2, 323Ci (M52) 2.5 Coupe, 323i (M52) 2.5, 325Ci (M54) 2.5 Coupe, 325i, 325ti (M50, M54) 2.5 Touring SW, Compact (99-05)</p>
	<p>AR7197 Rear Strut Mounting</p> <p>Seat Altea (BVY, BVZ) 2.0 FSi, (BMM) 2.0 TDi MPV (06-09), Leon (BLR, BLY, BVZ) 2.0 FSi, (BKD, BMM, CFHC, CLCB) 2.0 TDi, (BWA, BWJ, CDLD) 2.0T, FSi (06-09); Volkswagen Beetle (CBZB) 1.2 TSi, (CZDA) 1.4 TSi (2012-), Golf V (BGU) 1.6i Comfortline, Tiptronic, Trendline, (BLS, BXE) 1.9 TDi Comfortline, DSG, (BKD) 2.0 TDi DSG Sport, Sport Tiptronic, Sport 5-Spd. Man., 6-Spd. Auto., (BLX) 2.0i Trendline, GTi DSG, Comfortline, GTi 5-Spd. Man., 6-Spd. Auto., (BLY) 2.0 FSi Sport, Sport Tiptronic 6-Spd. Man., Auto. (04-09), Golf VI (CAXA, CAVD) 1.4 TSi Trendline, Comfortline, HighLine, (BSE, BSF, CCSA) 1.6i Trendline, (CAYC) 1.6 TDi Comfortline, DSG, Bluemotion, (CBAB, CFFB) 2.0 TDi HighLine, (CCZB) 2.0 GTi DSG, 2.0 TSi-R 4-Motion, DSG (09-13), Jetta V (CAVD, CAXA) 1.4 TSi Trendline, Comfortline, DSG, HighLine, (CAYC) 1.6 TDi Comfortline, DSG (09-11), 1.6i Comfortline, Tiptronic, Trendline, (BKC) 1.9 TDi Comfortline, DSG, (BHY) 2.0i Trendline, DSG, Comfortline, 5-Spd. Man., 6-Spd. Auto., (BHY) 2.0i Trendline, DSG, Comfortline, 5-Spd. Man., 6-Spd. Auto., 2.0 FSi, TFSi, Sportline, Tiptronic 6-Spd. Man./Auto. (05-11), (AZV, BKD, BMM) 2.0 TDi Sportline, Tiptronic, HighLine 5-Spd. Man., 6-Spd. Auto., 2.0 TSi HighLine (2005-), Jetta VI (CBZB) 1.2 TSi, (CAVD, CAXA) 1.4 TSi, (CAYC) 1.6 TDi, (CFHC, CJAA, CLCB) 2.0 TDi (2011-), Scirocco (CAVD) 1.4 TSi, (CDLF) 2.0 TSi, DSG, R (2009-), Tiguan 4X2, 4X4 (BWK, CAVA) 1.4 TSi Trend&Fun, Track&Field, (CBAB) 2.0 TDi Track&Field, Sport&Style, Trend&Fun, (CCZA) 2.0 TSi Track&Field, Sport&Style, 4-Motion (08-11), Touran (BGU, BSE, BSF) 1.6 5-Spd. Man., (BKC, BLS, BXE) 1.9 TDi MPV TrendLine, DSG, (AZV) 2.0 TDi MPV Comfortline, HighLine, DSG, (BLY) 2.0 FSi MPV HighLine (04-11), (CBZB) 1.2 TSi, (CAVC, CTHC) 1.4 TSi, (CFHC, CLCA) 2.0 TDi (2011-)</p>		<p>AR7203 Front Strut Mounting</p> <p>BMW 7-Series (E32) 730i (M30, M60) 3.0, 735i (M30) 3.5 6-Cyl., 740i (M60, M62) 4.0, 750iL (M70) 5.0 V12 (87-96)</p>
	<p>AR7198 Engine Mounting - RHS</p> <p>Volkswagen Caddy (BGU) 1.6i Life Van, MPV, (BJB) 1.9 TDi, Life Van, MPV, (BDJ) 2.0 SDi Van (04-16), (CLCA) 2.0 TDi 5-Spd. Man., (CFHC, CLCB) 2.0 TDi (2010-), Golf V (BLS, BXE) 1.9 TDi Comfortline, DSG (04-09), Jetta V (BKC) 1.9 TDi Comfortline, DSG (05-11), Passat V (BKC, BLS, BXE) 1.9 TDi Comfortline, DSG, HighLine (05-11), Touran (BKC, BLS, BXE) 1.9 TDi MPV TrendLine, DSG (04-11)</p>	 <p>L: 135</p>	<p>AR7204 Front Lower Control Arm Bush - Rear LHS</p> <p>BMW 3-Series (E46) M3 (M54) 3.0, (S50B32/4) 3.2 Convertible (93-05), (E46) 318i (M43) 1.8, (M43) 2.0 Touring SW, (N42) 2.0, 318ti (M47B) 2.0 Compact, 320d (M47D) 2.0 (98-05), 320i (M52) 2.0, (M54) 2.2, 323Ci (M52) 2.5 Coupe, 323i (M52) 2.5, 325Ci (M54) 2.5 Coupe, 325i, 325ti (M50, M54) 2.5 Touring SW, Compact (99-05), 328i (M52TU) 2.8 Coupe, 330Ci (M54) 3.0 Convertible, 330d (M57) 3.0 Dies., 330i (M54) 3.0 (99-05)</p>
 <p>NO PICTURE AVAILABLE AT TIME OF PRINT</p>	<p>AR7199 Gearbox Mounting - Lower LHS</p> <p>Audi A6 (AJK, ARE, BES) 2.7T Quattro, (ASB) 3.0 TDi Quattro (00-09)</p>	 <p>L: 135</p>	<p>AR7205 Front Lower Control Arm Bush - Rear RHS</p> <p>BMW 3-Series (E46) M3 (M54) 3.0, (S50B32/4) 3.2 Convertible (93-05), (E46) 318i (M43) 1.8, (M43) 2.0 Touring SW, (N42) 2.0, 318ti (M47B) 2.0 Compact, 320d (M47D) 2.0 (98-05), 320i (M52) 2.0, (M54) 2.2, 323Ci (M52) 2.5 Coupe, 323i (M52) 2.5, 325Ci (M54) 2.5 Coupe, 325i, 325ti (M50, M54) 2.5 Touring SW, Compact (99-05), 328i (M52TU) 2.8 Coupe, 330Ci (M54) 3.0 Convertible, 330d (M57) 3.0 Dies., 330i (M54) 3.0 (99-05)</p>
 <p>NO PICTURE AVAILABLE AT TIME OF PRINT</p>	<p>AR7200 Gearbox Mounting - Lower RHS</p> <p>Audi A6 (AJK, ARE, BES) 2.7T Quattro, (ASB) 3.0 TDi Quattro (00-09)</p>		<p>AR7206 Front Stabilizer Bar Bush</p> <p>BMW 3-Series (E36) 316i (M40) 1.8 Dolphin Shape, 318i (M40) 1.8 Motorsport I / II, (M42) 1.9 S (92-00), 328i (M52TU) 2.8 Dolphin Convertible, Individual (95-00)</p>
			<p>AR7207 Engine Mounting - L/RHS</p> <p>BMW 3-Series (E46) 318i (M43) 1.8, (M43) 2.0 Touring SW, (N42) 2.0, 318ti (M47B) 2.0 Compact, 320d (M47D) 2.0 (98-05)</p>
			<p>AR7208 Front Stabilizer Bar Bush</p> <p>BMW 3-Series (E36) 320i (M50) 2.0, 323i (M52) 2.5 (92-00), 325i (M50) 2.5 Dolphin Convertible, 325tds (M51) 2.5 6-Cyl. Dies., 328i (M52T) 2.8 (92-99)</p>
		 <p>ID: 12.5, OD: 60.5, L: 77</p>	<p>AR7209 Rear Axle Carrier Bush - Front</p> <p>BMW 3-Series (E36) 316i (M40) 1.8 Dolphin Shape, 318i (M40) 1.8 Motorsport I / II, (M42) 1.9 S, 320i (M50) 2.0, 323i (M52) 2.5, 325i (M50) 2.5 Dolphin Convertible, 325tds (M51) 2.5 6-Cyl. Dies., 328i (M52T) 2.8 (92-00)</p>
		 <p>ID: 15.5, OD: 62.5, L: 66.5</p>	<p>AR7210 Rear Axle Carrier Bush - Rear</p> <p>BMW 3-Series (E36) 316i (M40) 1.8 Dolphin Shape, 318i (M40) 1.8 Motorsport I / II, (M42) 1.9 S, 320i (M50) 2.0, 323i (M52) 2.5, 325i (M50) 2.5 Dolphin Convertible, 325tds (M51) 2.5 6-Cyl. Dies., 328i (M52T) 2.8 (92-00)</p>
			<p>AR7211 Engine Mounting - L/RHS</p> <p>BMW 3-Series (E36, E37) M-Coupe (S50B32) 3.2 6-Cyl. (93-05), Z3 (M52) 2.8 Roadster, (M54) 3.0 Roadster 6-Cyl. (97-03), (E36, E46) M3 (M54) 3.0, (S50B32/4) 3.2 Convertible (93-05)</p>

ENGINE MOUNTING & RUBBER

BUYERS GUIDE

 <p>ID: 12, OD: 61, L: 49</p>	<p>AR7212 Rear Trailing Arm Bush - Front L/RHS</p> <p>BMW 3-Series (E30) 316 (M10) 1.8, 316i (M40) 1.6, (M40) 1.8 Cabriolet, 318i (M40) 1.8 Cabriolet (83-92), 320i (M20, M50) 2.0, 323i (M20) 2.3, 325i (M20B25) 2.5, (M20B27) 2.7 Shadowline, iS Shadowline, Cabriolet, 333i (M30) 3.3 6-Cyl. (83-92), (E36) 316i (M40) 1.8 Dolphin Shape, 318i (M40) 1.8 Motorsport I / II, (M42) 1.9 S, 320i (M50) 2.0, 323i (M52) 2.5, 325i (M50) 2.5 Dolphin Convertible, 325tds (M51) 2.5 6-Cyl. Dies., 328i (M52T) 2.8 (92-00), (E36, E46) M3 (M54) 3.0, (S50B32/4) 3.2 Convertible (93-05), (E46) 318i (M43) 1.8, (M43) 2.0 Touring SW, (N42) 2.0, 318ti (M47B) 2.0 Compact, 320d (M47D) 2.0 (98-05), 320i (M52) 2.0, (M54) 2.2, 323Ci (M52) 2.5 Coupe, 323i (M52) 2.5, 325Ci (M54) 2.5 Coupe, 325i, 325ti (M50, M54) 2.5 Touring SW, Compact (99-05), 328i (M52TU) 2.8 Coupe, 330Ci (M54) 3.0 Convertible, 330d (M57) 3.0 Dies., 330i (M54) 3.0 (99-05)</p>
 <p>ID: 12, OD: 45, L: 29/56</p>	<p>AR7213 Rear Trailing Arm Bush - Lower L/RHS</p> <p>BMW 3-Series (E36) 316i (M40) 1.8 Dolphin Shape, 318i (M40) 1.8 Motorsport I / II, (M42) 1.9 S, 320i (M50) 2.0, 323i (M52) 2.5, 325i (M50) 2.5 Dolphin Convertible, 325tds (M51) 2.5 6-Cyl. Dies., 328i (M52T) 2.8 (92-00), 328i (M52TU) 2.8 Dolphin Convertible, Individual (95-00), (E36, E37) M-Coupe (S50B32) 3.2 6-Cyl. (93-05), (E36, E46) M3 (M54) 3.0, (S50B32/4) 3.2 Convertible (93-05), (E46) 318i (M43) 1.8, (M43) 2.0 Touring SW, (N42) 2.0, 318ti (M47B) 2.0 Compact, 320d (M47D) 2.0 (98-05), 320i (M52) 2.0, (M54) 2.2, 323Ci (M52) 2.5 Coupe, 323i (M52) 2.5, 325Ci (M54) 2.5 Coupe, 325i, 325ti (M50, M54) 2.5 Touring SW, Compact (99-05), 328i (M52TU) 2.8 Coupe, 330Ci (M54) 3.0 Convertible, 330d (M57) 3.0 Dies., 330i (M54) 3.0 (99-05)</p>
 <p>ID: 12, OD: 38, L: 57</p>	<p>AR7214 Rear Lower Control Arm Bush - Inner L/RHS</p> <p>BMW 3-Series (E36) 316i (M40) 1.8 Dolphin Shape, 318i (M40) 1.8 Motorsport I / II, (M42) 1.9 S, 320i (M50) 2.0, 323i (M52) 2.5, 325i (M50) 2.5 Dolphin Convertible, 325tds (M51) 2.5 6-Cyl. Dies., 328i (M52T) 2.8 (92-00), 328i (M52TU) 2.8 Dolphin Convertible, Individual (95-00), (E36, E37) M-Coupe (S50B32) 3.2 6-Cyl. (93-05), (E36, E46) M3 (M54) 3.0, (S50B32/4) 3.2 Convertible (93-05), (E46) 318i (M43) 1.8, (M43) 2.0 Touring SW, (N42) 2.0, 318ti (M47B) 2.0 Compact, 320d (M47D) 2.0 (98-05), 320i (M52) 2.0, (M54) 2.2, 323Ci (M52) 2.5 Coupe, 323i (M52) 2.5, 325Ci (M54) 2.5 Coupe, 325i, 325ti (M50, M54) 2.5 Touring SW, Compact (99-05), 328i (M52TU) 2.8 Coupe, 330Ci (M54) 3.0 Convertible, 330d (M57) 3.0 Dies., 330i (M54) 3.0 (99-05)</p>
	<p>AR7215 Centre Bearing Rubber</p> <p>BMW 3-Series (E36, E37) M-Coupe (S50B32) 3.2 6-Cyl. (93-05), (E46) M3 (M54) 3.0, (S50B32/4) 3.2 Convertible (93-05), 318i (M43) 1.8, (M43) 2.0 Touring SW, (N42) 2.0, 318ti (M47B) 2.0 Compact, 320d (M47D) 2.0 (98-05), 320i (M52) 2.0, (M54) 2.2, 323Ci (M52) 2.5 Coupe, 323i (M52) 2.5, 325Ci (M54) 2.5 Coupe, 325i, 325ti (M50, M54) 2.5 Touring SW, Compact (99-05), 328i (M52TU) 2.8 Coupe, 330Ci (M54) 3.0 Convertible, 330d (M57) 3.0 Dies., 330i (M54) 3.0 (99-05)</p>
	<p>AR7216 Rear Stabilizer Bar Bush</p> <p>BMW 3-Series (E36) 316i (M40) 1.8 Dolphin Shape, 318i (M40) 1.8 Motorsport I / II, (M42) 1.9 S, 320i (M50) 2.0, 323i (M52) 2.5 (92-00)</p>
 <p>ID: 12, OD: 35, L: 42/66.5</p>	<p>AR7217 Rear Upper Control Arm Bush - Inner L/RHS</p> <p>BMW 3-Series (E36) 316i (M40) 1.8 Dolphin Shape, 318i (M40) 1.8 Motorsport I / II, (M42) 1.9 S, 320i (M50) 2.0, 323i (M52) 2.5, 325i (M50) 2.5 Dolphin Convertible, 325tds (M51) 2.5 6-Cyl. Dies., 328i (M52T) 2.8 (92-00), (E36, E37) M-Coupe (S50B32) 3.2 6-Cyl. (93-05), (E36, E46) M3 (M54) 3.0, (S50B32/4) 3.2 Convertible (93-05), (E46) 318i (M43) 1.8, (M43) 2.0 Touring SW, (N42) 2.0, 318ti (M47B) 2.0 Compact, 320d (M47D) 2.0 (98-05), 320i (M52) 2.0, (M54) 2.2, 323Ci (M52) 2.5 Coupe, 323i (M52) 2.5, 325Ci (M54) 2.5 Coupe, 325i, 325ti (M50, M54) 2.5 Touring SW, Compact (99-05), 328i (M52TU) 2.8 Coupe, 330Ci (M54) 3.0 Convertible, 330d (M57) 3.0 Dies., 330i (M54) 3.0 (99-05)</p>

 <p>ID: 14</p>	<p>AR7220 Front Strut Mounting</p> <p>BMW 3-Series (E30) 316 (M10) 1.8, 316i (M40) 1.6, (M40) 1.8 Cabriolet, 318i (M40) 1.8 Cabriolet (83-92), 320i (M20, M50) 2.0, 323i (M20) 2.3, 325i (M20B25) 2.5, (M20B27) 2.7 Shadowline, iS Shadowline, Cabriolet, 333i (M30) 3.3 6-Cyl. (83-92), 5-Series (E28) 520i (M20B20) 2.0, 525e (M30B27) 2.5, 528i (M30B28) 2.8, 535i (M30B35) 3.5, M535i (M90) 3.5 6-Cyl., M5 (MX30) 3.5 (85-89), (E34) 520i (M50B20) 2.0, 525i (M50B25) 2.5, M5 (M50B35) 3.5 6-Cyl. (89-96)</p>
 <p>ID: 14/32</p>	<p>AR7221 Front Strut Mounting</p> <p>BMW 3-Series (E36) 316i (M40) 1.8 Dolphin Shape, 318i (M40) 1.8 Motorsport I / II, (M42) 1.9 S, 320i (M50) 2.0, 323i (M52) 2.5 (92-00), 325i (M50) 2.5 Dolphin Convertible, 325tds (M51) 2.5 6-Cyl. Dies., 328i (M52T) 2.8 (92-99), (E36, E46) 328i (M52TU) 2.8 Dolphin Convertible, Individual (95-00), M3 (M54) 3.0, (S50B32/4) 3.2 Convertible (93-05), Z3 (M52) 2.8 Roadster, (M54) 3.0 Roadster 6-Cyl. (97-03)</p>
	<p>AR7222 Transmission Mounting - LHS</p> <p>Audi A3 (BVZ) 2.0 FSi (03-13), (CBFA, CCZA) 2.0 TFSi, (BUB) 3.2 Quattro (04-13), (CMSA) 1.4 TFSi, (CAYC) 1.6 TDi (08-13), (CZCA, CZEAA) 1.4 TFSi, (CRFC) 2.0 TDi (13-17); Seat Altea (BVY, BVZ) 2.0 FSi Man. (06-09), Leon (BLR, BLY, BVZ) 2.0 FSi Man., (BWA, BWJ, CDLD) 2.0 FSi Man. (06-09); Volkswagen Beetle (CBZB) 1.2 TSi, (CZDA) 1.4 TSi (2012-), Caddy (BJB) 1.9 TDi, Life Van, MPV, (BDJ) 2.0 Sdi Van (04-16), (CLCA) 2.0 TDi 5-Spd. Man., (CFHC, CLCB) 2.0 TDi (2010-), CC (CFGB) 2.0 TDi, (CCZB) 2.0 TSi, (BWS) 3.6 FSi V6 4-Motion (2009-), Golf V (BGU) 1.6i Comfortline, Tiptronic, Trendline, (BLS, BXE) 1.9 TDi Comfortline, DSG, (BKD) 2.0 TDi DSG Sport, Sport Tiptronic, Sport 5-Spd. Man., 6-Spd. Auto., (BLX) 2.0i Trendline, GTi DSG, Comfortline, GTi 5-Spd. Man., 6-Spd. Auto., (BLY) 2.0 FSi Sport, Sport Tiptronic 6-Spd. Man., Auto. (04-09), Golf VI (CAXA, CAVD) 1.4 TSi Trendline, Comfortline, HighLine, (BSE, BSF, CCSA) 1.6i Trendline, (CAYC) 1.6 TDi Comfortline, DSG, Bluemotion, (CBAB, CFFB) 2.0 TDi HighLine, (CCZB) 2.0 GTi DSG, 2.0 TSi-R 4-Motion, DSG (09-13), Golf VII (CRVA, CYKB) 2.0 TDi, (CRBC, CRLB, CRMB, CRUA) 2.0 TDi (2013-), Jetta V (CAVD, CAXA) 1.4 TSi Trendline, Comfortline, DSG, HighLine, (CAYC) 1.6 TDi Comfortline, DSG (09-11), 1.6i Comfortline, Tiptronic, Trendline, (BKC) 1.9 TDi Comfortline, DSG, (BHY) 2.0i Trendline, DSG, Comfortline, 5-Spd. Man., 6-Spd. Auto., (BHY) 2.0i Trendline, DSG, Comfortline, 5-Spd. Man., 6-Spd. Auto., 2.0 FSi, TFSi, Sportline, Tiptronic 6-Spd. Man./Auto. (05-11), (AZV, BKD, BMM) 2.0 TDi Sportline, Tiptronic, HighLine 5-Spd. Man., 6-Spd. Auto., 2.0 TSi HighLine (2005-), Jetta VI (CBZB) 1.2 TSi, (CAVD, CAXA) 1.4 TSi, (CAYC) 1.6 TDi (2011-), Passat V (BZB, CDAA) 1.8 TSi Comfortline, DSG, HighLine, (BKC, BLS, BXE) 1.9 TDi Comfortline, DSG, HighLine, (AXX, BLR, BLY, BPY, BVY, BVZ, BWA, CAWB, CBFA, CCZ/TA) 2.0 FSi, TFSi Comfortline, HighLine (05-11), Scirocco (CAVD) 1.4 TSi, (CDLF) 2.0 TSi, DSG, R (2009-), Tiguan 4X2, 4X4 (BWK, CAVA) 1.4 TSi Man. Trend&Fun, Track&Field, (CBAB) 2.0 TDi Track&Field, Sport&Style, Trend&Fun, (CCZA) 2.0 TSi Track&Field, Sport&Style, 4-Motion (08-11), Touran (BGU, BSE, BSF) 1.6 5-Spd. Man., (BKC, BLS, BXE) 1.9 TDi MPV TrendLine, DSG, (AZV) 2.0 TDi MPV Comfortline, HighLine, DSG, (BLY) 2.0 FSi MPV HighLine (04-11), (CBZB) 1.2 TSi, (CAVC, CTHC) 1.4 TSi (2011-)</p>
	<p>AR7224 Front Strut Mounting</p> <p>BMW 5-Series (E39) 540i (M62) 4.4, M5 (S38) 3.6 (98-04), (S62) 4.9 V8 (99-04)</p>
 <p>ID: 15, OD: 58, L: 104</p>	<p>AR7225 Rear Axle Carrier Bush</p> <p>BMW 3-Series (E30) 316 (M10) 1.8, 316i (M40) 1.6, (M40) 1.8 Cabriolet, 318i (M40) 1.8 Cabriolet (83-92), 320i (M20, M50) 2.0, 323i (M20) 2.3, 325i (M20B25) 2.5, (M20B27) 2.7 Shadowline, iS Shadowline, Cabriolet, 333i (M30) 3.3 6-Cyl. (83-92)</p>
 <p>ID: 15, OD: 58, L: 65/117</p>	<p>AR7227 Engine Mounting - L/RHS</p> <p>BMW 3-Series (E36) 328i (M52TU) 2.8 Dolphin Convertible, Individual (95-00), 5-Series (E34) 520i (M50B20) 2.0 (89-96)</p>

ENGINE MOUNTING & RUBBER BUYERS GUIDE

299

	<p>AR7228 Engine Mounting - L/RHS BMW 5-Series (E34) 525i (M50B25) 2.5 (89-96)</p>	 <p>ID: 14, OD: 66, L: 64/76</p>	<p>AR7243 Front Upper Control Arm Bush - Inner Front BMW X3 (E83) 4X4 (M47N2) 2.0d Steptronic SUV Dies., (N46) 2.0i (04-10)</p>
	<p>AR7229 Engine Mounting - L/RHS BMW 5-Series (E34) 535i (M30B35) 3.5 6-Cyl. (95-96), M5 (M50B35) 3.5 6-Cyl. (92-94), 7-Series (E32) 730i (M30) 3.0, 735i (M30) 3.5 6-Cyl. (87-96)</p>	 <p>ID: 12, OD: 45, L: 57</p>	<p>AR7244 Rear Trailing Arm Bush BMW X3 (E83) 4X4 (M54, N52N) 2.5i SUV, LCI SUV, (M57N2) 3.0d SUV, (N52N) 3.0si (04-07)</p>
 <p>ID: 14, OD: 40, L: 50</p>	<p>AR7232 Rear Stabilizer Link, Trailing Arm Bush - Inner BMW 5-Series (E34) 520i (M50B20) 2.0, 525i (M50B25) 2.5, 530i (M60B30) 3.0 V8, 535i (M30B35) 3.5 6-Cyl., 540i (M60B40) 4.0 Edition V8 (89-96)</p>	 <p>ID: 14, OD: 66, L: 63/76</p>	<p>AR7245 Front Lower Control Arm Bush - Inner Front BMW X5 (E53) 4X4 (M57N) 3.0d Steptronic SUV Dies., (M54) 3.0i Steptronic SUV 6-Cyl. Pet., (M62) 4.4i Steptronic SUV Pet., (N62) 4.8iS Steptronic SUV V8 Pet. (01-10)</p>
 <p>ID: 23, OD: 51, L: 60</p>	<p>AR7234 Front Stabilizer Bar Bush BMW 5-Series (E34) 520i (M50B20) 2.0, 525i (M50B25) 2.5, M5 (M50B35) 3.5 6-Cyl., 530i (M60B30) 3.0 V8, 535i (M30B35) 3.5 6-Cyl., 540i (M60B40) 4.0 Edition V8 (89-96), 8-Series (E31) 850Ci (M70) 5.0 V12 (91-94), X3 (E83) 4X4 (M47N2) 2.0d Steptronic SUV Dies., (N46) 2.0i (06-10)</p>	 <p>ID: 29, OD: 62, W: 54.5</p>	<p>AR7250 Front Stabilizer Bar Bush BMW X3 (E83) 4X4 (M47N2) 2.0d Steptronic SUV Dies. (04-10), (M47N2) 2.0d Steptronic SUV Dies., (N46) 2.0i (06-10), X5 (E53) 4X4 (M57N) 3.0d Steptronic SUV Dies., (M54) 3.0i Steptronic SUV 6-Cyl. Pet., (M62) 4.4i Steptronic SUV Pet., (N62) 4.8iS Steptronic SUV V8 Pet. (01-10)</p>
 <p>ID: 13</p>	<p>AR7235 Rear Stabilizer Bar Bush BMW 3-Series (E90) 320d (N47) 2.0, 330d (N57) 3.0, 335i (N55) 3.0 (2007-), (E93) 330i (N52) 3.0, 335i (N54, N55) 3.0 (05-14)</p>		<p>AR7251 Front Strut Mounting BMW 5-Series (E34) 530i (M60B30) 3.0 V8, 535i (M30B35) 3.5 6-Cyl., 540i (M60B40) 4.0 Edition V8 (95-96), M5 (M50B35) 3.5 6-Cyl. (92-94)</p>
 <p>ID: 12.5, OD: 46, W: 52</p>	<p>AR7236 Front Lower Control Arm Bush - Inner Rear BMW 5-Series (E28) 520i (M20B20) 2.0, 525e (M30B27) 2.5, 528i (M30B28) 2.8, 535i (M30B35) 3.5, M535i (M90) 3.5 6-Cyl., M5 (MX30) 3.5 (85-89), (E34) 520i (M50B20) 2.0, 525i (M50B25) 2.5, 530i (M60B30) 3.0 V8, 535i (M30B35) 3.5 6-Cyl., 540i (M60B40) 4.0 Edition V8 (95-96), M5 (M50B35) 3.5 6-Cyl. (92-94), 7-Series (E32) 730i (M30, M60) 3.0, 735i (M30) 3.5 6-Cyl., 740i (M60, M62) 4.0, 750iL (M70) 5.0 V12 (87-96), 8-Series (E31) 850Ci (M70) 5.0 V12 (91-94), X3 (E83) 4X4 (M47N2) 2.0d Steptronic SUV Dies. (04-10), (M47N2) 2.0d Steptronic SUV Dies., (N46) 2.0i (06-10), X5 (E53) 4X4 (M57N) 3.0d Steptronic SUV Dies., (M54) 3.0i Steptronic SUV 6-Cyl. Pet., (M62) 4.4i Steptronic SUV Pet., (N62) 4.8iS Steptronic SUV V8 Pet. (01-10)</p>	 <p>ID: 16, OD: 153, H: 81</p>	<p>AR7254 Front Strut Mounting BMW X5 (E53) 4X4 (M57N) 3.0d Steptronic SUV Dies., (M54) 3.0i Steptronic SUV 6-Cyl. Pet., (M62) 4.4i Steptronic SUV Pet., (N62) 4.8iS Steptronic SUV V8 Pet. (01-10)</p>
 <p>ID: 18, L: 27, H: 32, W: 31</p>	<p>AR7238 Front Stabilizer Bar Bush - Inner Fiat Uno (156A2) 1.0 Cento, (160A3) 1.1 Fire, Mia, Rio, Tempo, Espresso P/Avan (90-05), (146C1) 1.4 Beat, Mia, Pacer, Pacer SX, Tempo SX, (146A) 1.4 Turbo (90-98)</p>	 <p>PCD: 78 6-HOLES</p>	<p>AR7255 Propshaft Coupling BMW X3 (E83) 4X4 (M54, N52N) 2.5i SUV, LCI SUV, (M57N2) 3.0d SUV, (N52N) 3.0si (04-07), (M47N2) 2.0d Steptronic SUV Dies. (04-10), (M47N2) 2.0d Steptronic SUV Dies., (N46) 2.0i (06-10), X5 (E53) 4X4 (M57N) 3.0d Steptronic SUV Dies., (M54) 3.0i Steptronic SUV 6-Cyl. Pet., (M62) 4.4i Steptronic SUV Pet., (N62) 4.8iS Steptronic SUV V8 Pet. (01-10)</p>
	<p>AR7239 Rear Carrier Bush - Centre BMW 7-Series (E32) 730i (M30, M60) 3.0, 735i (M30) 3.5 6-Cyl., 740i (M60, M62) 4.0, 750iL (M70) 5.0 V12 (87-96)</p>	 <p>ID: 30</p>	<p>AR7256 Centre Bearing Rubber - Rear BMW X5 (E53) 4X4 (M57N) 3.0d Steptronic SUV Dies., (M54) 3.0i Steptronic SUV 6-Cyl. Pet., (M62) 4.4i Steptronic SUV Pet., (N62) 4.8iS Steptronic SUV V8 Pet. (01-10)</p>
 <p>ID: 15, OD: 80, L: 85</p>	<p>AR7240 Rear Carrier Bush Bush - Front BMW 5-Series (E34) 520i (M50B20) 2.0, 525i (M50B25) 2.5, M5 (M50B35) 3.5 6-Cyl., 530i (M60B30) 3.0 V8, 535i (M30B35) 3.5 6-Cyl., 540i (M60B40) 4.0 Edition V8 (89-96), 7-Series (E32) 730i (M30, M60) 3.0, 735i (M30) 3.5 6-Cyl., 740i (M60, M62) 4.0, 750iL (M70) 5.0 V12 (87-96)</p>		<p>AR7257 Steering Coupling BMW 5-Series (E28) 520i (M20B20) 2.0, 525e (M30B27) 2.5, 528i (M30B28) 2.8, 535i (M30B35) 3.5, M535i (M90) 3.5 6-Cyl., M5 (MX30) 3.5 (85-89), (E34) 520i (M50B20) 2.0, 525i (M50B25) 2.5, M5 (M50B35) 3.5 6-Cyl., 530i (M60B30) 3.0 V8, 535i (M30B35) 3.5 6-Cyl., 540i (M60B40) 4.0 Edition V8 (89-96), 7-Series (E23) 728 (M30B28) 2.8, 728i (M30B28) 2.8, 730 (M30B28) 3.0, 733i (M30B32) 3.2, 735i (M30) 3.5, 745i (S38) 3.5 6-Cyl. (78-89), (E32) 730i (M30, M60) 3.0, 735i (M30) 3.5 6-Cyl., 740i (M60, M62) 4.0, 750iL (M70) 5.0 V12 (87-96), 8-Series (E31) 850Ci (M70) 5.0 V12 (91-94)</p>
 <p>ID: 12, OD: 61, L: 46</p>	<p>AR7241 Rear Axle Carrier Bush - Rear BMW 5-Series (E34) 520i (M50B20) 2.0, 525i (M50B25) 2.5, M5 (M50B35) 3.5 6-Cyl., 530i (M60B30) 3.0 V8, 535i (M30B35) 3.5 6-Cyl., 540i (M60B40) 4.0 Edition V8 (89-96), 7-Series (E32) 730i (M30, M60) 3.0, 735i (M30) 3.5 6-Cyl., 740i (M60, M62) 4.0, 750iL (M70) 5.0 V12 (87-96)</p>	 <p>PCD: 96 6-HOLES</p>	<p>AR7258 Propshaft Coupling BMW 3-Series (E36, E37) M-Coupe (S50B32) 3.2 6-Cyl. (93-05), (E36, E46) M3 (M54) 3.0, (S50B32/4) 3.2 Convertible (93-05)</p>
	<p>AR7259 Engine Mounting - L/RHS BMW 5-Series (E39) 523i (M52) 2.5, 525i (M54) 2.5, 528i (M52) 2.8, 530i (M54) 3.0 (96-04)</p>		<p>AR7259 Engine Mounting - L/RHS BMW 5-Series (E39) 523i (M52) 2.5, 525i (M54) 2.5, 528i (M52) 2.8, 530i (M54) 3.0 (96-04)</p>

ENGINE MOUNTING & RUBBER BUYERS GUIDE

	<p>AR7260 Engine Mounting - L/RHS</p> <p>BMW 5-Series (E28) 525e (M30B27) 2.5, 528i (M30B28) 2.8, 535i (M30B35) 3.5, M535i (M90) 3.5 6-Cyl., M5 (MX30) 3.5 (85-89)</p>	 <p>OD: 71, L: 60</p>	<p>AR7267 Rear Axle Carrier Bush - Rear Inner LHS</p> <p>BMW 1-Series (E81, E87) 116i (N45) 1.6, 118i (N46) 2.0, 120i (N46) 2.0, 130i (N52) 3.0 (04-15), (E88) 120i (N46) 2.0 (04-15), (E82) 120d (N47) 2.0 (2005-), (E87) 118d (M47) 2.0, 120d (M47) 2.0 (2005-), (E82, E88) 125i (N52, N54, N55) 3.0 Convertible, Coupe, 135i (N54, N55) 3.0 Turbo (08-14), 3-Series (E90) 320d (M47) 2.0, 320i (N46) 2.0, 323i (N52N) 2.5, 325i (N53) 2.5, 330i (N52, N53) 3.0, 330d (M57, N57) 3.0 (05-13), 320d (N47) 2.0, 330d (N57) 3.0, 335i (N55) 3.0 (2007-), (E92) 320i (N44) 2.0, 325i (N53) 2.5, 335i (N54, N55) 3.0 (02-15), (E93) 330i (N52) 3.0, 335i (N54, N55) 3.0 (05-14)</p>
 <p>ID: 17, OD: 85, L: 77</p>	<p>AR7261 Rear Carrier Bush - Rear Outer</p> <p>BMW 1-Series (E81, E87) 116i (N45) 1.6, 118i (N46) 2.0, 120i (N46) 2.0, 130i (N52) 3.0 (04-15), (E88) 120i (N46) 2.0 (04-15), (E82) 120d (N47) 2.0 (2005-), (E87) 118d (M47) 2.0, 120d (M47) 2.0 (2005-), (E82, E88) 125i (N52, N54, N55) 3.0 Convertible, Coupe, 135i (N54, N55) 3.0 Turbo (08-14), 3-Series (E90) 320d (M47) 2.0, 320i (N46) 2.0, 323i (N52N) 2.5, 325i (N53) 2.5, 330i (N52, N53) 3.0, 330d (M57, N57) 3.0 (05-13), 320d (N47) 2.0, 330d (N57) 3.0, 335i (N55) 3.0 (2007-), (E92) 320i (N44) 2.0, 325i (N53) 2.5, 335i (N54, N55) 3.0 (02-15), (E93) 330i (N52) 3.0, 335i (N54, N55) 3.0 (05-14)</p>	 <p>ID: 14, OD: 47, L: 55</p>	<p>AR7270 Rear Lower Control Arm Bush - Outer</p> <p>BMW 1-Series (E81, E87) 116i (N45) 1.6, 118i (N46) 2.0, 120i (N46) 2.0, 130i (N52) 3.0 (04-15), (E88) 120i (N46) 2.0 (04-15), (E82) 120d (N47) 2.0 (2005-), (E87) 118d (M47) 2.0, 120d (M47) 2.0 (2005-), 3-Series (E90) 320d (M47) 2.0, 320i (N46) 2.0, 323i (N52N) 2.5, 325i (N53) 2.5, 330i (N52, N53) 3.0, 330d (M57, N57) 3.0 (05-13), 320d (N47) 2.0, 330d (N57) 3.0, 335i (N55) 3.0 (2007-), (E92) 320i (N44) 2.0, 325i (N53) 2.5, 335i (N54, N55) 3.0 (02-15), (E93) 330i (N52) 3.0, 335i (N54, N55) 3.0 (05-14)</p>
	<p>AR7262 Rear Axle Push Rod - LHS</p> <p>BMW 1-Series (E81, E87) 116i (N45) 1.6, 118i (N46) 2.0, 120i (N46) 2.0, 130i (N52) 3.0 (04-15), (E88) 120i (N46) 2.0 (04-15), (E82) 120d (N47) 2.0 (2005-), (E87) 118d (M47) 2.0, 120d (M47) 2.0 (2005-), (E82, E88) 125i (N52, N54, N55) 3.0 Convertible, Coupe, 135i (N54, N55) 3.0 Turbo (08-14), 3-Series (E90) 320d (M47) 2.0, 320i (N46) 2.0, 323i (N52N) 2.5, 325i (N53) 2.5, 330i (N52, N53) 3.0, 330d (M57, N57) 3.0 (05-13), 320d (N47) 2.0, 330d (N57) 3.0, 335i (N55) 3.0 (2007-), (E92) 320i (N44) 2.0, 325i (N53) 2.5, 335i (N54, N55) 3.0 (02-15), (E93) 330i (N52) 3.0, 335i (N54, N55) 3.0 (05-14)</p>		<p>AR7271 Rear Axle Rear Track Strut - Rear</p> <p>BMW 1-Series (E81, E87) 116i (N45) 1.6, 118i (N46) 2.0, 120i (N46) 2.0, 130i (N52) 3.0 (04-15), (E88) 120i (N46) 2.0 (04-15), (E82) 120d (N47) 2.0 (2005-), (E87) 118d (M47) 2.0, 120d (M47) 2.0 (2005-), 3-Series (E90) 320d (M47) 2.0, 320i (N46) 2.0, 323i (N52N) 2.5, 325i (N53) 2.5, 330i (N52, N53) 3.0, 330d (M57, N57) 3.0 (05-13)</p>
	<p>AR7263 Rear Axle Push Rod - RHS</p> <p>BMW 1-Series (E81, E87) 116i (N45) 1.6, 118i (N46) 2.0, 120i (N46) 2.0, 130i (N52) 3.0 (04-15), (E88) 120i (N46) 2.0 (04-15), (E82) 120d (N47) 2.0 (2005-), (E87) 118d (M47) 2.0, 120d (M47) 2.0 (2005-), (E82, E88) 125i (N52, N54, N55) 3.0 Convertible, Coupe, 135i (N54, N55) 3.0 Turbo (08-14), 3-Series (E90) 320d (M47) 2.0, 320i (N46) 2.0, 323i (N52N) 2.5, 325i (N53) 2.5, 330i (N52, N53) 3.0, 330d (M57, N57) 3.0 (05-13), 320d (N47) 2.0, 330d (N57) 3.0, 335i (N55) 3.0 (2007-), (E92) 320i (N44) 2.0, 325i (N53) 2.5, 335i (N54, N55) 3.0 (02-15), (E93) 330i (N52) 3.0, 335i (N54, N55) 3.0 (05-14)</p>		<p>AR7272 Engine Mounting - LHS</p> <p>BMW 5-Series (E39) 540i (M62) 4.4, M5 (S38) 3.6 (98-04), (S62) 4.9 V8 (99-04), 7-Series (E38) 740i (M60) 4.0 V8, (M62) 4.4 V8, 750iL (M73) 5.4 V12 (96-03)</p>
	<p>AR7264 Rear Axle Carrier to Strut Link</p> <p>BMW 1-Series (E81, E87) 116i (N45) 1.6, 118i (N46) 2.0, 120i (N46) 2.0, 130i (N52) 3.0 (04-15), (E88) 120i (N46) 2.0 (04-15), (E82) 120d (N47) 2.0 (2005-), (E87) 118d (M47) 2.0, 120d (M47) 2.0 (2005-), (E82, E88) 125i (N52, N54, N55) 3.0 Convertible, Coupe, 135i (N54, N55) 3.0 Turbo (08-14), 3-Series (E90) 320d (M47) 2.0, 320i (N46) 2.0, 323i (N52N) 2.5, 325i (N53) 2.5, 330i (N52, N53) 3.0, 330d (M57, N57) 3.0 (05-13), 320d (N47) 2.0, 330d (N57) 3.0, 335i (N55) 3.0 (2007-), (E92) 320i (N44) 2.0, 325i (N53) 2.5, 335i (N54, N55) 3.0 (02-15), (E93) 330i (N52) 3.0, 335i (N54, N55) 3.0 (05-14)</p>		<p>AR7273 Engine Mounting - RHS</p> <p>BMW 5-Series (E39) 540i (M62) 4.4, M5 (S38) 3.6 (98-04), (S62) 4.9 V8 (99-04), 7-Series (E38) 740i (M60) 4.0 V8, (M62) 4.4 V8, 750iL (M73) 5.4 V12 (96-03)</p>
	<p>AR7265 Rear Lower Trailing Arm Bush - Inner & Outer L/RHS</p> <p>BMW 1-Series (E81, E87) 116i (N45) 1.6, 118i (N46) 2.0, 120i (N46) 2.0, 130i (N52) 3.0 (04-15), (E88) 120i (N46) 2.0 (04-15), (E82) 120d (N47) 2.0 (2005-), (E87) 118d (M47) 2.0, 120d (M47) 2.0 (2005-), (E82, E88) 125i (N52, N54, N55) 3.0 Convertible, Coupe, 135i (N54, N55) 3.0 Turbo (08-14), 3-Series (E90) 320d (M47) 2.0, 320i (N46) 2.0, 323i (N52N) 2.5, 325i (N53) 2.5, 330i (N52, N53) 3.0, 330d (M57, N57) 3.0 (05-13), 320d (N47) 2.0, 330d (N57) 3.0, 335i (N55) 3.0 (2007-), (E92) 320i (N44) 2.0, 325i (N53) 2.5, 335i (N54, N55) 3.0 (02-15), (E93) 330i (N52) 3.0, 335i (N54, N55) 3.0 (05-14)</p>		<p>AR7274 Rear Lower Control Arm Bush Assy. - Inner Rear</p> <p>BMW 1-Series (E81, E87) 116i (N45) 1.6, 118i (N46) 2.0, 120i (N46) 2.0, 130i (N52) 3.0 (04-15), (E88) 120i (N46) 2.0 (04-15), (E82) 120d (N47) 2.0 (2005-), (E87) 118d (M47) 2.0, 120d (M47) 2.0 (2005-), 3-Series (E90) 320d (M47) 2.0, 320i (N46) 2.0, 323i (N52N) 2.5, 325i (N53) 2.5, 330i (N52, N53) 3.0, 330d (M57, N57) 3.0 (05-13)</p>
 <p>ID: 12, OD: 54, L: 45/54</p>	<p>AR7266 Rear Axle Carrier Bush - Front, Centre L/RHS</p> <p>BMW 1-Series (E81, E87) 116i (N45) 1.6, 118i (N46) 2.0, 120i (N46) 2.0, 130i (N52) 3.0 (04-15), (E88) 120i (N46) 2.0 (04-15), (E82) 120d (N47) 2.0 (2005-), (E87) 118d (M47) 2.0, 120d (M47) 2.0 (2005-), (E82, E88) 125i (N52, N54, N55) 3.0 Convertible, Coupe, 135i (N54, N55) 3.0 Turbo (08-14), 3-Series (E90) 320d (M47) 2.0, 320i (N46) 2.0, 323i (N52N) 2.5, 325i (N53) 2.5, 330i (N52, N53) 3.0, 330d (M57, N57) 3.0 (05-13), 320d (N47) 2.0, 330d (N57) 3.0, 335i (N55) 3.0 (2007-), (E92) 320i (N44) 2.0, 325i (N53) 2.5, 335i (N54, N55) 3.0 (02-15), (E93) 330i (N52) 3.0, 335i (N54, N55) 3.0 (05-14)</p>	 <p>ID: 21, OD: 38, W: 34</p>	<p>AR7275 Rear Lower Control Arm Bush Assy. - Inner Front</p> <p>BMW 1-Series (E81, E87) 116i (N45) 1.6, 118i (N46) 2.0, 120i (N46) 2.0, 130i (N52) 3.0 (04-15), (E88) 120i (N46) 2.0 (04-15), (E82) 120d (N47) 2.0 (2005-), (E87) 118d (M47) 2.0, 120d (M47) 2.0 (2005-), 3-Series (E90) 320d (M47) 2.0, 320i (N46) 2.0 (05-13), 323i (N52N) 2.5, 325i (N53) 2.5, 330i (N52, N53) 3.0, 330d (M57, N57) 3.0 (05-13)</p> <p>AR7277 Rear Axle Carrier Bush</p> <p>BMW X5 (E53) 4X4 (M57N) 3.0d Steptronic SUV Dies., (M54) 3.0i Steptronic SUV 6-Cyl. Pet., (M62) 4.4i Steptronic SUV Pet., (N62) 4.8iS Steptronic SUV V8 Pet. (01-10)</p> <p>AR7278 Rear Axle Carrier Bush - Front, Centre</p> <p>BMW X5 (E53) 4X4 (M57N) 3.0d Steptronic SUV Dies., (M54) 3.0i Steptronic SUV 6-Cyl. Pet., (M62) 4.4i Steptronic SUV Pet., (N62) 4.8iS Steptronic SUV V8 Pet. (01-10)</p> <p>AR7279 Rear Axle Carrier Bush - Rear LHS</p> <p>BMW X5 (E53) 4X4 (M57N) 3.0d Steptronic SUV Dies., (M54) 3.0i Steptronic SUV 6-Cyl. Pet., (M62) 4.4i Steptronic SUV Pet., (N62) 4.8iS Steptronic SUV V8 Pet. (01-10)</p>

ENGINE MOUNTING & RUBBER BUYERS GUIDE

301

 ID: 14	AR7280 Front Strut Mounting - L/RHS BMW Mini Cooper (R50) Cooper (W10B16A) 1.6, (R52) Cooper (W10B16A, W11B16A) 1.6 Convertible, (R53) Cooper S (W11B16A) 1.6 (02-09)
 ID: 19, OD: 82.5, L: 92	AR7281 Rear Axle Carrier Bush - Front L/RHS BMW 5-Series (E39) 523i (M52) 2.5, 525i (M54) 2.5, 528i (M52) 2.8, 530d (M57) 3.0 Dies., 530i (M54) 3.0 (96-04), 540i (M62) 4.4, M5 (S38) 3.6 (98-04), (S62) 4.9 V8 (99-04)
 OD: 53	AR7282 Rear Axle Carrier Bush - Front Centre BMW 5-Series (E39) 523i (M52) 2.5, 525i (M54) 2.5, 528i (M52) 2.8, 530d (M57) 3.0 Dies., 530i (M54) 3.0 (96-04), 540i (M62) 4.4, M5 (S38) 3.6 (98-04), (S62) 4.9 V8 (99-04), 7-Series (E38) 740i (M60) 4.0 V8, (M62) 4.4 V8, 750iL (M73) 5.4 V12 (96-03)
 ID: 30	AR7283 Centre Bearing Rubber BMW 5-Series (E28) 520i (M20B20) 2.0, 525e (M30B27) 2.5, 528i (M30B28) 2.8, 535i (M30B35) 3.5, M535i (M90) 3.5 6-Cyl., M5 (MX30) 3.5 (85-89)
 ID: 12, OD: 58.5, L: 60/68	AR7289 Front Upper Control Arm Bush - Inner BMW 5-Series (E39) 523i (M52) 2.5, 525i (M54) 2.5, 528i (M52) 2.8, 530d (M57) 3.0 Dies., 530i (M54) 3.0 (96-04)
	AR7291 Transmission Mounting BMW 7-Series (E23) 728 (M30B28) 2.8, 728i (M30B28) 2.8, 735i (M30) 3.5, 745i (S38) 3.5 6-Cyl. (78-89)
	AR7292 Transmission Mounting BMW 7-Series (E23) 730 (M30B28) 3.0, 733i (M30B32) 3.2 (78-89)
	AR7295 Transmission Mounting BMW 7-Series (E23) 728 (M30B28) 2.8, 728i (M30B28) 2.8 (83-87)
	AR7296 Front Stabilizer Bar Bush BMW 7-Series (E23) 728 (M30B28) 2.8, 728i (M30B28) 2.8, 730 (M30B28) 3.0, 733i (M30B32) 3.2, 735i (M30) 3.5, 745i (S38) 3.5 6-Cyl. (78-89), (E32) 730i (M30, M60) 3.0, 735i (M30) 3.5 6-Cyl., 740i (M60, M62) 4.0, 750iL (M70) 5.0 V12 (87-96), 8-Series (E31) 850Ci (M70) 5.0 V12 (91-94)
	AR7298 Front Lower Control Arm Bush - Inner BMW 7-Series (E23) 728 (M30B28) 2.8, 728i (M30B28) 2.8, 730 (M30B28) 3.0, 733i (M30B32) 3.2, 735i (M30) 3.5, 745i (S38) 3.5 6-Cyl. (78-89)
	AR7299 Transmission Mounting Volvo S70 (D5252T) 2.5T R Sedan, Estate 5-Spd. Man., 4-Spd. Auto. (97-04)
	AR7300 Front Upper Control Arm Bush - Inner BMW 7-Series (E23) 728 (M30B28) 2.8, 728i (M30B28) 2.8, 730 (M30B28) 3.0, 733i (M30B32) 3.2, 735i (M30) 3.5, 745i (S38) 3.5 6-Cyl. (78-89)

 NO PICTURE AVAILABLE AT TIME OF PRINT	AR7303 Front Stabilizer Link Grommet BMW 7-Series (E23) 728 (M30B28) 2.8, 728i (M30B28) 2.8, 730 (M30B28) 3.0, 733i (M30B32) 3.2, 735i (M30) 3.5, 745i (S38) 3.5 6-Cyl. (78-89)
	AR7304 Engine Mounting - LHS BMW 5-Series (E39) 530d (M57) 3.0 Dies. (96-04)
	AR7305 Engine Mounting - RHS BMW 5-Series (E39) 530d (M57) 3.0 Dies. (96-04)
 NO PICTURE AVAILABLE AT TIME OF PRINT	AR7306 Front Strut Mounting BMW 7-Series (E23) 728 (M30B28) 2.8, 728i (M30B28) 2.8, 730 (M30B28) 3.0, 733i (M30B32) 3.2, 735i (M30) 3.5, 745i (S38) 3.5 6-Cyl. (78-89)
 OD: 69, L: 42/58	AR7308 Rear Axle Carrier Bush - Rear Centre BMW 5-Series (E39) 523i (M52) 2.5, 525i (M54) 2.5, 528i (M52) 2.8, 530d (M57) 3.0 Dies., 530i (M54) 3.0 (96-04), 540i (M62) 4.4, M5 (S38) 3.6 (98-04), (S62) 4.9 V8 (99-04)
	AR7309 Engine Mounting - Front Centre Volvo S60 (B5204T5) 2.0T, (B5234T3) 2.3 T5, (B5244S) 2.4, (D5244T) 2.4 D5, (D5244T4) 2.4 D5, (B5244T5) 2.4 T5, (B5254T2) 2.5T (03-09), S60 4X4 (B5244T4) 2.5 R (03-09), XC70 4X4 (B5244T3/4) 2.4 D5 Estate, SUV, Geartronic, (B5254T2) 2.5 T5 Estate, SUV, Geartronic (99-07), (D5244T5/10/14/16) 2.4 D5 Estate, SUV, Geartronic, (B5254T2) 2.5 T5 Estate, SUV, Geartronic, (B6324S) 3.2 Estate, SUV, Geartronic (2007-), XC90 (D5244T4) 2.4i D5 5/7-Seater SUV Geartronic, R-Design, Exec., (B5254T2) 2.5 T5 5/7-Seater SUV Geartronic, (B6294T) 2.9 T6 5/7-Seater SUV, (B6324S) 3.2 5/7-Seater SUV Geartronic, R-Design (2003-)
	AR7310 Engine Mounting - RHS Volvo S60 (B5204T5) 2.0T, (B5234T3) 2.3 T5, (B5244S) 2.4, (D5244T) 2.4 D5, (D5244T4) 2.4 D5, (B5244T5) 2.4 T5, (B5254T2) 2.5T (03-09), S60 4X4 (B5244T4) 2.5 R (03-09), S70 (B5254S) 2.4 Estate, (D5252T) 2.5T R Sedan, Estate 5-Spd. Man., 4-Spd. Auto. (97-04), V70 (B5234T4) 2.3 T5 Sedan, Estate (97-04), XC70 4X4 (B5244T3/4) 2.4 D5 Estate, SUV, Geartronic, (B5254T2) 2.5 T5 Estate, SUV, Geartronic (99-07), (D5244T5/10/14/16) 2.4 D5 Estate, SUV, Geartronic, (B5254T2) 2.5 T5 Estate, SUV, Geartronic, (B6324S) 3.2 Estate, SUV, Geartronic (2007-), XC90 (D5244T4) 2.4i D5 5/7-Seater SUV Geartronic, R-Design, Exec., (B5254T2) 2.5 T5 5/7-Seater SUV Geartronic (2003-)
	AR7311 Engine Mounting - RHS Daewoo Nubira I (616L, A16DM) 1.6 SX (97-03), Nubira II 1.6 SX (97-03)
	AR7312 Engine Mounting - RHS Daewoo Nubira I (C20SED, X20S) 2.0 CDX (97-03), Nubira II 2.0 CDX (97-03)
	AR7314 Engine Mounting - Rear Daewoo Nubira I (616L, A16DM) 1.6 SX, (C20SED, X20S) 2.0 CDX (97-03), Nubira II 1.6 SX, 2.0 CDX (97-03)
	AR7315 Front Strut Mounting Daewoo Nubira I (616L, A16DM) 1.6 SX, (C20SED, X20S) 2.0 CDX (97-03), Nubira II 1.6 SX, 2.0 CDX (97-03)







ENGINE MOUNTING & RUBBER

BUYERS GUIDE

	AR7318 Front Stabilizer Bar Bush Daewoo Nubira I (616L, A16DM) 1.6 SX, (C20SED, X20S) 2.0 CDX (97-03), Nubira II 1.6 SX, 2.0 CDX (97-03)		AR7332 Engine Mounting - Rear RHS (Insert Only) Citroen Berlingo (TU3JP) 1.4i Multispace, Multispace Executive MPV, P/van (03-10), Xsara (TU5JP4) 1.6 SX (01-06); Peugeot 406 (XU10J2TE) 2.0 ST, ST Comfort, ST Estate, (8RHY/Z, DW10TD/ATED) 2.0 HDi, Comfort, Exec., (ES9J4S) 3.0 V6 Coupe', ST, Executive, SV Auto. (96-05)
	AR7320 Engine Mounting - Rear (Support Yoke Bush) Peugeot 306 (TU5JP) 1.6 XT S/W (99-02), Expert 2.0 HDi (2008-)		AR7333 Engine Mounting - RHS Citroen Berlingo (TU3JP) 1.4i Multispace, Multispace Executive MPV, P/van (03-10); Peugeot 206 (TU3JP) 1.4 Popart, X-Line, (TU5JP4) 1.6 CC, SW XS, XT, XT Premium 2A/-C (01-08)
	AR7321 Engine Mounting - Rear Transmission Mounting Volvo S60 (B5204T5) 2.0T, (B5234T3) 2.3 T5, (B5244S) 2.4, (D5244T) 2.4 D5, (D5244T4) 2.4 D5, (B5244T5) 2.4 T5, (B5254T2) 2.5T (03-09), S60 4X4 (B5244T4) 2.5 R (03-09), S70 (B5254S) 2.4 Estate (97-04), V70 (B5234T4) 2.3 T5 Sedan, Estate (97-04), XC70 4X4 (B5244T3/4) 2.4 D5 Estate, SUV, Geartronic, (B5254T2) 2.5 T5 Estate, SUV, Geartronic (99-07), (D5244T5/10/14/16) 2.4 D5 Estate, SUV, Geartronic, (B5254T2) 2.5 T5 Estate, SUV, Geartronic, (B6324S) 3.2 Estate, SUV, Geartronic (2007-), XC90 (B5254T2) 2.5 T5 5/7-Seater SUV Geartronic (2003-)		AR7334 Engine Mounting - LHS Citroen Berlingo (TU3JP) 1.4i Multispace, Multispace Executive MPV, P/van (03-10), (TU5JP4B) 1.6, (DV6TED4BU, DV6AUTED4) 1.6 HDi 90 16V (2011-), C4 (DV6TED4) 1.6 HDi (05-10); Peugeot 206 (TU3JP) 1.4 Popart, X-Line, (TU5JP4) 1.6 CC, SW XS, XT, XT Premium 2A/-C (01-08), (EW10J4) 2.0 CC, GTi, GTi 180 Pet., (DW10TD) XT HDi Dies. (01-08), 308 (EP6-DT/CDTX, DV6TED4) 1.6i, VTI, THP X-Line, XS, XT, CC, SW, Comfort, Premium, GTi (2008-), 3008 (EP6-DT) 1.6i Exec., VTI Comfort, THP Premium (2010-), Partner 1.6 HDi (08-18)
	AR7322 Diff. Mounting BMW 7-Series (E23) 728 (M30B28) 2.8, 728i (M30B28) 2.8, 730 (M30B28) 3.0, 733i (M30B32) 3.2, 735i (M30) 3.5, 745i (S38) 3.5 6-Cyl. (78-89)		AR7335 Front Stabilizer Bar Bush Daewoo Cielo 1.5 GL, GLX, GTX, 150i, L (96-99), Espero (C18LE) 1.8 CD, (C20LE) 2.0 CD (96-98)
	AR7324 Engine Mounting - LHS Daewoo Nubira I (616L, A16DM) 1.6 SX Man., (C20SED, X20S) 2.0 CDX Man. (97-03), Nubira II 1.6 SX, 2.0 CDX Man. (97-03)		AR7336 Front Stabilizer Link Grommet Daewoo Espero (C18LE) 1.8 CD, (C20LE) 2.0 CD (96-98)
	AR7325 Engine Mounting - Rear Daewoo Espero (C18LE) 1.8 CD Auto., (C20LE) 2.0 CD Auto. (96-98)		AR7337 Engine Mounting - Rear RHS (Insert) (Bush to fit Engine Bracket) Citroen Berlingo (XUD9A) 1.9D P/van Dies. (03-10); Peugeot 206 (EW10J4) 2.0 CC, GTi, GTi 180 Pet., (DW10TD) XT HDi Dies. (01-08), 306 1.8 XT, (OHC-XU10J2/K) 2.0 XSi, Cabrio (99-02), 307 (TU5JP4) 1.6 Estate, XR, XS HDi, XT, (EW10J4) 2.0 CC 100, CC, 130, XS, Man., (DW10TD) XS HDi (01-07), 406 (XU10J2TE) 2.0 ST, ST Comfort, ST Estate, (8RHY/Z, DW10TD/ATED) 2.0 HDi, Comfort, Exec., (ES9J4S) 3.0 V6 Coupe', ST, Executive, SV Auto. (96-05), Expert 2.0 HDi (2008-), Partner 1.9D P/van, 2.0 Grand Raid HDi Dies. (03-10)
	AR7326 Engine Mounting - RHS Chevrolet Spark (M150) (F8CV) 0.8 L, LS, (B10S1) 1.0 LS, LT (03-05); Daewoo Matiz (F8CV) 800cc S, SE (99-03)		AR7338 Front Lower Control Arm Bush - Inner Front Citroen C2 (TU3JP) 1.4i VTR, (DV4TD) 1.4 HDi, (TU5J4S) 1.6 VTS (02-10); Peugeot 1007 (TU5JP4) 1.6 3 Dr. Hatch (05-08)
	AR7327 Transmission Mounting Chevrolet Spark (M150) (B10S1) 1.0 LS, LT (03-05); Daewoo Matiz (F8CV) 800cc S, SE (99-03)		AR7339 Front Lower Control Arm Bush - Outer Rear Citroen C2 (TU3JP) 1.4i VTR, (DV4TD) 1.4 HDi, (TU5J4S) 1.6 VTS (02-10); Peugeot 1007 (TU5JP4) 1.6 3 Dr. Hatch (05-08)
	AR7328 Engine Mounting - LHS Daewoo Espero (C18LE) 1.8 CD Auto., (C20LE) 2.0 CD Auto. (96-98)		AR7341 Engine Mounting - LHS Daewoo Nubira I (616L, A16DM) 1.6 SX Auto., (C20SED, X20S) 2.0 CDX Auto. (97-03), Nubira II 1.6 SX Auto., 2.0 CDX Auto. (97-03)
	AR7329 Engine Mounting - Front Spark (M150) (F8CV) 0.8 L, LS, (B10S1) 1.0 LS, LT (03-05); Daewoo Matiz (F8CV) 800cc S, SE (99-03)		AR7343 Engine Mounting - RHS Citroen C5 (EW10J4S) 2.0 SX (01-05); Fiat Ulysse (RFU, RFV) 2.0 MPV (99-01)
	AR7330 Engine Mounting - RHS Daewoo Espero (C18LE) 1.8 CD Auto., (C20LE) 2.0 CD Auto. (96-98)		AR7331 Engine Mounting - RHS Buffer Bracket Citroen Berlingo (TU3JP) 1.4i Multispace, Multispace Executive MPV, P/van, (XUD9A) 1.9D P/van Dies. (03-10); Peugeot 306 (TU5JP) 1.6 XT S/W, 1.8 XT, (XU10J2/K) 2.0 XSi, Cabrio OHC (99-02), Partner 1.9D P/van, 2.0 Grand Raid HDi Dies. (03-09)
	AR7331 Engine Mounting - RHS Buffer Bracket Citroen Berlingo (TU3JP) 1.4i Multispace, Multispace Executive MPV, P/van, (XUD9A) 1.9D P/van Dies. (03-10); Peugeot 306 (TU5JP) 1.6 XT S/W, 1.8 XT, (XU10J2/K) 2.0 XSi, Cabrio OHC (99-02), Partner 1.9D P/van, 2.0 Grand Raid HDi Dies. (03-09)		

ENGINE MOUNTING & RUBBER BUYERS GUIDE

 ID: 24	AR7347 Front Stabilizer Bar Bush BMW Mini Cooper (R50) Cooper (W10B16A) 1.6, (R52) Cooper (W10B16A, W11B16A) 1.6 Convertible, (R53) Cooper S (W11B16A) 1.6 (02-09)
	AR7349 Engine Mounting - LHS Volvo S70 (B5254S) 2.4 Estate, (D5252T) 2.5T R Sedan, Estate 5-Spd. Man., 4-Spd. Auto. (97-04), V70 (B5234T4) 2.3 T5 Sedan, Estate (97-04)
	AR7352 Exhaust Hanger - Front Daewoo Lanos (C14L) 1.3i S SOHC, (616L, Y6) 1.6 SX DOHC (97-03), Lanos II 1.4 S SOHC, 1.6 SX DOHC (97-03)
	AR7365 Transmission Mounting Volvo XC90 (B6294T) 2.9 T6 5/7-Seater SUV, (B6324S) 3.2 5/7-Seater SUV Geartronic, R-Design (2003-)
	AR7377 Engine Mounting - Rear Lower Volvo S70 (B5254S) 2.4 Estate, (D5252T) 2.5T R Sedan, Estate 5-Spd. Man., 4-Spd. Auto. (97-04), V70 (B5234T4) 2.3 T5 Sedan, Estate (97-04)
	AR7379 Rear Radius Arm Bush Volvo S40 (B4204T2/3) 2.0T Sedan 4-Spd. Auto., 5-Spd. Man. (97-04), V40 (B4204S, B4204T2) 2.0T Estate, 5-Spd. Man., 4-Spd. Auto. (97-04)
	AR7380 Steering Rack Mounting Volkswagen Golf II 1.3 CL 4-Spd. Man., 1.6 CSL 5-Spd. Man., 1.8 GTS 16V, CSX, GTI 8V, 16V, 5-Spd. Man., 3-Spd. Auto., 2.0 GTI 8V, Exec. 16V 5-Spd. Man. (84-92) - P/S , Golf III 1.6 GS 5-Spd. Man., 1.8 GSX, GTS 5-Spd. Man., 3-Spd. Auto., 2.0 GTI, 8V GTI Exec. 5-Spd. Man., 2.8 VR6, VR6 Exec. V6 5-Spd. Man., 4-Spd. Auto. (92-99) - P/S , Golf IV 1.6i Comfortline, Std., Tiptronic, 1.8 GTI HighLine, 1.8T GTI, 1.9 TDI HighLine, Comfortline, DSG, 2.0i Cabrio, HighLine (99-04), Jetta II 1.6 CSL 5-Spd. Man., 1.8 CLi, CLi Exec., Executive, CLX, CSX 5-Spd. Man., 3-Spd. Auto., 2.0 L 16V 5-Spd. Man. (85-92) - P/S , Jetta III 1.6 CSL 5-Spd. Man., 1.8 CLX, CSX 5-Spd. Man., 3-Spd. Auto., 2.0 CLi, CLi Exec. 5-Spd. Man., 2.8 VR6 Exec. V6 5-Spd. Man., 4-Spd. Auto. (92-99) - P/S , Jetta IV 1.6i Comfortline Std. 5-Spd. Man., 4-Spd. Auto., 1.9 TDI HighLine 5-Spd. Man., 2.0i HighLine 5-Spd. Man., 2.3 V5 5-Spd. Man. (99-05), Polo (6N) 1.4i Classic, Playa, 1.6i Classic Lux, Classic, Playa, 1.8i Classic Lux, Playa 5-Spd. Man. (96-03) - P/S
 ID: 25.5, OD: 72/87, L: 43/57	AR7382 Rear Subframe Bush - Front Volvo S70 (B5254S) 2.4 Estate, (D5252T) 2.5T R Sedan, Estate 5-Spd. Man., 4-Spd. Auto. (97-04), V70 (B5234T4) 2.3 T5 Sedan, Estate (97-04), XC70 4X4 (D5244T5/10/14/16) 2.4 D5 Estate, SUV, Geartronic, (B5254T2) 2.5 T5 Estate, SUV, Geartronic, (B6324S) 3.2 Estate, SUV, Geartronic (2007-), XC90 (D5244T4) 2.4i D5 5/7-Seater SUV Geartronic, R-Design, Exec., (B5254T2) 2.5 T5 5/7-Seater SUV Geartronic, (B6294T) 2.9 T6 5/7-Seater SUV, (B6324S) 3.2 5/7-Seater SUV Geartronic, R-Design, (B8444S) 4.4 7-Seater SUV, Geartronic, Executive, R-Design (2003-)
 ID: 25.5, OD: 72/87, L: 45/56	AR7383 Front & Rear Subframe Bush - Rear RHS Volvo S70 (B5254S) 2.4 Estate, (D5252T) 2.5T R Sedan, Estate 5-Spd. Man., 4-Spd. Auto. (97-04), V70 (B5234T4) 2.3 T5 Sedan, Estate (97-04), XC70 4X4 (D5244T5/10/14/16) 2.4 D5 Estate, SUV, Geartronic, (B5254T2) 2.5 T5 Estate, SUV, Geartronic, (B6324S) 3.2 Estate, SUV, Geartronic (2007-), XC90 (D5244T4) 2.4i D5 5/7-Seater SUV Geartronic, R-Design, Exec., (B5254T2) 2.5 T5 5/7-Seater SUV Geartronic, (B6294T) 2.9 T6 5/7-Seater SUV, (B6324S) 3.2 5/7-Seater SUV Geartronic, R-Design, (B8444S) 4.4 7-Seater SUV, Geartronic, Executive, R-Design (2003-)

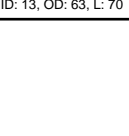
	AR7384 Front & Rear Subframe Bush - Rear LHS Volvo S70 (B5254S) 2.4 Estate, (D5252T) 2.5T R Sedan, Estate 5-Spd. Man., 4-Spd. Auto. (97-04), V70 (B5234T4) 2.3 T5 Sedan, Estate (97-04), XC70 4X4 (D5244T5/10/14/16) 2.4 D5 Estate, SUV, Geartronic, (B5254T2) 2.5 T5 Estate, SUV, Geartronic, (B6324S) 3.2 Estate, SUV, Geartronic (2007-), XC90 (D5244T4) 2.4i D5 5/7-Seater SUV Geartronic, R-Design, Exec., (B5254T2) 2.5 T5 5/7-Seater SUV Geartronic, (B6294T) 2.9 T6 5/7-Seater SUV, (B6324S) 3.2 5/7-Seater SUV Geartronic, R-Design, (B8444S) 4.4 7-Seater SUV, Geartronic, Executive, R-Design (2003-)
 ID: 26, L: 35, H: 46, W: 48	AR7385 Steering Rack Mounting - LHS Fiat Uno (156A2) 1.0 Cento, (160A3) 1.1 Fire, Mia, Rio, Tempo, Espresso P/van (90-05), (146C1) 1.4 Beat, Mia, Pacer, Pacer SX, Tempo SX, (146A) 1.4 Turbo (90-98)
 L: 35, H: 49, W: 58	AR7386 Steering Rack Mounting - RHS Fiat Uno (156A2) 1.0 Cento, (160A3) 1.1 Fire, Mia, Rio, Tempo, Espresso P/van (90-05), (146C1) 1.4 Beat, Mia, Pacer, Pacer SX, Tempo SX, (146A) 1.4 Turbo (90-98)
	AR7389 X-Member Bush Fiat Uno (156A2) 1.0 Cento, (160A3) 1.1 Fire, Mia, Rio, Tempo, Espresso P/van (90-05), (146C1) 1.4 Beat, Mia, Pacer, Pacer SX, Tempo SX, (146A) 1.4 Turbo (90-98)
 ID: 12, OD: 65, H: 39	AR7390 Front Strut Mounting Fiat Uno (156A2) 1.0 Cento, (160A3) 1.1 Fire, Mia, Rio, Tempo, Espresso P/van (90-05), (146C1) 1.4 Beat, Mia, Pacer, Pacer SX, Tempo SX, (146A) 1.4 Turbo (90-98)
	AR7393 Rear Strut Mounting Fiat Uno (146A) 1.4 Turbo (90-98)
	AR7395 Engine Mounting - Front Ford Escort MKVI FWD (CVH-PTE) 1.4i Hatchback, Sedan (95-00)
	AR7396 Engine Mounting - Rear Ford Escort MKVI FWD (CVH-PTE) 1.4i Hatchback, Sedan, (Zetec) 1.6i GL, GLE Hatchback, Sedan, (Zetec) 1.8i GLi Pet., (Endura DE) 1.8 TD Dies. (95-00)
	AR7398 Engine Mounting - Front Ford Escort MKVI FWD (Zetec) 1.6i GL, GLE Hatchback, Sedan, (Zetec) 1.8i GLi Pet., (Endura DE) 1.8 TD Dies. (95-00)
	AR7399 Transmission Mounting Ford Escort MKVI FWD (Endura DE) 1.8 TD Dies. (95-00)
	AR7400 Transmission Mounting Ford Escort MKVI FWD (CVH-PTE) 1.4i Hatchback, Sedan, (Zetec) 1.6i GL, GLE Hatchback, Sedan, (Zetec) 1.8i GLi Pet. (95-00)
 ID: 13, OD: 63, L: 70	AR7403 Rear Axle Beam Bush - Front Ford Escort MKVI FWD (CVH-PTE) 1.4i Hatchback, Sedan, (Zetec) 1.6i GL, GLE Hatchback, Sedan, (Zetec) 1.8i GLi Pet., (Endura DE) 1.8 TD Dies. (95-00)









ENGINE MOUNTING & RUBBER BUYERS GUIDE

	AR7407 Transmission Mounting Ford Mondeo (Endura D18Ti) 1.8 TDi LX, (Zetec ZH18Efi) 1.8i LX B-P Pet., (Zetec ZH20Efi, ZH20HE) 2.0i Aspen, CLX, B-P, (Duratec M5) 2.5i V6 Si (97-01)
	AR7408 Front Strut Mounting Ford Escort MKVI FWD (CVH-PTE) 1.4i Hatchback, Sedan, (Zetec) 1.6i GL, GLE Hatchback, Sedan, (Zetec) 1.8i GLi Pet., (Endura DE) 1.8 TD Dies. (95-00)
	AR7410 Front Lower Control Arm Bush - Inner Front Ford Escort MKVI FWD (CVH-PTE) 1.4i Hatchback, Sedan, (Zetec) 1.6i GL, GLE Hatchback, Sedan, (Zetec) 1.8i GLi Pet., (Endura DE) 1.8 TD Dies. (95-00), Mondeo (Endura D18Ti) 1.8 TDi LX, (Zetec ZH18Efi) 1.8i LX B-P Zetec Pet., (ZH20Efi, ZH20HE) 2.0i Aspen, CLX, B-P, (Duratec M5) 2.5i V6 Si (97-01)
	AR7411 Front Lower Control Arm Bush - Inner Front Ford Bantam 'Boet' (CLTA) 1.3i XL, XLS SWB P/up Pet., (Zetec) 1.6i XLE, XLT, SWB P/up Pet., 1.8di XL SWB P/up Dies. (02-12), Fiesta I (Endura EM5) 1.3i Flair, Flite, Fun Play, (CVH, PTE) 1.4i Flair, Flite, Fun, (Rocam) 1.6i Flair, Forte, RSi, Sport (97-04), Ikon (CLTA) 1.3i LX, Low, (CLTA) 1.6i LX, CLX, High, Low (01-06); Mazda 121 Soho (Endura - EM5) 1.3, i Hatch, (CVH/PTE) 1.4, i Hatch (97-99)
	AR7412 Engine Mounting - LHS Ford Falcon 4.0 Fairmont Futura S/W, 6-Cyl. MPI, XR6 (96-03)
	AR7413 Engine Mounting - RHS Ford Falcon 4.0 Fairmont Futura S/W, 6-Cyl. MPI, XR6 (96-03)
	AR7414 Transmission Mounting Ford Falcon 4.0 Fairmont Futura S/W, 6-Cyl. MPI, XR6 (96-03)
	AR7415 Front Stabilizer Bar Bush Ford Falcon 4.0 Fairmont Futura S/W, 6-Cyl. MPI, XR6 (96-03)
	AR7416 Front Upper Control Arm Bush - Outer Ford Falcon 4.0 Fairmont Futura S/W, 6-Cyl. MPI, XR6 (96-03)
	AR7417 Front Lower Control Arm Bush - Inner Ford Falcon 4.0 Fairmont Futura S/W, 6-Cyl. MPI, XR6 (96-03)
	AR7419 Front Upper Control Arm Bush - Inner Ford Falcon 4.0 Fairmont Futura S/W, 6-Cyl. MPI, XR6 (96-03)
	AR7420 Front Upper Control Arm Bush - Inner Ford Falcon 4.0 XR6 (96-03)

	AR7421 Front Lower Control Arm Bush - Outer Ford Mondeo (Endura D18Ti) 1.8 TDi LX, (Zetec ZH18Efi) 1.8i LX B-P Pet., (Zetec ZH20Efi, ZH20HE) 2.0i Aspen, CLX, B-P, (Duratec M5) 2.5i V6 Si (99-01)
	AR7423 Front Lower Control Arm Bush - Inner Ford Falcon 4.0 Fairmont Futura S/W, 6-Cyl. MPI, XR6 (96-98)
	AR7424 Front Lower Control Arm Bush - Inner Ford Falcon 4.0 Fairmont Futura S/W, 6-Cyl. MPI, XR6 (98-03)
	AR7428 Rear Stabilizer Bar Bush BMW Mini Cooper (R55) (N12B16A, N16B16A) 1.6 Clubman, (R56) (N12B16A, N16B16A) 1.6 Hatch, (R57) (N12B16A, N16B16A) 1.6 Convertible, (R58) (N16B16A) 1.6 Coupe, (R59) (N16B16A) 1.6 Roadster, (R60) (N16B16A) 1.6 Countryman, (R61) (N16B16A) 1.6 Paceman (2007-), Cooper S (R55) (N14B16A, N18B16A) 1.6 Clubman, (R56) (N14B16A, N18B16A) 1.6 Hatch, (R57) (N14B16A, N18B16A) 1.6 Convertible, (R58) (N18B16A) 1.6 Coupe, (R59) (N18B16A) 1.6 Roadster, (R60) (N18B16A) 1.6 Countryman, (R61) (N18B16A) 1.6 Paceman (2007-), Cooper S 4X4 (R60) (N18B16A) 1.6 Countryman, (R61) (N18B16A) 1.6 Paceman (2010-), Cooper John (R55) (N14B16C) 1.6 Clubman, (R56) (N14B16C, N18B16C) 1.6 Hatch, (R57) (N14B16C, N18B16C) 1.6 Convertible, (R58) (N14B16C, N18B16C) 1.6 Coupe, (R59) (N14B16C, N18B16C) 1.6 Roadster (2007-), Countryman JCW (R56) (N18B16C) 1.6 Hatch, (R60) (N18B16A) 1.6 Countryman (2007-), One (R56) (N16B16A) 1.6 Hatch, (R57) (N16B16A) 1.6 Convertible (2007-)
	AR7429 Front Lower Control Arm Bush - Inner Ford KA (A9A/B) 1.3i Low, LX, Ambiente, Trend, Collection (05-09)
	AR7430 Front Strut Mounting Ford Falcon 4.0 Fairmont Futura S/W, 6-Cyl. MPI, XR6 (96-03)
	AR7433 Front Lower Control Arm Bush - Inner Front Honda Ballade (SR4) (D15B3) 150 Encore, Luxline, Spreeline, (D16A7) 160E, i, Luxline, Spreeline, (B18B3) 180E, i Luxline, Spreeline (92-98)
	AR7434 Front Lower Control Arm Bush - Outer Honda Ballade (SH4) (D15B3) 150 16V SOHC, (D16A9) 160i 16V SOHC, DOHC (89-92), Ballade (SR4) (D15B3) 150 Encore, Luxline, Spreeline, (D16A7) 160E, i, Luxline, Spreeline, (B18B3) 180E, i Luxline, Spreeline (92-98)
	AR7435 Front Stabilizer Bar Bush Honda Ballade (SR4) (D15B3) 150 Encore, Luxline, Spreeline, (D16A7) 160E, i, Luxline, Spreeline, (B18B3) 180E, i Luxline, Spreeline (92-98)
	AR7436 Front Lower Control Arm Bush - Outer Rear Ford Escort MKVI FWD (CVH-PTE) 1.4i Hatchback, Sedan, (Zetec) 1.6i GL, GLE Hatchback, Sedan, (Zetec) 1.8i GLi Pet., (Endura DE) 1.8 TD Dies. (95-00), KA (A9A/B) 1.3i Low, LX, Ambiente, Trend, Collection (05-09)

ENGINE MOUNTING & RUBBER BUYERS GUIDE

305

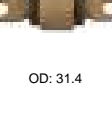
 ID: 18, OD: 55.5, L: 58	AR7438L Front Lower Control Arm Bush - Inner Rear LHS Honda Ballade (SR4) (D15B3) 150 Encore, Luxline, Spreeline, (D16A7) 160E, i, Luxline, Spreeline, (B18B3) 180E, i Luxline, Spreeline (92-98)
 ID: 18, OD: 55.5, L: 58	AR7438R Front Lower Control Arm Bush - Inner Rear RHS Honda Ballade (SR4) (D15B3) 150 Encore, Luxline, Spreeline, (D16A7) 160E, i, Luxline, Spreeline, (B18B3) 180E, i Luxline, Spreeline (92-98)
	AR7440 Front Strut Mounting Honda Ballade (SR4) (D15B3) 150 Encore, Luxline, Spreeline, (D16A7) 160E, i, Luxline, Spreeline, (B18B3) 180E, i Luxline, Spreeline (92-98)
 ID: 10, OD: 34, L: 40	AR7441 Front Upper Control Arm Bush - Inner Front & Outer Rear Honda Ballade (SH4) (D15B3) 150 16V SOHC, (D16A9) 160i 16V SOHC, DOHC (89-92), Ballade (SR4) (D15B3) 150 Encore, Luxline, Spreeline, (D16A7) 160E, i, Luxline, Spreeline, (B18B3) 180E, i Luxline, Spreeline (92-98)
	AR7445 Front Stabilizer Link Grommet Honda Ballade (SR4) (D15B3) 150 Encore, Luxline, Spreeline, (D16A7) 160E, i, Luxline, Spreeline, (B18B3) 180E, i Luxline, Spreeline (92-98)
 ID: 12, L: 20, H: 29.4	AR7446 Rear Stabilizer Bar Bush Honda Ballade (SR4) (D15B3) 150 Encore, Luxline, Spreeline, (D16A7) 160E, i, Luxline, Spreeline, (B18B3) 180E, i Luxline, Spreeline (92-98)
 OD: 80, L: 160	AR7448 Rear Upper Trailing Arm Bush - Inner Honda Ballade (SR4) (D15B3) 150 Encore, Luxline, Spreeline, (D16A7) 160E, i, Luxline, Spreeline, (B18B3) 180E, i Luxline, Spreeline (92-98), Ballade (SO4) (D15Z4) 150i, Series, Encore, Luxline, Spreeline, Auto., (D16Y9, 16Z) 160i Luxline, Spreeline, (B18B4) 180i Luxline (96-00), Civic (SO3) (D15Z4) 150i Luxline, Spreeline, (D16Y9) 160i Luxline, (D16A6) 160i V-TEC (96-03), Civic (SO4) (D16Z) 160i V-TEC, (B18B4) 180i Luxline, Spreeline (96-03)
	AR7450 Engine Mounting - RHS Honda Ballade (SR4) (D15B3) 150 Encore, Luxline, Spreeline Man., (D16A7) 160E, i, Luxline, Spreeline Man., (B18B3) 180E, i Luxline, Spreeline Man. (92-98)
	AR7451 Engine Mounting - Rear L/RHS Honda Ballade (SR4) (D15B3) 150 Encore, Luxline, Spreeline, (D16A7) 160E, i, Luxline, Spreeline, (B18B3) 180E, i Luxline, Spreeline (92-98), Ballade (SO4) (D15Z4) 150i, Series, Encore, Luxline, Spreeline, Auto., (D16Y9, 16Z) 160i Luxline, Spreeline, (B18B4) 180i Luxline (96-00), Civic (SO3) (D15Z4) 150i Luxline, Spreeline, (D16Y9) 160i Luxline, (D16A6) 160i V-TEC (96-03), Civic (SO4) (D16Z) 160i V-TEC, (B18B4) 180i Luxline, Spreeline (96-03), CR-V 4X4 (B20Z1) 2.0 SWB SUV Pet. (97-05)
 OD: 31.4	AR7453 Rear Upper Trailing Arm Bush - Inner L/RHS Honda Ballade (SR4) (D15B3) 150 Encore, Luxline, Spreeline, (D16A7) 160E, i, Luxline, Spreeline, (B18B3) 180E, i Luxline, Spreeline (92-98), Ballade (SO4) (D15Z4) 150i, Series, Encore, Luxline, Spreeline, Auto., (D16Y9, 16Z) 160i Luxline, Spreeline, (B18B4) 180i Luxline (96-00), Civic (SO3) (D15Z4) 150i Luxline, Spreeline, (D16Y9) 160i Luxline, (D16A6) 160i V-TEC (96-03), Civic (SO4) (D16Z) 160i V-TEC, (B18B4) 180i Luxline, Spreeline (96-03)

	AR7454 Engine Mounting - Rear Centre Honda Ballade (SO4) (D15Z4) 150i, Series, Encore, Luxline, Spreeline, Auto., (D16Y9, 16Z) 160i Luxline, Spreeline, (B18B4) 180i Luxline (96-00), Civic (SO3) (D15Z4) 150i Luxline, Spreeline, (D16Y9) 160i Luxline, (D16A6) 160i V-TEC (96-03), Civic (SO4) (D16Z) 160i V-TEC, (B18B4) 180i Luxline, Spreeline (96-03)
	AR7455 Engine Mounting - RHS Volvo S40 (B4204T2/3) 2.0T Sedan 4-Spd. Auto. (97-04), V40 (B4204S, B4204T2) 2.0T Estate, 4-Spd. Auto. (97-04)
	AR7456 Engine Mounting - LHS Volvo S40 (B4204T2/3) 2.0T Sedan 4-Spd. Auto. (97-04), V40 (B4204S, B4204T2) 2.0T Estate, 4-Spd. Auto. (97-04)
 ID: 12, OD: 36, L: 60	AR7457 Front Lower Control Arm Bush - Inner Front Volvo S40 (B4204T2/3) 2.0T Sedan 4-Spd. Auto., 5-Spd.Man. (97-04), V40 (B4204S, B4204T2) 2.0T Estate, 5-Spd. Man., 4-Spd. Auto. (97-04)
 ID: 15	AR7458 Front Strut Mounting Volvo S40 (B4204T2/3) 2.0T Sedan 4-Spd. Auto., 5-Spd.Man. (97-04), V40 (B4204S, B4204T2) 2.0T Estate, 5-Spd. Man., 4-Spd. Auto. (97-04)
	AR7459 Engine Mounting - RHS Volvo S40 (B4204T2/3) 2.0T Sedan 5-Spd.Man. (97-04), V40 (B4204S, B4204T2) 2.0T Estate, 5-Spd. Man. (97-04)
 L: 225	AR7462 Rear Axle Rod - RHS Volvo S40 (B4204T2/3) 2.0T Sedan 4-Spd. Auto., 5-Spd.Man. (97-04), V40 (B4204S, B4204T2) 2.0T Estate, 5-Spd. Man., 4-Spd. Auto. (97-04)
 L: 225	AR7463 Rear Axle Rod - LHS Volvo S40 (B4204T2/3) 2.0T Sedan 4-Spd. Auto., 5-Spd.Man. (97-04), V40 (B4204S, B4204T2) 2.0T Estate, 5-Spd. Man., 4-Spd. Auto. (97-04)
	AR7464 Engine Mounting - Front Volvo S70 (B5254S) 2.4 Estate, (D5252T) 2.5T R Sedan, Estate 5-Spd. Man., 4-Spd. Auto. (97-04), V70 (B5234T4) 2.3 T5 Sedan, Estate (97-04)
 ID: 12, OD: 61, L: 40/59	AR7465 Engine Mounting - Front (Insert for AR7513) Volvo S70 (B5254S) 2.4 Estate, (D5252T) 2.5T R Sedan, Estate 5-Spd. Man., 4-Spd. Auto. (97-04), V70 (B5234T4) 2.3 T5 Sedan, Estate (97-04), XC70 4X4 (B5244T3/4) 2.4 D5 Estate, SUV, Geartronic, (B5254T2) 2.5 T5 Estate, SUV, Geartronic (99-07), (D5244T5/10/14/16) 2.4 D5 Estate, SUV, Geartronic, (B5254T2) 2.5 T5 Estate, SUV, Geartronic, (B6324S) 3.2 Estate, SUV, Geartronic (2007-), XC90 (D5244T4) 2.4i D5 5/7-Seater SUV Geartronic, R-Design, Exec., (B5254T2) 2.5 T5 5/7-Seater SUV Geartronic (2003-)
	AR7470 Front Strut Mounting - Upper Volvo S70 (B5254S) 2.4 Estate, (D5252T) 2.5T R Sedan, Estate 5-Spd. Man., 4-Spd. Auto. (97-04), V70 (B5234T4) 2.3 T5 Sedan, Estate (97-04), XC70 4X4 (B5244T3/4) 2.4 D5 Estate, SUV, Geartronic, (B5254T2) 2.5 T5 Estate, SUV, Geartronic (99-07)

ENGINE MOUNTING & RUBBER BUYERS GUIDE









	AR7474 Front Lower Control Arm Bush - Outer Front LHS Volvo S40 (B4204T2/3) 2.0T Sedan 4-Spd. Auto., 5-Spd.Man. (97-04), V40 (B4204S, B4204T2) 2.0T Estate, 5-Spd. Man., 4-Spd. Auto. (97-04)		AR7486 Front Lower Control Arm Bush - Outer Rear Volvo S60 (B5204T5) 2.0T, (B5234T3) 2.3 T5, (B5244S) 2.4, (D5244T) 2.4 D5, (D5244T4) 2.4 D5, (B5244T5) 2.4 T5, (B5254T2) 2.5T (03-09), S60 4X4 (B5244T4) 2.5 R (03-09), XC70 4X4 (B5244T3/4) 2.4 D5 Estate, SUV, Geartronic, (B5254T2) 2.5 T5 Estate, SUV, Geartronic (99-07), (D5244T5/10/14/16) 2.4 D5 Estate, SUV, Geartronic, (B5254T2) 2.5 T5 Estate, SUV, Geartronic, (B6324S) 3.2 Estate, SUV, Geartronic (2007-)
	AR7475 Front Lower Control Arm Bush - Outer Front RHS Volvo S40 (B4204T2/3) 2.0T Sedan 4-Spd. Auto., 5-Spd.Man. (97-04), V40 (B4204S, B4204T2) 2.0T Estate, 5-Spd. Man., 4-Spd. Auto. (97-04)		AR7487 Front Strut Mounting - Upper Volvo S70 (B5254S) 2.4 Estate, (D5252T) 2.5T R Sedan, Estate 5-Spd. Man., 4-Spd. Auto. (97-04), V70 (B5234T4) 2.3 T5 Sedan, Estate (97-04)
	AR7476 Rear Axle Bush Volvo S40 (B4204T2/3) 2.0T Sedan 4-Spd. Auto., 5-Spd.Man. (97-04), V40 (B4204S, B4204T2) 2.0T Estate, 5-Spd. Man., 4-Spd. Auto. (97-04)		AR7488 Front Strut Mounting - Lower Volvo S70 (B5254S) 2.4 Estate, (D5252T) 2.5T R Sedan, Estate 5-Spd. Man., 4-Spd. Auto. (97-04), V70 (B5234T4) 2.3 T5 Sedan, Estate (97-04), XC70 4X4 (B5244T3/4) 2.4 D5 Estate, SUV, Geartronic, (B5254T2) 2.5 T5 Estate, SUV, Geartronic (99-07)
	AR7477 Rear Axle Frame Bush - Front Volvo S60 (B5204T5) 2.0T, (B5234T3) 2.3 T5, (B5244S) 2.4, (D5244T) 2.4 D5, (D5244T4) 2.4 D5, (B5244T5) 2.4 T5, (B5254T2) 2.5T (03-09), S60 4X4 (B5244T4) 2.5 R (03-09), S70 (B5254S) 2.4 Estate, (D5252T) 2.5T R Sedan, Estate 5-Spd. Man., 4-Spd. Auto. (97-04), V70 (B5234T4) 2.3 T5 Sedan, Estate (97-04), XC70 4X4 (B5244T3/4) 2.4 D5 Estate, SUV, Geartronic, (B5254T2) 2.5 T5 Estate, SUV, Geartronic (99-07)		AR7490 Transmission Mounting Volvo S40 (B4204T2/3) 2.0T Sedan 4-Spd. Auto. (97-04), V40 (B4204S, B4204T2) 2.0T Estate, 4-Spd. Auto. (97-04)
	AR7478 Rear Axle Frame Bush - Rear Volvo S60 (B5204T5) 2.0T, (B5234T3) 2.3 T5, (B5244S) 2.4, (D5244T) 2.4 D5, (D5244T4) 2.4 D5, (B5244T5) 2.4 T5, (B5254T2) 2.5T (03-09), S60 4X4 (B5244T4) 2.5 R (03-09), S70 (B5254S) 2.4 Estate, (D5252T) 2.5T R Sedan, Estate 5-Spd. Man., 4-Spd. Auto. (97-04), V70 (B5234T4) 2.3 T5 Sedan, Estate (97-04), XC70 4X4 (B5244T3/4) 2.4 D5 Estate, SUV, Geartronic, (B5254T2) 2.5 T5 Estate, SUV, Geartronic (99-07)		AR7491 Transmission Mounting Volvo S40 (B4204T2/3) 2.0T Sedan 5-Spd.Man. (97-04), V40 (B4204S, B4204T2) 2.0T Estate, 5-Spd. Man. (97-04)
	AR7479 Rear Strut Bush Volvo S70 (B5254S) 2.4 Estate, (D5252T) 2.5T R Sedan, Estate 5-Spd. Man., 4-Spd. Auto. (97-04), V70 (B5234T4) 2.3 T5 Sedan, Estate (97-04)		AR7492 Front Strut Mounting Honda Ballade (SO4) (D15Z4) 150i, Series, Encore, Luxline, Spreeline, Auto., (D16Y9, 16Z) 160i Luxline, Spreeline, (B18B4) 180i Luxline (96-00), Civic (SO3) (D15Z4) 150i Luxline, Spreeline, (D16Y9) 160i Luxline, (D16A6) 160i V-TEC (96-03), Civic (SO4) (D16Z) 160i V-TEC, (B18B4) 180i Luxline, Spreeline (96-03)
	AR7480 Engine Mounting - Front RHS Honda Civic (SO3) (D15Z4) 150i Luxline, Spreeline, (D16Y9) 160i Luxline, (D16A6) 160i V-TEC (96-03), Civic (SO4) (D16Z) 160i V-TEC, (B18B4) 180i Luxline, Spreeline (96-03)		AR7493 Front Lower Control Arm Bush - Inner Rear Honda Ballade (SO4) (D15Z4) 150i, Series, Encore, Luxline, Spreeline, Auto., (D16Y9, 16Z) 160i Luxline, Spreeline, (B18B4) 180i Luxline (96-00), Civic (SO3) (D15Z4) 150i Luxline, Spreeline, (D16Y9) 160i Luxline, (D16A6) 160i V-TEC (96-03), Civic (SO4) (D16Z) 160i V-TEC, (B18B4) 180i Luxline, Spreeline (96-03), CR-V 4X4 (B20Z1) 2.0 SWB SUV Pet. (97-05)
	AR7481 Engine Mounting - Front LHS Honda Civic (SO3) (D15Z4) 150i Luxline, Spreeline, (D16Y9) 160i Luxline, (D16A6) 160i V-TEC (96-03), Civic (SO4) (D16Z) 160i V-TEC, (B18B4) 180i Luxline, Spreeline (96-03)		AR7499 Rear Lower Control Arm Bush - Inner L/RHS Volvo S70 (B5254S) 2.4 Estate, (D5252T) 2.5T R Sedan, Estate 5-Spd. Man., 4-Spd. Auto. (97-04), V70 (B5234T4) 2.3 T5 Sedan, Estate (97-04)
	AR7482 Rear Axle Rod Assy. - L/RHS Volvo S40 (B4204T2/3) 2.0T Sedan 4-Spd. Auto., 5-Spd.Man. (97-04), V40 (B4204S, B4204T2) 2.0T Estate, 5-Spd. Man., 4-Spd. Auto. (97-04)		AR7500 Rear Lower Control Arm Bush - Outer Upper L/RHS Volvo S70 (B5254S) 2.4 Estate, (D5252T) 2.5T R Sedan, Estate 5-Spd. Man., 4-Spd. Auto. (97-04), V70 (B5234T4) 2.3 T5 Sedan, Estate (97-04)
	AR7485 Front Lower Control Arm Bush - Inner Front Volvo S60 (B5204T5) 2.0T, (B5234T3) 2.3 T5, (B5244S) 2.4, (D5244T) 2.4 D5, (D5244T4) 2.4 D5, (B5244T5) 2.4 T5, (B5254T2) 2.5T (03-09), S60 4X4 (B5244T4) 2.5 R (03-09), XC70 4X4 (B5244T3/4) 2.4 D5 Estate, SUV, Geartronic, (B5254T2) 2.5 T5 Estate, SUV, Geartronic (99-07), (D5244T5/10/14/16) 2.4 D5 Estate, SUV, Geartronic, (B5254T2) 2.5 T5 Estate, SUV, Geartronic, (B6324S) 3.2 Estate, SUV, Geartronic (2007-)		AR7502 Rear Axle Trailing Arm Bush - Front Upper L/RHS Volvo S70 (B5254S) 2.4 Estate, (D5252T) 2.5T R Sedan, Estate 5-Spd. Man., 4-Spd. Auto. (97-04), V70 (B5234T4) 2.3 T5 Sedan, Estate (97-04)
	AR7503 Rear Cross Strut Bush at Wheel Carrier Volvo S70 (B5254S) 2.4 Estate, (D5252T) 2.5T R Sedan, Estate 5-Spd. Man., 4-Spd. Auto. (97-04), V70 (B5234T4) 2.3 T5 Sedan, Estate (97-04)		AR7503 Rear Cross Strut Bush at Wheel Carrier Volvo S70 (B5254S) 2.4 Estate, (D5252T) 2.5T R Sedan, Estate 5-Spd. Man., 4-Spd. Auto. (97-04), V70 (B5234T4) 2.3 T5 Sedan, Estate (97-04)

ENGINE MOUNTING & RUBBER BUYERS GUIDE

	AR7504 Engine Mounting - Front RHS Honda Ballade (SO4) (D15Z4) 150i, Series, Encore, Luxline, Spreeline, Auto., (D16Y9, 16Z) 160i Luxline, Spreeline, (B18B4) 180i Luxline (96-00)
	AR7505 Front Strut Mousing Honda Ballade (SH4) (D15B3) 150 16V SOHC, (D16A9) 160i 16V SOHC, DOHC (89-92)
	AR7507 Engine Mounting - RHS Honda Ballade (SH4) (D15B3) 150 16V Man. SOHC, (D16A9) 160i 16V Man. SOHC, DOHC (89-92)
	AR7508 Engine Mounting - Rear Honda Ballade (SH4) (D15B3) 150 16V Man. SOHC, (D16A9) 160i 16V Man. SOHC, DOHC (89-92)
	AR7509 Front Lower Control Arm Bush - Inner Isuzu KB-Series KB160 (4ZA1) 1.6 SWB, Fleetside P/up Pet., KB200 (ZC1) 2.0 SWB, LWB, D/cab, LE, Fleetside, P/up Pet., KB220 (C22NE) 2.2 LWB D/cab, LE P/up Pet., KB230 (4ZD1) 2.3 SWB, LWB, D/cab P/up Pet., KB250D (4JA1) 2.5 SWB, LWB D/cab, LE, Fleetside, P/up Dies., KB280DT (4JB1) 2.8 SWB, LWB LE, D/cab LE, Frontier LX P/up (89-04), KB-Series KB260 (4ZE1) 2.6 SWB/LWB LE, LX, D/cab P/up Pet. (92-04)
	AR7510 Front Lower Control Arm Bush - Inner Front Isuzu KB-Series 4X4 KB280DT (4JB1) SWB, LWB LE, LE D/cab, LX, LX D/cab, P/up (96-04), KB320 (6VD1) V6 SWB, LWB Frontier LX, LX, LX D/cab P/up Pet. (98-04), KB-Series KB320 (6VD1) 3.2 V6 SWB, LWB LE, LX, D/cab, Frontier, Reef, Blazer P/up Pet. (92-04)
	AR7511 Front Lower Control Arm Bush - Outer Rear Isuzu KB-Series 4X4 KB220 (C22NE) LWB D/cab, LE, P/up Pet., KB230 (4ZD1) SWB P/up Pet., KB250D (4JA1) SWB/LWB, D/cab, LE, LE D/cab P/up Dies., KB260 (4ZE1) LWB D/cab, LE, LX D/cab P/up, KB280DT (4JB1) SWB, LWB LE, LE D/cab, LX, LX D/cab, P/up (89-04), KB320 (6VD1) V6 SWB, LWB Frontier LX, LX, LX D/cab P/up Pet. (98-04), KB-Series KB320 (6VD1) 3.2 V6 SWB, LWB LE, LX, D/cab, Frontier, Reef, Blazer P/up Pet. (92-04)
	AR7513 Engine Mounting - Front, Lower Torque Rod Mounting Volvo S60 (B5204T5) 2.0T, (B5234T3) 2.3 T5, (B5244S) 2.4, (D5244T) 2.4 D5, (D5244T4) 2.4 D5, (B5244T5) 2.4 T5, (B5254T2) 2.5T (03-09), S60 4X4 (B5244T4) 2.5 R (03-09), S70 (B5254S) 2.4 Estate, (D5252T) 2.5T R Sedan, Estate 5-Spd. Man., 4-Spd. Auto. (97-04), V70 (B5234T4) 2.3 T5 Sedan, Estate (97-04), XC70 4X4 (B5244T3/4) 2.4 D5 Estate, SUV, Geartronic, (B5254T2) 2.5 T5 Estate, SUV, Geartronic (99-07), (D5244T5/10/14/16) 2.4 D5 Estate, SUV, Geartronic, (B5254T2) 2.5 T5 Estate, SUV, Geartronic, (B6324S) 3.2 Estate, SUV, Geartronic (2007-)
	AR7515 Engine Mounting - Front Audi A6 (ABC) 2.6 (94-97)
	AR7516 Engine Mounting - Front Audi A6 (AAH) 2.8 (94-97)

	AR7519 Front Stabilizer Bar Bush Isuzu KB-Series 4X4 KB280DT (4JB1) SWB, LWB LE, LE D/cab, LX, LX D/cab, P/up (96-04), KB320 (6VD1) V6 SWB, LWB Frontier LX, LX, LX D/cab P/up Pet. (98-04), KB-Series KB320 (6VD1) 3.2 V6 SWB, LWB LE, LX, D/cab, Frontier, Reef, Blazer P/up Pet. (92-04)
	AR7521 Engine Mounting - LHS Isuzu KB-Series KB320 (6VD1) 3.2 V6 SWB, LWB LE, LX, D/cab, Frontier, Reef, Blazer P/up Pet. (92-04), KB-Series 4X4 KB320 (6VD1) V6 SWB, LWB Frontier LX, LX, LX D/cab P/up Pet. (98-04)
	AR7522 Engine Mounting - RHS Isuzu KB-Series KB320 (6VD1) 3.2 V6 SWB, LWB LE, LX, D/cab, Frontier, Reef, Blazer P/up Pet. (92-04), KB-Series 4X4 KB320 (6VD1) V6 SWB, LWB Frontier LX, LX, LX D/cab P/up Pet. (98-04)
	AR7523 Transmission Mounting Isuzu KB-Series KB320 (6VD1) 3.2 V6 SWB, LWB LE, LX, D/cab, Frontier, Reef, Blazer P/up Pet. (92-04)
	AR7524 Shock Rubber - Front Isuzu KB-Series KB280DT (4JB1) 2.8 SWB, LWB LE, D/cab LE, Frontier LX P/up (89-04), KB320 (6VD1) 3.2 V6 SWB, LWB LE, LX, D/cab, Frontier, Reef, Blazer P/up Pet. (92-04)
	AR7525 Transmission Mounting Isuzu KB-Series 4X4 KB320 (6VD1) V6 SWB, LWB Frontier LX, LX, LX D/cab P/up Pet. (98-04)
	AR7526 Engine Mounting - L/RHS Toyota Cressida (GX71) (1G-E) 2.0 GLi6 5-Spd. Man., Executive DOHC, (1G-FE) I.R.S. 4-Spd. Auto. (89-92), (MX75) 3.0 GLS 5-Spd. Man., (ECT) (7M-GE) 3.0i I.R.S. 24V DOHC 4-Spd. Auto. (86-92)
	AR7527 Front Upper Control Arm Bush - Inner Front & Outer Rear Nissan Hardbody (QW/244) (NA20S) 2.0 SWB, LWB SL P/up Pet., (KA20) 2.0i SWB, LWB S/Cab, SL, S/cab P/up Pet., (KA24) 2.4i LWB S/cab, SL S/cab, D/cab, SL D/cab, Hi Rider S/Cab, D/cab P/up Pet., (TD27i) 2.7 SE, D/C, TD LWB, S/cab, D/cab, SE P/up Dies. (98-11), Hardbody (D22, QW/244) (VG30E) 3.0i V6 LWB SL P/up Pet., (ZD30) 3.0D, TD LWB Hi Rider, KingCab, Hi Rider P/up Dies., (QD32) 3.2D LWB SE, SL, SLE, D/cab P/up Dies., (VG33E) 3.3 V6 LWB Hi Rider, S/cab, D/cab, KingCab P/up Pet. (98-10), Hardbody (D22, QW/244) 4X4 (KA24E) 2.4i, LWB S/cab, SL D/cab, P/up Pet., (TD27i) 2.7D, LWB S/cab, SE, D/cab, P/up Dies., (ZD30) 3.0 V6 LWB D/cab, SE, SE D/cab, SL P/up Pet. (98-10), Hardbody (D22, QW/244) 4X4 (ZD30) 3.0TD LWB D/cab, KingCab P/up Dies., (QD32) 3.2D LWB SL S/cab, SE D/cab P/up Dies., (VG33E) 3.3i V6 LWB D/cab, Hi Rider D/cab P/up Pet. (99-10), Hardbody NP300 (D22) (KA20DE) 2.0i SWB, LWB S, SE P/up Pet., (KA24DE) 2.4i LWB D/cab, D/cab Hi Rider P/up Pet., (YD25DDTi) 2.5 TDi LWB S, SE, D/C, D/C Hi Rider, P/up Dies. (2008-), Hardbody NP300 (D22) 4X4 (KA24DE) 2.4i LWB S/C, D/C Hi Rider P/up Pet., (YD25DDTi) 2.5 TDi LWB S, SE, D/C, D/C Hi Rider P/up Dies. (2008-), Patrol (Y61) 4X4 (VG30E) 3.0 V6 LWB Y60 S/W Pet., 3.0Di 6-Cyl. LWB GRX, TDi GL S/W Dies., (TD42) 4.2 6-Cyl. LWB LDF P/up, S/W Dies., 4.5 6-Cyl. LWB P/up Dies., 4.8 6-Cyl. LWB GL, GRX P/up Dies. (98-03)
	AR7528 Front Stabilizer Link Assy. Opel Astra F (14NV) 140, i, IS, (16NZ) 160, i, Estate, iE, IS OHC, (18XE) 180i 18SE/XL iE OHC (93-99), Kadett (14NE) 140, S, (16NZ) 160i S, (18SE) 180i, iE (93-99)

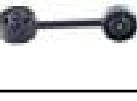
ENGINE MOUNTING & RUBBER BUYERS GUIDE

 ID: 22, L: 85	AR7529 Front Stabilizer Link Assy. Opel Astra F (20SE) 200i, Estate, iE, (20XE) tS (93-99), Kadett (20SE) 200iS, (20XE) tS (93-99)		AR7544 Engine Stabilizer Link Toyota Camry II 2.4i GLi, XLi (01-06), (MCV10) (1MZ-FE) 3.0 GLX Sedan V6 Quad Cam, Aluminum (01-06)
 THREAD: M10 x 1.75 ID: 12, OD: 35, L: 79	AR7530 Front Stabilizer Link Assy. Volkswagen Golf II 1.3 CL 4-Spd. Man., 1.6 CSL 5-Spd. Man., 1.8 GTS 16V, CSX, GTI 8V, 16V, 5-Spd. Man., 3-Spd. Auto., 2.0 GTI 8V, Exec. 16V 5-Spd. Man. (84-92), Golf III 1.6 GS 5-Spd. Man., 1.8 GSX, GTS 5-Spd. Man., 3-Spd. Auto., 2.0 GTI, 8V GTI Exec. 5-Spd. Man. (92-99), Jetta II 1.6 CSL 5-Spd. Man., 1.8 CLi, CLi Exec., Executive, CLX, CSX 5-Spd. Man., 3-Spd. Auto., 2.0 L 16V 5-Spd. Man. (85-92), Jetta III 1.6 CSL 5-Spd. Man., 1.8 CLX, CSX 5-Spd. Man., 3-Spd. Auto., 2.0 CLi, CLi Exec. 5-Spd. Man., 2.8 VR6 Exec. V6 5-Spd. Man., 4-Spd. Auto. (92-99)		AR7545 Engine Mounting - RHS BMW 5-Series (E60) 530d (M57) 3.0 (04-10)
 THREAD: M8 x 1.25 ID: 16.5, OD: 35, L: 76.5	AR7531 Front Stabilizer Link Assy. Volkswagen Golf II 1.3 CL 4-Spd. Man., 1.6 CSL 5-Spd. Man., 1.8 GTS 16V, CSX, GTI 8V, 16V, 5-Spd. Man., 3-Spd. Auto., 2.0 GTI 8V, Exec. 16V 5-Spd. Man. (84-92), Golf III 1.6 GS 5-Spd. Man., 1.8 GSX, GTS 5-Spd. Man., 3-Spd. Auto., 2.0 GTI, 8V GTI Exec. 5-Spd. Man. (92-99), Jetta II 1.6 CSL 5-Spd. Man., 1.8 CLi, CLi Exec., Executive, CLX, CSX 5-Spd. Man., 3-Spd. Auto., 2.0 L 16V 5-Spd. Man. (85-92), Jetta III 1.6 CSL 5-Spd. Man., 1.8 CLX, CSX 5-Spd. Man., 3-Spd. Auto., 2.0 CLi, CLi Exec. 5-Spd. Man., 2.8 VR6 Exec. V6 5-Spd. Man., 4-Spd. Auto. (92-99)	 NO PICTURE AVAILABLE AT TIME OF PRINT	AR7546 Engine Mounting - Rear Toyota Camry II 2.4i GLi, XLi (01-06)
 THREAD: M12 x 1.5 OD: 15, L: 100	AR7532 Front Stabilizer Link Assy. Volkswagen Polo (6N) 1.4i Classic, Playa, 1.6i Classic Lux, Classic, Playa, 1.8i Classic Lux, Playa 5-Spd. Man. (96-03)		AR7548 Engine Mounting - LHS Toyota Camry II 2.4i GLi, XLi Auto. (01-06)
 L: 55	AR7534 Front Stabilizer Link Assy. Volkswagen Golf III 2.8 VR6, VR6 Exec. V6 5-Spd. Man., 4-Spd. Auto. (92-99)		AR7549 Engine Mounting - RHS Toyota Camry II 2.4i GLi, XLi (01-06)
 ID: 28, L: 31.5, H: 42.4	AR7537 Front Stabilizer Bar Bush Mitsubishi Pajero 4X4 (4M40) 2.8TDi LWB GLS SUV V23C Dies., (6G72) 3.0 6-Cyl. SWB GLS Wagon V43W, V64W Pet. (90-01), (6G74) 3.5 V6 LWB GLS SUV V25/45W Pet. (95-01)	 ID: 16, L: 31, H: 62	AR7550 Front Stabilizer Bar Bush Toyota Camry II 2.4i GLi, XLi (01-06), (MCV10) (1MZ-FE) 3.0 GLX Sedan V6 Quad Cam, Aluminum (01-06)
	AR7539 Engine Mounting - Front Toyota Camry II (MCV10) (1MZ-FE) 3.0 GLX Sedan V6 Quad Cam, Aluminum Man. (01-06)		AR7552L Front Strut Mounting - LHS Toyota Camry II (MCV10) (1MZ-FE) 3.0 GLX Sedan V6 Quad Cam, Aluminum (01-06)
	AR7540 Engine Mounting - Front Toyota Camry II (MCV10) (1MZ-FE) 3.0 GLX Sedan V6 Quad Cam, Aluminum Auto. (01-06)		AR7552R Front Strut Mounting - RHS Toyota Camry II (MCV10) (1MZ-FE) 3.0 GLX Sedan V6 Quad Cam, Aluminum (01-06)
	AR7541 Transmission Mounting Toyota Camry II 2.4i GLi, XLi Auto. (01-06), (MCV10) (1MZ-FE) 3.0 GLX Sedan V6 Quad Cam, Aluminum Auto. (01-06)		AR7557 Rear Trailing Link Toyota Camry II 2.4i GLi, XLi (01-06), (MCV10) (1MZ-FE) 3.0 GLX Sedan V6 Quad Cam, Aluminum (01-06)
	AR7542 Transmission Mounting Toyota Camry II 2.4i GLi, XLi Man. (01-06), (MCV10) (1MZ-FE) 3.0 GLX Sedan V6 Quad Cam, Aluminum Man. (01-06)		AR7558 Rear Lateral Link No.1 - RHS Toyota Camry II 2.4i GLi, XLi (01-06), (MCV10) (1MZ-FE) 3.0 GLX Sedan V6 Quad Cam, Aluminum (01-06)
	AR7543 Engine Mounting - LHS BMW 5-Series (E60) 530d (M57) 3.0 (04-10)		AR7559 Rear Lateral Link No.1 - LHS Toyota Camry II 2.4i GLi, XLi (01-06), (MCV10) (1MZ-FE) 3.0 GLX Sedan V6 Quad Cam, Aluminum (01-06)
			AR7560 Rear Lateral Link No.2 L/RHS Toyota Camry II 2.4i GLi, XLi (01-06), (MCV10) (1MZ-FE) 3.0 GLX Sedan V6 Quad Cam, Aluminum (01-06)

ENGINE MOUNTING & RUBBER BUYERS GUIDE

	<p>AR7561 Engine Mounting - RHS Toyota Corolla (F11) (4ZZ-FE) 140i GLE, GLS, Sprinter 5-Spd. Man., (KS1) (3ZZ-FE) 160i GLE, GLS, GSX, Sprinter, (GF2) (1ZZ-FE) 180i GLE, GLS, GSX, Sprinter DOHC (02-08), Corolla Verso (3ZZ-FE) 1.6S, SX, TX MPV 5/6-Spd. Man., (1ZZ-FE) 1.8 SX, TX MPV 5/6-Spd. Man. (04-09), RunX (4ZZ-FE) 140i R, RS, RT, (3ZZ-FE) 160i RS, RT, RX, (1ZZ-FE) 180i RSi, RX 16V (03-08)</p>	 <p>ID: 15</p>	<p>AR7573 Front Strut Mounting Toyota Corolla (F11) (4ZZ-FE) 140i GLE, GLS, Sprinter 5-Spd. Man., (KS1) (3ZZ-FE) 160i GLE, GLS, GSX, Sprinter, (GF2) (1ZZ-FE) 180i GLE, GLS, GSX, Sprinter DOHC (02-08), RunX (4ZZ-FE) 140i R, RS, RT, (3ZZ-FE) 160i RS, RT, RX, (1ZZ-FE) 180i RSi, RX 16V (03-08)</p>
 <p>ID: 12, OD: 70, L: 76</p>	<p>AR7562 Front Upper Control Arm Bush - Inner BMW 5-Series (E60) 523i (M52, M53) 2.5, 525i (M54, N52) 2.5, 530d (M57) 3.0, 530i (M54, N52) 3.0, 545i (N62B44A) 4.4 V8 (04-10), 6-Series (E63, E64) 645Ci 4.4 (04-08)</p>	 <p>ID: 24, L: 32, H: 48, W: 57</p>	<p>AR7575 Front Stabilizer Bar Bush Toyota Yaris (1KR-FE) 1.0 T1, Zen1 Hatch, (2SZ-FE) 1.3 T3, Zen3, '+', Spirit Hatch, Sedan Man./Auto. (05-10), (2NZ-FE) 1.3 Zen3 (10-13), (1KR-FE) 1.0, (1NR-FE) 1.3 CVT, 6-Spd. (10-14)</p>
	<p>AR7563 Engine Mounting - Rear Toyota Corolla (F11) (4ZZ-FE) 140i GLE, GLS, Sprinter 5-Spd. Man., (KS1) (3ZZ-FE) 160i GLE, GLS, GSX, Sprinter, (GF2) (1ZZ-FE) 180i GLE, GLS, GSX, Sprinter DOHC (02-08), Corolla Verso (3ZZ-FE) 1.6S, SX, TX MPV 5/6-Spd. Man., (1ZZ-FE) 1.8 SX, TX MPV 5/6-Spd. Man. (04-09), RunX (4ZZ-FE) 140i R, RS, RT, (3ZZ-FE) 160i RS, RT, RX, (1ZZ-FE) 180i RSi, RX 16V (03-08)</p>	 <p>ID: 12, OD: 65.2, L: 96</p>	<p>AR7576 Rear Axle Beam Bush Toyota Corolla (F11) (4ZZ-FE) 140i GLE, GLS, Sprinter 5-Spd. Man., (KS1) (3ZZ-FE) 160i GLE, GLS, GSX, Sprinter, (GF2) (1ZZ-FE) 180i GLE, GLS, GSX, Sprinter DOHC (02-08), RunX (4ZZ-FE) 140i R, RS, RT, (3ZZ-FE) 160i RS, RT, RX, (1ZZ-FE) 180i RSi, RX 16V (03-08)</p>
	<p>AR7564 Engine Mounting - Front Toyota Auris (1AD-FTV) 2.0 D-4D RS, RX, Turbo, XD (07-13), Avensis (1AZ-FSE) 2.0 Advanced Auto. (06-09), Corolla (KS1) (3ZZ-FE) 160i GLE, GLS, GSX, Sprinter, (GF2) (1ZZ-FE) 180i GLE, GLS, GSX, Sprinter DOHC (02-08), Corolla (1AD-FTV) 2.0D-4D Advanced, Exclusive 6-Spd. Man. (2007-), Corolla Verso (3ZZ-FE) 1.6S, SX, TX MPV 5/6-Spd., (1ZZ-FE) 1.8 SX, TX MPV 5/6-Spd. (04-09), RunX (3ZZ-FE) 160i RS, RT, RX, (1ZZ-FE) 180i RSi, RX 16V (03-08), Verso (1AD-FTV) 2.0D-4D (09-14)</p>	 <p>ID: 14.2, OD: 33.2, L: 53</p>	<p>AR7577 Front Lower Control Arm Bush - Inner Front Toyota Yaris (1KR-FE) 1.0 T1, Zen1 Hatch, (2SZ-FE) 1.3 T3, Zen3, '+', Spirit Hatch, Sedan Man./Auto. (05-10), (2NZ-FE) 1.3 Zen3 (10-13), (1KR-FE) 1.0, (1NR-FE) 1.3 CVT, 6-Spd., (1NR-ZFXE) 1.5 Hybrid (10-14)</p>
	<p>AR7565 Engine Mounting - Front Toyota Corolla (F11) (4ZZ-FE) 140i GLE, GLS, Sprinter 5-Spd. Man. (02-08), Corolla Verso (3ZZ-FE) 1.6S, SX, TX MPV 5/6-Spd. Man., (1ZZ-FE) 1.8 SX, TX MPV 5/6-Spd. Man. (04-09), RunX (4ZZ-FE) 140i R, RS, RT (03-08)</p>	 <p>ID: 21, OD: 60, L: 62</p>	<p>AR7578 Front Lower Control Arm Bush - Outer Rear Toyota Yaris (1KR-FE) 1.0 T1, Zen1 Hatch, (2SZ-FE) 1.3 T3, Zen3, '+', Spirit Hatch, Sedan Man./Auto. (05-10), (2NZ-FE) 1.3 Zen3 (10-13), (1KR-FE) 1.0, (1NR-FE) 1.3 CVT, 6-Spd., (1NR-ZFXE) 1.5 Hybrid (10-14)</p>
	<p>AR7567 Engine Mounting - LHS BMW 5-Series (E60) 523i (M52, M53) 2.5, 525i (M54, N52) 2.5, 530i (M54, N52) 3.0 (04-10)</p>	 <p>ID: 21, OD: 60, L: 62</p>	<p>AR7579 Front Stabilizer Link Grommet Toyota Yaris (1KR-FE) 1.0 T1, Zen1 Hatch, (2SZ-FE) 1.3 T3, Zen3, '+', Spirit Hatch, Sedan Man./Auto. (05-10), (2NZ-FE) 1.3 Zen3 (10-13), (1KR-FE) 1.0, (1NR-FE) 1.3 CVT, 6-Spd., (1NR-ZFXE) 1.5 Hybrid (10-14)</p>
	<p>AR7568 Engine Mounting - RHS BMW 5-Series (E60) 523i (M52, M53) 2.5, 525i (M54, N52) 2.5, 530i (M54, N52) 3.0 (04-10)</p>		<p>AR7580 Engine Mounting - RHS Toyota Yaris (1KR-FE) 1.0 T1, Zen1 Hatch (05-10)</p>
	<p>AR7569 Engine Mounting - LHS Toyota Corolla (F11) (4ZZ-FE) 140i GLE, GLS, Sprinter 5-Spd. Man., (KS1) (3ZZ-FE) 160i GLE, GLS, GSX, Sprinter, (GF2) (1ZZ-FE) 180i GLE, GLS, GSX, Sprinter DOHC (02-08), Corolla Verso (3ZZ-FE) 1.6S, SX, TX MPV 5/6-Spd. Man., (1ZZ-FE) 1.8 SX, TX MPV 5/6-Spd. Man. (04-09), RunX (4ZZ-FE) 140i R, RS, RT, (3ZZ-FE) 160i RS, RT, RX, (1ZZ-FE) 180i RSi, RX 16V (03-08)</p>		<p>AR7581 Engine Mounting - Rear Toyota Yaris (1KR-FE) 1.0 T1, Zen1 Hatch (05-10)</p>
 <p>ID: 12, OD: 68, W: 85</p>	<p>AR7570 Rear Axle Beam Bush Toyota Yaris (1KR-FE) 1.0 T1, Zen1 Hatch, (2SZ-FE) 1.3 T3, Zen3, '+', Spirit Hatch, Sedan Man./Auto. (05-10), (2NZ-FE) 1.3 Zen3 (10-13)</p>		<p>AR7582 Engine Mounting - LHS Toyota Yaris (1KR-FE) 1.0 T1, Zen1 Hatch (05-10)</p>
 <p>ID: 12, L: 32, H: 37</p>	<p>AR7571 Front Stabilizer Bar Bush Toyota Corolla (F11) (4ZZ-FE) 140i GLE, GLS, Sprinter 5-Spd. Man., (KS1) (3ZZ-FE) 160i GLE, GLS, GSX, Sprinter, (GF2) (1ZZ-FE) 180i GLE, GLS, GSX, Sprinter DOHC (02-08)</p>		<p>AR7583 Engine Mounting - LHS Toyota Yaris (2SZ-FE) 1.3 T3, Zen3, '+', Spirit Hatch, Sedan Man./Auto. (05-10), (2NZ-FE) 1.3 Zen3 (10-13)</p>
 <p>NO PICTURE AVAILABLE AT TIME OF PRINT</p>	<p>AR7572 Steering Coupling Toyota Corolla (F11) (4ZZ-FE) 140i GLE, GLS, Sprinter 5-Spd. Man., (KS1) (3ZZ-FE) 160i GLE, GLS, GSX, Sprinter, (GF2) (1ZZ-FE) 180i GLE, GLS, GSX, Sprinter DOHC (02-08), RunX (4ZZ-FE) 140i R, RS, RT, (3ZZ-FE) 160i RS, RT, RX, (1ZZ-FE) 180i RSi, RX 16V (03-08)</p>		<p>AR7584 Engine Mounting - RHS Toyota Yaris (2SZ-FE) 1.3 T3, Zen3, '+', Spirit Hatch, Sedan Man./Auto. (05-10), (2NZ-FE) 1.3 Zen3 (10-13)</p>
	<p>AR7575 Steering Rack Mounting Toyota Yaris (1KR-FE) 1.0 T1, Zen1 Hatch, (2SZ-FE) 1.3 T3, Zen3, '+', Spirit Hatch, Sedan Man./Auto. (05-10)</p>	 <p>ID: 12.4, OD: 20/24, L: 25</p>	<p>AR7585 Steering Rack Mounting Toyota Yaris (1KR-FE) 1.0 T1, Zen1 Hatch, (2SZ-FE) 1.3 T3, Zen3, '+', Spirit Hatch, Sedan Man./Auto. (05-10)</p>

ENGINE MOUNTING & RUBBER BUYERS GUIDE

	AR7587 Engine Mounting - Rear Toyota Yaris (2SZ-FE) 1.3 T3, Zen3, '+', Spirit Hatch, Sedan Man./Auto. (05-10), (2NZ-FE) 1.3 Zen3 (10-13)		AR7597 Transmission Mounting Toyota Fortuner 4X4 (1KD-FTV) 3.0D-4D, Raised Body (06-11), Fortuner 4X2, 4X4 (1KD-FTV) 3.0D-4D DSI 4-Spd. Auto., Man. (11-16), Hilux "VIGO" 4X4 (2KD-FTV) 2.5 TDi LWB D-4D S/cab, S, SRX, HO Raised Body, D/C Raider P/up Dies., (2TR-FE) 2.7i LWB S/cab Raider, D/cab Raider, S/Cab, HO Raised Body, Legend40, P/up Pet., (1KD-FTV) 3.0D-4D LWB Raider, D/cab Raider Raised Body, Legend40 P/up Dies., (1GR-FE) 4.0 V6 D/cab Raider Raised Body, Legend40 P/up Pet. (05-11), Hilux 4X4 (1KD-FTV) 3.0D-4D Man. (11-16)
	AR7588 Front Strut Mounting (without Bearing) Toyota Yaris (1KR-FE) 1.0 T1, Zen1 Hatch, (2SZ-FE) 1.3 T3, Zen3, '+', Spirit Hatch, Sedan Man./Auto. (05-10), (2NZ-FE) 1.3 Zen3 (10-13), (1KR-FE) 1.0, (1NR-FE) 1.3 CVT, 6-Spd., (1NR-ZFXE) 1.5 Hybrid (10-14)		AR7598 Engine Mounting - L/RHS Toyota Quantum (2KD-FTV) 2.5D, "Family" Bus, 10/14 Seater MPV Dies., (2TR-FE) 2.7, "Family" Bus, 10/14/15 Seater, MPV, Ses' filike Pet. (2005-)
	AR7588B Front Strut Mounting (with Bearing) Toyota Yaris (1KR-FE) 1.0 T1, Zen1 Hatch, (2SZ-FE) 1.3 T3, Zen3, '+', Spirit Hatch, Sedan Man./Auto. (05-10), (2NZ-FE) 1.3 Zen3 (10-13), (1KR-FE) 1.0, (1NR-FE) 1.3 CVT, 6-Spd., (1NR-ZFXE) 1.5 Hybrid (10-14)		AR7599 Transmission Mounting Toyota Quantum (2KD-FTV) 2.5D, "Family" Bus, 10/14 Seater MPV Dies., (2TR-FE) 2.7, "Family" Bus, 10/14/15 Seater, MPV, Ses' filike Pet. (2005-)
	AR7590 Front Lower Control Arm Bush - Inner Front Toyota Avensis (1AZ-FSE) 2.0 Advanced, (2AD-FTV) 2.2 D-4D Exclusive, (2AZ-FSE) 2.4 Exclusive (06-09), Corolla (F11) (4ZZ-FE) 140i GLE, GLS, Sprinter 5-Spd. Man., (KS1) (3ZZ-FE) 160i GLE, GLS, GSX, Sprinter, (GF2) (1ZZ-FE) 180i GLE, GLS, GSX, Sprinter DOHC (02-08), RunX (4ZZ-FE) 140i R, RS, RT, (3ZZ-FE) 160i RS, RT, RX, (1ZZ-FE) 180i RSi, RX 16V (03-08)		AR7600 Exhaust Hanger - Front Toyota Fortuner 4X2, 4X4 (1KD-FTV) 3.0D-4D, Raised Body, (1GR-FE) 4.0 V6, Raised Body Pet. (06-11), Fortuner 4X2, 4X4 (2KD-FTV) 2.5D-4D 4-Spd. Auto., 5-Spd. Man., (1KD-FTV) 3.0D-4D DSI 4-Spd. Auto., (1GR-FE) 4.0 5-Spd. Auto. (11-16), Hilux "VIGO" 4X2 (1TR-FE) 2.0i LWB S/cab, S, SRX, P/up Pet. Standard Body, Hilux "VIGO" 4X2, 4X4 (2KD-FTV) 2.5 TDi LWB D-4D S/cab, S, SRX, HO Raised Body, D/C Raider P/up Dies., (2TR-FE) 2.7i LWB S/cab Raider, D/cab Raider, S/Cab, HO Raised Body, Legend40, P/up Pet., (1KD-FTV) 3.0D-4D LWB Raider, D/cab Raider Raised Body, Legend40 P/up Dies., (1GR-FE) 4.0 V6 D/cab Raider Raised Body, Legend40 P/up Pet. (05-11)
	AR7591 Front Lower Control Arm Bush - Outer Rear Toyota Avensis (1AZ-FSE) 2.0 Advanced, (2AD-FTV) 2.2 D-4D Exclusive, (2AZ-FSE) 2.4 Exclusive (06-09), Corolla (F11) (4ZZ-FE) 140i GLE, GLS, Sprinter 5-Spd. Man., (KS1) (3ZZ-FE) 160i GLE, GLS, GSX, Sprinter, (GF2) (1ZZ-FE) 180i GLE, GLS, GSX, Sprinter DOHC (02-08), RunX (4ZZ-FE) 140i R, RS, RT, (3ZZ-FE) 160i RS, RT, RX, (1ZZ-FE) 180i RSi, RX 16V (03-08)		AR7601 Exhaust Hanger - Front, Middle, Rear Toyota Condor 4X4 (2RZ-E) 2.4i Estate, TX Estate MPV Pet., 5-Spd. Man., (5L) 3.0 SWB Estate, TX Estate MPV Dies., (5L) 3.0 Estate, TE Estate MPV Dies. 5-Spd. Man. (00-05), Fortuner 4X2, 4X4 (1KD-FTV) 3.0D-4D, Raised Body, (1GR-FE) 4.0 V6, Raised Body Pet. (06-11), Fortuner 4X2, 4X4 (2KD-FTV) 2.5D-4D 4-Spd. Auto., 5-Spd. Man., (1KD-FTV) 3.0D-4D DSI 4-Spd. Auto., (1GR-FE) 4.0 5-Spd. Auto. (11-16), Hilux "VIGO" 4X2 (1TR-FE) 2.0i LWB S/cab, S, SRX, P/up Pet. Standard Body, Hilux "VIGO" 4X2, 4X4 (2KD-FTV) 2.5 TDi LWB D-4D S/cab, S, SRX, HO Raised Body, D/C Raider P/up Dies., (2TR-FE) 2.7i LWB S/cab Raider, D/cab Raider, S/Cab, HO Raised Body, Legend40, P/up Pet., (1KD-FTV) 3.0D-4D LWB Raider, D/cab Raider Raised Body, Legend40 P/up Dies., (1GR-FE) 4.0 V6 D/cab Raider Raised Body, Legend40 P/up Pet. (05-11), Hilux 4X2 (1TR-FE) 2.0 VVTi 5-Spd. Man., S/cab Std. Body, (2KD-FTV) 2.5D-4D 5-Spd. Man. Std., Raised Body, Hilux 4X4 (2KDF-TV) 2.5D-4D 5-Spd. Man., Raised Body (11-16)
	AR7592 Engine Mounting - L/RHS Toyota Fortuner 4X2, 4X4 (1KD-FTV) 3.0D-4D, Raised Body (06-11), Fortuner 4X2, 4X4 (2KD-FTV) 2.5D-4D 4-Spd. Auto., 5-Spd. Man., (1KD-FTV) 3.0D-4D DSI 4-Spd. Auto. (11-16), Hilux "VIGO" 4X2, 4X4 (2KD-FTV) 2.5 TDi LWB D-4D S/cab, S, SRX, HO Raised Body, D/C Raider P/up Dies., (1KD-FTV) 3.0D-4D LWB Raider, D/cab Raider Raised Body, Legend40 P/up Dies. (05-11), Hilux 4X2 (2KD-FTV) 2.5D-4D 5-Spd. Man. Std., Raised Body, (1KD-FTV) 3.0D-4D, Hilux 4X4 (2KDF-TV) 2.5D-4D 5-Spd. Man., Raised Body, (1KD-FTV) 3.0D-4D (11-16), Land Cruiser Prado 150 4X4 (1KD-FTV) 3.0D VX, TX S/W 4-Spd. Auto., Dies. (2010-)		AR7602 Front Strut Mounting Toyota Fortuner 4X2 (1KD-FTV) 3.0D-4D, Raised Body, (1GR-FE) 4.0 V6, Raised Body Pet. (06-11), Hilux "VIGO" 4X2 (1TR-FE) 2.0i LWB S/cab, S, SRX, P/up Pet. Standard Body (05-11), Hilux "VIGO" 4X2 (1TR-FE) 2.0i LWB S/cab, S, SRX, P/up Pet. Standard Body, (2KD-FTV) 2.5 TDi LWB D-4D S/cab, S, SRX, HO Raised Body, D/C Raider P/up Dies., (2TR-FE) 2.7i LWB S/cab Raider, D/cab Raider, S/Cab, HO Raised Body, Legend40, P/up Pet., (1KD-FTV) 3.0D-4D LWB Raider, D/cab Raider Raised Body, Legend40 P/up Dies., (1GR-FE) 4.0 V6 D/cab Raider Raised Body, Legend40 P/up Pet. (05-11), Hilux 4X2 (1TR-FE) 2.0 VVTi 5-Spd. Man., S/cab Std. Body, (2KD-FTV) 2.5D-4D 5-Spd. Man. Std., Raised Body, Hilux 4X4 (2KDF-TV) 2.5D-4D 5-Spd. Man., Raised Body (11-16)
	AR7593 Engine Mounting - L/RHS Toyota Hilux "VIGO" 4X2, 4X4 (1GR-FE) 4.0 V6 D/cab Raider Raised Body, Legend40 P/up Pet. (05-11), Hilux 4X2 (1TR-FE) 2.0 VVTi 5-Spd. Man., S/cab Std. Body, (2TR-FE) 2.7 VVTi (11-16)		AR7602 Front Strut Mounting Toyota Fortuner 4X2 (1KD-FTV) 3.0D-4D, Raised Body, (1GR-FE) 4.0 V6, Raised Body Pet. (06-11), Hilux "VIGO" 4X2 (1TR-FE) 2.0i LWB S/cab, S, SRX, P/up Pet. Standard Body (05-11), Hilux "VIGO" 4X2 (1TR-FE) 2.0i LWB S/cab, S, SRX, P/up Pet. Standard Body, (2KD-FTV) 2.5 TDi LWB D-4D S/cab, S, SRX, HO Raised Body, D/C Raider P/up Dies., (2TR-FE) 2.7i LWB S/cab Raider, D/cab Raider, S/Cab, HO Raised Body, Legend40, P/up Pet., (1KD-FTV) 3.0D-4D LWB Raider, D/cab Raider Raised Body, Legend40 P/up Dies., (1GR-FE) 4.0 V6 D/cab Raider Raised Body, Legend40 P/up Pet. (05-11), Hilux 4X2 (1TR-FE) 2.0 VVTi 5-Spd. Man., S/cab Std. Body, (2KD-FTV) 2.5D-4D 5-Spd. Man. Std., Raised Body, Hilux 4X4 (2KDF-TV) 2.5D-4D 5-Spd. Man., Raised Body (11-16)
	AR7595 Engine Mounting - L/RHS Toyota Fortuner 4X2, 4X4 (1GR-FE) 4.0 V6, Raised Body Pet. (06-11), Fortuner 4X2, 4X4 (1GR-FE) 4.0 5-Spd. Auto. (11-16), Hilux "VIGO" 4X2 (1TR-FE) 2.0i LWB S/cab, S, SRX, P/up Pet. Standard Body, (2TR-FE) 2.7i LWB S/cab Raider, D/cab Raider, S/Cab, HO Raised Body, Legend40, P/up Pet. (05-11), Hilux 4X2, 4X4 (1GR-FE) 4.0 (11-16), Hilux "REVO" 4X2 (2GD-FTV) 2.4 GD-6 Raised Body, (2TR-FE) 2.7 VVT-i Raised Body, 4X4 (2GD-FTV) 2.4 GD-6 Raised Body (2016-)		AR7602 Front Strut Mounting Toyota Fortuner 4X2 (1KD-FTV) 3.0D-4D, Raised Body, (1GR-FE) 4.0 V6, Raised Body Pet. (06-11), Hilux "VIGO" 4X2 (1TR-FE) 2.0i LWB S/cab, S, SRX, P/up Pet. Standard Body (05-11), Hilux "VIGO" 4X2 (1TR-FE) 2.0i LWB S/cab, S, SRX, P/up Pet. Standard Body, (2KD-FTV) 2.5 TDi LWB D-4D S/cab, S, SRX, HO Raised Body, D/C Raider P/up Dies., (2TR-FE) 2.7i LWB S/cab Raider, D/cab Raider, S/Cab, HO Raised Body, Legend40, P/up Pet., (1KD-FTV) 3.0D-4D LWB Raider, D/cab Raider Raised Body, Legend40 P/up Dies., (1GR-FE) 4.0 V6 D/cab Raider Raised Body, Legend40 P/up Pet. (05-11), Hilux 4X2 (1TR-FE) 2.0 VVTi 5-Spd. Man., S/cab Std. Body, (2KD-FTV) 2.5D-4D 5-Spd. Man. Std. Body (11-16), Hilux "REVO" 4X2 (1TR-FE) 2.0 VVT-i, (2GD-FTV) 2.4 GD Std. Body (2016-)
	AR7596 Transmission Mounting Toyota Hilux "VIGO" 4X2 (1TR-FE) 2.0i LWB S/cab, S, SRX, P/up Pet. Standard Body, 4X2 (2KD-FTV) 2.5 TDi LWB D-4D S/cab, S, SRX, HO Raised Body, D/C Raider P/up Dies., (2TR-FE) 2.7i LWB S/cab Raider, D/cab Raider, S/Cab, HO Raised Body, Legend40, P/up Pet., (1KD-FTV) 3.0D-4D LWB Raider, D/cab Raider Raised Body, Legend40 P/up Dies., (1GR-FE) 4.0 V6 D/cab Raider Raised Body, Legend40 P/up Pet. (05-11), Hilux 4X2 (1TR-FE) 2.0 VVTi 5-Spd. Man., S/cab Std. Body, (2KD-FTV) 2.5D-4D 5-Spd. Man. Std., Raised Body, (2TR-FE) 2.7 VVTi (11-16), Hilux "REVO" 4X2 (1TR-FE) 2.0 VVT-i, (2TR-FE) 2.7 VVT-i (2016-)		

ENGINE MOUNTING & RUBBER BUYERS GUIDE

	<p>AR7603 Front Strut Mounting</p> <p>Toyota Fortuner 4X4 (1KD-FTV) 3.0D-4D, Raised Body, (1GR-FE) 4.0 V6, Raised Body Pet. (06-11), Fortuner 4X2, 4X4 (2KD-FTV) 2.5D-4D 4-Spd. Auto., 5-Spd. Man., (1KD-FTV) 3.0D-4D DSI 4-Spd. Auto., (1GR-FE) 4.0 5-Spd. Auto. (11-16), Hilux "VIGO" 4X4 (2KD-FTV) 2.5 TDi LWB D-4D S/cab, S, SRX, HO Raised Body, D/C Raider P/up Dies., (2TR-FE) 2.7i LWB S/cab Raider, D/cab Raider, S/Cab, HO Raised Body, Legend40, P/up Pet., (1KD-FTV) 3.0D-4D LWB Raider, D/cab Raider Raised Body, Legend40 P/up Dies., (1GR-FE) 4.0 V6 D/cab Raider Raised Body, Legend40 P/up Pet. (05-11), Hilux 4X2 (1TR-FE) 2.0 VVTi 5-Spd. Man., (2KD-FTV) 2.5D-4D Raised Body, (2TR-FE) 2.7 VVTi, (1KD-FTV) 3.0D-4D, (1GR-FE) 4.0, Hilux 4X4 (2KDF-TV) 2.5D-4D 5-Spd. Man., Raised Body, (1KD-FTV) 3.0D-4D, (1GR-FE) 4.0 (11-16)</p>	 <p>ID: 23, OD: 35, L: 39</p>	<p>AR7613 Shackle Bush - Front</p> <p>Toyota Hilux "VIGO" 4X2 (1TR-FE) 2.0i LWB S/cab, S, SRX, P/up Pet. Standard Body, Hilux "VIGO" 4X2, 4X4 (2KD-FTV) 2.5 TDi LWB D-4D S/cab, S, SRX, D/C Raider P/up Dies., (2TR-FE) 2.7i LWB S/cab Raider, D/cab Raider, S/Cab, Legend40, P/up Pet., (1KD-FTV) 3.0D-4D LWB Raider, D/cab Raider, Legend40 P/up Dies., (1GR-FE) 4.0 V6 D/cab, Raider, Legend40 P/up Pet. (05-11) - Standard Body Models, Hilux 4X2 (1TR-FE) 2.0 VVTi 5-Spd. Man., S/cab Std. Body, (2KD-FTV) 2.5D-4D 5-Spd. Man. Std. Body (11-16), Hilux "REVO" 4X2 (1TR-FE) 2.0 VVT-i, (2GD-FTV) 2.4 GD Std. Body (2016-)</p>
 <p>ID: 20, OD: 48, L: 48</p>	<p>AR7604 Front Upper Control Arm Bush - Inner</p> <p>Toyota Quantum (2KD-FTV) 2.5D, "Family" Bus, 10/14 Seater MPV Dies., (2TR-FE) 2.7, "Family" Bus, 10/14/15 Seater, MPV, Ses' fikile Pet. (2005-)</p>	 <p>ID: 28.5, L: 38, H: 45, W: 52</p>	<p>AR7614 Front Stabilizer Bar Bush</p> <p>Toyota Quantum (2KD-FTV) 2.5D, "Family" Bus, 10/14 Seater MPV Dies., (2TR-FE) 2.7, "Family" Bus, 10/14/15 Seater, MPV, Ses' fikile Pet. (2005-)</p>
 <p>ID: 27, L: 38, H: 56, W: 52</p>	<p>AR7605 Front Stabilizer Bar Bush</p> <p>Toyota Fortuner 4X2, 4X4 (1KD-FTV) 3.0D-4D, Raised Body, (1GR-FE) 4.0 V6, Raised Body Pet. (06-11), Hilux "VIGO" 4X2 (1TR-FE) 2.0i LWB S/cab, S, SRX, P/up Pet. Standard Body, Hilux 4X2 (2KD-FTV) 2.5 TDi LWB D-4D S/cab, S, SRX, HO Raised Body, D/C Raider P/up Dies., (2TR-FE) 2.7i LWB S/cab Raider, D/cab Raider, S/Cab, HO Raised Body, Legend40, P/up Pet., (1KD-FTV) 3.0D-4D LWB Raider, D/cab Raider Raised Body, Legend40 P/up Dies., (1GR-FE) 4.0 V6 D/cab Raider Raised Body, Legend40 P/up Pet. (05-11), Hilux 4X2 (1TR-FE) 2.0 VVTi 5-Spd. Man., S/cab Std. Body, (2KD-FTV) 2.5D-4D 5-Spd. Man. Std. Body (11-16), Hilux "REVO" 4X2 (1TR-FE) 2.0 VVT-i, (2GD-FTV) 2.4 GD Std. Body (2016-)</p>	 <p>ID: 15, OD: 40, L: 36.5</p>	<p>AR7615 Shackle Bush - Front</p> <p>Toyota Hilux "VIGO" 4X2, 4X4 (2KD-FTV) 2.5 TDi LWB D-4D S/cab, S, SRX, HO Raised Body, D/C Raider P/up Dies., (2TR-FE) 2.7i LWB S/cab Raider, D/cab Raider, S/Cab, HO Raised Body, Legend40, P/up Pet., (1KD-FTV) 3.0D-4D LWB Raider, D/cab Raider Raised Body, Legend40 P/up Dies., (1GR-FE) 4.0 V6 D/cab Raider Raised Body, Legend40 P/up Pet. (05-11) - Raised Body Models, Hilux 4X2 (1TR-FE) 2.0 VVTi 5-Spd. Man., (2KD-FTV) 2.5D-4D Raised Body, (2TR-FE) 2.7 VVTi, (1KD-FTV) 3.0D-4D, (1GR-FE) 4.0, Hilux 4X4 (2KDF-TV) 2.5D-4D 5-Spd. Man., Raised Body, (1KD-FTV) 3.0D-4D, (1GR-FE) 4.0 (11-16)</p>
 <p>ID: 29.5, L: 36, H: 57, W: 52</p>	<p>AR7606 Front Stabilizer Bar Bush</p> <p>Toyota Fortuner 4X2, 4X4 (2KD-FTV) 2.5D-4D 4-Spd. Auto., 5-Spd. Man., (1KD-FTV) 3.0D-4D DSI 4-Spd. Auto., (1GR-FE) 4.0 5-Spd. Auto. (11-16), Hilux "VIGO" 4X4 (2KD-FTV) 2.5 TDi LWB D-4D S/cab, S, SRX, HO Raised Body, D/C Raider P/up Dies., (2TR-FE) 2.7i LWB S/cab Raider, D/cab Raider, S/Cab, HO Raised Body, Legend40, P/up Pet., (1KD-FTV) 3.0D-4D LWB Raider, D/cab Raider Raised Body, Legend40 P/up Dies., (1GR-FE) 4.0 V6 D/cab Raider Raised Body, Legend40 P/up Pet. (05-11), Hilux 4X2 (1TR-FE) 2.0 VVTi 5-Spd. Man., (2KD-FTV) 2.5D-4D Raised Body, (2TR-FE) 2.7 VVTi, (1KD-FTV) 3.0D-4D, (1GR-FE) 4.0, Hilux 4X4 (2KDF-TV) 2.5D-4D 5-Spd. Man., Raised Body, (1KD-FTV) 3.0D-4D, (1GR-FE) 4.0 (11-16)</p>	 <p>ID: 19, OD: 30, L: 51</p>	<p>AR7616 Shackle Bush - Rear Upper</p> <p>Toyota Hilux "VIGO" 4X2 (1TR-FE) 2.0i LWB S/cab, S, SRX, P/up Pet. Standard Body, Hilux "VIGO" 4X2, 4X4 (2KD-FTV) 2.5 TDi LWB D-4D S/cab, S, SRX, HO Raised Body, D/C Raider P/up Dies., (2TR-FE) 2.7i LWB S/cab Raider, D/cab Raider, S/Cab, HO Raised Body, Legend40, P/up Pet., (1KD-FTV) 3.0D-4D LWB Raider, D/cab Raider Raised Body, Legend40 P/up Dies., (1GR-FE) 4.0 V6 D/cab Raider Raised Body, Legend40 P/up Pet. (05-11), Hilux 4X2 (1TR-FE) 2.0 VVTi 5-Spd. Man., S/cab Std. Body, (2KD-FTV) 2.5D-4D 5-Spd. Man. Std., Raised Body, (2TR-FE) 2.7 VVTi, (1KD-FTV) 3.0D-4D, (1GR-FE) 4.0, Hilux 4X4 (2KDF-TV) 2.5D-4D 5-Spd. Man., Raised Body, (1KD-FTV) 3.0D-4D, (1GR-FE) 4.0 (11-16), Hilux "REVO" 4X2 (1TR-FE) 2.0 VVT-i, (2GD-FTV) 2.4 GD Std. Body, (2GD-FTV) 2.4 GD-6 Raised Body, (2TR-FE) 2.7 VVT-i, (1GD-FTV) 2.8 GD-6 Raised Body, 4X4 (2GD-FTV) 2.4 GD-6 Raised Body, (1GD-FTV) 2.8 GD-6 Raised Body (2016-)</p>
 <p>ID: 26.5, OD: 55/57, H: 75</p>	<p>AR7607 Front Upper Control Arm Bush - Outer</p> <p>Toyota Quantum (2KD-FTV) 2.5D, "Family" Bus, 10/14 Seater MPV Dies., (2TR-FE) 2.7, "Family" Bus, 10/14/15 Seater, MPV, Ses' fikile Pet. (2005-)</p>	 <p>ID: 19, OD: 30, L: 37.5</p>	<p>AR7617 Shackle Bush - Rear Lower</p> <p>Toyota Hilux "VIGO" 4X2 (1TR-FE) 2.0i LWB S/cab, S, SRX, P/up Pet. Standard Body, Hilux "VIGO" 4X2, 4X4 (2KD-FTV) 2.5 TDi LWB D-4D S/cab, S, SRX, HO Raised Body, D/C Raider P/up Dies., (2TR-FE) 2.7i LWB S/cab Raider, D/cab Raider, S/Cab, HO Raised Body, Legend40, P/up Pet., (1KD-FTV) 3.0D-4D LWB Raider, D/cab Raider Raised Body, Legend40 P/up Dies., (1GR-FE) 4.0 V6 D/cab Raider Raised Body, Legend40 P/up Pet. (05-11), Hilux 4X2 (1TR-FE) 2.0 VVTi 5-Spd. Man., S/cab Std. Body, (2KD-FTV) 2.5D-4D 5-Spd. Man. Std., Raised Body, (2TR-FE) 2.7 VVTi, (1KD-FTV) 3.0D-4D, (1GR-FE) 4.0, Hilux 4X4 (2KDF-TV) 2.5D-4D 5-Spd. Man., Raised Body, (1KD-FTV) 3.0D-4D, (1GR-FE) 4.0 (11-16)</p>
	<p>AR7608 Front Stabilizer Link Grommet</p> <p>Toyota Fortuner 4X2, 4X4 (1KD-FTV) 3.0D-4D, Raised Body, (1GR-FE) 4.0 V6, Raised Body Pet. (06-11), Hilux "VIGO" 4X2, 4X4 (2KD-FTV) 2.5 TDi LWB D-4D S/cab, S, SRX, HO Raised Body, D/C Raider P/up Dies., (2TR-FE) 2.7i LWB S/cab Raider, D/cab Raider, S/Cab, HO Raised Body, Legend40, P/up Pet., (1KD-FTV) 3.0D-4D LWB Raider, D/cab Raider Raised Body, Legend40 P/up Dies., (1GR-FE) 4.0 V6 D/cab Raider Raised Body, Legend40 P/up Pet. (05-11)</p>		<p>AR7617 Shackle Bush - Rear Lower</p> <p>Toyota Hilux "VIGO" 4X2 (1TR-FE) 2.0i LWB S/cab, S, SRX, P/up Pet. Standard Body, Hilux "VIGO" 4X2, 4X4 (2KD-FTV) 2.5 TDi LWB D-4D S/cab, S, SRX, HO Raised Body, D/C Raider P/up Dies., (2TR-FE) 2.7i LWB S/cab Raider, D/cab Raider, S/Cab, HO Raised Body, Legend40, P/up Pet., (1KD-FTV) 3.0D-4D LWB Raider, D/cab Raider Raised Body, Legend40 P/up Dies., (1GR-FE) 4.0 V6 D/cab Raider Raised Body, Legend40 P/up Pet. (05-11), Hilux 4X2 (1TR-FE) 2.0 VVTi 5-Spd. Man., S/cab Std. Body, (2KD-FTV) 2.5D-4D 5-Spd. Man. Std., Raised Body, (2TR-FE) 2.7 VVTi, (1KD-FTV) 3.0D-4D, (1GR-FE) 4.0, Hilux 4X4 (2KDF-TV) 2.5D-4D 5-Spd. Man., Raised Body, (1KD-FTV) 3.0D-4D, (1GR-FE) 4.0 (11-16)</p>
	<p>AR7612 Shock Rubber - Rear</p> <p>Toyota Fortuner 4X2, 4X4 (1KD-FTV) 3.0D-4D, Raised Body, (1GR-FE) 4.0 V6, Raised Body Pet. (06-11), Fortuner 4X2, 4X4 (2KD-FTV) 2.5D-4D 4-Spd. Auto., 5-Spd. Man., (1KD-FTV) 3.0D-4D DSI 4-Spd. Auto., (1GR-FE) 4.0 5-Spd. Auto. (11-16), Hilux 4X2 (1TR-FE) 2.0 VVTi 5-Spd. Man., S/cab Std. Body, (2KD-FTV) 2.5D-4D 5-Spd. Man. Std., Raised Body, (2TR-FE) 2.7 VVTi, (1KD-FTV) 3.0D-4D, (1GR-FE) 4.0, Hilux 4X4 (2KDF-TV) 2.5D-4D 5-Spd. Man., Raised Body, (1KD-FTV) 3.0D-4D, (1GR-FE) 4.0 (11-16)</p>	 <p>ID: 30, OD: 108.3, L: 175</p>	<p>AR7618 Centre Bearing Rubber</p> <p>Toyota Fortuner 4X2, 4X4 (1KD-FTV) 3.0D-4D, Raised Body, (1GR-FE) 4.0 V6, Raised Body Pet. (06-11), Fortuner 4X2, 4X4 (2KD-FTV) 2.5D-4D 4-Spd. Auto., 5-Spd. Man., (1KD-FTV) 3.0D-4D DSI 4-Spd. Auto., (1GR-FE) 4.0 5-Spd. Auto. (11-16), Hilux "VIGO" 4X2 (1TR-FE) 2.0i LWB S/cab, S, SRX, P/up Pet. Standard Body, Hilux "VIGO" 4X2, 4X4 (2KD-FTV) 2.5 TDi LWB D-4D S/cab, S, SRX, HO Raised Body, D/C Raider P/up Dies., (2TR-FE) 2.7i LWB S/cab Raider, D/cab Raider, S/Cab, HO Raised Body, Legend40, P/up Pet., (1KD-FTV) 3.0D-4D LWB Raider, D/cab Raider Raised Body, Legend40 P/up Dies., (1GR-FE) 4.0 V6 D/cab Raider Raised Body, Legend40 P/up Pet. (05-11), Hilux 4X2 (1TR-FE) 2.0 VVTi 5-Spd. Man., S/cab Std. Body, (2KD-FTV) 2.5D-4D 5-Spd. Man. Std., Raised Body, (2TR-FE) 2.7 VVTi, (1KD-FTV) 3.0D-4D, (1GR-FE) 4.0, Hilux 4X4 (2KDF-TV) 2.5D-4D 5-Spd. Man., Raised Body, (1KD-FTV) 3.0D-4D, (1GR-FE) 4.0 (11-16)</p>

ENGINE MOUNTING & RUBBER BUYERS GUIDE

	AR7619 Transmission Mounting Toyota Land Cruiser Prado 90/95 4X4 (1KZ-TE) 3.0 GX, VX S/W Dies. 5-Spd. Auto. (96-02)		AR7636 Rear Trailing Link Bush Toyota Land Cruiser (FZJ100) 4X4 4.2 VX TD P/up, S/W, GX DSL P/up AHC Diesel 5-Spd. Auto. (02-04), Prado 90/95 4X4 (1KZ-TE) 3.0 GX, VX S/W Dies. 5-Spd. Man., Auto., 3.4 GX, VX S/W Man., Auto., Pet. (96-02)
	AR7620 Transmission Mounting Toyota Land Cruiser Prado 90/95 4X4 (1KZ-TE) 3.0 GX, VX S/W Dies. 5-Spd. Man. (96-02)		AR7637 Rear Trailing Link Bush Toyota Land Cruiser (FZJ100) 4X4 4.2 VX TD P/up, S/W, GX DSL P/up AHC Diesel 5-Spd. Auto. (02-04), Prado 90/95 4X4 (1KZ-TE) 3.0 GX, VX S/W Dies. 5-Spd. Man., Auto., 3.4 GX, VX S/W Man., Auto., Pet. (96-02)
	AR7621 Engine Mounting - L/RHS Toyota Land Cruiser Prado 90/95 4X4 3.4 GX, VX S/W Man., Auto., Pet. (96-02)		AR7638 Upper Control Arm Link Bush Toyota Land Cruiser (FZJ100) 4X4 4.2 VX TD P/up, S/W, GX DSL P/up AHC Diesel 5-Spd. Auto. (02-04), Prado 90/95 4X4 (1KZ-TE) 3.0 GX, VX S/W Dies. 5-Spd. Man., Auto., 3.4 GX, VX S/W Man., Auto., Pet. (96-02)
	AR7622 Engine Mounting - Rear Toyota Land Cruiser Prado 90/95 4X4 3.4 GX, VX S/W Man., Pet. (96-02)		AR7639 Rear Lateral Link Toyota Land Cruiser (FZJ100) 4X4 4.2 VX TD P/up, S/W, GX DSL P/up AHC Diesel 5-Spd. Auto. (02-04), Prado 90/95 4X4 (1KZ-TE) 3.0 GX, VX S/W Dies. 5-Spd. Man., Auto., 3.4 GX, VX S/W Man., Auto., Pet. (96-02)
	AR7623 Engine Mounting - Rear Toyota Land Cruiser Prado 90/95 4X4 3.4 GX, VX S/W Auto., Pet. (96-02)		AR7640 Rear Lateral Link Toyota Land Cruiser (FZJ100) 4X4 4.2 VX TD P/up, S/W, GX DSL P/up AHC Diesel 5-Spd. Auto. (02-04), Prado 90/95 4X4 (1KZ-TE) 3.0 GX, VX S/W Dies. 5-Spd. Man., Auto., 3.4 GX, VX S/W Man., Auto., Pet. (96-02)
	AR7625 Front Upper Control Arm Bush - Inner & Outer Toyota Land Cruiser (FZJ100) 4X4 4.2 VX TD P/up, S/W, GX DSL P/up AHC Diesel 5-Spd. Auto. (02-04), Prado 90/95 4X4 (1KZ-TE) 3.0 GX, VX S/W Dies. 5-Spd. Man., Auto., 3.4 GX, VX S/W Man., Auto., Pet. (96-02) ID: 15, OD: 39.5, L: 52.5		AR7641 Engine Mounting - L/RHS Toyota Land Cruiser Prado 120 4X4 (1GR-FE) 4.0 GX, VX S/W 4-Spd. Auto. Pet. (02-09), Prado 150 4X4 (1GR-FE) 4.0 TX, VX S/W 4-Spd. Auto. Pet. (2010-), 100-Series 4X4 4.0 GX DSL S/W, VX S/W Pet. 5-Spd. Man., Auto. (98-06)
	AR7626 Front Lower Control Arm Bush - Inner & Outer Toyota Land Cruiser (FZJ100) 4X4 4.2 VX TD P/up, S/W, GX DSL P/up AHC Diesel 5-Spd. Auto. (02-04), Prado 90/95 4X4 (1KZ-TE) 3.0 GX, VX S/W Dies. 5-Spd. Man., Auto., 3.4 GX, VX S/W Man., Auto., Pet. (96-02) ID: 19.5, OD: 47, L: 66.5		AR7642 Transmission Mounting Toyota Land Cruiser Prado 120 4X4 (1GR-FE) 4.0 GX, VX S/W 4-Spd. Auto. Pet. (02-09), Prado 150 4X4 (1GR-FE) 4.0 TX, VX S/W 4-Spd. Auto. Pet. (2010-), 100-Series 4X4 4.0 GX DSL S/W, VX S/W Pet. 5-Spd. Man., Auto. (98-06)
	AR7629 Shock Rubber - Front Toyota Fortuner 4X2, 4X4 (2KD-FTV) 2.5D-4D 4-Spd. Auto., 5-Spd. Man., (1KD-FTV) 3.0D-4D DSI 4-Spd. Auto., (1GR-FE) 4.0 5-Spd. Auto. (11-16), Hilux "VIGO" 4X2 (1TR-FE) 2.0i LWB S/cab, S, SRX, P/up Pet. Standard Body (05-11), Hilux 4X2 (1TR-FE) 2.0 VVTi 5-Spd. Man., S/cab Std. Body, (2KD-FTV) 2.5D-4D 5-Spd. Man. Std., Raised Body, (2TR-FE) 2.7 VVTi, (1KD-FTV) 3.0D-4D, (1GR-FE) 4.0, Hilux 4X4 (2KDF-TV) 2.5D-4D 5-Spd. Man., Raised Body, (1KD-FTV) 3.0D-4D, (1GR-FE) 4.0 (11-16), Land Cruiser (FZJ100) 4X4 4.2 VX TD P/up, S/W, GX DSL P/up AHC Diesel 5-Spd. Auto. (02-04), (FZJ105) 4X4 4.5 GX S/W Dies. 5-Spd. Man., 4-Spd. Auto., 4.7 VX S/W V8 Petrol (03-08), (UZJ100) 4X4 (1HD-FTE) 4.2 VX TD S/W, GX DSL S/W, P/up S/W AHC Dies. 4/5-Spd. Auto. (04-08), (UZJ105) 4X4 4.5 GX S/W Dies. 5-Spd. Man., 4-Spd. Auto., 4.7 VX S/W V8 Petrol (03-08), Prado 90/95 4X4 (1KZ-TE) 3.0 GX, VX S/W Dies. 5-Spd. Man., Auto., 3.4 GX, VX S/W Man., Auto., Pet. (96-02), Prado 120 4X4 (1KZ-TE) 3.0TD, VX S/W Dies., 5-Spd. Man., 4-Spd. Auto., (1GR-FE) 4.0 GX, VX S/W 4-Spd. Auto. Pet. (02-09), 100-Series 4X4 4.0 GX DSL S/W, VX S/W Pet. 5-Spd. Man., Auto. (98-06)		AR7643 Transmission Mounting Toyota Land Cruiser Prado 120 4X4 (1KZ-TE) 3.0TD, VX S/W Dies., 5-Spd. Man. (02-09), Prado 150 4X4 (1KD-FTV) 3.0D VX, TX S/W 4-Spd. Auto., Dies. (2010-)
	AR7630 Front Stabilizer Bar Bush Toyota Land Cruiser (FZJ100) 4X4 4.2 VX TD P/up, S/W, GX DSL P/up AHC Diesel 5-Spd. Auto. (02-04), Prado 90/95 4X4 (1KZ-TE) 3.0 GX, VX S/W Dies. 5-Spd. Man., Auto., 3.4 GX, VX S/W Man., Auto., Pet. (96-02)		AR7644 Exhaust Hanger - Front, Middle, Rear Toyota Corolla Quest (1ZR-FE) 1.6 (2014-), Land Cruiser Prado 120 4X4 (1KZ-TE) 3.0TD, VX S/W Dies., 5-Spd. Man., 4-Spd. Auto., (1GR-FE) 4.0 GX, VX S/W 4-Spd. Auto. Pet. (04-05), RAV4 II (A/ZCA20) 4X2 (1ZZ-FE) 1.8 SUV Pet. 5-Spd. Man., RAV4 II (A/ZCA20) 4X4 (1AZ-FE) 2.0 SUV 5-Spd. Man., 4-Spd. Auto. (02-06)
	AR7631 Front Stabilizer Bar Bush Toyota Land Cruiser (FZJ100) 4X4 4.2 VX TD P/up, S/W, GX DSL P/up AHC Diesel 5-Spd. Auto. (02-04), Prado 90/95 4X4 (1KZ-TE) 3.0 GX, VX S/W Dies. 5-Spd. Man., Auto., 3.4 GX, VX S/W Man., Auto., Pet. (96-02) ID: 25, L: 31, H: 46, W: 51		AR7649 Front Upper Control Arm Bush - Inner & Outer Toyota Land Cruiser (FZJ105) 4X4 4.5 GX S/W Dies. 5-Spd. Man., 4-Spd. Auto., 4.7 VX S/W V8 Petrol (03-08), (UZJ100) 4X4 (1HD-FTE) 4.2 VX TD S/W, GX DSL S/W, P/up S/W AHC Dies. 4/5-Spd. Auto. (04-08), (UZJ105) 4X4 4.5 GX S/W Dies. 5-Spd. Man., 4-Spd. Auto., 4.7 VX S/W V8 Petrol (03-08), Prado 120 4X4 (1KZ-TE) 3.0TD, VX S/W Dies., 5-Spd. Man., 4-Spd. Auto., (1GR-FE) 4.0 GX, VX S/W 4-Spd. Auto. Pet. (02-09), Prado 150 4X4 (1KD-FTV) 3.0D VX, TX S/W 4-Spd. Auto., Dies., (1GR-FE) 4.0 TX, VX S/W 4-Spd. Auto. Pet. (2010-), 100-Series 4X4 4.0 GX DSL S/W, VX S/W Pet. 5-Spd. Man., Auto. (98-06) ID: 15, OD: 46, L: 62

ENGINE MOUNTING & RUBBER BUYERS GUIDE

 <p>ID: 19.5, OD: 48.5, L: 71.5</p>	<p>AR7650 Front Lower Control Arm Bush - Inner & Outer</p> <p>Toyota Land Cruiser (FZJ105) 4X4 4.5 GX S/W Dies. 5-Spd. Man., 4-Spd. Auto., 4.7 VX S/W V8 Petrol (03-08), (UZJ100) 4X4 (1HD-FTE) 4.2 VX TD S/W, GX DSL S/W, P/up S/W AHC Dies. 4/5-Spd. Auto. (04-08), (UZJ105) 4X4 4.5 GX S/W Dies. 5-Spd. Man., 4-Spd. Auto., 4.7 VX S/W V8 Petrol (03-08), Prado 120 4X4 (1KZ-TE) 3.0TD, VX S/W Dies., 5-Spd. Man., 4-Spd. Auto., (1GR-FE) 4.0 GX, VX S/W 4-Spd. Auto. Pet. (02-09), Prado 150 4X4 (1KD-FTV) 3.0D VX, TX S/W 4-Spd. Auto., Dies., (1GR-FE) 4.0 TX, VX S/W 4-Spd. Auto. Pet. (2010-), 100-Series 4X4 4.0 GX DSL S/W, VX S/W Pet. 5-Spd. Man., Auto. (98-06)</p>
	<p>AR7651 Front Strut Mounting</p> <p>Toyota Land Cruiser (FZJ105) 4X4 4.5 GX S/W Dies. 5-Spd. Man., 4-Spd. Auto., 4.7 VX S/W V8 Petrol (03-08), (UZJ100) 4X4 (1HD-FTE) 4.2 VX TD S/W, GX DSL S/W, P/up S/W AHC Dies. 4/5-Spd. Auto. (04-08), (UZJ105) 4X4 4.5 GX S/W Dies. 5-Spd. Man., 4-Spd. Auto., 4.7 VX S/W V8 Petrol (03-08), Prado 120 4X4 (1KZ-TE) 3.0TD, VX S/W Dies., 5-Spd. Man., 4-Spd. Auto., (1GR-FE) 4.0 GX, VX S/W 4-Spd. Auto. Pet. (02-09), Prado 150 4X4 (1KD-FTV) 3.0D VX, TX S/W 4-Spd. Auto., Dies., (1GR-FE) 4.0 TX, VX S/W 4-Spd. Auto. Pet. (2010-), 100-Series 4X4 4.0 GX DSL S/W, VX S/W Pet. 5-Spd. Man., Auto. (98-06)</p>
	<p>AR7652 Front Strut Mounting</p> <p>Toyota Land Cruiser (FZJ105) 4X4 4.5 GX S/W Dies. 5-Spd. Man., 4-Spd. Auto., 4.7 VX S/W V8 Petrol (03-08), (UZJ100) 4X4 (1HD-FTE) 4.2 VX TD S/W, GX DSL S/W, P/up S/W AHC Dies. 4/5-Spd. Auto. (04-08), (UZJ105) 4X4 4.5 GX S/W Dies. 5-Spd. Man., 4-Spd. Auto., 4.7 VX S/W V8 Petrol (03-08), Prado 120 4X4 (1KZ-TE) 3.0TD, VX S/W Dies., 5-Spd. Man., 4-Spd. Auto., (1GR-FE) 4.0 GX, VX S/W 4-Spd. Auto. Pet. (02-09), 100-Series 4X4 4.0 GX DSL S/W, VX S/W Pet. 5-Spd. Man., Auto. (98-06)</p>
	<p>AR7653 Front Strut Mounting</p> <p>Toyota Land Cruiser (FZJ105) 4X4 4.5 GX S/W Dies. 5-Spd. Man., 4-Spd. Auto., 4.7 VX S/W V8 Petrol (03-08), (UZJ100) 4X4 (1HD-FTE) 4.2 VX TD S/W, GX DSL S/W, P/up S/W AHC Dies. 4/5-Spd. Auto. (04-08), (UZJ105) 4X4 4.5 GX S/W Dies. 5-Spd. Man., 4-Spd. Auto., 4.7 VX S/W V8 Petrol (03-08), 100-Series 4X4 4.0 GX DSL S/W, VX S/W Pet. 5-Spd. Man., Auto. (98-06)</p>
	<p>AR7654 Front Stabilizer Bar Bush</p> <p>Toyota Land Cruiser (FZJ105) 4X4 4.5 GX S/W Dies. 5-Spd. Man., 4-Spd. Auto., 4.7 VX S/W V8 Petrol (03-08), (UZJ100) 4X4 (1HD-FTE) 4.2 VX TD S/W, GX DSL S/W, P/up S/W AHC Dies. 4/5-Spd. Auto. (04-08), (UZJ105) 4X4 4.5 GX S/W Dies. 5-Spd. Man., 4-Spd. Auto., 4.7 VX S/W V8 Petrol (03-08), Prado 120 4X4 (1KZ-TE) 3.0TD, VX S/W Dies., 5-Spd. Man., 4-Spd. Auto., (1GR-FE) 4.0 GX, VX S/W 4-Spd. Auto. Pet. (02-09), Prado 150 4X4 (1KD-FTV) 3.0D VX, TX S/W 4-Spd. Auto., Dies., (1GR-FE) 4.0 TX, VX S/W 4-Spd. Auto. Pet. (2010-), 100-Series 4X4 4.0 GX DSL S/W, VX S/W Pet. 5-Spd. Man., Auto. (98-06)</p>
	<p>AR7662 Rear Lateral Link Bush</p> <p>Toyota Land Cruiser (FZJ105) 4X4 4.5 GX S/W Dies. 5-Spd. Man., 4-Spd. Auto., 4.7 VX S/W V8 Petrol (03-08), (UZJ100) 4X4 (1HD-FTE) 4.2 VX TD S/W, GX DSL S/W, P/up S/W AHC Dies. 4/5-Spd. Auto. (04-08), (UZJ105) 4X4 4.5 GX S/W Dies. 5-Spd. Man., 4-Spd. Auto., 4.7 VX S/W V8 Petrol (03-08), Prado 120 4X4 (1KZ-TE) 3.0TD, VX S/W Dies., 5-Spd. Man., 4-Spd. Auto., (1GR-FE) 4.0 GX, VX S/W 4-Spd. Auto. Pet. (02-09), 100-Series 4X4 4.0 GX DSL S/W, VX S/W Pet. 5-Spd. Man., Auto. (98-06)</p>
	<p>AR7663 Rear Lateral Link Bush</p> <p>Toyota Land Cruiser (FZJ105) 4X4 4.5 GX S/W Dies. 5-Spd. Man., 4-Spd. Auto., 4.7 VX S/W V8 Petrol (03-08), (UZJ100) 4X4 (1HD-FTE) 4.2 VX TD S/W, GX DSL S/W, P/up S/W AHC Dies. 4/5-Spd. Auto. (04-08), (UZJ105) 4X4 4.5 GX S/W Dies. 5-Spd. Man., 4-Spd. Auto., 4.7 VX S/W V8 Petrol (03-08), Prado 120 4X4 (1KZ-TE) 3.0TD, VX S/W Dies., 5-Spd. Man., 4-Spd. Auto., (1GR-FE) 4.0 GX, VX S/W 4-Spd. Auto. Pet. (02-09), 100-Series 4X4 4.0 GX DSL S/W, VX S/W Pet. 5-Spd. Man., Auto. (98-06)</p>

	<p>AR7664 Rear Trailing Link Bush</p> <p>Toyota Land Cruiser (FZJ105) 4X4 4.5 GX S/W Dies. 5-Spd. Man., 4-Spd. Auto., 4.7 VX S/W V8 Petrol (03-08), (UZJ100) 4X4 (1HD-FTE) 4.2 VX TD S/W, GX DSL S/W, P/up S/W AHC Dies. 4/5-Spd. Auto. (04-08), (UZJ105) 4X4 4.5 GX S/W Dies. 5-Spd. Man., 4-Spd. Auto., 4.7 VX S/W V8 Petrol (03-08), Prado 120 4X4 (1KZ-TE) 3.0TD, VX S/W Dies., 5-Spd. Man., 4-Spd. Auto., (1GR-FE) 4.0 GX, VX S/W 4-Spd. Auto. Pet. (02-09), 100-Series 4X4 4.0 GX DSL S/W, VX S/W Pet. 5-Spd. Man., Auto. (98-06)</p>
	<p>AR7665 Engine Mounting - RHS</p> <p>Toyota RAV4 II (A/ZCA20) 4X2 (1ZZ-FE) 1.8 SUV Pet. 5-Spd. Man. (02-06)</p>
	<p>AR7666 Engine Mounting - Rear</p> <p>Toyota RAV4 II (A/ZCA20) 4X2 (1ZZ-FE) 1.8 SUV Pet. 5-Spd. Man. (02-06)</p>
	<p>AR7667 Engine Mounting - LHS</p> <p>Toyota RAV4 II (A/ZCA20) 4X2 (1ZZ-FE) 1.8 SUV Pet. 5-Spd. Man. (02-06)</p>
	<p>AR7668 Engine Mounting - Front</p> <p>Toyota RAV4 II (A/ZCA20) 4X2 (1ZZ-FE) 1.8 SUV Pet. 5-Spd. Man., RAV4 II (A/ZCA20) 4X4 (1AZ-FE) 2.0 SUV 5-Spd. Man., 4-Spd. Auto. (02-06)</p>
	<p>AR7669 Engine Mounting - RHS</p> <p>Toyota RAV4 II (A/ZCA20) 4X4 (1AZ-FE) 2.0 SUV 5-Spd. Man., 4-Spd. Auto. (02-06)</p>
	<p>AR7670 Engine Mounting - Rear</p> <p>Toyota RAV4 II (A/ZCA20) 4X4 (1AZ-FE) 2.0 SUV 5-Spd. Man., 4-Spd. Auto. (02-06)</p>
	<p>AR7671 Engine Mounting - LHS</p> <p>Toyota RAV4 II (A/ZCA20) 4X4 (1AZ-FE) 2.0 SUV 5-Spd. Man., 4-Spd. Auto. (02-06)</p>
 <p>ID: 22, L: 32, H: 41, W: 44</p>	<p>AR7672 Front Stabilizer Bar Bush</p> <p>Toyota RAV4 II (A/ZCA20) 4X2 (1ZZ-FE) 1.8 SUV Pet. 5-Spd. Man., RAV4 II (A/ZCA20) 4X4 (1AZ-FE) 2.0 SUV 5-Spd. Man., 4-Spd. Auto. (02-06)</p>
	<p>AR7673 Steering Coupling</p> <p>Toyota RAV4 II (A/ZCA20) 4X2 (1ZZ-FE) 1.8 SUV Pet. 5-Spd. Man., RAV4 II (A/ZCA20) 4X4 (1AZ-FE) 2.0 SUV 5-Spd. Man., 4-Spd. Auto. (02-06)</p>
	<p>AR7674 Steering Rack Mounting - LHS</p> <p>Toyota RAV4 II (A/ZCA20) 4X2 (1ZZ-FE) 1.8 SUV Pet. 5-Spd. Man., RAV4 II (A/ZCA20) 4X4 (1AZ-FE) 2.0 SUV 5-Spd. Man., 4-Spd. Auto. (02-06)</p>
	<p>AR7675 Steering Rack Mounting - RHS</p> <p>Toyota RAV4 II (A/ZCA20) 4X2 (1ZZ-FE) 1.8 SUV Pet. 5-Spd. Man., RAV4 II (A/ZCA20) 4X4 (1AZ-FE) 2.0 SUV 5-Spd. Man., 4-Spd. Auto. (02-06)</p>













ENGINE MOUNTING & RUBBER BUYERS GUIDE

	AR7676 Engine Mounting - RHS Toyota Avanza (3SZ-VE) 1.5 SX, TX MPV (06-12)		AR7696 Engine Mounting - Front Hyundai Elantra (J2) (G4GR) 1.6 GL S/W, GLi, GLS, (G4FG) 1.8 GL, GL S/W, GLS, (G4GC) 2.0 (95-01)
	AR7677 Front Stabilizer Link Assembly Toyota RAV4 II (A/ZCA20) 4X2 (1ZZ-FE) 1.8 SUV Pet. 5-Spd. Man., RAV4 II (A/ZCA20) 4X4 (1AZ-FE) 2.0 SUV 5-Spd. Man., 4-Spd. Auto. (02-06)		AR7697 Engine Mounting - Front Hyundai Accent (G4EH) 1.3 XS, LS, (G4EK) 1.5 CSI, RSi, LS (96-01), S-Coupe (4GDM, G4EK-T) 1.5 GT, LS (94-95)
	AR7678 Rear Lower Control Arm Bush - Inner Toyota RAV4 II (A/ZCA20) 4X2 (1ZZ-FE) 1.8 SUV Pet. 5-Spd. Man., RAV4 II (A/ZCA20) 4X4 (1AZ-FE) 2.0 SUV 5-Spd. Man., 4-Spd. Auto. (02-06)		AR7698 Engine Mounting - Front Hyundai Accent (G4EH) 1.3 XS, LS, (G4EK) 1.5 CSI, RSi, LS (96-01), S-Coupe (4GDM, G4EK-T) 1.5 GT, LS (94-95)
	AR7683 Rear Upper Lateral Link Toyota RAV4 II (A/ZCA20) 4X2 (1ZZ-FE) 1.8 SUV Pet. 5-Spd. Man., RAV4 II (A/ZCA20) 4X4 (1AZ-FE) 2.0 SUV 5-Spd. Man., 4-Spd. Auto. (02-06)		AR7699 Engine Mounting - Front Hyundai Sonata (G4JP) 2.0 GL, GLS (94-95)
	AR7684 Rear Lower Lateral Link - LHS Toyota RAV4 II (A/ZCA20) 4X2 (1ZZ-FE) 1.8 SUV Pet. 5-Spd. Man., RAV4 II (A/ZCA20) 4X4 (1AZ-FE) 2.0 SUV 5-Spd. Man., 4-Spd. Auto. (02-06)		AR7700 Engine Mounting - RHS Hyundai Sonata (G6BV) 2.5 V6, Vivante (98-05)
	AR7685 Rear Lower Lateral Link - RHS Toyota RAV4 II (A/ZCA20) 4X2 (1ZZ-FE) 1.8 SUV Pet. 5-Spd. Man., RAV4 II (A/ZCA20) 4X4 (1AZ-FE) 2.0 SUV 5-Spd. Man., 4-Spd. Auto. (02-06)		AR7701 Engine Mounting - Front Hyundai Getz (G4EA) 1.3, (G4EE) 1.4i HS, (D3EA) 1.5 CRDi, HS, (G4ED-G) 1.6, HS (03-12)
	AR7686 Centre Bearing Rubber Toyota RAV4 II (A/ZCA20) 4X2 (1ZZ-FE) 1.8 SUV Pet. 5-Spd. Man., RAV4 II (A/ZCA20) 4X4 (1AZ-FE) 2.0 SUV 5-Spd. Man., 4-Spd. Auto. (02-06)		AR7702 Engine Mounting - RHS Hyundai Santa Fe 2.4 Man. (03-04)
	AR7687 Engine Mounting - LHS Toyota Avanza (3SZ-VE) 1.5 SX, TX MPV (06-12)		AR7704 Engine Mounting - RHS Hyundai Elantra (XD) (G4ED) 1.6 GL, GLS Pet., (G4GC) 2.0 GLS, GLS S/W Pet., 2.0 CRDi GLS Dies. (00-06), Tiburon (G4DF) 2.0, (G6BA-G) 2.7 V6 DOHC (03-07)
	AR7688 Transmission Mounting Toyota Avanza 1.3 P/van, (K3-VE) 1.3 S, SX MPV, (3SZ-VE) 1.5 SX, TX MPV (06-12), (K3-VE) 1.3 S P/van, (K3-VE) 1.3 S, SX MPV, (3SZ-VE) 1.5 SX, TX MPV (12-16)		AR7705 Front Strut Mounting Hyundai Accent (G4EK) 1.5 CSI, RSi, LS (96-01), (G4EH) 1.3 LS, (G4EK) 1.5 LS (00-03), (G4EH) 1.3 LS, (G4EK) 1.5 LS, (G4ED) 1.6 GLS, HS, SR Sport (03-06), Getz (G4EA) 1.3, (G4EE) 1.4i HS, (D3EA) 1.5 CRDi, HS, (G4ED-G) 1.6, HS (03-12), S-Coupe (4GDM, G4EK-T) 1.5 GT, LS (94-95)
	AR7689 Front Stabilizer Bar Bush Toyota Avanza 1.3 P/van, (K3-VE) 1.3 S, SX MPV, (3SZ-VE) 1.5 SX, TX MPV (06-12)		AR7706 Front Strut Mounting Hyundai Elantra (J1) (G4CN) 1.8 GLi, Exec (93-95), Elantra (J2) (G4GR) 1.6 GL S/W, GLi, GLS, (G4FG) 1.8 GL, GL S/W, GLS, (G4GC) 2.0 (95-01), Elantra (XD) (G4ED) 1.6 GL, GLS Pet., (G4GC) 2.0 GLS, GLS S/W Pet., 2.0 CRDi GLS Dies. (00-06), Matrix (G4ED-G) 1.6, (G4GB-G) 1.8 (02-07), Tiburon (G4DF) 2.0 (95-03), (G4DF) 2.0, (G6BA-G) 2.7 V6 DOHC (03-07)
	AR7693 Engine Mounting - Front Hyundai Elantra (J1) (G4CN) 1.8 GLi, Exec (93-95)		AR7707 Front Strut Mounting Hyundai Sonata (G4JP) 2.0 GL, GLS (94-99)
	AR7694 Engine Mounting - Front Hyundai Elantra (J1) (G4GR) 1.6 GLS, Exec (93-95)		AR7708 Engine Mounting - Rear Hyundai Getz (G4EA) 1.3 Man., (G4EE) 1.4i HS Man., (D3EA) 1.5 CRDi, HS Man., (G4ED-G) 1.6, HS Man. (03-12)
	AR7695 Engine Mounting - Front Hyundai Elantra (J2) (G4GR) 1.6 GL S/W, GLi, GLS, (G4FG) 1.8 GL, GL S/W, GLS, (G4GC) 2.0 (95-01), Tiburon (G4DF) 2.0 (95-03)		AR7709 Engine Mounting - Rear Hyundai Accent (G4EH) 1.3 XS, LS, (G4EK) 1.5 CSI, RSi, LS (96-01), S-Coupe (4GDM, G4EK-T) 1.5 GT, LS (94-95)







ENGINE MOUNTING & RUBBER BUYERS GUIDE

315

	AR7710 Engine Mounting - Rear Hyundai Getz (G4EA) 1.3 Auto., (G4EE) 1.4i HS Auto., (D3EA) 1.5 CRDi, HS Auto., (G4ED-G) 1.6, HS Auto. (03-12)
	AR7711 Transmission Mounting Hyundai Accent (G4EH) 1.3 XS, LS, (G4EK) 1.5 CSi, RSi, LS (94-96) - SOHC, Man. Models, S-Coupe (4GDM, G4EK/-T) 1.5 GT, LS (94-95)
	AR7712 Transmission Mounting Hyundai Accent (G4EH) 1.3 XS, LS, (G4EK) 1.5 CSi, RSi, LS (94-96) - SOHC, Auto. Models
	AR7713 Transmission Mounting Hyundai Accent (G4EH) 1.3 XS, LS, (G4EK) 1.5 CSi, RSi, LS (96-00) - DOHC, Auto. Models
	AR7715 Transmission Mounting (Insert for AR8395) Hyundai Getz (G4EA) 1.3, (G4EE) 1.4i HS, (D3EA) 1.5 CRDi, HS, (G4ED-G) 1.6, HS (03-12)
 ID: 18.5, L: 56, H: 57, W: 59	AR7716 Front Lower Control Arm Bush - Outer Rear Hyundai Accent (G4EH) 1.3 XS, LS, (G4EK) 1.5 CSi, RSi, LS (96-01), S-Coupe (4GDM, G4EK/-T) 1.5 GT, LS (94-95)
 ID: 12.7, OD: 38, L: 56	AR7717 Front Lower Control Arm Bush - Inner Front Hyundai Accent (G4EH) 1.3 XS, LS, (G4EK) 1.5 CSi, RSi, LS (96-01), S-Coupe (4GDM, G4EK/-T) 1.5 GT, LS (94-95)
 ID: 20, L: 30, H: 33, W: 34	AR7718 Front Stabilizer Bar Bush Hyundai Accent (G4EH) 1.3 XS, LS, (G4EK) 1.5 CSi, RSi, LS (96-01), S-Coupe (4GDM, G4EK/-T) 1.5 GT, LS (94-95)
	AR7719 Steering Rack Mounting - LHS Hyundai Accent (G4EH) 1.3 XS, LS, (G4EK) 1.5 CSi, RSi, LS (96-01), S-Coupe (4GDM, G4EK/-T) 1.5 GT, LS (94-95)
	AR7720 Steering Rack Mounting - RHS Hyundai Accent (G4EH) 1.3 XS, LS, (G4EK) 1.5 CSi, RSi, LS (96-01), S-Coupe (4GDM, G4EK/-T) 1.5 GT, LS (94-95)
	AR7722 Rear Lateral Link - Front Hyundai Accent (G4EH) 1.3 XS, LS, (G4EK) 1.5 CSi, RSi, LS (96-01), S-Coupe (4GDM, G4EK/-T) 1.5 GT, LS (94-95)
	AR7723 Rear Lateral Link - Rear Hyundai Accent (G4EH) 1.3 XS, LS, (G4EK) 1.5 CSi, RSi, LS (96-01), S-Coupe (4GDM, G4EK/-T) 1.5 GT, LS (94-95)

	AR7724 Rear Lateral Link Bush - Front Hyundai Accent (G4EH) 1.3 XS, LS, (G4EK) 1.5 CSi, RSi, LS (96-01), S-Coupe (4GDM, G4EK/-T) 1.5 GT, LS (94-95)
	AR7725 Rear Trailing Link - LHS Hyundai Accent (G4EH) 1.3 XS, LS, (G4EK) 1.5 CSi, RSi, LS (96-01), S-Coupe (4GDM, G4EK/-T) 1.5 GT, LS (94-95)
	AR7726 Rear Trailing Link - RHS Hyundai Accent (G4EH) 1.3 XS, LS, (G4EK) 1.5 CSi, RSi, LS (96-01), S-Coupe (4GDM, G4EK/-T) 1.5 GT, LS (94-95)
 ID: 12, OD: 40, L: 49	AR7727 Rear Trailing Link Bush - Rear Hyundai Accent (G4EH) 1.3 XS, LS, (G4EK) 1.5 CSi, RSi, LS (96-01), S-Coupe (4GDM, G4EK/-T) 1.5 GT, LS (94-95)
	AR7728 Engine Mounting - Rear Hyundai Accent (G4EH) 1.3 LS, (G4EK) 1.5 LS (00-03), (G4EH) 1.3 LS, (G4EK) 1.5 LS, (G4ED) 1.6 GLS, HS, SR Sport (03-06)
	AR7729 Engine Mounting - LHS Hyundai Accent (G4EH) 1.3 LS, (G4EK) 1.5 LS (00-03), (G4EH) 1.3 LS, (G4EK) 1.5 LS, (G4ED) 1.6 GLS, HS, SR Sport (03-06)
	AR7730 Exhaust Hanger - Middle, Rear Hyundai Getz (G4EA) 1.3, (G4EE) 1.4i HS, (D3EA) 1.5 CRDi, HS, (G4ED-G) 1.6, HS (03-12)
	AR7732 Front Lower Control Arm Bush - Outer Rear Hyundai Accent (G4EH) 1.3 LS, (G4EK) 1.5 LS (00-03), (G4EH) 1.3 LS, (G4EK) 1.5 LS, (G4ED) 1.6 GLS, HS, SR Sport (03-06), (G4ED) 1.6 GLS, HS, (G4FC) 1.6 (2006-)
 ID: 18	AR7733 Front Stabilizer Bar Bush Hyundai Accent (G4EH) 1.3 LS, (G4EK) 1.5 LS (00-03), (G4EH) 1.3 LS, (G4EK) 1.5 LS, (G4ED) 1.6 GLS, HS, SR Sport (03-06)
	AR7734 Steering Rack Mounting - L/RHS Hyundai Accent (G4EH) 1.3 LS, (G4EK) 1.5 LS (00-03)
	AR7735 Rear Stabilizer Bar Bush Hyundai Accent (G4EH) 1.3 LS, (G4EK) 1.5 LS (00-03), (G4EH) 1.3 LS, (G4EK) 1.5 LS, (G4ED) 1.6 GLS, HS, SR Sport (03-06)
 ID: 13/15, L: 446	AR7736 Rear Lateral Link - Front LHS Hyundai Accent (G4EH) 1.3 LS, (G4EK) 1.5 LS (00-03)

ENGINE MOUNTING & RUBBER BUYERS GUIDE

 ID: 13/15, L: 446	AR7737 Rear Lateral Link - Front RHS Hyundai Accent (G4EH) 1.3 LS, (G4EK) 1.5 LS (00-03)	 ID: 12.5, OD: 36, L: 60	AR7751 Front Lower Control Arm Bush - Inner Front Hyundai Elantra (J1) (G4GR) 1.6 GLS, Exec, (G4CN) 1.8 GLi, Exec (93-95)
 ID: 13/15, L: 446	AR7738 Rear Lateral Link - Front RHS Hyundai Accent (G4EH) 1.3 LS, (G4EK) 1.5 LS (00-03)		AR7752 Front Lower Control Arm Bush - Outer Rear Hyundai Elantra (J1) (G4GR) 1.6 GLS, Exec, (G4CN) 1.8 GLi, Exec (93-95)
 ID: 13/15, L: 446	AR7739 Rear Lateral Link - Front LHS Hyundai Accent (G4EH) 1.3 LS, (G4EK) 1.5 LS (00-03)		AR7754 Front Stabilizer Bar Bush Hyundai Elantra (J1) (G4GR) 1.6 GLS, Exec, (G4CN) 1.8 GLi, Exec (93-95)
 ID: 12, OD: 30, L: 40	AR7740 Rear Trailing Link Bush - Outer Hyundai Accent (G4EH) 1.3 LS, (G4EK) 1.5 LS (00-03)		AR7755 Front Stabilizer Link Grommet Hyundai Elantra (J1) (G4GR) 1.6 GLS, Exec, (G4CN) 1.8 GLi, Exec (93-95)
 ID: 14, OD: 30, L: 39	AR7741 Rear Trailing Link Bush - Inner Hyundai Accent (G4EH) 1.3 LS, (G4EK) 1.5 LS (00-03)		AR7756 Rear Axle Beam Bush Hyundai Elantra (J1) (G4GR) 1.6 GLS, Exec, (G4CN) 1.8 GLi, Exec (93-95), Sonata (G4JP) 2.0 GL, GLS, (G6AT) 3.0 GLS V6 (96-99)
 ID: 14, OD: 30, L: 39	AR7742 Rear Trailing Link - RHS Hyundai Accent (G4EH) 1.3 LS, (G4EK) 1.5 LS (00-03)		AR7757 Rear Lateral Link Bush Hyundai Elantra (J1) (G4GR) 1.6 GLS, Exec, (G4CN) 1.8 GLi, Exec (93-95)
 ID: 14, OD: 30, L: 39	AR7744 Rear Trailing Link - LHS Hyundai Accent (G4EH) 1.3 LS, (G4EK) 1.5 LS (00-03)		AR7758 Rear Axle Support Bush - Inner Hyundai Elantra (J1) (G4GR) 1.6 GLS, Exec, (G4CN) 1.8 GLi, Exec (93-95)
 ID: 12.5, OD: 37, L: 50	AR7746 Rear Trailing Link Bush - Front Hyundai Accent (G4EH) 1.3 LS, (G4EK) 1.5 LS (00-03)	 NO PICTURE AVAILABLE AT TIME OF PRINT	AR7759 Rear Axle Support Bush - Outer Hyundai Elantra (J1) (G4GR) 1.6 GLS, Exec, (G4CN) 1.8 GLi, Exec (93-95)
 ID: 14, OD: 44, L: 55	AR7747 Rear Trailing Link Bush - Rear Hyundai Accent (G4EH) 1.3 LS, (G4EK) 1.5 LS (00-03)		AR7760 Engine Mounting - Rear Hyundai Elantra (J1) (G4CN) 1.8 GLi, Exec (93-95)
 ID: 14, OD: 44, L: 55	AR7748 Engine Mounting - Rear Hyundai Elantra (J1) (G4GR) 1.6 GLS, Exec (93-95)		AR7761 Engine Mounting - RHS Hyundai Elantra (J1) (G4GR) 1.6 GLS, Exec, (G4CN) 1.8 GLi, Exec (93-95), Elantra (J2) (G4GR) 1.6 GL S/W, GLi, GLS, (G4FG) 1.8 GL, GL S/W, GLS, (G4GC) 2.0 (95-01)
 ID: 14, OD: 44, L: 55	AR7749 Engine Mounting - L/RHS Hyundai Elantra (J1) (G4GR) 1.6 GLS, Exec (93-95), Elantra (J2) (G4GR) 1.6 GL S/W, GLi, GLS, (G4FG) 1.8 GL, GL S/W, GLS, (G4GC) 2.0 (95-01), Tiburon (G4DF) 2.0 (95-03)		AR7762 Engine Mounting - LHS Hyundai Elantra (J1) (G4CN) 1.8 GLi, Exec (93-95)
 ID: 14, OD: 44, L: 55	AR7750 Transmission Mounting Hyundai Elantra (J1) (G4GR) 1.6 GLS, Exec (93-95)		AR7765 Transmission Mounting Hyundai Elantra (J1) (G4CN) 1.8 GLi, Exec (93-95)
			AR7766 Engine Mounting - Rear Hyundai Elantra (J2) (G4GR) 1.6 GL S/W, GLi, GLS, (G4FG) 1.8 GL, GL S/W, GLS, (G4GC) 2.0 (95-98), Tiburon (G4DF) 2.0 (95-03)

ENGINE MOUNTING & RUBBER BUYERS GUIDE

317

	AR7767 Engine Mounting - Rear Hyundai Elantra (J2) (G4GR) 1.6 GL S/W, GLi, GLS, (G4FG) 1.8 GL, GL S/W, GLS, (G4GC) 2.0 (98-01)		AR7789 Transmission Mounting Hyundai Elantra (XD) (G4ED) 1.6 GL, GLS Pet. Auto., (G4GC) 2.0 GLS, GLS S/W Pet. Auto., 2.0 CRDi GLS Dies. Auto. (00-06)
	AR7770 Transmission Mounting Hyundai Elantra (J2) (G4GR) 1.6 GL S/W, GLi, GLS, (G4FG) 1.8 GL, GL S/W, GLS, (G4GC) 2.0 (95-01), Tiburon (G4DF) 2.0 (95-03)		AR7790 Transmission Mounting Hyundai Elantra (XD) (G4ED) 1.6 GL, GLS Pet. Man., (G4GC) 2.0 GLS, GLS S/W Pet. Man., 2.0 CRDi GLS Dies. Man. (00-06)
 ID: 12, OD: 35.5, L: 60	AR7772 Front Lower Control Arm Bush - Inner Front Hyundai Elantra (J2) (G4GR) 1.6 GL S/W, GLi, GLS, (G4FG) 1.8 GL, GL S/W, GLS, (G4GC) 2.0 (95-01), Tiburon (G4DF) 2.0 (95-03)		AR7791 Front Lower Control Arm Bush - Inner Front Hyundai Elantra (XD) (G4ED) 1.6 GL, GLS Pet., (G4GC) 2.0 GLS, GLS S/W Pet., 2.0 CRDi GLS Dies. (00-06), Elantra (HD) 1.6 GLS, (G4GC) 2.0 GLS (07-11), Tiburon (G4DF) 2.0 (00-03), (G4DF) 2.0, (G6BA-G) 2.7 V6 DOHC (03-07); Kia Cerato (G4FC) 1.6 LX, 2.0 CRDi (04-08)
 ID: 18, OD: 50, L: 55	AR7773L Front Lower Control Arm Bush - Rear LHS Hyundai Elantra (J2) (G4GR) 1.6 GL S/W, GLi, GLS, (G4FG) 1.8 GL, GL S/W, GLS, (G4GC) 2.0 (95-01), Tiburon (G4DF) 2.0 (95-03)	 ID: 14, OD: 60, L: 55	AR7792 Front Lower Control Arm Bush - Outer Rear Hyundai Elantra (XD) (G4ED) 1.6 GL, GLS Pet., (G4GC) 2.0 GLS, GLS S/W Pet., 2.0 CRDi GLS Dies. (00-06), Elantra (HD) 1.6 GLS, (G4GC) 2.0 GLS (07-11), Sonata (G6BA-G) 2.7 V6 (03-05), Tiburon (G4DF) 2.0, (G6BA-G) 2.7 V6 DOHC (03-07)
 ID: 18, OD: 50, L: 55	AR7773R Front Lower Control Arm Bush - Rear RHS Hyundai Elantra (J2) (G4GR) 1.6 GL S/W, GLi, GLS, (G4FG) 1.8 GL, GL S/W, GLS, (G4GC) 2.0 (95-01), Tiburon (G4DF) 2.0 (95-03)		AR7793 Front Stabilizer Bar Bush Hyundai Elantra (XD) (G4ED) 1.6 GL, GLS Pet., (G4GC) 2.0 GLS, GLS S/W Pet., 2.0 CRDi GLS Dies. (00-06), Sonata (G6BA-G) 2.7 V6 (03-05), Tiburon (G4DF) 2.0 (00-03), (G4DF) 2.0, (G6BA-G) 2.7 V6 DOHC (03-07)
 ID: 23, L: 31, H: 39, W: 44	AR7774 Front Stabilizer Bar Bush Hyundai Elantra (J2) (G4GR) 1.6 GL S/W, GLi, GLS, (G4FG) 1.8 GL, GL S/W, GLS, (G4GC) 2.0 (95-98), Tiburon (G4DF) 2.0 (95-03)		AR7795 Engine Mounting - LHS Hyundai Sonata (G4JP) 2.0 GL, GLS (94-97)
	AR7777 Rear Stabilizer Bar Bush Hyundai Elantra (HD) 1.6 GLS, (G4GC) 2.0 GLS (07-11)		AR7797 Engine Mounting - Rear Hyundai Sonata (G4JP) 2.0 GL, GLS Auto. (94-95)
	AR7780 Rear Lateral Link Bush - Front Hyundai Elantra (J2) (G4GR) 1.6 GL S/W, GLi, GLS, (G4FG) 1.8 GL, GL S/W, GLS, (G4GC) 2.0 (97-01), Elantra (XD) (G4ED) 1.6 GL, GLS Pet., (G4GC) 2.0 GLS, GLS S/W Pet., 2.0 CRDi GLS Dies. (00-06), Tiburon (G4DF) 2.0 (00-03)		AR7798 Engine Mounting - Rear Hyundai Sonata (G4JP) 2.0 GL, GLS Man. (94-95)
	AR7781 Rear Lateral Link Bush - Rear Hyundai Elantra (J2) (G4GR) 1.6 GL S/W, GLi, GLS, (G4FG) 1.8 GL, GL S/W, GLS, (G4GC) 2.0 (97-01), Elantra (XD) (G4ED) 1.6 GL, GLS Pet., (G4GC) 2.0 GLS, GLS S/W Pet., 2.0 CRDi GLS Dies. (00-06), Tiburon (G4DF) 2.0 (00-03)		AR7799 Transmission Mounting Hyundai Sonata (G4JP) 2.0 GL, GLS Man. (94-95)
	AR7782 Rear Trailing Link Bush Hyundai Elantra (J2) (G4GR) 1.6 GL S/W, GLi, GLS, (G4FG) 1.8 GL, GL S/W, GLS, (G4GC) 2.0 (97-01), Elantra (XD) (G4ED) 1.6 GL, GLS Pet., (G4GC) 2.0 GLS, GLS S/W Pet., 2.0 CRDi GLS Dies. (00-06), Sonata (G6BA-G) 2.7 V6 (96-05), Tiburon (G4DF) 2.0 (00-03), (G4DF) 2.0, (G6BA-G) 2.7 V6 DOHC (03-07)		AR7800 Transmission Mounting Hyundai Sonata (G4JP) 2.0 GL, GLS Auto. (94-95)
	AR7783 Engine Mounting - Front Hyundai Elantra (XD) (G4ED) 1.6 GL, GLS Pet., (G4GC) 2.0 GLS, GLS S/W Pet., 2.0 CRDi GLS Dies. (00-06)		AR7805 Front Lower Control Arm Bush - Inner Front Hyundai Sonata (G4JP) 2.0 GL, GLS, (G6AT) 3.0 GLS V6 (94-99)
	AR7785 Engine Mounting - Rear Hyundai Elantra (XD) (G4ED) 1.6 GL, GLS Pet., (G4GC) 2.0 GLS, GLS S/W Pet., 2.0 CRDi GLS Dies. (00-06), Tiburon (G4DF) 2.0, (G6BA-G) 2.7 V6 DOHC (03-07)		AR7806L Front Lower Control Arm Bush - Outer Rear LHS Hyundai Sonata (G4JP) 2.0 GL, GLS, (G6AT) 3.0 GLS V6 (94-99)

ENGINE MOUNTING & RUBBER BUYERS GUIDE

	AR7806R Front Lower Control Arm Bush - Outer Rear RHS Hyundai Sonata (G4JP) 2.0 GL, GLS, (G6AT) 3.0 GLS V6 (94-99)		AR7819 Engine Mounting - Rear Hyundai Sonata (G4JP) 2.0 GL, GLS Man. (96-99)
	AR7807 Front Stabilizer Bar Bush Hyundai Sonata (G4JP) 2.0 GL, GLS, (G6AT) 3.0 GLS V6 (94-95)		AR7821 Engine Mounting - LHS Hyundai Sonata (G4JP) 2.0 GL, GLS (97-99)
	AR7808 Rear Axle Support Bush - Inner Hyundai Sonata (G4JP) 2.0 GL, GLS, (G6AT) 3.0 GLS V6 (94-95)		AR7824 Transmission Mounting Hyundai Sonata (G4JP) 2.0 GL, GLS Man. (96-99)
	AR7809 Rear Axle Support Bush - Outer Hyundai Sonata (G4JP) 2.0 GL, GLS, (G6AT) 3.0 GLS V6 (94-95)		AR7825 Transmission Mounting Hyundai Sonata (G4JP) 2.0 GL, GLS Man. (97-99)
	AR7810 Rear Lateral Link Hyundai Sonata (G4JP) 2.0 GL, GLS, (G6AT) 3.0 GLS V6 (94-95) NO PICTURE AVAILABLE AT TIME OF PRINT		AR7826 Transmission Mounting Hyundai Sonata (G4JP) 2.0 GL, GLS Auto. (96-97)
	AR7811 Rear Lateral Link Bush Hyundai Sonata (G4JP) 2.0 GL, GLS, (G6AT) 3.0 GLS V6 (94-95) NO PICTURE AVAILABLE AT TIME OF PRINT		AR7835 Front Stabilizer Bar Bush Hyundai Sonata (G4JP) 2.0 GL, GLS, (G6AT) 3.0 GLS V6 (96-99) ID: 22, L: 35, H: 32, W: 37
	AR7812 Rear Axle Beam Bush Hyundai Sonata (G4JP) 2.0 GL, GLS, (G6AT) 3.0 GLS V6 (94-95)		AR7836 Front Stabilizer Bar Bush Hyundai Sonata (G4JP) 2.0 GL, GLS, (G6AT) 3.0 GLS V6 (96-99) ID: 20, L: 38, H: 33, W: 38
	AR7813 Engine Mounting - Front Hyundai Sonata (G4JP) 2.0 GL, GLS Man. (96-97)		AR7837 Steering Rack Mounting - L/RHS Hyundai Sonata (G4JP) 2.0 GL, GLS, (G6AT) 3.0 GLS V6 (94-99) NO PICTURE AVAILABLE AT TIME OF PRINT
	AR7814 Engine Mounting - Front Hyundai Sonata (G4JP) 2.0 GL, GLS Man. (97-99)		AR7838 Front Lateral Link Hyundai Sonata (G4JP) 2.0 GL, GLS, (G6AT) 3.0 GLS V6 (96-99)
	AR7815 Engine Mounting - Front Hyundai Sonata (G4JP) 2.0 GL, GLS Auto. (96-97)		AR7839 Rear Lateral Link Bush - Front Hyundai Sonata (G4JP) 2.0 GL, GLS, (G6AT) 3.0 GLS V6 (96-99) ID: 14, OD: 40, L: 50
	AR7816 Engine Mounting - Front Hyundai Sonata (G4JP) 2.0 GL, GLS Auto. (97-99)		AR7840 Rear Subframe Bush Hyundai Sonata (G4JP) 2.0 GL, GLS, (G6AT) 3.0 GLS V6 (96-99)
	AR7817 Engine Mounting - Rear Hyundai Sonata (G4JP) 2.0 GL, GLS Man. (96-97)		AR7842 Rear Trailing Link Bush Hyundai Sonata (G4JP) 2.0 GL, GLS, (G6AT) 3.0 GLS V6 (96-99), Sonata (G4JP) 2.0 GLS, Allegro, (G6BV) 2.5 V6, Vivante (96-05) NO PICTURE AVAILABLE AT TIME OF PRINT
	AR7818 Engine Mounting - Rear Hyundai Sonata (G4JP) 2.0 GL, GLS Man. (97-99)		

ENGINE MOUNTING & RUBBER BUYERS GUIDE

319

	AR7843 Engine Mounting - RHS Hyundai Sonata (G4JP) 2.0 GLS, Allegro, (G6BV) 2.5 V6, Vivante (96-05)
	AR7844 Engine Mounting - RHS Hyundai Sonata (G4JP) 2.0 GLS, Allegro (04-05)
	AR7845 Engine Mounting - LHS Hyundai Sonata (G4JP) 2.0 GLS, Allegro Man., (G6BV) 2.5 Man. V6, Vivante (96-05)
	AR7847 Engine Mounting - LHS Hyundai Sonata (G4JP) 2.0 GLS, Allegro Auto., (G6BV) 2.5 Auto. V6, Vivante (96-05)
	AR7848 Front Lower Control Arm Bush - Inner Front Hyundai Accent (G4EH) 1.3 LS, (G4EK) 1.5 LS (00-03), (G4EH) 1.3 LS, (G4EK) 1.5 LS, (G4ED) 1.6 GLS, HS, SR Sport (03-06), (G4ED) 1.6 GLS, HS, (G4FC) 1.6 (2006-), Getz (G4EA) 1.3, (G4EE) 1.4i HS, (D3EA) 1.5 CRDi, HS, (G4ED-G) 1.6, HS (03-12), i10 (G4HG) 1.1 GLS, (G4LA) 1.2 GLS, GLS HS (2008-), Matrix (G4ED-G) 1.6, (G4GB-G) 1.8 (02-07); Kia Picanto (G4HG) 1.1 LX, EX Std. (04-11), Rio II (A5D) 1.4, (G4ED) 1.6 Sport (05-11)
	AR7849 Engine Mounting - Front Hyundai Sonata (G4JP) 2.0 GLS, Allegro, Man., (G6BV) 2.5 V6 Man., Vivante, (G6BA-G) 2.7 V6 Man. (98-05)
	AR7850 Engine Mounting - Front Hyundai Sonata (G4JP) 2.0 GLS, Allegro, Man., (G6BV) 2.5 V6 Man., Vivante, (G6BA-G) 2.7 V6 Man. (98-05)
	AR7851 Engine Mounting - Front Hyundai Sonata (G4JP) 2.0 GLS, Allegro, Auto., (G6BV) 2.5 V6 Auto., Vivante, (G6BA-G) 2.7 V6 Auto. (98-05)
	AR7852 Engine Mounting - Front Hyundai Sonata (G4JP) 2.0 GLS, Allegro, Auto., (G6BV) 2.5 V6 Auto., Vivante, (G6BA-G) 2.7 V6 Auto. (98-05)
	AR7853 Engine Mounting - Rear Hyundai Sonata (G4JP) 2.0 Allegro (96-05)
	AR7854 Engine Mounting - Rear Hyundai Sonata (G4JP) 2.0 GLS, Allegro, (G6BV) 2.5 V6, Vivante (96-05)
	AR7856 Transmission Mounting Hyundai Sonata (G4JP) 2.0 GLS, Allegro (96-05)

	AR7859 Engine Mounting - Front Hyundai Sonata (G6BV) 2.5 V6, Vivante (98-02)
	AR7860 Front Lower Control Arm Bush - Outer Rear Hyundai Elantra (MD / UD) (G4FG) 1.6, (G4NB) 1.8 (2011-), Tucson (G4GC) 2.0 GLS (04-11), Tucson 4X4 (D4EA) 2.0 CRDi, (G6BA-G) 2.7 V6 (04-10), Veloster (G4FD, G4FJ) 1.6 GDi (2013-); Kia Rio II (A5D) 1.4, (G4ED) 1.6 Sport (05-11), Sportage 4X2, 4X4 (G4GC) 2.0 SWB SUV, (D4EA) 2.0 CRDi SUV, (G6BA) 2.7 V6 SUV (05-10)
	AR7861 Front Upper Control Arm Bush - Inner & Outer Hyundai Sonata (G4JP) 2.0 GLS, Allegro, (G6BA-G) 2.7 V6 (96-05)
	AR7862 Front Lower Control Arm Bush - Inner, Front Outer Hyundai Sonata (G4JP) 2.0 GLS, Allegro, (G6BV) 2.5 V6, Vivante, (G6BA-G) 2.7 V6 (96-05)
	AR7863 Front Lower Control Arm Bush - Inner, Front Inner Hyundai Sonata (G4JP) 2.0 GLS, Allegro, (G6BV) 2.5 V6, Vivante, (G6BA-G) 2.7 V6 (96-05)
	AR7864 Front Lower Control Arm Bush - Outer Rear Hyundai Sonata (G4JP) 2.0 Allegro, (G6BV) 2.5 V6, Vivante (00-02)
	AR7865 Front Strut Mounting Hyundai Sonata (G4JP) 2.0 GLS, Allegro, (G6BV) 2.5 V6, Vivante, (G6BA-G) 2.7 V6 (96-05)
	AR7866 Front Stabilizer Bar Bush Hyundai Sonata (G4JP) 2.0 GLS, Allegro, (G6BV) 2.5 V6, Vivante (96-05)
	AR7867 Front Stabilizer Bar Bush Hyundai Sonata (G4JP) 2.0 Allegro, (G6BV) 2.5 V6, Vivante (96-05)
	AR7868 Front Stabilizer Bar Bush Hyundai Sonata (G4JP) 2.0 GLS, Allegro (04-05)
	AR7869 Front & Rear Stabilizer Link Grommet Hyundai Sonata (G4JP) 2.0 GLS, Allegro, (G6BV) 2.5 V6, Vivante, (G6BA-G) 2.7 V6 (96-05) (96-05)
	AR7870 Shock Rubber - Front Upper Hyundai Sonata (G4JP) 2.0 GLS, Allegro, (G6BV) 2.5 V6, Vivante, (G6BA-G) 2.7 V6 (96-05)

ENGINE MOUNTING & RUBBER

BUYERS GUIDE

	AR7871 Shock Rubber - Front Lower Hyundai Sonata (G4JP) 2.0 GLS, Allegro, (G6BV) 2.5 V6, Vivante, (G6BA-G) 2.7 V6 (96-05)		AR7890 Rear Trailing Link - RHS Hyundai Tiburon (G4DF) 2.0 (95-03)
	AR7872 Steering Rack Mounting - L/RHS Hyundai Sonata (G4JP) 2.0 GLS, Allegro, (G6BV) 2.5 V6, Vivante (96-05)		AR7891 Rear Trailing Link - LHS Hyundai Tiburon (G4DF) 2.0 (95-03)
	AR7873 Rear Assisting Link - Lower Hyundai Sonata (G4JP) 2.0 GLS, Allegro, (G6BV) 2.5 V6, Vivante (96-05)		AR7892 Rear Trailing Link - RHS Hyundai Tiburon (G4DF) 2.0 (95-03)
	AR7874 Rear Assisting Link Bush - Lower Hyundai Sonata (G4JP) 2.0 GLS, Allegro, (G6BV) 2.5 V6, Vivante (96-05)		AR7893 Engine Mounting - Front Hyundai Tiburon (G4DF) 2.0, (G6BA-G) 2.7 V6 DOHC (03-07)
	AR7875 Rear Upper Control Arm Bush - LHS Hyundai Sonata (G4JP) 2.0 GLS, Allegro, (G6BV) 2.5 V6, Vivante (96-05)		AR7895 Engine Mounting - LHS Hyundai Sonata (G6BA-G) 2.7 V6 (03-05)
	AR7876 Rear Upper Control Arm Bush - RHS Hyundai Sonata (G4JP) 2.0 GLS, Allegro, (G6BV) 2.5 V6, Vivante (96-05)		AR7896 Steering Rack Mounting - L/RHS Hyundai Sonata (G6BA-G) 2.7 V6 (03-05), Tiburon (G4DF) 2.0, (G6BA-G) 2.7 V6 DOHC (03-07)
	AR7878 Rear Axle "Knuckle" Bush Hyundai Sonata (G4JP) 2.0 GLS, Allegro, (G6BV) 2.5 V6, Vivante (96-05)		AR7899 Rear Lateral Link - Front Hyundai Sonata (G6BA-G) 2.7 V6 (96-05), Tiburon (G4DF) 2.0, (G6BA-G) 2.7 V6 DOHC (03-07)
	AR7882 Rear Assisting Link - Upper Hyundai Sonata (G4JP) 2.0 GLS, Allegro, (G6BV) 2.5 V6, Vivante (96-05)		AR7900 Rear Lateral Link - Rear Hyundai Sonata (G6BA-G) 2.7 V6 (96-05), Tiburon (G4DF) 2.0, (G6BA-G) 2.7 V6 DOHC (03-07)
	AR7883 Engine Mounting - Rear Hyundai Tiburon (G4DF) 2.0 Auto. (99-03)		AR7901 Rear Lateral Link Bush - Front Hyundai Sonata (G6BA-G) 2.7 V6 (96-05), Tiburon (G4DF) 2.0, (G6BA-G) 2.7 V6 DOHC (03-07)
	AR7884 Front Stabilizer Bar Bush Hyundai Tiburon (G4DF) 2.0 (95-03)		AR7902 Rear Lateral Link Bush - Rear Hyundai Sonata (G6BA-G) 2.7 V6 (96-05), Tiburon (G4DF) 2.0, (G6BA-G) 2.7 V6 DOHC (03-07)
	AR7887 Rear Lateral Link - Front Hyundai Tiburon (G4DF) 2.0 (95-03)		AR7903 Rear Trailing Link - LHS Hyundai Sonata (G6BA-G) 2.7 V6 (96-05), Tiburon (G4DF) 2.0, (G6BA-G) 2.7 V6 DOHC (03-07)
	AR7888 Rear Lateral Link - Rear Hyundai Tiburon (G4DF) 2.0 (95-03)		AR7904 Rear Trailing Link - RHS Hyundai Sonata (G6BA-G) 2.7 V6 (96-05), Tiburon (G4DF) 2.0, (G6BA-G) 2.7 V6 DOHC (03-07)
	AR7889 Rear Trailing Link - LHS Hyundai Tiburon (G4DF) 2.0 (95-03)		AR7905 Engine Mounting - Rear Hyundai Santa Fe' 4X4 (G4JS) 2.4 (01-06)

ENGINE MOUNTING & RUBBER BUYERS GUIDE

321

	AR7906 Engine Mounting - Rear Hyundai Santa Fe' 4X4 (G6BA-G, G6EA) 2.7 (01-06), Santa Fe' 4X4 (G6EA) 2.7 GLS (2006-)
	AR7907 Engine Mounting - Front Hyundai Santa Fe' 4X4 (G4JS) 2.4 (01-06)
	AR7908 Engine Mounting - Front Hyundai Santa Fe' 4X4 (G6BA-G, G6EA) 2.7 (01-06), Santa Fe' 4X4 (G6EA) 2.7 GLS (2006-)
	AR7909 Engine Mounting - LHS Hyundai Santa Fe' 4X4 (G4JS) 2.4 (01-06)
	AR7910 Engine Mounting - LHS Hyundai Santa Fe' 4X4 (G6BA-G, G6EA) 2.7 (01-06), Santa Fe' 4X4 (G6EA) 2.7 GLS (2006-)
	AR7911 Centre Bearing Rubber Hyundai Santa Fe' 4X4 (G4JS) 2.4, (G6BA-G, G6EA) 2.7 (01-06)
	AR7912 Centre Bearing Rubber Hyundai Santa Fe' 4X4 (G4JS) 2.4, (G6BA-G, G6EA) 2.7 (01-06)
	AR7913 Exhaust Hanger - Front, Middle, Rear Hyundai Santa Fe' 4X4 (G4JS) 2.4, (G6BA-G, G6EA) 2.7 (01-06)
	AR7914 Front Lower Control Arm Bush - Inner Hyundai Santa Fe' 4X4 (G4JS) 2.4, (G6BA-G, G6EA) 2.7 (01-06)
	AR7915 Front Lower Control Arm Bush - Outer Hyundai Santa Fe' 4X4 (G4JS) 2.4, (G6BA-G, G6EA) 2.7 (01-06)
	AR7916 Front Stabilizer Bar Bush Hyundai Santa Fe' 4X4 (G4JS) 2.4, (G6BA-G, G6EA) 2.7 (01-06)
	AR7917 Steering Rack Mounting - L/RHS Hyundai Santa Fe' 4X4 (G4JS) 2.4, (G6BA-G, G6EA) 2.7 (01-06)
	AR7918 Front Strut Mounting Hyundai Santa Fe' 4X4 (G4JS) 2.4, (G6BA-G, G6EA) 2.7 (01-06)











	AR7921 Rear Lower Control Arm Bush - Outer Hyundai Santa Fe' 4X4 (G4JS) 2.4, (G6BA-G, G6EA) 2.7 (01-06)
	AR7926 Rear Upper & Lower Lateral Link Bush - L/RHS Hyundai Santa Fe' 4X4 (G4JS) 2.4, (G6BA-G, G6EA) 2.7 (01-06)
	AR7996 Front Strut Mounting Audi A4 (8E2/5, B6) (BFB) 1.8T Avant, Multitronic, SW (00-08), A6 (CGLC, CMGM) 2.0 TDi 8-Spd. Diesel Auto., (CDNB) 2.0 FSi 8-Spd. Petrol Auto. (11-15)
	AR7997 Front Strut Mounting Audi A4 (8E2/5, B6) (AVF, AWX) 1.9 TDi Avant, (ALT) 2.0 Executive (BGB) 2.0 TFSi, (BLB) 2.0 TDi (00-08)
	AR7998 Engine Mounting - RHS Mazda 6 (GG) (LFF7) 2.0 Active, Original, Elegant, (L3C1) 2.3 Dynamic, Individual, Sporty, Sporty Lux (03-09)
	AR7999 Engine Mounting - LHS Mazda 6 (GG) (LFF7) 2.0 Active, Original, Elegant, (L3C1) 2.3 Dynamic, Individual, Sporty, Sporty Lux (03-09)

ENGINE MOUNTING & RUBBER BUYERS GUIDE

 ID: 12, OD: 40, L: 37	AR8000 Front Lower Control Arm Bush - Outer Front Audi A4 (8E2/5, B6) (BFB) 1.8T Avant, Multitronic, SW, (AVF, AWX) 1.9 TDi Avant, (ALT) 2.0 Executive (BGB) 2.0 TFSi, (BLB) 2.0 TDi (00-08), (CABA/B, CDHA/B, CJEB) 1.8 TFSi, (BRD, CAGA, CJCA, CMEA, CMFA) 2.0 TDi, (CABE, CDNC, CGLC, CMGB) 2.0 TFSi, (CDNC, CPMA) 2.0 TFSi Quattro (08-14)		AR8012 Engine Mounting - Rear Mazda 6 (GG) (LFF7) 2.0 Active, Original, Elegant, (L3C1) 2.3 Dynamic, Individual, Sporty, Sporty Lux (03-09)
 ID: 10, OD: 46.5, L: 40	AR8001 Front Upper Control Arm Bush - Inner Front & Rear Audi A4 / A5 (CAPA, CCWA, CDUC, CKVB) 3.0 TDi Quattro, S-Tronic, Tiptronic, A4 (CALA) 3.2 FSi Quattro S-Tronic, A5 (CMUA) 3.0 TFSi Quattro S-Tronic, (CALA) 3.2 FSi Quattro S-Tronic (08-14), A6 (AGA, ALF, AMC, APS, ARJ, BDV, BDW) 2.4, (ACK) 2.8 Avant Quattro, (ARS) 4.2 V8 Quattro, Tiptronic (97-05), (AJK, ARE, BES) 2.7T Quattro, (ASB) 3.0 TDi Quattro (00-09)	 ID: 29, OD: 25.5, L: 53	AR8013 Front Stabilizer Bar Bush Audi A4 (8E2/5, B6) (BFB) 1.8T Avant, Multitronic, SW, (AVF, AWX) 1.9 TDi Avant, (ALT) 2.0 Executive (BGB) 2.0 TFSi, (BLB) 2.0 TDi (00-08), A6 (BDX, CCEA) 2.8 FSi 7-Spd. Auto. (07-09), (BPJ) 2.0 TFSi 7-Spd. Auto. Pet., (BPP, CANA) 2.7 TDi 7-Spd. Auto., (CCEA) 2.8 FSi 7-Spd. Auto. (09-11)
	AR8002 Rear Lower Control Arm Bush - Inner Front Audi A4 (8E2/5, B6) (BFB) 1.8T Avant, Multitronic, SW, (AVF, AWX) 1.9 TDi Avant, (ALT) 2.0 Executive (BGB) 2.0 TFSi, (BLB) 2.0 TDi (00-08), (CABA/B, CDHA/B, CJEB) 1.8 TFSi, (BRD, CAGA, CJCA, CMEA, CMFA) 2.0 TDi, (CABE, CDNC, CGLC, CMGB) 2.0 TFSi, (CDNC, CPMA) 2.0 TFSi Quattro (08-14)		AR8015 Engine Carrier Bush - Rear Audi A4 (8D2, B5) (APU) 1.8T Avant, Multitronic, SW (95-01)
	AR8003 Rear Lower Control Arm Bush - Inner Front Audi A4 (8E2/5, B6) (BFB) 1.8T Avant, Multitronic, SW, (AVF, AWX) 1.9 TDi Avant, (ALT) 2.0 Executive (BGB) 2.0 TFSi, (BLB) 2.0 TDi (00-08), (CABA/B, CDHA/B, CJEB) 1.8 TFSi, (BRD, CAGA, CJCA, CMEA, CMFA) 2.0 TDi, (CABE, CDNC, CGLC, CMGB) 2.0 TFSi, (CDNC, CPMA) 2.0 TFSi Quattro (08-14)		AR8017 Rear Axle Carrier Bush - Rear Audi A4 (8E2/5, B6) (BFB) 1.8T Avant, Multitronic, SW, (AVF, AWX) 1.9 TDi Avant, (ALT) 2.0 Executive (BGB) 2.0 TFSi, (BLB) 2.0 TDi (00-08)
	AR8004 Rear Lower Control Arm Bush - Outer Audi A4 (8E2/5, B6) (BFB) 1.8T Avant, Multitronic, SW, (AVF, AWX) 1.9 TDi Avant, (ALT) 2.0 Executive (BGB) 2.0 TFSi, (BLB) 2.0 TDi (00-08), (CABA/B, CDHA/B, CJEB) 1.8 TFSi, (BRD, CAGA, CJCA, CMEA, CMFA) 2.0 TDi, (CABE, CDNC, CGLC, CMGB) 2.0 TFSi, (CDNC, CPMA) 2.0 TFSi Quattro (08-14)		AR8018 Rear Axle Carrier Bush - Front Audi A4 (8E2/5, B6) (BFB) 1.8T Avant, Multitronic, SW, (AVF, AWX) 1.9 TDi Avant, (ALT) 2.0 Executive (BGB) 2.0 TFSi, (BLB) 2.0 TDi (00-08)
	AR8005 Rear Axle Upper Bush Audi A4 (8E2/5, B6) (BFB) 1.8T Avant, Multitronic, SW, (AVF, AWX) 1.9 TDi Avant, (ALT) 2.0 Executive (BGB) 2.0 TFSi, (BLB) 2.0 TDi (00-08)		AR8019 Engine Mounting - Front Buffer Audi A4 (8E2/5, B6) (BFB) 1.8T Avant, Multitronic, SW, (AVF, AWX) 1.9 TDi Avant, (ALT) 2.0 Executive (BGB) 2.0 TFSi, (BLB) 2.0 TDi (00-08), A6 (CCEA) 2.8 FSi 7-Spd. Auto. (09-11)
 OD: 44	AR8006 Rear Axle Lower Bush Audi A4 (8E2/5, B6) (BFB) 1.8T Avant, Multitronic, SW, (AVF, AWX) 1.9 TDi Avant, (ALT) 2.0 Executive (BGB) 2.0 TFSi, (BLB) 2.0 TDi (00-08)	 OD: 71	AR8020 Transmission Mounting Bush - Rear L/RHS Audi A4 (8E2/5, B6) (BFB) 1.8T Avant, Multitronic, SW, (AVF, AWX) 1.9 TDi Avant, (ALT) 2.0 Executive (BGB) 2.0 TFSi, (BLB) 2.0 TDi (00-08)
 OD: 49.5	AR8007 Front Upper Control Arm Bush - Inner Front & Rear Audi A4 (8E2/5, B6) (BFB) 1.8T Avant, Multitronic, SW, (AVF, AWX) 1.9 TDi Avant, (ALT) 2.0 Executive (BGB) 2.0 TFSi, (BLB) 2.0 TDi (00-08), (CABA/B, CDHA/B, CJEB) 1.8 TFSi, (BRD, CAGA, CJCA, CMEA, CMFA) 2.0 TDi, (CABE, CDNC, CGLC, CMGB) 2.0 TFSi, (CDNC, CPMA) 2.0 TFSi Quattro (08-14), A6 (BDX, CCEA) 2.8 FSi 7-Spd. Auto. (07-09), (BPJ) 2.0 TFSi 7-Spd. Auto. Pet., (BPP, CANA) 2.7 TDi 7-Spd. Auto., (CCEA) 2.8 FSi 7-Spd. Auto. (09-11)		AR8021 Transmission Mounting Bush - Front Audi A4 (8E2/5, B6) (AVF, AWX) 1.9 TDi Avant (00-08)
	AR8008 Rear Radius Rod Bush - Inner L/RHS Audi A4 (8E2/5, B6) (BFB) 1.8T Avant, Multitronic, SW, (AVF, AWX) 1.9 TDi Avant, (ALT) 2.0 Executive (BGB) 2.0 TFSi, (BLB) 2.0 TDi (00-08)		AR8022 Transmission Mounting Audi A4 2.5 TDi Quattro, Tiptronic (02-05), A6 (ASN) 3.0 Multitronic, Quattro (02-06)
	AR8009 Rear Radius Rod Bush - Outer L/RHS Audi A4 (8E2/5, B6) (BFB) 1.8T Avant, Multitronic, SW, (AVF, AWX) 1.9 TDi Avant, (ALT) 2.0 Executive (BGB) 2.0 TFSi, (BLB) 2.0 TDi (00-08)		AR8023 Engine Mounting - LHS Audi A4 (8E2/5, B6) (BFB) 1.8T Avant, Multitronic, SW, (AVF, AWX) 1.9 TDi Avant, (ALT) 2.0 Executive (BGB) 2.0 TFSi, (BLB) 2.0 TDi (00-08)
			AR8031 Transfer Gear Mounting Audi A4 (8E2/5, B6) (BFB) 1.8T Avant, Multitronic, SW, (AVF, AWX) 1.9 TDi Avant, (ALT) 2.0 Executive (BGB) 2.0 TFSi, (BLB) 2.0 TDi (00-08) - 8E-4-293 001 on
			AR8032 Transmission Mounting Audi A4 (8E2/5, B6) (BFB) 1.8T Avant, Multitronic, SW, (ALT) 2.0 Executive (BGB) 2.0 TFSi, (BLB) 2.0 TDi (00-08) - Auto. Models
			AR8033 Front Strut Mounting Fiat Seicento (176B2000) 1.1 S, Sporting (01-03)

ENGINE MOUNTING & RUBBER BUYERS GUIDE

323



	AR8034 Engine Mounting - RHS Nissan Almera (GA16DE) 1.6 Comfort, Elegance, Luxury, (QG18DE) 1.8 Elegance, Luxury (01-06)
	AR8035 Engine Mounting - Rear Nissan Almera (GA16DE) 1.6 Comfort, Elegance, Luxury, (QG18DE) 1.8 Elegance, Luxury (01-06)
	AR8036 Transmission Mounting Nissan Almera (GA16DE) 1.6 Comfort, Elegance, Luxury (01-06)
	AR8037 Front Lower Control Arm Bush - Inner Front Citroen C5 (EW10J4S) 2.0 SX (01-05)
	AR8038 Front Lower Control Arm Bush - Outer Rear Citroen C5 (EW10J4S) 2.0 SX (01-05)
	AR8039 Engine Mounting - L/RHS Kia Rio I (A3E) 1.3, RS, (A5D) 1.5, RS (00-05)
	AR8041 Rear Strut Mounting Audi A3 (BVZ) 2.0 FSi, (BMM, CLJA) 2.0 TDi (03-13), (CBFA, CCZA) 2.0 TFSi, (BUB) 3.2 Quattro (04-13), (CJZA, CCJZ) 1.2 TFSi, (CXSA) 1.4 TFSi, (CLHA) 1.6 TDi, (CJSA, CJSB) 1.8 TFSi, (DAGA) 2.0 TDi (12-17), S3 (CDLC) 2.0 TFSi (07-13)
	AR8042 Engine Mounting - RHS Audi A3 (BVZ) 2.0 FSi (03-13), (CBFA, CCZA) 2.0 TFSi, (BUB) 3.2 Quattro (04-13), (CJSA, CJSB) 1.8 TFSi (12-17), S3 (CDLC) 2.0 TFSi (07-13); Seat Altea (BVY, BVZ) 2.0 FSi (06-09), Leon (BLR, BLY, BVZ) 2.0 FSi, (BWA, BWJ, CDLD) 2.0 FSi (06-09), CC (CFGB) 2.0 TDi, (CCZB) 2.0 TSi, (BWS) 3.6 FSi V6 4-Motion (2009-); Volkswagen Golf V (BKD) 2.0 TDi DSG Sport, Sport Tiptronic, Sport 5-Spd. Man., 6-Spd. Auto., (BLX) 2.0i Trendline, GTi DSG, Comfortline, GTi 5-Spd. Man., 6-Spd. Auto., (BLY) 2.0 FSi Sport, Sport Tiptronic 6-Spd. Man., Auto. (04-09), Golf VI (CAXA, CAVD) 1.4 TSi Trendline, Comfortline, HighLine, 2.0 TSi-R 4-Motion, DSG (09-13), Jetta V (BHY) 2.0i Trendline, DSG, Comfortline, 5-Spd. Man., 6-Spd. Auto., 2.0 FSi, Sportline, Tiptronic 6-Spd. Man./Auto., 2.0 TFSi, Sportline, Tiptronic 6-Spd. Man./Auto. (05-11), 2.0 TSi HighLine (2005-), Jetta VI (CBZB) 1.2 TSi, (CAYC) 1.6 TDi, (CFHC, CJAA, CLCB) 2.0 TDi (2011-), Passat V (AXX, BLR, BLY, BPY, BVY, BVZ, BWA, CAWB, CBFA, CCZ/TA) 2.0 FSi, TFSi Comfortline, HighLine, (AXZ) 3.2 FSi Sportline, DSG (05-11), Passat (CDAA) 1.8 TSi (11-16), Scirocco (CDLF) 2.0 TSi, DSG, R (2009-), Tiguan 4X2, 4X4 (BWK, CAVA) 1.4 TSi Trend&Fun, Track&Field, (CBAB) 2.0 TDi Auto. Track&Field, Sport&Style, Trend&Fun, (CCZA) 2.0 TSi Auto., DSG Track&Field, Sport&Style, 4-Motion (08-11), Touran (BLY) 2.0 FSi MPV HighLine (04-11), (CFHF, CLCA) 2.0 TDi (2011-)
	AR8044 Transmission Mounting Nissan Almera (QG18DE) 1.8 Elegance, Luxury (01-06)
	AR8045 Engine Mounting - Front Ford Bantam 'Boet' (CLTA) 1.3i XL, XLS SWB P/up Pet. (02-12), Fiesta I (Rocam) 1.6i Flair, Forte (97-04), Ikon (CLTA) 1.3i LX, Low, (CLTA) 1.6i LX, CLX, High, Low (01-06)

	AR8046 Engine Mounting - Front Ford Bantam 'Boet' (Zetec) 1.6i XLE, XLT, SWB P/up Pet., 1.8di XL SWB P/up Dies. (02-12), Fiesta I (Rocam) 1.6i RSi, Sport (97-04), Ikon (CLTA) 1.6i LX, CLX, High, Low (01-06)
	AR8047 Exhaust Hanger - Front Ford Bantam 'Boet' (CLTA) 1.3i XL, XLS SWB P/up Pet., (Zetec) 1.6i XLE, XLT, SWB P/up Pet., 1.8di XL SWB P/up Dies. (02-12), Fiesta I (Endura EM5) 1.3i Flair, Flite, Fun Play, (CVH, PTE) 1.4i Flair, Flite, Fun, (Rocam) 1.6i Flair, Forte, RSi, Sport (97-04), Ikon (CLTA) 1.3i LX, Low, (CLTA) 1.6i LX, CLX, High, Low (01-06)
	AR8048 Front Lower Control Arm Bush - Front Ford Mondeo (Endura D18TI) 1.8 TDi LX, (Zetec ZH18EFI) 1.8i LX B-P Pet., (Zetec ZH20EFI, ZH20HE) 2.0i Aspen, CLX, B-P, (Duratec M5) 2.5i V6 Si (99-01)
	AR8049 Front Lower Control Arm Bush - Outer Rear Ford Mondeo (Endura D18TI) 1.8 TDi LX, (Zetec ZH18EFI) 1.8i LX B-P Pet., (Zetec ZH20EFI, ZH20HE) 2.0i Aspen, CLX, B-P, (Duratec M5) 2.5i V6 Si (97-99)
	AR8051 Front Stabilizer Bar Bush Mazda 6 (GG) (LFF7) 2.0 Active, Original, Elegant, (L3C1) 2.3 Dynamic, Individual, Sporty, Sporty Lux (03-09)
	AR8052 Rear Stabilizer Bar Bush Mazda 6 (GG) (LFF7) 2.0 Active, Original, Elegant, (L3C1) 2.3 Dynamic, Individual, Sporty, Sporty Lux (03-09)
	AR8053 Front Subframe Bush - LHS Mazda 6 (GG) (LFF7) 2.0 Active, Original, Elegant, (L3C1) 2.3 Dynamic, Individual, Sporty, Sporty Lux (03-09)
	AR8054 Front Subframe Bush - RHS Mazda 6 (GG) (LFF7) 2.0 Active, Original, Elegant, (L3C1) 2.3 Dynamic, Individual, Sporty, Sporty Lux (03-09)
	AR8055 Front Lower Control Arm Bush - Inner Front Mazda 6 (GG) (LFF7) 2.0 Active, Original, Elegant, (L3C1) 2.3 Dynamic, Individual, Sporty, Sporty Lux (03-09)
	AR8056 Front Lower Control Arm Bush - Outer Rear Mazda 6 (GG) (LFF7) 2.0 Active, Original, Elegant, (L3C1) 2.3 Dynamic, Individual, Sporty, Sporty Lux (03-09)
	AR8057 Rear Lateral Link - Adjustable L/RHS Mazda 6 (GG) (LFF7) 2.0 Active, Original, Elegant, (L3C1) 2.3 Dynamic, Individual, Sporty, Sporty Lux (03-09)

ENGINE MOUNTING & RUBBER BUYERS GUIDE

	AR8058 Engine Mounting - Front Nissan Almera (GA16DE) 1.6 Comfort, Elegance, Luxury, (QG18DE) 1.8 Elegance, Luxury (01-06)		AR8067 Rear Axle Beam Bush Kia Rio I (A3E) 1.3, RS, (A5D) 1.5, RS (00-05)
	AR8060 Engine Mounting - Front Middle Opel Corsa C (14NE) 140i Classic Comfort, Chill, Club, Sport, Lite, Lite+, S, Lite Sport, Sedan, Hatch, (16SE) 1.6i Elegance, Sport, Classic, Elegance Sedan, Hatch, (X17D) 1.7i DTi Hatch, Classic Elegance Sedan, Hatch Dies., 1.8i Hatch GSi, Classic Executive Sedan, Hatch (03-08), Corsa LDV II (14XE) 1.4i Utility S, Sport, Club, P/up Pet., (Y17DT) 1.7D Utility, Sport, Club DTi P/up Dies., (Z18XEL) 1.8i Utility, Sport, Club, P/up (02-10), Corsa Combo P/van (Z14XEP) 1.4i Pet. (05-12), Meriva (Z14XEP) 1.4 Essentia MPV, (A14NEL, B14NEL) 1.4T, (Z16XE/P) 1.6 Club, Comfort, Enjoy MPV, (Z17DT/H/R) 1.7 CDTi Elegance, Enjoy, (Z18XE) 1.8 Elegance, Easytronic MPV (03-15)	ID: 12, OD: 57, L: 60	AR8068 Steering Rack Mounting - LHS Kia Rio I (A3E) 1.3, RS, (A5D) 1.5, RS (00-05)
	AR8061 Engine Mounting - LHS Chevrolet Corsa 1.4 AC, Club, Sport, 1.7 DTi, Club, Sport, 1.8 Club, Sport (2010-), Utility 1.3D AC, Club, Sport, 1.4 AC, Club, Sport, 1.8 AC, Club, Sport (2010-); Opel Corsa C (14NE) 140i Classic Comfort, Chill, Club, Sport, Lite, Lite+, S, Lite Sport, Sedan, Hatch, (16SE) 1.6i Elegance, Sport, Classic, Elegance Sedan, Hatch, (X17D) 1.7i DTi Hatch, Classic Elegance Sedan, Hatch Dies., 1.8i Hatch GSi, Classic Executive Sedan, Hatch (03-08), Corsa LDV II (14XE) 1.4i Utility S, Sport, Club, P/up Pet., (Y17DT) 1.7D Utility, Sport, Club DTi P/up Dies., (Z18XEL) 1.8i Utility, Sport, Club, P/up (02-10), Corsa Combo P/van (Z14XEP) 1.4i Pet. (05-12), Meriva (Z14XEP) 1.4 Essentia MPV, (A14NEL, B14NEL) 1.4T, (Z16XE/P) 1.6 Club, Comfort, Enjoy MPV, (Z17DT/H/R) 1.7 CDTi Elegance, Enjoy, (Z18XE) 1.8 Elegance, Easytronic MPV (03-15)		AR8069 Steering Rack Mounting - RHS Kia Rio I (A3E) 1.3, RS, (A5D) 1.5, RS (00-05)
	AR8062 Engine Mounting - Front RHS Opel Corsa C (14NE) 140i Classic Comfort, Chill, Club, Sport, Lite, Lite+, S, Lite Sport, Sedan, Hatch, (16SE) 1.6i Elegance, Sport, Classic, Elegance Sedan, Hatch, (X17D) 1.7i DTi Hatch, Classic Elegance Sedan, Hatch Dies., 1.8i Hatch GSi, Classic Executive Sedan, Hatch (03-08), Corsa Combo P/van (Z14XEP) 1.4i Pet. (05-12), Meriva (Z14XEP) 1.4 Essentia MPV, (A14NEL, B14NEL) 1.4T, (Z16XE/P) 1.6 Club, Comfort, Enjoy MPV, (Z17DT/H/R) 1.7 CDTi Elegance, Enjoy, (Z18XE) 1.8 Elegance, Easytronic MPV (03-15)		AR8072 Transmission Mounting Kia Sephia (BFD) 1.5 LS, RS (98-04), Shuma (BFD) 1.5i LS, (TBD) 1.8i GS (98-04), Shuma II 1.6i, (T8) 1.8i GS (98-04), Spectra (A6) 1.6 Exec., LS (98-04)
	AR8063 Rear Axle Beam Bush Opel Corsa C (14NE) 140i Classic Comfort, Chill, Club, Sport, Lite, Lite+, S, Lite Sport, Sedan, Hatch, (16SE) 1.6i Elegance, Sport, Classic, Elegance Sedan, Hatch, (X17D) 1.7i DTi Hatch, Classic Elegance Sedan, Hatch Dies., 1.8i Hatch GSi, Classic Executive Sedan, Hatch (03-08), Corsa LDV II (14XE) 1.4i Utility S, Sport, Club, P/up Pet., (Y17DT) 1.7D Utility, Sport, Club DTi P/up Dies., (Z18XEL) 1.8i Utility, Sport, Club, P/up (02-10), Meriva (Z14XEP) 1.4 Essentia MPV, (A14NEL, B14NEL) 1.4T, (Z16XE/P) 1.6 Club, Comfort, Enjoy MPV, (Z17DT/H/R) 1.7 CDTi Elegance, Enjoy, (Z18XE) 1.8 Elegance, Easytronic MPV (03-15)	ID: 10, OD: 59/66, L: 65	AR8075 Front Lower Control Arm Bush - Inner Front, Outer Kia Carens (G4KA) 2.0 CVVT, (D4EA) 2.0 CRDi (03-06), Sephia (BFD) 1.5 LS, RS (98-04), Shuma (BFD) 1.5i LS, (TBD) 1.8i GS (98-04), Shuma II 1.6i, (T8) 1.8i GS (98-04), Spectra (A6) 1.6 Exec., LS (98-04)
	AR8064 Front Lower Control Arm Bush - Inner Front Nissan Almera (GA16DE) 1.6 Comfort, Elegance, Luxury, (QG18DE) 1.8 Elegance, Luxury (01-06)	L: 41.5/55	AR8077 Front Lower Control Arm Bush - Outer Rear LHS Kia Carens (G4KA) 2.0 CVVT, (D4EA) 2.0 CRDi (03-06), Sephia (BFD) 1.5 LS, RS (98-04), Shuma (BFD) 1.5i LS, (TBD) 1.8i GS (98-04), Shuma II 1.6i, (T8) 1.8i GS (98-04), Spectra (A6) 1.6 Exec., LS (98-04)
	AR8065 Front Lower Control Arm Bush - Outer Rear Nissan Almera (GA16DE) 1.6 Comfort, Elegance, Luxury, (QG18DE) 1.8 Elegance, Luxury (01-06)	ID: 21, OD: 49.5, W: 36.6	AR8078 Steering Rack Mounting - LHS Kia Sephia (BFD) 1.5 LS, RS (98-04), Shuma (BFD) 1.5i LS, (TBD) 1.8i GS (98-04), Shuma II 1.6i, (T8) 1.8i GS (98-04), Spectra (A6) 1.6 Exec., LS (98-04)
	AR8066 Engine Mounting - RHS Kia Spectra (A6) 1.6 Exec., LS (98-04)		AR8079 Steering Rack Mounting - RHS Kia Sephia (BFD) 1.5 LS, RS (98-04), Shuma (BFD) 1.5i LS, (TBD) 1.8i GS (98-04), Shuma II 1.6i, (T8) 1.8i GS (98-04), Spectra (A6) 1.6 Exec., LS (98-04)
			AR8088 Engine Mounting - L/RHS Kia Sorento 4X2, 4X4 (D4HB) 3.5 V6, 3.8 V6 (02-09)
			AR8089 Transmission Mounting Kia Sorento 4X2, 4X4 (D4HB) 3.5 V6, 3.8 V6 (02-09)
			AR8090 Front Subframe Insulator Bush Kia Sorento 4X2, 4X4 (D4CB) 2.5 CRDi SUV, (D4HB) 3.5 V6, 3.8 V6 (02-09)
			AR8091 Front Strut Mounting Kia Sorento 4X2, 4X4 (D4CB) 2.5 CRDi SUV, (D4HB) 3.5 V6, 3.8 V6 (02-09)
			AR8093 Front Stabilizer Link Grommet Kia Sorento 4X2, 4X4 (D4CB) 2.5 CRDi SUV, (D4HB) 3.5 V6, 3.8 V6 (02-09)

ENGINE MOUNTING & RUBBER BUYERS GUIDE

 ID: 27	AR8094 Front Stabilizer Bar Bush Kia Sorento 4X2, 4X4 (D4CB) 2.5 CRDi SUV, (D4HB) 3.5 V6, 3.8 V6 (02-09)
 ID: 25	AR8095 Front Stabilizer Bar Bush Kia Sorento 4X2, 4X4 (D4CB) 2.5 CRDi SUV, (D4HB) 3.5 V6, 3.8 V6 (02-09)
 ID: 12, OD: 36.5, W: 45	AR8096 Front Upper Control Arm Bush - Inner & Outer Kia Sorento 4X2, 4X4 (D4CB) 2.5 CRDi SUV, (D4HB) 3.5 V6, 3.8 V6 (02-09)
 ID: 12, OD: 36.5, W: 45	AR8097 Front Upper Control Arm Bush - Inner & Outer Kia Sorento 4X2, 4X4 (D4CB) 2.5 CRDi SUV, (D4HB) 3.5 V6, 3.8 V6 (02-09)
 ID: 12, OD: 36.5, W: 45	AR8098 Front Lower Control Arm Bush - Inner & Outer Kia Sorento 4X2, 4X4 (D4CB) 2.5 CRDi SUV, (D4HB) 3.5 V6, 3.8 V6 (02-09)
 ID: 18, OD: 53, L: 69	AR8099 Front Lower Control Arm Bush - Inner & Outer Kia Sorento 4X2, 4X4 (D4CB) 2.5 CRDi SUV, (D4HB) 3.5 V6, 3.8 V6 (02-09)
 ID: 14, OD: 56, W: 62	AR8100 Rear Upper Link Bush Kia Sorento 4X2, 4X4 (D4CB) 2.5 CRDi SUV, (D4HB) 3.5 V6, 3.8 V6 (02-09)
 ID: 14, OD: 55, W: 61	AR8101 Front Lower Link Bush Kia Sorento 4X2, 4X4 (D4CB) 2.5 CRDi SUV, (D4HB) 3.5 V6, 3.8 V6 (02-09)
 ID: 14, OD: 55, W: 61	AR8103 Rear Lower Link Bush Kia Sorento 4X2, 4X4 (D4CB) 2.5 CRDi SUV, (D4HB) 3.5 V6, 3.8 V6 (02-09)
 ID: 25	AR8107 Rear Stabilizer Bar Bush Kia Sorento 4X2, 4X4 (D4CB) 2.5 CRDi SUV, (D4HB) 3.5 V6, 3.8 V6 (02-09)
 ID: 22, L: 20, H: 37, W: 40	AR8109 Transmission Mounting Kia Sportage 4X4 (FE) 2.0 SWB SUV, Wagon Pet. (98-04)
 ID: 22, L: 20, H: 37, W: 40	AR8110 Front Stabilizer Bar Bush Kia Sportage 4X4 (FE) 2.0 SWB SUV, Wagon Pet. (98-04)

 ID: 12, OD: 36, L: 45	AR8111 Front Upper Control Arm Bush - Inner Front & Outer Rear Kia Sportage 4X4 (FE) 2.0 SWB SUV, Wagon Pet. (98-04)
 ID: 18, OD: 48, L: 60	AR8112 Front Lower Control Arm Bush - Inner Front & Outer Rear Kia Sportage 4X4 (FE) 2.0 SWB SUV, Wagon Pet. (98-04)
 ID: 12, OD: 36, L: 45	AR8113 Front Strut Mounting Kia Sportage 4X4 (FE) 2.0 SWB SUV, Wagon Pet. (98-04)
 ID: 12, OD: 48, L: 61	AR8115 Rear Lateral Link Bush Kia Sportage 4X4 (FE) 2.0 SWB SUV, Wagon Pet. (98-04)
 ID: 12, OD: 48, L: 56	AR8116 Upper Trailing Link Bush - Rear Kia Sportage 4X4 (FE) 2.0 SWB SUV, Wagon Pet. (98-04)
 ID: 12, OD: 49, L: 61	AR8117 Lower Trailing Link Bush - Rear Kia Sportage 4X4 (FE) 2.0 SWB SUV, Wagon Pet. (98-04)
 ID: 12, OD: 49, L: 61	AR8118 Engine Mounting - L/RHS Opel Omega 2.2i, 2.6i V6 (01-04)
 ID: 12, OD: 49, L: 61	AR8119 Transmission Mounting Opel Omega 2.2i, 2.6i V6 (01-04)
 ID: 12, OD: 49, L: 61	AR8120 Front Lower Control Arm Bush - Inner Opel Omega 2.2i, 2.6i V6 (01-04)
 ID: 12, OD: 49, L: 61	AR8121 Front Lower Control Arm Bush - Outer Opel Omega 2.2i, 2.6i V6 (01-04)
 ID: 12, OD: 49, L: 61	AR8122 Front Stabilizer Bar Bush Opel Omega 2.2i, 2.6i V6 (01-04)
 ID: 12, OD: 49, L: 61	AR8123 Front Strut Mounting Opel Omega 2.2i, 2.6i V6 (01-04)

ENGINE MOUNTING & RUBBER BUYERS GUIDE

	AR8124 Opel Omega 2.2i, 2.6i V6 (01-04) Centre Bearing Rubber		AR8137 Toyota Condor 4X4 (2RZ-E) 2.4i Estate, TX Estate MPV Pet., 5-Spd. Man., (5L) 3.0 SWB Estate, TX Estate MPV Dies., (5L) 3.0 Estate, TE Estate MPV Dies. 5-Spd. Man. (00-05) Front Stabilizer Bar Bush
	AR8125 Opel Omega 2.2i, 2.6i V6 (01-04) Propshaft Coupling		AR8138 Volvo S40 (B4204T2/3) 2.0T Sedan 4-Spd. Auto., 5-Spd. Man. (97-00) Transmission Mounting
	AR8126 Opel Omega 2.2i, 2.6i V6 (01-04) Rear Front Axle Beam Bush		AR8139 Toyota HiAce (YH50) (2Y) 1.8 SWB P/van 4-Spd. Man. Pet., (YH60) (2Y) 1.8 LWB LS Wagon, P/van 5-Spd. Man. Pet. (83-91), (YH53) (4Y) 2.2 SWB LS, GLX, GLX Exec. Wagon, Super10, (YH63) (4Y) 2.2 LWB Super16, SuperT, P/van, Siyaya Pet. 5-Spd. Man., 4-Spd. Auto. (86-09) Bump Stop Rubber - Rear
	AR8127 Opel Omega 2.2i, 2.6i V6 (01-04) Rear Axle Beam Bush - Rear		AR8140 Toyota Hilux 4X4 (KZ-TE) 3.0 (98-05) Centre Bearing Rubber
	AR8128 Opel Omega 2.2i, 2.6i V6 (01-04) Rear Trailing Link Bush	 ID: 30	AR8141 Toyota Condor 4X4 (2RZ-E) 2.4i Estate, TX Estate MPV Pet., 5-Spd. Man., (5L) 3.0 SWB Estate, TX Estate MPV Dies., (5L) 3.0 Estate, TE Estate MPV Dies. 5-Spd. Man. (00-05) Centre Bearing Rubber
	AR8129 Opel Omega 2.2i, 2.6i V6 (01-04) Rear Trailing Link Bush		AR8142 Daihatsu Materia (3S2-VE) 1.5i (07-11), Sirion (K3-VE) 1.3 CX, (3S2-VE) 1.5i Sport (02-14), Terios 4X2, 4X4 (K3-VE) 1.3, (3S2-VE) 1.5i (02-15) Front Lower Control Arm Bush - Outer Rear
	AR8130 Opel Omega 2.2i, 2.6i V6 (01-04) Rear Stabilizer Bar Bush		AR8143 Toyota Quantum (2KD-FTV) 2.5D, "Family" Bus, 10/14 Seater MPV Dies., (2TR-FE) 2.7, "Family" Bus, 10/14/15 Seater, MPV, Ses' fikile Pet. (2005-) Centre Bearing Rubber
	AR8132 Toyota Condor (2Y) 1.8 Estate, TE Estate MPV Pet., 2.0i Estate, TE, Estate MPV, (2RZ-E) 2.4i Estate, TE, TX Estate MPV Pet. (00-05), Condor 4X2 (2RZ-E) 2.4i Estate, TX Estate MPV Pet., 5-Spd. Man., (5L) 3.0 SWB Estate, TX Estate MPV Dies., (5L) 3.0 Estate, TE Estate MPV Dies. 5-Spd. Man. (00-05) Centre Bearing Rubber	 ID: 30, L: 175.5, H: 107.8	AR8144 Renault Clio II (D4F706) 1.2 Authentique, Expression, Generation, Va Va Voom, (K4J) 1.4 16V, (K7J) 1.4 8V Alaise, Alize, Expression, Privilege, RT, Expression, Priviledge, Va Va Voom (99-08), Kangoo (E7J780) 1.4 Multix Authentique MPV Pet., (E7J780) 1.4 Express Van Pet., (K9K700) 1.5dCi Express Van Dies. (01-10) Engine Support Mounting
	AR8133 Toyota Condor (2Y) 1.8 Estate, TE Estate MPV Pet., 2.0i Estate, TE, Estate MPV, (2RZ-E) 2.4i Estate, TE, TX Estate MPV Pet. (00-05), Condor 4X2, 4X4 (2RZ-E) 2.4i Estate, TX Estate MPV Pet., 5-Spd. Man., (5L) 3.0 SWB Estate, TX Estate MPV Dies., (5L) 3.0 Estate, TE Estate MPV Dies. 5-Spd. Man. (00-05) Front Upper Control Arm Bush - Inner Front		AR8144A Renault Clio II (D4F706) 1.2 Authentique, Expression, Generation, Va Va Voom, (K4J) 1.4 16V, (K7J) 1.4 8V Alaise, Alize, Expression, Privilege, RT, Expression, Priviledge, Va Va Voom (99-08), Kangoo (E7J780) 1.4 Multix Authentique MPV Pet., (E7J780) 1.4 Express Van Pet., (K9K700) 1.5dCi Express Van Dies. (01-10) Engine Support Mounting
	AR8134 Toyota Condor 4X4 (2RZ-E) 2.4i Estate, TX Estate MPV Pet., 5-Spd. Man., (5L) 3.0 SWB Estate, TX Estate MPV Dies., (5L) 3.0 Estate, TE Estate MPV Dies. 5-Spd. Man. (00-05) Front Lower Control Arm Bush - Inner		AR8144AB Renault Clio II (K9K700/702) 1.5dCi Expression, (K7M744/5/8) 1.6 Dynamique, Privilege, Sport, (F4R, F7R) 2.0 Sport (99-04), Kangoo (E7J780) 1.4 Multix Authentique MPV Pet., (E7J780) 1.4 Express Van Pet., (K9K700) 1.5dCi Express Van Dies. (01-10), (K9K700/704) 1.5dCi, (K7M750) 1.6 (03-13), Scenic II (K4J750) 1.4 Authentique (02-10), Twingo (D4F772) 1.2 Dynamique, '+', (K4M854) 1.6 RS, Gordini (08-13) Engine Support Mounting
	AR8135 Toyota Condor (2Y) 1.8 Estate, TE Estate MPV Pet., 2.0i Estate, TE, Estate MPV, (2RZ-E) 2.4i Estate, TE, TX Estate MPV Pet. (00-05), Condor 4X2, 4X4 (2RZ-E) 2.4i Estate, TX Estate MPV Pet., 5-Spd. Man., (5L) 3.0 SWB Estate, TX Estate MPV Dies., (5L) 3.0 Estate, TE Estate MPV Dies. 5-Spd. Man. (00-05) Front Upper Control Arm Bush - Outer Rear		AR8145 Toyota Avanza 1.3 P/van, (K3-VE) 1.3 S, SX MPV, (3SZ-VE) 1.5 SX, TX MPV (06-12) Front Lower Control Arm Bush - Inner Front
	AR8136 Toyota Condor (2Y) 1.8 Estate, TE Estate MPV Pet., 2.0i Estate, TE, Estate MPV, (2RZ-E) 2.4i Estate, TE, TX Estate MPV Pet. (00-05), Condor 4X2 (2RZ-E) 2.4i Estate, TX Estate MPV Pet., 5-Spd. Man., (5L) 3.0 SWB Estate, TX Estate MPV Dies., (5L) 3.0 Estate, TE Estate MPV Dies. 5-Spd. Man. (00-05) Front Stabilizer Bar Bush	 ID: 12, OD: 40, L: 70	

ENGINE MOUNTING & RUBBER BUYERS GUIDE

 ID: 16, OD: 65, L: 60	AR8146 Front Lower Control Arm Bush - Outer Rear Toyota Avanza 1.3 P/van, (K3-VE) 1.3 S, SX MPV, (3SZ-VE) 1.5 SX, TX MPV (06-12)
 OD: 100 6-HOLES	AR8149 Propshaft Coupling - Rear Mercedes-Benz (W202) C280 (M104.941) 2.8 6-Cyl. Elegance (94-00), (W203) C-Class C180 (M111.920) 1.8 Classic, C200 (M271.940) 2.0 Classic, S/W, C220 (OM611.962, OM646.963) 2.2 CDI Classic, S/W, Elegance, C230 2.3 Coupe, C240 (M203.086) 2.6 V6 Elegance, S/W, Elegance S/W, C270 (OM612.962) 2.7 CDI 5-Cyl. Elegance, S/W, C320 (M111.946) 3.2 V6 Avantgarde Elegance, SW, (M271.946) C180K , (M271.940) C200K , (OM611.962, OM646.963) C220 CDI , (M271.948) C230K , (M112.912) C240/240T , (OM642.910) C320 CDI , (M272.960) C350 (00-11), (W204) C-Class (M271.910, M271.952) C180K , (M271.950) C200K , (OM651.911) C220 CDI , (M272.947) C300 , (OM642.960) C350 CDI , (M272.961) C350 (07-14), (W208) CLK230 (M111.973/5) 2.3 Kompressor, CLK320 (M112.940) 3.2 V6 Cabrio (98-05), (W209) CLK320 (M112.940) 3.2 V6 Elegance, Cabrio (98-05), (W211) E-Class (M271.941/956) E200K , (M112.949) E320 (02-10)
 OD: 110 6-HOLES	AR8150 Propshaft Coupling Mercedes-Benz (W203) C-Class C270 (OM612.962) 2.7 CDI 5-Cyl. Elegance, S/W, (OM611.962, OM646.963) C220 CDI , (M272.960) C350 (00-11), (W211) E-Class (OM647.961) E270 CDI , (M113.967) E500 (02-10), (W212) E-Class (M271.860) E250, CGi , (M276.980) E350 (2011-)
 NO PICTURE AVAILABLE AT TIME OF PRINT	AR8150K Propshaft Coupling Mercedes-Benz (W211) E-Class E220 CDI (OM646.961) 2.2 (02-10)
 OD: 105 6-HOLES	AR8153 Propshaft Coupling BMW 6-Series (E63, E64) 645Ci 4.4 (04-08)
	AR8154 Engine Mounting - LHS BMW 5-Series (E60) 545i (N62B44A) 4.4 V8 (04-10), 6-Series (E63, E64) 645Ci 4.4 (04-08)
	AR8155 Engine Mounting - RHS BMW 5-Series (E60) 545i (N62B44A) 4.4 V8 (04-10), 6-Series (E63, E64) 645Ci 4.4 (04-08)
	AR8156 Front Stabilizer Bar Bush BMW 6-Series (E63, E64) 645Ci 4.4 (04-08)
	AR8160L Front Strut Mounting Nissan Livina (HR16DE) 1.6 Acenta, Acenta+, Visia , X-Gear Vista (07-15), Grand Livina (HR16DE) 1.6 Acenta, Acenta+ (07-15), Micra (K12) (CR14DE) 1.4 Comfort, Elegance, SE, Accenta, +, Sport, Visia , (K9K) 1.5dCi Tekna (04-11), Tiida (HR16DE) 1.6 Visia , Visia + , Acenta, (MR18DE) 1.8 Acenta (06-13); Renault Clio II (D4F706) 1.2 Authentique, Expression, Generation, Va Va Voom, (K4J) 1.4 16V, (K7J) 1.4 8V Alaise, Alize, Expression, Privilege, RT, Expression, Privilege, Va Va Voom, (K9K700/702) 1.5dCi Expression, (K7M744/5/8) 1.6 Dynamique, Privilege, Sport, (F4R) 2.0 Sport (99-04), Clio III (K4J780) 1.4 Alize Expression, Alize Privilege, Va Va Voom, (K9K700/702/752) 1.5dCi Expression, (K7M748, K4M800/01) 1.6 Dynamique, Privilege, S, Expression, Sport, (F4R/830/832) 2.0 Sport, Special Ed. (04-14), Modus (D4F740) 1.2 Authentique, (K4J770/780) 1.4 Expression, Dynamique, (K4M) 1.6 Expression (05-08)

	AR8160R Front Strut Mounting Nissan Livina (HR16DE) 1.6 Acenta, Acenta+, Visia , X-Gear Vista (07-15), Grand Livina (HR16DE) 1.6 Acenta, Acenta+ (07-15), Micra (K12) (CR14DE) 1.4 Comfort, Elegance, SE, Accenta, +, Sport, Visia , (K9K) 1.5dCi Tekna (04-11), Tiida (HR16DE) 1.6 Visia , Visia + , Acenta, (MR18DE) 1.8 Acenta (06-13); Renault Clio II (D4F706) 1.2 Authentique, Expression, Generation, Va Va Voom, (K4J) 1.4 16V, (K7J) 1.4 8V Alaise, Alize, Expression, Privilege, RT, Expression, Privilege, Va Va Voom, (K9K700/702) 1.5dCi Expression, (K7M744/5/8) 1.6 Dynamique, Privilege, Sport, (F4R) 2.0 Sport (99-04), Clio III (K4J780) 1.4 Alize Expression, Alize Privilege, Va Va Voom, (K9K700/702/752) 1.5dCi Expression, (K7M748, K4M800/01) 1.6 Dynamique, Privilege, S, Expression, Sport, (F4R/830/832) 2.0 Sport, Special Ed. (04-14), Modus (D4F740) 1.2 Authentique, (K4J770/780) 1.4 Expression, Dynamique, (K4M) 1.6 Expression (05-08)
	AR8162 Engine Mounting - LHS BMW X3 (E83) 4X4 (M47N2) 2.0d Steptronic SUV Dies. (04-10)
	AR8163 Engine Mounting - RHS BMW X3 (E83) 4X4 (M47N2) 2.0d Steptronic SUV Dies. (04-10)
	AR8164 Engine Mounting - LHS BMW X3 (E83) 4X4 (N46) 2.0i (04-10)
	AR8165 Engine Mounting - RHS BMW X3 (E83) 4X4 (N46) 2.0i (04-10)
	AR8166 Engine Mounting - LHS BMW X3 (E83) 4X4 (M54, N52N) 2.5i SUV, LCI SUV, (N52N) 3.0si (04-07)
	AR8167 Engine Mounting - RHS BMW X3 (E83) 4X4 (M54, N52N) 2.5i SUV, (N52N) 3.0si (04-07)
	AR8168 Engine Mounting - RHS BMW X3 (E83) 4X4 (M57N2) 3.0d SUV (04-07)
	AR8170 Transmission Mounting BMW X3 (E83) 4X4 (M47N2) 2.0d Steptronic SUV Dies., (N46) 2.0i (06-10)
	AR8171 Transmission Mounting BMW X3 (E83) 4X4 (M57N2) 3.0d SUV (04-07)
	AR8172 Transmission Mounting BMW X3 (E83) 4X4 (M54, N52N) 2.5i SUV, LCI SUV, (N52N) 3.0si (04-07)

ENGINE MOUNTING & RUBBER BUYERS GUIDE

 <p>ID: 22</p>	<p>AR8173 Front Stabilizer Bar Bush BMW X3 (E83) 4X4 (M54, N52N) 2.5i SUV, LCi SUV, (M57N2) 3.0d SUV, (N52N) 3.0si (04-07)</p>		<p>AR8186 Engine Mounting - LHS, Transmission Mounting Ford Focus II (IQDB) 1.6 Ambiente, Trend, Si, (QQDB, Q7DA) 1.8, (AODA, AODB, AODE) 2.0, (G6DA, G6DB, G6DD) 2.0 TDCi, (HYDA) 2.5 RS, ST (05-12), Focus III (PNDA) 1.6i, (MGDA) 2.0 TDCi, GDi, GTDi, (R9DA) ST1, ST3 (11-15), Kuga 4X2, 4X4 (JQMB, JQMA) 1.6 Ecoboost, Ambiente, (JTMA) 1.6 Ecoboost Titanium, Trend, (TXDA, TXMA) 2.0 TDCi Titanium, Trend AWD Powershift, (TXDB) 2.5 Turbo, Titanium, Trend AWD (2011-); Mazda 3 (BK, BL) (B6ZE, Z6) 1.6 Original, Active, Dynamic, (LF17) 2.0 Dynamic, Individual, (L3KG) 2.3 Individual MPS, (L5-VE) 2.5 (04-14), 5 (CR19) (LFF7) 2.0 Original, Active, Dynamic, Individual (07-10), 5 (CW) (LFZB) 2.0 (10-14); Volvo C30 (B4164S3) 1.6 Pet., (D4162T) 1.6 D2 Dies., (B4184S11) 1.8, (B4204S3) 2.0i, 2.0D, (B5254T3/7) 2.5i (07-13), C70 (B5254T3/7) 2.5 T5 Sedan (06-13), S40 (D4162T) 1.6 D2, (B4184S11) 1.8i, (B4204S3) 2.0, (D5204T) 2.0 D4, (D4204T) 2.0D, (B5244S4) 2.4i, (B5254T3/7) 2.5i T5 (04-12), V40 (D4162T) 1.6 D2, (B4164T3) 1.6 T3, (B4164T) 1.6 T4 (2012-), V50 1.8, (B4204S3) 2.0i Sedan R-Design, Powershift, (B5244S) 2.0D VS Sedan, 2.4 D5, (B5252FS) 2.4i VS T5 Sedan, (B5254T3/7) 2.5i T5 Sedan R-Design, Geartronic (04-12)</p>
	<p>AR8174 Rear Strut Mounting BMW X3 (E83) 4X4 (M54, N52N) 2.5i SUV, LCi SUV, (M57N2) 3.0d SUV, (N52N) 3.0si (04-07)</p>		<p>AR8187 Engine Mounting - Rear, Transmission Mounting Ford Focus II (IQDB) 1.6 Ambiente, Trend, Si, (QQDB, Q7DA) 1.8, (AODA, AODB, AODE) 2.0, (G6DA, G6DB, G6DD) 2.0 TDCi, (HYDA) 2.5 RS, ST (05-12), Focus III (PNDA) 1.6i, (MGDA) 2.0 TDCi, GDi, GTDi, (R9DA) ST1, ST3 (11-15), Kuga 4X2, 4X4 (JQMB, JQMA) 1.6 Ecoboost, Ambiente, (JTMA) 1.6 Ecoboost Titanium, Trend, (TXDA, TXMA) 2.0 TDCi Titanium, Trend AWD Powershift, (TXDB) 2.5 Turbo, Titanium, Trend AWD (2011-); Mazda 3 (BK, BL) (B6ZE, Z6) 1.6 Original, Active, Dynamic, (LF17) 2.0 Dynamic, Individual, (L3KG) 2.3 Individual MPS, (L5-VE) 2.5 (04-14), 5 (CR19) (LFF7) 2.0 Original, Active, Dynamic, Individual (07-10), 5 (CW) (LFZB) 2.0 (10-14); Volvo C30 (B4164S3) 1.6 Pet., (D4162T) 1.6 D2 Dies., (B4184S11) 1.8, (B4204S3) 2.0i, 2.0D, (B5254T3/7) 2.5i (07-13), C70 (B5254T3/7) 2.5 T5 Sedan (06-13), S40 (D4162T) 1.6 D2, (B4184S11) 1.8i, (B4204S3) 2.0, (D5204T) 2.0 D4, (D4204T) 2.0D, (D5244T13) 2.4 D5, (B5244S4) 2.4i, (B5254T3/7) 2.5i T5 (04-12), V40 (D4162T) 1.6 D2, (B4164T3) 1.6 T3, (B4164T) 1.6 T4, (D5204T6) 2.0 D3, (D5204T4) 2.0 D4 Cross Country, (B5254T12) 2.5 T5 (2012-), V50 1.8, (B4204S3) 2.0i Sedan R-Design, Powershift, (B5244S) 2.0D VS Sedan, 2.4 D5, (B5252FS) 2.4i VS T5 Sedan, (B5254T3/7) 2.5i T5 Sedan R-Design, Geartronic (04-12)</p>
 <p>ID: 17.5</p>	<p>AR8176 Rear Stabilizer Bar Bush BMW X3 (E83) 4X4 (M54, N52N) 2.5i SUV, LCi SUV, (M57N2) 3.0d SUV, (N52N) 3.0si (04-07)</p>		<p>AR8188 Engine Mounting - Rear Honda Civic (D15Z4) 150i Man., (D17A5) 170i Man. (00-06)</p>
	<p>AR8177 Engine Mounting - L/RHS BMW X5 (E53) 4X4 (M57N) 3.0d Steptronic SUV Dies., (M54) 3.0i Steptronic SUV 6-Cyl. Pet. (01-10)</p>		<p>AR8190 Engine Mounting - Rear Honda Accord (K20A6) 2.0i, (K24A3) 2.4i VTEC, Tourer, Exec. (03-08)</p>
	<p>AR8178 Transmission Mounting BMW X5 (E53) 4X4 (M57N) 3.0d Steptronic SUV Dies., (M54) 3.0i Steptronic SUV 6-Cyl. Pet. (01-10)</p>		<p>AR8191 Engine Mounting - Front Honda Civic (D15Z4) 150i Man., (D17A5) 170i Man. (00-06)</p>
	<p>AR8179 Transmission Mounting Nissan Micra (K12) (CR14DE) 1.4 Comfort, Elegance, SE, Accenta, +, Sport, Visia (04-11)</p>		<p>AR8192 Engine Mounting - Front Honda Civic (D15Z4) 150i Auto., (D17A5) 170i Auto. (00-06)</p>
	<p>AR8181 Engine Mounting - Rear Support Nissan Livina (HR16DE) 1.6 5-Spd. Man. Acenta, Acenta+, Visia, X-Gear Vista, Grand Livina (HR16DE) 1.6 5-Spd. Man. Acenta, Acenta+ (07-15), NV200 (M20) (K9K) 1.5dCi, (HR16DE) 1.6 (2013-), Tiida (HR16DE) 1.6 Visia, Visia +, Acenta 5-Spd. Man., 4-Spd. Auto., (MR18DE) 1.8 6-Spd. Man. (06-13); Renault Clio III (K4J) 1.4 16V, (K9K) 1.5dCi, (K4M) 1.6, (F4R) 2.0 Sport (04-14)</p>		
	<p>AR8182 Engine Mounting - L/RHS BMW X5 (E53) 4X4 (M62) 4.4i Steptronic SUV Pet., (N62) 4.8iS Steptronic SUV V8 Pet. (01-10)</p>		
	<p>AR8183 Transmission Mounting BMW X5 (E53) 4X4 (M62) 4.4i Steptronic SUV Pet., (N62) 4.8iS Steptronic SUV V8 Pet. (01-10)</p>		
	<p>AR8185 Engine Mounting - RHS Ford Kuga 4X2, 4X4 (JQMB, JQMA) 1.6 Ecoboost, Ambiente, (JTMA) 1.6 Ecoboost Titanium, Trend, (TXDA, TXMA) 2.0 TDCi Titanium, Trend AWD Powershift, (TXDB) 2.5 Turbo, Titanium, Trend AWD (2011-); Mazda 3 (BK, BL) (B6ZE, Z6) 1.6 Original, Active, Dynamic (04-14), 5 (CR19) (LFF7) 2.0 Original, Active, Dynamic, Individual (07-10), 5 (CW) (LFZB) 2.0 (10-14); Volvo V50 1.8, (B4204S3) 2.0i Sedan R-Design, Powershift, (B5244S) 2.0D VS Sedan, 2.4 D5, (B5252FS) 2.4i VS T5 Sedan, (B5254T3/7) 2.5i T5 Sedan R-Design, Geartronic (04-12)</p>		

ENGINE MOUNTING & RUBBER BUYERS GUIDE



329

	<p>AR8193 Front Strut Mounting</p> <p>Ford Focus II (IQDB) 1.6 Ambiente, Trend, Si, (QQDB, Q7DA) 1.8, (AODA, AODB, AODE) 2.0, (G6DA, G6DB, G6DD) 2.0 TDCi, (HYDA) 2.5 RS, ST (05-12), Focus III (PNDA) 1.6i, (MGDA) 2.0 TDCi, GDi, GTDi, (R9DA) ST1, ST3 (11-15), Kuga 4X2, 4X4 (JQMB, JQMA) 1.6 Ecoboost, Ambiente, (JTMA) 1.6 Ecoboost Titanium, Trend, (TXDA, TXMA) 2.0 TDCi Titanium, Trend AWD Powershift, (TXDB) 2.5 Turbo, Titanium, Trend AWD (2011-); Mazda 3 (BK, BL) (B6ZE, Z6) 1.6 Original, Active, Dynamic, (LF17) 2.0 Dynamic, Individual, (L3KG) 2.3 Individual MPS, (L5-VE) 2.5 (04-14); Volvo C30 (B4164S3) 1.6 Pet., (D4162T) 1.6 D2 Dies., (B4184S11) 1.8, (B4204S3) 2.0i, 2.0D, (B5254T3/7) 2.5i (07-13), C70 (B5254T3/7) 2.5 T5 Sedan (06-13), S40 (D4162T) 1.6 D2, (B4184S11) 1.8i, (B4204S3) 2.0, (D5204T) 2.0 D4, (D4204T) 2.0D, (D5244T13) 2.4 D5, (B5244S4) 2.4i, (B5254T3/7) 2.5i T5 (04-12), V50 1.8, (B4204S3) 2.0i Sedan R-Design, Powershift, (B5244S) 2.0D VS Sedan, 2.4 D5, (B5252FS) 2.4i VS T5 Sedan, (B5254T3/7) 2.5i T5 Sedan R-Design, Geartronic (04-12)</p>	 <p>ID: 14, OD: 74, W: 60</p>	<p>AR8207 Front Lower Control Arm Bush - Outer Rear</p> <p>Honda Accord (K20A6) 2.0i, (K24A3) 2.4i VTEC, Tourer, Exec. (03-08), Accord (R20A3) 2.0i V-TEC, (N22B1) 2.2i D-TEC, Tourer, Exec., (K24Z3) 2.4i V-TEC, Tourer, Exec. (08-15)</p>
	<p>AR8195L Front Strut Mounting - LHS (with Bearing)</p> <p>Mazda 5 (CR19) (LFF7) 2.0 Original, Active, Dynamic, Individual (07-10), 5 (CW) (LFZB) 2.0 (10-14)</p>	 <p>ID: 14.2, OD: 42.5/56, L: 63</p>	<p>AR8208 Front Lower Control Arm Bush - Outer Rear</p> <p>Honda Civic (D15Z4) 150i, (D17A5) 170i (00-06), CR-V II 4X4 (K20A4) 2.0i SWB SUV, (N22A2) 2.2 CTDi SWB SUV, (N22B3) 2.2 i-DTEC, (K24Z1/4) 2.4i V-TEC SWB SUV (05-09)</p>
	<p>AR8195R Front Strut Mounting - RHS (with Bearing)</p> <p>Mazda 5 (CR19) (LFF7) 2.0 Original, Active, Dynamic, Individual (07-10), 5 (CW) (LFZB) 2.0 (10-14)</p>	 <p>ID: 12.3, H: 56</p>	<p>AR8209 Front Lower Control Arm Bush - Inner Front</p> <p>Honda Accord (K20A6) 2.0i, (K24A3) 2.4i VTEC, Tourer, Exec. (03-08), (R20A3) 2.0i V-TEC, (N22B1) 2.2i D-TEC, Tourer, Exec., (K24Z3) 2.4i V-TEC, Tourer, Exec. (08-15)</p>
 <p>ID: 16</p>	<p>AR8199 Front Stabilizer Bar Bush</p> <p>BMW Mini Cooper (R50) Cooper (W10B16A) 1.6, (R52) Cooper (W10B16A, W11B16A) 1.6 Convertible, (R53) Cooper S (W11B16A) 1.6 (02-09)</p>		<p>AR8210 Rear Upper Trailing Arm Bush - Inner</p> <p>Honda Civic (D15Z4) 150i, (D17A5) 170i (00-06)</p>
 <p>ID: 23</p>	<p>AR8200 Front Stabilizer Bar Bush</p> <p>BMW Mini Cooper (R50) Cooper (W10B16A) 1.6, (R52) Cooper (W10B16A, W11B16A) 1.6 Convertible, (R53) Cooper S (W11B16A) 1.6 (02-09), Cooper (R55) (N12B16A, N16B16A) 1.6 Clubman, (R56) (N12B16A, N16B16A) 1.6 Hatch, (R57) (N12B16A, N16B16A) 1.6 Convertible, (R58) (N16B16A) 1.6 Coupe, (R59) (N16B16A) 1.6 Roadster, (R60) (N16B16A) 1.6 Countryman, (R61) (N16B16A) 1.6 Paceman (2007-) - Vehicles with Sport Suspension</p>		<p>AR8211 Rear Upper Trailing Arm Bush - Outer</p> <p>Honda Civic (D15Z4) 150i, (D17A5) 170i (00-06)</p>
	<p>AR8201 Front Strut Mounting</p> <p>BMW Mini Cooper (R53) Cooper S (W11B16A) 1.6 (02-09)</p>		<p>AR8212 Rear X-Member Bush - Front</p> <p>Mercedes-Benz (W169) A-Class A170 (M266.940) 1.7 Classic, A180 (OM640.940) 2.0 Cdi Classic, A200 (M266.960) 2.0 Elegance (05-13), (W245) B-Class (M266.940) B170, (M266.940) B180, (OM640.941) B200 CDi, (M266.960) B200, (M266.980) B200 Turbo (06-12)</p>
	<p>AR8202 Transmission Mounting</p> <p>BMW Mini Cooper (R53) Cooper S (W11B16A) 1.6 (02-09) - Man. Models</p>		<p>AR8213 Rear Axle Link Bush - Inner & Outer</p> <p>Mercedes-Benz (W169) A-Class A170 (M266.940) 1.7 Classic, A180 (OM640.940) 2.0 Cdi Classic, A200 (M266.960) 2.0 Elegance (05-13), (W245) B-Class (M266.940) B170, (M266.940) B180, (OM640.941) B200 CDi, (M266.960) B200, (M266.980) B200 Turbo (06-12)</p>
	<p>AR8203 Engine Mounting - Front</p> <p>Nissan X-Trail (T30) 4X4 (YD22ETI) 2.2D 6-Spd. Man. (01-07)</p>		<p>AR8214 Front Lower Control Arm Bush - Inner Front</p> <p>Mercedes-Benz (W169) A-Class A170 (M266.940) 1.7 Classic, A180 (OM640.940) 2.0 Cdi Classic, A200 (M266.960) 2.0 Elegance (05-13), (W245) B-Class (M266.940) B170, (M266.940) B180, (OM640.941) B200 CDi, (M266.960) B200, (M266.980) B200 Turbo (06-12)</p>
	<p>AR8204 Engine Mounting - Front</p> <p>Nissan X-Trail (T30) 4X2 (QR20DE) 2.0 5-Spd. Man., 4X4 (QR25DE) 2.5 5-Spd. Man., 4X4 (QR25DE) 2.5 SE 4-Spd. Auto. (01-07)</p>		<p>AR8215 Front Lower Control Arm Bush - Outer Rear</p> <p>Mercedes-Benz (W169) A-Class A170 (M266.940) 1.7 Classic, A180 (OM640.940) 2.0 Cdi Classic, A200 (M266.960) 2.0 Elegance (05-13), (W245) B-Class (M266.940) B170, (M266.940) B180, (OM640.941) B200 CDi, (M266.960) B200, (M266.980) B200 Turbo (06-12), (W245) B-Class (M266.940) B170, (M266.940) B180, (OM640.941) B200 CDi, (M266.960) B200, (M266.980) B200 Turbo (06-12)</p>
 <p>ID: 14.5, OD: 65, L: 63</p>	<p>AR8205 Front Lower Control Arm Bush - Inner Front</p> <p>Honda Civic (D15Z4) 150i, (D17A5) 170i (00-06), CR-V II 4X4 (K20A4) 2.0i SWB SUV, (N22A2) 2.2 CTDi SWB SUV, (N22B3) 2.2 i-DTEC, (K24Z1/4) 2.4i V-TEC SWB SUV (05-09)</p>		<p>AR8216 Rear Upper Control Arm Bush - Outer</p> <p>Mercedes-Benz (W169) A-Class A170 (M266.940) 1.7 Classic, A180 (OM640.940) 2.0 Cdi Classic, A200 (M266.960) 2.0 Elegance (05-13), (W204) C-Class (M271.910, M271.952) C180K, (M271.950) C200K, (OM651.911) C220 CDi, (M272.947) C300, (OM642.960) C350 CDi, (M272.961) C350 (07-14), (W212) E-Class (M271.820) E200 CGI, (OM651.924) E250 CDi, (M272.952) E300, (OM642.850) E350 CDi (2009-), (M273.971) E500 (06-12), (W245) B-Class (M266.940) B170, (M266.940) B180, (OM640.941) B200 CDi, (M266.960) B200, (M266.980) B200 Turbo (06-12)</p>

ENGINE MOUNTING & RUBBER BUYERS GUIDE

 <p>ID: 12, OD: 58, L: 53</p>	<p>AR8218 Front Lower Control Arm Bush - Outer Rear</p> <p>Renault Clio III (K4J780) 1.4 Alize Expression, Alize Privilege, Va Va Voom, (K9K700/702/752) 1.5dCi Expression, (K7M748, K4M800/01) 1.6 Dynamique, Privilege, S, Expression, Sport, (F4R/830/832) 2.0 Sport, Special Ed. (04-14), Modus (D4F740) 1.2 Authentique, (K4J770/780) 1.4 Expression, Dynamique, (K4M) 1.6 Expression (05-08)</p>	 <p>ID: 12, OD: 46.2, L: 60</p>	<p>AR8234 Front Lower Control Arm Bush - Inner Front & Outer Rear</p> <p>Opel Astra H (Z14XEP) 1.4 Essentia, (Z16XEP) 1.6 Enjoy, Essentia, (Z18XER) 1.8 Enjoy, Sport, GTC, GTC, Sport, (Z19DT) 1.9 CDTi Enjoy, GTC, Sport, (Z20LER) 2.0 Coupe' Turbo, GSi, GTC Turbo, OPC, Turbo Sport, GTC Turbo Sport (04-10), Zafira II (Z16XEP) 1.6 Essentia MPV, (Z18XEP) 1.8i Enjoy, CD, Elegance MPV, (Z20LEX) 2.0 OPC MPV, 2.2i Enjoy, Elegance MPV (05-09)</p>
 <p>ID: 14/16</p>	<p>AR8221 Front Stabilizer Bar Bush</p> <p>Ford Focus II (IQDB) 1.6 Ambiente, Trend, Si, (QQDB, Q7DA) 1.8, (AODA, AODB, AODE) 2.0, (G6DA, G6DB, G6DD) 2.0 TDCi, (HYDA) 2.5 RS, ST (05-12); Mazda 3 (BK, BL) (B6ZE, Z6) 1.6 Original, Active, Dynamic, (LF17) 2.0 Dynamic, Individual, (L3KG) 2.3 Individual MPS, (L5-VE) 2.5 (04-14), 5 (CR19) (LFF7) 2.0 Original, Active, Dynamic, Individual (07-10), 5 (CW) (LFZB) 2.0 (10-14); Volvo C30 (B4164S3) 1.6 Pet., (D4162T) 1.6 D2 Dies., (B4184S11) 1.8, (B4204S3) 2.0i, 2.0D, (B5254T3/7) 2.5i (07-13), S40 (D4162T) 1.6 D2, (B4184S11) 1.8i, (B4204S3) 2.0, (D5204T) 2.0 D4, (D4204T) 2.0D, (D5244T13) 2.4 D5, (B5244S4) 2.4i, (B5254T3/7) 2.5i T5 (04-12), V50 1.8, (B4204S3) 2.0i Sedan R-Design, Powershift, (B5244S) 2.0D VS Sedan, 2.4 D5, (B5252FS) 2.4i VS T5 Sedan, (B5254T3/7) 2.5i T5 Sedan R-Design, Geartronic (04-12)</p>	 <p>ID: 15, OD: 120, H: 49</p>	<p>AR8235 Front Strut Mounting</p> <p>Opel Astra H (Z14XEP) 1.4 Essentia, (Z16XEP) 1.6 Enjoy, Essentia, (Z18XER) 1.8 Enjoy, Sport, GTC, GTC, Sport, (Z19DT) 1.9 CDTi Enjoy, GTC, Sport, (Z20LER) 2.0 Coupe' Turbo, GSi, GTC Turbo, OPC, Turbo Sport, GTC Turbo Sport (04-10), Zafira II (Z16XEP) 1.6 Essentia MPV, (Z18XEP) 1.8i Enjoy, CD, Elegance MPV, (Z20LEX) 2.0 OPC MPV, 2.2i Enjoy, Elegance MPV (05-09)</p>
 <p>ID: 25</p>	<p>AR8224 Rear Stabilizer Bar Bush</p> <p>BMW 1-Series (E81, E87) 116i (N45) 1.6, 118i (N46) 2.0, 120i (N46) 2.0, 130i (N52) 3.0 (04-15), (E88) 120i (N46) 2.0 (04-15), (E82) 120d (N47) 2.0 (2005-), (E87) 118d (M47) 2.0, 120d (M47) 2.0 (2005-) - Vehicles with Sport Suspension</p>	 <p>ID: 12, L: 67.5</p>	<p>AR8236 Engine Mounting - Front LHS</p> <p>Chevrolet Corsa 1.4 AC, Club, Sport, 1.7 DTi, Club, Sport, 1.8 Club, Sport (2010-), Utility 1.3D AC, Club, Sport, 1.4 AC, Club, Sport, 1.8 AC, Club, Sport (2010-); Opel Corsa C (14NE) 140i Classic Comfort, Chill, Club, Sport, Lite, Lite+, S, Lite Sport, Sedan, Hatch, (16SE) 1.6i Elegance, Sport, Classic, Elegance Sedan, Hatch, (X17D) 1.7i DTi Hatch, Classic Elegance Sedan, Hatch Dies., 1.8i Hatch GSi, Classic Executive Sedan, Hatch (03-08), Corsa LDV II (14XE) 1.4i Utility S, Sport, Club, P/up Pet., (Y17DT) 1.7D Utility, Sport, Club DTi P/up Dies., (Z18XEL) 1.8i Utility, Sport, Club, P/up (02-10), Corsa Combo P/ivan (Z14XEP) 1.4i Pet. (05-12), Meriva (Z14XEP) 1.4 Essentia MPV, (A14NEL, B14NEL) 1.4T, (Z16XE/P) 1.6 Club, Comfort, Enjoy MPV, (Z17DT/H/R) 1.7 CDTi Elegance, Enjoy, (Z18XE) 1.8 Elegance, Easytronic MPV (03-15)</p>
 <p>ID: 12.5/14.5, OD: 69.8, L: 76</p>	<p>AR8225 Front Lower Control Arm Bush - Front</p> <p>BMW 1-Series (E81, E87) 116i (N45) 1.6, 118i (N46) 2.0, 120i (N46) 2.0, 130i (N52) 3.0 (04-15), (E88) 120i (N46) 2.0 (04-15), (E82) 120d (N47) 2.0 (2005-), (E87) 118d (M47) 2.0, 120d (M47) 2.0 (2005-), (E82, E88) 125i (N52, N54, N55) 3.0 Convertible, Coupe, 135i (N54, N55) 3.0 Turbo (08-14), 3-Series (E90) 320d (M47) 2.0, 320i (N46) 2.0, 323i (N52N) 2.5, 325i (N53) 2.5, 330i (N52, N53) 3.0, 330d (M57, N57) 3.0 (05-13), (E92) 320i (N44) 2.0, 325i (N53) 2.5, 335i (N54, N55) 3.0 (02-15), (E93) 330i (N52) 3.0, 335i (N54, N55) 3.0 (05-14)</p>	 <p>ID: 12, L: 67.5</p>	<p>AR8237 Front Lower Control Arm Bush - Inner Front</p> <p>Fiat Punto (188A5.000) 1.2 Active, Dyna, (188A9.000) 1.3 Dynamic, JTD MultiJet Active, Dyna (2005-), Grand Punto I / II (188A5, 199A4) 1.2, (199A2/3) 1.3D MultiJet, (199A6, 198A4, 350A1) 1.4 16V, (939A1.000) 1.9 MultiJet (06-12); Opel Adam (B10XFT) 1.0T Jam, Glam, Rocks, (A14XER, B14XER) 1.4 (2014-), Adam S (B14NEH) 1.4T (2014-), Corsa D (Z13DTH/J) 1.3 CDTi Enjoy Hatch, (Z14XEP/R) 1.4i Enjoy, Essentia, Cosmo Hatch, Sport, (A14NEL) 1.4T, (16LEL) 1.6i Sport, OPC A/Z (08-15), Corsa E (B10XFT, F10XFT) 1.0T, (B14XEL, B14NEH) 1.4T (2015-)</p>
 <p>ID: 11</p>	<p>AR8228 Rear Stabilizer Bar Bush</p> <p>BMW 3-Series (E92) 320i (N44) 2.0, 325i (N53) 2.5, 335i (N54, N55) 3.0 (02-15) - without M-Sport Suspension</p>	 <p>ID: 12, OD: 72.3, L: 66</p>	<p>AR8238 Front Lower Control Arm Bush - Outer Rear</p> <p>Fiat Punto (188A5.000) 1.2 Active, Dyna, (188A9.000) 1.3 Dynamic, JTD MultiJet Active, Dyna (2005-), Grand Punto I / II (188A5, 199A4) 1.2, (199A2/3) 1.3D MultiJet, (199A6, 198A4, 350A1) 1.4 16V, (939A1.000) 1.9 MultiJet (06-12); Opel Adam (B10XFT) 1.0T Jam, Glam, Rocks, (A14XER, B14XER) 1.4 (2014-), Adam S (B14NEH) 1.4T (2014-), Corsa D (Z13DTH/J) 1.3 CDTi Enjoy Hatch, (Z14XEP/R) 1.4i Enjoy, Essentia, Cosmo Hatch, Sport, (A14NEL) 1.4T, (16LEL) 1.6i Sport, OPC A/Z (08-15), Corsa E (B10XFT, F10XFT) 1.0T, (B14XEL, B14NEH) 1.4T (2015-)</p>
	<p>AR8229 Engine Mounting - Front</p> <p>Opel Astra H (Z14XEP) 1.4 Essentia, (Z16XEP) 1.6 Enjoy, Essentia, (Z18XER) 1.8 Enjoy, Sport, GTC, GTC, Sport (04-10), Zafira II (Z16XEP) 1.6 Essentia MPV, (Z18XEP) 1.8i Enjoy, CD, Elegance MPV (05-09)</p>		<p>AR8239 Engine Mounting - L/RHS</p> <p>Nissan Micra (K12) (CR14DE) 1.4 Comfort, Elegance, SE, Accenta, +, Sport, Visia, (K9K276, K9K722) 1.5dCi Tekna (04-11), NP200 (K9K) 1.5dCi SWB S, SE P/up (2008-); Renault Megane II (K9K722) 1.5dCi 5-Spd. Man. Authentique, Shake It! (02-10), Modus (K4J770/780) 1.4 Expression, Dynamique 5-Spd. Man. (05-08), Scenic II (F4R770/771) 2.0 Dynamique, Privilege MPV (02-10), Grand Scenic II (F4R740/1) 2.0 Expression MPV (05-10)</p>
	<p>AR8230 Engine Mounting - Front</p> <p>Opel Astra H (Z19DT) 1.9 CDTi Enjoy, GTC, Sport (04-10)</p>		<p>AR8241 Engine Mounting - RHS</p> <p>Renault Megane II (F9Q800) 1.9dCi 6-Spd. Man., CC Dynamique, Privilege, Dynamique, '+', (F4R770) 2.0 6-Spd. Man., CC Privilege, Classic Dynamique, (F4R774) 2.0T 6-Spd. Man. Sport, F1 Team (02-10), Scenic II (F9Q812) 1.9dCi Expression, Dynamique Dies. (02-10), Grand Scenic II (F9Q740) 1.9dCi Privilege (JAO5) (05-10)</p>
	<p>AR8231 Engine Mounting - RHS</p> <p>Opel Astra H (Z14XEP) 1.4 Essentia, (Z16XEP) 1.6 Enjoy, Essentia, (Z18XER) 1.8 Enjoy, Sport, GTC, GTC, Sport (04-10), Zafira II (Z16XEP) 1.6 Essentia MPV, (Z18XEP) 1.8i Enjoy, CD, Elegance MPV (05-09)</p>		<p>AR8241 Engine Mounting - RHS</p> <p>Renault Megane II (F9Q800) 1.9dCi 6-Spd. Man., CC Dynamique, Privilege, Dynamique, '+', (F4R770) 2.0 6-Spd. Man., CC Privilege, Classic Dynamique, (F4R774) 2.0T 6-Spd. Man. Sport, F1 Team (02-10), Scenic II (F9Q812) 1.9dCi Expression, Dynamique Dies. (02-10), Grand Scenic II (F9Q740) 1.9dCi Privilege (JAO5) (05-10)</p>
	<p>AR8232 Engine Mounting - RHS</p> <p>Opel Astra H (Z19DT) 1.9 CDTi Enjoy, GTC, Sport Man. (04-10)</p>		<p>AR8241 Engine Mounting - RHS</p> <p>Renault Megane II (F9Q800) 1.9dCi 6-Spd. Man., CC Dynamique, Privilege, Dynamique, '+', (F4R770) 2.0 6-Spd. Man., CC Privilege, Classic Dynamique, (F4R774) 2.0T 6-Spd. Man. Sport, F1 Team (02-10), Scenic II (F9Q812) 1.9dCi Expression, Dynamique Dies. (02-10), Grand Scenic II (F9Q740) 1.9dCi Privilege (JAO5) (05-10)</p>
	<p>AR8233 Engine Mounting - RHS</p> <p>Opel Astra H (Z19DT) 1.9 CDTi Enjoy, GTC, Sport Auto. (04-10)</p>		<p>AR8241 Engine Mounting - RHS</p> <p>Renault Megane II (F9Q800) 1.9dCi 6-Spd. Man., CC Dynamique, Privilege, Dynamique, '+', (F4R770) 2.0 6-Spd. Man., CC Privilege, Classic Dynamique, (F4R774) 2.0T 6-Spd. Man. Sport, F1 Team (02-10), Scenic II (F9Q812) 1.9dCi Expression, Dynamique Dies. (02-10), Grand Scenic II (F9Q740) 1.9dCi Privilege (JAO5) (05-10)</p>

ENGINE MOUNTING & RUBBER BUYERS GUIDE

 <p>ID: 14, OD: 38.3, L: 65</p>	<p>AR8243 Front Lower Control Arm Bush - Inner Front</p> <p>Ford Focus II (IQDB) 1.6 Ambiente, Trend, Si, (QQDB, Q7DA) 1.8, (AODA, AODB, AODE) 2.0, (G6DA, G6DB, G6DD) 2.0 TDCi, (HYDA) 2.5 RS, ST (05-12), Focus III (PNDA) 1.6i, (MGDA) 2.0 TDCi, GDi, GTDi, (R9DA) ST1, ST3 (11-15), Kuga 4X2, 4X4 (JQMB, JQMA) 1.6 Ecoboost, Ambiente, (JTMA) 1.6 Ecoboost Titanium, Trend, (TXDA, TXMA) 2.0 TDCi Titanium, Trend AWD Powershift, (TXDB) 2.5 Turbo, Titanium, Trend AWD (2011-); Mazda 3 (BK, BL) (B6ZE, Z6) 1.6 Original, Active, Dynamic, (LF17) 2.0 Dynamic, Individual, (L3KG) 2.3 Individual MPS, (L5-VE) 2.5 (04-14), 5 (CR19) (LFF7) 2.0 Original, Active, Dynamic, Individual (07-10), 5 (CW) (LFZB) 2.0 (10-14); Volvo C30 (B4164S3) 1.6 Pet., (D4162T) 1.6 D2 Dies., (B4184S11) 1.8, (B4204S3) 2.0i, 2.0D, (B5254T3/7) 2.5i (07-13), C70 (B5254T3/7) 2.5 T5 Sedan (06-13), S40 (D4162T) 1.6 D2, (B4184S11) 1.8i, (B4204S3) 2.0, (D5204T) 2.0 D4, (D4204T) 2.0D, (D5244T13) 2.4 D5, (B5244S4) 2.4i, (B5254T3/7) 2.5i T5 (04-12), V40 (D4162T) 1.6 D2, (B4164T3) 1.6 T3, (B4164T) 1.6 T4, (D5204T6) 2.0 D3, (D5204T4) 2.0 D4 Cross Country, (B5254T12) 2.5 T5 (2012-), V50 1.8, (B4204S3) 2.0i Sedan R-Design, Powershift, (B5244S) 2.0D VS Sedan, 2.4 D5, (B5252FS) 2.4i VS T5 Sedan, (B5254T3/7) 2.5i T5 Sedan R-Design, Geartronic (04-12), S70 (B5254S) 2.4 Estate, (D5252T) 2.5T R Sedan, Estate 5-Spd. Man., 4-Spd. Auto. (97-04), V70 (B5234T4) 2.3 T5 Sedan, Estate (97-04)</p>
 <p>ID: 22</p>	<p>AR8244 Front Lower Control Arm Bush - Outer Rear</p> <p>Ford Focus II (IQDB) 1.6 Ambiente, Trend, Si, (QQDB, Q7DA) 1.8, (AODA, AODB, AODE) 2.0, (G6DA, G6DB, G6DD) 2.0 TDCi, (HYDA) 2.5 RS, ST (05-12), Focus III (PNDA) 1.6i, (MGDA) 2.0 TDCi, GDi, GTDi, (R9DA) ST1, ST3 (11-15), Kuga 4X2, 4X4 (JQMB, JQMA) 1.6 Ecoboost, Ambiente, (JTMA) 1.6 Ecoboost Titanium, Trend, (TXDA, TXMA) 2.0 TDCi Titanium, Trend AWD Powershift, (TXDB) 2.5 Turbo, Titanium, Trend AWD (2011-); Mazda 5 (CR19) (LFF7) 2.0 Original, Active, Dynamic, Individual (07-10), 5 (CW) (LFZB) 2.0 (10-14); Volvo C30 (B4164S3) 1.6 Pet., (D4162T) 1.6 D2 Dies., (B4184S11) 1.8, (B4204S3) 2.0i, 2.0D, (B5254T3/7) 2.5i (07-13), C70 (B5254T3/7) 2.5 T5 Sedan (06-13), S40 (D4162T) 1.6 D2, (B4184S11) 1.8i, (B4204S3) 2.0, (D5204T) 2.0 D4, (D4204T) 2.0D, (D5244T13) 2.4 D5, (B5244S4) 2.4i, (B5254T3/7) 2.5i T5 (04-12), V40 (D4162T) 1.6 D2, (B4164T3) 1.6 T3, (B4164T) 1.6 T4, (D5204T6) 2.0 D3, (D5204T4) 2.0 D4 Cross Country, (B5254T12) 2.5 T5 (2012-), V50 1.8, (B4204S3) 2.0i Sedan R-Design, Powershift, (B5244S) 2.0D VS Sedan, 2.4 D5, (B5252FS) 2.4i VS T5 Sedan, (B5254T3/7) 2.5i T5 Sedan R-Design, Geartronic (04-12), S70 (B5254S) 2.4 Estate, (D5252T) 2.5T R Sedan, Estate 5-Spd. Man., 4-Spd. Auto. (97-04), V70 (B5234T4) 2.3 T5 Sedan, Estate (97-04)</p>
 <p>OD: 60</p>	<p>AR8245 Rear Subframe Bush</p> <p>Ford Focus I (ZH16MEFI) 1.6 Ambiente, Trend, (F9DA) 1.8 TDCi Trend, (ZH20MEFI) 2.0 RS, Trend, ST170 (00-05), Focus II (IQDB) 1.6 Ambiente, Trend, Si, (QQDB, Q7DA) 1.8, (AODA, AODB, AODE) 2.0, (G6DA, G6DB, G6DD) 2.0 TDCi, (HYDA) 2.5 RS, ST (05-12), Focus III (PNDA) 1.6i, (MGDA) 2.0 TDCi, GDi, GTDi, (R9DA) ST1, ST3 (11-15), Kuga 4X2, 4X4 (JQMB, JQMA) 1.6 Ecoboost, Ambiente, (JTMA) 1.6 Ecoboost Titanium, Trend, (TXDA, TXMA) 2.0 TDCi Titanium, Trend AWD Powershift, (TXDB) 2.5 Turbo, Titanium, Trend AWD (2011-); Mazda 3 (BK, BL) (B6ZE, Z6) 1.6 Original, Active, Dynamic, (LF17) 2.0 Dynamic, Individual, (L3KG) 2.3 Individual MPS, (L5-VE) 2.5 (04-14), 5 (CR19) (LFF7) 2.0 Original, Active, Dynamic, Individual (07-10), 5 (CW) (LFZB) 2.0 (10-14); Volvo C30 (B4164S3) 1.6 Pet., (D4162T) 1.6 D2 Dies., (B4184S11) 1.8, (B4204S3) 2.0i, 2.0D, (B5254T3/7) 2.5i (07-13), C70 (B5254T3/7) 2.5 T5 Sedan (06-13), S40 (D4162T) 1.6 D2, (B4184S11) 1.8i, (B4204S3) 2.0, (D5204T) 2.0 D4, (D4204T) 2.0D, (D5244T13) 2.4 D5, (B5244S4) 2.4i, (B5254T3/7) 2.5i T5 (04-12), V50 1.8, (B4204S3) 2.0i Sedan R-Design, Powershift, (B5244S) 2.0D VS Sedan, 2.4 D5, (B5252FS) 2.4i VS T5 Sedan, (B5254T3/7) 2.5i T5 Sedan R-Design, Geartronic (04-12)</p>

	<p>AR8246 Rear Lateral Link Bush</p> <p>Ford Focus I (ZH16MEFI) 1.6 Ambiente, Trend, (F9DA) 1.8 TDCi Trend, (ZH20MEFI) 2.0 RS, Trend, ST170 (00-05), Focus II (IQDB) 1.6 Ambiente, Trend, Si, (QQDB, Q7DA) 1.8, (AODA, AODB, AODE) 2.0, (G6DA, G6DB, G6DD) 2.0 TDCi, (HYDA) 2.5 RS, ST (05-12), Focus III (PNDA) 1.6i, (MGDA) 2.0 TDCi, GDi, GTDi, (R9DA) ST1, ST3 (11-15); Mazda 5 (CR19) (LFF7) 2.0 Original, Active, Dynamic, Individual (07-10); Volvo C30 (B4164S3) 1.6 Pet., (D4162T) 1.6 D2 Dies., (B4184S11) 1.8, (B4204S3) 2.0i, 2.0D, (B5254T3/7) 2.5i (07-13), C70 (B5254T3/7) 2.5 T5 Sedan (06-13), S40 (D4162T) 1.6 D2, (B4184S11) 1.8i, (B4204S3) 2.0, (D5204T) 2.0 D4, (D4204T) 2.0D, (D5244T13) 2.4 D5, (B5244S4) 2.4i, (B5254T3/7) 2.5i T5 (04-12), V50 1.8, (B4204S3) 2.0i Sedan R-Design, Powershift, (B5244S) 2.0D VS Sedan, 2.4 D5, (B5252FS) 2.4i VS T5 Sedan, (B5254T3/7) 2.5i T5 Sedan R-Design, Geartronic (04-12)</p>
 <p>ID: 18.5, L: 38, H: 34.5</p>	<p>AR8247 Rear Stabilizer Bar Bush</p> <p>Volkswagen Caddy (BGU) 1.6i Life Van, MPV, (BJB) 1.9 TDi, Life Van, MPV, (BDJ) 2.0 SDi Van (04-16), (CLCA) 2.0 TDi 5-Spd. Man., (CFHC, CLCB) 2.0 TDi (2010-)</p>
	<p>AR8248 Shackle Bush - Rear Upper</p> <p>Volkswagen Caddy (BGU) 1.6i Life Van, MPV, (BJB) 1.9 TDi, Life Van, MPV, (BDJ) 2.0 SDi Van (04-16), (CLCA) 2.0 TDi 5-Spd. Man., (CFHC, CLCB) 2.0 TDi (2010-)</p>
	<p>AR8249 Shackle Bush - Rear Lower</p> <p>Volkswagen Caddy (BGU) 1.6i Life Van, MPV, (BJB) 1.9 TDi, Life Van, MPV, (BDJ) 2.0 SDi Van (04-16), (CLCA) 2.0 TDi 5-Spd. Man., (CFHC, CLCB) 2.0 TDi (2010-)</p>
	<p>AR8250 Steering Rack Mounting - L/RHS</p> <p>Audi A3 (BVZ) 2.0 FSi, (BMM, CLJA) 2.0 TDi (03-13), (CJZA, CCJZ) 1.2 TFSi, (CXSA) 1.4 TFSi, (CLHA) 1.6 TDi, (CJSA, CJSB) 1.8 TFSi, (DAGA) 2.0 TDi (12-17), S3 (CDLC) 2.0 TFSi (07-13); Seat Altea (BVY, BVZ) 2.0 FSi, (BMM) 2.0 TDi MPV (06-09), Leon (BLR, BLY, BVZ) 2.0 FSi, (BKD, BMM, CFHC, CLCB) 2.0 TDi, (BWA, BWJ, CDLD) 2.0T, FSi (06-09); Volkswagen Golf V (BGU) 1.6i Comfortline, Tiptronic, Trendline, (BLS, BXE) 1.9 TDi Comfortline, DSG, (BKD) 2.0 TDi DSG Sport, Sport Tiptronic, Sport 5-Spd. Man., 6-Spd. Auto., (BLX) 2.0i Trendline, GTi DSG, Comfortline, GTi 5-Spd. Man., 6-Spd. Auto., (BLY) 2.0 FSi Sport, Sport Tiptronic 6-Spd. Man., Auto. (04-09), Golf VI (CAXA, CAVD) 1.4 TSi Trendline, Comfortline, HighLine, (BSE, BSF, CCXA) 1.6i Trendline, (CAYC) 1.6 TDi Comfortline, DSG, Bluemotion, (CBAB, CFFB) 2.0 TDi HighLine, (CCZB) 2.0 GTi DSG, 2.0 TSi-R 4-Motion, DSG (09-13), Jetta V (CAVD, CAXA) 1.4 TSi Trendline, Comfortline, DSG, HighLine, (CAYC) 1.6 TDi Comfortline, DSG (09-11), 1.6i Comfortline, Tiptronic, Trendline, (BKC) 1.9 TDi Comfortline, DSG, (BHY) 2.0i Trendline, DSG, Comfortline, 5-Spd. Man., 6-Spd. Auto., (BHY) 2.0i Trendline, DSG, Comfortline, 5-Spd. Man., 6-Spd. Auto., 2.0 FSi, TFSi, Sportline, Tiptronic 6-Spd. Man./Auto. (05-11), (AZV, BKD, BMM) 2.0 TDi Sportline, Tiptronic, HighLine 5-Spd. Man., 6-Spd. Auto., 2.0 TSi HighLine (2005-), Jetta VI (CBZB) 1.2 TSi, (CAVD, CAXA) 1.4 TSi, (CAYC) 1.6 TDi, (CFHC, CJAA, CLCB) 2.0 TDi (2011-), Scirocco (CAVD) 1.4 TSi, (CDLF) 2.0 TSi, DSG, R (2009-), Tiguan 4X2, 4X4 (BWK, CAVA) 1.4 TSi Trend&Fun, Track&Field, (CBAB) 2.0 TDi Track&Field, Sport&Style, Trend&Fun, (CCZA) 2.0 TSi Track&Field, Sport&Style, 4-Motion (08-11), Touran (BGU, BSE, BSF) 1.6 5-Spd. Man., (BKC, BLS, BXE) 1.9 TDi MPV TrendLine, DSG, (AZV) 2.0 TDi MPV Comfortline, HighLine, DSG, (BLY) 2.0 FSi MPV HighLine (04-11), (CBZB) 1.2 TSi, (CAVC, CTHC) 1.4 TSi, (CFHF, CLCA) 2.0 TDi (2011-)</p>
 <p>ID: 17</p>	<p>AR8251 Rear Stabilizer Bar Bush</p> <p>Seat Altea (BVY, BVZ) 2.0 FSi, (BMM) 2.0 TDi MPV (06-09), Leon (BLR, BLY, BVZ) 2.0 FSi, (BKD, BMM, CFHC, CLCB) 2.0 TDi, (BWA, BWJ, CDLD) 2.0T, FSi (06-09); Volkswagen Golf V (BKD) 2.0 TDi DSG Sport, Sport Tiptronic, Sport 5-Spd. Man., 6-Spd. Auto., (BLX) 2.0i Trendline, GTi DSG, Comfortline, GTi 5-Spd. Man., 6-Spd. Auto., (BLY) 2.0 FSi Sport, Sport Tiptronic 6-Spd. Man., Auto. (04-09)</p>

ENGINE MOUNTING & RUBBER

BUYERS GUIDE

 <p>ID: 21</p>	<p>AR8252 Rear Stabilizer Bar Bush</p> <p>Audi A3 (BVZ) 2.0 FSi, (BMM, CLJA) 2.0 TDi (03-13), (CJZA, CCJZ) 1.2 TFSi, (CXSA) 1.4 TFSi, (CLHA) 1.6 TDi, (CJSA, CJSB) 1.8 TFSi, (DAGA) 2.0 TDi (12-17), S3 (CDLC) 2.0 TFSi (07-13); Seat Altea (BVY, BVZ) 2.0 FSi, (BMM) 2.0 TDi MPV (06-09), Leon (BLR, BLY, BVZ) 2.0 FSi, (BKD, BMM, CFHC, CLCB) 2.0 TDi, (BWA, BWJ, CDLD) 2.0T, FSi (06-09); Volkswagen CC (CFGB) 2.0 TDi, (CCZB) 2.0 TSi, (BWS) 3.6 FSi V6 4-Motion (2009-), Golf V (BKD) 2.0 TDi DSG Sport, Sport Tiptronic, Sport 5-Spd. Man., 6-Spd. Auto., (BLX) 2.0i Trendline, GTi DSG, Comfortline, GTi 5-Spd. Man., 6-Spd. Auto., (BLY) 2.0 FSi Sport, Sport Tiptronic 6-Spd. Man., Auto. (04-09)</p>		<p>AR8269 Transmission Mounting</p> <p>Volkswagen Kombi (T5) 4X2, 4X4 (AXD) 2.5 TDi Crewbus, Beach, California Microbus, Van, P/van, S/cab, D/cab, HO P/up Dies. Man. (04-10)</p>
	<p>AR8253 Rear Stabilizer Bar Bush</p> <p>Audi A4 / A5 (CAPA, CCWA, CDUC, CKVB) 3.0 TDi Quattro, S-Tronic, Tiptronic, A4 (CALA) 3.2 FSi Quattro S-Tronic, A5 (CMUA) 3.0 TFSi Quattro S-Tronic, (CALA) 3.2 FSi Quattro S-Tronic (08-14)</p>	 <p>ID: 14/17, OD: 60, L: 64</p>	<p>AR8271 Front Lower Control Arm Bush - Outer Rear</p> <p>Volkswagen Kombi (T5) 4X2, 4X4 (AXC) 1.9 TDi Crewbus, Microbus, Beach, Van, P/van, S/cab, D/cab P/up Dies., (CAAB, CAAC, CCHA) 2.0 TDi, (CFCA) 2.0 BitDi 4-Motion, (AXD) 2.5 TDi Crewbus, Beach, California Microbus, Van, P/van, S/cab, D/cab, HO P/up Dies. (04-10)</p>
	<p>AR8255 Engine Support Mounting - Rear</p> <p>Audi A1 (CZCA, CZDD) 1.4 TFSi, SE, Sportback 92kw 5-Spd. Man. (15-18); Seat Ibiza III (ASZ, BLT) 1.9 TDi 96kw, (BPX, BUK) 1.9 TDi Cupra 118kw (2006-); Volkswagen Polo (9N) (ASZ, BLT) 1.9 TDi 96kw 6-Spd. Man. (2005-), Polo (6C, GP) (DAJA) 1.8 TSi GTi 141kw 6-Spd. Man. (2016-)</p>	 <p>ID: 14.3, OD: 40.3, L: 60</p>	<p>AR8272 Front Lower Control Arm Bush - Inner Front</p> <p>Volkswagen Kombi (T5) 4X2, 4X4 (AXC) 1.9 TDi Crewbus, Microbus, Beach, Van, P/van, S/cab, D/cab P/up Dies., (CAAB, CAAC, CCHA) 2.0 TDi, (CFCA) 2.0 BitDi 4-Motion, (AXD) 2.5 TDi Crewbus, Beach, California Microbus, Van, P/van, S/cab, D/cab, HO P/up Dies. (04-10)</p>
	<p>AR8256 Engine Mounting - RHS</p> <p>Volkswagen Kombi (T5) 4X2, 4X4 (AXC) 1.9 TDi Crewbus, Microbus, Beach, Van, P/van, S/cab, D/cab P/up Dies., (CAAB, CAAC, CCHA) 2.0 TDi, (CFCA) 2.0 BitDi 4-Motion (04-10)</p>	 <p>ID: 23.2</p>	<p>AR8273 Front Stabilizer Bar Bush</p> <p>Volkswagen Kombi (T5) 4X2, 4X4 (AXC) 1.9 TDi Crewbus, Microbus, Beach, Van, P/van, S/cab, D/cab P/up Dies., (CAAB, CAAC, CCHA) 2.0 TDi, (CFCA) 2.0 BitDi 4-Motion, (AXD) 2.5 TDi Crewbus, Beach, California Microbus, Van, P/van, S/cab, D/cab, HO P/up Dies. (04-10)</p>
	<p>AR8257 Steering Rack Mounting - L/RHS</p> <p>Seat Ibiza (BXW) 1.4 Sport, (BAH) 1.6, 1.9 TDi, Cupra (BPX), 96/118 (ASZ, BLT, BUK) (06-09), Ibiza (BBU) 1.8T, 2.0 (06-09); Volkswagen Polo (9N) (BBY, BKY, BLM) 1.4i, Classic, Trendline, Comfortline, (AMF) 1.4 TDi, Classic, (BAH) 1.6i, Classic Lux, Comfortline, Trendline, SE, (ATD) 1.9 TDi, HighLine, Classic, HighLine, Sportline, (BBU, BJX) 1.8T GTi Classic, Trendline, (ASZ, BBX) 2.0i HighLine, Classic HighLine (02-10), Cross Polo 1.6 TDi, 1.9 TDi (07-10), Polo Vivo (CFWA) 1.2 TDi, (CLPA, CLPB) 1.4i Trendline, (CLSA) 1.6i Trendline (2010-), Polo (6R) (CAVE, CDDA, CGBB, CLPA) 1.4i Trendline, Comfortline, GTi, (CFNA, CLSA) 1.6i Comfortline, Trendline, Tiptronic, (CAYC) 1.6 TDi Comfortline (10-15)</p>		<p>AR8274 Front Strut Mounting</p> <p>Volkswagen Kombi (T5) 4X2, 4X4 (AXC) 1.9 TDi Crewbus, Microbus, Beach, Van, P/van, S/cab, D/cab P/up Dies., (CAAB, CAAC, CCHA) 2.0 TDi, (CFCA) 2.0 BitDi 4-Motion, (AXD) 2.5 TDi Crewbus, Beach, California Microbus, Van, P/van, S/cab, D/cab, HO P/up Dies. (04-10)</p>
	<p>AR8259 Engine Mounting - RHS</p> <p>Volkswagen Kombi (T5) 4X2, 4X4 (AXD) 2.5 TDi Crewbus, Beach, California Microbus, Van, P/van, S/cab, D/cab, HO P/up Dies. (04-10)</p>		<p>AR8275 Rear Axle Trailing Arm Bush - Outer</p> <p>Volkswagen Kombi (T5) 4X2, 4X4 (AXC) 1.9 TDi Crewbus, Microbus, Beach, Van, P/van, S/cab, D/cab P/up Dies., (CAAB, CAAC, CCHA) 2.0 TDi, (CFCA) 2.0 BitDi 4-Motion, (AXD) 2.5 TDi Crewbus, Beach, California Microbus, Van, P/van, S/cab, D/cab, HO P/up Dies. (04-10)</p>
 <p>ID: 12.6, L: 122.5</p>	<p>AR8260 Engine Mounting - Front</p> <p>Volkswagen Kombi (T5) 4X2, 4X4 (AXC) 1.9 TDi Crewbus, Microbus, Beach, Van, P/van, S/cab, D/cab P/up Dies., (CAAB, CAAC, CCHA) 2.0 TDi, (CFCA) 2.0 BitDi 4-Motion, (AXD) 2.5 TDi Crewbus, Beach, California Microbus, Van, P/van, S/cab, D/cab, HO P/up Dies. (04-10)</p>		<p>AR8276 Rear Axle Trailing Arm Bush - Inner</p> <p>Volkswagen Kombi (T5) 4X2, 4X4 (AXC) 1.9 TDi Crewbus, Microbus, Beach, Van, P/van, S/cab, D/cab P/up Dies., (CAAB, CAAC, CCHA) 2.0 TDi, (CFCA) 2.0 BitDi 4-Motion, (AXD) 2.5 TDi Crewbus, Beach, California Microbus, Van, P/van, S/cab, D/cab, HO P/up Dies. (04-10)</p>
	<p>AR8263 Engine Mounting - Rear</p> <p>Volkswagen Kombi (T5) 4X2, 4X4 (AXC) 1.9 TDi Crewbus, Microbus, Beach, Van, P/van, S/cab, D/cab P/up Dies., (CAAB, CAAC, CCHA) 2.0 TDi, (CFCA) 2.0 BitDi 4-Motion, (AXD) 2.5 TDi Crewbus, Beach, California Microbus, Van, P/van, S/cab, D/cab, HO P/up Dies. (04-10)</p>	 <p>NO PICTURE AVAILABLE AT TIME OF PRINT</p>	<p>AR8280 Rear Axle Beam Bush</p> <p>Volkswagen Kombi (T5) 4X2, 4X4 (AXC) 1.9 TDi Crewbus, Microbus, Beach, Van, P/van, S/cab, D/cab P/up Dies., (CAAB, CAAC, CCHA) 2.0 TDi, (CFCA) 2.0 BitDi 4-Motion, (AXD) 2.5 TDi Crewbus, Beach, California Microbus, Van, P/van, S/cab, D/cab, HO P/up Dies. (04-10)</p>
	<p>AR8265 Engine Mounting - Rear</p> <p>Volkswagen Kombi (T5) 4X4 (AXD) 2.5 TDi Crewbus, Beach, California Microbus, Van, P/van, S/cab, D/cab, HO P/up Dies. (04-10)</p>		<p>AR8281 Rear Axle Carrier Bush - Front</p> <p>Volkswagen Kombi (T5) 4X2, 4X4 (AXC) 1.9 TDi Crewbus, Microbus, Beach, Van, P/van, S/cab, D/cab P/up Dies., (CAAB, CAAC, CCHA) 2.0 TDi, (CFCA) 2.0 BitDi 4-Motion, (AXD) 2.5 TDi Crewbus, Beach, California Microbus, Van, P/van, S/cab, D/cab, HO P/up Dies. (04-10)</p>
	<p>AR8266 Transmission Mounting</p> <p>Volkswagen Kombi (T5) 4X2, 4X4 (AXC) 1.9 TDi Crewbus, Microbus, Beach, Van, P/van, S/cab, D/cab P/up Dies., (CAAB, CAAC, CCHA) 2.0 TDi, (CFCA) 2.0 BitDi 4-Motion (04-10)</p>	 <p>NO PICTURE AVAILABLE AT TIME OF PRINT</p>	<p>AR8282 Rear Axle Carrier Bush - Rear</p> <p>Volkswagen Kombi (T5) 4X2, 4X4 (AXC) 1.9 TDi Crewbus, Microbus, Beach, Van, P/van, S/cab, D/cab P/up Dies., (CAAB, CAAC, CCHA) 2.0 TDi, (CFCA) 2.0 BitDi 4-Motion, (AXD) 2.5 TDi Crewbus, Beach, California Microbus, Van, P/van, S/cab, D/cab, HO P/up Dies. (04-10)</p>

ENGINE MOUNTING & RUBBER BUYERS GUIDE

333

 ID: 14, OD: 39, L: 55	AR8284 Front Lower Control Arm Bush - Inner Front Nissan X-Trail (T30) 4X2 (QR20DE) 2.0 5-Spd. Man., 4X4 (YD22ETI) 2.2D 6-Spd. Man., 4X4 (QR25DE) 2.5 5-Spd. Man., 4X4 (QR25DE) 2.5 SE 4-Spd. Auto. (01-07)	 ID: 17, OD: 58, L: 62	AR8295 Front Lower Control Arm Bush - Inner Front Daihatsu Materia (3S2-VE) 1.5i (07-11), Sirion (K3-VE) 1.3 CX, (3S2-VE) 1.5i Sport (02-14), Terios 4X2, 4X4 (K3-VE) 1.3, (3S2-VE) 1.5i (02-15)
 ID: 28	AR8285 Front Lower Control Arm Bush - Outer Rear Nissan X-Trail (T30) 4X2 (QR20DE) 2.0 5-Spd. Man., 4X4 (YD22ETI) 2.2D 6-Spd. Man., 4X4 (QR25DE) 2.5 5-Spd. Man., 4X4 (QR25DE) 2.5 SE 4-Spd. Auto. (01-07)		AR8297 Engine Mounting - LHS BMW 3-Series (E90) 323i (N52N) 2.5, 325i (N53) 2.5, 330i (N52, N53) 3.0, 330d (M57, N57) 3.0 (05-13), 335i (N55) 3.0 (2007-)
 NO PICTURE AVAILABLE AT TIME OF PRINT ID: 28	AR8285I Lower Control Arm Bush - Rear, Outer (Insert Only) Nissan X-Trail (T30) 4X2 (QR20DE) 2.0 5-Spd. Man., 4X4 (YD22ETI) 2.2D 6-Spd. Man., 4X4 (QR25DE) 2.5 5-Spd. Man., 4X4 (QR25DE) 2.5 SE 4-Spd. Auto. (01-07)		AR8298 Engine Mounting - RHS BMW 3-Series (E90) 323i (N52N) 2.5, 325i (N53) 2.5, 330i (N52, N53) 3.0, 330d (M57, N57) 3.0 (05-13), 330d (N57) 3.0 (2007-)
	AR8286 Front Lower Control Arm Bush - Inner Honda Civic VIII (R18A2) 1.8i VXi 6-Spd. Man (06-11)		AR8299 Rear Axle X-Member Bush - Front Mercedes-Benz (W204) C-Class (M271.910, M271.952) C180K , (M271.950) C200K , (OM651.911) C220 CDI , (M272.947) C300 , (OM642.960) C350 CDI , (M272.961) C350 (07-14)
 ID: 28, L: 50	AR8287 Front Lower Control Arm Bush - Inner Front TATA Indica / Vista 1.4 LEi, LSi, LX, LXi, 1.4 TDi DLX, DL (2005-), Indigo 1.4 GLX, GLS, GSX S/W, 1.4 TDi DLX S/W (2005-)		AR8300 Transmission Mounting Mercedes-Benz (W203) C-Class C240 (M203.086) 2.6 V6 Elegance, S/W, Elegance S/W, C270 (OM612.962) 2.7 CDI 5-Cyl. Elegance, S/W, C320 (M111.946) 3.2 V6 Avantgarde Elegance, SW, (M271.946) C180K , (M271.940) C200K , (OM611.962, OM646.963) C220 CDI , (M271.948) C230K , (M112.912) C240/240T , (OM642.910) C320 CDI , (M272.960) C350 (00-11)
 ID: 20, OD: 60, L: 49, H: 54	AR8288 Front Lower Control Arm Bush - Outer Rear TATA Indica / Vista 1.4 LEi, LSi, LX, LXi, 1.4 TDi DLX, DL (2005-), Indigo 1.4 GLX, GLS, GSX S/W, 1.4 TDi DLX S/W (2005-)		AR8301 Front Stabilizer Bar Bush Honda Civic VIII (R18A2) 1.8i VXi 6-Spd. Man (06-11)
	AR8289 Engine Mounting - RHS Daihatsu Materia (3S2-VE) 1.5i (07-11), Sirion (K3-VE) 1.3 CX, (3S2-VE) 1.5i Sport (02-14), Terios 4X2, 4X4 (K3-VE) 1.3, (3S2-VE) 1.5i (02-15)		AR8302 Engine Mounting - RHS Nissan X-Trail (T30) 4X2 (QR20DE) 2.0 5-Spd. Man., 4X4 (QR25DE) 2.5 5-Spd. Man., 4X4 (QR25DE) 2.5 SE 4-Spd. Auto. (01-07)
	AR8290 Engine Mounting - LHS Daihatsu Materia (3S2-VE) 1.5i (07-11), Sirion (K3-VE) 1.3 CX, (3S2-VE) 1.5i Sport (02-14), Terios 4X2, 4X4 (K3-VE) 1.3, (3S2-VE) 1.5i (02-15)		AR8303 Engine Mounting - Rear Nissan X-Trail (T30) 4X2 (QR20DE) 2.0 5-Spd. Man., 4X4 (YD22ETI) 2.2D 6-Spd. Man., 4X4 (QR25DE) 2.5 5-Spd. Man., 4X4 (QR25DE) 2.5 SE 4-Spd. Auto. (01-07)
	AR8291 Transmission Mounting Daihatsu Materia (3S2-VE) 1.5i (07-11), Sirion (K3-VE) 1.3 CX, (3S2-VE) 1.5i Sport (02-14), Terios 4X2, 4X4 (K3-VE) 1.3, (3S2-VE) 1.5i (02-15)		AR8304 Transmission Mounting Nissan X-Trail (T30) 4X2 (QR20DE) 2.0 5-Spd. Man., 4X4 (YD22ETI) 2.2D 6-Spd. Man., 4X4 (QR25DE) 2.5 5-Spd. Man. (01-07)
	AR8292 Engine Mounting - RHS Daihatsu Charade (1KR-FE) 1.0 Celeb, Classic (03-11)		AR8305 Transmission Mounting Nissan X-Trail (T30) 4X4 (QR25DE) 2.5 SE 4-Spd. Auto. (01-07)
	AR8293 Engine Mounting - LHS Daihatsu Charade (1KR-FE) 1.0 Celeb, Classic (03-11)	 ID: 10, OD: 29, L: 52	AR8306 Front Lower Control Arm Bush - Inner Chana Star 1.0 Club Cab, 1.3 Single Cab (06-12)
	AR8294 Transmission Mounting Daihatsu Charade (1KR-FE) 1.0 Celeb, Classic (03-11)		AR8307L Front Lower Control Arm Bush - Outer LHS Fiat Palio I (178B5.000) 1.2 ED, EL, Go!, Paint Ltd. M657.12T, (178B3.000) 1.6 EL, ELX, HL, Weekend SW (00-02), Siena I (178B5.000) 1.2 EL, EL+ M657.12T, (178B3.000) 1.6 EL+, HL, ELX (00-02) - P/S

ENGINE MOUNTING & RUBBER BUYERS GUIDE

	<p>AR8307R Front Lower Control Arm Bush - Outer RHS</p> <p>Fiat Palio I / II (178B5.000) 1.2 ED, EL, Go!, Paint Ltd. M657.12T, (178B3.000) 1.6 EL, ELX, HL, Weekend SW (00-10), Siena I / II (178B5.000) 1.2 EL, EL+ M657.12T, (178B3.000) 1.6 EL+, HL, ELX (00-10) - P/S</p>		<p>AR8320 Front Upper Control Arm Bush - Inner & Outer</p> <p>GWM Steed 2.2i D/cab Lux, Multi-Wagon (07-11), Steed 4X4 2.2i D/cab Lux, Multi-Wagon (07-11); Isuzu KB-Series KB220 Fleetside P/up, KB240i LE, D/C LE, Fleetside P/up, KB250D, DC LE, D/C LE, Fleetside P/up, D-TEQ, KB300 TDC TDi LX, D/C LX, Fleetside P/up, Hi-Rider, D-MAX (04-13), KB-Series D-TEQ 4X4 KB240i LE, D/C LE, Fleetside P/up, KB250D LE, D/C LE, Fleetside P/up, KB300TDi LX, D/C LX, Fleetside, "GO Big" P/up Hi-Rider (04-12)</p> <p>ID: 14, OD: 43, L: 45</p>
	<p>AR8308L Lower Control Arm Bush - Outer LHS</p> <p>Fiat Palio I / II (178B5.000) 1.2 ED, EL, Go!, Paint Ltd. M657.12T, (178B3.000) 1.6 EL, ELX, HL, Weekend SW (00-10), Siena I / II (178B5.000) 1.2 EL, EL+ M657.12T, (178B3.000) 1.6 EL+, HL, ELX (00-10) - M/S</p>		<p>AR8321 Front Lower Control Arm Bush - Inner & Outer</p> <p>Isuzu KB-Series KB220 Fleetside P/up, KB240i LE, D/C LE, Fleetside P/up, KB250D, DC LE, D/C LE, Fleetside P/up, D-TEQ, KB300 TDC TDi LX, D/C LX, Fleetside P/up, Hi-Rider, D-MAX (04-13), KB-Series D-TEQ 4X4 KB240i LE, D/C LE, Fleetside P/up, KB250D LE, D/C LE, Fleetside P/up, KB300TDi LX, D/C LX, Fleetside, "GO Big" P/up Hi-Rider (04-12)</p> <p>ID: 16, OD: 43, L: 57</p>
	<p>AR8308R Lower Control Arm Bush - Outer RHS</p> <p>Fiat Palio I / II (178B5.000) 1.2 ED, EL, Go!, Paint Ltd. M657.12T, (178B3.000) 1.6 EL, ELX, HL, Weekend SW (00-10), Siena I / II (178B5.000) 1.2 EL, EL+ M657.12T, (178B3.000) 1.6 EL+, HL, ELX (00-10) - M/S</p>		<p>AR8322 Front Upper Control Arm Bush - Inner Front & Rear</p> <p>Mercedes-Benz (W211) E-Class E220 CDi (OM646.961) 2.2, E240 (M112.913) 2.6, E280 (M272.943) 3.0, E320 (M112.949) 3.2 (02-10), (W211) E-Class (M271.941/956) E200K, (OM647.961) E270 CDi, (M112.949) E320, (OM642.920) E320 CDi, (M272.964) E350, (M113.967) E500 (02-10)</p>
	<p>AR8310 Front Upper Control Arm Bush - Inner & Outer</p> <p>Isuzu KB-Series D-TEQ 4X4 KB240i LE, D/C LE, Fleetside P/up, KB250D LE, D/C LE, Fleetside P/up, KB300TDi LX, D/C LX, Fleetside (04-12)</p> <p>ID: 16, OD: 36, L: 43</p>		<p>AR8323 Front Lower Control Arm Bush - Inner Front</p> <p>Mercedes-Benz (W211) E-Class E220 CDi (OM646.961) 2.2, E240 (M112.913) 2.6, E280 (M272.943) 3.0, E320 (M112.949) 3.2 (02-10), (W211) E-Class (M271.941/956) E200K, (OM647.961) E270 CDi, (M112.949) E320, (OM642.920) E320 CDi, (M272.964) E350, (M113.967) E500 (02-10)</p> <p>ID: 24, OD: 70.5, L: 80</p>
	<p>AR8312 Engine Mounting - RHS</p> <p>Isuzu KB-Series KB220 Fleetside P/up, KB240i LE, D/C LE, Fleetside P/up, KB250D, DC LE, D/C LE, Fleetside P/up, D-TEQ, KB300 TDC TDi LX, D/C LX, Fleetside P/up, Hi-Rider, D-MAX (04-13), KB-Series D-TEQ 4X4 KB240i LE, D/C LE, Fleetside P/up, KB250D LE, D/C LE, Fleetside P/up, KB300TDi LX, D/C LX, Fleetside, "GO Big" P/up Hi-Rider (04-12)</p>		<p>AR8325 Front Lower Control Arm Bush - Inner Rear Outer</p> <p>Mercedes-Benz (W211) E-Class E220 CDi (OM646.961) 2.2, E240 (M112.913) 2.6, E280 (M272.943) 3.0, E320 (M112.949) 3.2 (02-10)</p> <p>ID: 14, OD: 52, L: 56</p>
	<p>AR8313 Engine Mounting - LHS</p> <p>Isuzu KB-Series KB220 Fleetside P/up, KB240i LE, D/C LE, Fleetside P/up, KB250D, DC LE, D/C LE, Fleetside P/up, D-TEQ, KB300 TDC TDi LX, D/C LX, Fleetside P/up, Hi-Rider, D-MAX (04-13), KB-Series D-TEQ 4X4 KB240i LE, D/C LE, Fleetside P/up, KB250D LE, D/C LE, Fleetside P/up, KB300TDi LX, D/C LX, Fleetside, "GO Big" P/up Hi-Rider (04-12)</p>		<p>AR8326 Engine Mounting - LHS</p> <p>Chana Star 1.0 Club Cab (06-12)</p>
	<p>AR8314 Front Lower Control Arm Bush - Inner</p> <p>Chevrolet Aveo (T200) (F15S, LX6) 1.5 L, LS, LT, (A16DMS, LXV) 1.6 LT (03-15), Sonic (LSF) 1.3D, (A14XER) 1.4, (F16D4) 1.6 (11-16)</p> <p>ID: 12, OD: 28/32, W: 47</p>		<p>AR8327 Engine Mounting - RHS</p> <p>Chana Star 1.0 Club Cab (06-12)</p>
	<p>AR8315 Front Lower Control Arm Bush - Outer</p> <p>Chevrolet Aveo (T200) (F15S, LX6) 1.5 L, LS, LT, (A16DMS, LXV) 1.6 LT (03-15), Sonic (LSF) 1.3D, (A14XER) 1.4, (F16D4) 1.6 (11-16)</p> <p>ID: 12, OD: 60, W: 46</p>		<p>AR8328 Engine Mounting - Front</p> <p>Toyota Auris (4ZZ-FE) 1.4 RT, RS, (1ZR-FE) 1.6 RT, XI, XS, Sport X, XR, (2ZR-FAE) 1.8 RS, RX (07-13), (1NR-FE) 1.3, (1ZR-FAE) 1.6, 1.6 TRD (2010-), Corolla (1NR-FE) 1.3 Advanced, Impact, Professional, 6-Spd. Man., (1ZR-FE) 1.6 Advanced, Professional, Sprinter, 6-Spd. Man., 4-Spd. Auto., (2ZR-FE) 1.8 Advanced, Exclusive, 6-Spd. Man., 4-Spd. Auto., (3ZR-FE) 2.0 Sprinter, Exclusive, 6-Spd. Man./Auto. (2007-), Corolla (E180) (1NR-FE) 1.3 Esteem, Prestige 6-Spd. Man., (1ND-TV) 1.4D-4D Esteem, Prestige 6-Spd. Man., (1ZR-FE) 1.6 Prestige 6-Spd. Man. (14-19), Corolla Quest (1ZR-FE) 1.6 (2014-)</p>
	<p>AR8316 Front Strut Mounting</p> <p>Chevrolet Aveo (T200) (F15S, LX6) 1.5 L, LS, LT, (A16DMS, LXV) 1.6 LT (03-15), Sonic (LSF) 1.3D, (A14XER) 1.4, (F16D4) 1.6 (11-16), Spark, Spark Lite (M200, M250) (F8CV) 0.8 L, LS, (B10S1) 1.0 LS, LT (2005-); Daewoo Matiz (F8CV) 800cc S, SE (99-03)</p>		<p>AR8329 Engine Mounting - Rear</p> <p>Toyota Auris (4ZZ-FE) 1.4 RT, RS, (1ZR-FE) 1.6 RT, XI, XS, Sport X, XR, (2ZR-FAE) 1.8 RS, RX (07-13), (1NR-FE) 1.3, (1ZR-FAE) 1.6, 1.6 TRD (2010-), Corolla (1NR-FE) 1.3 Advanced, Impact, Professional, 6-Spd. Man., (1ZR-FE) 1.6 Advanced, Professional, Sprinter, 6-Spd. Man., 4-Spd. Auto., (2ZR-FE) 1.8 Advanced, Exclusive, 6-Spd. Man., 4-Spd. Auto., (3ZR-FE) 2.0 Sprinter, Exclusive, 6-Spd. Man./Auto. (2007-), Corolla (E180) (1NR-FE) 1.3 Esteem, Prestige 6-Spd. Man., (1ND-TV) 1.4D-4D Esteem, Prestige 6-Spd. Man., (1ZR-FE) 1.6 Prestige 6-Spd. Man. (14-19), Corolla Quest (1ZR-FE) 1.6 (2014-)</p>
	<p>AR8317 Transmission Mounting</p> <p>Chana Star 1.0 Club Cab (06-12)</p>		<p>AR8318 Engine Mounting - LHS</p> <p>GWM Steed 2.2i D/cab Lux, Multi-Wagon (07-11), Steed 4X4 2.2i D/cab Lux, Multi-Wagon (07-11)</p>
	<p>AR8318 Engine Mounting - LHS</p> <p>GWM Steed 2.2i D/cab Lux, Multi-Wagon (07-11), Steed 4X4 2.2i D/cab Lux, Multi-Wagon (07-11)</p>		<p>AR8319 Engine Mounting - RHS</p> <p>GWM Steed 2.2i D/cab Lux, Multi-Wagon (07-11), Steed 4X4 2.2i D/cab Lux, Multi-Wagon (07-11)</p>

ENGINE MOUNTING & RUBBER BUYERS GUIDE

	AR8330 Engine Mounting - LHS Toyota Auris (4ZZ-FE) 1.4 RT, RS, (1ZR-FE) 1.6 RT, XI, XS, Sport X, XR, (2ZR-FAE) 1.8 RS, RX (07-13), Corolla (1ZR-FE) 1.6 Advanced, Professional, Sprinter, 6-Spd. Man., 4-Spd. Auto., (2ZR-FE) 1.8 Advanced, Exclusive, 6-Spd. Man., 4-Spd. Auto., (3ZR-FE) 2.0 Sprinter, Exclusive, 6-Spd. Man./Auto.(2007-), Corolla Quest (1ZR-FE) 1.6 (2014-)
	AR8331 Engine Mounting - RHS Toyota Auris (4ZZ-FE) 1.4 RT, RS (07-13)
 ID: 14	AR8332 Front Strut Mounting Toyota Auris (4ZZ-FE) 1.4 RT, RS, (1ZR-FE) 1.6 RT, XI, XS, Sport X, XR, (2ZR-FAE) 1.8 RS, RX, (1AD-FTV) 2.0 D-4D RS, RX, Turbo, XD (07-13), (1NR-FE) 1.3, (1ZR-FAE) 1.6, 1.6 TRD, 1.8 HSD (2010-), Corolla (1NR-FE) 1.3 Advanced, Impact, Professional, 6-Spd. Man., (1ZR-FE) 1.6 Advanced, Professional, Sprinter, 6-Spd. Man., 4-Spd. Auto., (2ZR-FE) 1.8 Advanced, Exclusive, 6-Spd. Man., 4-Spd. Auto., (3ZR-FE) 2.0 Sprinter, Exclusive, 6-Spd. Man./Auto., (1AD-FTV) 2.0D-4D Advanced, Exclusive 6-Spd. Man. (2007-), Corolla (E180) (1NR-FE) 1.3 Esteem, Prestige, (1ND-TV) 1.4D-4D Esteem, Prestige, (1ZR-FE) 1.6 Esteem, Prestige, (2ZR-FE) 1.8 16V Exclusive, Prestige (14-19), Corolla Quest (1ZR-FE) 1.6 (2014-), RAV4 III (ACE, ALA) 4X4 (1AZ-FE) 2.0 GX, VX, Fierce SUV Pet., 5-Spd. Man., 4-Spd. Auto., (2AD-FTV) 2.2D-4D GX, VX Dies. 5-Spd. Man. (06-13)
 ID: 22, L: 52, H: 47, W: 63	AR8333 Front Stabilizer Bar Bush - LHS Toyota Auris (4ZZ-FE) 1.4 RT, RS, (1ZR-FE) 1.6 RT, XI, XS, Sport X, XR, (2ZR-FAE) 1.8 RS, RX, (1AD-FTV) 2.0 D-4D RS, RX, Turbo, XD (07-13), (1NR-FE) 1.3, (1ZR-FAE) 1.6, 1.6 TRD, 1.8 HSD (2010-), Corolla (1NR-FE) 1.3 Advanced, Impact, Professional, 6-Spd. Man., (1ZR-FE) 1.6 Advanced, Professional, Sprinter, 6-Spd. Man., 4-Spd. Auto., (2ZR-FE) 1.8 Advanced, Exclusive, 6-Spd. Man., 4-Spd. Auto., (3ZR-FE) 2.0 Sprinter, Exclusive, 6-Spd. Man./Auto., (1AD-FTV) 2.0D-4D Advanced, Exclusive 6-Spd. Man. (2007-), Corolla (E180) (1NR-FE) 1.3 Esteem, Prestige, (1ND-TV) 1.4D-4D Esteem, Prestige, (1ZR-FE) 1.6 Esteem, Prestige, (2ZR-FE) 1.8 16V Exclusive, Prestige (14-19), Corolla Quest (1ZR-FE) 1.6 (2014-)
 ID: 21, L: 52, H: 47, W: 63	AR8334 Front Stabilizer Bar Bush - RHS Toyota Auris (4ZZ-FE) 1.4 RT, RS, (1ZR-FE) 1.6 RT, XI, XS, Sport X, XR, (2ZR-FAE) 1.8 RS, RX, (1AD-FTV) 2.0 D-4D RS, RX, Turbo, XD (07-13), (1NR-FE) 1.3, (1ZR-FAE) 1.6, 1.6 TRD, 1.8 HSD (2010-), Corolla (1NR-FE) 1.3 Advanced, Impact, Professional, 6-Spd. Man., (1ZR-FE) 1.6 Advanced, Professional, Sprinter, 6-Spd. Man., 4-Spd. Auto., (2ZR-FE) 1.8 Advanced, Exclusive, 6-Spd. Man., 4-Spd. Auto., (3ZR-FE) 2.0 Sprinter, Exclusive, 6-Spd. Man./Auto., (1AD-FTV) 2.0D-4D Advanced, Exclusive 6-Spd. Man. (2007-), Corolla (E180) (1NR-FE) 1.3 Esteem, Prestige, (1ND-TV) 1.4D-4D Esteem, Prestige, (1ZR-FE) 1.6 Esteem, Prestige, (2ZR-FE) 1.8 16V Exclusive, Prestige (14-19), Corolla Quest (1ZR-FE) 1.6 (2014-)
	AR8335 Transmission Mounting Mitsubishi Colt LDV 4X4 (K65/75T) 2.4i LWB S/cab, Hi-Line, D/cab, Trailbuster S/cab, P/up Pet., (K77T) 2.8D LWB S/cab, P/up Dies., (K77T) 2.8TD LWB Rodeo D/cab, P/up Turbo Dies., (6G72, K76T) 3.0i V6 LWB Rodeo D/cab, ClubCab, P/up Pet. (04-09), Colt LDV 2.0 LWB P/up, 2.0i LWB Hi-Line P/up (04-09)
	AR8338 Engine Mounting - LHS Mitsubishi Colt LDV 4X4 (K65/75T) 2.4i LWB S/cab, Hi-Line, D/cab, Trailbuster S/cab, P/up Pet., (K77T) 2.8D LWB S/cab, P/up Dies., (K77T) 2.8TD LWB Rodeo D/cab, P/up Turbo Dies., (6G72, K76T) 3.0i V6 LWB Rodeo D/cab, ClubCab, P/up Pet. (04-09), Colt LDV 2.0 LWB P/up, 2.0i LWB Hi-Line P/up (04-09)
	AR8339 Engine Mounting - L/RHS Mitsubishi Pajero 4X4 (4D56) 2.5 Di-D, (4M41) 3.2 Di-DC, (4M41) 3.2 Di-D (2009-), Triton 4X2, 4X4 2.4 MPI D/cab P/up, 2.5 Di-D Clubcab P/up, 3.2 Di-D D/cab P/up, 3.5 MPI Clubcab P/up (2007-)







	AR8340 Front Stabilizer Bar Bush Mitsubishi Pajero 4X4 (4D56) 2.5 Di-D, (4M41) 3.2 Di-DC, (4M41) 3.2 Di-D (2009-), Triton 4X2, 4X4 2.4 MPI D/cab P/up, 2.5 Di-D Clubcab P/up, 3.2 Di-D D/cab P/up, 3.5 MPI Clubcab P/up (2007-)
	AR8341 Transmission Mounting Mitsubishi Pajero 4X4 (4D56) 2.5 Di-D, (4M41) 3.2 Di-DC, (4M41) 3.2 Di-D (2009-), Triton 4X2, 4X4 2.4 MPI D/cab P/up, 2.5 Di-D Clubcab P/up, 3.2 Di-D D/cab P/up, 3.5 MPI Clubcab P/up (2007-)
	AR8342 Front Lower Control Arm Bush - Inner Mitsubishi Pajero 4X4 (4D56) 2.5 Di-D, (4M41) 3.2 Di-DC, (4M41) 3.2 Di-D (2009-), Triton 4X2, 4X4 2.4 MPI D/cab P/up, 2.5 Di-D Clubcab P/up, 3.2 Di-D D/cab P/up, 3.5 MPI Clubcab P/up (2007-)
	AR8343 Front Strut Mounting Mitsubishi Pajero 4X4 (4D56) 2.5 Di-D, (4M41) 3.2 Di-DC, (4M41) 3.2 Di-D (2009-), Triton 4X2, 4X4 2.4 MPI D/cab P/up, 2.5 Di-D Clubcab P/up, 3.2 Di-D D/cab P/up, 3.5 MPI Clubcab P/up (2007-)
	AR8345 Engine Mounting - LHS Toyota Avensis (1AZ-FSE) 2.0 Advanced, (2AZ-FSE) 2.4 Exclusive (06-09)
	AR8346 Engine Mounting - Rear Toyota Avensis (1AZ-FSE) 2.0 Advanced (06-09)
	AR8347 Engine Mounting - RHS Toyota Avensis (1AZ-FSE) 2.0 Advanced, (2AD-FTV) 2.2 D-4D Exclusive (06-09)
	AR8348 Engine Mounting - Front Toyota Avensis (2AZ-FSE) 2.4 Exclusive (06-09)
	AR8349 Engine Mounting - Rear Toyota Avensis (2AZ-FSE) 2.4 Exclusive (06-09)
	AR8350 Engine Mounting - Front Toyota Avensis (2AD-FTV) 2.2 D-4D Exclusive (06-09)
	AR8351 Engine Mounting - Rear Toyota Avensis (2AD-FTV) 2.2 D-4D Exclusive (06-09)
	AR8352 Engine Mounting - LHS Toyota Avensis (2AD-FTV) 2.2 D-4D Exclusive (06-09)
	AR8353 Engine Mounting - RHS Toyota Avensis (2AD-FTV) 2.2 D-4D Exclusive (06-09)

ENGINE MOUNTING & RUBBER BUYERS GUIDE

	AR8354 Front Strut Mounting Toyota Avensis (1AZ-FSE) 2.0 Advanced, (2AD-FTV) 2.2 D-4D Exclusive, (2AZ-FSE) 2.4 Exclusive (06-09)		AR8364 Transmission Mounting Nissan Juke 4X2, 4X4 (K9K) 1.5dCi 6-Spd. Man., (HR16DE) 1.6 5-Spd. Man., (MR16DDT) 1.6 DIG-T M-CVT AWD (2011-), Livina (HR16DE) 1.6 5-Spd. Man. Acenta, Acenta+, Visia, X-Gear Vista, Grand Livina (HR16DE) 1.6 5-Spd. Man. Acenta, Acenta+ (07-15), Sentra (HR16DE) 1.6 5-Spd. Man., CVT (2013-), Tiida (HR16DE) 1.6 Visia, Visia +, Acenta 5-Spd. Man., (MR18DE) 1.8 6-Spd. Man. (06-13)
	AR8355 Front Stabilizer Bar Bush Toyota Avensis (1AZ-FSE) 2.0 Advanced, (2AD-FTV) 2.2 D-4D Exclusive, (2AZ-FSE) 2.4 Exclusive (06-09)		AR8365 Front Stabilizer Bar Bush Nissan Livina (HR16DE) 1.6 Acenta, Acenta+, Visia, X-Gear Vista (07-15), Grand Livina (HR16DE) 1.6 Acenta, Acenta+ (07-15), NV200 (M20) (K9K) 1.5dCi, (HR16DE) 1.6 (2013-), Tiida (HR16DE) 1.6 Visia, Visia +, Acenta, (MR18DE) 1.8 Acenta (06-13)
	AR8356 Engine Mounting - LHS, Transmission Mounting TATA Indica / Vista 1.4 LEi, LSi, LX, LXi, 1.4 TDi DLX, DL (2005-), Indigo 1.4 GLX, GLS, GSX S/W, 1.4 TDi DLX S/W (2005-) - Petrol Models Only		AR8366 Front Lower Control Arm Bush - Inner Ford Everest 4X2, 4X4 3.0 TDCi (09-15), Ranger 2.5D TD XL D/cab, XLT, SubCab, XLT Hi Trail, Super Cab XLT LWB P/up Dies., 3.0 TDCi D/cab XLE, SubCab XLT, Hi Trail, Super Cab XLT LWB P/up Dies. (07-12); Mazda BT-50 4X2, 4X4 2.5 TDi SLX D/cab P/up, 2.6 SLE D/cab, S/cab, P/up, (WLE7) 3.0 CRDi D/cab, SLE S/cab, CRDi SLX P/up (07-12)
	AR8357 Engine Mounting - RHS TATA Indica / Vista 1.4 LEi, LSi, LX, LXi, 1.4 TDi DLX, DL (2005-), Indigo 1.4 GLX, GLS, GSX S/W, 1.4 TDi DLX S/W (2005-)		AR8367 Front Upper Control Arm Bush - Inner & Outer Ford Everest 4X2, 4X4 3.0 TDCi (09-15), Ranger 2.5D TD XL D/cab, XLT, SubCab, XLT Hi Trail, Super Cab XLT LWB P/up Dies., 3.0 TDCi D/cab XLE, SubCab XLT, Hi Trail, Super Cab XLT LWB P/up Dies. (07-12); Mazda BT-50 4X2, 4X4 2.5 TDi SLX D/cab P/up, 2.6 SLE D/cab, S/cab, P/up, (WLE7) 3.0 CRDi D/cab, SLE S/cab, CRDi SLX P/up (07-12), Drifter 2.6i LWB SL Hi Ride S/cab, SLE D/C, SLX, Hi Ride, SLX Hi Ride D/cab (00-08)
	AR8358 Front Lower Control Arm Bush - Inner Hyundai H100 (4D56) 2.5i DT LWB P/up, Dropside Dies., (4G54) 2.6i LWB P/van, Dropside Pet. (04-09)		AR8368 Shock Rubber - Front Ford Ranger 2.5D TD XL D/cab, XLT, SubCab, XLT Hi Trail, Super Cab XLT LWB P/up Dies., 3.0 TDCi D/cab XLE, SubCab XLT, Hi Trail, Super Cab XLT LWB P/up Dies. (07-12); Mazda BT-50 4X2, 4X4 2.5 TDi SLX D/cab P/up, 2.6 SLE D/cab, S/cab, P/up, (WLE7) 3.0 CRDi D/cab, SLE S/cab, CRDi SLX P/up (07-12)
	AR8359 Front Strut Mounting Mercedes-Benz (W211) E-Class E220 CDi (OM646.961) 2.2, E240 (M112.913) 2.6, E280 (M272.943) 3.0, E320 (M112.949) 3.2 (02-10), (W211) E-Class (M271.941/956) E200K , (OM647.961) E270 CDi, (M112.949) E320 , (OM642.920) E320 CDi, (M272.964) E350 , (M113.967) E500 (02-10)		AR8369 Front Stabilizer Bar Bush Ford Ranger 2.5D TD XL D/cab, XLT, SubCab, XLT Hi Trail, Super Cab XLT LWB P/up Dies., 3.0 TDCi D/cab XLE, SubCab XLT, Hi Trail, Super Cab XLT LWB P/up Dies. (07-12); Mazda BT-50 4X2, 4X4 2.5 TDi SLX D/cab P/up, 2.6 SLE D/cab, S/cab, P/up, (WLE7) 3.0 CRDi D/cab, SLE S/cab, CRDi SLX P/up (07-12)
	AR8360 Front Lower Control Arm Bush - Inner Front Nissan Livina (HR16DE) 1.6 Acenta, Acenta+, Visia, X-Gear Vista (07-15), Grand Livina (HR16DE) 1.6 Acenta, Acenta+ (07-15), Micra (K12) (CR14DE) 1.4 Comfort, Elegance, SE, Accenta, +, Sport, Visia, (K9K) 1.5dCi Tekna (04-11), NV200 (M20) (K9K) 1.5dCi, (HR16DE) 1.6 (2013-), Sentra (HR16DE) 1.6 5-Spd. Man., CVT (2013-), Tiida (HR16DE) 1.6 Visia, Visia +, Acenta, (MR18DE) 1.8 Acenta (06-13); Renault Clio III (K4J780) 1.4 Alize Expression, Alize Privilege, Va Va Voom, (K9K700/702/752) 1.5dCi Expression, (K7M748, K4M800/01) 1.6 Dynamique, Privilege, S, Expression, Sport, (F4R/830/832) 2.0 Sport, Special Ed. (04-14), Modus (D4F740) 1.2 Authentique, (K4J770/780) 1.4 Expression, Dynamique, (K4M) 1.6 Expression (05-08)		AR8370 Engine Mounting - RHS Chevrolet Aveo (T200) (F15S, LX6) 1.5 L, LS, LT, (A16DMS, LXV) 1.6 LT (03-15), Sonic (LSF) 1.3D, (A14XER) 1.4, (F16D4) 1.6 (11-16)
	AR8361 Front Lower Control Arm Bush - Outer Rear Nissan Livina (HR16DE) 1.6 Acenta, Acenta+, Visia, X-Gear Vista (07-15), Grand Livina (HR16DE) 1.6 Acenta, Acenta+ (07-15), Micra (K12) (CR14DE) 1.4 Comfort, Elegance, SE, Accenta, +, Sport, Visia, (K9K) 1.5dCi Tekna (04-11), NV200 (M20) (K9K) 1.5dCi, (HR16DE) 1.6 (2013-), Sentra (HR16DE) 1.6 5-Spd. Man., CVT (2013-), Tiida (HR16DE) 1.6 Visia, Visia +, Acenta, (MR18DE) 1.8 Acenta (06-13)		AR8371 Engine Mounting - LHS Chevrolet Aveo (T200) (F15S, LX6) 1.5 L, LS, LT, (A16DMS, LXV) 1.6 LT (03-15), Sonic (LSF) 1.3D, (A14XER) 1.4, (F16D4) 1.6 (11-16)
	AR8362 Engine Mounting - Rear Support Nissan Micra (K12) (CR14DE) 1.4 Comfort, Elegance, SE, Accenta, +, Sport, Visia, (K9K276, K9K722) 1.5dCi Tekna (04-11), NV200 (K9K) 1.5dCi 5-Spd. Man. (2013-)		AR8372 Engine Mounting - Rear Chevrolet Aveo (T200) (F15S, LX6) 1.5 L, LS, LT, (A16DMS, LXV) 1.6 LT (03-15), Sonic (LSF) 1.3D, (A14XER) 1.4, (F16D4) 1.6 (11-16)
	AR8363 Engine Mounting - RHS Nissan Livina (HR16DE) 1.6 5-Spd. Man. Acenta, Acenta+, Visia, X-Gear Vista, Grand Livina (HR16DE) 1.6 5-Spd. Man. Acenta, Acenta+ (07-15), NV200 (M20) (K9K) 1.5dCi, (HR16DE) 1.6 (2013-), Tiida (HR16DE) 1.6 Visia, Visia +, Acenta 5-Spd. Man., 4-Spd. Auto., (MR18DE) 1.8 6-Spd. Man. (06-13)		AR8373 Front Stabilizer Bar Bush Honda Jazz (GD) (L13A1) 1.4i-DSi CVT (03-08)
	AR8374 Front Strut Mounting (without Bearing) Honda Ballade (L15A7) 1.5 i-VTEC (2011-), Brio (L12B1) 1.2 (2012-), Jazz (GD) (L13A1) 1.4i-DSi 5-Spd. Man., CVT, (L15A) 1.5i (03-08), Jazz (GE) (L13Z1) 1.3 5-Spd. Man., CVT, (L13Z1) 1.4i 5-Spd. Man./Auto., (L15A7) 1.5i 5-Spd. Man./Auto. (08-14), Jazz (GK) (L13Z1) 1.3, (LDA3) 1.3 CVT Hybrid, (L15A3) 1.5i (2015-)		

ENGINE MOUNTING & RUBBER BUYERS GUIDE

337

	<p>AR8374B Front Strut Mounting (with Bearing) Honda Ballade (L15A7) 1.5 i-VTEC (2011-), Brio (L12B1) 1.2 (2012-), Jazz (GD) (L13A1) 1.4i-DSi 5-Spd. Man., CVT, (L15A) 1.5i (03-08), Jazz (GE) (L13Z1) 1.3 5-Spd. Man., CVT, (L13Z1) 1.4i 5-Spd. Man./Auto., (L15A7) 1.5i 5-Spd. Man./Auto. (08-14), Jazz (GK) (L13Z1) 1.3, (LDA3) 1.3 CVT Hybrid, (L15A3) 1.5i (2015-)</p>
	<p>AR8375 Engine Mounting - RHS Honda Jazz (GD) (L13A1) 1.4i-DSi 5-Spd. Man., (L15A1) 1.5i V-Tec 5-Spd. Man. (03-08), Jazz (GE) (L13Z1) 1.4i (08-14)</p>
	<p>AR8376 Engine Mounting - Rear Honda Jazz (GD) (L13A1) 1.4i-DSi 5-Spd. Man., (L15A1) 1.5i V-Tec 5-Spd. Man. (03-08), Jazz (GE) (L13Z1) 1.4i (08-14)</p>
	<p>AR8377 Transmission Mounting Honda Jazz (GD) (L13A1) 1.4i-DSi 5-Spd. Man., (L15A1) 1.5i V-Tec 5-Spd. Man. (03-08), Jazz (GE) (L13Z1) 1.4i (08-14)</p>
	<p>AR8378 Transmission Mounting Honda Jazz (GD) (L13A1) 1.4i CVT, (L15A1) 1.5i CVT (03-08)</p>
	<p>AR8379 Engine Mounting - Rear Honda Jazz (GD) (L13A1) 1.4i CVT, (L15A1) 1.5i CVT (03-08)</p>
	<p>AR8380 Engine Mounting - RHS Honda Jazz (GD) (L13A1) 1.4i CVT, (L15A1) 1.5i CVT (03-08)</p>
	<p>AR8381 Front Lower Control Arm Bush - Inner Honda Jazz (GD) (L13A1) 1.4i-DSi 5-Spd. Man., CVT, (L15A) 1.5i (03-08) ID: 19.5, OD: 61.5, L: 50.5</p>
	<p>AR8382 Front Lower Control Arm Bush - Outer Honda Jazz (GD) (L13A1) 1.4i-DSi 5-Spd. Man., CVT, (L15A) 1.5i (03-08) ID: 12.5, OD: 29, L: 46</p>
	<p>AR8383 Engine Mounting - L/RHS Ford Everest 4X2, 4X4 3.0 TDCi (09-15), Ranger 3.0 TDCi D/cab XLE, SubCab XLT, Hi Trail, Super Cab XLT LWB P/up Dies. (07-12), Ranger 4X4 3.0 TDCi D/cab XLE, SubCab XLT, Hi Trail, Super Cab XLT LWB P/up Dies. (07-12); Mazda BT-50 4X2, 4X4 (WLE7) 3.0 CRDi D/cab, SLE S/cab, CRDi SLX P/up (07-12)</p>
	<p>AR8384 Front Lower Control Arm Bush - Rear BMW 1-Series (E81, E87) 116i (N45) 1.6, 118i (N46) 2.0, 120i (N46) 2.0, 130i (N52) 3.0 (04-15), (E88) 120i (N46) 2.0 (04-15), (E82) 120d (N47) 2.0 (2005-), (E87) 118d (M47) 2.0, 120d (M47) 2.0 (2005-), (E82, E88) 125i (N52, N54, N55) 3.0 Convertible, Coupe, 135i (N54, N55) 3.0 Turbo (08-14), 3-Series (E90) 320d (M47) 2.0, 320i (N46) 2.0, 323i (N52N) 2.5, 325i (N53) 2.5, 330i (N52, N53) 3.0, 330d (M57, N57) 3.0 (05-13), (E92) 320i (N44) 2.0, 325i (N53) 2.5, 335i (N54, N55) 3.0 (02-15), (E93) 330i (N52) 3.0, 335i (N54, N55) 3.0 (05-14)</p>

	<p>AR8385 Front Lower Control Arm Bush - Inner & Outer Isuzu KB-Series D-TEQ 4X4 KB240i LE, D/C LE, Fleetside P/up, KB250D LE, D/C LE, Fleetside P/up, KB300TDi LX, D/C LX, Fleetside, "GO Big" P/up Hi-Rider (04-12) ID: 16.4, OD: 36, L: 57</p>
	<p>AR8386 Engine Mounting - LHS Chana Star 1.3 Single Cab (06-12)</p>
	<p>AR8387 Engine Mounting - RHS Chana Star 1.3 Single Cab (06-12)</p>
	<p>AR8388 Transmission Mounting Chana Star 1.3 Single Cab (06-12) NO PICTURE AVAILABLE AT TIME OF PRINT</p>
	<p>AR8389 Engine Mounting - Rear Hyundai Atos (G4HC) 1.0 Prime, (G4HG) 1.1 GLS (00-07), (G4HC) 1.0 Prime, (G4HG) 1.1 GLS (07-13)</p>
	<p>AR8390 Front Stabilizer Bar Bush Hyundai Atos (G4HC) 1.0 Prime, (G4HG) 1.1 GLS (00-07), (G4HC) 1.0 Prime, (G4HG) 1.1 GLS (07-13) ID: 16, L: 33, H: 26, W: 32</p>
	<p>AR8391 Front Lower Control Arm Bush - Outer Hyundai Atos (G4HC) 1.0 Prime, (G4HG) 1.1 GLS (00-07) ID: 12, OD: 35, L: 56</p>
	<p>AR8392 Front Lower Control Arm Bush - Inner Hyundai Atos (G4HC) 1.0 Prime, (G4HG) 1.1 GLS (00-07) ID: 12, OD: 59, L: 44.5</p>
	<p>AR8393 Front Stabilizer Bar Bush Hyundai H100 (4D56) 2.5i DT LWB P/up, Dropside Dies., (4G54) 2.6i LWB P/van, Dropside Pet. (04-09) ID: 21, L: 45, H: 36, W: 38</p>
	<p>AR8394 Front Stabilizer Bar Bush Hyundai Getz (G4EA) 1.3, (G4EE) 1.4i HS, (D3EA) 1.5 CRDi, HS, (G4ED-G) 1.6, HS (03-12) ID: 19, L: 47, H: 44, W: 43.5</p>
	<p>AR8395 Transmission Mounting Hyundai Getz (G4EA) 1.3, (G4EE) 1.4i HS, (D3EA) 1.5 CRDi, HS, (G4ED-G) 1.6, HS (03-12)</p>
	<p>AR8398 Engine Mounting - Front Hyundai Atos (G4HC) 1.0 Prime, (G4HG) 1.1 GLS (00-07), (G4HC) 1.0 Prime, (G4HG) 1.1 GLS (07-13)</p>

ENGINE MOUNTING & RUBBER BUYERS GUIDE

 ID: 16.5, OD: 45, L: 70	AR8399 Front Lower Control Arm Bush - Outer Kia K2700i (J2) 2.7i Workhorse D/S, P/up (2004-)		AR8412 Front Upper Control Arm Bush - Inner & Outer TATA Safari 4X2, 4X4 2.2 CRDi GLS, GLX Dies. (2007-), Telcoline (DLTC) 2.0TD, LWB D/C P/up 483 Dies. (04-10)
 ID: 24, L: 41, H: 30, W: 39	AR8401 Front Stabilizer Bar Bush Kia K2700i (J2) 2.7i Workhorse D/S, P/up (2004-)	 ID: 16, OD: 49, W: 45	AR8413 Front Lower Control Arm Bush - Inner & Outer TATA Safari 4X2, 4X4 2.2 CRDi GLS, GLX Dies. (2007-), Telcoline (DLTC) 2.0TD, LWB D/C P/up 483 Dies. (04-10)
	AR8402 Transmission Mounting Kia K2700i (J2) 2.7i Workhorse D/S, P/up (2004-)		AR8414 Front Stabilizer Link Grommet TATA Indica / Vista 1.4 LEi, LSi, LX, LXi, 1.4 TDi DLX, DL (2005-), Indigo 1.4 GLX, GLS, GSX S/W, 1.4 TDi DLX S/W (2005-), Safari 4X2, 4X4 2.2 CRDi GLS, GLX Dies. (2007-), Telcoline (DLTC) 2.0TD, LWB D/C P/up 483 Dies. (04-10)
	AR8403 Engine Mounting - L/RHS Kia K2700i (J2) 2.7i Workhorse D/S, P/up (2004-)	 ID: 19, L: 61, H: 67, W: 58	AR8415 Front Lower Control Arm Bush - Outer Rear Nissan Sabre (GA16DS) 160 GX, GXi, (SR20DE) 200 GXi (94-02), Sentra (GA14DNE/DS) 140, GX, GXi, i, Si, (GA16DNE/S) 160, GSi, GX, GXi, SE, Si, (SR20DE) 200 GSi, STI (92-02)
 ID: 18, OD: 40/48, L: 41	AR8404 Shackle Bush - Rear Upper Toyota Land Cruiser 76-Series 4X4 (1HZ) 4.2D P/up, S/W Dies. 5-Spd. Man. (2009-), 77-Series 4X4 (1HZ) 4.2D P/up, S/W Dies. 5-Spd. Man. (2009-), 79-Series 4X4 (1GR-FE) 4.0 P/up Pet. 5-Spd. Man., (1HZ) 4.2D P/up, S/W Dies. 5-Spd. Man. (2009-)		AR8416 Transmission Mounting Nissan Tiida (HR16DE) 1.6 4-Spd. Auto. (2006-)
 ID: 18, OD: 39.5, L: 47.5	AR8405 Shackle Bush - Rear Lower Toyota Land Cruiser 76-Series 4X4 (1HZ) 4.2D P/up, S/W Dies. 5-Spd. Man. (2009-), 77-Series 4X4 (1HZ) 4.2D P/up, S/W Dies. 5-Spd. Man. (2009-), 79-Series 4X4 (1GR-FE) 4.0 P/up Pet. 5-Spd. Man., (1HZ) 4.2D P/up, S/W Dies. 5-Spd. Man. (2009-)		AR8417 Engine Mounting - RHS Nissan Tiida (MR18DE) 1.8 Acenta (06-13)
 ID: 14.2, OD: 40/52, L: 88.5	AR8406 Shackle Bush - Front Toyota Land Cruiser 76-Series 4X4 (1HZ) 4.2D P/up, S/W Dies. 5-Spd. Man. (2009-), 77-Series 4X4 (1HZ) 4.2D P/up, S/W Dies. 5-Spd. Man. (2009-), 79-Series 4X4 (1GR-FE) 4.0 P/up Pet. 5-Spd. Man., (1HZ) 4.2D P/up, S/W Dies. 5-Spd. Man. (2009-)	 ID: 24, OD: 71, L: 31	AR8418 Tension Rod Bush Toyota Quantum (2KD-FTV) 2.5D, "Family" Bus, 10/14 Seater MPV Dies., (2TR-FE) 2.7, "Family" Bus, 10/14/15 Seater, MPV, Ses' fikile Pet. (2005-)
 ID: 14, OD: 58/62, L: 36	AR8407 Tension Rod Bush Opel Corsa LDV I (13NE) 130i Utility P/up Pet., (14NE) 1.4i Utility, S P/up Pet., (16NE) 1.6i Utility, S, P/up Sport, (X17D) 1.7D Utility P/up Dies. (97-04) - Lotus Suspension	 ID: 12.5, OD: 62.5, L: 71	AR8419 Front Lower Control Arm Bush - Outer Rear Mazda 6 (GG) (LFF7) 2.0 Active, Original, Elegant, (L3C1) 2.3 Dynamic, Individual, Sporty, Sporty Lux (03-09)
	AR8408 Engine Mounting - RHS Renault Scenic I 1.4 RTE MPV, 1.6 RT, RXE MPV, 2.0 RXE, RXi MPV (98-02)		AR8420 Front Upper Control Arm Bush - Inner Front & Outer Rear Mazda 6 (GG) (LFF7) 2.0 Active, Original, Elegant, (L3C1) 2.3 Dynamic, Individual, Sporty, Sporty Lux (03-09)
	AR8409 Engine Mounting - LHS TATA Telcoline (DLTC) 2.0TD, LWB D/C P/up 483 Dies. (04-10)	 ID: 14.5, OD: 33, L: 150	AR8423 Front Lower Control Arm Bush - Inner Front Toyota Camry I (SXV10) (5S-FE) 220 Si, Sei 16V, (SXV11) (3S-FE) 200i, Si, 16V (92-01), (VCV10) (3VZ-FE) 300 SEi Quad Cam 5-Spd. (92-97), (MCV10) (1MZ-FE) 300 V6 SEi Quad Cam, Aluminum (97-01)
	AR8410 Engine Mounting - RHS TATA Telcoline (DLTC) 2.0TD, LWB D/C P/up 483 Dies. (04-10)	 ID: 14.5, OD: 60, L: 50	AR8424 Front Lower Control Arm Bush - Outer Rear Toyota Camry I (SXV10) (5S-FE) 220 Si, Sei 16V, (SXV11) (3S-FE) 200i, Si, 16V (92-01), (VCV10) (3VZ-FE) 300 SEi Quad Cam 5-Spd. (92-97), (MCV10) (1MZ-FE) 300 V6 SEi Quad Cam, Aluminum (97-01)
 NO PICTURE AVAILABLE AT TIME OF PRINT	AR8411 Engine Mounting - Rear TATA Telcoline (DLTC) 2.0TD, LWB D/C P/up 483 Dies. (04-10)		

ENGINE MOUNTING & RUBBER BUYERS GUIDE

339

 ID: 16, OD: 26, L: 57	AR8425 Shackle Bush - Front Isuzu KB-Series KB220 Fleetside P/up, KB240i LE, D/C LE, Fleetside P/up, KB250D , DC LE, D/C LE, Fleetside P/up, D-TEQ, KB300 TDC TDi LX, D/C LX, Fleetside P/up, Hi-Rider, D-MAX (04-13), KB-Series D-TEQ 4X4 KB240i LE, D/C LE, Fleetside P/up, KB250D LE, D/C LE, Fleetside P/up, KB300TDi LX, D/C LX, Fleetside, "GO Big" P/up Hi-Rider (04-12)
 OD: 100 6-HOLES	AR8427 Propshaft Coupling Mercedes-Benz (W202) C-Class (M111.920/21) C180 1.8 Classic, (M111.941) C200 2.0 Classic, Elegance, C220 (M111.961) 2.2 Classic, Elegance, C230 (M111.974) 2.3 Classic, Elegance, Kompressor, Sport, C240 (M112.910) 2.4 Classic, Elegance, C250D , TD (M605.910) 2.5 5-Cyl., C280 (M104.941) 2.8 6-Cyl. Elegance (94-00), (W210) E-Class E280 (M112.921) 2.8 V6, E320 (M104.995, M112.941) 3.2 V6 (96-02)
	AR8428 Front Strut Mounting Citroen C2 (TU3JP) 1.4i VTR, (DV4TD) 1.4 HDi, (TU5J4S) 1.6 VTS (02-10), C3 (TUBA) 1.4i Attraction, Seduction, (TU5JP4) 1.6i Exclusive, Seduction (2010-); Peugeot 1007 (TU5JP4) 1.6 3 Dr. Hatch (05-08)
 ID: 28, OD: 113, L: 204.5, H: 60.5	AR8429 Centre Bearing Rubber Ford Ranger 2.5D TD XL D/cab, XLT, SubCab, XLT Hi Trail, Super Cab XLT LWB P/up Dies. (07-12); Mazda BT-50 4X2, 4X4 2.6 SLE D/cab, S/cab, P/up (07-12)
 ID: 35, OD: 136, L: 224, H: 61	AR8430 Centre Bearing Rubber Ford Everest 4X2, 4X4 3.0 TDCi (09-15), Ranger 3.0 TDCi D/cab XLE, SubCab XLT, Hi Trail, Super Cab XLT LWB P/up Dies. (07-12), Ranger T6 4X2, 4X4 (GBVAJQJ) 2.2D HP Double Cab, (GBVAJPF) 2.2 TD MP Single Cab, (GBVAF, AK, AL) 2.5, 3.2D Wildtrack, (SAFA) 3.2 TDCi (2012-); Mazda BT-50 4X2, 4X4 (WLE7) 3.0 CRDi D/cab, SLE S/cab, CRDi SLX P/up (07-12)
 ID: 19.5, L: 35, H: 38, W: 36	AR8432 Front Stabilizer Bar Bush Nissan Almera (GA16DE) 1.6 Comfort, Elegance, Luxury, (QG18DE) 1.8 Elegance, Luxury (01-06)
	AR8433 Front Strut Mounting Nissan Almera (GA16DE) 1.6 Comfort, Elegance, Luxury, (QG18DE) 1.8 Elegance, Luxury (01-06)
 ID: 28, OD: 55.5, L: 74	AR8434 Front Lower Control Arm Bush - Inner Front Nissan Interstar (G9U) 2.5dCi SWB, LWB HR, SR P/van Dies. (2006-)
 ID: 28, OD: 55.5, L: 79	AR8435 Front Lower Control Arm Bush - Outer Rear Nissan Interstar (G9U) 2.5dCi SWB, LWB HR, SR P/van Dies. (2006-)
 ID: 22, L: 52, H: 45, W: 51	AR8436 Front Stabilizer Bar Bush Nissan Interstar (G9U) 2.5dCi SWB, LWB HR, SR P/van Dies. (2006-)
	AR8437 Rear Axle Beam Bush Nissan Interstar (G9U) 2.5dCi SWB, LWB HR, SR P/van Dies. (2006-)

	AR8438 Engine Mounting - Rear Nissan Interstar (G9U) 2.5dCi SWB, LWB HR, SR P/van Dies. (2006-)
 ID: 26	AR8439 Front Stabilizer Bar Bush Nissan Murano 3.5 V6 (05-10)
	AR8440 Front Strut Mounting Nissan Murano (Z50) 4X4 (VQ35DE) 3.5i V6, X-Tronic SUV (05-10), X-Trail (T30) 4X2 (QR20DE) 2.0 5-Spd. Man., 4X4 (YD22ETI) 2.2D 6-Spd. Man., 4X4 (QR25DE) 2.5 5-Spd. Man., 4X4 (QR25DE) 2.5 SE 4-Spd. Auto. (01-07)
	AR8441 Engine Mounting - RHS Nissan Murano (Z50) 4X4 (VQ35DE) 3.5i V6, X-Tronic SUV (05-10)
	AR8442 Engine Mounting - LHS Nissan Murano (Z50) 4X4 (VQ35DE) 3.5i V6, X-Tronic SUV (05-10)
	AR8444 Engine Mounting - Front Nissan Murano (Z50) 4X4 (VQ35DE) 3.5i V6, X-Tronic SUV (05-10)
	AR8446 Engine Mounting - Rear Nissan Murano (Z50) 4X4 (VQ35DE) 3.5i V6, X-Tronic SUV (05-10)
 ID: 14.5, OD: 44.5, L: 54	AR8447 Front Upper Control Arm Bush - Inner & Outer Nissan Navara (D40) 4X2, 4X4 (YD25DDTi) 2.5dCi LWB D/cab LE, SE, XE P/up Dies., (V9X) 3.0dCi V6 LWB D/cab, P/up Dies., (VQ40DE) 4.0i V6 LWB LE D/cab P/up Pet. (2005-), Pathfinder (R51) 4X4 (YD25DDTi) 2.5dCi LWB D/cab LE, SUV Dies., (V9X) 3.0dCi V6 LWB D/cab SUV Dies., (VQ40DE) 4.0i V6 LWB LE D/cab SUV Pet. (05-15)
 ID: 14.2	AR8448 Front Lower Control Arm Bush - Inner & Outer Nissan Navara (D40) 4X2, 4X4 (YD25DDTi) 2.5dCi LWB D/cab LE, SE, XE P/up Dies., (V9X) 3.0dCi V6 LWB D/cab, P/up Dies., (VQ40DE) 4.0i V6 LWB LE D/cab P/up Pet. (2005-), Pathfinder (R51) 4X4 (YD25DDTi) 2.5dCi LWB D/cab LE, SUV Dies., (V9X) 3.0dCi V6 LWB D/cab SUV Dies., (VQ40DE) 4.0i V6 LWB LE D/cab SUV Pet. (05-15)
 ID: 31.5	AR8449 Front Stabilizer Bar Bush Nissan Navara (D40) 4X2, 4X4 (YD25DDTi) 2.5dCi LWB D/cab LE, SE, XE P/up Dies., (V9X) 3.0dCi V6 LWB D/cab, P/up Dies., (VQ40DE) 4.0i V6 LWB LE D/cab P/up Pet. (2005-), Pathfinder (R51) 4X4 (YD25DDTi) 2.5dCi LWB D/cab LE, SUV Dies., (V9X) 3.0dCi V6 LWB D/cab SUV Dies., (VQ40DE) 4.0i V6 LWB LE D/cab SUV Pet. (05-15)
	AR8450 Front Strut Mounting Nissan Navara (D40) 4X2, 4X4 (YD25DDTi) 2.5dCi LWB D/cab LE, SE, XE P/up Dies., (V9X) 3.0dCi V6 LWB D/cab, P/up Dies., (VQ40DE) 4.0i V6 LWB LE D/cab P/up Pet. (2005-), Pathfinder (R51) 4X4 (YD25DDTi) 2.5dCi LWB D/cab LE, SUV Dies., (V9X) 3.0dCi V6 LWB D/cab SUV Dies., (VQ40DE) 4.0i V6 LWB LE D/cab SUV Pet. (05-15)

ENGINE MOUNTING & RUBBER

BUYERS GUIDE

	AR8451 Transmission Mounting Nissan Navara (D40) 4X2, 4X4 (V9X) 3.0dCi V6 LWB D/cab, P/up Dies. (2005-), Pathfinder (R51) 4X4 (V9X) 3.0dCi V6 LWB D/cab SUV Dies. (05-15)		AR8467 Rear Stabilizer Bar Bush Nissan Qashqai I (J10) 4X2 (K9K) 1.5dCi Acenta 6-Spd. Man., (HR16DE) 1.6 Acenta 5-Spd. Man., (MR20DE) 2.0 Acenta 6-Spd. Man., (M9R) 2.0dCi Acenta 6-Spd. Man. AWD, 4X4 (M9R) 2.0dCi 6-Spd. Man. (08-13), Qashqai II (J11) 4X2 (HRA2DDT) 1.2T Acenta + D 6-Spd. Man., (K9K) 1.5dCi Acenta 6-Spd. Man., (R9M) 1.6dCi Acenta 6-Spd. Man., (MR16DDT) 1.6 Acenta Tech 6-Spd. Man. (2014-); Renault Kadjar 4X2 (H5F408) 1.2T Dynamique 6-Spd. Man., (K9K) 1.5dCi Dynamique 6-Spd. Auto., 4X4 (R9M) 1.6dCi Dynamique 6-Spd. Man. (2016-)
	AR8452 Engine Mounting - L/RHS Nissan Navara (D40) 4X2, 4X4 (V9X) 3.0dCi V6 LWB D/cab, P/up Dies. (2005-), Pathfinder (R51) 4X4 (V9X) 3.0dCi V6 LWB D/cab SUV Dies. (05-15)		AR8468 Front Stabilizer Bar Bush Nissan Qashqai I (J10) 4X2 (K9K) 1.5dCi Acenta 6-Spd. Man., (HR16DE) 1.6 Acenta 5-Spd. Man., (MR20DE) 2.0 Acenta 6-Spd. Man., (M9R) 2.0dCi Acenta 6-Spd. Man. AWD, 4X4 (M9R) 2.0dCi 6-Spd. Man. (08-13), X-Trail (T31) 4X2 (MR20DE) 2.0 6-Spd. Man., 4X2 (M9R) 2.0dCi 6-Spd. Man., 4X4 (M9R) 2.0dCi SE 6-Spd. Auto, 4X4 (QR25DE) 2.5 SE 6-Spd. Man., CVT (07-15)
	AR8453 Transmission Mounting Nissan Navara (D40) 4X2, 4X4 (VQ40DE) 4.0i V6 LWB LE D/cab P/up Pet. (2005-), Pathfinder (R51) 4X4 (VQ40DE) 4.0i V6 LWB LE D/cab SUV Pet. (05-15)		AR8469L Front Strut Mounting - LHS Nissan Qashqai I (J10) 4X2 (K9K) 1.5dCi Acenta 6-Spd. Man., (HR16DE) 1.6 Acenta 5-Spd. Man., (MR20DE) 2.0 Acenta 6-Spd. Man., (M9R) 2.0dCi Acenta 6-Spd. Man. AWD, 4X4 (M9R) 2.0dCi 6-Spd. Man. (08-13), X-Trail (T31) 4X2 (MR20DE) 2.0 6-Spd. Man., 4X2 (M9R) 2.0dCi 6-Spd. Man., 4X4 (M9R) 2.0dCi SE 6-Spd. Auto, 4X4 (QR25DE) 2.5 SE 6-Spd. Man., CVT (07-15); Renault Koleos I (HY) 4X4 (M9R) 2.0dCi 6-Spd. Auto./Man., (2TR702) 2.5 Dynamique 6-Spd. Man., (2TR703) 2.5 CVT (08-15)
	AR8454 Engine Mounting - L/RHS Nissan Navara (D40) 4X2, 4X4 (VQ40DE) 4.0i V6 LWB LE D/cab P/up Pet. (2005-), Pathfinder (R51) 4X4 (VQ40DE) 4.0i V6 LWB LE D/cab SUV Pet. (05-15)		AR8469R Front Strut Mounting - RHS Nissan Qashqai I (J10) 4X2 (K9K) 1.5dCi Acenta 6-Spd. Man., (HR16DE) 1.6 Acenta 5-Spd. Man., (MR20DE) 2.0 Acenta 6-Spd. Man., (M9R) 2.0dCi Acenta 6-Spd. Man. AWD, 4X4 (M9R) 2.0dCi 6-Spd. Man. (08-13), X-Trail (T31) 4X2 (MR20DE) 2.0 6-Spd. Man., 4X2 (M9R) 2.0dCi 6-Spd. Man., 4X4 (M9R) 2.0dCi SE 6-Spd. Auto, 4X4 (QR25DE) 2.5 SE 6-Spd. Man., CVT (07-15); Renault Koleos I (HY) 4X4 (M9R) 2.0dCi 6-Spd. Auto./Man., (2TR702) 2.5 Dynamique 6-Spd. Man., (2TR703) 2.5 CVT (08-15)
	AR8455 Shackle Bush - Front Nissan Navara (D40) 4X2, 4X4 (YD25DDTi) 2.5dCi LWB D/cab LE, SE, XE P/up Dies., (V9X) 3.0dCi V6 LWB D/cab, P/up Dies., (VQ40DE) 4.0i V6 LWB LE D/cab P/up Pet. (2005-); Toyota Quantum (2KD-FTV) 2.5D, "Family" Bus, 10/14 Seater MPV Dies., (2TR-FE) 2.7, "Family" Bus, 10/14/15 Seater, MPV, Ses' fikile Pet. (2005-)		AR8470 Engine Mounting - RHS Front Nissan Qashqai I (J10) 4X2, 4X4 (HR16DE) 1.6 Visia, +2, Acenta SUV (07-15); Renault Kangoo II (K7M750) 1.6 8V 64KW 5-Spd. Man. (2008-), Megane II (K4M812) 1.6 5-Spd. Man. (02-10), Scenic II (K4M761) 1.6 16V 5-Spd. Man. (02-10), Grand Scenic II (K4M761) 1.6 16V 6-Spd. Man. (05-10)
	AR8456 Shackle Bush - Rear Upper Nissan Navara (D40) 4X2, 4X4 (YD25DDTi) 2.5dCi LWB D/cab LE, SE, XE P/up Dies., (V9X) 3.0dCi V6 LWB D/cab, P/up Dies., (VQ40DE) 4.0i V6 LWB LE D/cab P/up Pet. (2005-)		AR8471 Engine Mounting - LHS Rear Nissan Qashqai I (J10) (M9R) 2.0dCi Acenta 6-Spd. Man. AWD, 4X4 (M9R) 2.0dCi 6-Spd. Man. (08-13), X-Trail (T31) 4X4 (M9R) 2.0dCi 6-Spd. Auto. (07-15)
	AR8458 Front Lower Control Arm Bush - inner Front Nissan Primaster (F9Q760) 1.9dCi Minibus (07-11); Opel Vivaro (F9Q760) 1.9 CDTi P/van, Enjoy Bus Dies., (F4R720) 2.0i P/van Pet. (06-15); Renault Traffic (F9Q760) 1.9dCi MPV, 100 Panel Van Dies. (05-07)		AR8472 Engine Mounting - RHS Front Nissan Qashqai I (J10) (M9R) 2.0dCi Acenta 6-Spd. Man. AWD, 4X4 (M9R) 2.0dCi 6-Spd. Man. (08-13)
	AR8459 Front Strut Mounting Nissan Primaster (F9Q760) 1.9dCi Minibus (07-11); Opel Vivaro (F9Q760) 1.9 CDTi P/van, Enjoy Bus Dies., (F4R720) 2.0i P/van Pet. (06-15); Renault Traffic (F9Q760) 1.9dCi MPV, 100 Panel Van Dies. (05-07)		AR8473 Engine Mounting - Rear Torque Rod Nissan Qashqai I (J10) 4X4 (M9R) 2.0dCi 6-Spd. Man. (08-13), X-Trail (T31) 4X4 (M9R) 2.0dCi 6-Spd. Auto. (07-15)
	AR8460 Front Stabilizer Bar Bush Nissan Primaster (F9Q760) 1.9dCi Minibus (07-11); Opel Vivaro (F9Q760) 1.9 CDTi P/van, Enjoy Bus Dies., (F4R720) 2.0i P/van Pet. (06-15); Renault Traffic (F9Q760) 1.9dCi MPV, 100 Panel Van Dies. (05-07)		AR8474 Front Lower Control Arm Bush - Inner Front & Outer Rear Nissan NP200 (K9K) 1.5dCi SWB S, SE P/up Dies., (K7M) 1.6 SWB S, SE P/up Pet. (2008-); Renault Logan (K7M710) 1.6 Expression (08-12), Sandero (K7J710) 1.4 Authentique, Ambiance, (K7M690/710) 1.6 Cup, Dynamique, Stepway, Expression, '+', Pack, League, United (09-15), (B8) (H4B400) 900T TCe 90 (2014-)
	AR8461 Rear Axle Beam Bush Nissan Primaster (F9Q760) 1.9dCi Minibus (07-11); Opel Vivaro (F9Q760) 1.9 CDTi P/van, Enjoy Bus Dies., (F4R720) 2.0i P/van Pet. (06-15); Renault Traffic (F9Q760) 1.9dCi MPV, 100 Panel Van Dies. (05-07)		AR8475 Front Stabilizer Bar Bush Nissan NP200 (K9K) 1.5dCi SWB S, SE P/up Dies., (K7M) 1.6 SWB S, SE P/up Pet. (2008-); Renault Logan (K7M710) 1.6 Expression (08-12), Sandero (K7J710) 1.4 Authentique, Ambiance, (K7M690/710) 1.6 Cup, Dynamique, Stepway, Expression, '+', Pack, League, United (09-15), (B8) (H4B400) 900T TCe 90 (2014-)
	AR8462 Engine Mounting - L/RHS Nissan Primaster (F9Q760) 1.9dCi Minibus (07-11); Opel Vivaro (F9Q760) 1.9 CDTi P/van, Enjoy Bus Dies., (F4R720) 2.0i P/van Pet. (06-15); Renault Traffic (F9Q760) 1.9dCi MPV, 100 Panel Van Dies. (05-07)		
	AR8463 Engine Mounting - Rear Lower Nissan Primaster (F9Q760) 1.9dCi Minibus (07-11); Opel Vivaro (F9Q760) 1.9 CDTi P/van, Enjoy Bus Dies., (F4R720) 2.0i P/van Pet. (06-15); Renault Traffic (F9Q760) 1.9dCi MPV, 100 Panel Van Dies. (05-07)		

ENGINE MOUNTING & RUBBER BUYERS GUIDE

	<p>AR8476 Front Strut Mounting Nissan NP200 (K9K) 1.5dCi SWB S, SE P/up Dies., (K7M) 1.6 SWB S, SE P/up Pet. (2008-); Renault Duster 4X2, 4X4 (K9K884/858) 1.5dCi, (K4M616) 1.6 (2013-), Logan (K7M710) 1.6 Expression (08-12), Sandero (K7J710) 1.4 Authentique, Ambience, (K7M690/710) 1.6 Cup, Dynamique, Stepway, Expression, '+', Pack, League, United (09-15), (B8) (H4B400) 900T TCe 90 (2014-)</p>	 <p>ID: 19</p>	<p>AR8486 Front Lower Control Arm Bush - Outer Rear Chevrolet Cruze (F16D3) 1.6 L, LS, (F18D4) 1.8 LS, (Z20S1) 2.0D (09-12), Orlando (F18D4) 1.8 (2011-); Opel Astra J (A14NET, B14NET) 1.4T, (A16LET) 1.6T, (A20NFT, B20NFT) 2.0 OPC (2010-)</p>
 <p>ID: 12, OD: 67, L: 90</p>	<p>AR8477 Rear Axle Beam Bush Nissan Livina (HR16DE) 1.6 Acenta, Acenta+, Visia, X-Gear Vista (07-15), Grand Livina (HR16DE) 1.6 Acenta, Acenta+ (07-15), Micra (K13) (HR12DE) 1.2, (HR15DE) 1.5, (K9K700/4) 1.5dCi (2011-), NP200 (K9K) 1.5dCi SWB S, SE P/up Dies., (K7M) 1.6 SWB S, SE P/up Pet. (2008-); Renault Duster 4X2, 4X4 (K9K884/858) 1.5dCi, (K4M616) 1.6 (2013-), Logan (K7M710) 1.6 Expression (08-12), Sandero (K7J710) 1.4 Authentique, Ambience, (K7M690/710) 1.6 Cup, Dynamique, Stepway, Expression, '+', Pack, League, United (09-15), (B8) (H4B400) 900T TCe 90 (2014-)</p>		<p>AR8487 Front Stabilizer Bar Bush Chevrolet Cruze (F16D3) 1.6 L, LS, (F18D4) 1.8 LS, (Z20S1) 2.0D (09-12), Orlando (F18D4) 1.8 (2011-); Opel Astra J (A14NET, B14NET) 1.4T, (A16LET) 1.6T, (A20NFT, B20NFT) 2.0 OPC (2010-)</p>
	<p>AR8478 Engine Mounting - Rear Support Nissan NP200 (K9K) 1.5dCi SWB S, SE P/up, (K7M) 1.6 8V SWB S, SE P/up, (K4M) 1.6 16V SWB S, SE P/up (2008-); Renault Logan (K7M) 1.6 Expression (08-12), Megane II (K9K) 1.5dCi 5-Spd. Man., (K4M) 1.6 5-Spd. Man. (02-10), Modus (D4F740) 1.2 5-Spd. Man. (05-08), Sandero I (K7J) 1.4, (K7M) 1.6 (09-15), Scenic II (F4R) 2.0 6-Spd. Man. (02-10), Grand Scenic II (F4R) 2.0 6-Spd. Man. (05-10)</p>	 <p>ID: 19</p>	<p>AR8489 Front Stabilizer Bar Bush Opel Corsa D (Z13DTH/J) 1.3 CDTi Enjoy Hatch, (Z14XEP/R) 1.4i Enjoy, Essentia, Cosmo Hatch, Sport, (A14NEL) 1.4T, (16LEL) 1.6i Sport, OPC A/Z (08-15)</p>
	<p>AR8479 Transmission Mounting Nissan NP200 (K7M) 1.6 8V (2008-); Renault Duster I (K4M) 1.6 (2012-), Logan (K7M) 1.6 (2004-), Sandero I (K7J) 1.4, (K7M) 1.6 (09-15)</p>		<p>AR8490 Front Strut Mounting Opel Adam (B10XFT) 1.0T Jam, Glam, Rocks, (A14XER, B14XER) 1.4 (2014-), Adam S (B14NEH) 1.4T (2014-), Corsa D (Z13DTH/J) 1.3 CDTi Enjoy Hatch, (Z14XEP/R) 1.4i Enjoy, Essentia, Cosmo Hatch, Sport, (A14NEL) 1.4T, (16LEL) 1.6i Sport, OPC A/Z (08-15), Corsa E (B10XFT, F10XFT) 1.0T, (B14XEL, B14NEH) 1.4T (2015-)</p>
	<p>AR8480 Transmission Mounting Nissan Qashqai (J10) 4X2, 4X4 (HR16DE) 1.6 5-Spd. Man. (07-15), NP200 (K9K) 1.5dCi SWB S, SE P/up, (K7M) 1.6 8V SWB S, SE P/up (2008-); Renault Clio III (K4J) 1.4 16V, (K4M) 1.6 16V (04-14), Duster I (K4M) 1.6 16V (13-17), Kangoo II (K7M) 1.6 8V (2008-), Logan (K7M) 1.6 Expression (08-12), Megane II (K4M) 1.6 5-Spd. Man. (02-10), Modus (K4M) 1.6 5-Spd. Man. (05-08), Sandero I (K7J) 1.4 8V, (K7M) 1.6 8V (09-15), Scenic II (K4M) 1.6 5-Spd. Man. (02-10), Grand Scenic II (K4M) 1.6 5-Spd. Man. (05-10)</p>		<p>AR8491 Engine Mounting - RHS Opel Adam (B10XFT) 1.0T Jam, Glam, Rocks (2014-), Corsa D (Z13DTH/J) 1.3 CDTi Enjoy Hatch, (Z14XEP/R) 1.4i Enjoy, Essentia, Cosmo Hatch, Sport, (A14NEL) 1.4T (08-15), Corsa E (B10XFT, F10XFT) 1.0T (2015-)</p>
	<p>AR8481 Engine Mounting - Rear Nissan Maxima (QX) (VQ20E/DE) 2.0, (VQ30DE) 3.0 V6 (96-04)</p>		<p>AR8492 Engine Mounting - LHS Opel Corsa D (Z13DTH/J) 1.3 CDTi Enjoy Hatch, (Z14XEP/R) 1.4i Enjoy, Essentia, Cosmo Hatch, Sport, (A14NEL) 1.4T (08-15)</p>
	<p>AR8482 Engine Mounting - LHS Nissan Maxima (QX) (VQ20E/DE) 2.0, (VQ30DE) 3.0 V6 (96-04)</p>		<p>AR8493 Engine Mounting - Rear, Transmission Mounting Opel Adam (A14XER, B14XER) 1.4 (2014-), Corsa D (Z13DTH/J) 1.3 CDTi Enjoy Hatch, (Z14XEP/R) 1.4i Enjoy, Essentia, Cosmo Hatch, Sport, (A14NEL) 1.4T, (16LEL) 1.6i Sport, OPC A/Z (08-15)</p>
	<p>AR8483 Engine Mounting - RHS Nissan Maxima (QX) (VQ20E/DE) 2.0, (VQ30DE) 3.0 V6 (96-04)</p>		<p>AR8494 Engine Mounting - Rear Fiat Punto (188A5.000) 1.2 Active, Dyna, (188A9.000) 1.3 Dynamic, JTD MultiJet Active, Dyna (2005-), Grand Punto I / II (188A5, 199A4) 1.2, (199A2/3) 1.3D MultiJet, (199A6, 198A4, 350A1) 1.4 16V, (939A1.000) 1.9 MultiJet (06-12); Opel Adam (A14XER, B14XER) 1.4 (2014-), Corsa D (Z13DTH/J) 1.3 CDTi Enjoy Hatch, (Z14XEP/R) 1.4i Enjoy, Essentia, Cosmo Hatch, Sport, (A14NEL) 1.4T, (16LEL) 1.6i Sport, OPC A/Z (08-15), Corsa E (B10XFT, F10XFT) 1.0T, (B14NEH) 1.4T (2015-)</p>
	<p>AR8484 Engine Mounting - Front Nissan Maxima (QX) (VQ20E/DE) 2.0, (VQ30DE) 3.0 V6 (96-04)</p>		<p>AR8495 Engine Mounting - RHS Fiat Punto (188A5.000) 1.2 Active, Dyna, (188A9.000) 1.3 Dynamic, JTD MultiJet Active, Dyna (2005-), Grand Punto I / II (188A5, 199A4) 1.2, (199A2/3) 1.3D MultiJet, (199A6, 198A4, 350A1) 1.4 16V, (939A1.000) 1.9 MultiJet (06-12); Opel Corsa D (16LEL) 1.6i Sport, OPC A/Z (08-15)</p>
 <p>ID: 33, OD: 40, L: 60</p>	<p>AR8485 Front Lower Control Arm Bush - Inner Front Chevrolet Cruze (F16D3) 1.6 L, LS, (F18D4) 1.8 LS, (Z20S1) 2.0D (09-12), Orlando (F18D4) 1.8 (2011-); Opel Astra J (A14NET, B14NET) 1.4T, (A16LET) 1.6T, (A20NFT, B20NFT) 2.0 OPC (2010-)</p>		<p>AR8496 Engine Mounting - LHS Fiat Punto (188A5.000) 1.2 Active, Dyna, (188A9.000) 1.3 Dynamic, JTD MultiJet Active, Dyna (2005-), Grand Punto I / II (188A5, 199A4) 1.2, (199A2/3) 1.3D MultiJet, (199A6, 198A4, 350A1) 1.4 16V, (939A1.000) 1.9 MultiJet (06-12); Opel Corsa D (16LEL) 1.6i Sport, OPC A/Z (08-15)</p>
		 <p>ID: 12, OD: 32, L: 54</p>	<p>AR8497 Front Lower Control Arm Bush - Inner Rear Citroen C1 (1KR-FE) 1.0, (1KR-FE) 1.0i (2007-); Peugeot 107 (1KR-FE) 1.0 XR, XR+, X-Line, Urban, Trendy (06-16); Toyota Aygo (1KR-FE) 1.0 Fresh, Wild, Hatch (2011-)</p>

ENGINE MOUNTING & RUBBER

BUYERS GUIDE

 ID: 20, OD: 57, L: 62	AR8498 Front Lower Control Arm Bush - Outer Front & Rear Citroen C1 (1KR-FE) 1.0, (1KR-FE) 1.0i (2007-); Peugeot 107 (1KR-FE) 1.0 XR, XR+, X-Line, Urban, Trendy (06-16); Toyota Aygo (1KR-FE) 1.0 Fresh, Wild, Hatch (2011-)		AR8509 Front Strut Mounting Citroen C3 (TUBA) 1.4i Attraction, Seduction, (TU5JP4) 1.6i Exclusive, Seduction (2010-); Peugeot 207 (EP3) 1.4 XL, XR, XR+, Urban, Active, Pop Art, (EP6C) 1.6 CC Sport2, XS, GTi, (EP6DT) 1.6 VTi, Dynamic, Sportium, (DV6TED4) 1.6 HDi XS, Dynamic, Sportium (06-13)
 ID: 19, L: 32, H: 53, W: 46	AR8499 Front Stabilizer Bar Bush Citroen C1 (1KR-FE) 1.0, (1KR-FE) 1.0i (2007-); Fiat Grand Punto I / II (188A5, 199A4) 1.2, (199A2/3) 1.3D MultiJet, (199A6, 198A4, 350A1) 1.4 16V, (939A1.000) 1.9 MultiJet (06-12); Peugeot 107 (1KR-FE) 1.0 XR, XR+, X-Line, Urban, Trendy (06-16); Toyota Aygo (1KR-FE) 1.0 Fresh, Wild, Hatch (2011-)	 ID: 12, OD: 70.5/74, L: 82.5	AR8510 Rear Axle Beam Bush Peugeot 207 (EP3) 1.4 XL, XR, XR+, Urban, Active, Pop Art, (EP6C) 1.6 CC Sport2, XS, GTi, 1.6 (EP6DT) VTi, Dynamic, Sportium, (DV6TED4) 1.6 HDi XS, Dynamic, Sportium (06-13)
	AR8500 Front Strut Mounting Citroen C1 (1KR-FE) 1.0, (1KR-FE) 1.0i (2007-); Peugeot 107 (1KR-FE) 1.0 XR, XR+, X-Line, Urban, Trendy (06-16); Toyota Aygo (1KR-FE) 1.0 Fresh, Wild, Hatch (2011-)		AR8511 Engine Mounting - Rear Citroen C2 (TU3JP) 1.4i Auto. VTR, (DV4TD) 1.4 Auto. HDi, (TU5J4S) 1.6 Auto. VTS (02-10), C3 (TUBA) 1.4i Auto. Attraction, Seduction, (TU5JP4) 1.6i Auto. Exclusive, Seduction (2010-); Peugeot 1007 (TU5JP4) 1.6 Auto. 3 Dr. Hatch (05-08), 207 (EP3) 1.4 Auto. XL, XR, XR+, Urban, Active, Pop Art, (EP6C) 1.6 Auto. CC Sport2, XS, GTi, (EP6DT) 1.6 Auto. VTi, Dynamic, Sportium, (DV6TED4) 1.6 Auto. HDi XS, Dynamic, Sportium (06-13), 208 (EP6C) 1.6 VTi 5FS, 1.6 GTi (2012-)
 ID: 23, OD: 50, L: 45	AR8501 Rear Axle Beam Bush Citroen C1 (1KR-FE) 1.0, (1KR-FE) 1.0i (2007-); Peugeot 107 (1KR-FE) 1.0 XR, XR+, X-Line, Urban, Trendy (06-16); Toyota Aygo (1KR-FE) 1.0 Fresh, Wild, Hatch (2011-)		AR8512 Engine Mounting - LHS Citroen C2 (TU3JP) 1.4i VTR, (DV4TD) 1.4 HDi, (TU5J4S) 1.6 VTS (02-10), C3 (TUBA) 1.4i Attraction, Seduction, (TU5JP4) 1.6i Exclusive, Seduction (2010-); Peugeot 1007 (TU5JP4) 1.6 3 Dr. Hatch (05-08), 207 (EP3) 1.4 XL, XR, XR+, Urban, Active, Pop Art, (EP6C) 1.6 CC Sport2, XS, GTi, (EP6DT) 1.6 VTi, Dynamic, Sportium, (DV6TED4) 1.6 HDi XS, Dynamic, Sportium (06-13)
	AR8502 Engine Mounting - RHS Citroen C1 (1KR-FE) 1.0, (1KR-FE) 1.0i (2007-); Peugeot 107 (1KR-FE) 1.0 XR, XR+, X-Line, Urban, Trendy (06-16); Toyota Aygo (1KR-FE) 1.0 Fresh, Wild, Hatch (2011-)		AR8513 Engine Mounting - Rear Citroen C3 (TU5JP4) 1.6i Man. Exclusive, Seduction (2010-); Peugeot 207 (EP6C) 1.6 CC Sport2, XS, GTi, (EP6DT) 1.6 VTi, Dynamic, Sportium, (DV6TED4) 1.6 HDi XS, Dynamic, Sportium (06-13), 208 (EBO) 1.0 VTi ZMZ, (EB2F) 1.2 VTi HMZ, (DV6DTED) 1.6 HDi 9HP, (DV6CTED) 1.6 HDi 9HD (2012-)
	AR8503 Engine Mounting - Rear Citroen C1 (1KR-FE) 1.0, (1KR-FE) 1.0i (2007-); Peugeot 107 (1KR-FE) 1.0 XR, XR+, X-Line, Urban, Trendy (06-16); Toyota Aygo (1KR-FE) 1.0 Fresh, Wild, Hatch (2011-)		AR8514 Front Strut Mounting Citroen C4 (DV6TED4) 1.6 HDi, (EW10J4S) 2.0 VTS Coupe (05-10); Peugeot 308 (EP6-DT/CDTX, DV6TED4) 1.6i, VTi, THP X-Line, XS, XT, CC, SW, Comfort, Premium, GTi, (DW10CTED4) 2.0 HDi CC, SW (2008-), 3008 (EP6-DT) 1.6i Exec., VTi Comfort, THP Premium, (DW10CTED4) 2.0 HDi Exec., Grip (2010-)
	AR8504 Engine Mounting - LHS Citroen C1 (1KR-FE) 1.0, (1KR-FE) 1.0i (2007-); Peugeot 107 (1KR-FE) 1.0 XR, XR+, X-Line, Urban, Trendy (06-16); Toyota Aygo (1KR-FE) 1.0 Fresh, Wild, Hatch (2011-)		AR8515 Engine Mounting - Front, "Eye" Bush Citroen C4 (DV6TED4) 1.6 HDi, (EW10J4S) 2.0 VTS Coupe (05-10); Peugeot 308 (EP6-DT/CDTX, DV6TED4) 1.6i, VTi, THP X-Line, XS, XT, CC, SW, Comfort, Premium, GTi, (DW10CTED4) 2.0 HDi CC, SW (2008-), 3008 (EP6-DT) 1.6i Exec., VTi Comfort, THP Premium, (DW10CTED4) 2.0 HDi Exec., Grip (2010-)
 ID: 14.3, OD: 56.5, L: 48	AR8505 Front Lower Control Arm Bush - Inner Front Citroen C3 (TUBA) 1.4i Attraction, Seduction, (TU5JP4) 1.6i Exclusive, Seduction (2010-); Peugeot 207 (EP3) 1.4 XL, XR, XR+, Urban, Active, Pop Art, (EP6C) 1.6 CC Sport2, XS, GTi, (EP6DT) 1.6 VTi, Dynamic, Sportium, (DV6TED4) 1.6 HDi XS, Dynamic, Sportium (06-13)	 ID: 10, OD: 70, H: N/A	AR8516 Engine Mounting Support Bush - Rear Citroen Berlingo (TU5JP4B) 1.6, (DV6TED4BU, DV6AUTED4) 1.6 HDi 90 16V (2011-), C4 (DV6TED4) 1.6 HDi (05-10); Peugeot 308 (EP6-DT/CDTX, DV6TED4) 1.6i, VTi, THP X-Line, XS, XT, CC, SW, Comfort, Premium, GTi (2008-), 3008 (EP6-DT) 1.6i Exec., VTi Comfort, THP Premium (2010-), Partner 1.6 HDi (08-18)
 ID: 14, OD: 56.5, L: 47.9	AR8506 Front Lower Control Arm Bush - Outer Rear Citroen C3 (TUBA) 1.4i Attraction, Seduction, (TU5JP4) 1.6i Exclusive, Seduction (2010-); Peugeot 207 (EP3) 1.4 XL, XR, XR+, Urban, Active, Pop Art, (EP6C) 1.6 CC Sport2, XS, GTi, (EP6DT) 1.6 VTi, Dynamic, Sportium, (DV6TED4) 1.6 HDi XS, Dynamic, Sportium (06-13)	 ID: 10, OD: 34, L: 50	AR8517 Engine Mounting Support Bush - Rear Citroen C4 (EW10J4S) 2.0 VTS Coupe (05-10); Peugeot 308 (DW10CTED4) 2.0 HDi CC, SW (2008-), 3008 (DW10CTED4) 2.0 HDi Exec., Grip (2010-)
 ID: 20	AR8507 Front Stabilizer Bar Bush Citroen C3 (TUBA) 1.4i Attraction, Seduction, (TU5JP4) 1.6i Exclusive, Seduction (2010-); Peugeot 207 (EP3) 1.4 XL, XR, XR+, Urban, Active, Pop Art, (EP6C) 1.6 CC Sport2, XS, GTi, (EP6DT) 1.6 VTi, Dynamic, Sportium, (DV6TED4) 1.6 HDi XS, Dynamic, Sportium (06-13)	 ID: 26, OD: 46, L: 53	AR8518 Front Lower Control Arm Bush - Inner Front Peugeot Boxer (DJ5TED) 2.5TD 1.8 Ton Delivery Van Dies. (02-06)
 ID: 21	AR8508 Front Stabilizer Bar Bush Citroen C3 (TUBA) 1.4i Attraction, Seduction, (TU5JP4) 1.6i Exclusive, Seduction (2010-); Peugeot 207 (EP3) 1.4 XL, XR, XR+, Urban, Active, Pop Art, (EP6C) 1.6 CC Sport2, XS, GTi, (EP6DT) 1.6 VTi, Dynamic, Sportium, 1.6 (DV6TED4) HDi XS, Dynamic, Sportium (06-13), 208 (EBO) 1.0 VTi ZMZ, (EB2F) 1.2 VTi HMZ, (EP6C) 1.6 VTi 5FS, (DV6DTED) 1.6 HDi 9HP, (DV6CTED) 1.6 HDi 9HD, 1.6 GTi (2012-)		

ENGINE MOUNTING & RUBBER BUYERS GUIDE

343

 ID: 34	AR8519 Front Lower Control Arm Bush - Outer Rear Peugeot Boxer (DJ5TED) 2.5TD 1.8 Ton Delivery Van Dies. (02-06)
	AR8520L Front Strut Mounting - LHS Peugeot Boxer (4H4) 2.2 HDi Delivery Van Dies., (DJ5TED) 2.5 TDi Delivery Van Dies. (06-09), (P22DTE) 2.2 HDi "120" 4HU, (P22DTE) 2.2 HDi "130" 4HH, (F1CE0481D, F30DT) 3.0 HDi "130" (2007-)
	AR8520R Front Strut Mounting - RHS Peugeot Boxer (4H4) 2.2 HDi Delivery Van Dies., (DJ5TED) 2.5 TDi Delivery Van Dies. (06-09), (P22DTE) 2.2 HDi "120" 4HU, (P22DTE) 2.2 HDi "130" 4HH, (F1CE0481D, F30DT) 3.0 HDi "130" (2007-)
	AR8521 Engine Mounting - RHS Peugeot Boxer (4H4) 2.2 HDi Delivery Van Dies. (06-09), (P22DTE) 2.2 HDi "120" 4HU, (P22DTE) 2.2 HDi "130" 4HH (2007-)
	AR8522 Engine Mounting - Rear Peugeot Boxer (4H4) 2.2 HDi Delivery Van Dies. (06-09), (P22DTE) 2.2 HDi "120" 4HU, (P22DTE) 2.2 HDi "130" 4HH (2007-)
	AR8523 Engine Mounting - LHS Peugeot Boxer (4H4) 2.2 HDi Delivery Van Dies. (06-09), (P22DTE) 2.2 HDi "120" 4HU, (P22DTE) 2.2 HDi "130" 4HH (2007-)
	AR8524 Engine Mounting - Rear Support Nissan NP200 (K9K) 1.5dCi SWB S, SE P/up (2008-); Renault Clio III (K4J) 1.4 16V, (K9K) 1.5dCi, (K4M) 1.6, (F4R) 2.0 Sport (04-14), Kangoo II (K4M) 1.6 16V 5-Spd. Man. 78kw (2008-), Megane II (K9K) 1.5dCi 5-Spd. Man., (K4M) 1.6 5-Spd. Man. (02-10), Modus (K4J) 1.4 5-Spd. Man., (K4M) 1.6 16V 5-Spd. Man. (05-08), Scenic II (K4M) 1.6 5-Spd. Man. (02-10), Grand Scenic II (K4M) 1.6 16V 6-Spd. Man. (05-10)
	AR8526 Engine Mounting - Rear Support Renault Megane II (F9Q800) 1.9dCi 6-Spd. Man., CC Dynamique, Privilege, Dynamique, '+', (F4R770) 2.0 6-Spd. Man., CC Privilege, Classic Dynamique, (F4R774) 2.0T 6-Spd. Man. Sport, F1 Team (02-10), Scenic II (F9Q812) 1.9dCi Expression, Dynamique Dies. (02-10), Grand Scenic II (F9Q740) 1.9dCi Privilege (JAO5) (05-10)
	AR8527 Engine Mounting - Rear Support Renault Megane II (F9Q800) 1.9dCi, CC Dynamique, dCi Privilege, Dynamique, '+', 2.0, CC Privilege, Classic Dynamique, (F7R710) 2.0T Sport, F1 Team (02-10), Scenic II (F9Q812) 1.9dCi Expression, Dynamique Dies., (F4R770/771) 2.0 Dynamique, Privilege MPV (02-10), Grand Scenic II (F9Q740) 1.9dCi Privilege (JAO5), (F4R740/1) 2.0 Expression MPV (05-10)
	AR8528 Transmission Mounting Nissan Micra (K12) (K9K) 1.5dCi 5-Spd. Man. (04-11), NV200 (M20) (K9K) 1.5dCi, (HR16DE) 1.6 (2013-); Renault Clio III (K9K) 1.5dCi (04-14), Duster I 4X2, 4X4 (K9K) 1.5dCi (13-17), Megane II (K9K) 1.5dCi 5-Spd. Man., (F9Q) 1.9dCi 6-Spd. Man., (F4R) 2.0, 2.0T 6-Spd. Man. (02-10), Modus (D4F) 1.2 5-Spd. Man., (K4J) 1.4 5-Spd. Man. (05-08), Scenic II (F9Q) 1.9dCi 6-Spd. Man., (F4R) 2.0 6-Spd. Man. (02-10), Grand Scenic II (K4M) 1.6 16V 6-Spd. Man., (F9Q) 1.9dCi 6-Spd. Man., (F4R) 2.0 6-Spd. Man. (05-10)

 ID: 18, OD: 55, L: 50.5	AR8529 Front Lower Control Arm Bush - Inner Front Renault Fluence (K4M838/839) 1.6, (M4R714/751) 2.0 (11-16), Megane III (H4J700) 1.4 TCe Coupe, CC, Hatch Dynamique, GT-Line, (K4M9766/858) 1.6 Coupe, Hatch Dynamique, Shake it!, (R9M402) 1.6dCi, (F9Q870/72) 1.9dCi Hatch, Dynamique, 2.0i Coupe RS250 Cup, Sport, (F4R874) 2.0 RS265, 2.0 RB7 (2010-), Scenic III (K4M858) 1.6 Expression MPV, (F9Q870/72) 1.9dCi Dynamique MPV Dies. (2010-), Grand Scenic III (F9Q870/72) 1.9dCi Dynamique MPV (2010-)
 ID: 14, OD: 58, L: 65	AR8530 Front Lower Control Arm Bush - Outer Rear Renault Fluence (K4M838/839) 1.6, (M4R714/751) 2.0 (11-16), Megane III (H4J700) 1.4 TCe Coupe, CC, Hatch Dynamique, GT-Line, (K4M9766/858) 1.6 Coupe, Hatch Dynamique, Shake it!, (R9M402) 1.6dCi, (F9Q870/72) 1.9dCi Hatch, Dynamique, 2.0i Coupe RS250 Cup, Sport, (F4R874) 2.0 RS265, 2.0 RB7 (2010-), Scenic III (K4M858) 1.6 Expression MPV, (F9Q870/72) 1.9dCi Dynamique MPV Dies. (2010-), Grand Scenic III (F9Q870/72) 1.9dCi Dynamique MPV (2010-)
	AR8531 Front Strut Mounting Renault Megane III (H4J700) 1.4 TCe Coupe, CC, Hatch Dynamique, GT-Line, (K4M9766/858) 1.6 Coupe, Hatch Dynamique, Shake it!, (R9M402) 1.6dCi, (F9Q870/72) 1.9dCi Hatch, Dynamique, 2.0i Coupe RS250 Cup, Sport, (F4R874) 2.0 RS265, 2.0 RB7 (2010-), Scenic III (K4M858) 1.6 Expression MPV, (F9Q870/72) 1.9dCi Dynamique MPV Dies. (2010-), Grand Scenic III (F9Q870/72) 1.9dCi Dynamique MPV (2010-)
 ID: 12, OD: 80, L: 69.5	AR8532 Rear Axle Beam Bush Renault Megane III (H4J700) 1.4 TCe Coupe, CC, Hatch Dynamique, GT-Line, (K4M9766/858) 1.6 Coupe, Hatch Dynamique, Shake it!, (R9M402) 1.6dCi, (F9Q870/72) 1.9dCi Hatch, Dynamique, 2.0i Coupe RS250 Cup, Sport, (F4R874) 2.0 RS265, 2.0 RB7 (2010-), Scenic III (K4M858) 1.6 Expression MPV, (F9Q870/72) 1.9dCi Dynamique MPV Dies. (2010-), Grand Scenic III (F9Q870/72) 1.9dCi Dynamique MPV (2010-)
	AR8533 Engine Mounting - RHS Renault Fluence (K4M838/839) 1.6, (M4R714/751) 2.0 (11-16), Megane III (H4J700) 1.4 TCe Coupe, CC, Hatch Dynamique, GT-Line, (K4M9766/858) 1.6 Coupe, Hatch Dynamique, Shake it!, (R9M402) 1.6dCi (2010-), Scenic III (K4M858) 1.6 Expression MPV (2010-)
	AR8534 Engine Mounting - LHS Renault Fluence (M4R714/751) 2.0 (11-16), Megane III (H4J700) 1.4 TCe Coupe, CC, Hatch Dynamique, GT-Line (2010-)
	AR8535 Engine Mounting - Rear Lower Renault Megane III (H4J700) 1.4 TCe Coupe, CC, Hatch Dynamique, GT-Line, 2.0i Coupe RS250 Cup, Sport, (F4R874) 2.0 RS265, 2.0 RB7 (2010-)
	AR8536 Engine Mounting - RHS Upper Renault Megane III (H4J700) 1.4 TCe Coupe, CC, Hatch Dynamique, GT-Line, (K4M9766/858) 1.6 Coupe, Hatch Dynamique, Shake it!, (R9M402) 1.6dCi, 2.0i Coupe RS250 Cup, Sport, (F4R874) 2.0 RS265, 2.0 RB7 (2010-)
	AR8537 Engine Mounting - LHS Renault Fluence (K4M838/839) 1.6 (11-16), Megane III (K4M9766/858) 1.6 Coupe, Hatch Dynamique, Shake it!, (R9M402) 1.6dCi, (F9Q870/72) 1.9dCi Hatch, Dynamique (2010-), Scenic III (K4M858) 1.6 Expression MPV, (F9Q870/72) 1.9dCi Dynamique MPV Dies. (2010-), Grand Scenic III (F9Q870/72) 1.9dCi Dynamique MPV (2010-)
	AR8538 Engine Mounting - Rear Lower Renault Fluence (K4M838/839) 1.6, (M4R714/751) 2.0 (11-16), Megane III (K4M9766/858) 1.6 Coupe, Hatch Dynamique, Shake it!, (R9M402) 1.6dCi (2010-), Scenic III (K4M858) 1.6 Expression MPV (2010-)

ENGINE MOUNTING & RUBBER BUYERS GUIDE

	AR8539 Engine Mounting - RHS Lower Renault Megane III (F9Q870/72) 1.9dCi Hatch, Dynamique (2010-), Scenic III (F9Q870/72) 1.9dCi Dynamique MPV Dies. (2010-), Grand Scenic III (F9Q870/72) 1.9dCi Dynamique MPV (2010-)		AR8552 Front Lower Control Arm Bush - Inner Rear Suzuki Swift (M16A) 1.6 (2010-), SX4 (J20A, J20B) 2.0 (08-14)
	AR8540 Engine Mounting - RHS Upper Renault Megane III (F9Q870/72) 1.9dCi Hatch, Dynamique (2010-), Scenic III (F9Q870/72) 1.9dCi Dynamique MPV Dies. (2010-), Grand Scenic III (F9Q870/72) 1.9dCi Dynamique MPV (2010-)		AR8553 Engine Mounting - RHS Toyota Auris (1AD-FTV) 2.0 D-4D RS, RX, Turbo, XD (07-13), Corolla (1AD-FTV) 2.0D-4D Advanced, Exclusive 6-Spd. Man. (2007-), Verso (1AD-FTV) 2.0D-4D (09-14)
	AR8541 Engine Mounting - Rear Lower Renault Megane III (F9Q870/72) 1.9dCi Hatch, Dynamique (2010-), Scenic III (F9Q870/72) 1.9dCi Dynamique MPV Dies. (2010-), Grand Scenic III (F9Q870/72) 1.9dCi Dynamique MPV (2010-)		AR8555 Engine Mounting - Rear Toyota Auris (1AD-FTV) 2.0 D-4D RS, RX, Turbo, XD (07-13), Corolla (1AD-FTV) 2.0D-4D Advanced, Exclusive 6-Spd. Man. (2007-)
	AR8542 Engine Mounting - RHS Renault Twingo (D4F772) 1.2 Dynamique, '+' (08-13)		AR8556 Engine Mounting - LHS Toyota Auris (1AD-FTV) 2.0 D-4D RS, RX, Turbo, XD (07-13), Corolla (1AD-FTV) 2.0D-4D Advanced, Exclusive 6-Spd. Man. (2007-)
	AR8543 Engine Mounting - LHS Renault Twingo (D4F772) 1.2 Dynamique, '+' (08-13)		AR8557 Engine Mounting - RHS Toyota Auris (1ZR-FE) 1.6 RT, XI, XS, Sport X, XR, (2ZR-FAE) 1.8 RS, RX (07-13), (1ZR-FAE) 1.6, 1.6 TRD (2010-), Corolla (1ZR-FE) 1.6 Advanced, Professional, Sprinter, 6-Spd. Man., 4-Spd. Auto., (2ZR-FE) 1.8 Advanced, Exclusive, 6-Spd. Man., 4-Spd. Auto., (3ZR-FE) 2.0 Sprinter, Exclusive, 6-Spd. Man./Auto. (2007-), Corolla Quest (1ZR-FE) 1.6 (2014-), Verso (1ZR-FAE) 1.6, (2ZR-FAE) 1.8 (09-14)
	AR8544 Engine Mounting - Rear Renault Twingo (D4F772) 1.2 Dynamique, '+', (K4M854) 1.6 RS, Gordini (08-13)		AR8558 Front Strut Mounting Toyota Avanza 1.3 P/van, (K3-VE) 1.3 S, SX MPV, (3SZ-VE) 1.5 SX, TX MPV (06-12)
	AR8545 Engine Support Mounting - Rear, Transmission Mounting Renault Twingo (D4F772) 1.2 Dynamique, '+', (K4M854) 1.6 RS, Gordini (08-13)		AR8559 Rear Axle Beam Bush Toyota Auris (4ZZ-FE) 1.4 RT, RS, (1ZR-FE) 1.6 RT, XI, XS, Sport X, XR, (2ZR-FAE) 1.8 RS, RX, (1AD-FTV) 2.0 D-4D RS, RX, Turbo, XD (07-13), (1NR-FE) 1.3, (1ZR-FAE) 1.6, 1.6 TRD, 1.8 HSD (2010-), Corolla (1NR-FE) 1.3 Advanced, Impact, Professional, 6-Spd. Man., (1ZR-FE) 1.6 Advanced, Professional, Sprinter, 6-Spd. Man., 4-Spd. Auto., (2ZR-FE) 1.8 Advanced, Exclusive, 6-Spd. Man., 4-Spd. Auto., (3ZR-FE) 2.0 Sprinter, Exclusive, 6-Spd. Man./Auto., (1AD-FTV) 2.0D-4D Advanced, Exclusive 6-Spd. Man. (2007-), Corolla (E180) (1NR-FE) 1.3 Esteem, Prestige, (1ND-TV) 1.4D-4D Esteem, Prestige, (1ZR-FE) 1.6 Esteem, Prestige, (2ZR-FE) 1.8 16V Exclusive, Prestige (14-19), Corolla Quest (1ZR-FE) 1.6 (2014-), Corolla Verso (3ZZ-FE) 1.6S, SX, TX MPV 5/6-Spd. Man., (1ZZ-FE) 1.8 SX, TX MPV 5/6-Spd. Man., (1CD-FTV) 2.0D-4D TX MPV, 6-Spd. Man. (04-09), Verso (1ZR-FAE) 1.6, (2ZR-FAE) 1.8, (1AD-FTV) 2.0D-4D (09-14)
	AR8547 Front Lower Control Arm Bush - Inner Front Suzuki Swift (M15A) 1.5i GL, GLS Hatch (08-11)		AR8560 Engine Mounting - RHS Toyota Auris (1NR-FE) 1.3 (2010-), Corolla (1NR-FE) 1.3 Advanced, Impact, Professional, 6-Spd. Man. (2007-)
	AR8548 Front Lower Control Arm Bush - Outer Front & Rear Suzuki Swift (M15A) 1.5i GL, GLS Hatch (08-11), (M16A) 1.6 (2010-), SX4 (J20A, J20B) 2.0 (08-14)		AR8561 Engine Mounting - LHS Toyota Auris (1NR-FE) 1.3 (-2009), Corolla (1NR-FE) 1.3 Advanced, Impact, Professional, 6-Spd. Man. (2009-)
	AR8549 Front Stabilizer Bar Bush Suzuki Swift (M15A) 1.5i GL, GLS Hatch (08-11)		AR8563 Engine Mounting - RHS Toyota Corolla Verso (1CD-FTV) 2.0D-4D TX MPV, 6-Spd. Man. (04-09)
	AR8550 Front Strut Mounting Suzuki Swift (M15A) 1.5i GL, GLS Hatch (08-11)		AR8564 Engine Mounting - Front Toyota Corolla Verso (1CD-FTV) 2.0D-4D TX MPV, 6-Spd. Man. (04-09)
	AR8551 Rear Axle Beam Bush Suzuki Swift (M15A) 1.5i GL, GLS Hatch (08-11)		

ENGINE MOUNTING & RUBBER BUYERS GUIDE

	AR8565 Engine Mounting - Rear Toyota Corolla Verso (1CD-FTV) 2.0D-4D TX MPV, 6-Spd. Man. (04-09)
	AR8566 Engine Mounting - LHS Toyota Corolla Verso (1CD-FTV) 2.0D-4D TX MPV, 6-Spd. Man. (04-09)
 NO PICTURE AVAILABLE AT TIME OF PRINT ID: 15	AR8567 Front Strut Mounting Toyota Corolla Verso (3ZZ-FE) 1.6S, SX, TX MPV 5/6-Spd. Man., (1ZZ-FE) 1.8 SX, TX MPV 5/6-Spd. Man. (04-09)
 ID: 15	AR8568 Front Strut Mounting Toyota Corolla Verso (1CD-FTV) 2.0D-4D TX MPV, 6-Spd. Man. (04-09)
 ID: 15, OD: 45.5, L: 62	AR8570 Front Upper Control Arm Bush - Inner Front & Outer Rear Toyota Fortuner 4X2, 4X4 (1KD-FTV) 3.0D-4D, Raised Body, (1GR-FE) 4.0 V6, Raised Body Pet. (06-11), (2KD-FTV) 2.5D-4D 4-Spd. Auto., 5-Spd. Man., (1KD-FTV) 3.0D-4D DSI 4-Spd. Auto., (1GR-FE) 4.0 5-Spd. Auto. (11-16), (2GD-FTV) 2.4TD RB, (2TR-FE) 2.7 VVTi RB, (1GD-FTV) 2.8TD, (1GD-FTV) 2.8TD RB, (1KDFTV) 3.0D-4D 5-Spd. Auto., 6-Spd. Man., (1GR-FE) 4.0 V6 (2015-), Hilux "VIGO" 4X2, 4X4 (2KD-FTV) 2.5 TDi LWB D-4D S/cab, S, SRX, HO Raised Body, D/C Raider P/up Dies., (2TR-FE) 2.7i LWB S/cab Raider, D/cab Raider, S/cab, HO Raised Body, Legend40, P/up Pet., (1KD-FTV) 3.0D-4D LWB Raider, D/cab Raider Raised Body, Legend40 P/up Dies., (1GR-FE) 4.0 V6 D/cab Raider Raised Body, Legend40 P/up Pet. (05-11), Hilux 4X2 (1TR-FE) 2.0 VVTi 5-Spd. Man., (2KD-FTV) 2.5D-4D Raised Body, (2TR-FE) 2.7 VVTi, (1KD-FTV) 3.0D-4D, (1GR-FE) 4.0, Hilux 4X4 (2KDF-TV) 2.5D-4D 5-Spd. Man., Raised Body, (1KD-FTV) 3.0D-4D, (1GR-FE) 4.0 (11-16), Hilux "REVO" 4X2 (2GD-FTV) 2.4 GD-6 Raised Body, (2TR-FE) 2.7 VVT-i Raised Body, (1GD-FTV) 2.8 GD-6 Raised Body, (1GD-FE) 4.0 V6 Raised Body, Hilux "REVO" 4X4 (2GD-FTV) 2.4 GD-6 Raised Body, (1GD-FTV) 2.8 GD-6 Raised Body, (1GD-FE) 4.0 V6 Raised Body (2016-)
 ID: 14.5, OD: 48.6, L: 71	AR8571 Front Lower Control Arm Bush - Inner Front Toyota Fortuner 4X2, 4X4 (1KD-FTV) 3.0D-4D, Raised Body, (1GR-FE) 4.0 V6, Raised Body Pet. (06-11), (2KD-FTV) 2.5D-4D 4-Spd. Auto., 5-Spd. Man., (1KD-FTV) 3.0D-4D DSI 4-Spd. Auto., (1GR-FE) 4.0 5-Spd. Auto. (11-16), Hilux "VIGO" 4X2, 4X4 (2KD-FTV) 2.5 TDi LWB D-4D S/cab, S, SRX, HO Raised Body, D/C Raider P/up Dies., (2TR-FE) 2.7i LWB S/cab Raider, D/cab Raider, S/cab, HO Raised Body, Legend40, P/up Pet., (1KD-FTV) 3.0D-4D LWB Raider, D/cab Raider Raised Body, Legend40 P/up Dies., (1GR-FE) 4.0 V6 D/cab Raider Raised Body, Legend40 P/up Pet. (05-11), Hilux 4X2 (1TR-FE) 2.0 VVTi 5-Spd. Man., (2KD-FTV) 2.5D-4D Raised Body, (2TR-FE) 2.7 VVTi, (1KD-FTV) 3.0D-4D, (1GR-FE) 4.0, Hilux 4X4 (2KDF-TV) 2.5D-4D 5-Spd. Man., Raised Body, (1KD-FTV) 3.0D-4D, (1GR-FE) 4.0 (11-16)

 ID: 14.5, OD: 56.4, L: 88	AR8572 Front Lower Control Arm Bush - Outer Rear Toyota Fortuner 4X2, 4X4 (1KD-FTV) 3.0D-4D, Raised Body, (1GR-FE) 4.0 V6, Raised Body Pet. (06-11), (2KD-FTV) 2.5D-4D 4-Spd. Auto., 5-Spd. Man., (1KD-FTV) 3.0D-4D DSI 4-Spd. Auto., (1GR-FE) 4.0 5-Spd. Auto. (11-16), Hilux "VIGO" 4X2, 4X4 (2KD-FTV) 2.5 TDi LWB D-4D S/cab, S, SRX, HO Raised Body, D/C Raider P/up Dies., (2TR-FE) 2.7i LWB S/cab Raider, D/cab Raider, S/cab, HO Raised Body, Legend40, P/up Pet., (1KD-FTV) 3.0D-4D LWB Raider, D/cab Raider Raised Body, Legend40 P/up Dies., (1GR-FE) 4.0 V6 D/cab Raider Raised Body, Legend40 P/up Pet. (05-11), Hilux 4X2 (1TR-FE) 2.0 VVTi 5-Spd. Man., (2KD-FTV) 2.5D-4D Raised Body, (2TR-FE) 2.7 VVTi, (1KD-FTV) 3.0D-4D, (1GR-FE) 4.0, Hilux 4X4 (2KDF-TV) 2.5D-4D 5-Spd. Man., Raised Body, (1KD-FTV) 3.0D-4D, (1GR-FE) 4.0 (11-16), Land Cruiser Prado 120 4X4 (1KZ-TE) 3.0TD, VX S/W Dies., 5-Spd. Man., 4-Spd. Auto., (1GR-FE) 4.0 GX, VX S/W 4-Spd. Auto. Pet. (02-09), Prado 150 4X4 (1KD-FTV) 3.0D VX, TX S/W 4-Spd. Auto., Dies., (1GR-FE) 4.0 TX, VX S/W 4-Spd. Auto. Pet. (2010-), 100-Series 4X4 4.0 GX DSL S/W, VX S/W Pet. 5-Spd. Man., Auto. (98-06)
	AR8573 Rear Lateral Link Toyota Fortuner 4X2, 4X4 (1KD-FTV) 3.0D-4D, Raised Body, (1GR-FE) 4.0 V6, Raised Body Pet. (06-11)
	AR8574 Rear Lateral Link Bush Toyota Fortuner 4X2, 4X4 (1KD-FTV) 3.0D-4D, Raised Body, (1GR-FE) 4.0 V6, Raised Body Pet. (06-11)
	AR8575 Front Stabilizer Bar Bush Toyota Land Cruiser 79-Series 4X4 (1GR-FE) 4.0 P/up Pet. 5-Spd. Man. (2009-)
	AR8576 Engine Mounting - L/RHS Toyota Land Cruiser 76-Series 4X4 (1HZ) 4.2D P/up, S/W Dies. 5-Spd. Man. (2009-), 77-Series 4X4 (1HZ) 4.2D P/up, S/W Dies. 5-Spd. Man. (2009-), 79-Series 4X4 (1HZ) 4.2D P/up, S/W Dies. 5-Spd. Man. (2009-)
	AR8577 Engine Mounting - Rear Toyota Land Cruiser 76-Series 4X4 (1HZ) 4.2D P/up, S/W Dies. 5-Spd. Man. (2009-), 77-Series 4X4 (1HZ) 4.2D P/up, S/W Dies. 5-Spd. Man. (2009-), 79-Series 4X4 (1HZ) 4.2D P/up, S/W Dies. 5-Spd. Man. (2009-)
	AR8578 Engine Mounting - L/RHS Toyota Land Cruiser 79-Series 4X4 (1GR-FE) 4.0 P/up Pet. 5-Spd. Man. (2009-)
	AR8579 Engine Mounting - Rear Toyota Land Cruiser 79-Series 4X4 (1GR-FE) 4.0 P/up Pet. 5-Spd. Man. (2009-)
	AR8580 Front Upper Control Arm Bush - Inner & Outer Toyota Land Cruiser 200-Series 4X4 (1VD-FTV) 4.5 VX TD S/W Dies., 6-Spd. Man., (2UZ-FE) 4.7 VX S/W V8 Petrol 5-Spd. Man. (2009-), (1UR-FE) 4.6 V8 6-Spd. Auto. (2012-)
	AR8581 Front Lower Control Arm Bush - Inner Toyota Land Cruiser 200-Series 4X4 (1VD-FTV) 4.5 VX TD S/W Dies., 6-Spd. Man., (2UZ-FE) 4.7 VX S/W V8 Petrol 5-Spd. Man. (2009-), (1UR-FE) 4.6 V8 6-Spd. Auto. (2012-)

ENGINE MOUNTING & RUBBER BUYERS GUIDE

	AR8582 Front Strut Mounting Toyota Land Cruiser 200-Series 4X4 (1VD-FTV) 4.5 VX TD S/W Dies., 6-Spd. Man., (2UZ-FE) 4.7 VX S/W V8 Petrol 5-Spd. Man. (2009-)		AR8596 Engine Mounting - Front Toyota RAV4 III (ACE, ALA) 4X4 (2AD-FTV) 2.2D-4D GX, VX Dies. 5-Spd. Man. (2008-), RAV4 IV 4X4 (2AD-FHV, 2AD-FTV) 2.2D (2013-)
	AR8583 Engine Mounting - L/RHS Toyota Land Cruiser 200-Series 4X4 (2UZ-FE) 4.7 VX S/W V8 Petrol 5-Spd. Man. (2009-)		AR8597 Engine Mounting - Rear Toyota RAV4 III (ACE, ALA) 4X4 (2AD-FTV) 2.2D-4D GX, VX Dies. 5-Spd. Man. (06-08)
	AR8584 Engine Mounting - Rear Toyota Land Cruiser 200-Series 4X4 (2UZ-FE) 4.7 VX S/W V8 Petrol 5-Spd. Man. (2009-)		AR8599 Engine Mounting - LHS Toyota RAV4 III (ACE, ALA) 4X4 (2AD-FTV) 2.2D-4D GX, VX Dies. 5-Spd. Man. (06-13)
	AR8585 Engine Mounting - L/RHS Toyota Land Cruiser 200-Series 4X4 (1VD-FTV) 4.5 VX TD S/W Dies., 6-Spd. Man. (2009-)		AR8600 Engine Support Mounting - Rear Volkswagen Golf VI (CAYC) 1.6 TDi Comfortline, DSG, Bluemotion, (CBAB, CFFB) 2.0 TDi HighLine (09-13)
	AR8586 Engine Mounting - Rear Toyota Land Cruiser 200-Series 4X4 (1VD-FTV) 4.5 VX TD S/W Dies., 6-Spd. Man. (2009-)		AR8603 Engine Mounting - RHS Volkswagen Golf VI (CCZB) 2.0 GTi DSG (09-13)
	AR8587L Front Stabilizer Bar Bush - LHS Toyota RAV4 III (ACE, ALA) 4X4 (1AZ-FE) 2.0 GX, VX, Fierce SUV Pet., 5-Spd. Man., 4-Spd. Auto., (2AD-FTV) 2.2D-4D GX, VX Dies. 5-Spd. Man. (06-13)		AR8605 Front Lower Control Arm Bush - Inner Front & Outer Rear Mercedes-Benz Sprinter (BM906) 309 CDI Bus, P/van, (OM646.985) 311 CDI LWB Bus, P/van, (OM646.990) 315 CDI Bus, P/van, (OM642.992) 318 CDI Bus, P/van, (OM646.984) 509 CDI Bus, P/van, (OM646.985) 511 CDI Bus, P/van, (OM646.986) 515 CDI Bus, P/van, (OM646.992) 518 CDI Bus, P/van (2006-), Sprinter (BM906) (OM646.984) 309 CDI P/van, 16-Seater, (OM646.989, 990) 315 CDI FC, 16-Seater, (OM642.992, 993, 896) 318 CDI P/van, (OM642.992, 896, 898) 319 CDI DC, FC, PV, XC, (OM646.992, 993, 896) 518 CDI FC, DC, PV, 22-Seater, (OM642.896, 898, 992) 519 CDI (2009-); Volkswagen Crafter (CKTB, CSNB) 2.0 BITDi, (BJK, BJM) 2.5TDi 35-Series SWB, P/van, 50 HR-Series LWB, XLWB P/van (2007-)
	AR8587R Front Stabilizer Bar Bush - RHS Toyota RAV4 III (ACE, ALA) 4X4 (1AZ-FE) 2.0 GX, VX, Fierce SUV Pet., 5-Spd. Man., 4-Spd. Auto., (2AD-FTV) 2.2D-4D GX, VX Dies. 5-Spd. Man. (06-13)	ID: 14, OD: 59, L: 75	
	AR8590 Transmission Mounting Toyota RAV4 III (ACE, ALA) 4X4 (1AZ-FE) 2.0 GX, VX, Fierce SUV Pet., 5-Spd. Man., 4-Spd. Auto. (06-13), RAV4 IV 4X2 (3ZR-FE) 2.0 (2013-)		AR8606 Front Stabilizer Bar Bush Volkswagen Crafter (CKTB, CSNB) 2.0 BITDi, (BJK, BJM) 2.5TDi 35-Series SWB, P/van, 50 HR-Series LWB, XLWB P/van (2007-)
	AR8591 Engine Mounting - Front Toyota RAV4 III (ACE, ALA) 4X4 (1AZ-FE) 2.0 GX, VX, Fierce SUV Pet., 5-Spd. Man., 4-Spd. Auto. (06-13), RAV4 IV 4X2 (3ZR-FE) 2.0, (2AR-FE) 2.5 VX AWD (2013-)	ID: 27	
	AR8592 Engine Mounting - Rear Toyota RAV4 III (ACE, ALA) 4X4 (1AZ-FE) 2.0 GX, VX, Fierce SUV Pet., 5-Spd. Man., 4-Spd. Auto. (06-13), RAV4 IV 4X2 (3ZR-FE) 2.0 (2013-)		AR8607 Front Strut Mounting Mercedes-Benz Sprinter (BM906) 309 CDI Bus, P/van, (OM646.985) 311 CDI LWB Bus, P/van, (OM646.990) 315 CDI Bus, P/van, (OM642.992) 318 CDI Bus, P/van, (OM646.984) 509 CDI Bus, P/van, (OM646.985) 511 CDI Bus, P/van, (OM646.986) 515 CDI Bus, P/van, (OM646.992) 518 CDI Bus, P/van (2006-), Sprinter (BM906) (OM646.984) 309 CDI P/van, 16-Seater, (OM646.989, 990) 315 CDI FC, 16-Seater, (OM642.992, 993, 896) 318 CDI P/van, (OM642.992, 896, 898) 319 CDI DC, FC, PV, XC, (OM646.992, 993, 896) 518 CDI FC, DC, PV, 22-Seater, (OM642.896, 898, 992) 519 CDI (2009-); Volkswagen Crafter (CKTB, CSNB) 2.0 BITDi, (BJK, BJM) 2.5TDi 35-Series SWB, P/van, 50 HR-Series LWB, XLWB P/van (2007-)
	AR8593 Engine Mounting - LHS Toyota RAV4 III (ACE, ALA) 4X4 (1AZ-FE) 2.0 GX, VX, Fierce SUV Pet., 5-Spd. Man., 4-Spd. Auto. (06-13), RAV4 IV 4X2 (3ZR-FE) 2.0 (2013-)		
	AR8594 Transmission Mounting Toyota RAV4 III (ACE, ALA) 4X4 (2AD-FTV) 2.2D-4D GX, VX Dies. 5-Spd. Man. (06-13)		AR8608 Front Stabilizer Bar Bush Mercedes-Benz Sprinter (BM906) 309 CDI Bus, P/van, (OM646.985) 311 CDI LWB Bus, P/van, (OM646.990) 315 CDI Bus, P/van, (OM642.992) 318 CDI Bus, P/van, (OM646.984) 509 CDI Bus, P/van, (OM646.985) 511 CDI Bus, P/van, (OM646.986) 515 CDI Bus, P/van, (OM646.992) 518 CDI Bus, P/van (2006-), Sprinter (BM906) (OM646.984) 309 CDI P/van, 16-Seater, (OM646.989, 990) 315 CDI FC, 16-Seater, (OM642.992, 993, 896) 318 CDI P/van, (OM642.992, 896, 898) 319 CDI DC, FC, PV, XC, (OM646.992, 993, 896) 518 CDI FC, DC, PV, 22-Seater, (OM642.896, 898, 992) 519 CDI (2009-)
	AR8595 Engine Mounting - Front Toyota RAV4 III (ACE, ALA) 4X4 (2AD-FTV) 2.2D-4D GX, VX Dies. 5-Spd. Man. (06-08)		

ENGINE MOUNTING & RUBBER BUYERS GUIDE

	<p>AR8609 Front Stabilizer Bar Bush</p> <p>Mercedes-Benz Sprinter (BM906) 309 CDi Bus, P/van, (OM646.985) 311 CDi LWB Bus, P/van, (OM646.990) 315 CDi Bus, P/van, (OM642.992) 318 CDi Bus, P/van, (OM646.984) 509 CDi Bus, P/van, (OM646.985) 511 CDi Bus, P/van, (OM646.986) 515 CDi Bus, P/van, (OM646.992) 518 CDi Bus, P/van (2006-), Sprinter (BM906) (OM646.984) 309 CDi P/van, 16-Seater, (OM646.989, 990) 315 CDi FC, 16-Seater, (OM642.992, 993, 896) 318 CDi P/van, (OM642.992, 896, 898) 319 CDi DC, FC, PV, XC, (OM646.992, 993, 896) 518 CDi FC, DC, PV, 22-Seater, (OM642.896, 898, 992) 519 CDi (2009-)</p>
	<p>AR8610 Engine Mounting - Rear</p> <p>Mercedes-Benz Sprinter (BM906) 309 CDi Bus, P/van, (OM646.985) 311 CDi LWB Bus, P/van, (OM646.990) 315 CDi Bus, P/van, (OM642.992) 318 CDi Bus, P/van, (OM646.984) 509 CDi Bus, P/van, (OM646.985) 511 CDi Bus, P/van, (OM646.986) 515 CDi Bus, P/van, (OM646.992) 518 CDi Bus, P/van (2006-), Sprinter (BM906) (OM646.984) 309 CDi P/van, 16-Seater, (OM646.989, 990) 315 CDi FC, 16-Seater, (OM642.992, 993, 896) 318 CDi P/van, (OM642.992, 896, 898) 319 CDi DC, FC, PV, XC, (OM646.992, 993, 896) 518 CDi FC, DC, PV, 22-Seater, (OM642.896, 898, 992) 519 CDi (2009-); Volkswagen Crafter (CKTB, CSNB) 2.0 BITDi, (BJK, BJM) 2.5TDi 35-Series SWB, P/van, 50 HR-Series LWB, XLWB P/van (2007-)</p>
	<p>AR8611 Engine Mounting - Rear</p> <p>Mercedes-Benz Sprinter (BM906) 309 CDi Bus, P/van, (OM646.985) 311 CDi LWB Bus, P/van, (OM646.990) 315 CDi Bus, P/van, (OM642.992) 318 CDi Bus, P/van, (OM646.984) 509 CDi Bus, P/van, (OM646.985) 511 CDi Bus, P/van, (OM646.986) 515 CDi Bus, P/van, (OM646.992) 518 CDi Bus, P/van (2006-), Sprinter (BM906) (OM646.984) 309 CDi P/van, 16-Seater, (OM646.989, 990) 315 CDi FC, 16-Seater, (OM642.992, 993, 896) 318 CDi P/van, (OM642.992, 896, 898) 319 CDi DC, FC, PV, XC, (OM646.992, 993, 896) 518 CDi FC, DC, PV, 22-Seater, (OM642.896, 898, 992) 519 CDi (2009-), (W639) Vito 113 CDi, (OM646.980/982) 115 CDi, (OM651.940) 116 CDi, 120 CDi, (OM642.890) 122 CDi (2004-)</p>
	<p>AR8612 Engine Mounting - L/RHS</p> <p>Mercedes-Benz Sprinter (BM906) 309 CDi Bus, P/van, (OM646.985) 311 CDi LWB Bus, P/van, (OM646.990) 315 CDi Bus, P/van, (OM642.992) 318 CDi Bus, P/van, (OM646.984) 509 CDi Bus, P/van, (OM646.985) 511 CDi Bus, P/van, (OM646.986) 515 CDi Bus, P/van, (OM646.992) 518 CDi Bus, P/van (2006-), Sprinter (BM906) (OM646.984) 309 CDi P/van, 16-Seater, (OM646.989, 990) 315 CDi FC, 16-Seater, (OM642.992, 993, 896) 318 CDi P/van, (OM642.992, 896, 898) 319 CDi DC, FC, PV, XC, (OM646.992, 993, 896) 518 CDi FC, DC, PV, 22-Seater, (OM642.896, 898, 992) 519 CDi (2009-); Volkswagen Crafter (CKTB, CSNB) 2.0 BITDi, (BJK, BJM) 2.5TDi 35-Series SWB, P/van, 50 HR-Series LWB, XLWB P/van (2007-)</p>
 <p>ID: 18</p>	<p>AR8615 Front Stabilizer Bar Bush</p> <p>Ford Focus II (IQDB) 1.6 Ambiente, Trend, Si, (QQDB, Q7DA) 1.8, (AODA, AODB, AODE) 2.0, (G6DA, G6DB, G6DD) 2.0 TDCi, (HYDA) 2.5 RS, ST (05-12), Focus III (PNDA) 1.6i, (MGDA) 2.0 TDCi, GDi, GTDi, (R9DA) ST1, ST3 (11-15), Kuga 4X2, 4X4 (JQMB, JQMA) 1.6 Ecoboost, Ambiente, (JTMA) 1.6 Ecoboost Titanium, Trend, (TXDA, TXMA) 2.0 TDCi Titanium, Trend AWD Powershift, (TXDB) 2.5 Turbo, Titanium, Trend AWD (2011-); Mazda 3 (BK, BL) (B6ZE, Z6) 1.6 Original, Active, Dynamic, (LF17) 2.0 Dynamic, Individual, (L3KG) 2.3 Individual MPS, (L5-VE) 2.5 (04-14), 5 (CR19) (LFF7) 2.0 Original, Active, Dynamic, Individual (07-10), 5 (CW) (LFZB) 2.0 (10-14); Volvo C30 (B4164S3) 1.6 Pet., (D4162T) 1.6 D2 Dies., (B4184S11) 1.8, (B4204S3) 2.0i, 2.0D, (B5254T3/7) 2.5i (07-13), S40 (D4162T) 1.6 D2, (B4184S11) 1.8i, (B4204S3) 2.0, (D5204T) 2.0 D4, (D4204T) 2.0D, (D5244T13) 2.4 D5, (B5244S4) 2.4i, (B5254T3/7) 2.5i T5 (04-12), V50 1.8, (B4204S3) 2.0i Sedan R-Design, Powershift, (B5244S) 2.0D VS Sedan, 2.4 D5, (B5252FS) 2.4i VS T5 Sedan, (B5254T3/7) 2.5i T5 Sedan R-Design, Geartronic (04-12)</p>

	<p>AR8616 Engine Mounting - Rear</p> <p>Ford Fiesta III (M1JE) 1.6i TDCi (2008-), Figgo 1.4 TDCi Ambiente, (FXJA, FXJB) 1.4i Ambiente, Trend (10-16), Focus II (IQDB) 1.6 Ambiente, Trend, Si, (QQDB, Q7DA) 1.8, (AODA, AODB, AODE) 2.0, (G6DA, G6DB, G6DD) 2.0 TDCi, (HYDA) 2.5 RS, ST (05-12), Focus III (PNDA) 1.6i, (MGDA) 2.0 TDCi, GDi, GTDi, (R9DA) ST1, ST3 (11-15); Mazda 3 (BK, BL) (B6ZE, Z6) 1.6 Original, Active, Dynamic, (LF17) 2.0 Dynamic, Individual, (L3KG) 2.3 Individual MPS, (L5-VE) 2.5 (04-14); Volvo C30 (D4162T) 1.6 D2 Dies., (B4184S11) 1.8, (B4204S3) 2.0i (07-13), S40 (D4162T) 1.6 D2, (B4184S11) 1.8i, (B4204S3) 2.0, (D5204T) 2.0 D4 (04-12), V50 (B4204S3) 2.0i Sedan R-Design, Powershift, (B5244S) 2.0D VS Sedan (04-12)</p>
 <p>ID: 12</p>	<p>AR8617 Engine Mounting - Rear</p> <p>Volvo C30 (B5254T3/7) 2.5i (07-13), C70 (B5254T3/7) 2.5 T5 Sedan (06-13), S40 (D4204T) 2.0D, (D5244T13) 2.4 D5, (B5244S4) 2.4i, (B5254T3/7) 2.5i T5 (04-12), V40 (D5204T6) 2.0 D3, (D5204T4) 2.0 D4 Cross Country, (B5254T12) 2.5 T5 (2012-), V50 2.4 D5, (B5252FS) 2.4i VS T5 Sedan, (B5254T3/7) 2.5i T5 Sedan R-Design, Geartronic (04-12)</p>
	<p>AR8617I Engine Mounting - Rear (Insert Only)</p> <p>Volvo C30 (B5254T3/7) 2.5i (07-13), C70 (B5254T3/7) 2.5 T5 Sedan (06-13), S40 (D4204T) 2.0D, (D5244T13) 2.4 D5, (B5244S4) 2.4i, (B5254T3/7) 2.5i T5 (04-12), V40 (D5204T6) 2.0 D3, (D5204T4) 2.0 D4 Cross Country, (B5254T12) 2.5 T5 (2012-), V50 2.4 D5, (B5252FS) 2.4i VS T5 Sedan, (B5254T3/7) 2.5i T5 Sedan R-Design, Geartronic (04-12)</p>
	<p>AR8619 Engine Mounting - RHS</p> <p>Volvo XC70 4X4 (D5244T5/10/14/16) 2.4 D5 Estate, SUV, Geartronic, (B5254T2) 2.5 T5 Estate, SUV, Geartronic, (B6324S) 3.2 Estate, SUV, Geartronic (2007-)</p>
 <p>ID: 14.2, OD: 53.5, L: 50</p>	<p>AR8620 Front Lower Control Arm Bush - Inner Front</p> <p>Volvo XC90 (D5244T4) 2.4i D5 5/7-Seater SUV Geartronic, R-Design, Exec., (B5254T2) 2.5 T5 5/7-Seater SUV Geartronic, (B6294T) 2.9 T6 5/7-Seater SUV, (B6324S) 3.2 5/7-Seater SUV Geartronic, R-Design, (B8444S) 4.4 7-Seater SUV, Geartronic, Executive, R-Design (2003-)</p>
 <p>ID: N/A, OD: 58, L: 124</p>	<p>AR8621 Front Lower Control Arm Bush - Outer Rear</p> <p>Volvo XC90 (D5244T4) 2.4i D5 5/7-Seater SUV Geartronic, R-Design, Exec., (B5254T2) 2.5 T5 5/7-Seater SUV Geartronic, (B6294T) 2.9 T6 5/7-Seater SUV, (B6324S) 3.2 5/7-Seater SUV Geartronic, R-Design, (B8444S) 4.4 7-Seater SUV, Geartronic, Executive, R-Design (2003-)</p>
	<p>AR8622 Front Strut Mounting - Upper</p> <p>Volvo S60 (B5204T5) 2.0T, (B5234T3) 2.3 T5, (B5244S) 2.4, (D5244T) 2.4 D5, (D5244T4) 2.4 D5, (B5244T5) 2.4 T5, (B5254T2) 2.5T (03-09), S60 4X4 (B5244T4) 2.5 R (03-09), XC90 (D5244T4) 2.4i D5 5/7-Seater SUV Geartronic, R-Design, Exec., (B5254T2) 2.5 T5 5/7-Seater SUV Geartronic, (B6294T) 2.9 T6 5/7-Seater SUV, (B6324S) 3.2 5/7-Seater SUV Geartronic, R-Design, (B8444S) 4.4 7-Seater SUV, Geartronic, Executive, R-Design (2003-)</p>
	<p>AR8623 Front Strut Mounting - Lower</p> <p>Volvo S60 (B5204T5) 2.0T, (B5234T3) 2.3 T5, (B5244S) 2.4, (D5244T) 2.4 D5, (D5244T4) 2.4 D5, (B5244T5) 2.4 T5, (B5254T2) 2.5T (03-09), S60 4X4 (B5244T4) 2.5 R (03-09), XC90 (D5244T4) 2.4i D5 5/7-Seater SUV Geartronic, R-Design, Exec., (B5254T2) 2.5 T5 5/7-Seater SUV Geartronic, (B6294T) 2.9 T6 5/7-Seater SUV, (B6324S) 3.2 5/7-Seater SUV Geartronic, R-Design, (B8444S) 4.4 7-Seater SUV, Geartronic, Executive, R-Design (2003-)</p>
	<p>AR8624 Engine Mounting - Rear, Transmission Mounting</p> <p>Volvo S60 (D5244T) 2.4 D5, (D5244T4) 2.4 D5 (03-09), XC90 (D5244T4) 2.4i D5 5/7-Seater SUV Geartronic, R-Design, Exec. (2003-)</p>

ENGINE MOUNTING & RUBBER BUYERS GUIDE

	AR8625 Engine Mounting - RHS Volvo XC90 (B6294T) 2.9 T6 5/7-Seater SUV, (B6324S) 3.2 5/7-Seater SUV Geartronic, R-Design (2003-)		AR8638L Front Lower Control Arm Bush - Outer LHS Honda Civic VIII (R18A2) 1.8i VXi 6-Spd. Man (06-11)
	AR8626 Engine Mounting - Front Lower Volvo XC90 (B6294T) 2.9 T6 5/7-Seater SUV, (B6324S) 3.2 5/7-Seater SUV Geartronic, R-Design (2003-)		AR8638R Front Lower Control Arm Bush - Outer RHS Honda Civic VIII (R18A2) 1.8i VXi 6-Spd. Man (06-11)
	AR8628 Front Lower Control Arm Bush - Inner Front Outer Honda Accord (K20A6) 2.0i, (K24A3) 2.4i VTEC, Tourer, Exec. (03-08), (R20A3) 2.0i V-TEC, (N22B1) 2.2i D-TEC, Tourer, Exec., (K24Z3) 2.4i V-TEC, Tourer, Exec. (08-15)		AR8639 Front Stabilizer Bar Bush Honda CR-V II 4X4 (K20A4) 2.0i SWB SUV, (N22A2) 2.2 CTDi SWB SUV, (N22B3) 2.2 i-DTEC, (K24Z1/4) 2.4i V-TEC SWB SUV (05-09)
	AR8629 Front Upper Control Arm Bush - Inner & Outer Honda Accord (K20A6) 2.0i, (K24A3) 2.4i VTEC, Tourer, Exec. (03-08), (R20A3) 2.0i V-TEC, (N22B1) 2.2i D-TEC, Tourer, Exec., (K24Z3) 2.4i V-TEC, Tourer, Exec. (08-15)		AR8640 Front Lower Control Arm Bush - Outer LHS Honda CR-V III 4X4 (R20A1) 2.0i SWB SUV, (N22A2) 2.2 CTDi SWB SUV, (N22B3) 2.2 i-DTEC, (K24Z1/4) 2.4i V-TEC SWB SUV (09-12)
	AR8630 Front Stabilizer Bar Bush Honda Accord (K20A6) 2.0i, (K24A3) 2.4i VTEC, Tourer, Exec. (03-08)		AR8641 Front Lower Control Arm Bush - Outer RHS Honda CR-V III 4X4 (R20A1) 2.0i SWB SUV, (N22A2) 2.2 CTDi SWB SUV, (N22B3) 2.2 i-DTEC, (K24Z1/4) 2.4i V-TEC SWB SUV (09-12)
	AR8631 Rear Stabilizer Bar Bush Honda Accord (K20A6) 2.0i, (K24A3) 2.4i VTEC, Tourer, Exec. (03-08)		AR8642 Front Lower Control Arm Bush - Inner Honda CR-V III 4X4 (R20A1) 2.0i SWB SUV, (N22A2) 2.2 CTDi SWB SUV, (N22B3) 2.2 i-DTEC, (K24Z1/4) 2.4i V-TEC SWB SUV (09-12)
	AR8632 Front & Rear Strut Mounting Honda Accord (K20A6) 2.0i, (K24A3) 2.4i VTEC, Tourer, Exec. (03-08)		AR8643 Rear Stabilizer Bar Bush Honda CR-V III 4X4 (R20A1) 2.0i SWB SUV, (N22A2) 2.2 CTDi SWB SUV, (N22B3) 2.2 i-DTEC, (K24Z1/4) 2.4i V-TEC SWB SUV (09-12)
	AR8633 Engine Mounting - Front Honda Accord (K20A6) 2.0i, (K24A3) 2.4i VTEC, Tourer, Exec. (03-08)		AR8644 Rear Strut Mounting Hyundai Accent (G4EH) 1.3 LS, (G4EK) 1.5 LS (00-03), (G4EH) 1.3 LS, (G4EK) 1.5 LS, (G4ED) 1.6 GLS, HS, SR Sport (03-06)
	AR8634 Engine Mounting - RHS Honda Accord (K20A6) 2.0i, (K24A3) 2.4i VTEC, Tourer, Exec. (03-08)		AR8647 Front Stabilizer Bar Bush Hyundai Accent (G4ED) 1.6 GLS, HS, (G4FC) 1.6 (06-11); Kia Rio II (A5D) 1.4, (G4ED) 1.6 Sport (05-11), Rio III (G4LA) 1.2, (G4FA) 1.4 (2011-)
	AR8635 Front Stabilizer Bar Bush Honda Civic (D15Z4) 150i, (D17A5) 170i (00-06)		AR8468 Front Lower Control Arm Bush - Inner Hyundai Atos (G4HC) 1.0 Prime, (G4HG) 1.1 GLS (07-13)
	AR8636 Front Strut Mounting Honda Civic (D15Z4) 150i, (D17A5) 170i (00-06), CR-V II 4X4 (K20A4) 2.0i SWB SUV, (N22A2) 2.2 CTDi SWB SUV, (N22B3) 2.2 i-DTEC, (K24Z1/4) 2.4i V-TEC SWB SUV (05-09)		AR8649L Front Lower Control Arm Bush - Outer LHS Hyundai Atos (G4HC) 1.0 Prime, (G4HG) 1.1 GLS (07-13)
	AR8637 Rear Strut Mounting Honda Civic (D15Z4) 150i, (D17A5) 170i (00-06), CR-V II 4X4 (K20A4) 2.0i SWB SUV, (N22A2) 2.2 CTDi SWB SUV, (N22B3) 2.2 i-DTEC, (K24Z1/4) 2.4i V-TEC SWB SUV (05-09)		AR8649R Front Lower Control Arm Bush - Rear RHS Hyundai Atos (G4HC) 1.0 Prime, (G4HG) 1.1 GLS (07-13)

ENGINE MOUNTING & RUBBER BUYERS GUIDE

	AR8650 Front Strut Mounting Hyundai Atos (G4HC) 1.0 Prime, (G4HG) 1.1 GLS (00-07), (G4HC) 1.0 Prime, (G4HG) 1.1 GLS (07-13)
	AR8651 Engine Mounting - RHS Nissan NP200 (K7M) 1.6 8V SWB S, SE P/up Dies. (2008-); Renault Logan (K7M710) 1.6 Expression (08-12), Sandero (K7J710) 1.4 Authentique, Ambience, (K7M690/710) 1.6 Cup, Dynamique, Stepway, Expression, '+', Pack, League, United (09-15)
 ID: 12, OD: 60, L: 54.5	AR8654 Front Lower Control Arm Bush - Outer Hyundai i10 (G4HG) 1.1 GLS, (G4LA) 1.2 GLS, GLS HS (2008-); Kia Picanto (G4HG) 1.1 LX, EX Std. (04-11)
 ID: 19	AR8655 Front Stabilizer Bar Bush Hyundai i10 (G4HG) 1.1 GLS, (G4LA) 1.2 GLS, GLS HS (2008-)
 ID: 23.5	AR8658 Front Stabilizer Bar Bush Hyundai Elantra (HD) 1.6 GLS, (G4GC) 2.0 GLS (07-11), i30 (G4FG) 1.6, (G4GC-G) 2.0 (10-12); Kia Carens (G4KA) 2.0 CVVT, (D4EA) 2.0 CRDi (03-09)
 ID: 14.5, OD: 63, L: 56	AR8659 Front Lower Control Arm Bush - Outer Rear Hyundai Elantra (XD) (G4ED) 1.6 GL, GLS Pet., (G4GC) 2.0 GLS, GLS S/W Pet., 2.0 CRDi GLS Dies. (00-06), Matrix (G4ED-G) 1.6, (G4GB-G) 1.8 (02-07)
	AR8661 Front Stabilizer Bar Bush Hyundai Matrix (G4ED-G) 1.6, (G4GB-G) 1.8 (02-07)
	AR8662L Rear Strut Mounting - LHS Hyundai Atos (G4HC) 1.0 Prime, (G4HG) 1.1 GLS (00-07), Matrix (G4ED-G) 1.6, (G4GB-G) 1.8 (02-07)
	AR8662R Rear Strut Mounting - RHS Hyundai Atos (G4HC) 1.0 Prime, (G4HG) 1.1 GLS (00-07), Matrix (G4ED-G) 1.6, (G4GB-G) 1.8 (02-07)
	AR8664 Front Lower Control Arm Bush - Outer Rear Hyundai Santa Fe' (D4EB, D4HB) 2.2 CRDi (2006-), Santa Fe' 4X4 (D4EB, D4HB) 2.2 CRDi, (G6EA) 2.7 GLS (2006-); Kia Sorento 4X2, 4X4 (D4HB) 2.2 CRDi, (G6DC) 3.5 (2009-)
	AR8665 Front Stabilizer Bar Bush Hyundai H1 (G4KC) 2.4 CVVT, (D4CB) 2.5 CRDi (2009-), Santa Fe' (D4EB, D4HB) 2.2 CRDi (2006-), Santa Fe' 4X4 (D4EB, D4HB) 2.2 CRDi, (G6EA) 2.7 GLS (2006-), Sonata (NF) 2.4 GLS (05-10); Kia Sorento 4X2, 4X4 (D4HB) 2.2 CRDi, (G6DC) 3.5 (2009-)
 ID: 12, L: 39, H: 55	AR8666 Front Lower Control Arm Bush - Inner Front Hyundai Tucson (G4GC) 2.0 GLS (04-11), Tucson 4X4 (D4EA) 2.0 CRDi, (G6BA-G) 2.7 V6 (04-10); Kia Carens (G4KA) 2.0 CVVT, (D4EA) 2.0 CRDi (07-09), Cerato (TD) (G4FC) 1.6, (G4KD) 2.0 (09-13), Sportage 4X2, 4X4 (G4GC) 2.0 SWB SUV, (D4EA) 2.0 CRDi SUV, (G6BA) 2.7 V6 SUV (05-10)

	AR8667 Front Stabilizer Bar Bush Hyundai Tucson (G4GC) 2.0 GLS (04-11), Tucson 4X4 (D4EA) 2.0 CRDi, (G6BA-G) 2.7 V6 (04-10),
 ID: 14, OD: 66, L: 60	AR8668 Front Lower Control Arm Bush - Inner Front & Outer Rear Hyundai i30 (G4FG) 1.6, (G4GC-G) 2.0 (10-12), Santa Fe' (D4EB, D4HB) 2.2 CRDi (2006-), Santa Fe' 4X4 (D4EB, D4HB) 2.2 CRDi, (G6EA) 2.7 GLS (2006-); Kia Carens (G4KA) 2.0 CVVT, (D4EA) 2.0 CRDi (07-09), Cerato (TD) (G4FC) 1.6, (G4KD) 2.0 (09-13), Sedona (D4HB) 2.2 CRDi, (KV6) 3.8 (07-13), Sorento 4X2, 4X4 (D4HB) 2.2 CRDi, (G6DC) 3.5 (2009-)
 ID: 14	AR8669 Rear Stabilizer Bar Bush Kia Carens (G4KA) 2.0 CVVT, (D4EA) 2.0 CRDi (03-09)
	AR8670 Rear Stabilizer Bar Bush Kia Cerato (G4FC) 1.6 LX, 2.0 CRDi (04-08)
 L: 27	AR8671 Front Lower Control Arm Bush - Inner Kia Sorento 4X2, 4X4 (D4CB) 2.5 CRDi SUV, (D4HB) 3.5 V6, 3.8 V6 (02-09)
	AR8672 Front Stabilizer Bar Bush Kia Sportage 4X2, 4X4 (G4GC) 2.0 SWB SUV, (D4EA) 2.0 CRDi SUV, (G6BA) 2.7 V6 SUV (05-10)
	AR8673 Front Stabilizer Bar Bush Mercedes-Benz (W169) A-Class A170 (M266.940) 1.7 Classic, A180 (OM640.940) 2.0 CdI Classic, A200 (M266.960) 2.0 Elegance (05-13), (W211) E-Class (M271.941/956) E200K, (OM647.961) E270 CdI, (M112.949) E320, (OM642.920) E320 CdI, (M272.964) E350, (M113.967) E500 (02-10), (W245) B-Class (M266.940) B170, (M266.940) B180, (OM640.941) B200 CdI, (M266.960) B200, (M266.980) B200 Turbo (06-12)
	AR8674 Front Strut Mounting Mercedes-Benz (W169) A-Class A170 (M266.940) 1.7 Classic, A180 (OM640.940) 2.0 CdI Classic, A200 (M266.960) 2.0 Elegance (05-13), (W245) B-Class (M266.940) B170, (M266.940) B180, (OM640.941) B200 CdI, (M266.960) B200, (M266.980) B200 Turbo (06-12)
	AR8675 Engine Mounting - Rear LHS Mercedes-Benz (W169) A-Class A170 (M266.940) 1.7 Classic, A180 (OM640.940) 2.0 CdI Classic, A200 (M266.960) 2.0 Elegance (05-13) - Man. Models, (W245) B-Class (M266.940) B170, (M266.940) B180, (OM640.941) B200 CdI, (M266.960) B200, (M266.980) B200 Turbo (06-12)
	AR8676 Engine Mounting - Rear LHS Mercedes-Benz (W169) A-Class A170 (M266.940) 1.7 Auto. Classic, A180 (OM640.940) 2.0 Auto. CdI Classic, A200 (M266.960) 2.0 Auto. Elegance (05-13), (W245) B-Class (M266.940) B170, (M266.940) B180, (OM640.941) B200 CdI, (M266.960) B200, (M266.980) B200 Turbo (06-12)
	AR8677 Engine Mounting - Front L/RHS Mercedes-Benz (W169) A-Class A170 (M266.940) 1.7 Classic, A180 (OM640.940) 2.0 CdI Classic, A200 (M266.960) 2.0 Elegance (05-13), (W245) B-Class (M266.940) B170, (M266.940) B180, (OM640.941) B200 CdI, (M266.960) B200, (M266.980) B200 Turbo (06-12)





ENGINE MOUNTING & RUBBER BUYERS GUIDE

	AR8678 Engine Mounting - Rear RHS Mercedes-Benz (W169) A-Class A170 (M266.940) 1.7 Classic, A180 (OM640.940) 2.0 CDi Classic, A200 (M266.960) 2.0 Elegance (05-13), (W245) B-Class (M266.940) B170, (M266.940) B180, (OM640.941) B200 CDi, (M266.960) B200, (M266.980) B200 Turbo (06-12)		AR8689 Engine Mounting - L/RHS Mercedes-Benz (W639) Vito 113 CDi, (OM646.980/982) 115 CDi, (OM651.940) 116 CDi, 120 CDi, (OM642.890) 122 CDi (2004-)
	AR8679 Rear Lower Control Arm Bush - Outer Mercedes-Benz (W204) C-Class (M271.910, M271.952) C180K, (M271.950) C200K, (OM651.911) C220 CDi, (M272.947) C300, (OM642.960) C350 CDi, (M272.961) C350 (07-14)		AR8690 Rear Lower Control Arm Bush - Front Mercedes-Benz (W163) ML-Class (M111.977) ML230 SUV, (OM612.963) ML270 CDi SUV, (M112.942) ML320 SUV, (M113.942) ML430 SUV, (M113.964) ML500 SUV, (M113.981) ML55 AMG SUV (98-06)
	AR8680 Front Lower Control Arm Bush - Outer Rear Mercedes-Benz (W204) C-Class (M271.910, M271.952) C180K, (M271.950) C200K, (OM651.911) C220 CDi, (M272.947) C300, (OM642.960) C350 CDi, (M272.961) C350 (07-14)		AR8691 Engine Mounting - RHS Mercedes-Benz (W163) ML-Class (M111.977) ML230 SUV, (OM612.963) ML270 CDi SUV, (M112.942) ML320 SUV, (M113.942) ML430 SUV, (M113.964) ML500 SUV, (M113.981) ML55 AMG SUV (98-06)
	AR8681 Front Strut Mounting Mercedes-Benz (W204) C-Class (M271.910, M271.952) C180K, (M271.950) C200K, (OM651.911) C220 CDi, (M272.947) C300, (OM642.960) C350 CDi, (M272.961) C350 (07-14)		AR8692 Engine Mounting - LHS Mercedes-Benz (W163) ML-Class (M111.977) ML230 SUV, (OM612.963) ML270 CDi SUV, (M112.942) ML320 SUV, (M113.942) ML430 SUV, (M113.964) ML500 SUV, (M113.981) ML55 AMG SUV (98-06)
	AR8682 Rear Strut Mounting Mercedes-Benz (W204) C-Class (M271.910, M271.952) C180K, (M271.950) C200K, (OM651.911) C220 CDi, (M272.947) C300, (OM642.960) C350 CDi, (M272.961) C350 (07-14), (W212) E-Class (M274.920) E200, (M274.920) E250, (M271.860) E250, CGi, (M276.980) E350, (M276.820) E400, (M278.922) E500 (2011-)		AR8693 Engine Mounting - Rear Mercedes-Benz (W163) ML-Class (M111.977) ML230 SUV, (OM612.963) ML270 CDi SUV, (M112.942) ML320 SUV, (M113.942) ML430 SUV, (M113.964) ML500 SUV, (M113.981) ML55 AMG SUV (98-06)
	AR8683 Engine Mounting - L/RHS Mercedes-Benz (W204) C-Class (M271.910, M271.952) C180K, (M271.950) C200K, (OM651.911) C220 CDi, (M272.947) C300, (OM642.960) C350 CDi, (M272.961) C350 (07-14), (W212) E-Class (M271.820) E200 CGi, (OM651.924) E250 CDi, (M272.952) E300, (OM642.850) E350 CDi (2009-), (M273.971) E500 (06-12), (W212) E-Class (M271.860) E250, CGi, (M278.922) E500 (2011-)		AR8694 Front Lower Control Arm Bush - Inner Front Jeep Grand Cherokee IV 4X4 (ERB) 3.6 V6, (EZH) 5.7 V8 (2011-); Mercedes-Benz (W163) ML-Class (OM642.940) ML320 CDi SUV, (M272.967) ML350 SUV, (M273.963) ML500 SUV, (M156.980) ML63 AMG SUV (2006-)
	AR8684 Transmission Mounting Mercedes-Benz (W204) C-Class (M271.910, M271.952) C180K, (M271.950) C200K, (OM651.911) C220 CDi, (M272.947) C300, (OM642.960) C350 CDi, (M272.961) C350 (07-14), (W212) E-Class (M271.820) E200 CGi, (OM651.924) E250 CDi, (M272.952) E300, (OM642.850) E350 CDi (2009-), (M273.971) E500 (06-12), (W212) E-Class (M271.860) E250, CGi, (M276.980) E350, (M276.820) E400, (M278.922) E500 (2011-)		AR8695 Rear Lower Control Arm Bush - Inner Mercedes-Benz (W163) ML-Class (OM642.940) ML320 CDi SUV, (M272.967) ML350 SUV, (M273.963) ML500 SUV, (M156.980) ML63 AMG SUV (2006-)
	AR8685 Front Upper Control Arm Bush - Inner Rear Mercedes-Benz (W212) E-Class (M271.820) E200 CGi, (OM651.924) E250 CDi, (M272.952) E300, (OM642.850) E350 CDi (2009-), (M273.971) E500 (06-12), (W212) E-Class (M274.920) E200, (M274.920) E250, (M271.860) E250, CGi, (M276.980) E350, (M276.820) E400, (M278.922) E500 (2011-)		AR8696 Engine Mounting - L/RHS Mercedes-Benz (W163) ML-Class (OM642.940) ML320 CDi SUV, (M272.967) ML350 SUV, (M273.963) ML500 SUV, (M156.980) ML63 AMG SUV (2006-)
	AR8686 Rear Lower Control Arm Bush - Inner Mercedes-Benz (W212) E-Class (M271.820) E200 CGi, (OM651.924) E250 CDi, (M272.952) E300, (OM642.850) E350 CDi (2009-), (M273.971) E500 (06-12)		AR8697 Transmission Mounting Mercedes-Benz (W163) ML-Class (OM642.940) ML320 CDi SUV, (M272.967) ML350 SUV, (M273.963) ML500 SUV, (M156.980) ML63 AMG SUV (2006-)
	AR8687 Front Strut Mounting Mercedes-Benz (W212) E-Class (M271.820) E200 CGi, (OM651.924) E250 CDi, (M272.952) E300, (OM642.850) E350 CDi (2009-), (M273.971) E500 (06-12), (W212) E-Class (M274.920) E200, (M274.920) E250, (M271.860) E250, CGi, (M276.980) E350, (M276.820) E400, (M278.922) E500 (2011-)		AR8698 Transmission Mounting Chrysler Voyager 2.4 SE, 3.3 SE (97-04)
	AR8688 Front Strut Mounting Mercedes-Benz (W639) Vito 113 CDi, (OM646.980/982) 115 CDi, (OM651.940) 116 CDi, 120 CDi, (OM642.890) 122 CDi (2004-)		AR8699 Engine Mounting - Front Chrysler Voyager 2.4 SE, 3.3 SE (97-04)
	AR8700 Front Stabilizer Bar Bush Peugeot 1007 (TU5JP4) 1.6 3 Dr. Hatch (05-08)		AR8701 Engine Mounting - Front Peugeot 1007 (TU5JP4) 1.6 3 Dr. Hatch (05-08)

ENGINE MOUNTING & RUBBER BUYERS GUIDE

351

	AR8703 Front Upper Control Arm Bush - Inner Front & Outer Rear Hyundai Sonata (NF) 2.4 GLS (05-10), Sonata (YF) (G4KC) 2.4 GDi (10-15)
	AR8704 Front Lower Control Arm Bush - Inner Front Hyundai Sonata (NF) 2.4 GLS (05-10)
	AR8705 Front Lower Control Arm Bush - Outer Rear Hyundai Sonata (NF) 2.4 GLS (05-10)
	AR8706 Front Lower Control Arm Bush - Outer Hyundai Sonata (NF) 2.4 GLS (05-10)
	AR8707 Front Stabilizer Bar Bush Kia Picanto (G4HG) 1.1 LX, EX Std. (04-11), (G3LA) 1.0, (G4LA) 1.2 (2011-)
	AR8708 Front Strut Mounting Hyundai i10 (G4HG) 1.1 GLS, (G4LA) 1.2 GLS, GLS HS (2008-), i20 (G4LA) 1.2 Fluid, Motion, (G4FA) 1.4 Fluid, Glide, (D4FC) 1.4 CRDi Glide, (G4FC) 1.6 GLS (2009-); Kia Picanto (G4HG) 1.1 LX, EX Std. (04-11), (G3LA) 1.0, (G4LA) 1.2 (2011-), Rio III (G4LA) 1.2, (G4FA) 1.4 (2011-)
	AR8709 Front Lower Control Arm Bush - Inner Front Mitsubishi Pajero 4X4 3.2 Di-D, Di-D GLS, GLX, TDi GLS SUV, (6G75) 3.8 X-Treme, GLS SUV DOCH (02-07)
	AR8710 Front Lower Control Arm Bush - Outer Rear Mitsubishi Pajero 4X4 3.2 Di-D, Di-D GLS, GLX, TDi GLS SUV, (6G75) 3.8 X-Treme, GLS SUV DOCH (02-07)
	AR8711 Front Upper Control Arm Bush - Inner & Outer Mitsubishi Pajero 4X4 3.2 Di-D, Di-D GLS, GLX, TDi GLS SUV, (6G75) 3.8 X-Treme, GLS SUV DOCH (02-07)
	AR8712 Rear Stabilizer Link Assy. Mitsubishi Pajero 4X4 3.2 Di-D, Di-D GLS, GLX, TDi GLS SUV, (6G75) 3.8 X-Treme, GLS SUV DOCH (02-07)
	AR8713 Engine Mounting - RHS BMW Mini Cooper S (R55) (N14B16A, N18B16A) 1.6 Clubman, (R56) (N14B16A, N18B16A) 1.6 Hatch, (R57) (N14B16A, N18B16A) 1.6 Convertible, (R58) (N18B16A) 1.6 Coupe, (R59) (N18B16A) 1.6 Roadster, (R60) (N18B16A) 1.6 Countryman, (R61) (N18B16A) 1.6 Paceman (2007-), Cooper S 4X4 (R60) (N18B16A) 1.6 Countryman, (R61) (N18B16A) 1.6 Paceman (2007-), Cooper S 4X4 (R60) (N18B16A) 1.6 Countryman, (R61) (N18B16A) 1.6 Paceman (2010-), Cooper John (R55) (N14B16C) 1.6 Clubman, (R56) (N14B16C, N18B16C) 1.6 Hatch, (R57) (N14B16C, N18B16C) 1.6 Convertible, (R58) (N14B16C, N18B16C) 1.6 Coupe, (R59) (N14B16C, N18B16C) 1.6 Roadster (2007-), Countryman JCW (R56) (N18B16C) 1.6 Hatch, (R60) (N18B16A) 1.6 Countryman (2007-), One (R56) (N16B16A) 1.6 Hatch, (R57) (N16B16A) 1.6 Convertible (2007-)

	AR8714 Engine Mounting - Rear BMW Mini Cooper (R55) (N12B16A, N16B16A) 1.6 Clubman, (R56) (N12B16A, N16B16A) 1.6 Hatch, (R57) (N12B16A, N16B16A) 1.6 Convertible, (R58) (N16B16A) 1.6 Coupe, (R59) (N16B16A) 1.6 Roadster, (R60) (N16B16A) 1.6 Countryman, (R61) (N16B16A) 1.6 Paceman (2007-), Cooper S (R55) (N14B16A, N18B16A) 1.6 Clubman, (R56) (N14B16A, N18B16A) 1.6 Hatch, (R57) (N14B16A, N18B16A) 1.6 Convertible, (R58) (N18B16A) 1.6 Coupe, (R59) (N18B16A) 1.6 Roadster, (R60) (N18B16A) 1.6 Countryman, (R61) (N18B16A) 1.6 Paceman (2007-), Cooper S 4X4 (R60) (N18B16A) 1.6 Countryman, (R61) (N18B16A) 1.6 Paceman (2010-), Cooper John (R55) (N14B16C) 1.6 Clubman, (R56) (N14B16C, N18B16C) 1.6 Hatch, (R57) (N14B16C, N18B16C) 1.6 Convertible, (R58) (N14B16C, N18B16C) 1.6 Coupe, (R59) (N14B16C, N18B16C) 1.6 Roadster (2007-), Countryman JCW (R56) (N18B16C) 1.6 Hatch, (R60) (N18B16A) 1.6 Countryman (2007-), One (R56) (N16B16A) 1.6 Hatch, (R57) (N16B16A) 1.6 Convertible (2007-)
	AR8715 Engine Mounting - RHS BMW Mini Cooper (R55) (N12B16A, N16B16A) 1.6 Clubman, (R56) (N12B16A, N16B16A) 1.6 Hatch, (R57) (N12B16A, N16B16A) 1.6 Convertible, (R58) (N16B16A) 1.6 Coupe, (R59) (N16B16A) 1.6 Roadster, (R60) (N16B16A) 1.6 Countryman, (R61) (N16B16A) 1.6 Paceman (2007-)
	AR8716 Transmission Mounting BMW Mini Cooper (R55) (N12B16A, N16B16A) 1.6 Clubman, (R56) (N12B16A, N16B16A) 1.6 Hatch, (R57) (N12B16A, N16B16A) 1.6 Convertible, (R58) (N16B16A) 1.6 Coupe, (R59) (N16B16A) 1.6 Roadster, (R60) (N16B16A) 1.6 Countryman, (R61) (N16B16A) 1.6 Paceman (2007-), Cooper S (R55) (N14B16A, N18B16A) 1.6 Clubman, (R56) (N14B16A, N18B16A) 1.6 Hatch, (R57) (N14B16A, N18B16A) 1.6 Convertible, (R58) (N18B16A) 1.6 Coupe, (R59) (N18B16A) 1.6 Roadster, (R60) (N18B16A) 1.6 Countryman, (R61) (N18B16A) 1.6 Paceman (2007-), Cooper S 4X4 (R60) (N18B16A) 1.6 Countryman, (R61) (N18B16A) 1.6 Paceman (2010-), Cooper John (R55) (N14B16C) 1.6 Clubman, (R56) (N14B16C, N18B16C) 1.6 Hatch, (R57) (N14B16C, N18B16C) 1.6 Convertible, (R58) (N14B16C, N18B16C) 1.6 Coupe, (R59) (N14B16C, N18B16C) 1.6 Roadster (2007-), Countryman JCW (R56) (N18B16C) 1.6 Hatch, (R60) (N18B16A) 1.6 Countryman (2007-), One (R56) (N16B16A) 1.6 Hatch, (R57) (N16B16A) 1.6 Convertible (2007-) - Auto. Models
	AR8717 Transmission Mounting BMW Mini Cooper (R55) (N12B16A) 1.6 Clubman, (R56) (N12B16A) 1.6 Hatch, (R57) (N12B16A) 1.6 Convertible (2007-)
	AR8718 Front Strut Mounting BMW Mini Cooper (R55) (N12B16A, N16B16A) 1.6 Clubman, (R56) (N12B16A, N16B16A) 1.6 Hatch, (R57) (N12B16A, N16B16A) 1.6 Convertible, (R58) (N16B16A) 1.6 Coupe, (R59) (N16B16A) 1.6 Roadster, (R60) (N16B16A) 1.6 Countryman, (R61) (N16B16A) 1.6 Paceman (2007-), Cooper S (R55) (N14B16A, N18B16A) 1.6 Clubman, (R56) (N14B16A, N18B16A) 1.6 Hatch, (R57) (N14B16A, N18B16A) 1.6 Convertible, (R58) (N18B16A) 1.6 Coupe, (R59) (N18B16A) 1.6 Roadster, (R60) (N18B16A) 1.6 Countryman, (R61) (N18B16A) 1.6 Paceman (2007-), Cooper S 4X4 (R60) (N18B16A) 1.6 Countryman, (R61) (N18B16A) 1.6 Paceman (2010-), Cooper John (R55) (N14B16C) 1.6 Clubman, (R56) (N14B16C, N18B16C) 1.6 Hatch, (R57) (N14B16C, N18B16C) 1.6 Convertible, (R58) (N14B16C, N18B16C) 1.6 Coupe, (R59) (N14B16C, N18B16C) 1.6 Roadster (2007-), Countryman JCW (R56) (N18B16C) 1.6 Hatch, (R60) (N18B16A) 1.6 Countryman (2007-), One (R56) (N16B16A) 1.6 Hatch, (R57) (N16B16A) 1.6 Convertible (2007-)
	AR8719 Engine Mounting - RHS Ford KA (A9A/B) 1.3i Low, LX, Ambiente, Trend, Collection (05-09)

ENGINE MOUNTING & RUBBER BUYERS GUIDE

	AR8720 Engine Mounting - Rear Ford KA (A9A/B) 1.3i Low, LX, Ambiente, Trend, Collection (05-09)		AR8732 Engine Mounting - RHS Audi A4 (8E2/5, B6) 1.8T, (AVF, AWX) 1.9 TDi, Avant (00-08)
	AR8721 Transmission Mounting Ford KA (A9A/B) 1.3i Low, LX, Ambiente, Trend, Collection (05-09)		AR8734 Front Lower Control Arm Bush - Inner Front Audi A4 / A5 (CAPA, CCWA, CDUC, CKVB) 3.0 TDi Quattro, S-Tronic, Tiptronic, A4 (CALA) 3.2 FSi Quattro S-Tronic, A5 (CMUA) 3.0 TFSi Quattro S-Tronic, (CALA) 3.2 FSi Quattro S-Tronic (08-14), A6 (CGLC, CMGM) 2.0 TDi 8-Spd. Diesel Auto., (CDNB) 2.0 FSi 8-Spd. Petrol Auto. (11-15)
	AR8722 Engine Mounting - RHS Chevrolet Captiva 4X2, 4X4 (Z24SED) 2.4 LT (07-11)		AR8735 Engine Mounting - L/RHS Audi A4 (CABA/B, CDHA/B, CJEB) 1.8 TFSi Auto. (08-14), (CAEB, CDNC, CGLC, CMGB) 2.0 TFSi, Quattro, Multitronic, Quattro Auto. (08-14), A4 / A5 (CAPA, CCWA, CDUC, CKVB) 3.0 TDi Quattro, S-Tronic, Tiptronic Auto., A4 (CALA) 3.2 FSi Quattro S-Tronic Auto., A5 (CMUA) 3.0 TFSi Quattro S-Tronic Auto., (CALA) 3.2 FSi Quattro S-Tronic Auto. (08-14)
	AR8723 Engine Mounting - Front Chevrolet Captiva 4X2, 4X4 (Z24SED) 2.4 LT (07-11)		AR8736 Engine Mounting - RHS Audi A4 (CABA/B, CDHA/B, CJEB) 1.8 TFSi Man. (08-14), (CAEB, CDNC, CGLC, CMGB) 2.0 TFSi, Quattro Man., 2.0 TFSi Multitronic, Quattro Man. (08-14)
	AR8724 Transmission Mounting Chevrolet Captiva 4X2, 4X4 (Z20S) 2.0D LTZ Man., (Z24SED) 2.4 LT Man., (10HM) 3.2 LTZ Man. (07-11)		AR8737 Engine Mounting - LHS Audi A4 (CAEB, CDNC, CGLC, CMGB) 2.0 TFSi Man., Quattro, Multitronic, Quattro (08-14)
	AR8726 Transmission Mounting Ford Ranger 2.5D TD XL D/cab, XLT, SubCab, XLT Hi Trail, Super Cab XLT LWB P/up Dies. Auto., 3.0 TDCi D/cab XLE, SubCab XLT, Hi Trail, Super Cab XLT LWB P/up Dies. Auto. (07-12); Mazda B-Series B2600i LWB D/cab, Drifter SLX P/up Pet. Auto. (86-02), BT-50 4X4 2.5 TDi SLX D/cab P/up, 2.6 SLE D/cab, S/cab, P/up, (WLE7) 3.0 CRDi D/cab, SLE S/cab, CRDi SLX P/up Auto. (07-12), Drifter 1.8 SWB, LWB XL P/up Pet. Auto., 2.2 SWB, LWB XL Auto., (WL4) 2.5TD LWB Hi Ride, S/cab, SL Hi Ride, SLE, SLX, D/cab, LX Hi Ride, P/up Dies. Auto., 2.6i LWB SL Hi Ride S/cab, SLE D/C, SLX, Hi Ride, SLX Hi Ride D/cab Auto. (01-05)		AR8738 Engine Mounting - LHS Audi A5 2.0 TFSi, 3.2 FSi (2008-)
	AR8727 Transmission Mounting Ford Ranger 4X4 2.5D TD XL D/cab, XLT, SubCab, XLT Hi Trail, Super Cab XLT LWB P/up Dies. Auto., 3.0 TDCi D/cab XLE, SubCab XLT, Hi Trail, Super Cab XLT LWB P/up Dies. Auto. (07-12); Mazda B-Series 4X4 B2500D (WL4) TD LWB, D/cab, Magnum, Drifter SLX P/up Dies. Auto., B2600i V6 LWB Drifter, D/cab Drifter, SLX P/up Pet. Auto. (96-07)		AR8739 Front Strut Mounting Audi A4 (CABA/B, CDHA/B, CJEB) 1.8 TFSi, (BRD, CAGA, CJCA, CMEA, CMFA) 2.0 TDi, (CABE, CDNC, CGLC, CMGB) 2.0 TFSi, (CDNC, CPMA) 2.0 TFSi Quattro (08-14), (CAEB, CDNC, CGLC, CMGB) 2.0 TFSi, Quattro, 2.0 TFSi Multitronic, Quattro (08-14), A4 / A5 (CAPA, CCWA, CDUC, CKVB) 3.0 TDi Quattro, S-Tronic, Tiptronic, A4 (CALA) 3.2 FSi Quattro S-Tronic, A5 (CMUA) 3.0 TFSi Quattro S-Tronic, (CALA) 3.2 FSi Quattro S-Tronic (08-14)
	AR8728 Transmission Mounting Ford Everest 4X2, 4X4 3.0 TDCi (09-15), Ranger 4X4 2.5D TD XL D/cab, XLT, SubCab, XLT Hi Trail, Super Cab XLT LWB P/up Dies. Man., 3.0 TDCi D/cab XLE, SubCab XLT, Hi Trail, Super Cab XLT LWB P/up Dies. Man. (07-12); Mazda B-Series 4X4 B2500D (WL4) TD LWB, D/cab, Magnum, Drifter SLX P/up Dies. Man., B2600i V6 LWB Drifter, D/cab Drifter, SLX P/up Pet. (96-07)		AR8743 Engine Mounting - RHS Chevrolet Optra (F16D3) 1.6, (T18SED) 1.8 (04-11)
	AR8729 Engine Mounting - RHS Audi A4 (8E2/5, B6) (ALT) 2.0 Executive (BGB) 2.0 TFSi, (BLB) 2.0 TDi (00-08)		AR8744 Engine Mounting - RHS Torque Rod Chevrolet Optra (F16D3) 1.6, (T18SED) 1.8 (04-11)
	AR8730 Engine Mounting - Front Audi A4 (8E2/5, B6) (AVF, AWX) 1.9 TDi Avant (00-08)		AR8745 Engine Mounting - Rear Lower Torque Rod Chevrolet Optra (T18SED) 1.8 (04-11)
	AR8731 Transmission Mounting Audi A4 (8E2/5, B6) (AVF, AWX) 1.9 TDi Avant (00-08)		AR8746 Transmission Mounting Chevrolet Optra (F16D3) 1.6, (T18SED) 1.8 (04-11)
	AR8747 Engine Mounting - Front Fiat Stilo (182B6000) 1.6 Actual, Active, Multi Wagon, Active, (192A1000, 937A7.000) 1.9 JTD Dynamic, Actual, Multi Wagon JTD Dynamic (03-07)		

ENGINE MOUNTING & RUBBER BUYERS GUIDE

353

	AR8748 Engine Mounting - Rear Fiat Stilo (182B6000) 1.6 Actual, Active, Multi Wagon, Active, (192A1000, 937A7.000) 1.9 JTD Dynamic, Actual, Multi Wagon JTD Dynamic (03-07)		AR8763 Front Lower Control Arm Bush - Outer Rear Citroen C4 Aircross (9HD-DV6C) 1.6 HDi 115, (4B11) 2.0 (2010-); Dodge Caliber (EBA) 1.8, (ECN) 2.0, (ECE) 2.0 CRD, (ED3) 2.4 (06-12); Jeep Compass 4X4 (ECD, ECE) 2.0 CRD, (ECN) 2.0, (ED3, ER2) 2.4 CRD (07-09); Patriot (MK74) 4X4 (ECD, ECE) 2.0 CRD, (ED3) 2.4 (2007-); Mitsubishi ASX (4B11) 2.0 (2011-); Lancer (4A91) 1.5, (4G18) 1.6 (03-10), Outlander 4X4 (4B12) 2.4 (07-14)
	AR8749 Engine Mounting - Rear Fiat Stilo (182B6000) 1.6 Actual, Active, Multi Wagon, Active, (192A1000, 937A7.000) 1.9 JTD Dynamic, Actual, Multi Wagon JTD Dynamic (03-07)		AR8764 Front Stabilizer Bar Bush Mitsubishi Lancer (4A91) 1.5, (4G18) 1.6 (03-10)
	AR8750 Front Stabilizer Bar Bush Ford Fiesta III (M1JE) 1.0 Ecoboost, Titanium, Trend, 1.4i Ambiente, Trend, Titanium, 1.6i Ambiente, Trend, Sport, Titanium, TDCi (2008-); Mazda 2 (DE) (ZJ-VE) 1.3, (ZY-DE/VE) 1.5 (07-15)		AR8765 Front Lower Control Arm Bush - Inner Front Citroen C4 Aircross (9HD-DV6C) 1.6 HDi 115, (4B11) 2.0 (2010-); Dodge Caliber (EBA) 1.8, (ECN) 2.0, (ECE) 2.0 CRD, (ED3) 2.4 (06-12); Jeep Compass 4X4 (ECD, ECE) 2.0 CRD, (ECN) 2.0, (ED3, ER2) 2.4 CRD (07-09); Patriot (MK74) 4X4 (ECD, ECE) 2.0 CRD, (ED3) 2.4 (2007-); Mitsubishi ASX (4B11) 2.0 (2011-); Lancer (4A91) 1.5, (4G18) 1.6 (03-10), Outlander 4X4 (4B12) 2.4 (07-14)
	AR8751 Front Lower Control Arm Bush - Inner Front Ford Fiesta III (M1JE) 1.0 Ecoboost, Titanium, Trend, 1.4i Ambiente, Trend, Titanium, 1.6i Ambiente, Trend, Sport, Titanium, TDCi (2008-); Mazda 2 (DE) (ZJ-VE) 1.3, (ZY-DE/VE) 1.5 (09-15)		AR8767 Engine Mounting - Rear Support Nissan NP200 (K9K) 1.5dCi (2008-); Renault Clio III (K4J) 1.4 16V 72kw Man. Hatch (06-12), Grand Scenic II (K4M) 1.6 16V 83kw Man. MPV (04-09), Kangoo II (K7M) 1.6 8V 64kw Man. MPV, (K4M) 1.6 16V 78kw Man. MPV (2011-), Megane II (K4M) 1.6 16V 83kw Man. Hatch, Sedan (03-09), Modus (K4J) 1.4 72kw Man. Hatch (2005-), Scenic II (K4M) 1.6 16V 83kw Man. MPV (04-09), Grand Scenic II (K4M) 1.6 16V Man. MPV (04-09)
	AR8753 Front Strut Mounting Ford Ecosport (M1JC) 1.0i Ecoboost, (UGJE) 1.5 TDCi, (UEJB) 1.5i (2013-), Fiesta III (M1JE) 1.0 Man. Ecoboost, Titanium, Trend, 1.4i Man. Ambiente, Trend, Titanium, 1.6i Man. Ambiente, Trend, Sport, Titanium, TDCi (2008-); Mazda 2 (DE) (ZJ-VE) 1.3, (ZY-DE/VE) 1.5 (07-15), 2 (DL) (ZJ-VE) 1.3, (ZY-DE/VE) 1.5 (2015-), CX-3 (PEX3) 2.0 (2015-), CX-5 (GH, KE) (PEY4) 2.0 (12-15)		AR8768 Engine Mounting - RHS Nissan NP200 (K4M) 1.6 16V (2008-)
	AR8754 Front Strut Mounting Ford Fiesta III (M1JE) 1.0 Auto. Ecoboost, Titanium, Trend, 1.4i Auto. Ambiente, Trend, Titanium, 1.6i Auto. Ambiente, Trend, Sport, Titanium, TDCi (2008-)		AR8769 Engine Mounting - RHS Nissan NP200 (K9K) 1.5dCi SWB S, SE P/up Dies. (2008-); Renault Duster 4X2, 4X4 (K9K884/858) 1.5dCi, (K4M616) 1.6 (2013-)
	AR8756 Rear Axle Beam Bush Ford Fiesta III (M1JE) 1.0 Ecoboost, Titanium, Trend, 1.4i Ambiente, Trend, Titanium, 1.6i Ambiente, Trend, Sport, Titanium, TDCi (2008-)		AR8774 Front Stabilizer Link Assy. Peugeot Boxer (DJ5TED) 2.5TD 1.8 Ton Delivery Van Dies. (02-06), (P22DTE) 2.2 HDi "120" 4HU, (P22DTE) 2.2 HDi "130" 4HH, (F1CE0481D, F30DT) 3.0 HDi "130" (2007-)
	AR8757 Engine Mounting - Rear Ford Ecosport (M1JC) 1.0i Ecoboost, (UGJE) 1.5 TDCi, (UEJB) 1.5i (2013-), Fiesta II (Zetec) 1.4i Trend, (Rocam, Zetec) 1.6i Ambiente, Ghia, Trend, 2.0i ST150, ST (04-09), Fiesta III (M1JE) 1.0 Ecoboost, Titanium, Trend, 1.4i Ambiente, Trend, Titanium, 1.6i, TDCi, Ambiente, Trend, Sport, Titanium (2008-), Figgo 1.4 TDCi Ambiente, (FXJA, FXJB) 1.4i Ambiente, Trend (10-16), Ikon 1.4. 1.4 TDCi. 1.6, i (07-11)		AR8778 Front Lower Control Arm Bush - Outer Rear Hyundai Getz (G4EA) 1.3, (G4EE) 1.4i HS, (D3EA) 1.5 CRDi, HS, (G4ED-G) 1.6, HS (03-12)
	AR8758 Engine Mounting - RHS Ford Fiesta III (M1JE) 1.0 Auto. Ecoboost, Titanium, Trend, 1.4i Auto. Ambiente, Trend, Titanium, 1.6i Auto. Ambiente, Trend, Sport, Titanium, TDCi (2008-)		AR8779 Transmission Mounting Chevrolet Corsa 1.4 AC, Club, Sport, 1.7 DTi, Club, Sport, 1.8 Club, Sport (2010-), Utility 1.3D AC, Club, Sport, 1.4 AC, Club, Sport, 1.8 AC, Club, Sport (2010-), Corsa C (14NE) 140i Classic Comfort, Chill, Club, Sport, Lite, Lite+, S, Lite Sport, Sedan, Hatch, (16SE) 1.6i Elegance, Sport, Classic, Elegance Sedan, Hatch, (X17D) 1.7i DTi Hatch, Classic Elegance Sedan, Hatch Dies., 1.8i Hatch GSi, Classic Executive Sedan, Hatch (03-08), Corsa LDV II (14XE) 1.4i Utility S, Sport, Club, P/up Pet., (Y17DT) 1.7D Utility, Sport, Club DTi P/up Dies., (Z18XEL) 1.8i Utility, Sport, Club, P/up (02-10), Corsa Combo P/van (Z14XEP) 1.4i Pet. (05-12)
	AR8759 Engine Mounting - RHS Ford Fiesta III (M1JE) 1.0 Ecoboost, Titanium, Trend, 1.4i Ambiente, Trend, Titanium, 1.6i Ambiente, Trend, Sport, Titanium, TDCi (2008-)		AR8780 Shackle Bush - Front Ford Ranger T6 4X2, 4X4 (GBVAJQJ) 2.2D HP Double Cab, (GBVAJPF) 2.2 TD MP Single Cab, (GBVAF, AK, AL) 2.5, 3.2D Wildtrack, (SAFA) 3.2 TDCi (2012-); Mazda BT-50 4X2, 4X4 (MZ-CD, P4-AT) 2.2, (MZI L5-Y3) 2.5, (MZ-CD, P5-Y3) 3.2 (2012-)
	AR8760 Transmission Mounting Ford Fiesta III (M1JE) 1.0 Ecoboost, Titanium, Trend, 1.4i Ambiente, Trend, Titanium, 1.6i Ambiente, Trend, Sport, Titanium, TDCi (2008-)		
	AR8761 Engine Mounting - RHS Citroen C4 (DV6TED4) 1.6 HDi (05-10); Peugeot 307 (TU5JP4) 1.6 Estate, XR, XS HDi, XT, (EW10J4) 2.0 CC 100, CC,130, XS, Man., (DW10TD) XS HDi (01-07)		

ENGINE MOUNTING & RUBBER BUYERS GUIDE

	AR8781 Shackle Bush - Rear Upper Ford Ranger T6 4X2, 4X4 (GBVAJQJ) 2.2D HP Double Cab, (GBVAJPF) 2.2 TD MP Single Cab, (GBVAF, AK, AL) 2.5, 3.2D Wildtrack, (SAFA) 3.2 TDCi (2012-); Mazda BT-50 4X2, 4X4 (MZ-CD, P4-AT) 2.2, (MZI L5-Y3) 2.5, (MZ-CD, P5-Y3) 3.2 (2012-)		AR8795 Front Lower Control Arm Bush - Outer Mahindra Scorpio 4X2, 4X4 2.0, 2.2 CRED, 2.5, GLX, 2.6, GLX, 2.6TD GLX (2003-)
	AR8782 Shackle Bush - Rear Lower Ford Ranger T6 4X2, 4X4 (GBVAJQJ) 2.2D HP Double Cab, (GBVAJPF) 2.2 TD MP Single Cab, (GBVAF, AK, AL) 2.5, 3.2D Wildtrack, (SAFA) 3.2 TDCi (2012-); Mazda BT-50 4X2, 4X4 (MZ-CD, P4-AT) 2.2, (MZI L5-Y3) 2.5, (MZ-CD, P5-Y3) 3.2 (2012-)		AR8796 Front Stabilizer Bar Bush Mahindra Scorpio 4X2, 4X4 2.0, 2.2 CRED, 2.5, GLX, 2.6, GLX, 2.6TD GLX (2003-)
	AR8783 Shackle Bush - Front Mitsubishi Triton 4X2, 4X4 2.4 MPi D/cab P/up, 2.5 Di-D Clubcab P/up, 3.2 Di-D D/cab P/up, 3.5 MPi Clubcab P/up (2007-)		AR8797 Engine Mounting - Front TATA Indica / Vista 1.4 LEi, LSi, LX, LXi, 1.4 TDi DLX, DL (2005-), Indigo 1.4 GLX, GLS, GSX S/W, 1.4 TDi DLX S/W (2005-)
	AR8784 Rear Spring Front Eye Bush Volkswagen Amarok 4X2, 4X4 (CDCA) 2.0 BiTDi, (CDBA, CNFA) 2.0 TDi, (CFPA) 2.0 TSi, (CNEA, CSHA) 2.0 BiTDi, (CNFB) 2.0 TDi (10-16)		AR8798 Front Lower Control Arm Bush - Outer Rear Toyota Hilux "VIGO" 4X2 (1TR-FE) 2.0i LWB S/cab, S, SRX, P/up Pet. Standard Body, 4X2, 4X4 (2KD-FTV) 2.5 TDi LWB D-4D S/cab, S, SRX, HO Raised Body, D/C Raider P/up Dies. (05-11), Hilux 4X2 (1TR-FE) 2.0 VVTi 5-Spd. Man., S/cab Std. Body, (2KD-FTV) 2.5D-4D 5-Spd. Man. Std. Body (11-16), Hilux "REVO" 4X2 (1TR-FE) 2.0 VVT-i, (2GD-FTV) 2.4 GD Std. Body (2016-)
	AR8785 Shackle Bush - Rear Lower Volkswagen Amarok 4X2, 4X4 (CDCA) 2.0 BiTDi, (CDBA, CNFA) 2.0 TDi, (CFPA) 2.0 TSi, (CNEA, CSHA) 2.0 BiTDi, (CNFB) 2.0 TDi (10-16)		AR8799 Front Lower Control Arm Bush - Inner Rear Toyota Hilux "VIGO" 4X2 (1TR-FE) 2.0i LWB S/cab, S, SRX, P/up Pet. Standard Body, 4X2, 4X4 (2KD-FTV) 2.5 TDi LWB D-4D S/cab, S, SRX, HO Raised Body, D/C Raider P/up Dies. (05-11), Hilux 4X2 (1TR-FE) 2.0 VVTi 5-Spd. Man., S/cab Std. Body, (2KD-FTV) 2.5D-4D 5-Spd. Man. Std. Body (11-16), Hilux "REVO" 4X2 (1TR-FE) 2.0 VVT-i, (2GD-FTV) 2.4 GD Std. Body (2016-)
	AR8786 Shackle Bush - Rear Upper Volkswagen Amarok 4X2, 4X4 (CDCA) 2.0 BiTDi, (CDBA, CNFA) 2.0 TDi, (CFPA) 2.0 TSi, (CNEA, CSHA) 2.0 BiTDi, (CNFB) 2.0 TDi (10-16)		AR8800 Front & Rear Stabilizer Bar Bush TATA Indica / Vista 1.4 LEi, LSi, LX, LXi, 1.4 TDi DLX, DL (2005-), Indigo 1.4 GLX, GLS, GSX S/W, 1.4 TDi DLX S/W (2005-), Safari 4X2 2.2 CRDi GLS, GLX Dies. (2007-), Telcoline (DLTC) 2.0TD, LWB D/C P/up 483 Dies. (04-10)
	AR8788 Front Upper Control Arm Bush - Inner Mahindra Bolero 4X2, 4X4 Maxi Truck (XD3, NEF) 2.5D, 2.5TD (2005-)		AR8801 Rear Lower Control Arm Bush - Inner TATA Indica / Vista 1.4 LEi, LSi, LX, LXi, 1.4 TDi DLX, DL (2005-), Indigo 1.4 GLX, GLS, GSX S/W, 1.4 TDi DLX S/W (2005-)
	AR8789 Front Lower Control Arm Bush - Inner Mahindra Bolero 4X2, 4X4 Maxi Truck (XD3, NEF) 2.5D, 2.5TD (2005-)		AR8802 Rear Lower Control Arm Bush - Outer TATA Indica / Vista 1.4 LEi, LSi, LX, LXi, 1.4 TDi DLX, DL (2005-), Indigo 1.4 GLX, GLS, GSX S/W, 1.4 TDi DLX S/W (2005-)
	AR8790 Front Strut Bar Bush Mahindra Bolero 4X2, 4X4 Maxi Truck (XD3, NEF) 2.5D, 2.5TD (2005-)		AR8805 Engine Mounting - RHS Chevrolet Spark, Spark Lite (M200, M250) (F8CV) 0.8 L, LS, (B10S1) 1.0 LS, LT (2005-)
	AR8791 Front Stabilizer Bar Bush Mahindra Bolero 4X2, 4X4 Maxi Truck (XD3, NEF) 2.5D, 2.5TD (2005-)		
	AR8792 Front Stabilizer Link Grommet Mahindra Bolero 4X2, 4X4 Maxi Truck (XD3, NEF) 2.5D, 2.5TD (2005-), Scorpio 4X2, 4X4 2.0, 2.2 CRED, 2.5, GLX, 2.6, GLX, 2.6TD GLX (2003-)		
	AR8793 Front Upper Control Arm Bush - Inner Mahindra Scorpio 4X2, 4X4 2.0, 2.2 CRED, 2.5, GLX, 2.6, GLX, 2.6TD GLX (2003-)		

ENGINE MOUNTING & RUBBER BUYERS GUIDE

355













 <p>ID: 16.3, OD: 43, L: 64.8</p>	<p>AR8806 Front Lower Control Arm Bush - Inner Front</p> <p>Toyota Auris (4ZZ-FE) 1.4 RT, RS, (1ZR-FE) 1.6 RT, XI, XS, Sport X, XR, (2ZR-FAE) 1.8 RS, RX, (1AD-FTV) 2.0 D-4D RS, RX, Turbo, XD (07-13), (1NR-FE) 1.3, (1ZR-FAE) 1.6, 1.6 TRD, 1.8 HSD (2010-), Corolla (1NR-FE) 1.3 Advanced, Impact, Professional, 6-Spd. Man., (1ZR-FE) 1.6 Advanced, Professional, Sprinter, 6-Spd. Man., 4-Spd. Auto., (2ZR-FE) 1.8 Advanced, Exclusive, 6-Spd. Man., 4-Spd. Auto., (3ZR-FE) 2.0 Sprinter, Exclusive, 6-Spd. Man./Auto., (1AD-FTV) 2.0D-4D Advanced, Exclusive 6-Spd. Man. (2007-), Corolla (E180) (1NR-FE) 1.3 Esteem, Prestige, (1ND-TV) 1.4D-4D Esteem, Prestige, (1ZR-FE) 1.6 Esteem, Prestige, (2ZR-FE) 1.8 16V Exclusive, Prestige (14-19), Corolla Quest (1ZR-FE) 1.6 (2014-), Corolla Verso (3ZZ-FE) 1.6S, SX, TX MPV 5/6-Spd. Man., (1ZZ-FE) 1.8 SX, TX MPV 5/6-Spd. Man. (04-09), (1CD-FTV) 2.0D-4D TX MPV, 6-Spd. Man. (04-09), Verso (1ZR-FAE) 1.6, (2ZR-FAE) 1.8, (1AD-FTV) 2.0D-4D (09-14), RAV4 III (ACE, ALA) 4X4 (1AZ-FE) 2.0 GX, VX, Fierce SUV Pet., 5-Spd. Man., 4-Spd. Auto., (2AD-FTV) 2.2D-4D GX, VX Dies. 5-Spd. Man. (06-13), RAV4 IV 4X2 (3ZR-FE) 2.0, GX, (2AR-FE) 2.5 VX AWD, RAV4 IV 4X4 (2AD-FHV, 2AD-FTV) 2.2D (2013-)</p>	 <p>ID: 45</p>	<p>AR8814 Centre Bearing Rubber</p> <p>Nissan Navara (D40) 4X2, 4X4 (YD25DDTi) 2.5dCi LWB D/cab LE, SE, XE P/up Dies., (V9X) 3.0dCi V6 LWB D/cab, P/up Dies., (VQ40DE) 4.0i V6 LWB LE D/cab P/up Pet. (2005-), Pathfinder (R51) 4X4 (YD25DDTi) 2.5dCi LWB D/cab LE, SUV Dies., (V9X) 3.0dCi V6 LWB D/cab SUV Dies., (VQ40DE) 4.0i V6 LWB LE D/cab SUV Pet. (05-15)</p>
 <p>ID: 16, OD: 68, L: 60</p>	<p>AR8807 Front Lower Control Arm Bush - Outer Rear</p> <p>Toyota Auris (4ZZ-FE) 1.4 RT, RS, (1ZR-FE) 1.6 RT, XI, XS, Sport X, XR, (2ZR-FAE) 1.8 RS, RX, (1AD-FTV) 2.0 D-4D RS, RX, Turbo, XD (07-13), (1NR-FE) 1.3, (1ZR-FAE) 1.6, 1.6 TRD, 1.8 HSD (2010-), Corolla (1NR-FE) 1.3 Advanced, Impact, Professional, 6-Spd. Man., (1ZR-FE) 1.6 Advanced, Professional, Sprinter, 6-Spd. Man., 4-Spd. Auto., (2ZR-FE) 1.8 Advanced, Exclusive, 6-Spd. Man., 4-Spd. Auto., (3ZR-FE) 2.0 Sprinter, Exclusive, 6-Spd. Man./Auto., (1AD-FTV) 2.0D-4D Advanced, Exclusive 6-Spd. Man. (2007-), Corolla (E180) (1NR-FE) 1.3 Esteem, Prestige, (1ND-TV) 1.4D-4D Esteem, Prestige, (1ZR-FE) 1.6 Esteem, Prestige, (2ZR-FE) 1.8 16V Exclusive, Prestige (14-19), Corolla Quest (1ZR-FE) 1.6 (2014-), Corolla Verso (3ZZ-FE) 1.6S, SX, TX MPV 5/6-Spd. Man., (1ZZ-FE) 1.8 SX, TX MPV 5/6-Spd. Man. (04-09), (1CD-FTV) 2.0D-4D TX MPV, 6-Spd. Man. (04-09), Verso (1ZR-FAE) 1.6, (2ZR-FAE) 1.8, (1AD-FTV) 2.0D-4D (09-14), RAV4 III (ACE, ALA) 4X4 (1AZ-FE) 2.0 GX, VX, Fierce SUV Pet., 5-Spd. Man., 4-Spd. Auto., (2AD-FTV) 2.2D-4D GX, VX Dies. 5-Spd. Man. (06-13), RAV4 IV 4X2 (3ZR-FE) 2.0, GX, (2AR-FE) 2.5 VX AWD, RAV4 IV 4X4 (2AD-FHV, 2AD-FTV) 2.2D (2013-)</p>	 <p>ID: 12.5, OD: 38, L: 55</p>	<p>AR8816 Front Lower Control Arm Bush - Inner Front</p> <p>Hyundai iX35 4X2, 4X4 (G4KD/D4HA) 2.0 CRDi, 2.4 (G4KE) (2010-), Sonata (YF) (G4KC) 2.4 GDi (10-15); Kia Optima (G4KJ) 2.4 (12-14), Sportage 4X2, 4X4 (G4NC) 2.0, (D4HA) 2.0 CRDi (2010-)</p>
 <p>ID: 12.5, OD: 41, L: 66</p>	<p>AR8808 Front Upper Control Arm Bush - Inner Front & Outer Rear</p> <p>Toyota Hilux "VIGO" 4X2 (1TR-FE) 2.0i LWB S/cab, S, SRX, P/up Pet. Standard Body, Hilux "VIGO" 4X2, 4X4 (2KD-FTV) 2.5 TDi LWB D-4D S/cab, S, SRX, D/C Raider P/up Dies. (05-11) - Standard Body Models, Hilux 4X2 (1TR-FE) 2.0 VVT-i 5-Spd. Man., S/cab Std. Body, (2KD-FTV) 2.5D-4D 5-Spd. Man. Std. Body (11-16), Hilux "REVO" 4X2 (1TR-FE) 2.0 VVT-i, (2GD-FTV) 2.4 GD Std. Body (2016-)</p>	 <p>ID: 14.5, OD: 70, L: 60</p>	<p>AR8817 Front Lower Control Arm Bush - Outer Rear</p> <p>Hyundai i30 (G4GG) 1.6 GLS, Premium, (G4NB-B) 1.8 GLS, Executive (2012-), iX35 4X2, 4X4 (G4KD/D4HA) 2.0 CRDi, 2.4 (G4KE) (2010-), Sonata (YF) (G4KC) 2.4 GDi (10-15); Kia Cerato (YD) (G4FC) 1.6, (G4FJ) 1.6T-GDi, (G4NA) 2.0 (2013-), Optima (G4KJ) 2.4 (12-14), Sportage 4X2, 4X4 (G4NC) 2.0, (D4HA) 2.0 CRDi (2010-)</p>
	<p>AR8809 Engine Mounting - RHS</p> <p>Peugeot 307 (TU5JP4) 1.6 Estate, XR, XS HDi, XT, (EW10J4) 2.0 CC 100, CC,130, XS, Man., (DW10TD) XS HDi (01-07)</p>		<p>AR8818 Front Strut Mounting</p> <p>Hyundai iX35 4X2, 4X4 (G4KD/D4HA) 2.0 CRDi, 2.4 (G4KE) (2010-), Tucson (G4GC) 2.0 GLS (04-11); Kia Sportage 4X2, 4X4 (G4NC) 2.0, (D4HA) 2.0 CRDi (2010-)</p>
	<p>AR8810 Transmission Mounting</p> <p>Nissan Navara (D40) 4X2, 4X4 (YD25DDTi) 2.5dCi Man. LWB D/cab LE, SE, XE P/up Dies. (2005-), Pathfinder (R51) 4X4 (YD25DDTi) 2.5dCi LWB D/cab LE, SUV Dies. (05-15)</p>		<p>AR8819 Shackle Bush - Front</p> <p>Volkswagen Crafter (BJK, BJM) 2.5TDi 50 HR-Series LWB, XLWB P/van (2007-)</p>
	<p>AR8811 Engine Mounting - L/RHS</p> <p>Nissan Navara (D40) 4X2, 4X4 (YD25DDTi) 2.5dCi Man. LWB D/cab LE, SE, XE P/up Dies. (2005-), Pathfinder (R51) 4X4 (YD25DDTi) 2.5dCi LWB D/cab LE, SUV Dies., (V9X) 3.0dCi V6 LWB D/cab SUV Dies. (05-15)</p>		<p>AR8820 Rear Strut Mounting</p> <p>Hyundai iX35 4X2, 4X4 (G4KD/D4HA) 2.0 CRDi, 2.4 (G4KE) (2010-); Kia Sportage 4X2, 4X4 (G4NC) 2.0, (D4HA) 2.0 CRDi (2010-)</p>
	<p>AR8812 Engine Mounting - LHS</p> <p>Chevrolet Sonic (LSF) 1.3D Auto., (A14XER) 1.4 Auto., (F16D4) 1.6 Auto. (11-16)</p>		<p>AR8821 Rear Stabilizer Bar Bush</p> <p>Hyundai iX35 4X2, 4X4 (G4KD/D4HA) 2.0 CRDi, 2.4 (G4KE) (2010-); Kia Sportage 4X2, 4X4 (G4NC) 2.0, (D4HA) 2.0 CRDi (2010-)</p>
 <p>ID: 14.3, OD: 42, L: 50</p>	<p>AR8822 Front Lower Control Arm Bush - Inner Front</p> <p>Nissan Murano (Z50) 4X4 (VQ35DE) 3.5i V6, X-Tronic SUV (05-10)</p>	 <p>ID: 24</p>	<p>AR8823 Front Lower Control Arm Bush - Outer Rear</p> <p>Nissan Murano (Z50) 4X4 (VQ35DE) 3.5i V6, X-Tronic SUV (05-10)</p>

ENGINE MOUNTING & RUBBER BUYERS GUIDE

	AR8824 Engine Mounting - Rear Honda CR-V II 4X4 (K20A4) 2.0i Auto. SWB SUV (05-09)		AR8836 Engine Mounting - Front Chevrolet Captiva 4X2, 4X4 (Z20S) 2.0D LTZ (07-11); Hyundai Getz (G4EA) 1.3, (G4EE) 1.4i HS, (D3EA) 1.5 CRDi, HS, (G4ED-G) 1.6, HS (03-12)
	AR8825 Engine Mounting - Front Honda Civic (K20Z4) 2.0i Auto. VTEC Type-R (2006-), CR-V II 4X4 (K20A4) 2.0i Auto. SWB SUV (05-09)		AR8837 Rear Stabilizer Bar Bush Chevrolet Captiva 4X2, 4X4 (Z20S) 2.0D LTZ, (Z24SED) 2.4 LT, (10HM) 3.2 LTZ (07-11), 2.2D LTZ 5-dr Dsl. AWD AT, (LNQ) 2.2D LT 5-dr Dsl. AT, (LE5) 2.4 LT, LS 5-dr, 3.0 LTZ 5-dr AWD AT (11-17)
	AR8826 Engine Mounting - RHS Ford Focus II (QQDB, Q7DA) 1.8, (AODA, AODB, AODE) 2.0 (05-12), Focus III (PNDA) 1.6i, (MGDA) 2.0 TDCi, GDi, GTDi, (R9DA) ST1, ST3 (11-15); Mazda 3 (BK, BL) (LF17) 2.0 Dynamic, Individual, (L3KG) 2.3 Individual MPS (04-14), 5 (CR19) (LFF7) 2.0 Original, Active, Dynamic, Individual (07-10), 5 (CW) (LFZB) 2.0 (10-14); Volvo C30 (B4164S3) 1.6 Pet., (B4184S11) 1.8, (B4204S3) 2.0i (07-13), S40 (B4184S11) 1.8i, (B4204S3) 2.0, (D5204T) 2.0 D4, (D4204T) 2.0D (04-12)		AR8838 Transmission Mounting Nissan Navara (D40) 4X2, 4X4 (YD25DDTi) 2.5dCi Auto. LWB D/cab LE, SE, XE P/up Dies. (2005-)
	AR8827 Front & Rear Stabilizer Bar Bush Audi Q7 (BAR) 4.2 FSi Quattro (06-10); Volkswagen Touareg 4X4 (BAC, BPE) 2.5 R5 TDi, (BKS, CATA, CASA, CASC, CNRB) 3.0 V6 TDi, (AXQ) 4.2 V8, (AYH, BLE, BWF) 5.0 V10 TDi (04-11), (BHK, BHL) 3.6 FSi V6, (BAR) 4.2 V8 (07-11), (CASA, CNRB) 3.0 TDi V6, (CGRA) 3.6 FSi V6, (CKDA) 4.2 TDi V8 (2010-)		AR8839 Engine Mounting - Front Hyundai i10 (G4HG) 1.1 GLS, (G4LA) 1.2 GLS, GLS HS (2008-)
	AR8828 Front Lower Control Arm Bush - Inner Front Land Rover Discovery I 2.2 TD, 3.5, 3.9 (89-04), Discovery III 2.5 TD V6, 2.7 TD V6, 4.0 V6, 4.4 V8 (05-09)		AR8840 Engine Mounting - L/RHS Volkswagen Amarok 4X2, 4X4 (CDCA) 2.0 BITDi, (CDBA, CNFA) 2.0 TDi, (CFPA) 2.0 TSi, (CNEA, CSHA) 2.0 BITDi, (CNFB) 2.0 TDi (10-16)
	AR8830 Front Stabilizer Bar Bush Chevrolet Captiva 4X2, 4X4 (Z20S) 2.0D LTZ, (Z24SED) 2.4 LT, (10HM) 3.2 LTZ (07-11), 2.2D LTZ 5-dr Dsl. AWD AT, (LNQ) 2.2D LT 5-dr Dsl. AT, (LE5) 2.4 LT, LS 5-dr, 3.0 LTZ 5-dr AWD AT (11-17)		AR8841 Front Stabilizer Link Bush Kit Toyota Land Cruiser (FJ62) 4X4 (3F) 4.0, GX P/up Pet. 5-Spd. Man., 4-Spd. Auto., (2F) 4.2 P/up, GX Pet. 5-Spd. Man., 4-Spd. Auto. (87-90), (FZJ80) 4X4 (1FZ-FE, 1HD) 4.5 Std., GX P/up, GX, VX S/W 12V Dies. 5-Spd. Man., 4-Spd. Auto. (90-98), (FZJ100) 4X4 (2UZ-FE) 4.7 VX V8 Petrol 5-Spd. Man., 4-Spd. Auto. (98-03), (FZJ105) 4X4 (1FZ-FE) 4.2 Std., GX P/up Dies. Turbo 5-Spd. Man., 4-Spd. Auto. (98-06), (HDJ80) 4X4 (1FZ-FE, 1HD) 4.5 Std., GX P/up, GX, VX S/W 12V Dies. 5-Spd. Man., 4-Spd. Auto. (90-98), (HDJ100) 4X4 (2UZ-FE) 4.7 VX V8 Petrol 5-Spd. Man., 4-Spd. Auto. (98-03), (1FZ-FE) 4.5 GX, VX S/W Dies. 5-Spd. Man., 4-Spd. Auto. (98-06), (HZJ105) 4X4 (1HZ) 4.2 GX P/up Dies. Turbo 5-Spd. Man., Auto. (98-06), (UZJ100) 4X4 (2UZ-FE) 4.7 VX V8 Petrol 5-Spd. Man., 4-Spd. Auto. (98-03)
	AR8831 Front Lower Control Arm Bush - Inner Front Chevrolet Captiva 4X2, 4X4 (Z20S) 2.0D LTZ, (Z24SED) 2.4 LT, (10HM) 3.2 LTZ (07-11), 2.2D LTZ 5-dr Dsl. AWD AT, (LNQ) 2.2D LT 5-dr Dsl. AT, (LE5) 2.4 LT, LS 5-dr, 3.0 LTZ 5-dr AWD AT (11-17)		AR8842 Front Stabilizer Link Bush Kit Toyota Land Cruiser 76-Series 4X4 (1HZ) 4.2D P/up, S/W Dies. 5-Spd. Man. (2009-), 77-Series 4X4 (1HZ) 4.2D P/up, S/W Dies. 5-Spd. Man. (2009-), 79-Series 4X4 (1GR-FE) 4.0 P/up Pet. 5-Spd. Man., (1HZ) 4.2D P/up, S/W Dies. 5-Spd. Man. (2009-)
	AR8832 Front Lower Control Arm Bush - Outer Rear Chevrolet Captiva 4X2, 4X4 (Z20S) 2.0D LTZ, (Z24SED) 2.4 LT, (10HM) 3.2 LTZ (07-11), 2.2D LTZ 5-dr Dsl. AWD AT, (LNQ) 2.2D LT 5-dr Dsl. AT, (LE5) 2.4 LT, LS 5-dr, 3.0 LTZ 5-dr AWD AT (11-17)		AR8843 Engine Mounting - LHS Chrysler Neon (EDJ) 1.6 SE, 2.0 LX, RT (00-06)
	AR8832I Front Lower Control Arm Bush - Outer Rear (Insert Only) Chevrolet Captiva 4X2, 4X4 (Z20S) 2.0D LTZ, (Z24SED) 2.4 LT, (10HM) 3.2 LTZ (07-11), 2.2D LTZ 5-dr Dsl. AWD AT, (LNQ) 2.2D LT 5-dr Dsl. AT, (LE5) 2.4 LT, LS 5-dr, 3.0 LTZ 5-dr AWD AT (11-17)		AR8845 Front Strut Mounting Chevrolet Cruze (F16D3) 1.6 L, LS, (F18D4) 1.8 LS, (Z20S1) 2.0D (09-12), Orlando (F18D4) 1.8 (2011-); Opel Astra J (A14NET, B14NET) 1.4T, (A16LET) 1.6T, (A20NFT, B20NFT) 2.0 OPC (2010-), Mokka (A14NET, B14NET) 1.4T (15-16)
	AR8833 Rear Axle Diff. Bush Centre Chevrolet Captiva 4X2, 4X4 (Z20S) 2.0D LTZ, (Z24SED) 2.4 LT, (10HM) 3.2 LTZ (07-11), 2.2D LTZ 5-dr Dsl. AWD AT, (LNQ) 2.2D LT 5-dr Dsl. AT, (LE5) 2.4 LT, LS 5-dr, 3.0 LTZ 5-dr AWD AT (11-17)		AR8846 Rear Strut Mounting Chevrolet Cruze (F16D3) 1.6 L, LS, (F18D4) 1.8 LS, (Z20S1) 2.0D (09-12), Orlando (F18D4) 1.8 (2011-)
	AR8834 Front Strut Mounting Chevrolet Captiva 4X2, 4X4 (Z20S) 2.0D LTZ, (Z24SED) 2.4 LT, (10HM) 3.2 LTZ (07-11), 2.2D LTZ 5-dr Dsl. AWD AT, (LNQ) 2.2D LT 5-dr Dsl. AT, (LE5) 2.4 LT, LS 5-dr, 3.0 LTZ 5-dr AWD AT (11-17); Kia Optima (G4KJ) 2.4 (12-14)		AR8847 Rear Axle Beam Bush Chevrolet Cruze (F16D3) 1.6 L, LS, (F18D4) 1.8 LS, (Z20S1) 2.0D (09-12), Orlando (F18D4) 1.8 (2011-)
	AR8835 Engine Mounting - RHS Chevrolet Captiva 4X2, 4X4 (Z20S) 2.0D LTZ (07-11)		

ENGINE MOUNTING & RUBBER BUYERS GUIDE

357

 ID: 33, L: 54, H: 64, W: 78	AR8848 Front Stabilizer Bar Bush Jeep Grand Cherokee 4X4 (EXL) 3.0 CRD, (EKG) 3.7 V6, (EVA) 4.7 V8, (EZB) 5.7 V8 (05-13)
	AR8849 Centre Bearing Rubber BMW 3-Series (E46) 318i (M43) 1.8, (M43) 2.0 Touring SW, (N42) 2.0, 318ti (M47B) 2.0 Compact, 320d (M47D) 2.0 (98-05), 328i (M52TU) 2.8 Coupe, 330Ci (M54) 3.0 Convertible, 330d (M57) 3.0 Dies., 330i (M54) 3.0 (99-05)
	AR8850 Engine Mounting - RHS Front Chrysler Neon (EDJ) 1.6 SE, 2.0 LX, RT (00-06)
	AR8851 Engine Mounting - RHS Middle Chrysler Neon (EDJ) 1.6 SE, 2.0 LX, RT (00-06)
 NO PICTURE AVAILABLE AT TIME OF PRINT	AR8852 Engine Mounting - RHS Rear Chrysler Neon (EDJ) 1.6 SE, 2.0 LX, RT (00-06)
	AR8853 Front Lower Control Arm Bush - Outer Rear Chrysler Neon (EDJ) 1.6 SE, 2.0 LX, RT (00-06)
	AR8854 Front Lower Control Arm Bush - Inner Front Chrysler Neon (EDJ) 1.6 SE, 2.0 LX, RT (00-06)
	AR8855 Front Strut Mounting Chrysler Neon (EDJ) 1.6 SE, 2.0 LX, RT (00-06)
	AR8856 Rear Strut Mounting Chrysler Neon (EDJ) 1.6 SE, 2.0 LX, RT (00-06)
 NO PICTURE AVAILABLE AT TIME OF PRINT	AR8857 Transmission Mounting Toyota Hilux (LN192) (5L) 3.0D LWB D-E DLX, Raider D/cab Raised Body Dies., (KZ-TE) 3.0iD LWB D/cab Raider, Legend35 Raider, D/cab, Raider Dies. (98-05)
	AR8858 Transmission Mounting Toyota Fortuner 4X2, 4X4 (1GR-FE) 4.0 V6, Raised Body Pet. (06-11), Fortuner 4X4 (1GR-FE) 4.0 5-Spd. Auto. (11-16), Hilux "VIGO" 4X4 (1GR-FE) 4.0 V6 D/cab Raider Raised Body, Legend40 P/up Pet. (05-11), Hilux 4X2, 4X4 (1GR-FE) 4.0 (11-16)
	AR8859 Engine Mounting - LHS Honda Civic (D15Z4) 150i, (D17A5) 170i (00-06)
	AR8860 Engine Mounting - RHS Honda Civic (D15Z4) 150i, (D17A5) 170i (00-06)

	AR8861 Transmission Mounting Hyundai Atos (G4HC) 1.0 Prime, (G4HG) 1.1 GLS (00-07), (G4HC) 1.0 Prime, (G4HG) 1.1 GLS (07-13)
 ID: 8.2, L: 69	AR8862 Front Stabilizer Bar Link Hyundai Atos (G4HC) 1.0 Prime, (G4HG) 1.1 GLS (00-07), (G4HC) 1.0 Prime, (G4HG) 1.1 GLS (07-13)
	AR8863 Rear Axle Beam Bush Hyundai Getz (G4EA) 1.3, (G4EE) 1.4i HS, (D3EA) 1.5 CRDi, HS, (G4ED-G) 1.6, HS (03-12)
	AR8864 Engine Mounting - RHS Hyundai i10 (G4HG) 1.1 GLS, (G4LA) 1.2 GLS, GLS HS (2008-)
	AR8865 Transmission Mounting Hyundai i10 (G4HG) 1.1 GLS, (G4LA) 1.2 GLS, GLS HS (2008-)
	AR8866 Engine Mounting - Rear Hyundai Elantra (MD, UD) (G4FG) 1.6, (G4NB) 1.8 (2011-), i20 (G4LA) 1.2 Fluid, Motion, (G4FA) 1.4 Fluid, Glide, (D4FC) 1.4 CRDi Glide, (G4FC) 1.6 GLS (2009-), Veloster (G4FD, G4FJ) 1.6 GDi Man. (2013-); Kia Cerato (YD) (G4FC) 1.6, (G4FJ) 1.6T-GDi, (G4NA) 2.0 (2013-), Rio III (G4FA) 1.4 Man. (2011-)
	AR8867 Engine Mounting - LHS Hyundai i20 (G4LA) 1.2 Fluid, Motion (2009-)
	AR8868 Engine Mounting - RHS Hyundai i20 (G4LA) 1.2 Fluid, Motion, (G4FA) 1.4 Fluid, Glide, (D4FC) 1.4 CRDi Glide, (G4FC) 1.6 GLS (2009-); Kia Soul (G4FC) 1.6, (D4FB) 1.6 CRDi (09-11)
 ID: 12.1, OD: 34, L: 54	AR8869 Front Lower Control Arm Bush - Inner Front Hyundai Grand i10 (G3LAG) 1.0, (G4LA) 1.2 (2014-), i20 (G4LA) 1.2 Fluid, Motion, (G4FA) 1.4 Fluid, Glide, (D4FC) 1.4 CRDi Glide, (G4FC) 1.6 GLS (2009-); Kia Picanto (G3LA) 1.0, (G4LA) 1.2 (2011-), Rio III (G4LA) 1.2, (G4FA) 1.4 (2011-), Soul (G4FC) 1.6, (D4FB) 1.6 CRDi (2009-)
 ID: 14, OD: 66, L: 60	AR8870 Front Lower Control Arm Bush - Outer Rear Hyundai Grand i10 (G3LAG) 1.0, (G4LA) 1.2 (2014-), i20 (G4LA) 1.2 Fluid, Motion, (G4FA) 1.4 Fluid, Glide, (D4FC) 1.4 CRDi Glide, (G4FC) 1.6 GLS (2009-); Kia Picanto (G3LA) 1.0, (G4LA) 1.2 (2011-), Rio III (G4LA) 1.2, (G4FA) 1.4 (2011-), Soul (G4FC) 1.6, (D4FB) 1.6 CRDi (2009-)
	AR8871 Front Stabilizer Bar Bush Hyundai i20 (G4LA) 1.2 Fluid, Motion, (G4FA) 1.4 Fluid, Glide, (D4FC) 1.4 CRDi Glide, (G4FC) 1.6 GLS (2009-)
	AR8872 Front Strut Mounting Hyundai Accent (G4ED) 1.6 GLS, HS, (G4FC) 1.6 (2011-)

ENGINE MOUNTING & RUBBER

BUYERS GUIDE

	AR8873 Rear Axle Beam Bush Hyundai i20 (G4LA) 1.2 Fluid, Motion, (G4FA) 1.4 Fluid, Glide, (D4FC) 1.4 CRDi Glide, (G4FC) 1.6 GLS (2009-)		AR8886 Front Strut Mounting Toyota Etios (2NR-FE) 1.5 Xi, 1.5 Xs Cross (2012-)
	AR8874 Engine Mounting - Front Hyundai Elantra (HD) 1.6 GLS, (G4GC) 2.0 GLS (07-11), i30 (G4FG) 1.6, (G4GC-G) 2.0 (10-12); Kia Cerato (TD) (G4FC) 1.6 Man., (G4KD) 2.0 Man. (09-13)		AR8887 Centre Bearing Rubber Toyota Avanza 1.3 P/van, (K3-VE) 1.3 S, SX MPV, (3SZ-VE) 1.5 SX, TX MPV (06-12), (K3-VE) 1.3 S P/van, (K3-VE) 1.3 S, SX MPV, (3SZ-VE) 1.5 SX, TX MPV (12-16)
	AR8875 Engine Mounting - Rear Hyundai Elantra (HD) 1.6 GLS, (G4GC) 2.0 GLS (07-11), i30 (G4FG) 1.6, (G4GC-G) 2.0 (10-12)		AR8890 Transmission Mounting Honda CR-V II 4X4 (K20A4) 2.0i Auto. SWB SUV (05-09)
	AR8876 Engine Mounting - LHS Hyundai Elantra (HD) 1.6 GLS, (G4GC) 2.0 GLS (07-11), i30 (G4FG) 1.6, (G4GC-G) 2.0 (10-12)		AR8891 Centre Bearing Rubber Honda CR-V II 4X4 (K20A4) 2.0i SWB SUV, (N22A2) 2.2 CTDi SWB SUV, (N22B3) 2.2 i-DTEC, (K24Z1/4) 2.4i V-TEC SWB SUV (05-09)
	AR8877 Engine Mounting - RHS Hyundai Elantra (HD) 1.6 GLS, (G4GC) 2.0 GLS (07-11), i30 (G4FG) 1.6, (G4GC-G) 2.0 (10-12); Kia Cerato (TD) (G4FC) 1.6, (G4KD) 2.0 (09-13)		AR8893 Rear Upper Control Arm Bush - Inner Front & Rear Jeep Cherokee (KJ) 4X4 (EDI) 2.4, (R425) 2.5 CRD, (ENR) 2.8 CRD, (EKG) 3.7 CRD (02-08), Grand Cherokee (WG, WJ) 4X4 (ENF) 2.7 CRD, (EVA, EVC) 4.7 V8 (02-05), Grand Cherokee 4X4 (EXL) 3.0 CRD, (EKG) 3.7 V6, (EVA) 4.7 V8, (EZB) 5.7 V8 (05-13)
	AR8878 Rear Stabilizer Bar Bush Hyundai i30 (G4FG) 1.6, (G4GC-G) 2.0 (10-12), i30 (G4GG) 1.6 GLS, Premium, (G4NB-B) 1.8 GLS, Executive (2012-)		AR8894 Centre Bearing Rubber Hyundai iX35 4X2, 4X4 (G4KD/D4HA) 2.0 CRDi, 2.4 (G4KE) (2010-), Santa Fe' (D4EB, D4HB) 2.2 CRDi (06-13), Santa Fe' 4X4 (D4EB, D4HB) 2.2 CRDi, (G6EA) 2.7 GLS (06-13); Kia Sorento 4X2, 4X4 (D4HB) 2.2 CRDi, (G6DC) 3.5 (2009-), Sportage 4X2, 4X4 (G4NC) 2.0, (D4HA) 2.0 CRDi (2010-)
	AR8879 Rear Strut Mounting Hyundai i30 (G4FG) 1.6, (G4GC-G) 2.0 (10-12)		AR8895 Front Lower Control Arm Bush - Inner Front Nissan Juke 4X2, 4X4 (HRA2DDT) 1.2, (K9K) 1.5dCi, (HR16DE) 1.6, (MR16DDT) 1.6 DIG-T (2011-)
	AR8880 Engine Mounting - Rear Toyota Etios (2NR-FE) 1.5 Xi, 1.5 Xs Cross (2012-)		AR8896 Front Lower Control Arm Bush - Outer Rear Nissan Juke 4X2, 4X4 (HRA2DDT) 1.2, (K9K) 1.5dCi, (HR16DE) 1.6, (MR16DDT) 1.6 DIG-T (2011-)
	AR8881 Engine Mounting - RHS Toyota Etios (2NR-FE) 1.5 Xi, 1.5 Xs Cross (2012-)		AR8897 Centre Bearing Rubber Toyota Hilux "VIGO" 4X4 (2KD-FTV) 2.5 TDi LWB D-4D S/cab, S, SRX, HO Raised Body, D/C Raider P/up Dies., (2TR-FE) 2.7i LWB S/cab Raider, D/cab Raider, S/cab, HO Raised Body, Legend40, P/up Pet., (1KD-FTV) 3.0D-4D LWB Raider, D/cab Raider Raised Body, Legend40 P/up Dies., (1GR-FE) 4.0 V6 D/cab Raider Raised Body, Legend40 P/up Pet. (05-11)
	AR8882 Engine Mounting - LHS Toyota Etios (2NR-FE) 1.5 Xi, 1.5 Xs Cross (2012-)		AR8898 Front Stabilizer Bar Bush Nissan Juke 4X2, 4X4 (HRA2DDT) 1.2, (K9K) 1.5dCi, (HR16DE) 1.6, (MR16DDT) 1.6 DIG-T (2011-)
	AR8883 Front Lower Control Arm Bush - Inner Toyota Etios (2NR-FE) 1.5 Xi, 1.5 Xs Cross (2012-)		AR8899 Rear Strut Mounting Nissan Juke 4X2, 4X4 (HRA2DDT) 1.2, (K9K) 1.5dCi, (HR16DE) 1.6, (MR16DDT) 1.6 DIG-T (2011-)
	AR8884 Front Lower Control Arm Bush - Outer Toyota Etios (2NR-FE) 1.5 Xi, 1.5 Xs Cross (2012-)		AR8903 Engine Mounting - Rear Torque Rod Nissan Juke 4X2 (HRA2DDT) 1.2T 6-Spd. Man., (HR16DE) 1.6 5-Spd. Man. (2011-), 4X4 (MR16DDT) 1.6 DIG-T CVT (2013-), Sentra (HR16DE) 1.6 5-Spd. Man. (2013-)
	AR8885 Front Stabilizer Bar Bush Toyota Etios (2NR-FE) 1.5 Xi, 1.5 Xs Cross (2012-)		

ENGINE MOUNTING & RUBBER BUYERS GUIDE

359

	<p>AR8905 Rear Axle Beam Bush</p> <p>Audi A3 (CJZA, CCJZ) 1.2 TFSi, (CXSA) 1.4 TFSi, (CLHA) 1.6 TDi, (CJSA, CJSB) 1.8 TFSi, (DAGA) 2.0 TDi (12-17); Volkswagen Golf VII (CJZA) 1.2 TSi, (CMBA, CPVA, CXSA) 1.4 TSi, (CHPA, CPTA) 1.4 TSi, (CRVA, CYKB) 2.0 TDi, (CRBC, CRLB, CRMB, CRUA) 2.0 TDi (2013-)</p>		<p>AR8918 Front Stabilizer Link</p> <p>Volkswagen Amarok 4X2, 4X4 (CDCA) 2.0 BiTDi, (CDBA, CNFA) 2.0 TDi, (CFPA) 2.0 TSi, (CNEA, CSHA) 2.0 BiTDi, (CNFB) 2.0 TDi (10-16)</p> <p>ID: 12.4</p>
	<p>AR8906 Front Upper Control Arm Bush - Inner & Outer</p> <p>Volkswagen Amarok 4X2, 4X4 (CDCA) 2.0 BiTDi, (CDBA, CNFA) 2.0 TDi, (CFPA) 2.0 TSi, (CNEA, CSHA) 2.0 BiTDi, (CNFB) 2.0 TDi (10-16)</p> <p>ID: 10, OD: 40, L: 35/60</p>		<p>AR8919 Transmission Mounting</p> <p>Volkswagen Amarok 4X2, 4X4 (CDCA) 2.0 BiTDi Auto., (CDBA, CNFA) 2.0 TDi Auto., (CFPA) 2.0 TSi Auto., (CNEA, CSHA) 2.0 BiTDi Auto., (CNFB) 2.0 TDi Auto. (10-16)</p>
	<p>AR8907 Front Lower Control Arm Bush - Inner Front</p> <p>Volkswagen Amarok 4X2, 4X4 (CDCA) 2.0 BiTDi, (CDBA, CNFA) 2.0 TDi, (CFPA) 2.0 TSi, (CNEA, CSHA) 2.0 BiTDi, (CNFB) 2.0 TDi (10-16)</p> <p>ID: 14, OD: 40.5, L: 60</p>		<p>AR8920 Front Stabilizer Link - L/RHS</p> <p>Audi A1 (CHZB) 1.0, (CBZA) 1.2 TFSi, (CAVG, CAXA) 1.4 TFSi, (CAYC) 1.6 TDi Hatch 3-Dr, Sportback, (DAJB) 1.8 (11-18), A3 (AGN) 1.8, (AGU, BFU) 1.8T (98-04)</p> <p>NO PICTURE AVAILABLE AT TIME OF PRINT</p>
	<p>AR8909 Front Strut Mounting</p> <p>Audi A3 (CJZA, CCJZ) 1.2 TFSi, (CXSA) 1.4 TFSi, (CLHA) 1.6 TDi, (CJSA, CJSB) 1.8 TFSi, (DAGA) 2.0 TDi (12-17), (CZCA, CZEA) 1.4 TFSi, (CRFC) 2.0 TDi (13-17), S3 (CJXB) 2.0 TFSi (13-17); Volkswagen Golf VII (CJZA) 1.2 TSi, (CMBA, CPVA, CXSA) 1.4 TSi, (CHPA, CPTA) 1.4 TSi, (CRVA, CYKB) 2.0 TDi, (CRBC, CRLB, CRMB, CRUA) 2.0 TDi (2013-)</p>		<p>AR8921 Rear Axle Guide Beam Bush</p> <p>Audi A4 (CABA/B, CDHA/B, CJEB) 1.8 TFSi, (BRD, CAGA, CJCA, CMEA, CMFA) 2.0 TDi, (CABE, CDNC, CGLC, CMGB) 2.0 TFSi, (CDNC, CPMA) 2.0 TFSi Quattro (08-14), A4 / A5 (CAPA, CCWA, CDUC, CKVB) 3.0 TDi Quattro, S-Tronic, Tiptronic, A4 (CALA) 3.2 FSi Quattro S-Tronic, A5 (CMUA) 3.0 TFSi Quattro S-Tronic, (CALA) 3.2 FSi Quattro S-Tronic (08-14)</p> <p>NO PICTURE AVAILABLE AT TIME OF PRINT</p>
	<p>AR8910 Transmission Mounting</p> <p>Audi A3 (CZCA, CZEA) 1.4 TFSi, (CRFC) 2.0 TDi (2016-); Volkswagen Golf VII (CJZA) 1.2 TSi, (CMBA, CPVA, CXSA) 1.4 TSi, (CHPA, CPTA) 1.4 TSi (2013-)</p>		<p>AR8922 Upper Wishbone Bush</p> <p>Audi A4 / A5 (CAPA, CCWA, CDUC, CKVB) 3.0 TDi Quattro, S-Tronic, Tiptronic, A4 (CALA) 3.2 FSi Quattro S-Tronic, A5 (CMUA) 3.0 TFSi Quattro S-Tronic, (CALA) 3.2 FSi Quattro S-Tronic (08-14)</p> <p>NO PICTURE AVAILABLE AT TIME OF PRINT</p>
	<p>AR8911 Engine Mounting - RHS</p> <p>Audi A3 (CLHA) 1.6 TDi (12-17), (CZCA, CZEA) 1.4 TFSi (13-17), S3 (CJXB) 2.0 TFSi (13-17); Volkswagen Golf VII (CJZA) 1.2 TSi, (CMBA, CPVA, CXSA) 1.4 TSi, (CHPA, CPTA) 1.4 TSi (2013-)</p>		<p>AR8923 Rear Axle Beam Bush - Front</p> <p>Audi A4 (CABA/B, CDHA/B, CJEB) 1.8 TFSi, (BRD, CAGA, CJCA, CMEA, CMFA) 2.0 TDi, (CABE, CDNC, CGLC, CMGB) 2.0 TFSi, (CDNC, CPMA) 2.0 TFSi Quattro (08-14), A4 / A5 (CAPA, CCWA, CDUC, CKVB) 3.0 TDi Quattro, S-Tronic, Tiptronic, A4 (CALA) 3.2 FSi Quattro S-Tronic, A5 (CMUA) 3.0 TFSi Quattro S-Tronic, (CALA) 3.2 FSi Quattro S-Tronic (08-14), A6 (CGLC, CMGM) 2.0 TDi 8-Spd. Diesel Auto., (CDNB) 2.0 FSi 8-Spd. Petrol Auto. (11-15)</p> <p>NO PICTURE AVAILABLE AT TIME OF PRINT</p>
	<p>AR8912 Engine Mounting - Rear</p> <p>Audi A3 (CZCA, CZEA) 1.4 TFSi Man. (13-17); Volkswagen Golf VII (CJZA) 1.2 TSi, (CMBA, CPVA, CXSA) 1.4 TSi, (CHPA, CPTA) 1.4 TSi (2013-)</p>		<p>AR8924 Rear Axle Beam Bush - Rear</p> <p>Audi A4 (CABA/B, CDHA/B, CJEB) 1.8 TFSi, (BRD, CAGA, CJCA, CMEA, CMFA) 2.0 TDi, (CABE, CDNC, CGLC, CMGB) 2.0 TFSi, (CDNC, CPMA) 2.0 TFSi Quattro (08-14), A4 / A5 (CAPA, CCWA, CDUC, CKVB) 3.0 TDi Quattro, S-Tronic, Tiptronic, A4 (CALA) 3.2 FSi Quattro S-Tronic, A5 (CMUA) 3.0 TFSi Quattro S-Tronic, (CALA) 3.2 FSi Quattro S-Tronic (08-14), A6 (CGLC, CMGM) 2.0 TDi 8-Spd. Diesel Auto., (CDNB) 2.0 FSi 8-Spd. Petrol Auto. (11-15)</p> <p>NO PICTURE AVAILABLE AT TIME OF PRINT</p>
	<p>AR8913 Centre Bearing Rubber</p> <p>Hyundai Tucson (G4GC) 2.0 GLS (04-11), Tucson 4X4 (D4EA) 2.0 CRDi, (G6BA-G) 2.7 V6 (04-10); Kia Sportage 4X2, 4X4 (G4GC) 2.0 SWB SUV, (D4EA) 2.0 CRDi SUV, (G6BA) 2.7 V6 SUV (05-10)</p>		<p>AR8925 Front Lower Control Arm Bush - Outer Front & Rear</p> <p>Audi A4 / A5 (CAPA, CCWA, CDUC, CKVB) 3.0 TDi Quattro, S-Tronic, Tiptronic, A4 (CALA) 3.2 FSi Quattro S-Tronic, A5 (CMUA) 3.0 TFSi Quattro S-Tronic, (CALA) 3.2 FSi Quattro S-Tronic (08-14), A6 (BDX, CCEA) 2.8 FSi 7-Spd. Auto. (07-09), (BPJ) 2.0 TFSi 7-Spd. Auto. Pet., (BPP, CANA) 2.7 TDi 7-Spd. Auto., (CCEA) 2.8 FSi 7-Spd. Auto. (09-11), A6 (CGLC, CMGM) 2.0 TDi 8-Spd. Diesel Auto., (CDNB) 2.0 FSi 8-Spd. Petrol Auto. (11-15)</p>
	<p>AR8914 Propshaft Coupling</p> <p>Hyundai Tucson (G4GC) 2.0 GLS (04-11), Tucson 4X4 (D4EA) 2.0 CRDi, (G6BA-G) 2.7 V6 (04-10); Kia Sportage 4X2, 4X4 (G4GC) 2.0 SWB SUV, (D4EA) 2.0 CRDi SUV, (G6BA) 2.7 V6 SUV (05-10)</p>		<p>AR8926 Front Stabilizer Link - L/RHS</p> <p>Audi A4 (CABA/B, CDHA/B, CJEB) 1.8 TFSi, (BRD, CAGA, CJCA, CMEA, CMFA) 2.0 TDi, (CABE, CDNC, CGLC, CMGB) 2.0 TFSi, (CDNC, CPMA) 2.0 TFSi Quattro (08-14), A4 / A5 (CAPA, CCWA, CDUC, CKVB) 3.0 TDi Quattro, S-Tronic, Tiptronic, A4 (CALA) 3.2 FSi Quattro S-Tronic, A5 (CMUA) 3.0 TFSi Quattro S-Tronic, (CALA) 3.2 FSi Quattro S-Tronic (08-14), A6 (CGLC, CMGM) 2.0 TDi 8-Spd. Diesel Auto., (CDNB) 2.0 FSi 8-Spd. Petrol Auto. (11-15)</p>
	<p>AR8915 Front Lower Control Arm Bush - Outer Rear</p> <p>Volkswagen Amarok 4X2, 4X4 (CDCA) 2.0 BiTDi, (CDBA, CNFA) 2.0 TDi, (CFPA) 2.0 TSi, (CNEA, CSHA) 2.0 BiTDi, (CNFB) 2.0 TDi (10-16)</p> <p>ID: 14.3, OD: 60.4, L: 64</p>		<p>AR8927 Rear Stabilizer Link - L/RHS</p> <p>Audi A4 / A5 (CAPA, CCWA, CDUC, CKVB) 3.0 TDi Quattro, S-Tronic, Tiptronic, A4 (CALA) 3.2 FSi Quattro S-Tronic, A5 (CMUA) 3.0 TFSi Quattro S-Tronic, (CALA) 3.2 FSi Quattro S-Tronic (08-14)</p> <p>NO PICTURE AVAILABLE AT TIME OF PRINT</p>
	<p>AR8916 Front Lower Control Arm Bush - Outer Centre</p> <p>Volkswagen Amarok 4X2, 4X4 (CDCA) 2.0 BiTDi, (CDBA, CNFA) 2.0 TDi, (CFPA) 2.0 TSi, (CNEA, CSHA) 2.0 BiTDi, (CNFB) 2.0 TDi (10-16)</p> <p>ID: 14, OD: 46, L: 84</p>		
	<p>AR8917 Front Stabilizer Bar Bush</p> <p>Volkswagen Amarok 4X2, 4X4 (CDCA) 2.0 BiTDi, (CDBA, CNFA) 2.0 TDi, (CFPA) 2.0 TSi, (CNEA, CSHA) 2.0 BiTDi, (CNFB) 2.0 TDi (10-16)</p> <p>NO PICTURE AVAILABLE AT TIME OF PRINT</p>		

ENGINE MOUNTING & RUBBER BUYERS GUIDE

 NO PICTURE AVAILABLE AT TIME OF PRINT	AR8928 Transmission Mounting Audi A4 (CABA/B, CDHA/B, CJEB) 1.8 TFSi, (BRD, CAGA, CJCA, CMEA, CMFA) 2.0 TDi, (CABE, CDNC, CGLC, CMGB) 2.0 TFSi, (CDNC, CPMA) 2.0 TFSi Quattro (08-14), A4 / A5 (CAPA, CCWA, CDUC, CKVB) 3.0 TDi Quattro, S-Tronic, Tiptronic, A4 (CALA) 3.2 FSi Quattro S-Tronic, A5 (CMUA) 3.0 TFSi Quattro S-Tronic, (CALA) 3.2 FSi Quattro S-Tronic (08-14)
 NO PICTURE AVAILABLE AT TIME OF PRINT	AR8931 Engine Mounting - RHS Nissan NV350 (F9Q760) 2.5 Impendulo 16-Seater Taxi (2014-)
 NO PICTURE AVAILABLE AT TIME OF PRINT	AR8932 Engine Mounting - LHS Nissan NV350 (F9Q760) 2.5 Impendulo 16-Seater Taxi (2014-)
	AR8933 Transmission Mounting Nissan NV350 (F9Q760) 2.5 Impendulo 16-Seater Taxi (2014-)
 NO PICTURE AVAILABLE AT TIME OF PRINT	AR8934 Engine Mounting - Rear Nissan NV350 (F9Q760) 2.5 Impendulo 16-Seater Taxi (2014-)
 ID: 18, OD: 35.5, L: 53	AR8935 Shackle Bush - Rear Upper Nissan NV200 (M20) (K9K) 1.5dCi, (HR16DE) 1.6 (2013-), NV350 (F9Q760) 2.5 Impendulo 16-Seater Taxi (2014-)
 NO PICTURE AVAILABLE AT TIME OF PRINT	AR8936 Shackle Bush - Rear Lower Nissan NV200 (M20) (K9K) 1.5dCi, (HR16DE) 1.6 (2013-), NV350 (F9Q760) 2.5 Impendulo 16-Seater Taxi (2014-)
 ID: 12, OD: 40, L: 60/80	AR8937 Shackle Bush - Front Nissan NV200 (M20) (K9K) 1.5dCi, (HR16DE) 1.6 (2013-), NV350 (F9Q760) 2.5 Impendulo 16-Seater Taxi (2014-)
 NO PICTURE AVAILABLE AT TIME OF PRINT	AR8938 Steering Rack Mounting Nissan NV350 (F9Q760) 2.5 Impendulo 16-Seater Taxi (2014-)
	AR8939 Front Stabilizer Bar Bush Nissan NV350 (F9Q760) 2.5 Impendulo 16-Seater Taxi (2014-)
	AR8941 Front Lower Control Arm Bush - Inner Front Nissan NV350 (F9Q760) 2.5 Impendulo 16-Seater Taxi (2014-)
	AR8942 Front Lower Control Arm Bush - Outer Rear Nissan NV350 (F9Q760) 2.5 Impendulo 16-Seater Taxi (2014-)

	AR8948 Front Axle Beam Bush Audi A6 (BDX, CCEA) 2.8 FSi 7-Spd. Auto. (07-09), (BPJ) 2.0 TFSi 7-Spd. Auto. Pet., (BPP, CANA) 2.7 TDi 7-Spd. Auto., (CCEA) 2.8 FSi 7-Spd. Auto. (09-11)
	AR8949 Rear Axle Beam Bush Audi A6 (BDX, CCEA) 2.8 FSi 7-Spd. Auto. (07-09), (BPJ) 2.0 TFSi 7-Spd. Auto. Pet., (BPP, CANA) 2.7 TDi 7-Spd. Auto., (CCEA) 2.8 FSi 7-Spd. Auto. (09-11)
	AR8950 Front Subframe Bush - Front Audi A6 (BDX, CCEA) 2.8 FSi 7-Spd. Auto. (07-09), (BPJ) 2.0 TFSi 7-Spd. Auto. Pet., (BPP, CANA) 2.7 TDi 7-Spd. Auto., (CCEA) 2.8 FSi 7-Spd. Auto. (09-11)
	AR8951 Front Subframe Bush - Rear Audi A6 (BDX, CCEA) 2.8 FSi 7-Spd. Auto. (07-09), (BPJ) 2.0 TFSi 7-Spd. Auto. Pet., (BPP, CANA) 2.7 TDi 7-Spd. Auto., (CCEA) 2.8 FSi 7-Spd. Auto. (09-11)
	AR8952 Front Strut Mounting Audi A6 (BDX, CCEA) 2.8 FSi 7-Spd. Auto. (07-09), (BPJ) 2.0 TFSi 7-Spd. Auto. Pet., (BPP, CANA) 2.7 TDi 7-Spd. Auto., (CCEA) 2.8 FSi 7-Spd. Auto. (09-11)
	AR8953 Engine Mounting - Rear Audi A6 (BPJ) 2.0 TFSi 7-Spd. Auto. Pet. (09-11)
 NO PICTURE AVAILABLE AT TIME OF PRINT	AR8954 Engine Mounting - RHS Audi A6 (BPJ) 2.0 TFSi 7-Spd. Auto. Pet. (09-11)
	AR8955 Transmission Mounting Audi A6 (BPJ) 2.0 TFSi 7-Spd. Auto. Pet. (09-11)
 NO PICTURE AVAILABLE AT TIME OF PRINT	AR8956 Engine Mounting - LHS Audi A6 (CDNB) 2.0 FSi 8-Spd. Petrol Auto., (CGLC, CMGM) 2.0 TDi 8-Spd. Diesel Auto. (11-15)
 NO PICTURE AVAILABLE AT TIME OF PRINT	AR8957 Engine Mounting - RHS Audi A6 (CDNB) 2.0 FSi 8-Spd. Petrol Auto., (CGLC, CMGM) 2.0 TDi 8-Spd. Diesel Auto. (11-15)
 NO PICTURE AVAILABLE AT TIME OF PRINT	AR8958 Transmission Mounting Audi A6 (CDNB) 2.0 FSi 8-Spd. Petrol Auto., (CGLC, CMGM) 2.0 TDi 8-Spd. Diesel Auto. (11-15)
	AR8959 Engine Mounting - LHS Audi A6 (CDNB) 2.0 FSi 8-Spd. Petrol Auto. (11-15)
 NO PICTURE AVAILABLE AT TIME OF PRINT	AR8960 Engine Mounting - RHS Audi A6 (CDNB) 2.0 FSi 8-Spd. Petrol Auto. (11-15)

ENGINE MOUNTING & RUBBER BUYERS GUIDE

	<p>AR8961 Transmission Mounting Audi A6 (CDNB) 2.0 FSi 8-Spd. Petrol Auto. (11-15)</p>
	<p>AR8962 Engine Mounting - LHS Audi A4 (8E2/5, B6) (ALT) 2.0 Executive (BGB) 2.0 TFSi, (BLB) 2.0 TDi (00-08)</p>
	<p>AR8963 Engine Mounting - LHS Audi A4 (BRD, CAGA, CJCA, CMEA, CMFA) 2.0 TDi, (CABE, CDNC, CGLC, CMGB) 2.0 TFSi, (CDNC, CPMA) 2.0 TFSi Quattro (08-14)</p>
	<p>AR8964 Engine Mounting - RHS Audi A4 (BRD, CAGA, CJCA, CMEA, CMFA) 2.0 TDi, (CABE, CDNC, CGLC, CMGB) 2.0 TFSi, (CDNC, CPMA) 2.0 TFSi Quattro (08-14)</p>
	<p>AR8966 Engine Mounting - RHS BMW 1-Series (F20, F21) 116i (N13B16A) 1.6, 118i (N13B16A) 1.6, 120i (N13B16A) 1.6 (11-19), 3-Series (F30, F31) 316i (N13B16A) 1.6 (12-19)</p>
	<p>AR8967 Engine Mounting - LHS BMW 1-Series (F20, F21) 116i (N13B16A) 1.6, 118i (N13B16A) 1.6, 120i (N13B16A) 1.6 (11-19), 3-Series (F30, F31) 316i (N13B16A) 1.6 (12-19)</p>
	<p>AR8968 Transmission Mounting BMW 1-Series (F20, F21) 116i (N13B16A) 1.6, 118i (N13B16A) 1.6, 120d (B47D20A) 2.0, 120i (N13B16A) 1.6, (B48B20A) 2.0, 125i (B48B20B, N20B20A) 2.0, M135i (N55B30A) 3.0 (11-19), 2-Series (F22, F23) 220d (B47D20A, N47D20A) 2.0 Coupe, 220i (B48B20A, N20B20A/B) 2.0 Coupe, 228i (N20B20A, N26B20A) 2.0 Coupe, 230i (B46B20B, B48B20A) 2.0 Coupe (14-19), 3-Series (F30, F31) 316i (N13B16A) 1.6, 320d (N47D20A) 2.0, 320i (B48B20A, N20B20A/B/D) 2.0, 328i (N20B20A) 2.0, 330i (B46B20A, B48B20A) 2.0, 335i (N55B30A) 3.0, 340i (B58B30A) 3.0 (12-19), (F34) 320d GT (B47D20A, N47D20C) 2.0, 320i GT (N20B20A/B) 2.0, 328i GT (N20B20A, N26B20A) 2.0 (2015-), 4-Series (F32) 420d (B47B20A, N47D20C) 2.0 Coupe, 420i (N20B20A/B) 2.0 Coupe, 428i (N20B20A, N26B20A) 2.0 Coupe, 430i (B46B20B, B48B20A) 2.0 Coupe (2014-), (F33) 420i (N20B20B) 2.0 Cabriolet, 428i (N20B20A, N26B20A) 2.0 Cabriolet, 430i (B48B20B) 2.0 Cabriolet (2014-), (F36) 420d (B47B20A, N47D20C) 2.0 Gran Coupe, 428i (N20B20A, N26B20A) 2.0 Gran Coupe, 430i (N20B20B) 2.0 Gran Coupe, 428i (N20B20A, N26B20A) 2.0 Gran Coupe (2014-)</p>
	<p>AR8969 Centre Bearing Rubber BMW 1-Series (F20, F21) 116i (N13B16A) 1.6, 118i (N13B16A) 1.6, 120d (B47D20A) 2.0, 120i (N13B16A) 1.6, (B48B20A) 2.0, 125i (B48B20B, N20B20A) 2.0, M135i (N55B30A) 3.0 (11-19), 2-Series (F22, F23) 220d (B47D20A) 2.0 Coupe, 220i (B48B20A, N20B20A/B) 2.0 Coupe, 228i (N20B20A, N26B20A) 2.0 Coupe, 230i (B46B20B, B48B20A) 2.0 Coupe (14-19)</p>

	<p>AR8970 Front Lower Control Arm Bush - Inner Front BMW 1-Series (F20, F21) 116i (N13B16A) 1.6, 118i (B38B15A) 1.5, (N13B16A) 1.6, 120d (B47D20A) 2.0, 120i (N13B16A) 1.6, (B48B20A) 2.0, 125i (B48B20B, N20B20A) 2.0, M135i (N55B30A) 3.0 (11-19), 2-Series (F22, F23) 220d (B47D20A, N47D20A) 2.0 Coupe, 220i (B48B20A, N20B20A/B) 2.0 Coupe, 228i (N20B20A, N26B20A) 2.0 Coupe, 230i (B46B20B, B48B20A) 2.0 Coupe, M235i (N55B30A) 3.0 Coupe, M240i (B58B30A) 3.0 Coupe (14-19), 3-Series (F30, F31) 316i (N13B16A) 1.6, 318i (B38A15A) 1.6, 320d (N47D20A) 2.0, 320i (B48B20A, N20B20A/B/D) 2.0, 328i (N20B20A) 2.0, 330d (N57D30A) 3.0, 330i (B46B20A, B48B20A) 2.0, 335i (N55B30A) 3.0, 340i (B58B30A) 3.0 (12-19), (F34) 320d GT (B47D20A, N47D20C) 2.0, 320i GT (N20B20A/B) 2.0, 328i GT (N20B20A, N26B20A) 2.0, 335i GT (N55B30A) 3.0, 340i GT (B58B30A) 3.0 (2013-), 4-Series (F32) 420d (B47B20A, N47D20C) 2.0 Coupe, 420i (N20B20A/B) 2.0 Coupe, 428i (N20B20A, N26B20A) 2.0 Coupe, 430i (B46B20B, B48B20B) 2.0 Coupe, 435i (N55B30A) 3.0 Coupe, 440i (B58B30A) 3.0 Coupe (2014-), (F33) 420i (N20B20B) 2.0 Cabriolet, 428i (N20B20A, N26B20A) 2.0 Cabriolet, 430i (B48B20B) 2.0 Cabriolet, 440i (B58B30A) 3.0 Cabriolet (2014-), (F36) 420d (B47B20A, N47D20C) 2.0 Gran Coupe, 420i (N20B20B) 2.0 Gran Coupe, 428i (N20B20A, N26B20A) 2.0 Gran Coupe, 430i (B48B20B) 2.0 Gran Coupe, 435i (N55B30A) 3.0 Gran Coupe, 440i (B58B30A) 3.0 Gran Coupe (2014-)</p>
	<p>AR8971 Front Lower Control Arm Bush - Outer Rear BMW 1-Series (F20, F21) 116i (N13B16A) 1.6, 118i (B38B15A) 1.5, (N13B16A) 1.6, 120d (B47D20A) 2.0, 120i (N13B16A) 1.6, (B48B20A) 2.0, 125i (B48B20B, N20B20A) 2.0, M135i (N55B30A) 3.0 (11-19), 2-Series (F22, F23) 220d (B47D20A, N47D20A) 2.0 Coupe, 220i (B48B20A, N20B20A/B) 2.0 Coupe, 228i (N20B20A, N26B20A) 2.0 Coupe, 230i (B46B20B, B48B20A) 2.0 Coupe, M235i (N55B30A) 3.0 Coupe, M240i (B58B30A) 3.0 Coupe (14-19), 3-Series (F30, F31) 316i (N13B16A) 1.6, 318i (B38A15A) 1.6, 320d (N47D20A) 2.0, 320i (B48B20A, N20B20A/B/D) 2.0, 328i (N20B20A) 2.0, 330d (N57D30A) 3.0, 330i (B46B20A, B48B20A) 2.0, 335i (N55B30A) 3.0, 340i (B58B30A) 3.0 (12-19), (F34) 320d GT (B47D20A, N47D20C) 2.0, 320i GT (N20B20A/B) 2.0, 328i GT (N20B20A, N26B20A) 2.0, 335i GT (N55B30A) 3.0, 340i GT (B58B30A) 3.0 (2013-), 4-Series (F32) 420d (B47B20A, N47D20C) 2.0 Coupe, 420i (N20B20A/B) 2.0 Coupe, 428i (N20B20A, N26B20A) 2.0 Coupe, 430i (B46B20B, B48B20B) 2.0 Coupe, 435i (N55B30A) 3.0 Coupe, 440i (B58B30A) 3.0 Coupe (2014-), (F33) 420i (N20B20B) 2.0 Cabriolet, 428i (N20B20A, N26B20A) 2.0 Cabriolet, 430i (B48B20B) 2.0 Cabriolet, 440i (B58B30A) 3.0 Cabriolet (2014-), (F36) 420d (B47B20A, N47D20C) 2.0 Gran Coupe, 420i (N20B20B) 2.0 Gran Coupe, 428i (N20B20A, N26B20A) 2.0 Gran Coupe, 430i (B48B20B) 2.0 Gran Coupe, 435i (N55B30A) 3.0 Gran Coupe, 440i (B58B30A) 3.0 Gran Coupe (2014-)</p>
	<p>AR8972 Rear Axle Carrier Bush - Front Outer BMW 1-Series (F20, F21) 116i (N13B16A) 1.6, 118i (B38B15A) 1.5, (N13B16A) 1.6, 120d (B47D20A) 2.0, 120i (N13B16A) 1.6, (B48B20A) 2.0, 125i (B48B20B, N20B20A) 2.0, M135i (N55B30A) 3.0 (11-19), 2-Series (F22, F23) 220d (B47D20A, N47D20A) 2.0 Coupe, 220i (B48B20A, N20B20A/B) 2.0 Coupe, 228i (N20B20A, N26B20A) 2.0 Coupe, 230i (B46B20B, B48B20A) 2.0 Coupe, M235i (N55B30A) 3.0 Coupe, M240i (B58B30A) 3.0 Coupe (14-19), 3-Series (F30, F31) 316i (N13B16A) 1.6, 318i (B38A15A) 1.6, 320d (N47D20A) 2.0, 320i (B48B20A, N20B20A/B/D) 2.0, 328i (N20B20A) 2.0, 330d (N57D30A) 3.0, 330i (B46B20A, B48B20A) 2.0, 335i (N55B30A) 3.0, 340i (B58B30A) 3.0 (12-19), (F34) 320d GT (B47D20A, N47D20C) 2.0, 320i GT (N20B20A/B) 2.0, 328i GT (N20B20A, N26B20A) 2.0, 335i GT (N55B30A) 3.0, 340i GT (B58B30A) 3.0 (2013-), 4-Series (F32) 420d (B47B20A, N47D20C) 2.0 Coupe, 420i (N20B20A/B) 2.0 Coupe, 428i (N20B20A, N26B20A) 2.0 Coupe, 430i (B46B20B, B48B20B) 2.0 Coupe, 435i (N55B30A) 3.0 Coupe, 440i (B58B30A) 3.0 Coupe (2014-), (F33) 420i (N20B20B) 2.0 Cabriolet, 428i (N20B20A, N26B20A) 2.0 Cabriolet, 430i (B48B20B) 2.0 Cabriolet, 440i (B58B30A) 3.0 Cabriolet (2014-), (F36) 420d (B47B20A, N47D20C) 2.0 Gran Coupe, 420i (N20B20B) 2.0 Gran Coupe, 428i (N20B20A, N26B20A) 2.0 Gran Coupe, 430i (B48B20B) 2.0 Gran Coupe, 435i (N55B30A) 3.0 Gran Coupe, 440i (B58B30A) 3.0 Gran Coupe (2014-)</p>

ENGINE MOUNTING & RUBBER BUYERS GUIDE

	<p>AR8973 Rear Axle Carrier Bush - Front Centre</p> <p>BMW 1-Series (F20, F21) 116i (N13B16A) 1.6, 118i (B38B15A) 1.5, (N13B16A) 1.6, 120d (B47D20A) 2.0, 120i (N13B16A) 1.6, (B48B20A) 2.0, 125i (B48B20B, N20B20A) 2.0, M135i (N55B30A) 3.0 (11-19), 2-Series (F22, F23) 220d (B47D20A, N47D20A) 2.0 Coupe, 220i (B48B20A, N20B20A/B) 2.0 Coupe, 228i (N20B20A, N26B20A) 2.0 Coupe, 230i (B46B20B, B48B20A) 2.0 Coupe, M235i (N55B30A) 3.0 Coupe, M240i (B58B30A) 3.0 Coupe (14-19), 3-Series (F30, F31) 316i (N13B16A) 1.6, 318i (B38A15A) 1.6, 320d (N47D20A) 2.0, 320i (B48B20A, N20B20A/B/D) 2.0, 328i (N20B20A) 2.0, 330d (N57D30A) 3.0, 330i (B46B20A, B48B20A) 2.0, 335i (N55B30A) 3.0, 340i (B58B30A) 3.0 (12-19), (F34) 320d GT (B47D20A, N47D20C) 2.0, 320i GT (N20B20A/B) 2.0, 328i GT (N20B20A, N26B20A) 2.0, 335i GT (N55B30A) 3.0, 340i GT (B58B30A) 3.0 (2013-), 4-Series (F32) 420d (B47B20A, N47D20C) 2.0 Coupe, 420i (N20B20A/B) 2.0 Coupe, 428i (N20B20A, N26B20A) 2.0 Coupe, 430i (B46B20B, B48B20B) 2.0 Coupe, 435i (N55B30A) 3.0 Coupe, 440i (B58B30A) 3.0 Coupe (2014-), (F33) 420i (N20B20B) 2.0 Cabriolet, 428i (N20B20A, N26B20A) 2.0 Cabriolet, 430i (B48B20B) 2.0 Cabriolet, 435i (N55B30A) 3.0 Cabriolet, 440i (B58B30A) 3.0 Cabriolet (2014-), (F36) 420d (B47B20A, N47D20C) 2.0 Gran Coupe, 420i (N20B20B) 2.0 Gran Coupe, 428i (N20B20A, N26B20A) 2.0 Gran Coupe, 430i (B48B20B) 2.0 Gran Coupe, 435i (N55B30A) 3.0 Gran Coupe, 440i (B58B30A) 3.0 Gran Coupe (2014-)</p>	 <p>ID: 12</p>	<p>AR8976 Rear Stabilizer Bar Bush</p> <p>BMW 1-Series (F20, F21) 116i (N13B16A) 1.6, 118i (B38B15A) 1.5, (N13B16A) 1.6, 120d (B47D20A) 2.0, 120i (N13B16A) 1.6, (B48B20A) 2.0, 125i (B48B20B, N20B20A) 2.0, M135i (N55B30A) 3.0 (11-19), 2-Series (F22, F23) 220d (B47D20A, N47D20A) 2.0 Coupe, 220i (B48B20A, N20B20A/B) 2.0 Coupe, 228i (N20B20A, N26B20A) 2.0 Coupe, 230i (B46B20B, B48B20A) 2.0 Coupe, M235i (N55B30A) 3.0 Coupe, M240i (B58B30A) 3.0 Coupe (14-19), 3-Series (F30, F31) 316i (N13B16A) 1.6, 318i (B38A15A) 1.6, 320d (N47D20A) 2.0, 320i (B48B20A, N20B20A/B/D) 2.0, 328i (N20B20A) 2.0, 330d (N57D30A) 3.0, 330i (B46B20A, B48B20A) 2.0, 335i (N55B30A) 3.0, 340i (B58B30A) 3.0 (12-19), (F34) 320d GT (B47D20A, N47D20C) 2.0, 320i GT (N20B20A/B) 2.0, 328i GT (N20B20A, N26B20A) 2.0, 335i GT (N55B30A) 3.0, 340i GT (B58B30A) 3.0 (2013-), 4-Series (F32) 420d (B47B20A, N47D20C) 2.0 Coupe, 420i (N20B20A/B) 2.0 Coupe, 428i (N20B20A, N26B20A) 2.0 Coupe, 430i (B46B20B, B48B20B) 2.0 Coupe, 435i (N55B30A) 3.0 Coupe, 440i (B58B30A) 3.0 Coupe (2014-), (F33) 420i (N20B20B) 2.0 Cabriolet, 428i (N20B20A, N26B20A) 2.0 Cabriolet, 430i (B48B20B) 2.0 Cabriolet, 435i (N55B30A) 3.0 Cabriolet, 440i (B58B30A) 3.0 Cabriolet (2014-), (F36) 420d (B47B20A, N47D20C) 2.0 Gran Coupe, 420i (N20B20B) 2.0 Gran Coupe, 428i (N20B20A, N26B20A) 2.0 Gran Coupe, 430i (B48B20B) 2.0 Gran Coupe, 435i (N55B30A) 3.0 Gran Coupe, 440i (B58B30A) 3.0 Gran Coupe (2014-)</p>
	<p>AR8974 Rear Axle Carrier Bush - Rear, Outer</p> <p>BMW 1-Series (F20, F21) 116i (N13B16A) 1.6, 118i (B38B15A) 1.5, (N13B16A) 1.6, 120d (B47D20A) 2.0, 120i (N13B16A) 1.6, (B48B20A) 2.0, 125i (B48B20B, N20B20A) 2.0, M135i (N55B30A) 3.0 (11-19), 2-Series (F22, F23) 220d (B47D20A, N47D20A) 2.0 Coupe, 220i (B48B20A, N20B20A/B) 2.0 Coupe, 228i (N20B20A, N26B20A) 2.0 Coupe, 230i (B46B20B, B48B20A) 2.0 Coupe, M235i (N55B30A) 3.0 Coupe, M240i (B58B30A) 3.0 Coupe (14-19), 3-Series (F30, F31) 316i (N13B16A) 1.6, 318i (B38A15A) 1.6, 320d (N47D20A) 2.0, 320i (B48B20A, N20B20A/B/D) 2.0, 328i (N20B20A) 2.0, 330d (N57D30A) 3.0, 330i (B46B20A, B48B20A) 2.0, 335i (N55B30A) 3.0, 340i (B58B30A) 3.0 (12-19), (F34) 320d GT (B47D20A, N47D20C) 2.0, 320i GT (N20B20A/B) 2.0, 328i GT (N20B20A, N26B20A) 2.0, 335i GT (N55B30A) 3.0, 340i GT (B58B30A) 3.0 (2013-), 4-Series (F32) 420d (B47B20A, N47D20C) 2.0 Coupe, 420i (N20B20A/B) 2.0 Coupe, 428i (N20B20A, N26B20A) 2.0 Coupe, 430i (B46B20B, B48B20B) 2.0 Coupe, 435i (N55B30A) 3.0 Coupe, 440i (B58B30A) 3.0 Coupe (2014-), (F33) 420i (N20B20B) 2.0 Cabriolet, 428i (N20B20A, N26B20A) 2.0 Cabriolet, 430i (B48B20B) 2.0 Cabriolet, 435i (N55B30A) 3.0 Cabriolet, 440i (B58B30A) 3.0 Cabriolet (2014-), (F36) 420d (B47B20A, N47D20C) 2.0 Gran Coupe, 420i (N20B20B) 2.0 Gran Coupe, 428i (N20B20A, N26B20A) 2.0 Gran Coupe, 430i (B48B20B) 2.0 Gran Coupe, 435i (N55B30A) 3.0 Gran Coupe, 440i (B58B30A) 3.0 Gran Coupe (2014-)</p>	 <p>ID: 13</p>	<p>AR8977 Rear Stabilizer Bar Bush</p> <p>BMW 1-Series (F20, F21) 116i (N13B16A) 1.6, 118i (B38B15A) 1.5, (N13B16A) 1.6, 120d (B47D20A) 2.0, 120i (N13B16A) 1.6, (B48B20A) 2.0, 125i (B48B20B, N20B20A) 2.0, M135i (N55B30A) 3.0 (11-19), 2-Series (F22, F23) 220d (B47D20A, N47D20A) 2.0 Coupe, 220i (B48B20A, N20B20A/B) 2.0 Coupe, 228i (N20B20A, N26B20A) 2.0 Coupe, 230i (B46B20B, B48B20A) 2.0 Coupe, M235i (N55B30A) 3.0 Coupe, M240i (B58B30A) 3.0 Coupe (14-19), 3-Series (F30, F31) 316i (N13B16A) 1.6, 318i (B38A15A) 1.6, 320d (N47D20A) 2.0, 320i (B48B20A, N20B20A/B/D) 2.0, 328i (N20B20A) 2.0, 330d (N57D30A) 3.0, 330i (B46B20A, B48B20A) 2.0, 335i (N55B30A) 3.0, 340i (B58B30A) 3.0 (12-19), (F34) 320d GT (B47D20A, N47D20C) 2.0, 320i GT (N20B20A/B) 2.0, 328i GT (N20B20A, N26B20A) 2.0, 335i GT (N55B30A) 3.0, 340i GT (B58B30A) 3.0 (2013-), 4-Series (F32) 420d (B47B20A, N47D20C) 2.0 Coupe, 420i (N20B20A/B) 2.0 Coupe, 428i (N20B20A, N26B20A) 2.0 Coupe, 430i (B46B20B, B48B20B) 2.0 Coupe, 435i (N55B30A) 3.0 Coupe, 440i (B58B30A) 3.0 Coupe (2014-), (F33) 420i (N20B20B) 2.0 Cabriolet, 428i (N20B20A, N26B20A) 2.0 Cabriolet, 430i (B48B20B) 2.0 Cabriolet, 435i (N55B30A) 3.0 Cabriolet, 440i (B58B30A) 3.0 Cabriolet (2014-), (F36) 420d (B47B20A, N47D20C) 2.0 Gran Coupe, 420i (N20B20B) 2.0 Gran Coupe, 428i (N20B20A, N26B20A) 2.0 Gran Coupe, 430i (B48B20B) 2.0 Gran Coupe, 435i (N55B30A) 3.0 Gran Coupe, 440i (B58B30A) 3.0 Gran Coupe (2014-)</p>
	<p>AR8975 Rear Axle Carrier Bush - Rear, Centre</p> <p>BMW 1-Series (F20, F21) 116i (N13B16A) 1.6, 118i (B38B15A) 1.5, (N13B16A) 1.6, 120d (B47D20A) 2.0, 120i (N13B16A) 1.6, (B48B20A) 2.0, 125i (B48B20B, N20B20A) 2.0, M135i (N55B30A) 3.0 (11-19), 2-Series (F22, F23) 220d (B47D20A, N47D20A) 2.0 Coupe, 220i (B48B20A, N20B20A/B) 2.0 Coupe, 228i (N20B20A, N26B20A) 2.0 Coupe, 230i (B46B20B, B48B20A) 2.0 Coupe, M235i (N55B30A) 3.0 Coupe, M240i (B58B30A) 3.0 Coupe (14-19), 3-Series (F30, F31) 316i (N13B16A) 1.6, 318i (B38A15A) 1.6, 320d (N47D20A) 2.0, 320i (B48B20A, N20B20A/B/D) 2.0, 328i (N20B20A) 2.0, 330d (N57D30A) 3.0, 330i (B46B20A, B48B20A) 2.0, 335i (N55B30A) 3.0, 340i (B58B30A) 3.0 (12-19), (F34) 320d GT (B47D20A, N47D20C) 2.0, 320i GT (N20B20A/B) 2.0, 328i GT (N20B20A, N26B20A) 2.0, 335i GT (N55B30A) 3.0, 340i GT (B58B30A) 3.0 (2013-), 4-Series (F32) 420d (B47B20A, N47D20C) 2.0 Coupe, 420i (N20B20A/B) 2.0 Coupe, 428i (N20B20A, N26B20A) 2.0 Coupe, 430i (B46B20B, B48B20B) 2.0 Coupe, 435i (N55B30A) 3.0 Coupe, 440i (B58B30A) 3.0 Coupe (2014-), (F33) 420i (N20B20B) 2.0 Cabriolet, 428i (N20B20A, N26B20A) 2.0 Cabriolet, 430i (B48B20B) 2.0 Cabriolet, 435i (N55B30A) 3.0 Cabriolet, 440i (B58B30A) 3.0 Cabriolet (2014-), (F36) 420d (B47B20A, N47D20C) 2.0 Gran Coupe, 420i (N20B20B) 2.0 Gran Coupe, 428i (N20B20A, N26B20A) 2.0 Gran Coupe, 430i (B48B20B) 2.0 Gran Coupe, 435i (N55B30A) 3.0 Gran Coupe, 440i (B58B30A) 3.0 Gran Coupe (2014-)</p>	 <p>NO PICTURE AVAILABLE AT TIME OF PRINT ID: 30</p>	<p>AR8978 Centre Bearing Rubber</p> <p>Mitsubishi Triton 4X2, 4X4 2.4 MPI D/cab P/up, 2.5 Di-D Clubcab P/up, 3.2 Di-D D/cab P/up, 3.5 MPI Clubcab P/up (2007-)</p> <p>AR8979 Transmission Mounting</p> <p>Volkswagen Amarok 4X2, 4X4 (CDCA) 2.0 BITDi Man., (CDBA, CNFA) 2.0 TDi Man., (CFPA) 2.0 TSi Man., (CNEA, CSHA) 2.0 BITDi Man., (CNFB) 2.0 TDi Man. (10-16)</p> <p>AR8980 Front Strut Mounting</p> <p>Volkswagen Amarok 4X2, 4X4 (CDCA) 2.0 BITDi, (CDBA, CNFA) 2.0 TDi, (CFPA) 2.0 TSi, (CNEA, CSHA) 2.0 BITDi, (CNFB) 2.0 TDi (10-16)</p> <p>AR8981 Front Strut Mounting</p> <p>Citroen C2 (TU3JP) 1.4i VTR, (DV4TD) 1.4 HDi, (TU5J4S) 1.6 VTS (02-10), C3 (TUBA) 1.4i Attraction, Seduction, (TU5JP4) 1.6i Exclusive, Seduction (2010-); Peugeot 208 (EBO) 1.0 VTi ZMZ, (EB2F) 1.2 VTi HMZ, (EP6C) 1.6 VTi 5FS, (DV6GTED) 1.6 HDi 9HP, (DV6CTED) 1.6 HDi 9HD, 1.6 GTi (2012-)</p>

ENGINE MOUNTING & RUBBER BUYERS GUIDE











	<p>AR8982 Front Upper Control Arm Bush - Inner Front & Rear</p> <p>Ford Territory 4X2, 4X4 4.0 Ghia, TX, ST (05-10)</p>
	<p>AR8983 Front Lower Control Arm Bush - Inner</p> <p>Ford Territory 4X2, 4X4 4.0 Ghia, TX, ST (05-10)</p>
	<p>AR8984 Front Lower Control Arm Bush - Outer</p> <p>Ford Territory 4X2, 4X4 4.0 Ghia, TX, ST (05-10)</p>
	<p>AR8985 Engine Mounting - L/RHS</p> <p>Ford Territory 4X2, 4X4 4.0 Ghia, TX, ST (05-10)</p>
	<p>AR8986 Transmission Mounting</p> <p>Ford Territory 4X2, 4X4 4.0 Ghia, TX, ST (05-10)</p>
	<p>AR8987 Centre Bearing Rubber</p> <p>Ford Territory 4X2, 4X4 4.0 Ghia, TX, ST (05-10)</p>
	<p>AR8988 Propshaft Coupling</p> <p>Ford Territory 4X2, 4X4 4.0 Ghia, TX, ST (05-10)</p>
	<p>AR8990 Rear Stabilizer Bar Bush</p> <p>Audi A6 (BDX, CCEA) 2.8 FSi 7-Spd. Auto. (07-09), (BPJ) 2.0 TFSi 7-Spd. Auto. Pet., (BPP, CANA) 2.7 TDi 7-Spd. Auto., (CCEA) 2.8 FSi 7-Spd. Auto. (09-11)</p>
	<p>AR8991 Engine Mounting - LHS</p> <p>Audi A6 (BDX, CCEA) 2.8 FSi 7-Spd. Auto. (07-09), (BPP, CANA) 2.7 TDi 7-Spd. Auto., (CCEA) 2.8 FSi 7-Spd. Auto. (09-11)</p>
	<p>AR8992 Engine Mounting - RHS</p> <p>Audi A6 (BDX, CCEA) 2.8 FSi 7-Spd. Auto. (07-09), (BPP, CANA) 2.7 TDi 7-Spd. Auto., (CCEA) 2.8 FSi 7-Spd. Auto. (09-11)</p>
	<p>AR8998 Engine Mounting - LHS</p> <p>Audi A6 (ASB) 3.0 TDi Quattro (00-09)</p>
	<p>AR8999 Engine Mounting - RHS</p> <p>Audi A6 (ASB) 3.0 TDi Quattro (00-09)</p>

ENGINE MOUNTING & RUBBER BUYERS GUIDE

	AR9001 Hyundai Getz (G4EE) 1.4i HS, (D3EA) 1.5 CRDi, HS (03-12)	Engine Mounting - Rear		AR9014 Kia Sportage 4X2, 4X4 (D4EA) 2.0 CRDi SUV (05-10)	Engine Mounting - Front
	AR9002 Hyundai Getz (D3EA) 1.5 CRDi, HS, (G4ED-G) 1.6, HS (03-12)	Transmission Mounting		AR9015 Kia Sportage 4X2, 4X4 (D4EA) 2.0 CRDi SUV (05-10)	Engine Mounting - Rear
	AR9003 Hyundai Tucson (G4GC) 2.0 GLS (04-11); Kia Sportage 4X2, 4X4 (G4GC) 2.0 SWB SUV (05-10)	Engine Mounting - Front	 ID: 14, OD: 41, L: 52	AR9016 Honda Ballade (L15A7) 1.5 i-VTEC (2011-), Brio (L12B1) 1.2 (2012-), Jazz (GE) (L13Z1) 1.3 5-Spd. Man., CVT, (L13Z1) 1.4i 5-Spd. Man./Auto., (L15A7) 1.5i 5-Spd. Man./Auto. (08-14), Jazz (GK) (L13Z1) 1.3, (LDA3) 1.3 CVT Hybrid, (L15A3) 1.5i (2015-)	Front Lower Control Arm Bush - Inner
	AR9004 Hyundai Tucson (G4GC) 2.0 GLS (04-11), Tucson 4X4 (G6BA-G) 2.7 V6 (04-10); Kia Sportage 4X2, 4X4 (G4GC) 2.0 SWB SUV, (G6BA) 2.7 V6 SUV (05-10)	Engine Mounting - RHS		AR9017L Honda Ballade (L15A7) 1.5 i-VTEC (2011-), Brio (L12B1) 1.2 (2012-), Jazz (GE) (L13Z1) 1.3 5-Spd. Man., CVT, (L13Z1) 1.4i 5-Spd. Man./Auto., (L15A7) 1.5i 5-Spd. Man./Auto. (08-14), Jazz (GK) (L13Z1) 1.3, (LDA3) 1.3 CVT Hybrid, (L15A3) 1.5i (2015-)	Front Lower Control Arm Bush - Outer LHS
	AR9005 Hyundai Tucson (G4GC) 2.0 GLS (04-11); Kia Sportage 4X2, 4X4 (G4GC) 2.0 SWB SUV (05-10)	Transmission Mounting		AR9017R Honda Ballade (L15A7) 1.5 i-VTEC (2011-), Brio (L12B1) 1.2 (2012-), Jazz (GE) (L13Z1) 1.3 5-Spd. Man., CVT, (L13Z1) 1.4i 5-Spd. Man./Auto., (L15A7) 1.5i 5-Spd. Man./Auto. (08-14), Jazz (GK) (L13Z1) 1.3, (LDA3) 1.3 CVT Hybrid, (L15A3) 1.5i (2015-)	Front Lower Control Arm Bush - Outer RHS
	AR9006 Hyundai Tucson (G4GC) 2.0 GLS (04-11); Kia Sportage 4X2, 4X4 (G4GC) 2.0 SWB SUV (05-10)	Engine Mounting - Rear	 ID: 25.5, OD: 66, L: 52	AR9017I Honda Ballade (L15A7) 1.5 i-VTEC (2011-), Brio (L12B1) 1.2 (2012-), Jazz (GE) (L13Z1) 1.3 5-Spd. Man., CVT, (L13Z1) 1.4i 5-Spd. Man./Auto., (L15A7) 1.5i 5-Spd. Man./Auto. (08-14), Jazz (GK) (L13Z1) 1.3, (LDA3) 1.3 CVT Hybrid, (L15A3) 1.5i (2015-)	Front Lower Control Arm Bush - Outer (Insert Only)
	AR9007 Hyundai Tucson 4X4 (D4EA) 2.0 CRDi (04-10)	Engine Mounting - Front		AR9018 Honda Ballade (L15A7) 1.5 i-VTEC (2011-), Brio (L12B1) 1.2 (2012-)	Front Stabilizer Bar Bush
	AR9008 Hyundai Tucson 4X4 (D4EA) 2.0 CRDi (04-10); Kia Sportage 4X2, 4X4 (D4EA) 2.0 CRDi SUV (05-10)	Engine Mounting - RHS		AR9019 Honda Jazz (LDA3) 1.3 CVT Hybrid (2011-)	Engine Mounting - Rear
	AR9009 Hyundai Tucson 4X4 (D4EA) 2.0 CRDi (04-10); Kia Sportage 4X2, 4X4 (D4EA) 2.0 CRDi SUV (05-10)	Transmission Mounting		AR9020 Honda Jazz (LDA3) 1.3 CVT Hybrid (2011-)	Engine Mounting - RHS
	AR9010 Hyundai Tucson 4X4 (D4EA) 2.0 CRDi (04-10)	Engine Mount - Rear		AR9021 Honda Jazz (LDA3) 1.3 CVT Hybrid (2011-)	Transmission Mounting
	AR9011 Hyundai Tucson 4X4 (G6BA-G) 2.7 V6 (04-10); Kia Sportage 4X2, 4X4 (G6BA) 2.7 V6 SUV (05-10)	Engine Mounting - Front	 ID: 12.3, OD: 60.2, L: 35	AR9022 Honda Jazz (GD) (L13A1) 1.4i-DSi 5-Spd. Man., (L15A1) 1.5 V-Tec 5-Spd. Man., CVT (03-08), Jazz (GE) (L13Z1) 1.3 5-Spd. Man., CVT, (L13Z1) 1.4i 5-Spd. Man./Auto., (L15A7) 1.5i 5-Spd. Man./Auto. (08-14), Jazz (GK) (L13Z1) 1.3, (LDA3) 1.3 CVT Hybrid, (L15A3) 1.5i (2015-)	Front Stabilizer Bar Bush
	AR9012 Hyundai Tucson 4X4 (G6BA-G) 2.7 V6 (04-10); Kia Sportage 4X2, 4X4 (G6BA) 2.7 V6 SUV (05-10)	Transmission Mounting	 ID: 12.3, OD: 60.2, L: 54.2	AR9023 Chevrolet Optra (F16D3) 1.6, (T18SED) 1.8 (04-11)	Front Lower Control Arm Bush - Outer Rear
	AR9013 Hyundai Tucson 4X4 (G6BA-G) 2.7 V6 (04-10); Kia Sportage 4X2, 4X4 (G6BA) 2.7 V6 SUV (05-10)	Engine Mounting - Rear			

ENGINE MOUNTING & RUBBER BUYERS GUIDE

365

 ID: 12.3, OD: 44, L: 59.5	AR9024 Front Lower Control Arm Bush - Inner Front Chevrolet Optra (F16D3) 1.6, (T18SED) 1.8 (04-11)
	AR9025 Front Strut Mounting Chevrolet Optra (F16D3) 1.6, (T18SED) 1.8 (04-11)
	AR9026 Rear Strut Mounting Chevrolet Optra (F16D3) 1.6, (T18SED) 1.8 (04-11)
 ID: 17	AR9027 Front Stabilizer Bar Bush Chevrolet Optra (F16D3) 1.6, (T18SED) 1.8 (04-11)
 ID: 18	AR9028 Front Stabilizer Bar Bush Chevrolet Optra (F16D3) 1.6, (T18SED) 1.8 (04-11)
	AR9029 Rear Stabilizer Bar Bush Chevrolet Optra (F16D3) 1.6, (T18SED) 1.8 (04-11)
	AR9030 Engine Mounting - Rear Chevrolet Optra (F16D3) 1.6 (04-11)
	AR9031 Engine Mounting - L/RHS Hyundai H1 (G4KC) 2.4 CVVT, (D4CB) 2.5 CRDi (2009-)
	AR9032 Transmission Mounting Hyundai H1 (G4KC) 2.4 CVVT, (D4CB) 2.5 CRDi (2009-)
 ID: 14.5, OD: 42, L: 70	AR9033 Front Lower Control Arm Bush - Inner Front Hyundai H1 (G4KC) 2.4 CVVT, (D4CB) 2.5 CRDi (2009-)
 ID: 14.4, OD: 69.5, L: 60	AR9034 Front Lower Control Arm Bush - Outer Rear Hyundai H1 (G4KC) 2.4 CVVT, (D4CB) 2.5 CRDi (2009-)
	AR9035 Front Strut Mounting Hyundai H1 (G4KC) 2.4 CVVT, (D4CB) 2.5 CRDi (2009-), Santa Fe' (D4EB) 2.2 CRDi, (D4HB) 2.2 CRDi (2006-), Santa Fe' 4X4 (D4EB, D4HB) 2.2 CRDi, (G6EA) 2.7 GLS (2006-); Kia Sedona (D4HB) 2.2 CRDi, (KV6) 3.8 (07-13)













 ID: 19	AR9036 Rear Stabilizer Bar Bush Hyundai H1 (G4KC) 2.4 CVVT, (D4CB) 2.5 CRDi (2009-)
	AR9037 Engine Mounting - Front Ford Ecosport (M1JC) 1.0i Ecoboost, (UGJE) 1.5 TDCi, (UEJB) 1.5i (2013-), Fiesta III (M1JE) 1.0 Ecoboost, Titanium, Trend (2008-)
	AR9038 Transmission Mounting Ford Ecosport (M1JC) 1.0i Ecoboost, (UGJE) 1.5 TDCi, (UEJB) 1.5i (2013-), Fiesta III (M1JE) 1.0 Ecoboost, Titanium, Trend (2008-)
	AR9040 Engine Mounting - RHS Ford Figo 1.4 TDCi Ambiente, (FXJA, FXJB) 1.4i Ambiente, Trend (10-16)
	AR9041 Engine Mounting - RHS Toyota Avanza 1.3 P/van (06-12), (K3-VE) 1.3 S P/van, (K3-VE) 1.3 S, SX MPV, (3SZ-VE) 1.5 SX, TX MPV (12-16)
	AR9042 Engine Mounting - LHS Toyota Avanza 1.3 P/van (06-12), (K3-VE) 1.3 S P/van, (K3-VE) 1.3 S, SX MPV, (3SZ-VE) 1.5 SX, TX MPV (12-16)
 ID: 12, OD: 38, L: 70	AR9043 Front Lower Control Arm Bush - Inner Toyota Avanza (K3-VE) 1.3 S P/van, SX MPV, (3SZ-VE) 1.5 SX, TX MPV (12-16), Avanza (1NR-VE) 1.3 S, SX MPV, S P/van, (2NR-VE) 1.5 SX, TX MPV (2015-)
 ID: 12/18, OD: 70, L: 30/60	AR9044 Front Lower Control Arm Bush - Outer Toyota Avanza (K3-VE) 1.3 S P/van, SX MPV, (3SZ-VE) 1.5 SX, TX MPV (12-16), Avanza (1NR-VE) 1.3 S, SX MPV, S P/van, (2NR-VE) 1.5 SX, TX MPV (2015-)
	AR9046 Front Lower Control Arm Bush - Inner Front Ford Ecosport (M1JC) 1.0i Ecoboost, (UGJE) 1.5 TDCi, (UEJB) 1.5i (2013-)
	AR9047 Front Lower Control Arm Bush - Outer Rear Ford Ecosport (M1JC) 1.0i Ecoboost, (UGJE) 1.5 TDCi, (UEJB) 1.5i (2013-), Fiesta III (M1JE) 1.0 Ecoboost, Titanium, Trend, 1.4i Ambiente, Trend, Titanium, 1.6i Ambiente, Trend, Sport, Titanium, TDCi (2008-); Mazda 2 (DE) (ZJ-VE) 1.3, (ZY-DE/VE) 1.5 (09-15)
 ID: 24, OD: 60, L: 48.5/70	AR9048 Rear Carrier Bush Ford Fiesta II (Zetec) 1.4i Trend, (Rocam, Zetec) 1.6i Ambiente, Ghia, Trend, 2.0i ST150, ST (04-09), Ikon 1.4 1.4 TDCi. 1.6, i (07-11)

ENGINE MOUNTING & RUBBER BUYERS GUIDE

	AR9049 Rear Strut Mounting Ford Ecosport (M1JC) 1.0i Ecoboost, (UGJE) 1.5 TDCi, (UEJB) 1.5i (2013-), Fiesta II (Zetec) 1.4i Trend, (Rocam, Zetec) 1.6i Ambiente, Ghia, Trend, 2.0i ST150, ST (04-09), Fiesta III (M1JE) 1.0 Ecoboost, Titanium, Trend, 1.4i Ambiente, Trend, Titanium, 1.6i Ambiente, Trend, Sport, Titanium, TDCi (2008-), Figio 1.4 TDCi Ambiente, (FXJA, FXJB) 1.4i Ambiente, Trend (10-16), Ikon 1.4 1.4 TDCi, 1.6, i (07-11); Mazda 2 (DE) (ZJ-VE) 1.3, (ZY-DE/VE) 1.5 (07-15), 2 (DL) (ZJ-VE) 1.3, (ZY-DE/VE) 1.5 (2015-)		AR9062 Front Upper Control Arm Bush - Inner & Outer Ford Ranger T6 4X2, 4X4 (GBVAJQJ) 2.2D HP Double Cab, (GBVAJPF) 2.2 TD MP Single Cab, (GBVAF, AK, AL) 2.5, 3.2D Wildtrack, (SAFA) 3.2 TDCi (2012-); Mazda BT-50 4X2, 4X4 (MZ-CD, P4-AT) 2.2, (MZI L5-Y3) 2.5, (MZ-CD, P5-Y3) 3.2 (2012-)
	AR9050 Front Stabilizer Bar Bush Ford Ecosport (M1JC) 1.0i Ecoboost, (UGJE) 1.5 TDCi, (UEJB) 1.5i (2013-)		AR9063 Front Lower Control Arm Bush - Inner Front Ford Ranger T6 4X2, 4X4 (GBVAJQJ) 2.2D HP Double Cab, (GBVAJPF) 2.2 TD MP Single Cab, (GBVAF, AK, AL) 2.5, 3.2D Wildtrack, (SAFA) 3.2 TDCi (2012-); Mazda BT-50 4X2, 4X4 (MZ-CD, P4-AT) 2.2, (MZI L5-Y3) 2.5, (MZ-CD, P5-Y3) 3.2 (2012-)
	AR9051 Front Stabilizer Bar Bush Ford Focus II (QQDB, Q7DA) 1.8 (05-12), Focus III (PNDA) 1.6i, (MGDA) 2.0 TDCi, GDi, GTDi, (R9DA) ST1, ST3 (11-15)		AR9064 Front Lower Control Arm Bush - Outer Rear Ford Ranger T6 4X2, 4X4 (GBVAJQJ) 2.2D HP Double Cab, (GBVAJPF) 2.2 TD MP Single Cab, (GBVAF, AK, AL) 2.5, 3.2D Wildtrack, (SAFA) 3.2 TDCi (2012-); Mazda BT-50 4X2, 4X4 (MZ-CD, P4-AT) 2.2, (MZI L5-Y3) 2.5, (MZ-CD, P5-Y3) 3.2 (2012-)
	AR9053 Front Strut Mounting Volvo S40 (B4204T2/3) 2.0T Sedan 4-Spd. Auto., 5-Spd.Man. (97-04), V40 (B4204S, B4204T2) 2.0T Estate, 5-Spd. Man., 4-Spd. Auto. (97-04)		AR9065 Front Stabilizer Bar Bush Ford Ranger T6 4X2, 4X4 (GBVAJQJ) 2.2D HP Double Cab, (GBVAJPF) 2.2 TD MP Single Cab, (GBVAF, AK, AL) 2.5, 3.2D Wildtrack, (SAFA) 3.2 TDCi (2012-) - Standard Body Models
	AR9054 Front Strut Mounting Ford Mondeo (IS7G, CJBA, CJBB) 2.0 Ghia, (MEBA) 3.0 ST220 (02-06)		AR9066 Front Stabilizer Bar Bush Ford Ranger T6 4X2, 4X4 (GBVAJQJ) 2.2D HP Double Cab, (GBVAJPF) 2.2 TD MP Single Cab, (GBVAF, AK, AL) 2.5, 3.2D Wildtrack, (SAFA) 3.2 TDCi (2012-) - Raised Body Models
	AR9055 Rear Strut Mounting Ford Mondeo (IS7G, CJBA, CJBB) 2.0 Ghia, (MEBA) 3.0 ST220 (02-06)		AR9068 Front Lower Control Arm Bush - Outer Rear Fiat 500 (169A4.000) 1.2, (169A3.000) 1.4 (08-15), Panda 4X4 (187A1) 1.1, (169A4, 188A4) 1.2, (169A3) 1.4 (2005-)
	AR9056 Rear Axle Beam Bush Ford Mondeo (IS7G, CJBA, CJBB) 2.0 Ghia, (MEBA) 3.0 ST220 (02-06)		AR9069 Front Lower Control Arm Bush - Inner Front Fiat 500 (169A4.000) 1.2, (169A3.000) 1.4 (08-15), Panda 4X4 (187A1) 1.1, (169A4, 188A4) 1.2, (169A3) 1.4 (2005-)
	AR9057 Transmission Mounting - Upper Ford Mondeo (IS7G, CJBA, CJBB) 2.0 Ghia, (MEBA) 3.0 ST220 (02-06)		AR9070 Front Strut Mounting Fiat 500 (169A4.000) 1.2, (169A3.000) 1.4 (08-15), Panda 4X4 (187A1) 1.1, (169A4, 188A4) 1.2, (169A3) 1.4 (2005-)
	AR9058 Engine Mounting - RHS Ford Mondeo (IS7G, CJBA, CJBB) 2.0 Ghia, (MEBA) 3.0 ST220 (02-06)		AR9071 Engine Mounting - Rear Fiat 500 (169A4.000) 1.2 (08-15), Panda 4X4 (187A1) 1.1, (169A4, 188A4) 1.2, (169A3) 1.4 (2005-)
	AR9059 Front Stabilizer Bar Bush Ford Mondeo (IS7G, CJBA, CJBB) 2.0 Ghia (02-06)		AR9072 Engine Mounting - LHS Fiat 500 (169A4.000) 1.2 (08-15)
	AR9060 Rear Stabilizer Bar Bush Ford Mondeo (IS7G, CJBA, CJBB) 2.0 Ghia, (MEBA) 3.0 ST220 (02-06)		AR9073 Transmission Mounting Fiat 500 (169A4.000) 1.2 (08-15)
	AR9061 Engine Mounting - Rear Ford Mondeo (IS7G, CJBA, CJBB) 2.0 Ghia, (MEBA) 3.0 ST220 (02-06)		AR9074 Engine Mounting - Rear Fiat 500 (169A3.000) 1.4 (08-15)

ENGINE MOUNTING & RUBBER BUYERS GUIDE

367

	AR9075 Fiat 500 (169A3.000) 1.4 (08-15)	Engine Mounting - LHS
	AR9076 Fiat 500 (169A3.000) 1.4 (08-15)	Transmission Mounting
	AR9080 Ford Ranger T6 4X2 (GBVAJQJ) 2.2D D/cab 6-Spd. Man., (GBVAJQJ) 2.2 TD S/cab 6-Spd. Man., (SAFA) 3.2D, TDCi, Wildtrack 6-Spd. Man. (2012-); Mazda BT-50 4X2 (MZ-CD, P4-AT) 2.2 6-Spd. Man., (MZ-CD, P5-Y3) 3.2 6-Spd. Man. (2012-)	Transmission Mounting
	AR9089 Ford Ranger T6 4X2, 4X4 (GBVAJQJ) 2.2D D/cab 6-Spd. Auto., (GBVAJPF) 2.2 TD S/cab 6-Spd. Auto., (SAFA) 3.2D, TDCi, Wildtrack 6-Spd. Auto. (2012-); Mazda BT-50 4X2, 4X4 (MZ-CD, P4-AT) 2.2 6-Spd. Auto., (MZ-CD, P5-Y3) 3.2 6-Spd. Auto. (2012-)	Engine Mounting - LHS
	AR9090 Ford Ranger T6 4X2, 4X4 (GBVAJQJ) 2.2D D/cab 6-Spd. Auto., (GBVAJPF) 2.2 TD S/cab 6-Spd. Auto., (SAFA) 3.2D, TDCi, Wildtrack 6-Spd. Auto. (2012-); Mazda BT-50 4X2, 4X4 (MZ-CD, P4-AT) 2.2 6-Spd. Auto., (MZ-CD, P5-Y3) 3.2 6-Spd. Auto. (2012-)	Engine Mounting - RHS
	AR9094 Ford Ranger T6 4X2 (GBVAJQJ) 2.2D D/cab 6-Spd. Auto., (GBVAJQJ) 2.2 TD S/cab 6-Spd. Auto., (GBVAF/K/L) 2.5 Man., (SAFA) 3.2D, TDCi, Wildtrack 6-Spd. Auto. (2012-); Mazda BT-50 4X2 (MZ-CD, P4-AT) 2.2 6-Spd. Auto., (MZ-CD, P5-Y3) 3.2 6-Spd. Auto. (2012-)	Transmission Mounting
	AR9097 Fiat Grand Punto I / II (188A5, 199A4) 1.2, (199A2/3) 1.3D MultiJet, (199A6, 198A4, 350A1) 1.4 16V, (939A1.000) 1.9 MultiJet (06-12)	Front Strut Mounting
	AR9098 Fiat Panda 4X4 (187A1) 1.1, (169A4, 188A4) 1.2, (169A3) 1.4 (2005-)	Front Stabilizer Bar Bush
ID: 19.5		
	AR9099 Fiat Panda 4X4 (187A1) 1.1, (169A4, 188A4) 1.2, (169A3) 1.4 (2005-)	Front Stabilizer Bar Bush
ID: 20.5		
	AR9100 Hyundai Accent (G4ED) 1.6 GLS, HS, (G4FC) 1.6 (06-11), Elantra (HD) 1.6 GLS, (G4GC) 2.0 GLS (07-11), i30 (G4FG) 1.6, (G4GC-G) 2.0 (10-12); Kia Cerato (TD) (G4FC) 1.6, (G4KD) 2.0 (09-13), Rio II (A5D) 1.4, (G4ED) 1.6 Sport (05-11)	Front Strut Mounting
	AR9101 Hyundai Accent (G4ED) 1.6 GLS, HS, (G4FC) 1.6 (2006-); Kia Rio II (A5D) 1.4, (G4ED) 1.6 Sport (05-11)	Engine Mounting - Front (Insert Only)
	AR9102 Hyundai Accent (G4ED) 1.6 GLS, HS, (G4FC) 1.6 (2006-); Kia Rio II (A5D) 1.4, (G4ED) 1.6 Sport (05-11)	Engine Mounting - Rear (Insert Only)
	AR9103 Hyundai Accent (G4ED) 1.6 GLS, HS, (G4FC) 1.6 (2006-); Kia Rio II (A5D) 1.4, (G4ED) 1.6 Sport (05-11)	Engine Mounting - LHS

	AR9104 Hyundai Accent (G4ED) 1.6 GLS, HS, (G4FC) 1.6 (2006-); Kia Rio II (A5D) 1.4, (G4ED) 1.6 Sport (05-11)	Engine Mounting - RHS
	AR9105 Hyundai Accent (G4ED) 1.6 GLS, HS, (G4FC) 1.6 (2011-), Veloster (G4FD, G4FJ) 1.6 GDi (2013-)	Front Stabilizer Bar Bush
ID: 20.5		
	AR9106 Hyundai iX35 4X2, 4X4 (G4KD/D4HA) 2.0 CRDi, 2.4 (G4KE) (2010-); Kia Sportage 4X2, 4X4 (G4NC) 2.0, (D4HA) 2.0 CRDi (2010-)	Front Stabilizer Bar Bush
	AR9107 Hyundai Santa Fe' (D4EB) 2.2 CRDi, (D4HB) 2.2 CRDi (2006-), Santa Fe' 4X4 (D4EB, D4HB) 2.2 CRDi, (G6EA) 2.7 GLS (2006-)	Rear Upper Control Arm Bush
ID: 12, OD: 40, L: 45		
	AR9108 Hyundai Santa Fe' (D4EB) 2.2 CRDi, (D4HB) 2.2 CRDi (2006-), Santa Fe' 4X4 (D4EB, D4HB) 2.2 CRDi, (G6EA) 2.7 GLS (2006-); Kia Sorento 4X2, 4X4 (D4HB) 2.2 CRDi, (G6DC) 3.5 (2009-)	Rear Stabilizer Bar Bush
	AR9109 Kia Rio III (G4LA) 1.2, (G4FA) 1.4 (2011-)	Rear Stabilizer Bar Bush
	AR9110 Hyundai Santa Fe' (D4EB) 2.2 CRDi, (D4HB) 2.2 CRDi (2006-), Santa Fe' 4X4 (D4EB, D4HB) 2.2 CRDi (2006-); Kia Sorento 4X2, 4X4 (D4HB) 2.2 CRDi, (G6DC) 3.5 (2009-)	Engine Mounting - Front
	AR9111 Hyundai Santa Fe' (D4EB) 2.2 CRDi, (D4HB) 2.2 CRDi (2006-), Santa Fe' 4X4 (D4EB, D4HB) 2.2 CRDi (2006-); Kia Sorento 4X2, 4X4 (D4HB) 2.2 CRDi, (G6DC) 3.5 (2009-)	Engine Mounting - Rear
	AR9112 Hyundai Santa Fe' (D4EB) 2.2 CRDi, (D4HB) 2.2 CRDi (06-10), Santa Fe' 4X4 (D4EB, D4HB) 2.2 CRDi (2006-); Kia Sorento 4X2, 4X4 (D4HB) 2.2 CRDi, (G6DC) 3.5 (2009-)	Engine Mounting - LHS
	AR9113 Hyundai Santa Fe' (D4EB) 2.2 CRDi, (D4HB) 2.2 CRDi (06-10), Santa Fe' 4X4 (D4EB, D4HB) 2.2 CRDi (2006-); Kia Sorento 4X2, 4X4 (D4HB) 2.2 CRDi, (G6DC) 3.5 (2009-)	Engine Mounting - RHS
	AR9114 Kia Cerato (TD) (G4FC) 1.6, (G4KD) 2.0 (09-13)	Front Stabilizer Bar Bush
	AR9115 Hyundai Sonata (NF) 2.4 GLS (05-10)	Engine Mounting - Front
	AR9116 Hyundai Sonata (NF) 2.4 GLS (05-10)	Engine Mounting - Rear

ENGINE MOUNTING & RUBBER BUYERS GUIDE

	AR9117 Hyundai Sonata (NF) 2.4 GLS (05-10)	Engine Mounting - LHS		AR9130 Kia Carens (G4KA) 2.0 CVVT, (D4EA) 2.0 CRDi (03-06)	Engine Mounting - RHS
	AR9118 Hyundai Sonata (NF) 2.4 GLS (05-10)	Engine Mounting - RHS		AR9131 Kia Carens (G4KA) 2.0 CVVT, (D4EA) 2.0 CRDi (03-06)	Transmission Mounting
	AR9119 Hyundai Sonata (NF) 2.4 GLS (05-10)	Rear Stabilizer Bar Bush		AR9132 Kia Carens (G4KA) 2.0 CVVT, (D4EA) 2.0 CRDi (07-09)	Engine Mounting - Front
	AR9120 Hyundai Sonata (NF) 2.4 GLS (05-10)	Front Strut Mounting		AR9133 Kia Carens (G4KA) 2.0 CVVT, (D4EA) 2.0 CRDi (07-09)	Engine Mounting - RHS
	AR9121 Hyundai Sonata (NF) 2.4 GLS (05-10)	Rear Strut Mounting		AR9134 Kia Carens (G4KA) 2.0 CVVT, (D4EA) 2.0 CRDi (07-09)	Transmission Mounting
	AR9122 Hyundai Sonata (YF) (G4KC) 2.4 GDi (10-15); Kia Optima (G4KJ) 2.4 (12-14)	Front Stabilizer Bar Bush		AR9135 Kia Cerato (G4FC) 1.6 LX (04-08)	Engine Mounting - Front
	AR9123 Hyundai Sonata (YF) (G4KC) 2.4 GDi (10-15); Kia Optima (G4KJ) 2.4 (12-14)	Rear Stabilizer Bar Bush		AR9136 Kia Cerato (G4FC) 1.6 LX (04-08)	Engine Mounting - Rear
	AR9124 Ford Focus II (HYDA) 2.5 RS, ST (05-12), Kuga 4X2, 4X4 (TXDB) 2.5 Turbo, Titanium, Trend AWD (2011-); Volvo C30 (B5254T3/7) 2.5i (07-13), C70 (B5254T3/7) 2.5 T5 Sedan (06-13), S40 (B5244S4) 2.4i, (B5254T3/7) 2.5i T5 (04-12), V40 (B5254T12) 2.5 T5 (2012-)	Engine Mounting - RHS		AR9137 Kia Cerato (G4FC) 1.6 LX (04-08)	Engine Mounting - LHS
	AR9125 Hyundai Elantra (MD, UD) (G4FG) 1.6, (G4NB) 1.8 (2011-), i30 (G4GG) 1.6 GLS, Premium, (G4NB-B) 1.8 GLS, Executive (2012-), Veloster (G4FD, G4FJ) 1.6 GDi (2013-); Kia Cerato (YD) (G4FC) 1.6, (G4FJ) 1.6T-GDi, (G4NA) 2.0 (2013-)	Front Lower Control Arm Bush - Inner Rear		AR9138 Kia Cerato (G4FC) 1.6 LX, 2.0 CRDi (04-08)	Engine Mounting - RHS
	AR9126 Hyundai Elantra (MD, UD) (G4FG) 1.6, (G4NB) 1.8 (2011-), Veloster (G4FD, G4FJ) 1.6 GDi (2013-)	Front Stabilizer Bar Bush		AR9139 Kia Cerato (G4FC) 1.6 LX, 2.0 CRDi (04-08)	Front Strut Mounting
	AR9127 Hyundai Elantra (MD, UD) (G4FG) 1.6, (G4NB) 1.8 (2011-), Veloster (G4FD, G4FJ) 1.6 GDi (2013-)	Front Strut Mounting		AR9140 Kia Cerato (G4FC) 1.6 LX, 2.0 CRDi (04-08)	Rear Strut Mounting
	AR9128 Kia Carens (G4KA) 2.0 CVVT, (D4EA) 2.0 CRDi (03-06)	Engine Mounting - Front		AR9141 Kia Cerato (G4FC) 1.6 LX, 2.0 CRDi (04-08)	Front Lower Control Arm Bush - Outer
	AR9129 Kia Carens (G4KA) 2.0 CVVT, (D4EA) 2.0 CRDi (03-06)	Engine Mounting - Rear		AR9142 Kia Cerato (G4FC) 1.6 LX, 2.0 CRDi (04-08)	Front Stabilizer Bar Bush

ENGINE MOUNTING & RUBBER BUYERS GUIDE

369

	AR9143 Kia Cerato 2.0 CRDi (04-08)	Engine Mounting - Rear		AR9156 Kia Sedona 2.5, (J3) 2.9 CRDi (04-06)	Rear Stabilizer Bar Bush
	AR9144 Kia Cerato 2.0 CRDi (04-08)	Engine Mounting - Front		AR9157 Kia Sedona (J3) 2.9 CRDi (04-06)	Engine Mounting - Front
	AR9145 Kia Cerato 2.0 CRDi (04-08)	Engine Mounting - LHS		AR9158 Kia Sedona (J3) 2.9 CRDi (04-06)	Engine Mounting - Rear
	AR9146 Kia Picanto (G4HG) 1.1 LX, EX Std. (04-11)	Engine Mounting - Front		AR9159 Kia Sedona (J3) 2.9 CRDi (04-06)	Engine Mounting - RHS
	AR9147 Kia Picanto (G4HG) 1.1 LX, EX Std. (04-11)	Engine Mounting - LHS		AR9160 Kia Sedona (J3) 2.9 CRDi (04-06)	Transmission Mounting
	AR9148 Kia Picanto (G4HG) 1.1 LX, EX Std. (04-11)	Engine Mounting - RHS		AR9162 Kia Sedona (D4HB) 2.2 CRDi, (KV6) 3.8 (07-13)	Front Lower Control Arm Bush - Outer Rear
	AR9149 Kia Sedona 2.5 (04-06)	Engine Mounting - Front		AR9163 Kia Sedona (D4HB) 2.2 CRDi, (KV6) 3.8 (07-13)	Front Stabilizer Bar Bush
	AR9150 Kia Sedona 2.5 (04-06)	Engine Mounting - Rear		AR9164 Kia Sedona (D4HB) 2.2 CRDi, (KV6) 3.8 (07-13)	Rear Stabilizer Bar Bush
	AR9151 Kia Sedona 2.5 (04-06)	Engine Mounting - RHS		AR9165 Kia Sorento 4X2, 4X4 (D4CB) 2.5 CRDi SUV (02-09)	Engine Mounting - L/RHS
	AR9152 Kia Sedona 2.5 (04-06)	Transmission Mounting		AR9166 Kia Sorento 4X2, 4X4 (D4CB) 2.5 Auto. CRDi SUV (02-09)	Transmission Mounting
	AR9153 Kia Sedona 2.5, (J3) 2.9 CRDi (04-06)	Front Strut Mounting		AR9167 Kia Sorento 4X2, 4X4 (D4CB) 2.5 Man. CRDi SUV (02-09)	Transmission Mounting
	AR9154 Kia Sedona 2.5, (J3) 2.9 CRDi (04-06)	Front Lower Control Arm Bush - Inner		AR9168 Kia Sorento 4X2, 4X4 (D4HB) 2.2 CRDi, (G6DC) 3.5 (2009-)	Front Strut Mounting
	AR9155 Kia Sedona 2.5, (J3) 2.9 CRDi (04-06)	Front Stabilizer Bar Bush		AR9169 Kia Soul (G4FC) 1.6, (D4FB) 1.6 CRDi (09-11)	Engine Mounting - Rear

ENGINE MOUNTING & RUBBER BUYERS GUIDE

	AR9171 Kia Soul (G4FC) 1.6, (D4FB) 1.6 CRDi (09-11) Engine Mounting - LHS		AR9184L Mazda 6 (GH) (LF17) 2.0, (L5-VE) 2.5 (08-14) Front Lower Control Arm Bush - Outer Rear LHS
	AR9172 Kia Soul (G4FC) 1.6, (D4FB) 1.6 CRDi (2009-) Front Stabilizer Bar Bush	ID: 29	
	AR9173 Kia Soul (G4FC) 1.6, (D4FB) 1.6 CRDi (2009-) Front Strut Mounting		AR9184R Mazda 6 (GH) (LF17) 2.0, (L5-VE) 2.5 (08-14) Front Lower Control Arm Bush - Outer Rear RHS
	AR9174 Kia Soul (G4FC) 1.6, (D4FB) 1.6 CRDi (2011-) Engine Mounting - Rear	ID: 29	
	AR9175 Kia Soul (G4FC) 1.6, (D4FB) 1.6 CRDi (2011-) Engine Mounting - LHS		AR9185 Mazda 6 (GH) (LF17) 2.0, (L5-VE) 2.5 (08-14) Front Upper Control Arm Bush - Inner & Outer
	AR9176 Kia Soul (G4FC) 1.6, (D4FB) 1.6 CRDi (2011-) Engine Mounting - RHS	ID: 10, OD: 40, L: 24/44.5	
	AR9177 Mazda 2 (DE) (ZJ-VE) 1.3 Man., (ZY-DE/VE) 1.5 Man. (07-15) Engine Mounting - Rear		AR9186 Mazda 6 (GH) (LF17) 2.0, (L5-VE) 2.5 (08-14) Front Stabilizer Bar Bush
	AR9178 Mazda 2 (DE) (ZJ-VE) 1.3 Man., (ZY-DE/VE) 1.5 Man. (07-15) Engine Mounting - LHS	ID: 23	
	AR9179 Mazda 2 (DE) (ZJ-VE) 1.3, (ZY-DE/VE) 1.5 (07-15) Engine Mounting - RHS		AR9187 Mazda 6 (GH) (LF17) 2.0, (L5-VE) 2.5 (08-14) Rear Stabilizer Bar Bush
	AR9180 Mazda 6 (GH) (LF17) 2.0, (L5-VE) 2.5 (08-14) Engine Mounting - Rear	ID: 20	
	AR9181 Mazda 6 (GH) (LF17) 2.0, (L5-VE) 2.5 (08-14) Engine Mounting - LHS		AR9188 Mazda 3 (BM, BN) (Z6Y1) 1.6, (PEY7, PEX2) 2.0 (2014-), 6 (GJ, GL) (PEY5) 2.0, (SHY1) 2.2D, (PYY1, PYZA, PYY8) 2.5 (2014-), CX-5 (GH, KE) (PEY4) 2.0 (12-15) Front Lower Control Arm Bush - Inner Front
	AR9182 Mazda 6 (GH) (LF17) 2.0, (L5-VE) 2.5 (08-14) Engine Mounting - RHS		AR9189L Mazda 3 (BM, BN) (Z6Y1) 1.6, (PEY7, PEX2) 2.0 (2014-), 6 (GJ, GL) (PEY5) 2.0, (SHY1) 2.2D, (PYY1, PYZA, PYY8) 2.5 (2014-), CX-5 (GH, KE) (PEY4) 2.0 (12-15) Front Lower Control Arm Bush - Outer Rear LHS
	AR9183 Mazda 6 (GH) (LF17) 2.0, (L5-VE) 2.5 (08-14) Front Lower Control Arm Bush - Inner Front		AR9189R Mazda 3 (BM, BN) (Z6Y1) 1.6, (PEY7, PEX2) 2.0 (2014-), 6 (GJ, GL) (PEY5) 2.0, (SHY1) 2.2D, (PYY1, PYZA, PYY8) 2.5 (2014-), CX-5 (GH, KE) (PEY4) 2.0 (12-15) Front Lower Control Arm Bush - Outer Rear RHS
ID: 14, OD: 40.5, L: 37.5			AR9189I Mazda 3 (BM, BN) (Z6Y1) 1.6, (PEY7, PEX2) 2.0 (2014-), 6 (GJ, GL) (PEY5) 2.0, (SHY1) 2.2D, (PYY1, PYZA, PYY8) 2.5 (2014-), CX-5 (GH, KE) (PEY4) 2.0 (12-15) Front Lower Control Arm Bush - Outer Rear LHS (Insert Only)
			AR9190 Mazda 3 (BM, BN) (Z6Y1) 1.6, (PEY7, PEX2) 2.0 (2014-), 6 (GJ, GL) (PEY5) 2.0, (SHY1) 2.2D, (PYY1, PYZA, PYY8) 2.5 (2014-), CX-5 (GH, KE) (PEY4) 2.0 (12-15) Engine Mounting - Rear
			AR9191 Mazda 3 (BM, BN) (Z6Y1) 1.6, (PEY7, PEX2) 2.0 (2014-), 6 (GJ, GL) (PEY5) 2.0, (SHY1) 2.2D, (PYY1, PYZA, PYY8) 2.5 (2014-), CX-5 (GH, KE) (PEY4) 2.0 (12-15) Engine Mounting - LHS
			AR9192 Mazda 3 (BM, BN) (Z6Y1) 1.6, (PEY7, PEX2) 2.0 (2014-), 6 (GJ, GL) (PEY5) 2.0, (SHY1) 2.2D, (PYY1, PYZA, PYY8) 2.5 (2014-), CX-5 (GH, KE) (PEY4) 2.0 (12-15) Engine Mounting - RHS

ENGINE MOUNTING & RUBBER BUYERS GUIDE

371

	AR9193 Mazda CX-7 (ER) 4X2, 4X4 (L3-VDT) 2.3, (L5-VE) 2.5 (07-12)	Engine Mounting - Rear
	AR9194 Mazda CX-7 (ER) 4X2, 4X4 (L3-VDT) 2.3, (L5-VE) 2.5 (07-12)	Engine Mounting - LHS
	AR9195 Mazda CX-7 (ER) 4X2, 4X4 (L3-VDT) 2.3, (L5-VE) 2.5 (07-12)	Engine Mounting - RHS
	AR9196 Mazda CX-7 (ER) 4X2, 4X4 (L3-VDT) 2.3, (L5-VE) 2.5 (07-12)	Front Lower Control Arm Bush - Inner Front
	AR9197L Mazda CX-7 (ER) 4X2, 4X4 (L3-VDT) 2.3, (L5-VE) 2.5 (07-12)	Front Lower Control Arm Bush - Outer Rear LHS
	AR9197R Mazda CX-7 (ER) 4X2, 4X4 (L3-VDT) 2.3, (L5-VE) 2.5 (07-12)	Front Lower Control Arm Bush - Outer Rear RHS
	AR9197I Mazda CX-7 (ER) 4X2, 4X4 (L3-VDT) 2.3, (L5-VE) 2.5 (07-12)	Front Lower Control Arm Bush - Outer (Insert Only)
	AR9198 Mazda CX-7 (ER) 4X2, 4X4 (L3-VDT) 2.3, (L5-VE) 2.5 (07-12)	Centre Bearing Rubber - Front
	AR9199 Mazda CX-7 (ER) 4X2, 4X4 (L3-VDT) 2.3, (L5-VE) 2.5 (07-12)	Centre Bearing Rubber - Rear
	AR9200 Mazda CX-7 (ER) 4X2, 4X4 (L3-VDT) 2.3, (L5-VE) 2.5 (07-12)	Front Stabilizer Bar Bush
	AR9201 Mazda CX-7 (ER) 4X2, 4X4 (L3-VDT) 2.3, (L5-VE) 2.5 (07-12)	Rear Stabilizer Bar Bush
	AR9208 Ford Ranger T6 4X2, 4X4 (GBVAJQJ) 2.2D D/cab 6-Spd. Man., (GBVAJPF) 2.2 TD S/cab 6-Spd. Man., (GBVAF/K/L) 2.5 6-Spd. Man., (SAFA) 3.2D, TDCi, Wildtrack 6-Spd. Man. (2012-); Mazda BT-50 4X2, 4X4 (MZ-CD, P4-AT) 2.2 6-Spd. Man., (MZ-I, L5-Y3) 2.5 6-Spd. Man., (MZ-CD, P5-Y3) 3.2 6-Spd. Man. (2012-)	Engine Mounting - LHS

	AR9209 Ford Ranger T6 4X2, 4X4 (GBVAJQJ) 2.2D D/cab 6-Spd. Man., (GBVAJPF) 2.2 TD S/cab 6-Spd. Man., (GBVAF/K/L) 2.5 6-Spd. Man., (SAFA) 3.2D, TDCi, Wildtrack 6-Spd. Man. (2012-); Mazda BT-50 4X2, 4X4 (MZ-CD, P4-AT) 2.2 6-Spd. Man., (MZ-I, L5-Y3) 2.5 6-Spd. Man., (MZ-CD, P5-Y3) 3.2 6-Spd. Man. (2012-)	Engine Mounting - RHS
	AR9210 Ford Ranger T6 4X4 (GBVAJQJ) 2.2D D/cab 6-Spd. Man./Auto., (GBVAJQJ) 2.2 TD S/cab 6-Spd. Man./Auto., (SAFA) 3.2D, TDCi, Wildtrack 6-Spd. Man./Auto. (2012-); Mazda BT-50 4X2 (MZ-CD, P4-AT) 2.2 6-Spd. Man./Auto., (MZ-CD, P5-Y3) 3.2 6-Spd. Man./Auto. (2012-)	Transmission Mounting
	AR9214 Datsun GO (HR12DE) 1.2 (2015-), GO+ (HR12DE) 1.2 (2015-); Nissan Almera (HR15DE) 1.5 (2013-), Micra (K13) (HR12DE) 1.2, (HR15DE) 1.5, (K9K700/4) 1.5dCi (2011-), Micra (K14) (H4B408, HR09DET) 0.9T (2018-)	Front Lower Control Arm Bush - Inner Front
	AR9215 Datsun GO (HR12DE) 1.2 (2015-), GO+ (HR12DE) 1.2 (2015-); Nissan Almera (HR15DE) 1.5 (2013-), Micra (K13) (HR12DE) 1.2, (HR15DE) 1.5, (K9K700/4) 1.5dCi (2011-), Micra (K14) (H4B408, HR09DET) 0.9T (2018-)	Front Lower Control Arm Bush - Outer Rear
	AR9216 Nissan Almera (HR15DE) 1.5 (2013-), Micra (K13) (HR12DE) 1.2, (HR15DE) 1.5, (K9K700/4) 1.5dCi (2011-), Micra (K14) (H4B408, HR09DET) 0.9T (2018-), Murano (Z50) 4X4 (VQ35DE) 3.5i V6, X-Tronic SUV (05-10)	Front Stabilizer Bar Bush
	AR9218 Nissan Navara (D40) 4X2, 4X4 (YD25DDTi) 2.5dCi LWB D/cab LE, SE, XE P/up Dies., (V9X) 3.0dCi V6 LWB D/cab, P/up Dies., (VQ40DE) 4.0i V6 LWB LE D/cab P/up Pet. (2005-)	Steering Rack Mounting
	AR9219 Nissan Murano (Z51) 4X4 (VQ35DE) 3.5i V6, X-Tronic SUV (09-15)	Engine Mounting - Rear
	AR9220 Nissan Murano (Z51) 4X4 (VQ35DE) 3.5i V6, X-Tronic SUV (09-15)	Engine Mounting - RHS Front
	AR9221 Nissan Murano (Z51) 4X4 (VQ35DE) 3.5i V6, X-Tronic SUV (09-15)	Engine Mounting - RHS Rear
	AR9222 Nissan Murano (Z51) 4X4 (VQ35DE) 3.5i V6, X-Tronic SUV (09-15)	Front Lower Control Arm Bush - Inner Front
	AR9223 Nissan Murano (Z51) 4X4 (VQ35DE) 3.5i V6, X-Tronic SUV (09-15)	Front Lower Control Arm Bush - Outer Rear
	AR9224 Nissan Murano (Z51) 4X4 (VQ35DE) 3.5i V6, X-Tronic SUV (09-15)	Front Stabilizer Bar Bush

ENGINE MOUNTING & RUBBER BUYERS GUIDE

	AR9225 Front Strut Mounting Nissan Murano (Z51) 4X4 (VQ35DE) 3.5i V6, X-Tronic SUV (09-15)		AR9242 Engine Mounting - LHS Nissan Hardbody NP300 (D22) (YD25DDTi) 2.5 TDi LWB S, SE, D/C, D/C Hi Rider, P/up Dies. (2008-), Hardbody NP300 (D22) 4X4 (YD25DDTi) 2.5 TDi LWB S, SE, D/C, D/C Hi Rider P/up Dies. (2008-)
	AR9226 Rear Strut Mounting Nissan Murano (Z51) 4X4 (VQ35DE) 3.5i V6, X-Tronic SUV (09-15)		AR9243 Engine Mounting - RHS Nissan Hardbody NP300 (D22) (YD25DDTi) 2.5 TDi LWB S, SE, D/C, D/C Hi Rider, P/up Dies. (2008-), Hardbody NP300 (D22) 4X4 (YD25DDTi) 2.5 TDi LWB S, SE, D/C, D/C Hi Rider P/up Dies. (2008-)
	AR9227 Rear Stabilizer Bar Bush Nissan Murano (Z51) 4X4 (VQ35DE) 3.5i V6, X-Tronic SUV (09-15)		AR9245 Engine Mounting - Rear Nissan Almera (HR15DE) 1.5 Man. / Auto (2013-), Micra (K13) (HR15DE) 1.5, (K9K700/4) 1.5dCi (2011-)
	AR9228 Engine Mounting - Rear Nissan Qashqai I (J10) 4X2 (HR16DE) 1.6 Acenta 5-Spd. Man., (MR20DE) 2.0 Acenta 6-Spd. Man., (M9R) 2.0dCi Acenta 6-Spd. Man. AWD (08-13), X-Trail (T31) 4X2 (MR20DE) 2.0 6-Spd. Man., 4X4 (QR25DE) 2.5 SE 6-Spd. Man., CVT (07-15); Renault Koleos I (HY) 4X4 (2TR702) 2.5 Dynamique 6-Spd. Man., (2TR703) 2.5 CVT (08-15)		AR9246 Transmission Mounting Nissan Almera (HR15DE) 1.5 Man. / Auto (2013-), Micra (K13) (HR15DE) 1.5, (K9K700/4) 1.5dCi (2011-), Micra (K14) (H4B408, HR09DET) 0.9T (2018-)
	AR9229 Front Lower Control Arm Bush - Inner Front Nissan Qashqai I (J10) 4X2 (K9K) 1.5dCi Acenta 6-Spd. Man., (HR16DE) 1.6 Acenta 5-Spd. Man., (MR20DE) 2.0 Acenta 6-Spd. Man., (M9R) 2.0dCi Acenta 6-Spd. Man. AWD, 4X4 (M9R) 2.0dCi 6-Spd. Man. (08-13), X-Trail (T31) 4X2 (MR20DE) 2.0 6-Spd. Man., 4X2 (M9R) 2.0dCi 6-Spd. Man., 4X4 (M9R) 2.0dCi SE 6-Spd. Auto, 4X4 (QR25DE) 2.5 SE 6-Spd. Man., CVT (07-15); Renault Koleos I (HY) 4X4 (M9R) 2.0dCi 6-Spd. Auto./Man., (2TR702) 2.5 Dynamique 6-Spd. Man., (2TR703) 2.5 CVT (08-15)		AR9247 Engine Mounting - RHS Nissan Almera (HR15DE) 1.5 Man. / Auto (2013-), Micra (K13) (HR15DE) 1.5 (2011-)
	AR9230 Front Lower Control Arm Bush - Outer Rear Nissan Qashqai I (J10) 4X2 (K9K) 1.5dCi Acenta 6-Spd. Man., (HR16DE) 1.6 Acenta 5-Spd. Man., (MR20DE) 2.0 Acenta 6-Spd. Man., (M9R) 2.0dCi Acenta 6-Spd. Man. AWD, 4X4 (M9R) 2.0dCi 6-Spd. Man. (08-13), X-Trail (T31) 4X2 (MR20DE) 2.0 6-Spd. Man., 4X2 (M9R) 2.0dCi 6-Spd. Man., 4X4 (M9R) 2.0dCi SE 6-Spd. Auto, 4X4 (QR25DE) 2.5 SE 6-Spd. Man., CVT (07-15); Renault Koleos I (HY) 4X4 (M9R) 2.0dCi 6-Spd. Auto./Man., (2TR702) 2.5 Dynamique 6-Spd. Man., (2TR703) 2.5 CVT (08-15)		AR9248 Engine Mounting - LHS Hyundai Veloster (G4FD, G4FJ) 1.6 GDi (2013-)
	AR9233 Engine Mounting - RHS Nissan Juke 4X2 (HR16DE) 1.6 5-Spd. Man. (2011-), Sentra (HR16DE) 1.6 5-Spd. Man., CVT (2013-)		AR9249 Engine Mounting - RHS Hyundai Veloster (G4FD, G4FJ) 1.6 GDi (2013-)
	AR9237 Front Stabilizer Bar Bush Nissan Sentra (HR16DE) 1.6 5-Spd. Man., CVT (2013-)		AR9250 Front Strut Mounting Nissan Almera (HR15DE) 1.5 (2013-), Micra (K13) (HR12DE) 1.2, (HR15DE) 1.5, (K9K700/4) 1.5dCi (2011-), Micra (K14) (H4B408, HR09DET) 0.9T (2018-)
	AR9238L Front Strut Mounting - LHS Nissan Juke 4X2, 4X4 (HRA2DDT) 1.2, (K9K) 1.5dCi, (HR16DE) 1.6, (MR16DDT) 1.6 DIG-T (2011-), Sentra (HR16DE) 1.6 5-Spd. Man., CVT (2013-)		AR9251 Engine Mounting - RHS Nissan X-Trail (T31) 4X2 (MR20DE) 2.0 6-Spd. Man., 4X2 (M9R) 2.0dCi 6-Spd. Man., 4X4 (M9R) 2.0dCi 6-Spd. Auto. (07-15); Renault Koleos I (HY) 4X4 (M9R) 2.0dCi 6-Spd. Auto./Man. (08-15)
	AR9238R Front Strut Mounting - RHS Nissan Juke 4X2, 4X4 (HRA2DDT) 1.2, (K9K) 1.5dCi, (HR16DE) 1.6, (MR16DDT) 1.6 DIG-T (2011-), Sentra (HR16DE) 1.6 5-Spd. Man., CVT (2013-)		AR9252 Rear Axle Beam Bush Nissan Almera (HR15DE) 1.5 (2013-)
	AR9239 Shock Rubber - Rear Nissan Sentra (HR16DE) 1.6 5-Spd. Man., CVT (2013-)		AR9256 Engine Mounting - LHS Toyota Auris (1ZR-FAE) 1.6, 1.6 TRD (2010-), Verso (1ZR-FAE) 1.6, (2ZR-FAE) 1.8 (09-14)
			AR9257 Engine Mounting - Front Toyota Auris 1.8 HSD (2010-)
			AR9258 Engine Mounting - Rear Toyota Auris 1.8 HSD (2010-)

ENGINE MOUNTING & RUBBER BUYERS GUIDE

373

 <p>NO PICTURE AVAILABLE AT TIME OF PRINT</p>	<p>AR9259 Engine Mounting - LHS Toyota Auris 1.8 HSD (2010-)</p>		<p>AR9278 Front Strut Mounting Toyota RAV4 IV 4X2 (3ZR-FE) 2.0, GX, (2AR-FE) 2.5 VX AWD, RAV4 IV 4X4 (2AD-FHV, 2AD-FTV) 2.2D (2013-)</p>
 <p>NO PICTURE AVAILABLE AT TIME OF PRINT</p>	<p>AR9260 Engine Mounting - RHS Toyota Auris 1.8 HSD (2010-)</p>		<p>AR9279 Rear Stabilizer Bar Bush Toyota RAV4 IV 4X2 (3ZR-FE) 2.0, GX, (2AR-FE) 2.5 VX AWD, RAV4 IV 4X4 (2AD-FHV, 2AD-FTV) 2.2D (2013-)</p>
	<p>AR9261 Engine Mounting - Rear Toyota Land Cruiser 200-Series 4X4 (1UR-FE) 4.6 V8 6-Spd. Auto. (2012-)</p>		<p>AR9280 Engine Mounting - Front Toyota Verso (1ZR-FAE) 1.6, (2ZR-FAE) 1.8 (09-14)</p>
	<p>AR9262 Engine Mounting - LHS Toyota Land Cruiser 200-Series 4X4 (1UR-FE) 4.6 V8 6-Spd. Auto. (2012-)</p>		<p>AR9281 Engine Mounting - Rear Toyota Verso (1ZR-FAE) 1.6, (2ZR-FAE) 1.8 (09-14)</p>
	<p>AR9263 Engine Mounting - RHS Toyota Land Cruiser 200-Series 4X4 (1UR-FE) 4.6 V8 6-Spd. Auto. (2012-)</p>		<p>AR9284 Front Stabilizer Bar Bush - LHS Toyota Verso (1ZR-FAE) 1.6, (2ZR-FAE) 1.8, (1AD-FTV) 2.0D-4D (09-14)</p>
	<p>AR9264 Front Stabilizer Bar Bush Toyota Land Cruiser 200-Series 4X4 (1UR-FE) 4.6 V8 6-Spd. Auto. (2012-)</p>		<p>AR9285 Front Stabilizer Bar Bush - RHS Toyota Verso (1ZR-FAE) 1.6, (2ZR-FAE) 1.8, (1AD-FTV) 2.0D-4D (09-14)</p>
	<p>AR9265 Rear Stabilizer Bar Bush Toyota Land Cruiser 200-Series 4X4 (1UR-FE) 4.6 V8 6-Spd. Auto. (2012-)</p>		<p>AR9286 Front Strut Mounting Toyota Verso (1ZR-FAE) 1.6, (2ZR-FAE) 1.8, (1AD-FTV) 2.0D-4D (09-14)</p>
	<p>AR9266 Transmission Mounting Toyota Land Cruiser (UZJ100) 4X4 (1HD-FTE) 4.2 VX TD S/W, GX DSL S/W, P/up S/W AHC Dies. 4/5-Spd. Auto. (04-08), 100-Series 4X4 4.2D 5-Spd. Man., 4.2D 4-Spd. Auto., 4.7 V8 5-Spd. Auto. (02-07)</p>		<p>AR9287 Engine Mounting - Front Toyota Verso (2ZR-FAE) 1.8 CVT (09-14), RAV4 IV 4X2 (3ZR-FE) 2.0 CVT (2013-)</p>
	<p>AR9267 Engine Mounting - L/RHS Toyota Land Cruiser (UZJ100) 4X4 (1HD-FTE) 4.2 VX TD S/W, GX DSL S/W, P/up S/W AHC Dies. 4/5-Spd. Auto. (04-08), 100-Series 4X4 4.2D 5-Spd. Man., 4.2D 4-Spd. Auto., 4.7 V8 5-Spd. Auto. (02-07)</p>		<p>AR9288 Engine Mounting - Rear Toyota Verso (2ZR-FAE) 1.8 CVT (09-14)</p>
 <p>NO PICTURE AVAILABLE AT TIME OF PRINT</p>	<p>AR9272 Engine Mounting - Rear Toyota RAV4 IV 4X4 (2AD-FHV, 2AD-FTV) 2.2D (2013-)</p>		<p>AR9289 Engine Mounting - LHS Toyota Verso (2ZR-FAE) 1.8 CVT (09-14)</p>
 <p>NO PICTURE AVAILABLE AT TIME OF PRINT</p>	<p>AR9273 Engine Mounting - LHS Toyota RAV4 IV 4X4 (2AD-FHV, 2AD-FTV) 2.2D (2013-)</p>		<p>AR9290 Engine Mounting - Rear Toyota Verso (1AD-FTV) 2.0D-4D (09-14)</p>
	<p>AR9274 Engine Mounting - RHS Toyota RAV4 IV 4X2 (3ZR-FE) 2.0, RAV4 IV 4X4 (2AD-FHV, 2AD-FTV) 2.2D (2013-)</p>		<p>AR9291 Engine Mounting - LHS Toyota Verso (1AD-FTV) 2.0D-4D (09-14)</p>
	<p>AR9277 Front Stabilizer Bar Bush Toyota RAV4 IV 4X2 (3ZR-FE) 2.0, RAV4 IV 4X4 (2AD-FHV, 2AD-FTV) 2.2D (2013-)</p>	 <p>NO PICTURE AVAILABLE AT TIME OF PRINT</p>	<p>AR9292 Engine Mounting - Rear Toyota Yaris (1KR-FE) 1.0 (10-14)</p>

ENGINE MOUNTING & RUBBER BUYERS GUIDE

	AR9293 Engine Mounting - LHS Toyota Yaris (1KR-FE) 1.0 (10-14)		AR9312 Centre Bearing Rubber Mercedes-Benz Sprinter (BM906) (OM646.984) 309 CDI P/van, 16-Seater, (OM646.989, 990) 315 CDI FC, 16-Seater, (OM642.992, 993, 896) 318 CDI P/van, (OM642.992, 896, 898) 319 CDI DC, FC, PV, XC, (OM646.992, 993, 896) 518 CDI FC, DC, PV, 22-Seater, (OM642.896, 898, 992) 519 CDI (2009-); Volkswagen Crafter (CKTB, CSNB) 2.0 BitDi, (BJK, BJM) 2.5TDI 35-Series SWB, P/van, 50 HR-Series LWB, XLWB P/van (2007-)
	AR9294 Engine Mounting - RHS Toyota Yaris (1KR-FE) 1.0 (10-14)		AR9313 Rear Axle Beam Bush Volkswagen Beetle (CBZB) 1.2 TSi, (CZDA) 1.4 TSi (2012-)
	AR9295 Rear Axle Beam Bush Toyota Yaris (1KR-FE) 1.0, (1NR-FE) 1.3 CVT, 6-Spd. (10-14)		AR9314 Brake Pedal Rubber Volkswagen Golf VII (CJZA) 1.2 TSi, (CMBA, CPVA, CXSA) 1.4 TSi, (CHPA, CPTA) 1.4 TSi, (CRVA, CYKB) 2.0 TDi, (CRBC, CRLB, CRMB, CRUA) 2.0 TDi (2013-)
	AR9296 Engine Mounting - Rear Toyota Yaris (NSP130) (1NR-FE) 1.3 CVT, 6-Spd. Man. (10-14)		AR9315 Front Lower Control Arm Bush - Outer Rear Volkswagen Beetle (CBZB) 1.2 TSi, (CZDA) 1.4 TSi (2012-), Caddy (CLCA) 2.0 TDi 5-Spd. Man., (CFHC, CLCB) 2.0 TDi (2010-), Jetta VI (CBZB) 1.2 TSi, (CAVD, CAXA) 1.4 TSi, (CAYC) 1.6 TDi, (CFHC, CJAA, CLCB) 2.0 TDi (2011-)
	AR9297 Engine Mounting - LHS Toyota Yaris (1NR-FE) 1.3 CVT, 6-Spd. (10-14)		AR9316 Engine Mounting - Rear Volkswagen Passat (CDA) 1.8 TSi, (CFFB) 2.0 TDi (11-16)
	AR9298 Engine Mounting - RHS Toyota Yaris (1NR-FE) 1.3 CVT, 6-Spd. (10-14)		AR9317 Engine Mounting - RHS Volkswagen Passat (CFFB) 2.0 TDi (11-16)
	AR93 Shock Rubber - Front Ford Capri 1.6 GT, 2.0 XL, 3.0 (69-73), Cortina MkI 1.2 De Luxe, 1.5 Super, S/W (62-66), Cortina MkII 1.3, 1.6 GT, Super, XL (68-71); Leyland Mini 1.0, Cooper, Countryman, MkII, MkIII, P/up, P/van, S, S/W, Sed., 1.1, Clubman, Countryman, D/L, Moonlight, Sunshine, Van den Plas, 1.3, Panda, 1275 GTS, E, Clubman GT, Cooper S (59-84)		AR9318 Transmission Mounting Volkswagen Tiguan 4X2, 4X4 (CAXA) 1.4 TSi Man., (CAVD, CTHD) 1.4 TSi Man. 4-Motion, (CFFD) 2.0 TDi, (CCZB) 2.0 TSi Man. 4-Motion (11-17)
	AR9307 Front Stabilizer Bar Bush Toyota Yaris (1NR-ZFXE) 1.5 Hybrid (10-14)		AR9319 Engine Mounting - Rear Volkswagen Tiguan 4X2, 4X4 (CAXA) 1.4 TSi 6-Spd. Man., (CFFD) 2.0 TDi 6-Spd. Man (11-17)
	AR9308 Front Strut Mounting Toyota Yaris (KSP130) (1KR-FE) 1.0, (NSP130) (1NR-FE) 1.3, (NSP131) (2NR-FKE) 1.5 Pulse Hybrid (13-17)		AR9320 Rear Carrier Bush - Front Audi S3 (CDLC) 2.0 TFSi (07-13); Volkswagen Tiguan 4X2, 4X4 (CAXA) 1.4 TSi, (CAVD, CTHD) 1.4 TSi 4-Motion, (CFFD) 2.0 TDi, (CCZB) 2.0 TSi 4-Motion (11-17)
	AR9309 Rear Axle Beam Bush Toyota Yaris (KSP130) (1KR-FE) 1.0, (NSP130) (1NR-FE) 1.3, (NSP131) (2NR-FKE) 1.5 Pulse Hybrid (13-17)		AR9321 Rear Carrier Bush - Rear Audi S3 (CDLC) 2.0 TFSi (07-13); Volkswagen Tiguan 4X2, 4X4 (CAXA) 1.4 TSi, (CAVD, CTHD) 1.4 TSi 4-Motion, (CFFD) 2.0 TDi, (CCZB) 2.0 TSi 4-Motion (11-17)
	AR9310 Centre Bearing Rubber Volkswagen Amarok 4x2, 4x4 (CDCA) 2.0 BitDi, (CDBA, CNFA) 2.0 TDi, (CFPA) 2.0 TSi, (CNEA, CSHA) 2.0 BitDi, (CNFB) 2.0 TDi (10-16)		AR9322 Centre Bearing Rubber Volkswagen Tiguan 4X2, 4X4 (BWK, CAVA) 1.4 TSi Trend&Fun, Track&Field, (CBAB) 2.0 TDi Track&Field, Sport&Style, Trend&Fun, (CCZA) 2.0 TSi Track&Field, Sport&Style, 4-Motion (08-11), (CAXA) 1.4 TSi, (CAVD, CTHD) 1.4 TSi 4-Motion, (CFFD) 2.0 TDi, (CCZB) 2.0 TSi 4-Motion (11-17)
	AR9311 Centre Bearing Rubber Toyota RAV4 III (ACE, ALA) 4X4 (1AZ-FE) 2.0 GX, VX, Fierce SUV Pet., 5-Spd. Man., 4-Spd. Auto., (2AD-FTV) 2.2D-4D GX, VX Dies. 5-Spd. Man. (06-13), RAV4 IV 4X2 (3ZR-FE) 2.0, GX, (2AR-FE) 2.5 VX AWD, RAV4 IV 4X4 (2AD-FHV, 2AD-FTV) 2.2D (2013-)		AR9323 Propshaft Coupling - Front Volkswagen Tiguan 4X2, 4X4 (CAXA) 1.4 TSi, (CAVD, CTHD) 1.4 TSi 4-Motion, (CFFD) 2.0 TDi, (CCZB) 2.0 TSi 4-Motion (11-17)

ENGINE MOUNTING & RUBBER BUYERS GUIDE

375

	<p>AR9324 Propshaft Coupling - Rear</p> <p>Volkswagen Tiguan 4X2, 4X4 (CAXA) 1.4 TSi, (CAVD, CTHD) 1.4 TSi 4-Motion, (CFFD) 2.0 TDi, (CCZB) 2.0 TSi 4-Motion (11-17)</p>		<p>AR9336 Accelerator Pedal Rubber</p> <p>Volkswagen Touareg 4X4 (BAC, BPE) 2.5 R5 TDi, (BKS, CATA, CASA, CASC, CNRB) 3.0 V6 TDi, (AXQ) 4.2 V8, (AYH, BLE, BWF) 5.0 V10 TDi (04-11), (BHK, BHL) 3.6 FSi V6, (BAR) 4.2 V8 (07-11), (CASA, CNRB) 3.0 TDi V6, (CGRA) 3.6 FSi V6, (CKDA) 4.2 TDi V8 (2010-)</p>
	<p>AR9325 Engine Mounting - Rear</p> <p>Volkswagen Tiguan 4X2, 4X4 Tiguan 4X2, 4X4 (CAXA) 1.4 TSi 6/7-Spd. Auto., (CFFD) 2.0 TDi 6/7-Spd. Auto. (11-17)</p>		<p>AR9337 Engine Mounting - L/RHS</p> <p>Volkswagen Touareg 4X4 (AYH, BLE, BWF) 5.0 V10 TDi (04-11)</p>
	<p>AR9326 Engine Mounting - RHS</p> <p>Volkswagen Tiguan 4X2, 4X4 (CFFD) 2.0 TDi, (CCZB) 2.0 TSi 4-Motion (11-17)</p>		<p>AR9338 Transmission Mounting</p> <p>Audi Q7 (BAR) 4.2 FSi Quattro (06-10); Volkswagen Touareg 4X4 (BAC, BPE) 2.5 R5 TDi, (BKS, CATA, CASA, CASC, CNRB) 3.0 V6 TDi, (AXQ) 4.2 V8, (AYH, BLE, BWF) 5.0 V10 TDi (04-11), (BHK, BHL) 3.6 FSi V6, (BAR) 4.2 V8 (07-11)</p>
	<p>AR9327 Transmission Mounting</p> <p>Volkswagen Tiguan 4X2, 4X4 (CAXA) 1.4 TSi Auto., (CAVD, CTHD) 1.4 TSi Auto. 4-Motion, (CFFD) 2.0 TDi, (CCZB) 2.0 TSi Auto. 4-Motion (11-17)</p>		<p>AR9339 Engine Mounting - L/RHS</p> <p>Volkswagen Touareg 4X4 (BAC, BPE) 2.5 R5 TDi (04-11), (CASA, CNRB) 3.0 TDi V6, (CGRA) 3.6 FSi V6, (CKDA) 4.2 TDi V8 (2010-)</p>
	<p>AR9329 Front Upper Control Arm Bush - Inner & Outer</p> <p>Audi Q7 (BAR) 4.2 FSi Quattro (06-10); Volkswagen Touareg 4X4 (BAC, BPE) 2.5 R5 TDi, (BKS, CATA, CASA, CASC, CNRB) 3.0 V6 TDi, (AXQ) 4.2 V8, (AYH, BLE, BWF) 5.0 V10 TDi (04-11), (BHK, BHL) 3.6 FSi V6, (BAR) 4.2 V8 (07-11)</p>		<p>AR9340 Engine Mounting - L/RHS</p> <p>Audi Q7 (BAR) 4.2 FSi Quattro (06-10); Volkswagen Touareg 4X4 (AXQ) 4.2 V8 (04-11), (BHK, BHL) 3.6 FSi V6, (BAR) 4.2 V8 (07-11)</p>
	<p>AR9330 Front Lower Control Arm Bush - Inner Front Inner</p> <p>Audi Q7 (BAR) 4.2 FSi Quattro (06-10); Volkswagen Touareg 4X4 (BAC, BPE) 2.5 R5 TDi, (BKS, CATA, CASA, CASC, CNRB) 3.0 V6 TDi, (AXQ) 4.2 V8, (AYH, BLE, BWF) 5.0 V10 TDi (04-11), (BHK, BHL) 3.6 FSi V6, (BAR) 4.2 V8 (07-11), (CASA, CNRB) 3.0 TDi V6, (CGRA) 3.6 FSi V6, (CKDA) 4.2 TDi V8 (2010-)</p>		<p>AR9341 Engine Mounting - L/RHS</p> <p>Volkswagen Touareg 4X4 (CASA, CNRB) 3.0 TDi V6 (2010-)</p>
	<p>AR9331 Front Lower Control Arm Bush - Inner Front Outer</p> <p>Audi Q7 (BAR) 4.2 FSi Quattro (06-10); Volkswagen Touareg 4X4 (BAC, BPE) 2.5 R5 TDi, (BKS, CATA, CASA, CASC, CNRB) 3.0 V6 TDi, (AXQ) 4.2 V8, (AYH, BLE, BWF) 5.0 V10 TDi (04-11), (BHK, BHL) 3.6 FSi V6, (BAR) 4.2 V8 (07-11), (CASA, CNRB) 3.0 TDi V6, (CGRA) 3.6 FSi V6, (CKDA) 4.2 TDi V8 (2010-)</p>		<p>AR9342 Engine Mounting - L/RHS</p> <p>Volkswagen Touareg 4X4 (CGRA) 3.6 FSi V6 (2010-)</p>
	<p>AR9332 Front Lower Control Arm Bush - Outer Rear</p> <p>Audi Q7 (BAR) 4.2 FSi Quattro (06-10); Volkswagen Touareg 4X4 (BAC, BPE) 2.5 R5 TDi, (BKS, CATA, CASA, CASC, CNRB) 3.0 V6 TDi, (AXQ) 4.2 V8, (AYH, BLE, BWF) 5.0 V10 TDi (04-11), (BHK, BHL) 3.6 FSi V6, (BAR) 4.2 V8 (07-11), (CASA, CNRB) 3.0 TDi V6, (CGRA) 3.6 FSi V6, (CKDA) 4.2 TDi V8 (2010-)</p>		<p>AR9343 Engine Mounting - L/RHS</p> <p>Volkswagen Touareg 4X4 (CKDA) 4.2 TDi V8 (2010-)</p>
<small>ID: 14, OD: 72, L: 53</small> 	<p>AR9333 Front Axle Beam Bush - Front & Rear L/RHS</p> <p>Volkswagen Touareg 4X4 (BAC, BPE) 2.5 R5 TDi, (BKS, CATA, CASA, CASC, CNRB) 3.0 V6 TDi, (AXQ) 4.2 V8, (AYH, BLE, BWF) 5.0 V10 TDi (04-11), (BHK, BHL) 3.6 FSi V6, (BAR) 4.2 V8 (07-11)</p>		<p>AR9344 Front Upper Control Arm Bush - Inner & Outer</p> <p>Volkswagen Touareg 4X4 (CASA, CNRB) 3.0 TDi V6, (CGRA) 3.6 FSi V6, (CKDA) 4.2 TDi V8 (2010-)</p>
	<p>AR9334 Front & Rear Strut Mounting</p> <p>Volkswagen Touareg 4X4 (BAC, BPE) 2.5 R5 TDi, (BKS, CATA, CASA, CASC, CNRB) 3.0 V6 TDi, (AXQ) 4.2 V8, (AYH, BLE, BWF) 5.0 V10 TDi (04-11), (BHK, BHL) 3.6 FSi V6, (BAR) 4.2 V8 (07-11)</p>		<p>AR9347 Front Strut Mounting</p> <p>Volkswagen Touareg 4X4 (CASA, CNRB) 3.0 TDi V6, (CGRA) 3.6 FSi V6, (CKDA) 4.2 TDi V8 (2010-)</p>
	<p>AR9335 Brake Pedal Rubber</p> <p>Volkswagen Touareg 4X4 (BAC, BPE) 2.5 R5 TDi, (BKS, CATA, CASA, CASC, CNRB) 3.0 V6 TDi, (AXQ) 4.2 V8, (AYH, BLE, BWF) 5.0 V10 TDi (04-11), (BHK, BHL) 3.6 FSi V6, (BAR) 4.2 V8 (07-11), (CASA, CNRB) 3.0 TDi V6, (CGRA) 3.6 FSi V6, (CKDA) 4.2 TDi V8 (2010-)</p>		<p>AR9348 Front Axle Beam Bush</p> <p>Volkswagen Touareg 4X4 (CASA, CNRB) 3.0 TDi V6, (CGRA) 3.6 FSi V6 (2010-)</p>
			<p>AR9349 Front Axle Beam Bush</p> <p>Volkswagen Touareg 4X4 (CKDA) 4.2 TDi V8 (2010-)</p>
			<p>AR9350 Rear Strut Mounting</p> <p>Volkswagen Touareg 4X4 (CASA, CNRB) 3.0 TDi V6, (CGRA) 3.6 FSi V6, (CKDA) 4.2 TDi V8 (2010-)</p>

ENGINE MOUNTING & RUBBER BUYERS GUIDE

	<p>AR9351 Rear Axle Beam Bush Volkswagen Up (CHYB) 1.0 (2015-)</p>		<p>AR9358 Front Strut Mounting BMW 1-Series (F20, F21) 116i (N13B16A) 1.6, 118i (B38B15A) 1.5, (N13B16A) 1.6, 120d (B47D20A) 2.0, 120i (N13B16A) 1.6, (B48B20A) 2.0, 125i (B48B20B, N20B20A) 2.0, M135i (N55B30A) 3.0 (11-19), 2-Series (F22, F23) 220d (B47D20A) 2.0 Coupe, 220i (B48B20A, N20B20A/B) 2.0 Coupe, 228i (N20B20A, N26B20A) 2.0 Coupe, 230i (B46B20B, B48B20A) 2.0 Coupe, M235i (N55B30A) 3.0 Coupe, M240i (B58B30A) 3.0 Coupe (14-19), 3-Series (F30, F31) 316i (N13B16A) 1.6, 318i (B38A15A) 1.6, 320d (N47D20A) 2.0, 320i (B48B20A, N20B20A/B/D) 2.0, 328i (N20B20A) 2.0, 330d (N57D30A) 3.0, 330i (B46B20A, B48B20A) 2.0, 335i (N55B30A) 3.0, 340i (B58B30A) 3.0 (12-19), (F34) 320d GT (B47D20A, N47D20C) 2.0, 320i GT (N20B20A/B) 2.0, 328i GT (N20B20A, N26B20A) 2.0, 335i GT (N55B30A) 3.0, 340i GT (B58B30A) 3.0 (2013-), 4-Series (F32) 420d (B47B20A, N47D20C) 2.0 Coupe, 420i (N20B20A/B) 2.0 Coupe, 428i (N20B20A, N26B20A) 2.0 Coupe, 430i (B46B20B, B48B20B) 2.0 Coupe, 435i (N55B30A) 3.0 Coupe, 440i (B58B30A) 3.0 Coupe (2014-), (F33) 420i (N20B20B) 2.0 Cabriolet, 428i (N20B20A, N26B20A) 2.0 Cabriolet, 430i (B48B20B) 2.0 Cabriolet, 435i (N55B30A) 3.0 Cabriolet, 440i (B58B30A) 3.0 Cabriolet (2014-), (F36) 420d (B47B20A, N47D20C) 2.0 Gran Coupe, 420i (N20B20B) 2.0 Gran Coupe, 428i (N20B20A, N26B20A) 2.0 Gran Coupe, 430i (B48B20B) 2.0 Gran Coupe, 435i (N55B30A) 3.0 Gran Coupe, 440i (B58B30A) 3.0 Gran Coupe (2014-)</p>
 <p>ID: 16</p>	<p>AR9352 Front Stabilizer Bar Bush Volkswagen Polo (9N) (BBY, BKY, BLM) 1.4i, Classic, Trendline, Comfortline, (AMF) 1.4 TDi, Classic, (BAH) 1.6i, Classic Lux, Comfortline, Trendline, SE, (ATD) 1.9 TDi, HighLine, Classic, HighLine, Sportline, (BBU, BJX) 1.8T GTi Classic, Trendline, (ASZ, BBX) 2.0i HighLine, Classic HighLine (02-10), Cross Polo 1.6 TDi, 1.9 TDi (07-10), Polo (CBZB) 1.2 Trendline DSG Pet., (CBZC) 1.2 TSi Comfortline Man. Pet., (CFWA) 1.2 TDi Trendline, BlueMotion Man. DSL, (CGPA, CGPB) 1.2 Man. (2010-), Polo Vivo (CFWA) 1.2 TDi, (CLPA, CLPB) 1.4i Trendline, (CLSA) 1.6i Trendline (2010-), Polo (6R) (CAVE, CDDA, CGGB, CLPA) 1.4i Trendline, Comfortline, GTi, (CFNA, CLSA) 1.6i Comfortline, Trendline, Tiptronic, (CAYC) 1.6 TDi Comfortline (10-15), Polo (6C) (CJZC, CJZD) 1.2 TSi, (CDDA, CGGB, CLPA) 1.4, (CUTA, CYZB) 1.4 TDi, (CWXC) 1.5 TDi, (CFNA, CLSA) 1.6, (DAJA) 1.8 TSi, GTi (2014-), Polo (CHYA, CHYB) 1.0 Comfortline, Trendline BlueMotion Hatch (2014-), Polo (GP) (CHZB) 1.0 TSi BlueMotion 5-dr, (CHZC) 1.0 TSi Comfortline, TSi-R-Line DSG (15-17), Polo (AW1, BZ1) 1.0 TSi GT (2018-), Up (CHYB) 1.0 (2015-)</p>		<p>AR9359 Exhaust Hanger - Middle BMW 1-Series (E81, E87) 116i (N45) 1.6, 118i (N46) 2.0, 120i (N46) 2.0, 130i (N52) 3.0 (04-15), (E88) 120i (N46) 2.0 (04-15), (E82) 120d (N47) 2.0 (2005-), (E87) 118d (M47) 2.0, 120d (M47) 2.0 (2005-), (E82, E88) 125i (N52, N54, N55) 3.0 Convertible, Coupe, 135i (N54, N55) 3.0 Turbo (08-14)</p>
	<p>AR9353 Engine Mounting - RHS Volkswagen Up (CHYB) 1.0 (2015-)</p>		<p>AR9360 Engine Mounting - LHS BMW 2-Series (F22, F23) 220d (N47D20A) 2.0 Coupe (11-19), 3-Series (F30, F31) 320d (N47D20A) 2.0, 328i (N20B20A) 2.0 (12-19), (F34) 320d GT (N47D20C) 2.0, 328i GT (N20B20A, N26B20A) 2.0 (2013-), 4-Series (F32) 420d (B47B20A, N47D20C) 2.0 Coupe (2014-), (F36) 420d (N47D20C) 2.0 Gran Coupe (2014-)</p>
	<p>AR9354 Engine Mounting - LHS Volkswagen Up (CHYB) 1.0 (2015-)</p>		<p>AR9361 Engine Mounting - RHS BMW 2-Series (F22, F23) 220d (N47D20A) 2.0 Coupe (11-19), 3-Series (F30, F31) 320d (N47D20A) 2.0, 328i (N20B20A) 2.0 (12-19), (F34) 320d GT (N47D20C) 2.0, 328i GT (N20B20A, N26B20A) 2.0 (2013-), 4-Series (F32) 420d (B47B20A, N47D20C) 2.0 Coupe (2014-), (F36) 420d (N47D20C) 2.0 Gran Coupe (2014-)</p>
	<p>AR9355 Engine Mounting - Rear Volkswagen Up (CHYB) 1.0 (2015-)</p>		<p>AR9362 Exhaust Hanger BMW 1-Series (F20, F21) 120d (B47D20A) 2.0 (11-19), 2-Series (F22, F23) 220d (N47D20A) 2.0 Coupe (14-19), 3-Series (E90) 320d (M47) 2.0, 320i (N46) 2.0 (05-13), (E92) 320i (N44) 2.0 (02-15), (E93) 330i (N52) 3.0, 335i (N54, N55) 3.0 (05-14), (F30, F31) 320d (N47D20A) 2.0 (12-19), (F34) 320d GT (N47D20C) 2.0 (2013-), 4-Series (F32) 420d (B47B20A, N47D20C) 2.0 Coupe (2014-)</p>
	<p>AR9357 Exhaust Hanger - Middle BMW 1-Series (F20, F21) 116i (N13B16A) 1.6, 118i (B38B15A) 1.5, (N13B16A) 1.6, 120i (N13B16A) 1.6, (B48B20A) 2.0, 125i (B48B20B, N20B20A) 2.0, M135i (N55B30A) 3.0 (11-19), 2-Series (F22, F23) 220i (B48B20A, N20B20A/B) 2.0 Coupe, 228i (N20B20A, N26B20A) 2.0 Coupe, 230i (B46B20B, B48B20A) 2.0 Coupe (14-19), (F45) 218i Active Tourer (B38A15A) 1.5, 220d Active Tourer (B47C20A/B) 2.0, 220i Active Tourer (B48A20A/F) 2.0, 225i Active Tourer (B48A20B) 2.0 (2015-), (F46) 218i Gran Tourer (B38A15A) 1.5, 220d Gran Tourer (B47C20A/B) 2.0, 220i Gran Tourer (B48A20A) 2.0 (2015-), 3-Series (F30, F31) 316i (N13B16A) 1.6, 318i (B38A15A) 1.6, 320d (N47D20A) 2.0, 320i (B48B20A, N20B20A/B/D) 2.0, 330d (N57D30A) 3.0, 330i (B46B20A, B48B20A) 2.0, 335i (N55B30A) 3.0, 340i (B58B30A) 3.0 (12-19), (F34) 320i GT (N20B20A/B) 2.0, 335i GT (N55B30A) 3.0, 340i GT (B58B30A) 3.0 (2013-), 4-Series (F32) 420i (N20B20A/B) 2.0 Coupe, 428i (N20B20A, N26B20A) 2.0 Coupe, 430i (B46B20B, B48B20B) 2.0 Coupe, 435i (N55B30A) 3.0 Coupe, 440i (B58B30A) 3.0 Coupe (2014-), (F33) 420i (N20B20B) 2.0 Cabriolet, 428i (N20B20A, N26B20A) 2.0 Cabriolet, 430i (B48B20B) 2.0 Cabriolet, 435i (N55B30A) 3.0 Cabriolet, 440i (B58B30A) 3.0 Cabriolet (2014-), (F36) 420d (B47B20A, N47D20C) 2.0 Gran Coupe, 420i (N20B20B) 2.0 Gran Coupe, 428i (N20B20A, N26B20A) 2.0 Gran Coupe, 430i (B48B20B) 2.0 Gran Coupe, 435i (N55B30A) 3.0 Gran Coupe, 440i (B58B30A) 3.0 Gran Coupe (2014-), 5-Series (E34) 520i (M50B20) 2.0, 525i (M50B25) 2.5, 530i (M60B30) 3.0 V8, 535i (M30B35) 3.5 6-Cyl., 540i (M60B40) 4.0 Edition V8 (89-96), X1 (F48) sDrive18i (B38A15A) 1.5 Auto., sDrive20d (B47C20A/B) 2.0 Steptronic, xDrive20d (B47C20A/B) 2.0 Auto. (2015-), X2 (F39) sDrive18i (B38A15A) 1.5 7-Spd. Dual Clutch (2018-)</p>		<p>AR9363 Engine Mounting - LHS BMW 1-Series (F20, F21) 125i (B48B20B, N20B20A) 2.0 (11-19), 2-Series (F22, F23) 220i (B48B20A, N20B20A/B) 2.0 Coupe, 228i (N20B20A, N26B20A) 2.0 Coupe (14-19), 3-Series (F30, F31) 320i (N20B20A/B/D) 2.0 (12-19), (F34) 320i GT (N20B20A/B) 2.0 (2013-), 4-Series (F32) 428i (N20B20A, N26B20A) 2.0 Coupe (2014-), (F36) 420i (N20B20B) 2.0 Gran Coupe (2014-)</p>
	<p>AR9357 Exhaust Hanger - Middle BMW 1-Series (F20, F21) 116i (N13B16A) 1.6, 118i (B38B15A) 1.5, (N13B16A) 1.6, 120i (N13B16A) 1.6, (B48B20A) 2.0, 125i (B48B20B, N20B20A) 2.0, M135i (N55B30A) 3.0 (11-19), 2-Series (F22, F23) 220i (B48B20A, N20B20A/B) 2.0 Coupe, 228i (N20B20A, N26B20A) 2.0 Coupe, 230i (B46B20B, B48B20A) 2.0 Coupe (14-19), (F45) 218i Active Tourer (B38A15A) 1.5, 220d Active Tourer (B47C20A/B) 2.0, 220i Active Tourer (B48A20A/F) 2.0, 225i Active Tourer (B48A20B) 2.0 (2015-), (F46) 218i Gran Tourer (B38A15A) 1.5, 220d Gran Tourer (B47C20A/B) 2.0, 220i Gran Tourer (B48A20A) 2.0 (2015-), 3-Series (F30, F31) 316i (N13B16A) 1.6, 318i (B38A15A) 1.6, 320d (N47D20A) 2.0, 320i (B48B20A, N20B20A/B/D) 2.0, 330d (N57D30A) 3.0, 330i (B46B20A, B48B20A) 2.0, 335i (N55B30A) 3.0, 340i (B58B30A) 3.0 (12-19), (F34) 320i GT (N20B20A/B) 2.0, 335i GT (N55B30A) 3.0, 340i GT (B58B30A) 3.0 (2013-), 4-Series (F32) 420i (N20B20A/B) 2.0 Coupe, 428i (N20B20A, N26B20A) 2.0 Coupe, 430i (B46B20B, B48B20B) 2.0 Coupe, 435i (N55B30A) 3.0 Coupe, 440i (B58B30A) 3.0 Coupe (2014-), (F33) 420i (N20B20B) 2.0 Cabriolet, 428i (N20B20A, N26B20A) 2.0 Cabriolet, 430i (B48B20B) 2.0 Cabriolet, 435i (N55B30A) 3.0 Cabriolet, 440i (B58B30A) 3.0 Cabriolet (2014-), (F36) 420d (B47B20A, N47D20C) 2.0 Gran Coupe, 420i (N20B20B) 2.0 Gran Coupe, 428i (N20B20A, N26B20A) 2.0 Gran Coupe, 430i (B48B20B) 2.0 Gran Coupe, 435i (N55B30A) 3.0 Gran Coupe, 440i (B58B30A) 3.0 Gran Coupe (2014-), 5-Series (E34) 520i (M50B20) 2.0, 525i (M50B25) 2.5, 530i (M60B30) 3.0 V8, 535i (M30B35) 3.5 6-Cyl., 540i (M60B40) 4.0 Edition V8 (89-96), X1 (F48) sDrive18i (B38A15A) 1.5 Auto., sDrive20d (B47C20A/B) 2.0 Steptronic, xDrive20d (B47C20A/B) 2.0 Auto. (2015-), X2 (F39) sDrive18i (B38A15A) 1.5 7-Spd. Dual Clutch (2018-)</p>		<p>AR9364 Engine Mounting - RHS BMW 1-Series (F20, F21) 125i (B48B20B, N20B20A) 2.0 (11-19), 2-Series (F22, F23) 220i (B48B20A, N20B20A/B) 2.0 Coupe, 228i (N20B20A, N26B20A) 2.0 Coupe (14-19), 3-Series (F30, F31) 320i (N20B20A/B/D) 2.0 (12-19), (F34) 320i GT (N20B20A/B) 2.0 (2013-), 4-Series (F32) 428i (N20B20A, N26B20A) 2.0 Coupe (2014-), (F36) 420i (N20B20B) 2.0 Gran Coupe (2014-)</p>

ENGINE MOUNTING & RUBBER BUYERS GUIDE

	<p>AR9365 Propshaft Coupling</p> <p>BMW 1-Series (E82, E88) 135i (N54, N55) 3.0 Turbo (08-14), (E82) M-Coupe (N54T) 3.0 (11-12), (F20, F21) M135i (N55B30A) 3.0 (11-19), 2-Series (F22, F23) 220d (B47D20A, N47D20A) 2.0 Coupe, M235i (N55B30A) 3.0 Coupe, M240i (B58B30A) 3.0 Coupe (14-19), 3-Series (E90) 320d (N47) 2.0, 330d (N57) 3.0, 335i (N55) 3.0 (2007-), (E92) 335i (N54, N55) 3.0 (02-15), (E93) 335i (N54, N55) 3.0 (05-14), (F30, F31) 320d (N47D20A) 2.0, 330d (N57D30A) 3.0, 335i (N55B30A) 3.0, 340i (B58B30A) 3.0 (12-19), (F34) 320d GT (N47D20C) 2.0, 335i GT (N55B30A) 3.0, 340i GT (B58B30A) 3.0 (2013-), 4-Series (F32) 420d (B47B20A, N47D20C) 2.0 Coupe, 435i (N55B30A) 3.0 Coupe, 440i (B568B30A) 3.0 Coupe (2014-), (F33) 435i (N55B30A) 3.0 Cabriolet, 440i (B58B30A) 3.0 Cabriolet (2014-), (F36) 420d (B47B20A, N47D20C) 2.0 Gran Coupe, 435i (N55B30A) 3.0 Gran Coupe, 440i (B58B30A) 3.0 Gran Coupe (2014-)</p>
	<p>AR9366 Centre Bearing Rubber</p> <p>BMW 1-Series (E82, E88) 125i (N52, N54, N55) 3.0 Convertible, Coupe, 135i (N54, N55) 3.0 Turbo (08-14), (E82) M-Coupe (N54T) 3.0 (11-12), 3-Series (E90) 335i (N55) 3.0 (2007-), (E92) 335i (N54, N55) 3.0 (02-15), (E93) 335i (N54, N55) 3.0 (05-14), (F30, F31) 335i (N55B30A) 3.0, 340i (B58B30A) 3.0 (12-19), 4-Series (F32) 420d (B47B20A, N47D20C) 2.0 Coupe, 435i (N55B30A) 3.0 Coupe, 440i (B568B30A) 3.0 Coupe (2014-), (F33) 435i (N55B30A) 3.0 Cabriolet, 440i (B58B30A) 3.0 Cabriolet (2014-), (F36) 440i (B58B30A) 3.0 Gran Coupe (2014-)</p>
	<p>AR9367 Rear Stabilizer Bar Bush</p> <p>BMW 1-Series (E82, E88) 125i (N52, N54, N55) 3.0 Convertible, Coupe, 135i (N54, N55) 3.0 Turbo (08-14), 3-Series (E92) 320i (N44) 2.0, 325i (N53) 2.5, 335i (N54, N55) 3.0 (02-15) - Vehicles with M-Sport Suspension</p>
	<p>AR9368 Engine Mounting - RHS</p> <p>BMW 1-Series (E82, E88) 135i (N54, N55) 3.0 Turbo (08-14), (E82) M-Coupe (N54T) 3.0 (11-12), 3-Series (E90) 335i (N55) 3.0 (2007-), (E92) 335i (N54, N55) 3.0 (02-15), (E93) 335i (N54, N55) 3.0 (05-14)</p>
	<p>AR9369 Exhaust Hanger - Middle</p> <p>BMW 1-Series (E82) M-Coupe (N54T) 3.0 (11-12)</p>
	<p>AR9370 Front Upper Control Arm Bush - Front</p> <p>BMW 1-Series (E82) M-Coupe (N54T) 3.0 (11-12)</p>
	<p>AR9371 Front Lower Control Arm Bush - Rear</p> <p>BMW 1-Series (E82) M-Coupe (N54T) 3.0 (11-12)</p>
	<p>AR9372 Front Stabilizer Bar Bush</p> <p>BMW 1-Series (E82) M-Coupe (N54T) 3.0 (11-12)</p>
	<p>AR9373 Rear Axle Carrier Bush - Front L/RHS</p> <p>BMW 1-Series (E82) M-Coupe (N54T) 3.0 (11-12)</p>
	<p>AR9374 Rear Axle Carrier Bush - Front Centre</p> <p>BMW 1-Series (E82) M-Coupe (N54T) 3.0 (11-12)</p>

	<p>AR9375 Rear Axle Carrier Bush - Rear L/RHS</p> <p>BMW 1-Series (E82) M-Coupe (N54T) 3.0 (11-12)</p>
	<p>AR9376 Rear Axle Carrier Bush - Rear Centre</p> <p>BMW 1-Series (E82) M-Coupe (N54T) 3.0 (11-12)</p>
	<p>AR9377 Rear Stabilizer Bar Bush</p> <p>BMW 1-Series (E82) M-Coupe (N54T) 3.0 (11-12)</p>
	<p>AR9378 Front Stabilizer Bar Bush</p> <p>BMW 1-Series (F20, F21) 116i (N13B16A) 1.6, 118i (B38B15A) 1.5, (N13B16A) 1.6, 120d (B47D20A) 2.0, 120i (N13B16A) 1.6, (B48B20A) 2.0, 125i (B48B20B, N20B20A) 2.0, M135i (N55B30A) 3.0 (11-19), 2-Series (F22, F23) 220d (B47D20A) 2.0 Coupe, 220i (B48B20A, N20B20A/B) 2.0 Coupe, 228i (N20B20A, N26B20A) 2.0 Coupe, 230i (B46B20B, B48B20A) 2.0 Coupe, M235i (N55B30A) 3.0 Coupe, M240i (B58B30A) 3.0 Coupe (14-19), 3-Series (F30, F31) 316i (N13B16A) 1.6, 318i (B38A15A) 1.6, 320d (N47D20A) 2.0, 320i (B48B20A, N20B20A/B/D) 2.0, 328i (N20B20A) 2.0, 330d (N57D30A) 3.0, 330i (B46B20A, B48B20A) 2.0, 335i (N55B30A) 3.0, 340i (B58B30A) 3.0 (12-19), (F34) 320d GT (B47D20A, N47D20C) 2.0, 320i GT (N20B20A/B) 2.0, 328i GT (N20B20A, N26B20A) 2.0, 335i GT (N55B30A) 3.0, 340i GT (B58B30A) 3.0 (2013-), 4-Series (F32) 420d (B47B20A, N47D20C) 2.0 Coupe, 420i (N20B20A/B) 2.0 Coupe, 428i (N20B20A, N26B20A) 2.0 Coupe, 430i (B46B20B, B48B20B) 2.0 Coupe, 435i (N55B30A) 3.0 Coupe, 440i (B58B30A) 3.0 Coupe (2014-), (F33) 420i (N20B20B) 2.0 Cabriolet, 428i (N20B20A, N26B20A) 2.0 Cabriolet, 430i (B48B20B) 2.0 Cabriolet, 435i (N55B30A) 3.0 Cabriolet, 440i (B58B30A) 3.0 Cabriolet (2014-), (F36) 420d (B47B20A, N47D20C) 2.0 Gran Coupe, 420i (N20B20B) 2.0 Gran Coupe, 428i (N20B20A, N26B20A) 2.0 Gran Coupe, 430i (B48B20B) 2.0 Gran Coupe, 435i (N55B30A) 3.0 Gran Coupe, 440i (B58B30A) 3.0 Gran Coupe (2014-)</p>
	<p>AR9379 Exhaust Hanger</p> <p>BMW 3-Series (E92) 325i (N53) 2.5 (02-15)</p>
	<p>AR9380 Engine Mounting - L/RHS</p> <p>BMW 3-Series (E92) 325i (N53) 2.5 (02-15)</p>
	<p>AR9381 Exhaust Hanger</p> <p>BMW 3-Series (E90) 335i (N55) 3.0 (2007-), (E92) 335i (N54, N55) 3.0 (02-15), (E93) 330i (N52) 3.0, 335i (N54, N55) 3.0 (05-14)</p>
	<p>AR9382 Rear Stabilizer Bar Bush</p> <p>BMW 3-Series (E93) 330i (N52) 3.0, 335i (N54, N55) 3.0 (05-14)</p>
	<p>AR9383 Engine Mounting - LHS</p> <p>BMW 1-Series (F20, F21) M135i (N55B30A) 3.0 (11-19), 2-Series (F22, F23) M235i (N55B30A) 3.0 Coupe, M240i (B58B30A) 3.0 Coupe (14-19), 3-Series (F30, F31) 335i (N55B30A) 3.0, 340i (B58B30A) 3.0 (12-19), (F34) 335i (N55B30A) 3.0 (2013-), 4-Series (F32) 435i (N55B30A) 3.0 Coupe, 440i (B568B30A) 3.0 Coupe (2014-), (F33) 420i (N20B20B) 2.0 Cabriolet, 435i (N55B30A) 3.0 Cabriolet, 440i (B58B30A) 3.0 Cabriolet (2014-), (F36) 435i (N55B30A) 3.0 Gran Coupe, 440i (B58B30A) 3.0 Gran Coupe (2014-)</p>

ENGINE MOUNTING & RUBBER BUYERS GUIDE

	<p>AR9384 Engine Mounting - RHS</p> <p>BMW 1-Series (F20, F21) M135i (N55B30A) 3.0 (11-19), 2-Series (F22, F23) M235i (N55B30A) 3.0 Coupe, M240i (B58B30A) 3.0 Coupe (14-19), 3-Series (F30, F31) 335i (N55B30A) 3.0, 340i (B58B30A) 3.0 (12-19), (F34) 335i (N55B30A) 3.0 (2013-), 4-Series (F32) 435i (N55B30A) 3.0 Coupe, 440i (B568B30A) 3.0 Coupe (2014-), (F33) 420i (N20B20B) 2.0 Cabriolet, 435i (N55B30A) 3.0 Cabriolet, 440i (B58B30A) 3.0 Cabriolet (2014-), (F36) 435i (N55B30A) 3.0 Gran Coupe, 440i (B58B30A) 3.0 Gran Coupe (2014-)</p>		<p>AR9395 Engine Mounting - RHS</p> <p>Chevrolet Cruze (A14NET, B14NET) 1.4T LS 6-Spd. Man./Auto., (F16D4) 1.6L 5-Spd. Man., (F18D4) 1.8 L, LS, 5-Spd. Man., 6-Spd. Auto. (2012-), Orlando (J309) (F18D4) 1.8L 5-Spd. Man. MPV (2012-); Opel Astra J (A14NET) 1.4T Man., (B14NET) 1.4T Auto., GTC, (A16LET) 1.6T Sport, GTC Hatch, Cosmo Sedan, (A16XER) 1.6 Essentia Hatch, Sedan (2010-)</p>
	<p>AR9385 Transmission Mounting</p> <p>BMW 1-Series (F20, F21) M135i (N55B30A) 3.0 (11-19), 2-Series (F22, F23) M235i (N55B30A) 3.0 Coupe, M240i (B58B30A) 3.0 Coupe (14-19), 3-Series (F30, F31) 330d (N57D30A) 3.0, 335i (N55B30A) 3.0, 340i (B58B30A) 3.0 (12-19), (F34) 335i (N55B30A) 3.0 (2013-), 4-Series (F32) 435i (N55B30A) 3.0 Coupe, 440i (B568B30A) 3.0 Coupe (2014-), (F33) 420i (N20B20B) 2.0 Cabriolet, 435i (N55B30A) 3.0 Cabriolet, 440i (B58B30A) 3.0 Cabriolet (2014-), (F36) 435i (N55B30A) 3.0 Gran Coupe, 440i (B58B30A) 3.0 Gran Coupe (2014-)</p>		<p>AR9396 Engine Mounting - Front</p> <p>Chevrolet Cruze (LNP, Z20D1) 2.0D LS 6-Spd. Man. (2012-); Opel Astra J (B20NFT) 2.0T OPC (2010-)</p>
	<p>AR9386 Rear Axle Beam Bush</p> <p>Chevrolet Aveo (T200) (F15S, LX6) 1.5 L, LS, LT, (A16DMS, LXV) 1.6 LT (03-15), Sonic (LSF) 1.3D, (A14XER) 1.4, (F16D4) 1.6 (11-16), Spark, Spark Lite (M200, M250) (F8CV) 0.8 L, LS, (B10S1) 1.0 LS, LT (2005-)</p>		<p>AR9397 Engine Mounting - Rear</p> <p>Chevrolet Spark, Spark Lite (M200, M250) (F8CV) 0.8 L, LS, (B10S1) 1.0 LS, LT (2005-)</p>
	<p>AR9387 Front Axle Beam Bush - Front</p> <p>Chevrolet Aveo (T200) (F15S, LX6) 1.5 L, LS, LT, (A16DMS, LXV) 1.6 LT (03-15), Sonic (LSF) 1.3D, (A14XER) 1.4, (F16D4) 1.6 (11-16)</p>		<p>AR9398 Front Lower Control Arm Bush - Outer</p> <p>Chevrolet Spark (M150) (F8CV) 0.8 L, LS, (B10S1) 1.0 LS, LT (03-05), Spark, Spark Lite (M200, M250) (F8CV) 0.8 L, LS, (B10S1) 1.0 LS, LT (2005-)</p> <p>ID: 10, OD: 28.5, L: 52</p>
	<p>AR9388 Front Axle Beam Bush - Rear</p> <p>Chevrolet Aveo (T200) (F15S, LX6) 1.5 L, LS, LT, (A16DMS, LXV) 1.6 LT (03-15), Sonic (LSF) 1.3D, (A14XER) 1.4, (F16D4) 1.6 (11-16)</p>		<p>AR9399 Rear Axle Beam Bush</p> <p>Citroen Berlingo (TU5JP4B) 1.6, (DV6TED4BU, DV6AUTED4) 1.6 HDi 90 16V (2011-) - Standard Suspension</p>
	<p>AR9389 Front Stabilizer Bar Bush</p> <p>Chevrolet Aveo (T200) (F15S, LX6) 1.5 L, LS, LT, (A16DMS, LXV) 1.6 LT (03-15), Sonic (LSF) 1.3D, (A14XER) 1.4, (F16D4) 1.6 (11-16)</p> <p>ID: 16</p>		<p>AR9400 Rear Axle Beam Bush</p> <p>Citroen Berlingo (TU5JP4B) 1.6, (DV6TED4BU, DV6AUTED4) 1.6 HDi 90 16V (2011-) - Heavy Duty Suspension; Peugeot Partner 1.6 HDi (08-18)</p>
	<p>AR9390 Rear Axle Beam Bush - Front</p> <p>Chevrolet Captiva 4X2, 4X4 (Z20S) 2.0D LTZ, (Z24SED) 2.4 LT, (10HM) 3.2 LTZ (07-11), 2.2D LTZ 5-dr Dsl. AWD AT, (LNQ) 2.2D LT 5-dr Dsl. AT, (LE5) 2.4 LT, LS 5-dr, 3.0 LTZ 5-dr AWD AT (11-17)</p>		<p>AR9401 Front Stabilizer Bar Bush</p> <p>Citroen Berlingo (TU5JP4B) 1.6, (DV6TED4BU, DV6AUTED4) 1.6 HDi 90 16V (2011-); Peugeot Partner 1.6 HDi (08-18)</p> <p>ID: 21</p>
	<p>AR9391 Rear Axle Beam Bush - Rear</p> <p>Chevrolet Captiva 4X2, 4X4 (Z20S) 2.0D LTZ, (Z24SED) 2.4 LT, (10HM) 3.2 LTZ (07-11), 2.2D LTZ 5-dr Dsl. AWD AT, (LNQ) 2.2D LT 5-dr Dsl. AT, (LE5) 2.4 LT, LS 5-dr, 3.0 LTZ 5-dr AWD AT (11-17)</p>		<p>AR9402 Front Stabilizer Bar Bush</p> <p>Citroen Berlingo (TU5JP4B) 1.6, (DV6TED4BU, DV6AUTED4) 1.6 HDi 90 16V (2011-); Peugeot Partner 1.6 HDi (08-18)</p> <p>ID: 25</p>
	<p>AR9392 Centre Bearing Rubber</p> <p>Chevrolet Captiva 4X2, 4X4 (Z20S) 2.0D LTZ, (Z24SED) 2.4 LT, (10HM) 3.2 LTZ (07-11), 2.2D LTZ 5-dr Dsl. AWD AT, (LNQ) 2.2D LT 5-dr Dsl. AT, (LE5) 2.4 LT, LS 5-dr, 3.0 LTZ 5-dr AWD AT (11-17)</p>		<p>AR9403 Front Stabilizer Bar Bush</p> <p>Citroen Berlingo (TU5JP4B) 1.6, (DV6TED4BU, DV6AUTED4) 1.6 HDi 90 16V (2011-); Peugeot Partner 1.6 HDi (08-18)</p> <p>ID: 23</p>
	<p>AR9393 Engine Mounting - Rear</p> <p>Chevrolet Captiva 4X2, 4X4 (Z20S) 2.0D LTZ, (Z24SED) 2.4 LT (07-11)</p>		<p>AR9404 Front Stabilizer Link Pin Kit - Complete</p> <p>Citroen C1 (1KR-FE) 1.0, (1KR-FE) 1.0i (2007-); Peugeot 107 (1KR-FE) 1.0 XR, XR+, X-Line, Urban, Trendy (06-16); Toyota Aygo (1KR-FE) 1.0 Fresh, Wild, Hatch (2011-), Etios (2NR-FE) 1.5 Xi, 1.5 Xs Cross (2012-), Yaris (1KR-FE) 1.0 T1, Zen1 Hatch, (2SZ-FE) 1.3 T3, Zen3, '+', Spirit Hatch, Sedan Man./Auto. (05-10), (2NZ-FE) 1.3 Zen3 (10-13), (1KR-FE) 1.0, (1NR-FE) 1.3 CVT, 6-Spd., (1NR-ZFXE) 1.5 Hybrid (10-14)</p>
	<p>AR9394 Engine Mounting - Rear</p> <p>Chevrolet Cruze (A14NET, B14NET) 1.4T LS 6-Spd. Man./Auto., (F16D4) 1.6L 5-Spd. Man., (F18D4) 1.8 L, LS 5-Spd. Man., 6-Spd. Auto., (LLW, Z20S1) 2.0D L 5-Spd. Man., (LNP, Z20D1) 2.0D LS, LT 6-Spd. Man./Auto. (2012-), Orlando (J309) (F18D4) 1.8L 5-Spd. Man. MPV (2012-); Opel Astra J (A14NET) 1.4T Man., (B14NET) 1.4T Auto., GTC, (A16LET) 1.6T Sport, GTC Hatch, Cosmo Sedan, (A16XER) 1.6 Essentia Hatch, Sedan, (B20NFT) 2.0T OPC (2010-)</p>		<p>AR9405 Rear Axle Beam Bush</p> <p>Citroen C2 (TU3JP) 1.4i VTR, (DV4TD) 1.4 HDi, (TU5J4S) 1.6 VTS (02-10)</p>
			<p>AR9406 Front Stabilizer Bar Bush</p> <p>Citroen C2 (TU3JP) 1.4i VTR, (DV4TD) 1.4 HDi, (TU5J4S) 1.6 VTS (02-10)</p>

ENGINE MOUNTING & RUBBER BUYERS GUIDE

379

	AR9407 Engine Mounting - RHS Citroen C2 (TU3JP) 1.4i VTR, (DV4TD) 1.4 HDi (02-10)
 ID: 25	AR9408 Front Stabilizer Bar Bush Daihatsu Materia (3S2-VE) 1.5i (07-11), Sirion (K3-VE) 1.3 CX, (3S2-VE) 1.5i Sport (02-14), Terios 4X2, 4X4 (K3-VE) 1.3, (3S2-VE) 1.5i (02-15)
 ID: 16	AR9409 Rear Stabilizer Bar Bush Daihatsu Materia (3S2-VE) 1.5i (07-11), Sirion (K3-VE) 1.3 CX, (3S2-VE) 1.5i Sport (02-14), Terios 4X2, 4X4 (K3-VE) 1.3, (3S2-VE) 1.5i (02-15)
	AR9410 Rear Axle Beam Bush Daihatsu Materia (3S2-VE) 1.5i (07-11), Sirion (K3-VE) 1.3 CX, (3S2-VE) 1.5i Sport (02-14), Terios 4X2, 4X4 (K3-VE) 1.3, (3S2-VE) 1.5i (02-15)
 NO PICTURE AVAILABLE AT TIME OF PRINT	AR9411 Exhaust Hanger Daihatsu Materia (3S2-VE) 1.5i (07-11), Sirion (K3-VE) 1.3 CX, (3S2-VE) 1.5i Sport (02-14), Terios 4X2, 4X4 (K3-VE) 1.3, (3S2-VE) 1.5i (02-15)
	AR9412 Engine Mounting - RHS Peugeot 208 (EBO) 1.0 VTi ZMZ, (EB2F) 1.2 VTi HMZ, (EP6C) 1.6 VTi 5FS, (DV6DTE) 1.6 HDi 9HP, (DV6CTED) 1.6 HDi 9HD, 1.6 GTi (2012-)
	AR9413 Transmission Mounting Peugeot 208 (EBO) 1.0 VTi ZMZ, (EB2F) 1.2 VTi HMZ (2012-)
 ID: 12, OD: 72, L: 82.5	AR9414 Rear Axle Beam Bush Peugeot 208 (EBO) 1.0 VTi ZMZ, (EB2F) 1.2 VTi HMZ, (EP6C) 1.6 VTi 5FS, (DV6DTE) 1.6 HDi 9HP, (DV6CTED) 1.6 HDi 9HD, 1.6 GTi (2012-)
 ID: 14, OD: 56.5, L: 48	AR9415 Front Lower Control Arm Bush - Inner Front Peugeot 208 (EBO) 1.0 VTi ZMZ, (EB2F) 1.2 VTi HMZ, (EP6C) 1.6 VTi 5FS, (DV6DTE) 1.6 HDi 9HP, (DV6CTED) 1.6 HDi 9HD, 1.6 GTi (2012-)
 ID: 14, OD: 56, L: 48	AR9416 Front Lower Control Arm Bush - Outer Rear Peugeot 208 (EBO) 1.0 VTi ZMZ, (EB2F) 1.2 VTi HMZ, (EP6C) 1.6 VTi 5FS, (DV6DTE) 1.6 HDi 9HP, (DV6CTED) 1.6 HDi 9HD, 1.6 GTi (2012-)
	AR9417 Transmission Mounting Peugeot 208 (EP6C) 1.6 VTi 5FS, (DV6DTE) 1.6 HDi 9HP, (DV6CTED) 1.6 HDi 9HD, 1.6 GTi (2012-)
	AR9418 Engine Mounting - RHS Citroen C4 Aircross (9HD-DV6C) 1.6 HDi 115 (2010-); Peugeot 308 (EP6-DT/CDTX, DV6TED4) 1.6i, VTi, THP X-Line, XS, XT, CC, SW, Comfort, Premium, GTi (2008-), 3008 (EP6-DT) 1.6i Exec., VTi Comfort, THP Premium (2010-), Partner (TU5JP4) 1.6 NFU, (TU5JP4B) 1.6 NFR, (DV6ATED4) 1.6 HDi 9HX, (DV6TED4BU) 1.6 9HS (2009-)

 ID: 19, OD: 38, L: 65	AR9419 Front Lower Control Arm Bush - Inner Front Peugeot Boxer (4H4) 2.2 HDi Delivery Van Dies., (DJ5TED) 2.5 TDi Delivery Van Dies. (06-09), (P22DTE) 2.2 HDi "120" 4HU, (P22DTE) 2.2 HDi "130" 4HH, (F1CE0481D, F30DT) 3.0 HDi "130" (2007-)
 ID: 19, OD: 75, L: 76	AR9420 Front Lower Control Arm Bush - Outer Rear Peugeot Boxer (4H4) 2.2 HDi Delivery Van Dies., (DJ5TED) 2.5 TDi Delivery Van Dies. (06-09), (P22DTE) 2.2 HDi "120" 4HU, (P22DTE) 2.2 HDi "130" 4HH, (F1CE0481D, F30DT) 3.0 HDi "130" (2007-)
	AR9421 Engine Mounting - Rear Peugeot Boxer (P22DTE) 2.2 HDi "120" 4HU, (P22DTE) 2.2 HDi "130" 4HH (2007-)
	AR9422 Exhaust Hanger - Middle Peugeot Boxer (P22DTE) 2.2 HDi "120" 4HU, (P22DTE) 2.2 HDi "130" 4HH, (F1CE0481D, F30DT) 3.0 HDi "130" (2007-)
	AR9423 Engine Mounting - Front Mitsubishi ASX (4B11) 2.0 (2011-), Lancer (4A91) 1.5, (4G18) 1.6 (03-10), Outlander 4X4 (4B12) 2.4 (07-14)
	AR9424 Engine Mounting - Rear Mitsubishi ASX (4B11) 2.0 (2011-), Lancer (4A91) 1.5, (4G18) 1.6 (03-10)
	AR9425 Front Stabilizer Bar Bush Volvo V40 (D4162T) 1.6 D2, (B4164T3) 1.6 T3, (B4164T) 1.6 T4, (D5204T6) 2.0 D3, (D5204T4) 2.0 D4 Cross Country, (B5254T12) 2.5 T5 (2012-)
	AR9426 Transmission Mounting Citroen C4 Aircross (4B11) 2.0 (2010-); Mitsubishi ASX (4B11) 2.0 (2011-), Lancer (4A91) 1.5, (4G18) 1.6 (03-10), Outlander 4X4 (4B12) 2.4 (07-14)
	AR9427 Engine Mounting - Front Dodge Caliber (EBA) 1.8, (ECN) 2.0, (ECE) 2.0 CRD, (ED3) 2.4 (06-12); Jeep Compass 4X4 (ECD, ECE) 2.0 CRD, (ECN) 2.0, (ED3, ER2) 2.4 CRD (07-09), Patriot (MK74) 4X4 (ECD, ECE) 2.0 CRD, (ED3) 2.4 (2007-)
	AR9428 Engine Mounting - Rear Dodge Caliber (EBA) 1.8, (ECN) 2.0, (ECE) 2.0 CRD, (ED3) 2.4 (06-12); Jeep Compass 4X4 (ECD, ECE) 2.0 CRD, (ECN) 2.0, (ED3, ER2) 2.4 CRD (07-09), Patriot (MK74) 4X4 (ECD, ECE) 2.0 CRD, (ED3) 2.4 (2007-)
	AR9429 Engine Mounting - LHS Dodge Caliber (EBA) 1.8, (ECN) 2.0, (ECE) 2.0 CRD, (ED3) 2.4 (06-12); Jeep Compass 4X4 (ECD, ECE) 2.0 CRD, (ECN) 2.0, (ED3, ER2) 2.4 CRD (07-09), Patriot (MK74) 4X4 (ECD, ECE) 2.0 CRD, (ED3) 2.4 (2007-)
	AR9430 Engine Mounting - RHS Dodge Caliber (EBA) 1.8, (ECN) 2.0, (ECE) 2.0 CRD, (ED3) 2.4 (06-12); Jeep Compass 4X4 (ECD, ECE) 2.0 CRD, (ECN) 2.0, (ED3, ER2) 2.4 CRD (07-09), Patriot (MK74) 4X4 (ECD, ECE) 2.0 CRD, (ED3) 2.4 (2007-); Mitsubishi ASX (4B11) 2.0 (2011-), Lancer (4A91) 1.5, (4G18) 1.6 (03-10), Outlander 4X4 (4B12) 2.4 (07-14)

ENGINE MOUNTING & RUBBER BUYERS GUIDE

	AR9433 Front Strut Mounting Dodge Caliber (EBA) 1.8, (ECN) 2.0, (ECE) 2.0 CRD, (ED3) 2.4 (06-12); Jeep Compass 4X4 (ECD, ECE) 2.0 CRD, (ECN) 2.0, (ED3, ER2) 2.4 CRD (07-09), Patriot (MK74) 4X4 (ECD, ECE) 2.0 CRD, (ED3) 2.4 (2007-)		AR9446 Front Stabilizer Bar Bush Honda Accord (R20A3) 2.0i V-TEC, (N22B1) 2.2i D-TEC, Tourer, Exec., (K24Z3) 2.4i V-TEC, Tourer, Exec. (08-15)
	AR9434 Front Stabilizer Bar Bush Dodge Caliber (EBA) 1.8, (ECN) 2.0, (ECE) 2.0 CRD, (ED3) 2.4 (06-12); Jeep Compass 4X4 (ECD, ECE) 2.0 CRD, (ED3, ER2) 2.4 CRD (07-09)		AR9447 Rear Stabilizer Bar Bush Honda Accord (R20A3) 2.0i V-TEC, (N22B1) 2.2i D-TEC, Tourer, Exec., (K24Z3) 2.4i V-TEC, Tourer, Exec. (08-15)
	AR9435 Rear Stabilizer Bar Bush Dodge Caliber (EBA) 1.8, (ECN) 2.0, (ECE) 2.0 CRD, (ED3) 2.4 (06-12); Jeep Compass 4X4 (ECD, ECE) 2.0 CRD, (ECN) 2.0, (ED3, ER2) 2.4 CRD (07-09), Patriot (MK74) 4X4 (ECD, ECE) 2.0 CRD, (ED3) 2.4 (2007-)		AR9448 Engine Mounting - Rear Honda Ballade (L15A7) 1.5 i-VTEC 5-Spd. Man. (2011-), Brio (L12B1) 1.2 5-Spd. Man. (2012-), Jazz (GE) (L13Z1) 1.3 5-Spd. Man., (L13Z1) 1.4i 5-Spd. Man., (L15A7) 1.5i 5-Spd. Man. (08-14)
	AR9436 Centre Bearing Rubber Dodge Caliber (EBA) 1.8, (ECN) 2.0, (ECE) 2.0 CRD, (ED3) 2.4 (06-12); Jeep Compass 4X4 (ECD, ECE) 2.0 CRD, (ECN) 2.0, (ED3, ER2) 2.4 CRD (07-09), Patriot (MK74) 4X4 (ECD, ECE) 2.0 CRD, (ED3) 2.4 (2007-)		AR9449 Engine Mounting - RHS Honda Ballade (L15A7) 1.5 i-VTEC (2011-), Brio (L12B1) 1.2 (2012-), Jazz (GE) (L13Z1) 1.3 5-Spd. Man., CVT, (L13Z1) 1.4i 5-Spd. Man./Auto., (L15A7) 1.5i 5-Spd. Man./Auto. (08-14), Jazz (GK) (L13Z1) 1.3, (L15A3) 1.5i (2015-)
	AR9437 Front Lower Control Arm Bush - Inner Front Dodge Journey (ECE) 2.0 CRD, (ED3) 2.4, (EER) 2.7 V6, (ERB) 3.6 V6 (2008-)		AR9450 Transmission Mounting Honda Ballade (L15A7) 1.5 i-VTEC (2011-), Brio (L12B1) 1.2 (2012-), Jazz (GE) (L13Z1) 1.3 5-Spd. Man., CVT, (L13Z1) 1.4i 5-Spd. Man./Auto., (L15A7) 1.5i 5-Spd. Man./Auto. (08-14), Jazz (GK) (L13Z1) 1.3, (L15A3) 1.5i (2015-)
	AR9438 Front Lower Control Arm Bush - Outer Rear Dodge Journey (ECE) 2.0 CRD, (ED3) 2.4, (EER) 2.7 V6, (ERB) 3.6 V6 (2008-)		AR9451 Engine Mounting - Front Honda Civic VIII (R18A2) 1.8i VXi 6-Spd. Man (06-11)
	AR9439 Front Strut Mounting Dodge Journey (ECE) 2.0 CRD, (ED3) 2.4, (EER) 2.7 V6, (ERB) 3.6 V6 (2008-)		AR9452 Engine Mounting - Rear Honda Civic VIII (R18A2) 1.8i VXi 6-Spd. Man (06-11)
	AR9440 Rear Subframe Bush - Upper L/RHS Honda Accord (K20A6) 2.0i, (K24A3) 2.4i VTEC, Tourer, Exec. (03-08)		AR9453 Engine Mounting - RHS Honda Civic VIII (R18A2) 1.8i VXi 6-Spd. Man (06-11)
	AR9441 Rear Subframe Bush - Lower Front Honda Accord (K20A6) 2.0i, (K24A3) 2.4i VTEC, Tourer, Exec. (03-08)		AR9454 Transmission Mounting Honda Civic VIII (R18A2) 1.8i VXi 6-Spd. Man (06-11)
	AR9442 Rear Subframe Bush - Lower Rear Honda Accord (K20A6) 2.0i, (K24A3) 2.4i VTEC, Tourer, Exec. (03-08)		AR9455 Front Lower Control Arm Bush - Inner Front Honda Civic (N16A1) 1.6 i-VTEC, (R18Z4) 1.8 i-VTEC (2012-) ID: 14, OD: 67, L: 37
	AR9443 Engine Mounting - Rear Honda Accord (R20A3) 2.0i V-TEC, (N22B1) 2.2i D-TEC, Tourer, Exec., (K24Z3) 2.4i V-TEC, Tourer, Exec. (08-15)		AR9456 Front Lower Control Arm Bush - Outer Rear Honda Civic (N16A1) 1.6 i-VTEC, (R18Z4) 1.8 i-VTEC (2012-)
	AR9444 Engine Mounting - LHS Honda Accord (R20A3) 2.0i V-TEC, (N22B1) 2.2i D-TEC, Tourer, Exec., (K24Z3) 2.4i V-TEC, Tourer, Exec. (08-15)		AR9457 Front Stabilizer Bar Bush Honda Civic (N16A1) 1.6 i-VTEC, (R18Z4) 1.8 i-VTEC (2012-) ID: 21
	AR9445 Engine Mounting - RHS Honda Accord (R20A3) 2.0i V-TEC, (N22B1) 2.2i D-TEC, Tourer, Exec., (K24Z3) 2.4i V-TEC, Tourer, Exec. (08-15)		AR9458 Front Stabilizer Bar Bush Honda Civic (N16A1) 1.6 i-VTEC, (R18Z4) 1.8 i-VTEC (2012-) ID: 22

ENGINE MOUNTING & RUBBER BUYERS GUIDE

 ID: 24	AR9459 Front Stabilizer Bar Bush Honda Civic (N16A1) 1.6 i-VTEC, (R18Z4) 1.8 i-VTEC (2012-)		AR9469 Front Stabilizer Bar Bush - LHS Honda CR-V III 4X4 (R20A1) 2.0i SWB SUV, (N22A2) 2.2 CTDi SWB SUV, (N22B3) 2.2 i-DTEC, (K24Z1/4) 2.4i V-TEC SWB SUV (09-12)
 ID: 9, OD: 19.7, W: 29	AR9460 Rear Stabilizer Bar Bush Honda Civic (N16A1) 1.6 i-VTEC, (R18Z4) 1.8 i-VTEC (2012-)		AR9470 Front Stabilizer Bar Bush - RHS Honda CR-V III 4X4 (R20A1) 2.0i SWB SUV, (N22A2) 2.2 CTDi SWB SUV, (N22B3) 2.2 i-DTEC, (K24Z1/4) 2.4i V-TEC SWB SUV (09-12)
	AR9461 Engine Mounting - Rear Honda CR-V III 4X4 (R20A1) 2.0 RVSi 5-Spd. Auto., (K24Z4) 2.4 5-Spd. Auto. (07-12)		AR9471 Centre Bearing Rubber Honda CR-V III 4X4 (N22A2) 2.2 CTDi SWB SUV (09-12)
	AR9462 Engine Mounting - LHS Honda CR-V III 4X4 (R20A1) 2.0 RVSi 5-Spd. Auto., (K24Z4) 2.4 5-Spd. Auto. (07-12)		AR9472 Centre Bearing Rubber Honda CR-V III 4X4 (N22B3) 2.2 i-DTEC (09-12)
	AR9463 Engine Mounting - RHS Honda CR-V III 4X4 (R20A1) 2.0 5-Spd. Auto., 6-Spd. Man., (K24Z4) 2.4 5-Spd. Auto., 6-Spd. Man. (07-12)		AR9473 Exhaust Hanger - Middle Honda Jazz (GE) (L13Z1) 1.4i, (L15A3) 1.5i (08-14), Jazz (GK) (L13Z1) 1.3, (LDA3) 1.3 CVT Hybrid, (L15A3) 1.5i (2015-)
	AR9464L Front Lower Control Arm Bush - Outer Rear LHS Ford Focus III (PNDA) 1.6i, (MGDA) 2.0 TDCi, GDi, GTDi, (R9DA) ST1, ST3 (11-15), Kuga 4X2, 4X4 (JQMB, JQMA) 1.6 Ecoboost, Ambiente, (JTMA) 1.6 Ecoboost Titanium, Trend, (TXDA, TXMA) 2.0 TDCi Titanium, Trend AWD Powershift, (TXDB) 2.5 Turbo, Titanium, Trend AWD (2011-); Mazda 3 (BK, BL) (B6ZE, Z6) 1.6 Original, Active, Dynamic, (LF17) 2.0 Dynamic, Individual, (L3KG) 2.3 Individual MPS, (L5-VE) 2.5 (04-14); Volvo V40 (D4162T) 1.6 D2, (B4164T3) 1.6 T3, (B4164T) 1.6 T4, (D5204T6) 2.0 D3, (D5204T4) 2.0 D4 Cross Country, (B5254T12) 2.5 T5 (2012-)		AR9474 Exhaust Hanger - Rear Honda Jazz (GE) (L13Z1) 1.4i, (L15A3) 1.5i (08-14), Jazz (GK) (L13Z1) 1.3, (LDA3) 1.3 CVT Hybrid, (L15A3) 1.5i (2015-)
	AR9464R Front Lower Control Arm Bush - Outer Rear RHS Ford Focus III (PNDA) 1.6i, (MGDA) 2.0 TDCi, GDi, GTDi, (R9DA) ST1, ST3 (11-15), Kuga 4X2, 4X4 (JQMB, JQMA) 1.6 Ecoboost, Ambiente, (JTMA) 1.6 Ecoboost Titanium, Trend, (TXDA, TXMA) 2.0 TDCi Titanium, Trend AWD Powershift, (TXDB) 2.5 Turbo, Titanium, Trend AWD (2011-); Mazda 3 (BK, BL) (B6ZE, Z6) 1.6 Original, Active, Dynamic, (LF17) 2.0 Dynamic, Individual, (L3KG) 2.3 Individual MPS, (L5-VE) 2.5 (04-14); Volvo V40 (D4162T) 1.6 D2, (B4164T3) 1.6 T3, (B4164T) 1.6 T4, (D5204T6) 2.0 D3, (D5204T4) 2.0 D4 Cross Country, (B5254T12) 2.5 T5 (2012-)	 ID: 30	AR9475 Front Stabilizer Bar Bush Jeep Cherokee (KJ) 4X4 (EDI) 2.4, (R425) 2.5 CRD, (ENR) 2.8 CRD, (EKG) 3.7 CRD (02-08)
	AR9465 Centre Bearing Rubber Honda CR-V III 4X4 (R20A1) 2.0i SWB SUV (09-12)		AR9476 Front Stabilizer Link Jeep Cherokee (KJ) 4X4 (EDI) 2.4, (R425) 2.5 CRD, (ENR) 2.8 CRD, (EKG) 3.7 CRD (02-08)
	AR9466 Front Strut Mounting Honda CR-V III 4X4 (R20A1) 2.0i SWB SUV, (N22A2) 2.2 CTDi SWB SUV, (N22B3) 2.2 i-DTEC, (K24Z1/4) 2.4i V-TEC SWB SUV (09-12)		AR9477L Front Strut Mounting Jeep Cherokee (KJ) 4X4 (EDI) 2.4, (R425) 2.5 CRD, (ENR) 2.8 CRD, (EKG) 3.7 CRD (02-08)
	AR9467 Rear Strut Mounting Honda CR-V III 4X4 (R20A1) 2.0i SWB SUV, (N22A2) 2.2 CTDi SWB SUV, (N22B3) 2.2 i-DTEC, (K24Z1/4) 2.4i V-TEC SWB SUV (09-12)		AR9477R Front Strut Mounting Jeep Cherokee (KJ) 4X4 (EDI) 2.4, (R425) 2.5 CRD, (ENR) 2.8 CRD, (EKG) 3.7 CRD (02-08)
	AR9468 Centre Bearing Rubber Honda CR-V III 4X4 (K24Z1/4) 2.4i V-TEC SWB SUV (09-12)		AR9478 Front Upper Control Arm Bush - Inner Front & Rear Jeep Cherokee (KJ) 4X4 (EDI) 2.4, (R425) 2.5 CRD, (ENR) 2.8 CRD, (EKG) 3.7 CRD (02-08)
	AR9468 Centre Bearing Rubber Honda CR-V III 4X4 (K24Z1/4) 2.4i V-TEC SWB SUV (09-12)		AR9479 Front Lower Control Arm Bush - Inner Front & Rear Jeep Cherokee (KJ) 4X4 (EDI) 2.4, (R425) 2.5 CRD, (ENR) 2.8 CRD, (EKG) 3.7 CRD (02-08)
	AR9468 Centre Bearing Rubber Honda CR-V III 4X4 (K24Z1/4) 2.4i V-TEC SWB SUV (09-12)		AR9480 Front Lower Control Arm Bush - Outer Centre Jeep Cherokee (KJ) 4X4 (EDI) 2.4, (R425) 2.5 CRD, (ENR) 2.8 CRD, (EKG) 3.7 CRD (02-08)











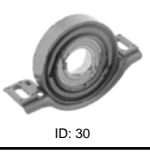









ENGINE MOUNTING & RUBBER BUYERS GUIDE

 ID: 14	AR9481 Rear Stabilizer Bar Bush Jeep Cherokee (KJ) 4X4 (EDI) 2.4, (R425) 2.5 CRD, (ENR) 2.8 CRD, (EKG) 3.7 CRD (02-08)
	AR9482 Front Stabilizer Link Dodge Nitro 4X4 (ENS) 2.8 CRD, (EKG) 3.7 (07-10); Jeep Cherokee (KK) 4X4 (ENS) 2.8 CRD, (EKG) 3.7 CRD (2008-)
 ID: 12, OD: 46, L: 51	AR9483 Front Upper Control Arm Bush - Inner Front & Rear Dodge Nitro 4X4 (ENS) 2.8 CRD, (EKG) 3.7 (07-10); Jeep Cherokee (KK) 4X4 (ENS) 2.8 CRD, (EKG) 3.7 CRD (2008-), Grand Cherokee 4X4 (EXL) 3.0 CRD, (EKG) 3.7 V6, (EVA) 4.7 V8, (EZB) 5.7 V8 (05-13)
 ID: 16, OD: 55, L: 80	AR9484 Front Lower Control Arm Bush - Inner Front Dodge Nitro 4X4 (ENS) 2.8 CRD, (EKG) 3.7 (07-10); Jeep Cherokee (KK) 4X4 (ENS) 2.8 CRD, (EKG) 3.7 CRD (2008-), Grand Cherokee 4X4 (EXL) 3.0 CRD, (EKG) 3.7 V6, (EVA) 4.7 V8, (EZB) 5.7 V8 (05-13)
	AR9485 Front Lower Control Arm Bush - Inner Rear Dodge Nitro 4X4 (ENS) 2.8 CRD, (EKG) 3.7 (07-10); Jeep Cherokee (KK) 4X4 (ENS) 2.8 CRD, (EKG) 3.7 CRD (2008-), Grand Cherokee 4X4 (EXL) 3.0 CRD, (EKG) 3.7 V6, (EVA) 4.7 V8, (EZB) 5.7 V8 (05-13)
	AR9486 Front Lower Control Arm Bush - Outer Centre Dodge Nitro 4X4 (ENS) 2.8 CRD, (EKG) 3.7 (07-10); Jeep Cherokee (KK) 4X4 (ENS) 2.8 CRD, (EKG) 3.7 CRD (2008-), Grand Cherokee 4X4 (EXL) 3.0 CRD, (EKG) 3.7 V6, (EVA) 4.7 V8, (EZB) 5.7 V8 (05-13)
 ID: 31	AR9487 Front Stabilizer Bar Bush Dodge Nitro 4X4 (ENS) 2.8 CRD, (EKG) 3.7 (07-10); Jeep Cherokee (KK) 4X4 (ENS) 2.8 CRD, (EKG) 3.7 CRD (2008-)
 ID: 20	AR9488 Rear Stabilizer Bar Bush Jeep Cherokee (KK) 4X4 (ENS) 2.8 CRD, (EKG) 3.7 CRD (2008-), Grand Cherokee (WG, WJ) 4X4 (ENF) 2.7 CRD, (EVA, EVC) 4.7 V8 (02-05), Grand Cherokee 4X4 (EXL) 3.0 CRD, (EKG) 3.7 V6, (EVA) 4.7 V8, (EZB) 5.7 V8 (05-13)
	AR9489 Front Strut Mounting Jeep Grand Cherokee (WG, WJ) 4X4 (ENF) 2.7 CRD, (EVA, EVC) 4.7 V8 (02-05), Grand Cherokee 4X4 (EXL) 3.0 CRD, (EKG) 3.7 V6, (EVA) 4.7 V8, (EZB) 5.7 V8 (05-13)
	AR9490 Engine Mounting - LHS Jeep Grand Cherokee (WG, WJ) 4X4 (ENF) 2.7 CRD, (EVA, EVC) 4.7 V8 (02-05)
	AR9491 Engine Mounting - RHS Jeep Grand Cherokee (WG, WJ) 4X4 (ENF) 2.7 CRD, (EVA, EVC) 4.7 V8 (02-05)
	AR9492 Transmission Mounting Jeep Grand Cherokee (WG, WJ) 4X4 (ENF) 2.7 CRD, (EVA, EVC) 4.7 V8 (02-05)

 ID: 28	AR9493 Front Stabilizer Bar Bush Jeep Grand Cherokee (WG, WJ) 4X4 (ENF) 2.7 CRD, (EVA, EVC) 4.7 V8 (02-05)
	AR9494 Front Stabilizer Link Jeep Grand Cherokee (WG, WJ) 4X4 (ENF) 2.7 CRD, (EVA, EVC) 4.7 V8 (02-05)
	AR9495 Rear Stabilizer Link Jeep Grand Cherokee (WG, WJ) 4X4 (ENF) 2.7 CRD, (EVA, EVC) 4.7 V8 (02-05)
	AR9498 Front Upper Control Arm Bush - Inner Front & Rear Jeep Grand Cherokee IV 4X4 (ERB) 3.6 V6, (EZH) 5.7 V8 (2011-); Mercedes-Benz (W163) ML-Class (OM642.940) ML320 CDi SUV, (M272.967) ML350 SUV, (M273.963) ML500 SUV, (M156.980) ML63 AMG SUV (2006-)
	AR9501 Front Lower Control Arm Bush - Outer Centre Jeep Grand Cherokee IV 4X4 (ERB) 3.6 V6, (EZH) 5.7 V8 (2011-); Mercedes-Benz (W163) ML-Class (OM642.940) ML320 CDi SUV, (M272.967) ML350 SUV, (M273.963) ML500 SUV, (M156.980) ML63 AMG SUV (2006-)
	AR9502 Front Stabilizer Bar Bush Jeep Wrangler 4X4 (ENS) 2.8 CRD, (SO1) 4.0 (2002-)
	AR9503 Rear Stabilizer Bar Bush Jeep Wrangler 4X4 (ENS) 2.8 CRD, (SO1) 4.0 (2002-)
	AR9504 Front Stabilizer Link Jeep Wrangler 4X4 (ENS) 2.8 CRD, (SO1) 4.0 (2002-)
	AR9505 Rear Stabilizer Link Jeep Wrangler 4X4 (ENS) 2.8 CRD, (SO1) 4.0 (2002-)
	AR9506 Transmission Mounting Mercedes-Benz (W176) A-Class (M270.910) A180, (OM651.901) A180 CDi, (OM607.951) A180 CDi, (M270.910) A200, (OM651.930) A220 CDi, (M270.920) A250 (2013-), (W242, W246) B-Class (M270.910) B180, (OM651.901) B180 CDi, (M270.910) B200, (OM651.901) B200 CDi, (M270.920) B250 (2012-)
	AR9507 Transmission Mounting Mercedes-Benz (W176) A-Class (M270.910) A180, (OM651.901) A180 CDi, (OM607.951) A180 CDi, (M270.910) A200, (OM651.930) A220 CDi, (M270.920) A250 (2013-), (W242, W246) B-Class (M270.910) B180, (OM651.901) B180 CDi, (M270.910) B200, (OM651.901) B200 CDi, (M270.920) B250 (2012-)
	AR9508 Engine Mounting - Rear LHS Mercedes-Benz (W176) A-Class (M270.910) A180, (OM651.901) A180 CDi, (OM607.951) A180 CDi, (M270.910) A200, (OM651.930) A220 CDi, (M270.920) A250 (2013-), (W242, W246) B-Class (M270.910) B180, (OM651.901) B180 CDi, (M270.910) B200, (OM651.901) B200 CDi, (M270.920) B250 (2012-)

ENGINE MOUNTING & RUBBER BUYERS GUIDE

383

	<p>AR9509 Engine Mounting - Rear RHS</p> <p>Mercedes-Benz (W176) A-Class (M270.910) A180, (OM651.901) A180 CDi, (OM607.951) A180 CDi, (M270.910) A200, (OM651.930) A220 CDi, (M270.920) A250 (2013-), (W242, W246) B-Class (M270.910) B180, (OM651.901) B180 CDi, (M270.910) B200, (OM651.901) B200 CDi, (M270.920) B250 (2012-)</p>		<p>AR9518 Centre Bearing Rubber</p> <p>Mercedes-Benz (W203) C-Class (OM611.962, OM646.963) C220 CDi, (OM642.910) C320 CDi (00-11)</p>
	<p>AR9510 Engine Mounting - RHS</p> <p>Mercedes-Benz (W176) A-Class (M270.910) A180, (OM651.901) A180 CDi, (OM607.951) A180 CDi, (M270.910) A200, (OM651.930) A220 CDi, (M270.920) A250 (2013-), (W242, W246) B-Class (M270.910) B180, (OM651.901) B180 CDi, (M270.910) B200, (OM651.901) B200 CDi, (M270.920) B250 (2012-)</p>		<p>AR9519 Propshaft Coupling</p> <p>Mercedes-Benz (W203) C-Class (OM642.910) C320 CDi (00-11), (W211) E-Class (OM642.920) E320 CDi (02-10), (W639) Vito 113 CDi, (OM646.980/982) 115 CDi, (OM651.940) 116 CDi, 120 CDi, (OM642.890) 122 CDi (2004-)</p>
	<p>AR9511 Front Lower Control Arm Bush - Inner Front</p> <p>Mercedes-Benz (W176) A-Class (M270.910) A180, (OM651.901) A180 CDi, (OM607.951) A180 CDi, (M270.910) A200, (OM651.930) A220 CDi, (M270.920) A250 (2013-), (W242, W246) B-Class (M270.910) B180, (OM651.901) B180 CDi, (M270.910) B200, (OM651.901) B200 CDi, (M270.920) B250 (2012-)</p>		<p>AR9520 Engine Mounting - Rear</p> <p>Mazda 3 (BK, BL) (B6ZE, Z6) 1.6 Original, Active, Dynamic, (LF17) 2.0 Dynamic, Individual, (L3KG) 2.3 Individual MPS, (L5-VE) 2.5 (04-14), 5 (CR19) (LFF7) 2.0 Original, Active, Dynamic, Individual (07-10), 5 (CW) (LFZB) 2.0 (10-14)</p>
	<p>AR9512L Front Lower Control Arm Bush - Outer Rear LHS</p> <p>Mercedes-Benz (W176) A-Class (M270.910) A180, (OM651.901) A180 CDi, (OM607.951) A180 CDi, (M270.910) A200, (OM651.930) A220 CDi, (M270.920) A250 (2013-), (W242, W246) B-Class (M270.910) B180, (OM651.901) B180 CDi, (M270.910) B200, (OM651.901) B200 CDi, (M270.920) B250 (2012-)</p>		<p>AR9521 Centre Bearing Rubber</p> <p>Mercedes-Benz (W204) C-Class (M271.910, M271.952) C180K, (M271.950) C200K, (OM651.911) C220 CDi, (M272.947) C300, (OM642.960) C350 CDi, (M272.961) C350 (07-14), (W212) E-Class (M274.920) E200, (M274.920) E250, (M271.860) E250, CGi, (M276.980) E350, (M276.820) E400, (M278.922) E500 (2011-)</p>
	<p>AR9512R Front Lower Control Arm Bush - Outer Rear RHS</p> <p>Mercedes-Benz (W176) A-Class (M270.910) A180, (OM651.901) A180 CDi, (OM607.951) A180 CDi, (M270.910) A200, (OM651.930) A220 CDi, (M270.920) A250 (2013-), (W242, W246) B-Class (M270.910) B180, (OM651.901) B180 CDi, (M270.910) B200, (OM651.901) B200 CDi, (M270.920) B250 (2012-)</p>		<p>AR9522 Centre Bearing Rubber</p> <p>Mercedes-Benz (W211) E-Class E220 CDi (OM646.961) 2.2, E240 (M112.913) 2.6, E280 (M272.943) 3.0, E320 (M112.949) 3.2 (02-10), (W211) E-Class (M271.941/956) E200K, (OM647.961) E270 CDi, (M112.949) E320, (OM642.920) E320 CDi, (M272.964) E350, (M113.967) E500 (02-10)</p>
	<p>AR9513 Trailing Arm Bush</p> <p>Mercedes-Benz (W176) A-Class (M270.910) A180, (OM651.901) A180 CDi, (OM607.951) A180 CDi, (M270.910) A200, (OM651.930) A220 CDi, (M270.920) A250 (2013-), (W242, W246) B-Class (M270.910) B180, (OM651.901) B180 CDi, (M270.910) B200, (OM651.901) B200 CDi, (M270.920) B250 (2012-)</p>		<p>AR9523 Rear Subframe Bush - Front</p> <p>Mercedes-Benz (W211) E-Class E220 CDi (OM646.961) 2.2, E240 (M112.913) 2.6, E280 (M272.943) 3.0, E320 (M112.949) 3.2 (02-10)</p>
	<p>AR9514 Front Strut Mounting</p> <p>Mercedes-Benz (W176) A-Class (M270.910) A180, (OM651.901) A180 CDi, (OM607.951) A180 CDi, (M270.910) A200, (OM651.930) A220 CDi, (M270.920) A250 (2013-), (W242, W246) B-Class (M270.910) B180, (OM651.901) B180 CDi, (M270.910) B200, (OM651.901) B200 CDi, (M270.920) B250 (2012-)</p>		<p>AR9524 Rear Subframe Bush - Rear</p> <p>Mercedes-Benz (W211) E-Class E240 (M112.913) 2.6, E320 (M112.949) 3.2 (02-10)</p>
	<p>AR9515 Front Strut Mounting</p> <p>Mercedes-Benz (W176) A-Class (M270.910) A180, (OM651.901) A180 CDi, (OM607.951) A180 CDi, (M270.910) A200, (OM651.930) A220 CDi, (M270.920) A250 (2013-) - with Sport Suspension</p>		<p>AR9525 Front Stabilizer Bar Bush</p> <p>Mercedes-Benz (W211) E-Class (M271.941/956) E200K, (OM647.961) E270 CDi, (M112.949) E320, (OM642.920) E320 CDi, (M272.964) E350, (M113.967) E500 (02-10)</p>
	<p>AR9516 Centre Bearing Rubber</p> <p>Mercedes-Benz (W203) C-Class C180 (M111.920) 1.8 Classic, C200 (M271.940) 2.0 Classic, S/W, C220 (OM611.962, OM646.963) 2.2 CDi Classic, S/W, Elegance, C230 2.3 Coupe, C240 (M203.086) 2.6 V6 Elegance, S/W, Elegance S/W, C270 (OM612.962) 2.7 CDi 5-Cyl. Elegance, S/W, C320 (M111.946) 3.2 V6 Avantgarde Elegance, SW, (M271.946) C180K, (M271.940) C200K, (OM611.962, OM646.963) C220 CDi, (M271.948) C230K, (M112.912) C240/240T, (OM642.910) C320 CDi, (M272.960) C350 (00-11)</p>		<p>AR9526 Engine Mounting - Rear, L/RHS</p> <p>Mercedes-Benz (W211) E-Class E220 CDi (OM646.961) 2.2, E240 (M112.913) 2.6, E280 (M272.943) 3.0, E320 (M112.949) 3.2 (02-10), (W211) E-Class (M271.941/956) E200K, (M112.949) E320 (02-10)</p>
	<p>AR9517 Centre Bearing Rubber</p> <p>Mercedes-Benz (W203) C-Class C270 (OM612.962) 2.7 CDi 5-Cyl. Elegance, S/W, (M271.946) C180K, (M271.940) C200K, (OM611.962, OM646.963) C220 CDi, (M271.948) C230K, (M112.912) C240/240T, (OM642.910) C320 CDi, (M272.960) C350 (00-11)</p>		<p>AR9527 Centre Bearing Rubber</p> <p>Mercedes-Benz (W211) E-Class (OM642.920) E320 CDi (02-10)</p>
			<p>AR9528 Engine Mounting - LHS</p> <p>Mercedes-Benz (W211) E-Class (M272.964) E350 (02-10)</p>
			<p>AR9529 Engine Mounting - RHS</p> <p>Mercedes-Benz (W211) E-Class (M272.964) E350 (02-10)</p>

ENGINE MOUNTING & RUBBER BUYERS GUIDE

	AR9530 Transmission Mounting Mercedes-Benz (W211) E-Class (M272.964) E350 (02-10)		AR9543 Engine Mounting - RHS Hyundai Elantra (MD, UD) (G4FG) 1.6, (G4NB) 1.8 (2011-); Kia Cerato (YD) (G4FC) 1.6, (G4FJ) 1.6T-GDi, (G4NA) 2.0 (2013-)
	AR9531 Front Lower Control Arm Bush - Inner Front Mercedes-Benz (W212) E-Class (M271.820) E200 CGI, (OM651.924) E250 CDI, (M272.952) E300, (OM642.850) E350 CDI (2009-), (M273.971) E500 (06-12), (W212) E-Class (M274.920) E200, (M274.920) E250, (M271.860) E250, CGI, (M276.980) E350, (M276.820) E400, (M278.922) E500 (2011-)		AR9544 Engine Mounting - Front Kia Picanto (G3LA) 1.0 (2011-)
	AR9532 Engine Mounting - L/RHS Mercedes-Benz (W212) E-Class (M276.980) E350, (M276.820) E400 (2011-)		AR9545 Engine Mounting - LHS Kia Picanto (G3LA) 1.0 Man. (2011-)
	AR9533 Engine Mounting - L/RHS Mercedes-Benz (W212) E-Class (M274.920) E200, (M274.920) E250 (2011-)		AR9546 Engine Mounting - RHS Kia Picanto (G3LA) 1.0 Man. (2011-)
	AR9534 Transmission Mounting Mercedes-Benz (W212) E-Class (M274.920) E200, (M274.920) E250 (2011-)		AR9548 Engine Mounting - LHS Kia Picanto (G4LA) 1.2 (2011-)
	AR9535 Exhaust Hanger Mercedes-Benz Sprinter (BM906) (OM646.984) 309 CDI P/van, 16-Seater, (OM646.989, 990) 315 CDI FC, 16-Seater, (OM642.992, 993, 896) 318 CDI P/van, (OM642.992, 896, 898) 319 CDI DC, FC, PV, XC, (OM646.992, 993, 896) 518 CDI FC, DC, PV, 22-Seater, (OM642.896, 898, 992) 519 CDI (2009-)		AR9550 Engine Mounting - RHS Kia Picanto (G4LA) 1.2 (2011-)
 ID: 30	AR9536 Centre Bearing Rubber - Front Mercedes-Benz (W639) Vito 113 CDI, (OM646.980/982) 115 CDI, (OM651.940) 116 CDI, 120 CDI, (OM642.890) 122 CDI (2004-)		AR9552 Engine Mounting - LHS Kia Rio III (G4LA) 1.2 (2011-)
 ID: 30	AR9537 Centre Bearing Rubber - Rear Mercedes-Benz (W639) Vito 113 CDI, (OM646.980/982) 115 CDI, (OM651.940) 116 CDI, 120 CDI, (OM642.890) 122 CDI (2004-)		AR9553 Engine Mounting - RHS Kia Rio III (G4LA) 1.2 Man., (G4FA) 1.4 Man. (2011-)
	AR9538 Engine Mounting - Front Hyundai Sonata (YF) (G4KC) 2.4 GDi (10-15); Kia Optima (G4KJ) 2.4 (12-14)		AR9555 Engine Mounting - LHS Kia Rio III (G4FA) 1.4 Man. (2011-)
	AR9539 Engine Mounting - LHS Hyundai Sonata (YF) (G4KC) 2.4 GDi (10-15); Kia Optima (G4KJ) 2.4 (12-14)		AR9556 Engine Mounting - LHS Isuzu KB-Series KB240i LE, D/C LE, Fleetside P/up (04-13)
	AR9540 Engine Mounting - RHS Hyundai Sonata (YF) (G4KC) 2.4 GDi (10-15); Kia Optima (G4KJ) 2.4 (12-14)		AR9557 Engine Mounting - RHS Isuzu KB-Series KB240i LE, D/C LE, Fleetside P/up (04-13)
	AR9542 Engine Mounting - LHS Hyundai Elantra (MD, UD) (G4FG) 1.6, (G4NB) 1.8 (2011-); Kia Cerato (YD) (G4FC) 1.6, (G4FJ) 1.6T-GDi, (G4NA) 2.0 (2013-)		AR9558 Front Strut Mounting Citroen C4 Aircross (9HD-DV6C) 1.6 HDi 115, (4B11) 2.0 (2010-); Mitsubishi ASX (4B11) 2.0 (2011-), Outlander 4X4 (4B12) 2.4 (07-14)
			AR9559 Front Stabilizer Bar Bush Mitsubishi ASX (4B11) 2.0 (2011-)

ENGINE MOUNTING & RUBBER BUYERS GUIDE

385

	AR9560 Rear Stabilizer Bar Bush Citroen C4 Aircross (9HD-DV6C) 1.6 HDi 115 (2010-); Mitsubishi ASX (4B11) 2.0 (2011-)		AR9573 Steering Rack Mounting Mitsubishi Pajero 4X4 (4D56) 2.5 Di-D, (4M41) 3.2 Di-DC, (4M41) 3.2 Di-D (2009-)
	AR9561 Front Strut Mounting Mitsubishi Lancer (4A91) 1.5, (4G18) 1.6 (03-10)		AR9575 Front Strut Mounting Audi A6 (ABC) 2.6, (AAH) 2.8 (94-97)
	AR9562 Rear Stabilizer Bar Bush Mitsubishi Lancer (4A91) 1.5, (4G18) 1.6 (03-10)		AR9576 Engine Mounting - Rear Renault Captur (H4B) 0.9T TCe, (H5F) 1.2, (K9K) 1.5dCi (2013-), Clio IV (H4B) 0.9T TCe 90, (D4F) 1.2 5-Spd. Man. (2013-), Sandero (B8) (H4B400) 900T TCe 90 (2014-)
	AR9563 Centre Bearing Rubber Mitsubishi Outlander 4X4 (4B12) 2.4 (07-14)		AR9577 Transmission Mounting Renault Captur (H4B) 0.9T TCe, (H5F) 1.2, (K9K) 1.5dCi (2013-), Clio IV (H4B) 0.9T TCe 90, (D4F) 1.2 5-Spd. Man. (2013-)
	AR9564 Engine Mounting - Rear Citroen C4 Aircross (9HD-DV6C) 1.6 HDi 115, (4B11) 2.0 (2010-); Mitsubishi Outlander 4X4 (4B12) 2.4 (07-14)		AR9578 Front Strut Mounting Renault Clio IV (H4B400/8) 0.9T TCe 90, (D4F740, H5F403) 1.2, (M5M400, M5M401, M5M450) 1.6 RS (2013-)
	AR9565 Front Stabilizer Bar Bush Citroen C4 Aircross (9HD-DV6C) 1.6 HDi 115, (4B11) 2.0 (2010-); Mitsubishi Outlander 4X4 (4B12) 2.4 (07-14)		AR9579 Front Stabilizer Bar Bush Renault Duster 4X2, 4X4 (K9K884/858) 1.5dCi, (K4M616) 1.6 (2013-), Kwid (B4D404) 1.0 (2015-)
	AR9566 Rear Stabilizer Bar Bush Mitsubishi Outlander 4X4 (4B12) 2.4 (07-14)		AR9580 Rear Stabilizer Bar Bush Renault Duster 4X2, 4X4 (K9K884/858) 1.5dCi, (K4M616) 1.6 (2013-)
	AR9567 Engine Mounting - L/RHS Front Mitsubishi Pajero 4X4 3.2 Di-D, Di-D GLS, GLX, TDi GLS SUV, (6G75) 3.8 X-Treme, GLS SUV DOCH (02-07)		AR9581 Engine Mounting - Rear Renault Duster 4X2, 4X4 (K9K884/858) 1.5dCi, (K4M616) 1.6 (2013-)
	AR9568 Engine Mounting - Rear L/RHS Mitsubishi Pajero 4X4 3.2 Di-D, Di-D GLS, GLX, TDi GLS SUV, (6G75) 3.8 X-Treme, GLS SUV DOCH (02-07)		AR9582 Front Lower Control Arm Bush - - Inner Front & Outer Rear Renault Duster 4X2, 4X4 (K9K884/858) 1.5dCi, (K4M616) 1.6 (2013-)
	AR9569 Front Stabilizer Link Grommet Mitsubishi Pajero 4X4 3.2 Di-D, Di-D GLS, GLX, TDi GLS SUV, (6G75) 3.8 X-Treme, GLS SUV DOCH (02-07)		AR9583 Front Axle Beam Bush - Front Renault Fluence (K4M838/839) 1.6, (M4R714/751) 2.0 (11-16)
	AR9570 Front Stabilizer Bar Bush Mitsubishi Pajero 4X4 3.2 Di-D, Di-D GLS, GLX, TDi GLS SUV, (6G75) 3.8 X-Treme, GLS SUV DOCH (02-07)		AR9584 Front Axle Beam Bush - Rear Renault Fluence (K4M838/839) 1.6, (M4R714/751) 2.0 (11-16)
	AR9571 Rear Stabilizer Bar Bush Mitsubishi Pajero 4X4 3.2 Di-D, Di-D GLS, GLX, TDi GLS SUV, (6G75) 3.8 X-Treme, GLS SUV DOCH (02-07)		AR9585 Rear Axle Beam Bush Renault Fluence (K4M838/839) 1.6, (M4R714/751) 2.0 (11-16)
	AR9572 Rear Stabilizer Bar Bush Mitsubishi Pajero 4X4 (4D56) 2.5 Di-D, (4M41) 3.2 Di-DC, (4M41) 3.2 Di-D (2009-)		AR9586 Front Strut Mounting Renault Fluence (K4M838/839) 1.6, (M4R714/751) 2.0 (11-16)

ENGINE MOUNTING & RUBBER BUYERS GUIDE

 ID: 22.5	AR9587 Front Stabilizer Bar Bush Renault Fluence (K4M838/839) 1.6, (M4R714/751) 2.0 (11-16)	 ID: 16.5	AR9602 Rear Stabilizer Bar Bush Volvo C30 (B4164S3) 1.6 Pet., (D4162T) 1.6 D2 Dies., (B4184S11) 1.8, (B4204S3) 2.0i, 2.0D, (B5254T3/7) 2.5i (07-13), S40 (D4162T) 1.6 D2, (B4184S11) 1.8i, (B4204S3) 2.0, (D5204T) 2.0 D4, (D4204T) 2.0D, (D5244T13) 2.4 D5, (B5244S4) 2.4i, (B5254T3/7) 2.5i T5 (04-12)
 ID: 20	AR9588 Front Stabilizer Bar Bush Renault Fluence (K4M838/839) 1.6, (M4R714/751) 2.0 (11-16)		AR9603 Engine Mounting - RHS Volvo S40 (B4204S3) 2.0, (D5244T13) 2.4 D5 (04-12), V40 (D5204T6) 2.0 D3, (D5204T4) 2.0 D4 Cross Country (2012-)
	AR9589 Engine Mounting - RHS Upper Renault Clio II (K9K700/702/752) 1.5dCi Expression (04-14), Kangoo (K9K700/704) 1.5dCi, (K7M750) 1.6 (03-13)		AR9604 Engine Mounting - Rear Volvo V40 (D4162T) 1.6 D2, (B4164T3) 1.6 T3, (B4164T) 1.6 T4 (2012-)
	AR9590 Engine Mounting - LHS Renault Kangoo (K7M750) 1.6 (03-13)		AR9605 Front Strut Mounting Volvo V40 (D4162T) 1.6 D2, (B4164T3) 1.6 T3, (B4164T) 1.6 T4, (D5204T6) 2.0 D3, (D5204T4) 2.0 D4 Cross Country, (B5254T12) 2.5 T5 (2012-)
	AR9591 Engine Mounting - Rear Renault Kangoo (K7M750) 1.6 (03-13)		AR9606 Engine Mounting - Front Centre Volvo S60 (D5244T) 2.4 D5, (D5244T4) 2.4 D5 (03-09)
	AR9592 Front Strut Mounting Renault Kangoo (K7M750) 1.6 (03-13)		AR9607 Front Lower Control Arm Bush - Inner Front Suzuki Alto (K10B) 1.0 (09-15), Celerio (K10B) 1.0 (2015-)
	AR9594 Engine Mounting - RHS Renault Megane III 2.0i Coupe RS250 Cup, Sport, (F4R874) 2.0 RS265, 2.0 RB7 (2010-)		AR9608 Rear Lower Control Arm Bush - Outer Rear Suzuki Alto (K10B) 1.0 (09-15), Celerio (K10B) 1.0 (2015-)
	AR9596 Engine Mounting - LHS Renault Twingo (K4M854) 1.6 RS, Gordini (08-13)		AR9609 Engine Mounting - Rear Suzuki Alto (K10B) 1.0 (09-15), Celerio (K10B) 1.0 (2015-)
	AR9598 Engine Mounting - RHS Ford Focus II (IQDB) 1.6 Ambiente, Trend, Si (05-12); Volvo C30 (D4162T) 1.6 D2 Dies. (07-13), S40 (D4162T) 1.6 D2 (04-12), V40 (D4162T) 1.6 D2 (2012-)		AR9610 Engine Mounting - LHS Suzuki Alto (K10B) 1.0 (09-15), Celerio (K10B) 1.0 (2015-)
	AR9599 Engine Mounting - LHS Ford Kuga 4X2, 4X4 (JQMB, JQMA) 1.6 Ecoboost, Ambiente, (JTMA) 1.6 Ecoboost Titanium, Trend, (TXDA, TXMA) 2.0 TDCi Titanium, Trend AWD Powershift, (TXDB) 2.5 Turbo, Titanium, Trend AWD (2011-); Volvo C30 (B5254T3/7) 2.5i (07-13), S40 (D5204T) 2.0 D4, (D5244T13) 2.4 D5 (04-12), V40 (D5204T6) 2.0 D3, (D5204T4) 2.0 D4 Cross Country, (B5254T12) 2.5 T5 (2012-)		AR9611 Engine Mounting - RHS Suzuki Alto (K10B) 1.0 (09-15), Celerio (K10B) 1.0 (2015-)
	AR9600 Engine Mounting - RHS Ford Focus II (G6DA, G6DB, G6DD) 2.0 TDCi (05-12), Focus III (PNDA) 1.6i, (MGDA) 2.0 TDCi, GDi, GTDi, (R9DA) ST1, ST3 (11-15), Kuga 4X2, 4X4 (TXDA, TXMA) 2.0 TDCi Titanium, Trend AWD Powershift (2011-); Volvo S40 (D4204T) 2.0D (04-12)		AR9612 Front Strut Mounting Suzuki Alto (K10B) 1.0 (09-15), Celerio (K10B) 1.0 (2015-)
	AR9601 Engine Mounting - Rear Volvo C30 (B4164S3) 1.6 Pet. (07-13)		AR9613 Front Stabilizer Bar Bush Suzuki Alto (K10B) 1.0 (09-15), Celerio (K10B) 1.0 (2015-)
			AR9614 Engine Mounting - Rear Suzuki Swift (K12M) 1.2 GA, GL, (K14B) 1.4 GL, GLS, SE (2010-)

ENGINE MOUNTING & RUBBER BUYERS GUIDE

387

	AR9615 Suzuki Swift (K12M) 1.2 GA, GL, (K14B) 1.4 GL, GLS, SE (2010-) Engine Mounting - LHS		AR9629 Suzuki SX4 (J20A, J20B) 2.0 (08-14) Engine Mounting - Front
	AR9616 Suzuki Swift (K12M) 1.2 GA, GL, (K14B) 1.4 GL, GLS, SE (2010-) Engine Mounting - RHS		AR9630 Suzuki SX4 (J20A, J20B) 2.0 (08-14) Engine Mounting - Rear
	AR9617 Suzuki Swift (K12M) 1.2 GA, GL, (K14B) 1.4 GL, GLS, SE, (M16A) 1.6 (2010-), SX4 (J20A, J20B) 2.0 (08-14) Front Strut Mounting		AR9631 Suzuki SX4 (J20A, J20B) 2.0 (08-14) Engine Mounting - LHS
	AR9618 Suzuki Swift (K12M) 1.2 GA, GL, (K14B) 1.4 GL, GLS, SE, (M16A) 1.6 (2010-) Front Stabilizer Bar Bush		AR9632 Suzuki SX4 (J20A, J20B) 2.0 (08-14) Engine Mounting - RHS
	AR9619 Suzuki Swift (M16A) 1.6 (2010-) Engine Mounting - Front		AR9633 Audi A3 (CJZA, CCJZ) 1.2 TFSi, (CXSA) 1.4 TFSi(12-17) Engine Mounting - RHS
	AR9620 Suzuki Swift (M16A) 1.6 (2010-) Engine Mounting - LHS		AR9634 Audi A3 (CJZA, CCJZ) 1.2 TFSi, (CXSA) 1.4 TFSi (12-17) Transmission Mounting
	AR9621 Suzuki Swift (M16A) 1.6 (2010-) Engine Mounting - RHS		AR9635 Audi A3 (CXSA) 1.4 TFSi, (CLHA) 1.6 TDi (12-17), (CZCA, CZEA) 1.4 TFSi, (CRFC) 2.0 TDi (13-17), S3 (CJXB) 2.0 TFSi (13-17) Upper & Lower Subframe Bush
	AR9622 Suzuki Swift (M15A) 1.5i GL, GLS Hatch (08-11) Engine Mounting - Rear		AR9636 Peugeot Boxer (F1CE0481D, F30DT) 3.0 HDi "130" (2007-) Engine Mounting - Rear
	AR9624 Suzuki Swift (M15A) 1.5i GL, GLS Hatch (08-11) Engine Mounting - LHS		AR9637 Peugeot Boxer (F1CE0481D, F30DT) 3.0 HDi "130" (2007-) Engine Mounting - Rear
	AR9625 Suzuki Swift (M15A) 1.5i GL, GLS Hatch (08-11) Engine Mounting - RHS		AR9638 Peugeot Boxer (F1CE0481D, F30DT) 3.0 HDi "130" (2007-) Engine Mounting - LHS
	AR9626 Suzuki Jimny 4X4 (M13A) 1.3 (2008-) Engine Mounting - L/RHS		AR9639 Peugeot Boxer (F1CE0481D, F30DT) 3.0 HDi "130" (2007-) Engine Mounting - RHS
	AR9627 Suzuki Jimny 4X4 (M13A) 1.3 (2008-) Transmission Mounting		AR9640 Ford Kuga 4X2, 4X4 (JQMB, JQMA) 1.6 Ecoboost, Ambiente, (JTMA) 1.6 Ecoboost Titanium, Trend (2011-); Volvo V40 (B4164T3) 1.6 T3, (B4164T) 1.6 T4 (2012-) Engine Mounting - RHS
	AR9628 Suzuki Jimny 4X4 (M13A) 1.3 (2008-) Front Stabilizer Bar Bush		

ENGINE MOUNTING & RUBBER BUYERS GUIDE







 ID: 21.5	AR9641 Front Stabilizer Bar Bush BMW Mini Cooper (R55) (N12B16A, N16B16A) 1.6 Clubman, (R56) (N12B16A, N16B16A) 1.6 Hatch, (R57) (N12B16A, N16B16A) 1.6 Convertible, (R58) (N16B16A) 1.6 Coupe, (R59) (N16B16A) 1.6 Roadster, (R60) (N16B16A) 1.6 Countryman, (R61) (N16B16A) 1.6 Paceman (2007-), Cooper S (R55) (N14B16A, N18B16A) 1.6 Clubman, (R56) (N14B16A, N18B16A) 1.6 Hatch, (R57) (N14B16A, N18B16A) 1.6 Convertible, (R58) (N18B16A) 1.6 Coupe, (R59) (N18B16A) 1.6 Roadster, (R60) (N18B16A) 1.6 Countryman, (R61) (N18B16A) 1.6 Paceman (2007-), Cooper S 4X4 (R60) (N18B16A) 1.6 Countryman, (R61) (N18B16A) 1.6 Paceman (2010-), Cooper John (R55) (N14B16C) 1.6 Clubman, (R56) (N14B16C, N18B16C) 1.6 Hatch, (R57) (N14B16C, N18B16C) 1.6 Convertible, (R58) (N14B16C, N18B16C) 1.6 Coupe, (R59) (N14B16C, N18B16C) 1.6 Roadster (2007-), Countryman JCW (R56) (N18B16C) 1.6 Hatch, (R60) (N18B16A) 1.6 Countryman (2007-), One (R56) (N16B16A) 1.6 Hatch, (R57) (N16B16A) 1.6 Convertible (2007-)	 AR9650 Front Strut Mounting Hyundai i30 (G4GG) 1.6 GLS, Premium, (G4NB-B) 1.8 GLS, Executive (2012-)
 ID: 23.5	AR9642 Front Stabilizer Bar Bush BMW Mini Cooper (R55) (N12B16A, N16B16A) 1.6 Clubman, (R56) (N12B16A, N16B16A) 1.6 Hatch, (R57) (N12B16A, N16B16A) 1.6 Convertible, (R58) (N16B16A) 1.6 Coupe, (R59) (N16B16A) 1.6 Roadster, (R60) (N16B16A) 1.6 Countryman, (R61) (N16B16A) 1.6 Paceman (2007-), Cooper S (R55) (N14B16A, N18B16A) 1.6 Clubman, (R56) (N14B16A, N18B16A) 1.6 Hatch, (R57) (N14B16A, N18B16A) 1.6 Convertible, (R58) (N18B16A) 1.6 Coupe, (R59) (N18B16A) 1.6 Roadster, (R60) (N18B16A) 1.6 Countryman, (R61) (N18B16A) 1.6 Paceman (2007-), Cooper S 4X4 (R60) (N18B16A) 1.6 Countryman, (R61) (N18B16A) 1.6 Paceman (2010-), Cooper John (R55) (N14B16C) 1.6 Clubman, (R56) (N14B16C, N18B16C) 1.6 Hatch, (R57) (N14B16C, N18B16C) 1.6 Convertible, (R58) (N14B16C, N18B16C) 1.6 Coupe, (R59) (N14B16C, N18B16C) 1.6 Roadster (2007-), Countryman JCW (R56) (N18B16C) 1.6 Hatch, (R60) (N18B16A) 1.6 Countryman (2007-), One (R56) (N16B16A) 1.6 Hatch, (R57) (N16B16A) 1.6 Convertible (2007-)	 AR9651 Front Stabilizer Bar Bush Hyundai i30 (G4GG) 1.6 GLS, Premium, (G4NB-B) 1.8 GLS, Executive (2012-)
	AR9643 Engine Mounting - Front Hyundai iX35 4X2, 4X4 (G4KD/D4HA) 2.0 CRDi, 2.4 (G4KE) (2010-); Kia Sportage 4X2, 4X4 (G4NC) 2.0, (D4HA) 2.0 CRDi (2010-)	 AR9652 Engine Mounting - LHS Hyundai Matrix (G4ED-G) 1.6, (G4GB-G) 1.8 (02-07)
	AR9644 Engine Mounting - LHS Hyundai iX35 4X2, 4X4 (G4KD/D4HA) 2.0 CRDi, 2.4 (G4KE) (2010-); Kia Sportage 4X2, 4X4 (G4NC) 2.0, (D4HA) 2.0 CRDi (2010-)	 AR9653 Engine Mounting - RHS Hyundai Matrix (G4ED-G) 1.6, (G4GB-G) 1.8 (02-07)
	AR9645 Engine Mounting - RHS Hyundai iX35 4X2, 4X4 (G4KD/D4HA) 2.0 CRDi, 2.4 (G4KE) (2010-); Kia Sportage 4X2, 4X4 (G4NC) 2.0, (D4HA) 2.0 CRDi (2010-)	 AR9654 Engine Mounting - Rear Hyundai Matrix (G4ED-G) 1.6, (G4GB-G) 1.8 (02-07)
	AR9646 Transmission Mounting Hyundai iX35 4X2, 4X4 (G4KD/D4HA) 2.0 CRDi, 2.4 (G4KE) (2010-)	 AR9655 Engine Mounting - Rear Kia Cerato (TD) (G4FC) 1.6 Man., (G4KD) 2.0 Man. (09-13)
	AR9647 Engine Mounting - Rear Hyundai i30 (G4GG) 1.6 GLS, Premium, (G4NB-B) 1.8 GLS, Executive (2012-)	 AR9656 Engine Mounting - LHS Kia Cerato (TD) (G4FC) 1.6, (G4KD) 2.0 (09-13)
	AR9648 Engine Mounting - LHS Hyundai i30 (G4GG) 1.6 GLS, Premium, (G4NB-B) 1.8 GLS, Executive (2012-)	 AR9657 Front Strut Mounting Kia Cerato (YD) (G4FC) 1.6, (G4FJ) 1.6T-GDi, (G4NA) 2.0 (2013-)
	AR9649 Engine Mounting - RHS Hyundai i30 (G4GG) 1.6 GLS, Premium, (G4NB-B) 1.8 GLS, Executive (2012-)	 AR9658 Engine Mounting - Front Kia Cerato (TD) (G4FC) 1.6 Auto., (G4KD) 2.0 Auto. (09-13)
		 AR9659 Engine Mounting - Rear Kia Cerato (TD) (G4FC) 1.6 Auto., (G4KD) 2.0 Auto. (09-13)
		 AR9661 Engine Mounting - Rear Kia Cerato (G4KD) 2.0 Man. (09-13)
		 AR9662 Rear Stabilizer Bar Bush Nissan NV200 (M20) (K9K) 1.5dCi, (HR16DE) 1.6 (2013-)
		 AR9663 Front Strut Mounting Daewoo Lanos (C14L) 1.3i S SOHC, (616L, Y6) 1.6 SX DOHC (97-03), Lanos II 1.4 S SOHC, 1.6 SX DOHC (97-03)

ENGINE MOUNTING & RUBBER BUYERS GUIDE

	AR9693 Engine Mounting - Front Honda Jazz (GD) (L13A1) 1.4i-DSi 5-Spd. Man., (L15A1) 1.5i V-Tec 5-Spd. Man. (03-08), Jazz (GE) (L13Z1) 1.4i, (L15A3) 1.5i (08-14)		AR9708 Front Lower Control Arm Bush - Outer Rear TATA Bolt 1.2T XMS, XT (2015-)
	AR9694 Engine Mounting - RHS Renault Clio II (D4F706/740/764) 1.2 Authentique, Expression, Generation, Va Va Voom (04-14)		AR9709 Front Stabilizer Bar Bush TATA Bolt 1.2T XMS, XT (2015-)
	AR9696 Transmission Mounting Opel Adam (B10XFT) 1.0T Jam, Glam, Rocks, (A14XER, B14XER) 1.4 (2014-), Corsa E (B10XFT, F10XFT) 1.0T (2015-)		AR9710 Front Strut Mounting TATA Bolt 1.2T XMS, XT (2015-)
	AR9697 Engine Mounting - RHS Opel Adam (A14XER, B14XER) 1.4 (2014-)		AR9711 Exhaust Hanger - Middle, Rear TATA Bolt 1.2T XMS, XT (2015-)
	AR9698 Rear Axle Beam Bush Opel Adam (B10XFT) 1.0T Jam, Glam, Rocks, (A14XER, B14XER) 1.4 (2014-), Adam S (B14NEH) 1.4T (2014-), Corsa D (Z13DTH/J) 1.3 CDTi Enjoy Hatch, (Z14XEP/R) 1.4i Enjoy, Essentia, Cosmo Hatch, Sport, (A14NEL) 1.4T, (16LEL) 1.6i Sport, OPC A/Z (08-15), Corsa E (B10XFT, F10XFT) 1.0T, (B14XEL, B14NEH) 1.4T (2015-)		AR9712 Rear Stabilizer Bar Bush TATA Bolt 1.2T XMS, XT (2015-)
	AR9699 Engine Mounting - RHS Opel Mokka (A14NET, B14NET) 1.4T (15-16)		AR9713 Rear Axle Beam Bush TATA Bolt 1.2T XMS, XT (2015-)
	AR9700 Engine Mounting - Rear Opel Mokka (A14NET, B14NET) 1.4T (15-16)		AR9714 Engine Mounting - L/RHS TATA Safari 4X2, 4X4 2.2 CRDi GLS, GLX Dies. (2007-)
	AR9701 Engine Mounting - Rear Opel Mokka (A14NET, B14NET) 1.4T (15-16)		AR9715 Engine Mounting - Rear TATA Safari 4X2 2.2 CRDi GLS, GLX Dies. (2007-)
	AR9702 Transmission Mounting Opel Mokka (A14NET, B14NET) 1.4T (15-16)		AR9716 Engine Mounting - Rear TATA Safari 4X4 2.2 CRDi GLS, GLX Dies. (2007-)
	AR9704 Engine Mounting - Rear TATA Bolt 1.2T XMS, XT (2015-)		AR9717 Front Stabilizer Bar Bush TATA Safari 4X4 2.2 CRDi GLS, GLX Dies. (2007-)
	AR9705 Engine Mounting - LHS TATA Bolt 1.2T XMS, XT (2015-)		AR9718 Exhaust Hanger - Middle, Rear TATA Safari 4X2, 4X4 2.2 CRDi GLS, GLX Dies. (2007-)
	AR9706 Engine Mounting - RHS TATA Bolt 1.2T XMS, XT (2015-)		AR9719 Rear Stabilizer Bar Bush TATA Safari 4X4 2.2 CRDi GLS, GLX Dies. (2007-)
	AR9707 Frpmt Lower Control Arm Bush - Inner Front TATA Bolt 1.2T XMS, XT (2015-)		AR9720 Rear Stabilizer Link Grommet TATA Safari 4X2, 4X4 2.2 CRDi GLS, GLX Dies. (2007-)

ENGINE MOUNTING & RUBBER BUYERS GUIDE

391

	AR9722 Engine Mounting - RHS Citroen C4 (EW10J4S) 2.0 VTS Coupe (05-10)
	AR9723 Engine Mounting - Rear Fiat Palio I / II (178B5.000) 1.2 ED, EL, Go!, Paint Ltd. M657.12T, (178B3.000) 1.6 EL, ELX, HL, Weekend SW (00-10), Siena I / II (178B5.000) 1.2 EL, EL+ M657.12T, (178B3.000) 1.6 EL+, HL, ELX (00-10)
	AR9724 Engine Mounting - LHS Fiat Palio I / II (178B5.000) 1.2 ED, EL, Go!, Paint Ltd. M657.12T, (178B3.000) 1.6 EL, ELX, HL, Weekend SW (00-10), Siena I / II (178B5.000) 1.2 EL, EL+ M657.12T, (178B3.000) 1.6 EL+, HL, ELX (00-10)
	AR9725 Engine Mounting - RHS Fiat Palio I / II (178B5.000) 1.2 ED, EL, Go!, Paint Ltd. M657.12T, (178B3.000) 1.6 EL, ELX, HL, Weekend SW (00-10), Siena I / II (178B5.000) 1.2 EL, EL+ M657.12T, (178B3.000) 1.6 EL+, HL, ELX (00-10)
	AR9726L Front Strut Mounting - LHS Fiat Palio I / II (178B5.000) 1.2 ED, EL, Go!, Paint Ltd. M657.12T, (178B3.000) 1.6 EL, ELX, HL, Weekend SW (00-10), Siena I / II (178B5.000) 1.2 EL, EL+ M657.12T, (178B3.000) 1.6 EL+, HL, ELX (00-10)
	AR9726R Front Strut Mounting - RHS Fiat Palio I / II (178B5.000) 1.2 ED, EL, Go!, Paint Ltd. M657.12T, (178B3.000) 1.6 EL, ELX, HL, Weekend SW (00-10), Siena I / II (178B5.000) 1.2 EL, EL+ M657.12T, (178B3.000) 1.6 EL+, HL, ELX (00-10)
	AR9727 Engine Mounting - Rear Mahindra Bolero 4X2, 4X4 Maxi Truck (XD3, NEF) 2.5D, 2.5TD (2005-) <small>NO PICTURE AVAILABLE AT TIME OF PRINT</small>
	AR9728 Engine Mounting - L/RHS Mahindra Bolero 4X2, 4X4 Maxi Truck (XD3, NEF) 2.5D, 2.5TD (2005-)
	AR9729 Exhaust Hanger - Middle Mahindra Bolero 4X2, 4X4 Maxi Truck (XD3, NEF) 2.5D, 2.5TD (2005-)
	AR9731 Engine Mounting - Front Fiat Seicento (176B2000) 1.1 S, Sporting (01-03)
	AR9732 Engine Mounting - LHS Fiat Seicento (176B2000) 1.1 S, Sporting (01-03)
	AR9733 Engine Mounting - RHS Fiat Seicento (176B2000) 1.1 S, Sporting (01-03)
	AR9734 Front Stabilizer Bar Bush Fiat Seicento (176B2000) 1.1 S, Sporting (01-03)

	AR9735 Rear Axle Beam Bush Toyota Etios (2NR-FE) 1.5 Xi, 1.5 Xs Cross (2012-)
	AR9736 Exhaust Hanger - Rear Toyota Etios (2NR-FE) 1.5 Xi, 1.5 Xs Cross (2012-)
	AR9737 Exhaust Hanger - Middle Toyota Corolla Quest (1ZR-FE) 1.6 (2014-)
	AR9738 Transmission Mounting Hyundai Getz (G4EE) 1.4i HS (03-12)
	AR9739 Engine Mounting - Front Audi A6 (ASB) 3.0 TDi Quattro (00-09), (BPJ) 2.0 TFSi 7-Spd. Auto. Pet., (BPP, CANA) 2.7 TDi 7-Spd. Auto., (CCEA) 2.8 FSi 7-Spd. Auto. (09-11)
	AR9740 Engine Mounting - Front Audi A6 (CGLC, CMGM) 2.0 TDi 8-Spd. Diesel Auto., (CDNB) 2.0 FSi 8-Spd. Petrol Auto. (11-15)
	AR9741 Front Upper Control Arm Bush - Inner Front & Rear Audi A6 (CGLC, CMGM) 2.0 TDi 8-Spd. Diesel Auto., (CDNB) 2.0 FSi 8-Spd. Petrol Auto. (11-15)
	AR9742 Front Strut Mounting Chevrolet Spark (M300) (B12D1) 1.2 (2010-)
	AR9743 Engine Mounting - Rear Audi S3 (CJXB) 2.0 TFSi (13-17)
	AR9744 Engine Mounting - RHS Ford Fiesta II (Zetec) 1.4i Trend, (Rocam, Zetec) 1.6i Ambiente, Ghia, Trend, 2.0i ST150, ST (04-09), Figo 1.4 TDCi Ambiente (10-16)
	AR9746 Front Lower Control Arm Bush - Inner Front Opel Mokka (A14NET, B14NET) 1.4T (15-16) <small>ID: 12, OD: 64, L: 48/70</small>
	AR9747 Front Lower Control Arm Bush - Outer Rear Opel Mokka (A14NET, B14NET) 1.4T (15-16)
	AR9748 Transmission Mounting Audi A3 (CRFC) 2.0 TDi (13-17), S3 (CJXB) 2.0 TFSi (13-17)

ENGINE MOUNTING & RUBBER BUYERS GUIDE

	AR9749 Rear Axle Beam Bush - Front Audi A3 (CZCA, CZEA) 1.4 TFSi, (CRFC) 2.0 TDi (13-17), S3 (CJXB) 2.0 TFSi (13-17)		AR9768 Transmission Mounting Toyota Fortuner 4X2 (1KD-FTV) 3.0D-4D Man., Raised Body (06-11), (2KD-FTV) 2.5D-4D 5-Spd. Man., (1KD-FTV) 3.0D-4D DSi Man. (11-16), Hilux 4X2 (2KD-FTV) 2.5D-4D 5-Spd. Man. Std., Raised Body, (1KD-FTV) 3.0D-4D (11-16)
	AR9750 Rear Axle Beam Bush - Rear Audi A3 (CZCA, CZEA) 1.4 TFSi, (CRFC) 2.0 TDi (13-17), S3 (CJXB) 2.0 TFSi (13-17)		AR9769 Transmission Mounting Toyota Hilux 4X4 (2KDF-TV) 2.5D-4D 5-Spd. Man., Raised Body (11-16)
	AR9754 Engine Mounting - L/RHS BMW 3-Series (E46) 330d (M57) 3.0 Dies. (99-05) NO PICTURE AVAILABLE AT TIME OF PRINT		AR9770 Trailing Arm Bush Toyota Fortuner 4X2, 4X4 (1KD-FTV) 3.0D-4D, Raised Body, (1GR-FE) 4.0 V6, Raised Body Pet. (06-11)
	AR9755 Centre Bearing Rubber Isuzu KB-Series (D-MAX) 4X2 KB250 (4JK1) DC LE, D/C LE, Fleetside P/up, KB300 (4JJ1) TDC TDi LX, D/C LX, Fleetside P/up, Hi-Rider (04-13)		AR9771 Engine Mounting - L/RHS Toyota Fortuner 4X2, 4X4 (1KDFTV) 3.0D-4D 5-Spd. Auto., 6-Spd. Man. (2015-)
	AR9756 Engine Mounting - Front Hyundai Accent (G4ED) 1.6 GLS, HS, (G4FC) 1.6 (2006-); Kia Rio II (A5D) 1.4, (G4ED) 1.6 Sport (05-11)		AR9773 Brake & Clutch Rubber Nissan NV200 (M20) (K9K) 1.5dCi, (HR16DE) 1.6 (2013-)
	AR9757 Engine Mounting - Rear Hyundai Accent (G4ED) 1.6 GLS, HS, (G4FC) 1.6 (2006-); Kia Rio II (A5D) 1.4, (G4ED) 1.6 Sport (05-11)		AR9774 Rear Axle Beam Bush Suzuki Swift (K12M) 1.2 GA, GL, (K14B) 1.4 GL, GLS, SE, (M16A) 1.6 (2010-)
	AR9759 Front Stabilizer Link Pin Kit Ford Everest 4X2, 4X4 3.0 TDCi (09-15), Ranger 2.5D TD XL D/cab, XLT, SubCab, XLT Hi Trail, Super Cab XLT LWB P/up Dies., 3.0 TDCi D/cab XLE, SubCab XLT, Hi Trail, Super Cab XLT LWB P/up Dies. (07-12); Mazda BT-50 4X2, 4X4 2.5 TDi SLX D/cab P/up, 2.6 SLE D/cab, S/cab, P/up, (WLE7) 3.0 CRDi D/cab, SLE S/cab, CRDi SLX P/up (07-12)		AR9775 Engine Mounting - Rear Nissan Micra (K13) (HR12DE) 1.2 (2011-)
	AR9761 Front Stabilizer Bar Bush Ford Fiesta III (M1JE) 1.0 Ecoboost, Titanium, Trend (2008-)		AR9776 Transmission Mounting Nissan Micra (K13) (HR12DE) 1.2 (2011-)
	AR9762 Engine Mounting - RHS Ford KA (A9A/B) 1.3i Low, LX, Ambiente, Trend, Collection (05-09)		AR9777 Engine Mounting - RHS Nissan Micra (K13) (HR12DE) 1.2 (2011-)
	AR9763 Front Stabilizer Bar Bush Suzuki SX4 (J20A) 2.0 (08-14)		AR9778 Engine Mounting - LHS Honda Accord (K20A6) 2.0i, (K24A3) 2.4i VTEC, Tourer, Exec. (03-08)
	AR9764 Engine Mounting - Rear Nissan X-Trail (T30) 4X2, 4X4 (QR20DE) 2.0 SUV Pet. (01-08)		AR9779 Engine Mounting - LHS Honda Accord (K20A6) 2.0i, (K24A3) 2.4i VTEC, Tourer, Exec. (03-08)
	AR9766 Centre Bearing Rubber Toyota Fortuner 4X2 (2GD-FTV) 2.4TD RB, (2TR-FE) 2.7 VVTi RB, (1GD-FTV) 2.8TD, (1GD-FTV) 2.8TD RB, (1KDFTV) 3.0D-4D 5-Spd. Auto., 6-Spd. Man., (1GR-FE) 4.0 V6, Fortuner 4X4 (1GD-FTV) 2.8TD, (1GD-FTV) 2.8TD RB, (1KDFTV) 3.0D-4D 5-Spd. Auto., 6-Spd. Man. (2015-), Hilux "REVO" 4X2 (1TR-FE) 2.0 VVT-i, (2GD-FTV) 2.4 GD Std. Body, GD-6 Raised Body, (2TR-FE) 2.7 VVT-i Raised Body, (1GD-FTV) 2.8 GD-6 Raised Body, (1GD-FE) 4.0 V6 Raised Body, Hilux "REVO" 4X4 (2GD-FTV) 2.4 GD-6 Raised Body, (1GD-FTV) 2.8 GD-6 Raised Body, (1GD-FE) 4.0 V6 Raised Body (2016-)		AR9780 Front Lower Control Arm Bush - Outer Rear Volkswagen Passat V (BZB, CDAA) 1.8 TSi Comfortline, DSG, HighLine, (BKC, BLS, BXE) 1.9 TDi Comfortline, DSG, HighLine, (AXX, BLR, BLY, BPY, BVY, BVZ, BWA, CAWB, CBFA, CCZ/TA) 2.0 FSi, TFSi Comfortline, HighLine, (BMP) 2.0 TDi Comfortline, HighLine, DSG, (AXZ) 3.2 FSi Sportline, DSG (05-11), Passat (CDAA) 1.8 TSi, (CFFB) 2.0 TDi (11-16)

ENGINE MOUNTING & RUBBER BUYERS GUIDE

393

	<p>AR9781 Engine Mounting - L/RHS</p> <p>Toyota Fortuner 4X2, 4X4 (2GD-FTV) 2.4TD RB, (1GD-FTV) 2.8TD, (1GD-FTV) 2.8TD RB (2015-), Hilux "REVO" 4X2 (2GD-FTV) 2.4 GD Std. Body, (2GD-FTV) 2.4 GD-6 Raised Body, (1GD-FTV) 2.8 GD-6 Raised Body, Hilux "REVO" 4X4 (2GD-FTV) 2.4 GD-6 Raised Body, (1GD-FTV) 2.8 GD-6 Raised Body (2016-)</p>		<p>AR9794 Engine Mounting - Rear</p> <p>Mazda 2 (DE) (ZJ-VE) 1.3 Auto., (ZY-DE/VE) 1.5 Auto. (07-15)</p>
	<p>AR9784 Transmission Mounting</p> <p>Toyota Fortuner 4X2, 4X4 (2GD-FTV) 2.4TD RB, (2TR-FE) 2.7 VVTi RB, (1GD-FTV) 2.8TD, (1GD-FTV) 2.8TD RB, (1KDFTV) 3.0D-4D 5-Spd. Auto., 6-Spd. Man., (1GR-FE) 4.0 V6 (2015-)</p>		<p>AR9795 Engine Mounting - LHS</p> <p>Mazda 2 (DE) (ZJ-VE) 1.3 Auto., (ZY-DE/VE) 1.5 Auto. (07-15)</p>
	<p>AR9785 Front Lower Control Arm Bush - Inner Front</p> <p>Toyota Fortuner 4X2, 4X4 (2GD-FTV) 2.4TD RB, (2TR-FE) 2.7 VVTi RB, (1GD-FTV) 2.8TD, (1GD-FTV) 2.8TD RB, (1KDFTV) 3.0D-4D 5-Spd. Auto., 6-Spd. Man., (1GR-FE) 4.0 V6 (2015-), Hilux "REVO" 4X2 (2GD-FTV) 2.4 GD-6 Raised Body, (2TR-FE) 2.7 VVT-I Raised Body, (1GD-FTV) 2.8 GD-6 Raised Body, (1GD-FE) 4.0 V6 Raised Body, Hilux "REVO" 4X4 (2GD-FTV) 2.4 GD-6 Raised Body, (1GD-FTV) 2.8 GD-6 Raised Body, (1GD-FE) 4.0 V6 Raised Body (2016-)</p>		<p>AR9796 Engine Mounting - L/RHS</p> <p>Toyota Fortuner 4X2, 4X4 (2TR-FE) 2.7 VVTi RB (2015-), Hilux "REVO" 4X2 (1TR-FE) 2.0 VVT-i, (2TR-FE) 2.7 VVT-i (2016-)</p>
	<p>AR9786 Front Lower Control Arm Bush - Outer Rear</p> <p>Toyota Hilux "REVO" 4X2 (2GD-FTV) 2.4 GD-6 Raised Body, (2TR-FE) 2.7 VVT-I Raised Body, (1GD-FTV) 2.8 GD-6 Raised Body, (1GD-FE) 4.0 V6 Raised Body, Hilux "REVO" 4X4 (2GD-FTV) 2.4 GD-6 Raised Body, (1GD-FTV) 2.8 GD-6 Raised Body, (1GD-FE) 4.0 V6 Raised Body (2016-)</p> <p>ID: 16.5, OD: 56, L: 88.5</p>		<p>AR9798 Engine Mounting - Rear</p> <p>Honda Ballade (L15A7) 1.5 i-VTEC 5-Spd. Auto. (2011-), Brio (L12B1) 1.2 5-Spd. Auto. (2012-), Jazz (GE) (L13Z1) 1.3 5-Spd. Auto., (L13Z1) 1.4i 5-Spd. Auto., (L15A7) 1.5i 5-Spd. Auto. (08-14)</p>
	<p>AR9787 Front Stabilizer Bar Bush</p> <p>Toyota Fortuner 4X2, 4X4 (2GD-FTV) 2.4TD RB, (2TR-FE) 2.7 VVTi RB, (1GD-FTV) 2.8TD, (1GD-FTV) 2.8TD RB, (1KDFTV) 3.0D-4D 5-Spd. Auto., 6-Spd. Man., (1GR-FE) 4.0 V6 (2015-), Hilux "REVO" 4X2 (1GD-FTV) 2.8 GD-6 Raised Body, (1GD-FE) 4.0 V6 Raised Body, Hilux "REVO" 4X4 (1GD-FTV) 2.8 GD-6 Raised Body, (1GD-FE) 4.0 V6 Raised Body (2016-)</p>		<p>AR9799 Brake Pedal Rubber</p> <p>Toyota Fortuner 4X2, 4X4 (2GD-FTV) 2.4TD RB, (2TR-FE) 2.7 VVTi RB, (1GD-FTV) 2.8TD, (1GD-FTV) 2.8TD RB, (1GR-FE) 4.0 V6 (2015-)</p>
	<p>AR9788 Shock Rubber - Front</p> <p>Toyota Fortuner 4X2, 4X4 (2GD-FTV) 2.4TD RB, (2TR-FE) 2.7 VVTi RB, (1GD-FTV) 2.8TD, (1GD-FTV) 2.8TD RB, (1KDFTV) 3.0D-4D 5-Spd. Auto., 6-Spd. Man., (1GR-FE) 4.0 V6 (2015-), Hilux "REVO" 4X2 (1TR-FE) 2.0 VVT-i, (2GD-FTV) 2.4 GD Std. Body, (2GD-FTV) 2.4 GD-6 Raised Body, (2TR-FE) 2.7 VVT-I, (1GD-FTV) 2.8 GD-6 Raised Body, Hilux "REVO" 4X4 (2GD-FTV) 2.4 GD-6 Raised Body, (1GD-FTV) 2.8 GD-6 Raised Body (2016-)</p> <p>NO PICTURE AVAILABLE AT TIME OF PRINT</p>		<p>AR9800 Transmission Mounting</p> <p>Toyota Hilux "REVO" 4X2 (1GD-FTV) 2.8 GD-6 Auto. Raised Body (2016-)</p>
	<p>AR9789 Front Strut Mounting</p> <p>Toyota Fortuner 4X2, 4X4 (2GD-FTV) 2.4TD RB, (2TR-FE) 2.7 VVTi RB, (1GD-FTV) 2.8TD, (1GD-FTV) 2.8TD RB, (1KDFTV) 3.0D-4D 5-Spd. Auto., 6-Spd. Man., (1GR-FE) 4.0 V6 (2015-), Hilux "REVO" 4X2 (2GD-FTV) 2.4 GD-6 Raised Body, (2TR-FE) 2.7 VVT-I Raised Body, (1GD-FTV) 2.8 GD-6 Raised Body, (1GD-FE) 4.0 V6 Raised Body, Hilux "REVO" 4X4 (2GD-FTV) 2.4 GD-6 Raised Body, (1GD-FTV) 2.8 GD-6 Raised Body, (1GD-FE) 4.0 V6 Raised Body (2016-)</p>		<p>AR9801 Transmission Mounting</p> <p>Toyota Hilux "REVO" 4X4 (2GD-FTV) 2.4 GD-6 Raised Body, (1GD-FTV) 2.8 GD-6 Raised Body (2016-)</p> <p>NO PICTURE AVAILABLE AT TIME OF PRINT</p>
	<p>AR9790 Rear Stabilizer Bar Bush</p> <p>Toyota Fortuner 4X2, 4X4 (2GD-FTV) 2.4TD RB, (2TR-FE) 2.7 VVTi RB, (1GD-FTV) 2.8TD, (1GD-FTV) 2.8TD RB, (1KDFTV) 3.0D-4D 5-Spd. Auto., 6-Spd. Man., (1GR-FE) 4.0 V6 (2015-)</p>		<p>AR9802 Engine Mounting - RHS</p> <p>Mazda 3 (BK, BL) (LF17) 2.0 Dynamic, Individual, (L3KG) 2.3 Individual MPS (04-14)</p>
	<p>AR9791 Transmission Mounting</p> <p>Toyota Hilux "REVO" 4X2 (2GD-FTV) 2.4 GD-6 Raised Body, (1GD-FTV) 2.8 GD-6 Raised Body Man. (2016-)</p> <p>NO PICTURE AVAILABLE AT TIME OF PRINT</p>		<p>AR9803 Bump Stop</p> <p>Toyota Quantum (2KD-FTV) 2.5 D-4D (2005-)</p>
	<p>AR9793 Transmission Mounting</p> <p>Toyota Fortuner 4X2 (1KD-FTV) 3.0D-4D Auto., Raised Body (06-11), Fortuner 4X2 (2KD-FTV) 2.5D-4D 4-Spd. Auto., (1KD-FTV) 3.0D-4D DSi 4-Spd. Auto.(11-16), Hilux 4X4 (1KD-FTV) 3.0D-4D Auto. (11-16), Hilux "REVO" 4X2 (2GD-FTV) 2.4 GD Std. Body (2016-)</p>		<p>AR9804 Engine Mounting - LHS</p> <p>Opel Corsa D (A14NEL) 1.4T (08-15)</p>
			<p>AR9805 Engine Mounting - LHS</p> <p>Honda CR-V 4X4 (B20Z1) 2.0 SWB SUV Pet. (97-05)</p>
			<p>AR9806 Engine Mounting - RHS</p> <p>Ford Focus III (R9DA) 2.0 ST1, ST3 (11-15), Kuga 4X2, 4X4 (JQMB, JQMA) 1.6 Ecoboost, Ambiente, (JTMA) 1.6 Ecoboost Titanium, Trend, (TXDA, TXMA) 2.0 TDCi Titanium, Trend AWD Powershift, (TXDB) 2.5 Turbo, Titanium, Trend AWD (2011-)</p>
			<p>AR9807 Engine Mounting - RHS Upper Torque Rod</p> <p>Nissan Juke 4X2, 4X4 (K9K) 1.5dCi 6-Spd. Man., (HR16DE) 1.6 5-Spd. Man., (MR16DDT) 1.6 DIG-T 6-Spd. Man., CVT (2011-)</p>

ENGINE MOUNTING & RUBBER BUYERS GUIDE

	AR9808 Bump Stop Rubber Toyota Fortuner 4X2, 4X4 (2KD-FTV) 2.5D-4D 4-Spd. Auto., 5-Spd. Man., (1KD-FTV) 3.0D-4D DSI 4-Spd. Auto., (1GR-FE) 4.0 5-Spd. Auto. (11-16), (2GD-FTV) 2.4TD RB, (2TR-FE) 2.7 VVTi RB, (1GD-FTV) 2.8TD, (1GD-FTV) 2.8TD RB, (1KDFTV) 3.0D-4D 5-Spd. Auto., 6-Spd. Man., (1GR-FE) 4.0 V6 (2015-), Hilux 4X2 (1TR-FE) 2.0 VVTi 5-Spd. Man., (2KD-FTV) 2.5D-4D Raised Body, (2TR-FE) 2.7 VVTi, (1KD-FTV) 3.0D-4D, (1GR-FE) 4.0, Hilux 4X4 (2KDF-TV) 2.5D-4D 5-Spd. Man., Raised Body, (1KD-FTV) 3.0D-4D, (1GR-FE) 4.0 (11-16), Hilux "REVO" 4X2 (2GD-FTV) 2.4 GD-6 Raised Body, (2TR-FE) 2.7 VVT-i Raised Body, (1GD-FTV) 2.8 GD-6 Raised Body, (1GD-FE) 4.0 V6 Raised Body, Hilux "REVO" 4X4 (2GD-FTV) 2.4 GD-6 Raised Body, (1GD-FTV) 2.8 GD-6 Raised Body, (1GD-FE) 4.0 V6 Raised Body (2016-)		AR9821 Engine Mounting - Rear Mazda 2 (DL) (ZJ-VE) 1.3 Pet., (ZY-DE/VE) 1.5 Pet. (2015-), CX-3 (PEX3) 2.0 Man. (2015-)
	AR9809 Rear Trailing Arm Bush Toyota Fortuner 4X2, 4X4 (2GD-FTV) 2.4TD RB, (2TR-FE) 2.7 VVTi RB, (1GD-FTV) 2.8TD, (1GD-FTV) 2.8TD RB, (1KDFTV) 3.0D-4D 5-Spd. Auto., 6-Spd. Man., (1GR-FE) 4.0 V6 (2015-)		AR9824 Engine Mounting - RHS Mazda 2 (DL) (ZJ-VE) 1.3 Man., (ZY-DE/VE) 1.5 Man. (2015-)
	AR9811 Rear Shock Rubber Toyota Fortuner 4X2, 4X4 (2GD-FTV) 2.4TD RB, (2TR-FE) 2.7 VVTi RB, (1GD-FTV) 2.8TD, (1GD-FTV) 2.8TD RB, (1GR-FE) 4.0 V6 (2015-)		AR9825 Engine Mounting - RHS Mazda 2 (DL) (ZJ-VE) 1.3 Man. Pet., (ZY-DE/VE) 1.5 Man. Pet. (2015-)
	AR9812 Front Upper Control Arm Bush - Inner Front Kia K2700i (J2) 2.7i Workhorse D/S, P/up (2004-)		AR9826 Engine Mounting - RHS Mazda 2 (DL) (ZJ-VE) 1.3 Auto. Dies., (ZY-DE/VE) 1.5 Auto. Dies. (2015-)
	AR9813 Front Upper Control Arm Bush - Outer Rear Kia K2700i (J2) 2.7i Workhorse D/S, P/up (2004-)		AR9827 Engine Mounting - RHS Mazda 2 (DL) (ZJ-VE) 1.3 Auto. Pet., (ZY-DE/VE) 1.5 Auto. Pet. (2015-)
	AR9814 Engine Mounting - RHS Upper Nissan Tiida (HR16DE) 1.6 Visia, Visia +, Acenta, (MR18DE) 1.8 Acenta (06-13)		AR9828 Engine Mounting - RHS Mazda 2 (DL) (ZJ-VE) 1.3 Auto. Pet., (ZY-DE/VE) 1.5 Auto. Pet. (2015-)
	AR9815 Engine Mounting - RHS Chevrolet Sonic (LSF) 1.3D, (A14XER) 1.4, (F16D4) 1.6 (11-16)		AR9831 Transmission Mounting Mazda 2 (DL) (ZJ-VE) 1.3 Man., (ZY-DE/VE) 1.5 Man. (2015-)
	AR9816 Rear Lateral Link Toyota Fortuner 4X2, 4X4 (2GD-FTV) 2.4TD RB, (2TR-FE) 2.7 VVTi RB, (1GD-FTV) 2.8TD, (1GD-FTV) 2.8TD RB, (1KDFTV) 3.0D-4D 5-Spd. Auto., 6-Spd. Man., (1GR-FE) 4.0 V6 (2015-)		AR9832 Transmission Mounting Mazda 2 (DL) (ZJ-VE) 1.3 Auto. Dies., (ZY-DE/VE) 1.5 Auto. Dies. (2015-)
	AR9817 Bump Stop Toyota Hilux "VIGO" 4X2 (1TR-FE) 2.0i LWB S/cab, S, SRX, P/up Pet. Standard Body, Hilux "VIGO" 4X2, 4X4 (2KD-FTV) 2.5 TDi LWB D-4D S/cab, S, SRX, D/C Raider P/up Dies. (05-11) - Standard Body Models , Hilux 4X2 (1TR-FE) 2.0 VVTi 5-Spd. Man., S/cab Std. Body, (2KD-FTV) 2.5D-4D 5-Spd. Man. Std. Body (11-16), Hilux "REVO" 4X2 (1TR-FE) 2.0 VVT-i, (2GD-FTV) 2.4 GD Std. Body (2016-)		AR9833 Transmission Mounting Mazda 2 (DL) (ZJ-VE) 1.3 Auto. Pet., (ZY-DE/VE) 1.5 Auto. Pet. (2015-)
	AR9818 Front Lower Control Arm Bush - Inner Front Mazda 2 (DL) (ZJ-VE) 1.3, (ZY-DE/VE) 1.5 (2015-), CX-3 (PEX3) 2.0 (2015-)		AR9835 Front Lower Control Arm Bush - Outer Rear Mazda 2 (DL) (ZJ-VE) 1.3, (ZY-DE/VE) 1.5 (2015-), CX-3 (PEX3) 2.0 (2015-)
	AR9818 Front Stabilizer Bar Bush Chevrolet Sonic (LSF) 1.3D, (A14XER) 1.4, (F16D4) 1.6 (11-16)		AR9836 Front Stabilizer Bar Bush Mazda 2 (DL) (ZJ-VE) 1.3 Pet., (ZY-DE/VE) 1.5 Pet. (2015-)
	AR9820 Engine Mounting - Rear Mazda 2 (DL) (ZJ-VE) 1.3 Dies., (ZY-DE/VE) 1.5 Dies. (2015-), CX-3 (PEX3) 2.0 Auto. (2015-)		AR9837 Front Stabilizer Bar Bush Mazda 2 (DL) (ZJ-VE) 1.3 Dies., (ZY-DE/VE) 1.5 Dies. (2015-), 3 (BM, BN) (Z6Y1) 1.6, (PEY7, PEX2) 2.0 (2014-), 6 (GJ, GL) (PEY5) 2.0, (SHY1) 2.2D, (PYY1, PYZA, PYY8) 2.5 (2014-), CX-3 (PEX3) 2.0 (2015-), CX-5 (GH, KE) (PEY4) 2.0 (12-15)

ENGINE MOUNTING & RUBBER BUYERS GUIDE

395

	AR9838 Rear Lateral Link Bush - LHS Toyota Avanza (K3-VE) 1.3 S P/van, SX MPV, (3SZ-VE) 1.5 SX, TX MPV (12-16)		AR9857 Transmission Mounting Volkswagen Passat (CDA) 1.8 TSi (11-16)
	AR9839 Rear Lateral Link Bush - RHS Toyota Avanza (K3-VE) 1.3 S P/van, SX MPV, (3SZ-VE) 1.5 SX, TX MPV (12-16)		AR9858 Front Strut Mounting Hyundai Sonata (YF) (G4KC) 2.4 GDi (10-15)
	AR9840 Rear Upper Control Arm Link Toyota Avanza (K3-VE) 1.3 S P/van, SX MPV, (3SZ-VE) 1.5 SX, TX MPV (12-16)		AR9859 Rear Strut Mounting Hyundai Sonata (YF) (G4KC) 2.4 GDi (10-15)
	AR9841 Engine Mounting - L/RHS Toyota Avanza (1NR-VE) 1.3 S, SX MPV, (1NR-VE) 1.3 S P/van, (2NR-VE) 1.5 SX, TX MPV (2015-)		AR9860 Rear Axle Beam Bush Chevrolet Corsa 1.4 AC, Club, Sport, 1.7 DTi, Club, Sport, 1.8 Club, Sport (2010-), Utility 1.3D AC, Club, Sport, 1.4 AC, Club, Sport, 1.8 AC, Club, Sport (2010-)
	AR9842 Transmission Mounting Toyota Avanza (1NR-VE) 1.3 S, SX MPV, (1NR-VE) 1.3 S P/van, (2NR-VE) 1.5 SX, TX MPV (2015-)		AR9862 Front Strut Mounting Renault Laguna 2.0 RT, RT Estate, RXE (96-00), (F4P7) 1.8 Authentique, Expression, 1.9dCi Expression, 2.0 Expression, (L7X731) 3.0 Privilege (01-09)
	AR9845 Front Stabilizer Bar Bush Toyota Avanza (1NR-VE) 1.3 S, SX MPV, (1NR-VE) 1.3 S P/van, (2NR-VE) 1.5 SX, TX MPV (2015-)		AR9863 Engine Mounting - RHS Mazda 3 (BK, BL) (B6ZE, Z6) 1.6 Original, Active, Dynamic, (LF17) 2.0 Dynamic, Individual, (L3KG) 2.3 Individual MPS, (L5-VE) 2.5 (04-14), 3 (BM, BN) (Z6Y1) 1.6, (PEY7, PEX2) 2.0 (2014-)
	AR9846 Centre Bearing Rubber Toyota Avanza (1NR-VE) 1.3 S, SX MPV, (1NR-VE) 1.3 S P/van, (2NR-VE) 1.5 SX, TX MPV (2015-)		AR9864 Front Strut Mounting Mazda 3 (BM, BN) (Z6Y1) 1.6, (PEY7, PEX2) 2.0 (2014-), 6 (GJ, GL) (PEY5) 2.0, (SHY1) 2.2D, (PYY1, PYZA, PYY8) 2.5 (2014-)
	AR9847 Rear Lateral Arm Toyota Avanza (1NR-VE) 1.3 S, SX MPV, (1NR-VE) 1.3 S P/van, (2NR-VE) 1.5 SX, TX MPV (2015-)		AR9865 Engine Mounting - RHS Honda CR-V II 4X4 (K20A4) 2.0i SWB SUV (05-09)
	AR9848 Rear Upper Control Arm Link Toyota Avanza (1NR-VE) 1.3 S, SX MPV, (1NR-VE) 1.3 S P/van, (2NR-VE) 1.5 SX, TX MPV (2015-)		AR9866 Engine Mounting - Front Opel Astra H (Z20LER) 2.0 Coupe' Turbo, GSi, GTC Turbo, OPC, Turbo Sport, GTC Turbo Sport (04-10)
	AR9849 Bump Stop Toyota Hilux "VIGO" 4X2, 4X4 (2KD-FTV) 2.5 TDi LWB D-4D S/cab, S, SRX, HO Raised Body, D/C Raider P/up Dies. (05-11), Hilux "REVO" 4X2 (1TR-FE) 2.0 VVT-i, (2GD-FTV) 2.4 GD Std. Body, (2GD-FTV) 2.4 GD-6 Raised Body, (2TR-FE) 2.7 VVT-i, (1GD-FTV) 2.8 GD-6 Raised Body, (1GD-FE) 4.0 V6 Raised Body, Hilux "REVO" 4X4 (2GD-FTV) 2.4 GD-6 Raised Body, (1GD-FTV) 2.8 GD-6 Raised Body, (1GD-FE) 4.0 V6 Raised Body (2016-)		AR9867 Engine Mounting - LHS Opel Astra H (Z14XEP) 1.4 Essentia, (Z16XEP) 1.6 Enjoy, Essentia, (Z18XER) 1.8 Enjoy, Sport, GTC, GTC, Sport, (Z19DT) 1.9 CDTi Enjoy, GTC, Sport, (Z20LER) 2.0 Coupe' Turbo, GSi, GTC Turbo, OPC, Turbo Sport, GTC Turbo Sport (04-10)
	AR9851 Engine Mounting - LHS Hyundai i20 (G4FA) 1.4 Fluid, Glide, (D4FC) 1.4 CRDi Glide, (G4FC) 1.6 GLS (2009-)		AR9868 Engine Mounting - RHS Opel Astra H (Z20LER) 2.0 Coupe' Turbo, GSi, GTC Turbo, OPC, Turbo Sport, GTC Turbo Sport (04-10)
	AR9852 Front Strut Mounting Toyota Avanza (K3-VE) 1.3 S P/van, SX MPV, (3SZ-VE) 1.5 SX, TX MPV (12-16), (1NR-VE) 1.3 S, SX MPV, (1NR-VE) 1.3 S P/van, (2NR-VE) 1.5 SX, TX MPV (2015-)		AR9869 Engine Mounting - L/RHS Suzuki Grand Vitara 4X4 2.4 (2012-)
	AR9853 Front Strut Mounting Chevrolet Aveo (T200) (F15S, LX6) 1.5 L, LS, LT, (A16DMS, LXV) 1.6 LT (03-15), Spark, Spark Lite (M200, M250) (F8CV) 0.8 L, LS, (B10S1) 1.0 LS, LT (2005-)		AR9870 Transmission Mounting Suzuki Grand Vitara 4X4 2.4 (2012-)

ENGINE MOUNTING & RUBBER BUYERS GUIDE

	AR9871 Suzuki Grand Vitara 4X4 2.4 (2012-) Front Strut Mounting		AR9883 Chevrolet Corsa 1.4 AC, Club, Sport, 1.7 DTI, Club, Sport, 1.8 Club, Sport (2010-), Utility 1.3D AC, Club, Sport, 1.4 AC, Club, Sport, 1.8 AC, Club, Sport (2010-), Trailblazer 4X2, 4X4 (XLD25) 2.5D, (LWH) 2.8D, (LY7) 3.6 (12-14) Front Stabilizer Bar Bush
	AR9872 Suzuki Grand Vitara 4X4 2.4 (2012-) Front Lower Control Arm Bush - Inner Front		AR9887 Chevrolet Spark (M300) (B12D1) 1.2 (2010-) Front Lower Control Arm Bush - Inner Front
ID: 14, OD: 35, L: 52			
	AR9873 Suzuki Grand Vitara 4X4 2.4 (2012-) Front Lower Control Arm Bush - Outer Rear		AR9888 Chevrolet Spark (M300) (B12D1) 1.2 (2010-) Front Lower Control Arm Bush - Outer Rear
	AR9874 Suzuki Grand Vitara 4X4 2.4 (2012-) Front Stabilizer Bar Bush		AR9890 Mazda 6 (GJ, GL) (PEY5) 2.0, (SHY1) 2.2D, (PYY1, PYZA, PYY8) 2.5 (2014-) Rear Stabilizer Bar Bush
	AR9875 Suzuki SX4 (J20A, J20B) 2.0 (08-14), Grand Vitara 4X4 2.4 (2012-) Rear Upper Control Arm Bush - Inner Front & Outer Rear		AR9893 Toyota Hilux "REVO" 4X2 (1TR-FE) 2.0 VVT-i, (2GD-FTV) 2.4 GD Std. Body, (2GD-FTV) 2.4 GD-6 Raised Body, (2TR-FE) 2.7 VVT-i, (1GD-FTV) 2.8 GD-6 Raised Body, Hilux "REVO" 4X4 (2GD-FTV) 2.4 GD-6 Raised Body, (1GD-FTV) 2.8 GD-6 Raised Body (2016-) Shackle Bush - Rear Lower
	AR9876 Chevrolet Trailblazer 4X2, 4X4 (XLD25) 2.5D, (LWH) 2.8D, (LY7) 3.6 (12-14) Front Strut Mounting		AR9894 Toyota Fortuner 4X2, 4X4 (1GR-FE) 4.0 V6 (2015-), Hilux "REVO" 4X2 (1GD-FE) 4.0 V6 Raised Body, Hilux "REVO" 4X4 (1GD-FE) 4.0 V6 Raised Body (2016-) Engine Mounting - L/RHS
	AR9877 Chevrolet Trailblazer 4X2, 4X4 (XLD25) 2.5D, (LWH) 2.8D (12-14) Engine Mounting - L/RHS		AR9895 Toyota Hilux "REVO" 4X4 (1GD-FE) 4.0 V6 Raised Body (2016-) Transmission Mounting
		NO PICTURE AVAILABLE AT TIME OF PRINT	
	AR9878 Chevrolet Trailblazer 4X2, 4X4 (XLD25) 2.5D, (LWH) 2.8D, (LY7) 3.6 (12-14) Transmission Mounting		AR9896 Toyota Hilux "REVO" 4X2 (1GD-FE) 4.0 V6 Raised Body (2016-) Transmission Mounting
	AR9879 Chevrolet Trailblazer 4X2, 4X4 (LY7) 3.6 (12-14) Engine Mounting - L/RHS		AR9897 Audi A3 (CLHA) 1.6 TDi (12-17) Engine Mounting - Rear
	AR9880 Chevrolet Trailblazer 4X2, 4X4 (XLD25) 2.5D, (LWH) 2.8D, (LY7) 3.6 (12-14) Front Upper Control Arm Bush - Inner Front & Outer Rear		AR9899 Audi A1 (CHZB, DKLD) 1.0 TFSi, Sportback 70kw 5-Spd. Man., (CAYC) 1.6 TDi 77kw 5-Spd. Man. (15-18); Volkswagen Polo (6C, GP) (CHZB) 1.0 TSi 70kw 5-Spd. Man., (CHZC) 1.0 TSi R-Line 81kw 7-Spd. DSG (2015-). Polo Vivo II (CHZC) 1.0 TSi GT 81kw 6-Spd. Man., (CLPB) 1.4 55kw 5-Spd. Man., (CLPA) 1.4 63kw 5-Spd. Man., (CLSA) 1.6 77kw 5-Spd. Man., 6-Spd. Auto. (2018-) Engine Mounting - Rear
	AR9881 Chevrolet Trailblazer 4X2, 4X4 (XLD25) 2.5D, (LWH) 2.8D, (LY7) 3.6 (12-14) Front Lower Control Arm Bush - Inner Front & Outer Rear		AR9900 Audi A1 (CHZB, DKLD) 1.0 TFSi, Sportback 70kw 6-Spd. Auto., (CZCA, CZDD) 1.4 TFSi, SE 92kw 7-Spd. S-Tronic, Sportback 92kw 6-Spd. Auto., (DAJB) 1.8 TFSi Sport 141kw 7-Spd. S-Tronic (15-18) Engine Mounting - Rear
	AR9882 Mazda 3 (BM, BN) (Z6Y1) 1.6, (PEY7, PEX2) 2.0 (2014-) Rear Stabilizer Bar Bush		AR9901 Volkswagen Polo (6C) (CUSA, CYZB) 1.4 TDi 55kw 5-Spd. Man., (CUTA, CYZA) 1.4 TDi 77kw 5-Spd. Man. (2014-), Polo (6C, GP) (CHZB) 1.0 TSi 70kw 5-Spd. Man., (CHZC) 1.0 TSi R-Line 81kw 7-Spd. DSG, (DAJA) 1.8 TSi GTi 141kw 6-Spd. Man., 7-Spd. DSG (2015-), Polo Vivo II (CHZC) 1.0 TSi GT 81kw 6-Spd. Man. (2018-) Engine Mounting - RHS

ENGINE MOUNTING & RUBBER BUYERS GUIDE

397

	AR9902 Mazda CX-3 (PEX3) 2.0 Man. (2015-)	Engine Mounting - LHS		AR9930 Toyota RAV4 IV 4X2 (3ZR-FE) 2.0 GX Man., (2AR-FE) 2.5 VX AWD Man. (2013-)	Engine Mounting - LHS
	AR9903 Mazda CX-3 (PEX3) 2.0 (2015-)	Engine Mounting - RHS		AR9931 Toyota RAV4 IV 4X2 (3ZR-FE) 2.0 CVT (2013-)	Engine Mounting - LHS
	AR9904 Mazda CX-3 (PEX3) 2.0 Auto. (2015-)	Engine Mounting - LHS		AR9932 Toyota RAV4 IV 4X2 (2AR-FE) 2.5 VX AWD (2013-)	Engine Mounting - LHS
	AR9909 Isuzu KB-Series D-TEQ 4X4 KB240i LE, D/C LE, Fleetside P/up, KB250D LE, D/C LE, Fleetside P/up, KB300TDi LX, D/C LX, Fleetside, "GO Big" P/up Hi-Rider (04-12)	Transmission Mounting		AR9933 Toyota RAV4 IV 4X2 (3ZR-FE) 2.0 CVT (2013-)	Engine Mounting - RHS
	AR9910 Renault Megane II (F9Q800) 1.9dCi, CC Dynamique, dCi Privilege, Dynamique, '+', 2.0, CC Privilege, Classic Dynamique, (F7R710) 2.0T Sport, F1 Team (02-10)	Engine Mounting - Rear		AR9934 Toyota RAV4 IV 4X2 (2AR-FE) 2.5 VX AWD (2013-)	Engine Mounting - RHS
	AR9918 Chevrolet Sonic (LSF) 1.3D Man., (A14XER) 1.4 Man., (F16D4) 1.6 Man. (11-16)	Engine Mounting - RHS		AR9935L Toyota RAV4 IV 4X2 (3ZR-FE) 2.0 GX, (2AR-FE) 2.5 VX AWD (2013-)	Front Stabilizer Bar Bush
	AR9919 Chevrolet Sonic (LSF) 1.3D, (A14XER) 1.4, (F16D4) 1.6 (11-16)	Engine Mounting - Rear		AR9935R Toyota RAV4 IV 4X2 (3ZR-FE) 2.0 GX, (2AR-FE) 2.5 VX AWD (2013-)	Front Stabilizer Bar Bush
	AR9923 Chevrolet Aveo (T200) (F15S, LX6) 1.5 L, LS, LT, (A16DMS, LXV) 1.6 LT (2011-), Sonic (LSF) 1.3D, (A14XER) 1.4, (F16D4) 1.6 (2011-)	Front Lower Control Arm Bush - Inner		AR9936 Toyota RAV4 IV 4X2 (2AR-FE) 2.5 VX AWD (2013-)	Centre Bearing Rubber
	AR9924 Chevrolet Aveo (T200) (F15S, LX6) 1.5 L, LS, LT, (A16DMS, LXV) 1.6 LT (2011-), Sonic (LSF) 1.3D, (A14XER) 1.4, (F16D4) 1.6 (2011-), Corsa D (Z13DTH/J) 1.3 CDTi Enjoy Hatch, (Z14XEP/R) 1.4i Enjoy, Essentia, Cosmo Hatch, Sport, (A14NEL) 1.4T, (16LEL) 1.6i Sport, OPC A/Z (08-15), Corsa E (B10XFT, F10XFT) 1.0T, (B14XEL, B14NEH) 1.4T (2015-)	Front Lower Control Arm Bush - Outer Front		AR9937 Toyota Yaris (KSP130) (1KR-FE) 1.0 (2013-)	Engine Mounting - Rear
	AR9925 Toyota RAV4 IV 4X2 (3ZR-FE) 2.0 GX Man., (2AR-FE) 2.5 VX AWD Man. (2013-)	Engine Mounting - Front		AR9938 Toyota Yaris (NSP130) (1NR-FE) 1.3 (13-17)	Engine Mounting - Rear
	AR9927 Toyota RAV4 IV 4X2 (3ZR-FE) 2.0 GX Man., (2AR-FE) 2.5 VX AWD Man. (2013-)	Engine Mounting - Rear		AR9939 Toyota Yaris (NSP131) (2NR-FKE) 1.5 Pulse Hybrid (14-17)	Engine Mounting - Rear
	AR9928 Toyota RAV4 IV 4X2 (3ZR-FE) 2.0 CVT (2013-)	Engine Mounting - Rear		AR9941 Toyota Yaris (KSP130) (1KR-FE) 1.0 (2013-)	Engine Mounting - LHS
	AR9929 Toyota RAV4 IV 4X2 (2AR-FE) 2.5 VX AWD (2013-)	Engine Mounting - Rear		AR9942 Toyota Yaris (NSP130) (1NR-FE) 1.3 (13-17)	Engine Mounting - LHS



ENGINE MOUNTING & RUBBER BUYERS GUIDE

	AR9945 Engine Mounting - LHS Toyota Yaris (NSP131) (2NR-FKE) 1.5 Pulse Hybrid (14-17)		AR9968 Engine Mounting - Rear Chevrolet Spark (M300) (B12D1) 1.2 (2010-)
	AR9947 Engine Mounting - RHS Toyota Yaris (KSP130) (1KR-FE) 1.0 (2013-)		AR9969 Engine Mounting - Rear Audi A1 (CBZA) 1.2 TFSi, Sportback 63kw 5-Spd. Man. (11-18)
	AR9948 Engine Mounting - RHS Toyota Yaris (NSP130) (1NR-FE) 1.3 (13-17)		AR9973 Engine Mounting - RHS Volkswagen Polo (CGPA, CGPB) 1.2 Man. (2010-)
	AR9949 Engine Mounting - RHS Toyota Yaris (NSP131) (2NR-FKE) 1.5 Pulse Hybrid (14-17)		AR9974 Engine Mounting - Rear Renault Kwid (B4D404) 1.0 (2015-)
	AR9951 Front Stabilizer Bar Bush Nissan X-Trail (T30) 4X2 (QR20DE) 2.0 5-Spd. Man., 4X4 (YD22ETI) 2.2D 6-Spd. Man., 4X4 (QR25DE) 2.5 5-Spd. Man., 4X4 (QR25DE) 2.5 SE 4-Spd. Auto. (01-07)		AR9975 Engine Mounting - LHS Renault Kwid (B4D404) 1.0 (2015-)
	AR9952 Rear Stabilizer Bar Bush Nissan X-Trail (T30) 4X2 (QR20DE) 2.0 5-Spd. Man., 4X4 (YD22ETI) 2.2D 6-Spd. Man., 4X4 (QR25DE) 2.5 5-Spd. Man., 4X4 (QR25DE) 2.5 SE 4-Spd. Auto. (01-07)		AR9976 Engine Mounting - RHS Renault Kwid (B4D404) 1.0 (2015-)
	AR9961 Front Strut Mounting Volvo S40 (B4204T2/3) 2.0T Sedan 4-Spd. Auto., 5-Spd. Man. (97-04), (D4162T) 1.6 D2, (B4184S11) 1.8i, (B4204S3) 2.0, (D5204T) 2.0 D4, (D4204T) 2.0D (04-12)		AR9978 Engine Mounting - Rear Opel Corsa E (B10XFT, F10XFT) 1.0T (2015-)
	AR9963 Engine Mounting - LHS Mazda 3 (BK, BL) (B6ZE, Z6) 1.6 Original, Active, Dynamic (04-14)		AR9979 Engine Mounting - Rear Opel Corsa E (B14XEL) 1.4T (2015-)
	AR9964 Front Stabilizer Bar Bush Volkswagen Polo (CBZB) 1.2 Trendline DSG Pet., (CBZC) 1.2 TSi Comfortline Man. Pet., (CFWA) 1.2 TDi Trendline, BlueMotion Man. DSL, (CGPA, CGPB) 1.2 Man., (CTHE) 1.4 TSi GTi DSG (2010-), Polo (CHYA, CHYB) 1.0 Comfortline, Trendline BlueMotion Hatch (2014-), Polo (GP) (CHZB) 1.0 TSi BlueMotion 5-dr, (CHZC) 1.0 TSi Comfortline, TSi-R-Line DSG (15-17), Polo (AW1, BZ1) 1.0 TSi GT (2018-)		AR9980 Engine Mounting - Rear Opel Corsa E (B14XEL) 1.4T (2015-)
	AR9965 Rear Axle Beam Bush Mazda 2 (DE) (ZJ-VE) 1.3, (ZY-DE/VE) 1.5 (07-15)		AR9981 Engine Mounting - Rear Opel Corsa E (B14NEH) 1.4T (2015-)
	AR9966 Engine Mounting - Rear Volkswagen Polo Vivo II (CHZC) 1.0 TSi GT 81kw 6-Spd. Man., (CLPB) 1.4 55kw 5-Spd. Man., (CLPA) 1.4 63kw 5-Spd. Man., (CLSA) 1.6 77kw 5-Spd. Man., 1.6 77kw 6-Spd. Auto. (2018-)		AR9982 Engine Mounting - RHS Opel Corsa E (B14XEL) 1.4T (2015-)
	AR9967 Engine Mounting - Rear Lower Torque Rod Nissan Juke 4X2, 4X4 (K9K) 1.5dCi 5-Spd. Man., (MR16DDT) 1.6 DIG-T 6-Spd. Man. (2011-)		AR9983 Engine Mounting - RHS Opel Corsa E (B14NEH) 1.4T (2015-)
			AR9984 Transmission Mounting - Rear Opel Corsa E (B14XEL) 1.4T (2015-)

ENGINE MOUNTING & RUBBER BUYERS GUIDE

399

	AR9985 Transmission Mounting - Rear Opel Corsa E (B14NEH) 1.4T (2015-)
	AR9986 Front Stabilizer Bar Bush Opel Corsa E (B10XF, F10XF) 1.0T, (B14XEL, B14NEH) 1.4T (2015-)
	AR9987L Rear Strut Mounting - LHS Opel Corsa E (B10XF, F10XF) 1.0T, (B14XEL, B14NEH) 1.4T (2015-)
	AR9987R Rear Strut Mounting - RHS Opel Corsa E (B10XF, F10XF) 1.0T, (B14XEL, B14NEH) 1.4T (2015-)
	AR9995 Engine Mounting - RHS Ford Focus III (MGDA) 2.0 TDCi (11-15), Kuga 4X2, 4X4 (TXDA, TXMA) 2.0 TDCi Titanium, Trend AWD Powershift (2011-); Volvo C30 2.0D (07-13), S40 (D4204T) 2.0D (04-12), V50 (B5244S) 2.0D VS Sedan (04-12)
	AR9996 Front Lower Control Arm Bush - Inner Front Nissan Qashqai II (J11) 4X2 (HRA2DDT) 1.2T Acenta + D 6-Spd. Man., (K9K) 1.5dCi Acenta 6-Spd. Man., (R9M) 1.6dCi Acenta 6-Spd. Man., (MR16DDT) 1.6 Acenta Tech 6-Spd. Man. (2014-); Renault Kadjar 4X2 (H5F408) 1.2T Dynamique 6-Spd. Man., (K9K) 1.5dCi Dynamique 6-Spd. Auto., 4X4 (R9M) 1.6dCi Dynamique 6-Spd. Man. (2016-)
	AR9997 Front Lower Control Arm Bush - Outer Rear Nissan Qashqai II (J11) 4X2 (HRA2DDT) 1.2T Acenta + D 6-Spd. Man., (K9K) 1.5dCi Acenta 6-Spd. Man., (R9M) 1.6dCi Acenta 6-Spd. Man., (MR16DDT) 1.6 Acenta Tech 6-Spd. Man. (2014-); Renault Kadjar 4X2 (H5F408) 1.2T Dynamique 6-Spd. Man., (K9K) 1.5dCi Dynamique 6-Spd. Auto., 4X4 (R9M) 1.6dCi Dynamique 6-Spd. Man. (2016-)
	ARTOY5 Short Caliper Link Pin Toyota HiAce (YH50) (2Y) 1.8 SWB P/van 4-Spd. Man. Pet., (YH60) (2Y) 1.8 LWB LS Wagon, P/van 5-Spd. Man. Pet. (83-91)
	ARTOY6 Long Caliper Link Pin Toyota HiAce (YH50) (2Y) 1.8 SWB P/van 4-Spd. Man. Pet., (YH60) (2Y) 1.8 LWB LS Wagon, P/van 5-Spd. Man. Pet. (83-91)
	SK211 Front Lower Control Arm Bush - Outer Ford Sapphire 1.6 L Kent, 2.0 GL, GLE, 2.0i GLi, GLi Exec., GLEA Koln, 3.0 V6 Ghia, GLX Essex (89-93), Sierra 1.6 GL, L, SW Kent, 2.0 GL, GL S/W, GLE, GLEA, GLi, LX Sedan, SW Koln, (Cologne) 2.3 V6 GLE, SW, 3.0 V6 GLS, GLX, LX, RS, XR6, 3.0i V6 RS Essex (83-93)

	SK500 Steering Coupling Ford Bantam (CVH, FUA) 1.4 Leisure SWB P/up Pet., (CVH) 1.6 Leisure, Nite SWB P/up Pet. (86-94), Cortina MKIII 1.6 L SWB P/up Kent Pet., 2.0 V4 SWB P/up Koln Pet., 2.5 V6 L SWB P/up Essex Pet., (EV30) 3.0 GT, L, XL, XLE "Big Six" Essex (71-77), Cortina MKIV 1.3 L Kent, 1.6 1-Tonner SWB P/up Kent Pet., 2.0 GL, GLE Koln, 3.0 V6 1-Tonner SWB P/up Essex Pet. (77-86), Cortina MKV 1.6 1-Tonner SWB P/up Kent Pet., 2.4D 1-Tonner SWB P/up York Pet., 3.0 V6 1-Tonner SWB, LWB P/up Essex Pet. (77-86), Escort MKI / II 1.1 300 SWB P/van Kent Pet., 1.3 30/35/45 SWB P/van Kent Pet., 1.6 45 P/van SWB P/van Kent Pet. (68-81), Escort MKIII FWD 1.3 GL, L Kent, (HL16CVH) 1.6 GLE, L Sport, XR3, i, (Endura DE) 1.8i GLi Pet. - Zetec, TD Dies. (81-86), Sapphire 1.6 L Kent, 2.0 GL, GLE, 2.0i GLi, GLi Exec., GLEA Koln, 3.0 V6 Ghia, GLX Essex (89-93), Sierra 1.6 GL, L, SW Kent, 2.0 GL, GL S/W, GLE, GLEA, GLi, LX Sedan, SW Koln, 2.3 V6 GLE, SW, Cologne, 3.0 V6 GLS, GLX, LX, RS, XR6, 3.0i V6 RS Essex (89-93), Sapphire 1.6 L Kent, 2.0 GL, GLE, 2.0i GLi, GLi Exec., GLEA Koln, 3.0 V6 Ghia, GLX Essex (89-93), Sierra 1.6 GL, L, SW Kent, 2.0 GL, GL S/W, GLE, GLEA, GLi, LX Sedan, SW Koln, (Cologne) 2.3 V6 GLE, SW, 3.0 V6 GLS, GLX, LX, RS, XR6, 3.0i V6 RS Essex (83-93); Mazda Rustler 1.3 SWB P/up Kent 2V Pet., (CVH, FUA) 1.4 SWB P/up, (CVH, LUC) 1.6 LX (86-02)
	SK516 Radius Link Repair Kit Mercedes-Benz (W126) 280S, SE (M110.987/89) 2.8 6-Cyl., 300SE (M103.981) 3.0 6-Cyl., 380SE (M116.963) 3.8 V8, 420SE (M116.965) 4.2 V8, 500SE (M117.965) 5.0 V8 (86-93)



From humble beginnings to present day, delivering quality guaranteed auto parts at superior levels of service for more than 40 years.



Guaranteed for your safety and reliability

Johannesburg

Tel: 011 634 7600
Fax: 011 493 3132
61 Trump Street
Selby
Johannesburg
2091
P O Box 260642
Excom 2023

Durban

Tel: 031 531 6000
Fax: 031 531 6210
33 Aloefield Crecent
Springfield Park
Durban North
4051
P O Box 309
Durban 4000

Cape Town

Tel: 021 928 3420
Fax: 021 931 0840
Unit 16. Dundas Park
23b Junction Street
Parow Industria
P O Box 688
Maitland 7404