



# PARTQUIP

QUALITY GUARANTEED AUTO PARTS



## BEARING CATALOGUE

Including: Hubs, Oil Seals, Steering Knuckles  
& Thrust Bearings

# 2022

COPYRIGHT RESERVED

OFFICIAL DISTRIBUTOR OF  
**Fersa**  
Bearings  
MADE IN SPAIN



## Important

The information listed here in is correct to the best of the Company's knowledge and belief, having been compiled from reliable and official sources of information.

However we cannot assume any responsibility for possible errors.

Please refer to your Partquip price list for parts currently available.

### Notes:

This catalogue replaces all previous issues. For older vehicles not covered in this issue, please refer to previous issues or contact your nearest Partquip branch. While every effort has been made to ensure that the information in this catalogue is correct at the time of printing, Partquip cannot accept any responsibility for errors, which may occur.

### Quality:

The manufacturing standards of all parts are very high and ensure the maximum degree of safety under all climatic conditions. It is necessary sometimes to manufacture parts that differ slightly in appearance from the old parts removed from a vehicle. In many cases these will be of improved, modern design and in all cases they will function as well as the parts replaced.

### Guarantee:

All goods are guaranteed for 12 months from date of purchase against defects arising from faulty material or manufacture/workmanship. This guarantee does not extend to defects caused by wear and tear, neglect or accidental damage. All goods are sold with the understanding that we cannot accept liability for consequential personal injury, damage or loss as a result of the misuse or incorrect fitment of our products.

### General:

All parts listed, sold or supplied are offered and sold as parts for replacement only. Vehicle or manufacturer names, descriptions, symbols and numbers listed in this catalogue are used for reference purposes only.

The contents of this catalogue are protected by copyright.

Unlawful use of the contents will result in prosecution.

© COPYRIGHT 2020

All rights reserved. No part of this book may be reproduced or transmitted in any form or by any means, electronic or mechanical, including photocopying, or by any information storage or retrieval system, without permission from the copyright holder.

# Index

## Helpful information

Alternator bearings	i
Taxi sliding door bearings	ii
Bearing & oil seal positions	iii - vi
The bearing generations, differences between ASB/ABS & correct fitment of bearings	vii - x
Bearing fitment procedures	xi
Differential identification	xii
Knuckle kits	xiii
Popular gearbox bearings	xiv
Gearbox & differential applications	xv -xviii
Vehicle application listing	xix
Bearing application	1-212
Thrust bearing buyers guide	213-228
HUB / Stub axle / Steering Knuckle I.D chart	229-277
Buyers guide - Loose Bearings	278-341
PTFE oil seal fitment page	342
Buyers guide - Oil seals	343-407
Buyers guide - Bearing kits	408-448
V-Belt Tensioner	449-457

## ALTERNATOR BEARINGS

ALTERNATOR MAKE	AMPS/VOLTS	FRONT BEARINGS	REAR BEARINGS
BOSCH	28 Amp	6203 ZZ	6001 ZZ
	35 - 70 Amp - 24 Volt	6203 ZZ	6201 ZZ
	55 Amp - 12 Volt	6203 ZZ	6201 ZZ
	55 - 70 Amp - 24 Volt	6203 ZZ	6201 ZZ
DUCELLIER	N/A	6203 2RS	6201 2RS
HITACHI	35 Amp	6202 2RS	6201 2RS
	60 Amp	6203 2RS	6201 2RS
LUCAS	40 - 65 Amp - 12 Volt	6202 ZZ	6202 ZZ
	60 Amp	6202 ZZ	6002 ZZ
	Light Duty 42 Amp	6202 ZZ	6202 2RS
	Heavy Duty 42 - 60 Amp 12 Volt	6302 2RS	6202 2RS
	ADE Heavy Duty 12 Volt	6302 ZZ	6202 ZZ
MARELLI	N/A	6302 ZZ	6201 ZZ
MITSUBISHI	35 Amp	6202 2RS	6201 2RS
	50 Amp	6203 2RS	6201 2RS
MOTOROLA	35 - 72 Amp - 12 Volt	6203 2RS	6200 2RS
	35 - 100 Amp - 24 Volt	6303 2RS	6200 2RS
	40 Amp - 12 Volt (Isuzu Diesel)	6203 2RS	6203 2RS
NIPPON DENSO	30 Amp - 12 Volt	6202 2RS	6201 2RS
	15 Amp - 24 Volt	6304 2RS	6302 2RS
NISSAN (Heavy Duty)	25 - 40 Amp	6305 2RS	6204 2RS
	12 - 24 Volt		
PARIS RHONE	N/A	6203 2RS	N/A

## TAXI SLIDING DOOR BEARINGS

### FORD HUSKY & MITSUBISHI L300

Upper bearing	1 x 608 ZZ
Middle bearing	2 x 688 ZZ + 2 x 68334 - 95700
Lower bearing	1 x 608 ZZ + 1 x 607 ZZ

### MERCEDES-BENZ SPRINTER

Roller door bearing	1 x BKT010
---------------------	------------

### Nissan NV350

Upper bearing (with bracket)	1 x BKT013
Middle bearing (with bracket)	1 x BKT014
Lower bearing (with bracket)	1 x BKT015, 1 x BKT016

### TOYOTA HIACE 67-77 ("Katjiban")

Upper bearing	2 x 608 ZZ
Middle bearing	1 x 608 ZZ + 1 x 68334 - 95660
Lower bearing	1 x 608 ZZ

### TOYOTA HIACE 77-84 ("Super 10, Scorocoro")

Upper bearing	2 x 608 ZZ
Middle bearing	1 x 688 ZZ + 1 x 68334 - 95700
Lower bearing	1 x 608 ZZ

### TOYOTA HIACE 1984- ("Zola budd, TV 2, Tupperware, China eyes")

Upper bearing	1 x 608 ZZ
Middle bearing	1 x 688 ZZ + 2 x 68334 - 95700
Lower bearing	1 x 608 ZZ

### TOYOTA QUANTUM

Upper bearing (No bracket)	1 x BKT007 (Top)
Upper bearing (with bracket)	1 x BKT007B (Top)
Side bearing (with bracket)	1 x BKT008 (Side)
Middle bearing (with bracket)	1 x BKT009 (Middle)



## FRONT WHEEL DRIVE

### BEARING & OIL SEAL POSITIONS

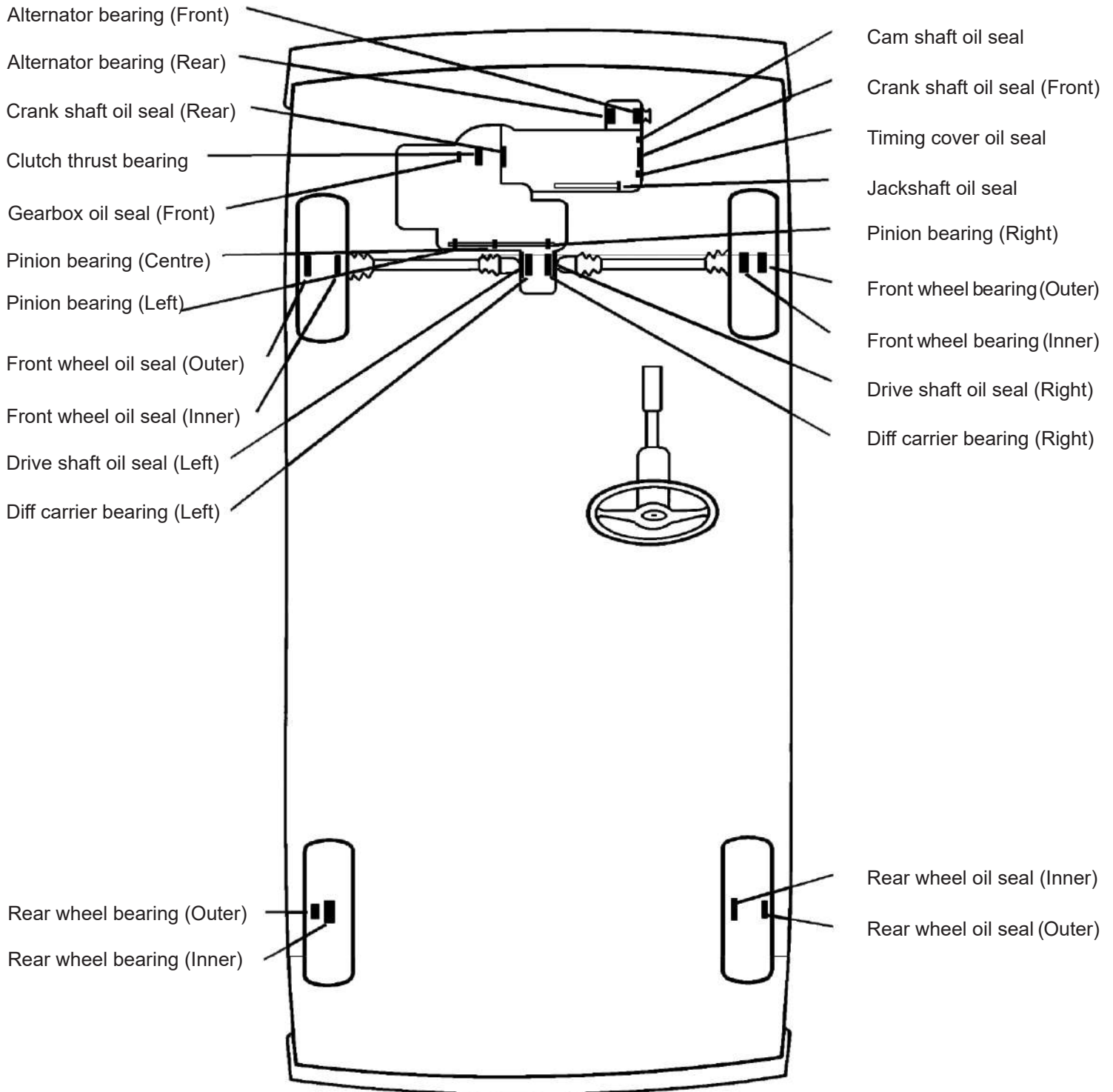



# REAR WHEEL DRIVE

## BEARING & OIL SEAL POSITIONS (REAR ENGINE)

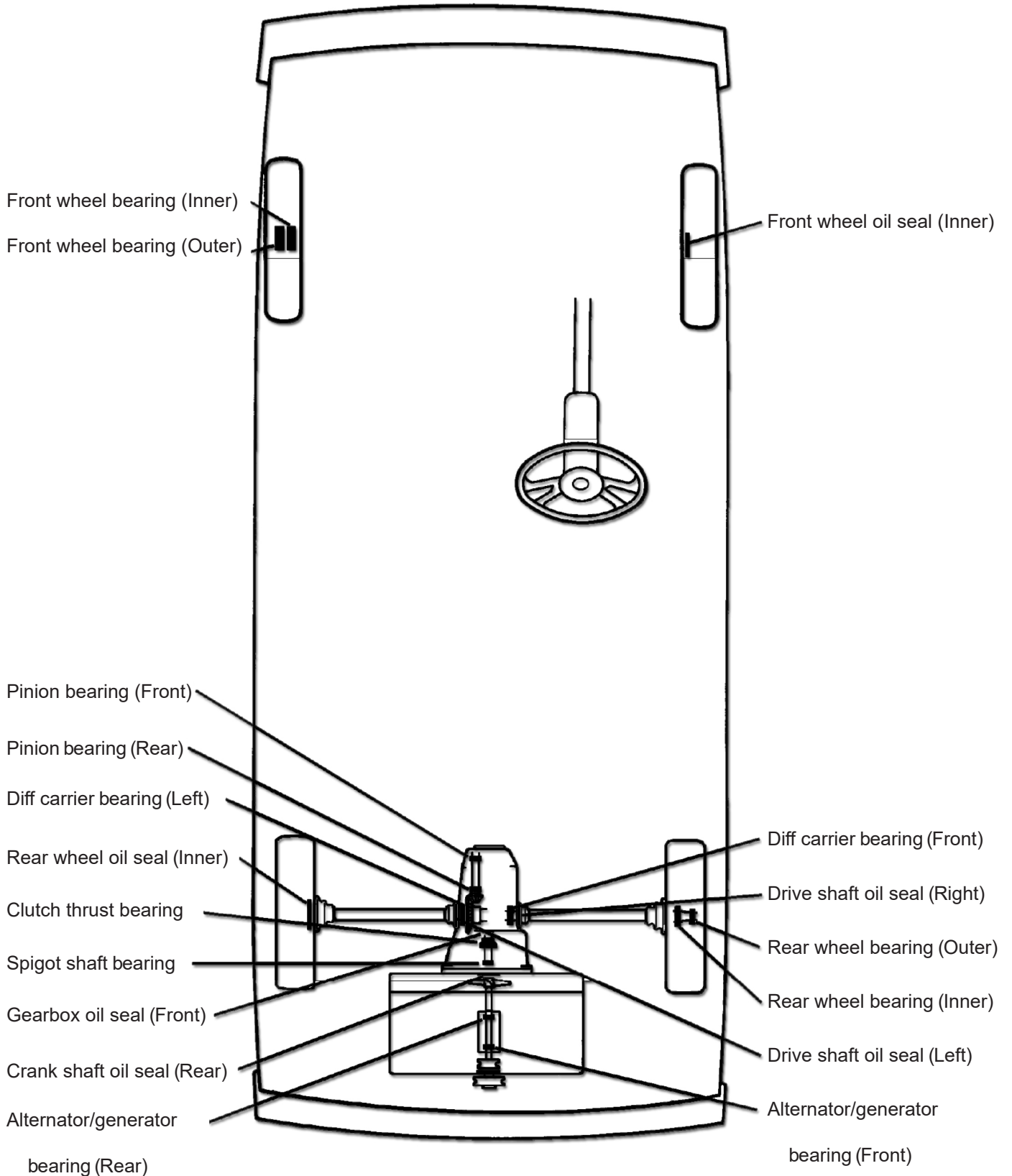

## REAR WHEEL DRIVE

### BEARING & OIL SEAL POSITIONS (FRONT ENGINE)

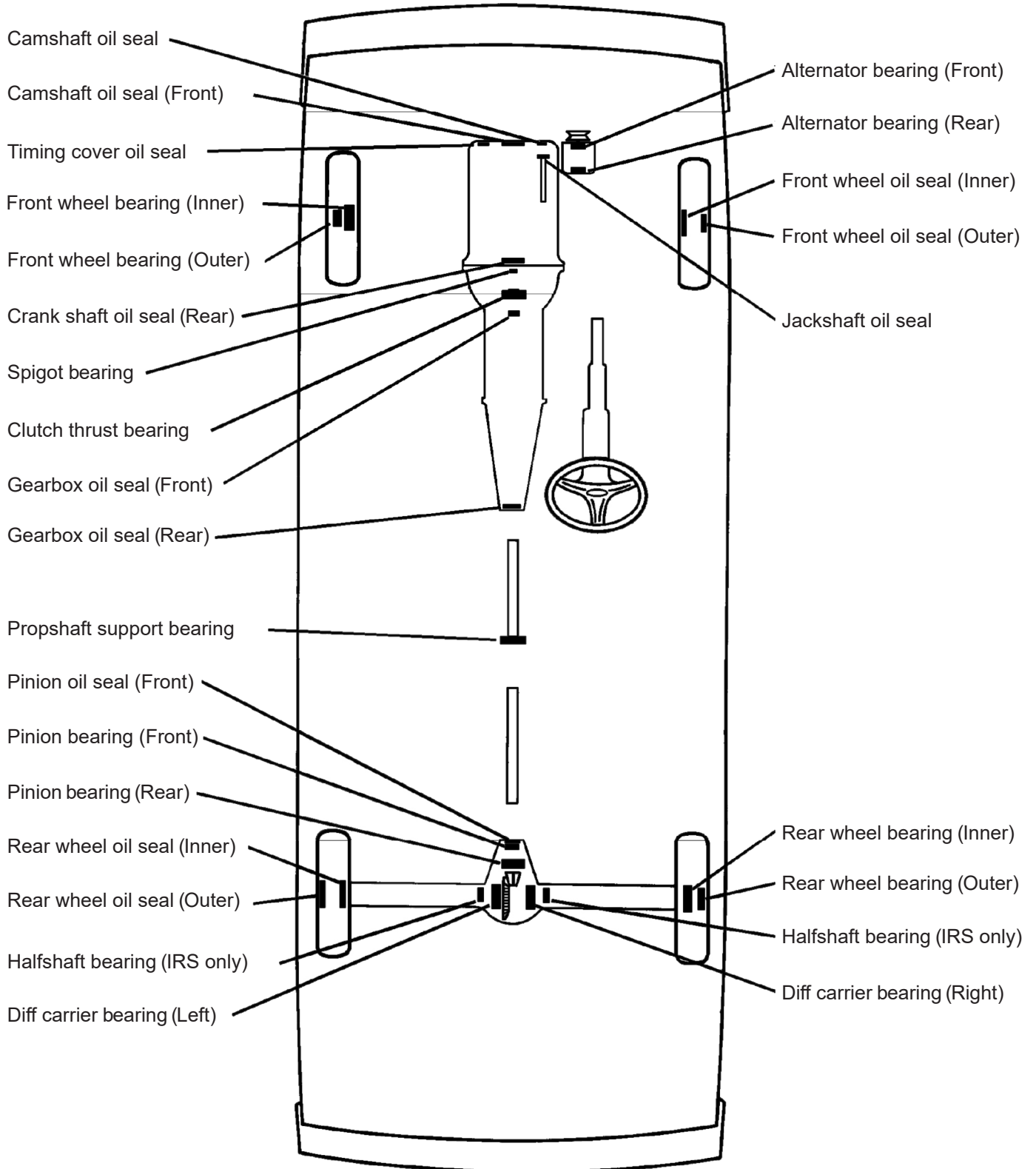



# 4X4 WHEEL DRIVE

## BEARING & OIL SEAL POSITIONS

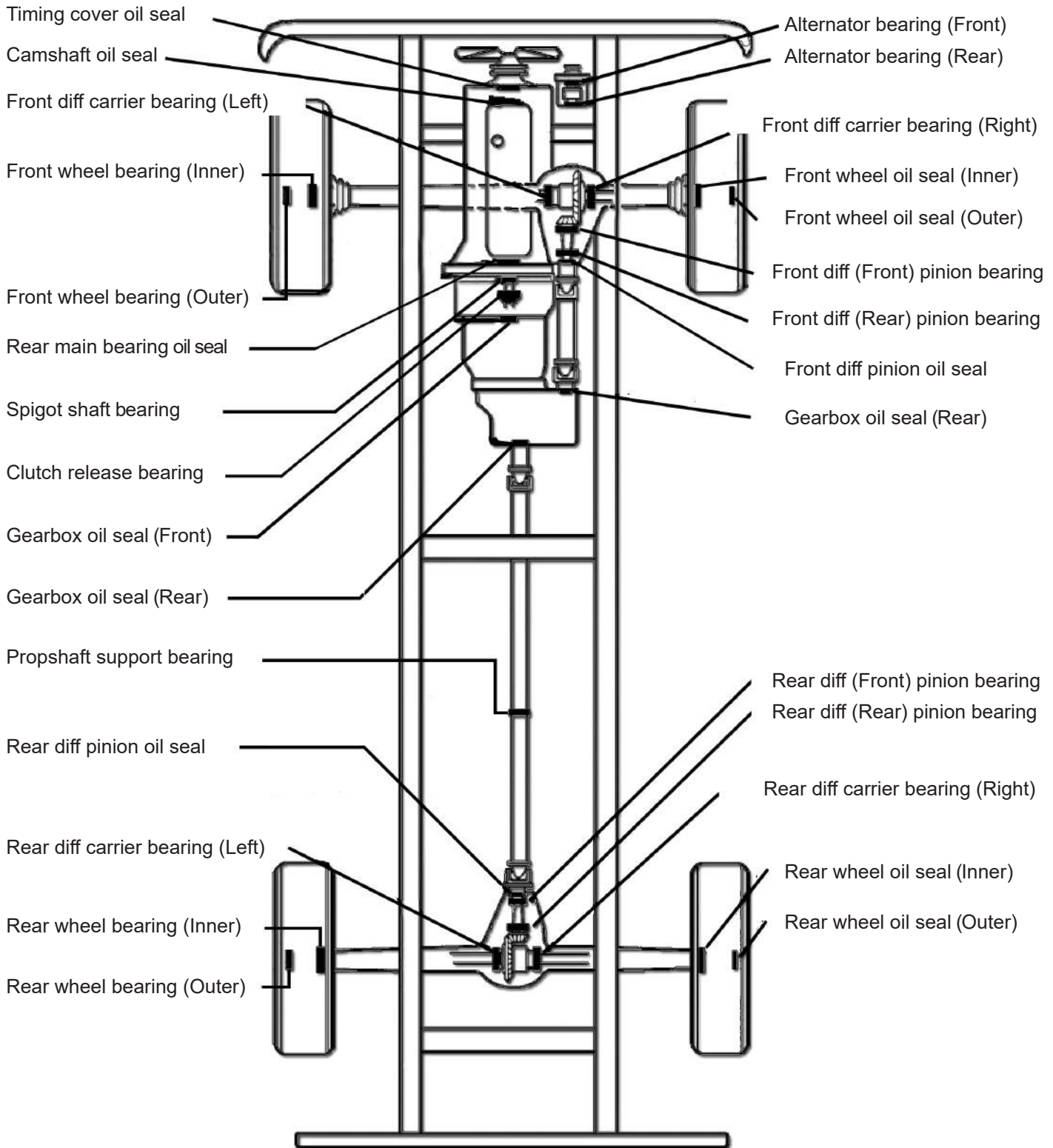

# BEARING GENERATION INFORMATION

## STANDARD BEARINGS



Tapered roller bearing

Tapered roller bearings can be dismantled, inner/outer rings can be separately installed. Tapered roller bearings provide a higher load-carrying capacity but with a limited speed range.



Single row deep groove ball bearing

Single row deep groove ball bearings have deep, uninterrupted raceway grooves. These raceway grooves have a close osculation with the balls, enabling the bearings to accommodate radial loads and axial loads in both directions.

### 1<sup>st</sup> Generation

### 1T Generation



Double-row angular contact ball bearing

Double-row angular contact ball bearings are compact bearing units for both front and rear passenger cars which support and bear high lateral forces during driving on round bends.



Double-row tapered roller bearing

Double-row tapered roller bearings are similar to 1<sup>st</sup> generation bearings, instead of balls, they use tapered rollers as rolling bodies. This increases the bearings capacity to support high axle loads and lateral acceleration.

### 2.1<sup>nd</sup> Generation

### 3<sup>rd</sup> Generation



Double-row angular contact ball bearing

Double-row angular contact ball bearings are 2nd generation compact bearing units that have the advantages of an integrated wheel flange for attaching the brake disc and wheel rim.



Double-row angular contact ball bearing

Double-row angular contact ball bearings are 3rd generation bearings and are highly integrated units with a mounting flange for a brake disc, wheel and wheel mount that guarantee high running accuracy, integrated speed sensors provide the required signal for ABS control.

### 3.1 Generation

### 3.2 Generation



Double-row angular contact ball bearing with axial splines

The drive torque is transferred between the wheel bearing and the axle journal by means of radial splines, which have a certain amount of clearance.



Double-row angular contact ball bearing with ABS Encoder

The magnetic pulse generator ring takes over the function of the ABS sensor ring, normally mounted on the wheel hub or drive shaft joint.

## ABS BEARING INFORMATION

3<sup>rd</sup> Generation HUB Bearings In The Automotive Industry Designed With a Magnetic ABS Pulse Generator



Gear type ABS pick up



Integrated ABS sensor; magnetic pick-up



Integrated ABS Sensor



Ladder Type ABS Pick-Up

Notes



## THE DIFFERENCE BETWEEN ABS AND ASB

### ABS

### ASB

#### “Anti-Lock Braking System”

#### “Active Sensor Bearing”

Simply indicates that a vehicle has been fitted with a system which prevents the wheels locking under heavy braking and therefore allows the driver to retain control of the vehicle.

This is the magnetic speed sensor on the bearing which enables the ABS system on the vehicle to determine whether or not the wheel's are rotating. This can be in the form of a seal on the “DAC” type bearing; or on additional sensor on Hub bearing units.

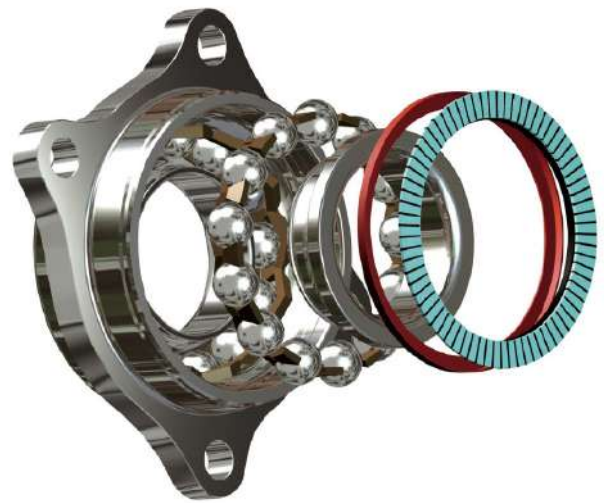
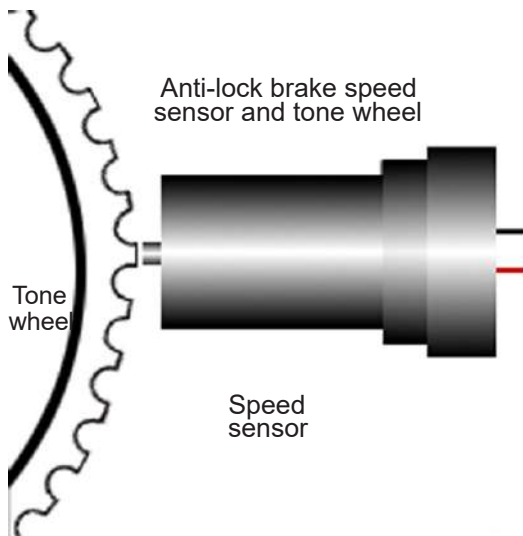

### The most common question asked from customers:

The “ABS light” does not want to go off?

See below possible reasons:

1. The “DAC” type bearing has been fitted the wrong way around, and the sensor cannot read the ASB seal.
2. There is damage to the ASB seal.
3. Another magnet has come into contact with the ASB seal, and has affected the magnets in the ASB seal.
4. There may be a manufacture fault (although this is rare as bearing speed sensors are tested at the factory during assembly)

Notes

## FITTING THE ABS DAC TYPE BEARING THE RIGHT WAY AROUND

Technological advancements have led to the ABS pick-up being integrated into the seal of bearings for later model applications.(Image 1)

In the case of double row angular contact ball bearings and double row tapered rollers bearings (pictured below), it's VITAL that the bearing is pressed into the steering knuckle so that the magnetic seal is in the correct position for the sensor to "read" the seal on the bearing.

An easy way to determine which side of the bearing has the magnetic ABS/ASB seal is to use a ferrous metal paper clip or split pin to see which side of the bearing it's attracted to.

NB!!! Do not use any heavy metal objects to try and determine which side is magnetic, as this could damage the seal. Any damage to the seal will result in a faulty reading from the sensor.



The magnetic ABS/ASB seal can be identified by placing a lightweight metallic object (eg. paperclip) against the seals

Image 1

## BEARING FITMENT PROCEDURES

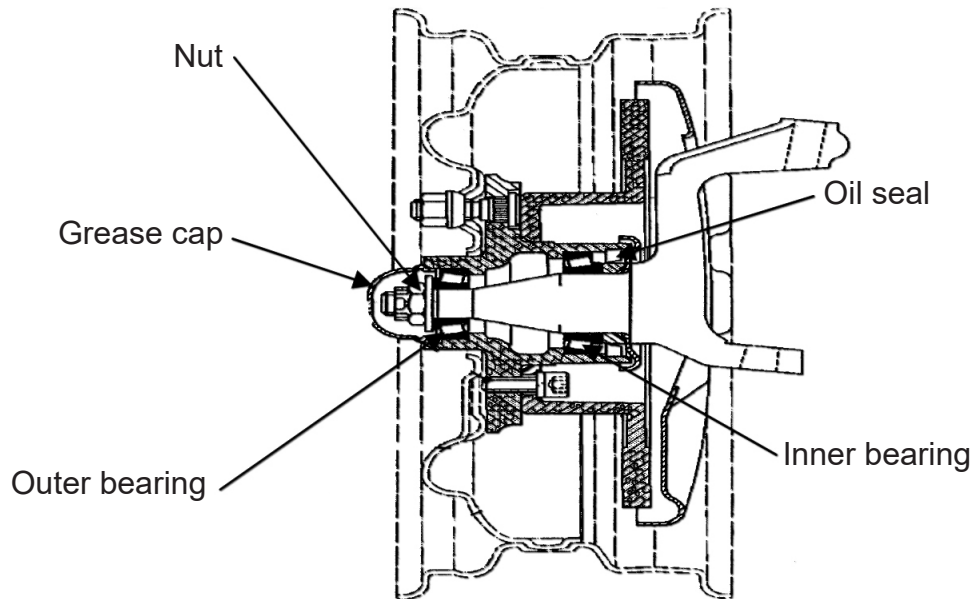

### Note:

It is important not to over-tighten your bearings or for that matter to under-tighten them. If there are any question of dust or dirt on the Bearings, it is advisable to wash them in petrol before proceeding as listed below.

Following these instructions will help you do the job correctly and extend bearing life:

1	Insert the Cup of the inner bearing into the inside of the hub. Use the old Cup as a drift so as not to damage the new Cup, making sure it is the right way round.
2	Insert the Cup of the outer bearing into the outside of the hub as above.
3	Pack an approved type of grease into the cone of inner bearing. (Pack grease into the spaces between cage, cone and rollers)
4	Push the pre-greased inner cone into the inside of the hub.
5	Press Oil seal into inside of hub with sealing lips pointing towards bearing.
6	Mount hub on shaft carefully so as not to damage seal.
7	Apply grease freely to cone of outer bearing, and mount onto shaft.
8	Mount washer.
9	Fit castle or lock nut.
10	Tighten nut while the wheel is being rotated until drag is felt. (If available, follow repair manual instructions and use a torque wrench where applicable)
11	Back off nut approximately 1/12 turn, if castle nut, until alignment with the split pin hole is obtained. Then fit pin.
12	Check bearing for running smoothness and wobble. The wheel must not drag, but rotate freely. Be sure the wheel does not wobble!!
13	Mount grease cap.



## DIFFERENTIAL IDENTIFICATION

### Local Differential

View From The Back. Crown Wheel And Pinion Removed From The Back.

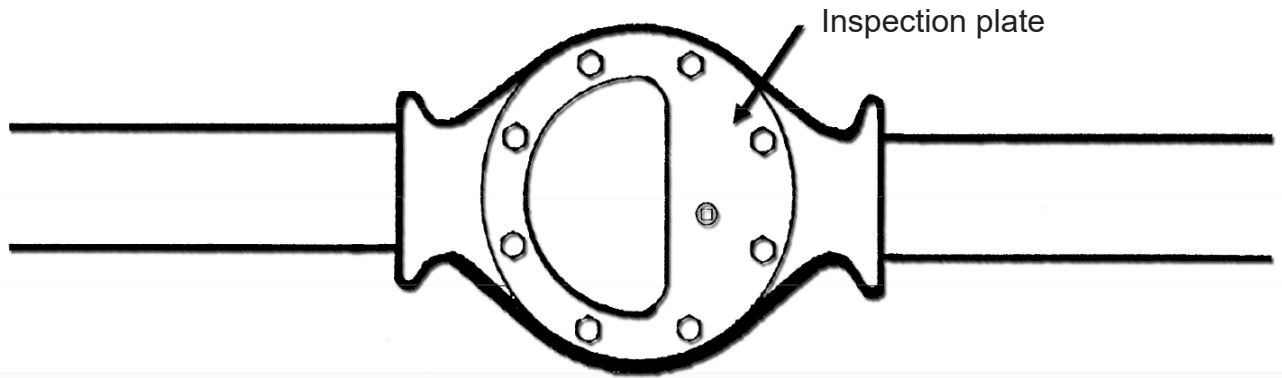

### Imported Differential

View From The Back. Crown Wheel And Pinion Removed From The Front With The Pinion Housing.

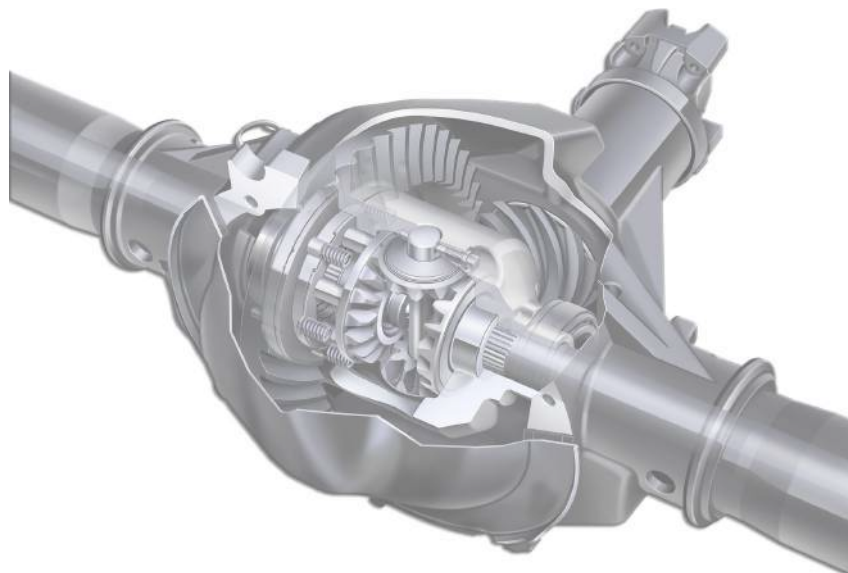
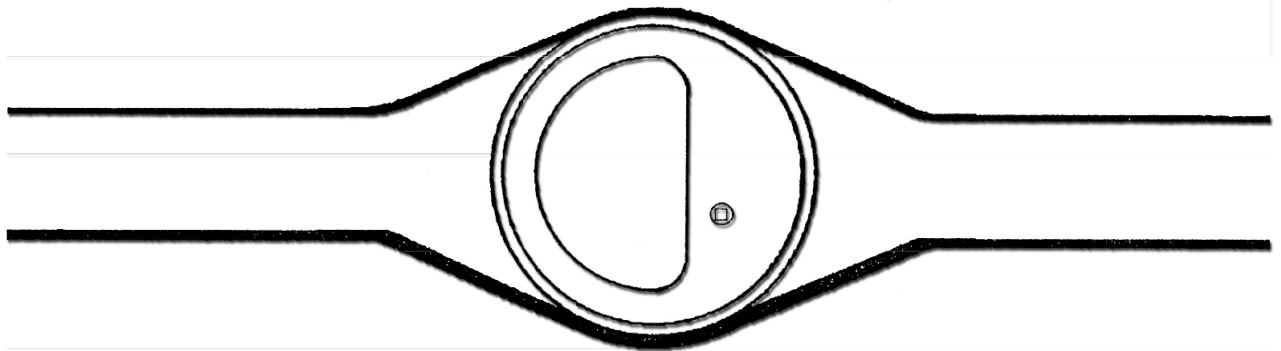

## KNUCKLE KITS

### 4X4 KNUCKLE KITS & OIL SEALS

**OS11835**

Toyota Hilux LN36, 46, RN36, 46 (78-84), LN60, 65, RN67, YN60, 62, 65, 67 (83-89), Land Cruiser FJ75 (3F), HJ75 (2H) (85-91)



**OS11960**

Toyota Land Cruiser FJ75 (3F) (90-91), FZJ75 (1FZF, 1HZ) (93-99)



**OS11963**

Toyota Hilux RN6 (18R) (81-83), LN65 (2L) (88-95), RN67 (22R) (94-98), YN65 (3Y) (84-85), YN67 (4Y) (85-94), KZN165, KZN190 (1KZTE) (00-05), LN167 (5L, 5LE) (98-02), LN192 (5L, 5LE) LN169, RZN169 (3RZFE) (98-05), RZN194 (3RZFE) (98-02), Land Cruiser FJ75 (3F, 2H) (85-89), FJ75 (3F, 2H) (90-91), FZJ75 (1FZH, 1HZ) (93-99)



**OS11975**

Toyota Land Cruiser



**OS11980**

Toyota Land Cruiser FZJ75 1FZF, 1HZ (93-99)



**OS11995**

Toyota Land Cruiser FZJ80, HDJ80 (1990-)



## POPULAR GEARBOX BEARINGS

### VARIOUS MAKES & MODELS (60-13)

6205ZNR	6206ZNR	6207ZNR	6208ZNR	6304ZNR
6305ZNR	6306ZNR	6307ZNR	62/222RSC3	62/28
62/28 NR	63/32	63/32 NR	63/28 NRC3	63/32 ZNR

### GEARBOX KITS:

ISUZU	ISUZU	FORD/MAZDA	NISSAN	HIACE/HILUX
PQGBK1	PQGBK2	PQGBK3	PQGBK4	PQGBK5

### BEARINGS:

6208 ZNR	63082RSN	255820-5NR	6306NRC3	32TM03NXC3P
63/32ZNR	63072RSN	63/28C3	6306ZZ	30TM11NC3P
BD25-9C3	22TM07	63/32NRC3	6305C3	NUPK2205P
6204ZZ	BD25-9	63072RSN	B22-19C3	31RUKSS2NRJP
B20-122C3	62062RSC3	025-57N	6205C3	
6206ZZ		63/22C3	62042RSC3	
NR1		NR2/3/4		

### OIL SEALS

9771	9771	274308	304508	304508
274308	274308	9858	355010	385811
		9838		

### DIFFERENTIAL KITS:

	PQDK1	PQDK2
BEARINGS:	Various commercial makes & models local "Borg Warner" diff - 80-10	Various commercial makes & models imported "Borg Warner" diff 80-10
	86610+49	802011+48
	88610+49	88610+49
	501310+49	102910+49
	501310+49	102910+49
OIL SEAL:	2738	9718
<b>NEW!</b>	PQDK6 (TOYOTA QUANTUM)	
BEARINGS:	STA3072	
	TR070904-1	
	TR100802	
OIL SEAL:	9359	



## GEARBOX & DIFFERENTIAL APPLICATIONS

APPLICATIONS	LOCATION	C.A.M. COMMERCIAL	C.A.M. INYATHI 2.2i Std. Minibus, Taxi	FORD COMMERCIAL	FORD COURIER 2.5 Turbo Dies. D/cab, Leisure P/up WL4	FORD RANGER 2.5D, Turbo Dies. D/cab, High Trail, XL, DT XLT High Trail D/cab, Super cab.
<b>Years</b>			2007-		97-00	00-07
<b>Gearbox Bearings</b>			N/A		255820-5NR 63/28C3 63/32NRC3 63072RSN 025-57N 63/22C3 NR2/3/4	255820-5NR 63/28C3 63/32NRC3 63072RSN 025-57N 63/22C3 NR2/3/4
<b>Gearbox Oil Seal</b>	- Front		304508		274308	274308
	- Rear		385811		9838	9838
<b>Gearbox Kit</b>			N/A		PQGBK3	PQGBK3
<b>Diff Pinion Bearing</b>	- Front		30306C		86610/49 [Loc.] 802011+48 [Imp.]	86610/49 [Loc.] 802011+48 [Imp.]
	- Rear		TR0708030CNP 32307		88610/49 [Both]	88610/49 [Both]
<b>Diff Carrier Bearing</b>	- Left		17831/887 TR100802		501310/49 [Loc.] 102910/49 [Imp.]	501310/49 [Loc.] 102910/49 [Imp.]
	- Right		17831/887 TR100802		501310/49 [Loc.] 102910/49 [Imp.]	501310/49 [Loc.] 102910/49 [Imp.]
<b>Pinion Oil Seal</b>			2738 9718		2738 [Loc.] 9718 [Imp.]	2738 [Loc.] 9718 [Imp.]
<b>Diff Kit</b>			PQDK3 PQDK4 PQDK5		PQDK1 [Local – Borg Warner] PQDK2 [Imported]	PQDK1 [Local – Borg Warner] PQDK2 [Imported]

APPLICATIONS	LOCATION	FORD RANGER 2.5 Dies., Turbo Dies. D/cab, High Trail, XL, DT XLT High Trail D/cab, Super cab.	FORD 4X4	FORD 4X4 COURIER 2.5 Dies., Turbo, Dies. D/cab, Leisure P/up WL4 / Turbo	FORD 4X4 RANGER 2.5 D/cab, High Trail, XL, DT XLT High Trail D/cab, Super cab 2.5TD Montana D/cab WL4	ISUZU COMMERCIAL
<b>Years</b>		07-09		96-00	00-09	
<b>Gearbox Bearings</b>		255820-5NR 63/28C3 63/32NRC3 63072RSN 025-57N 63/22C3 NR2/3/4		255820-5NR 63/28C3 63/32NRC3 63072RSN 025-57N 63/22C3 NR2/3/4	255820-5NR 63/28C3 63/32NRC3 63072RSN 025-57N 63/22C3 NR2/3/4	
<b>Gearbox Oil Seal</b>	- Front	274307		274308	274308	
	- Rear	9838		9858 9838 [Ext. Housing]	9858 9838 [Ext. Housing]	
<b>Gearbox Kit</b>		PQGBK3		PQGBK3	PQGBK3	
<b>Diff Pinion Bearing</b>	- Front	86610/49 [Loc.] 802011+48 [Imp.]		86610/49 [Loc.] 802011+48 [Imp.]	86610/49 [Loc.] 802011+48 [Imp.]	
	- Rear	88610/49 [Both]		88610/49 [Both]	88610/49 [Both]	
<b>Diff Carrier Bearing</b>	- Left	501310/49 [Loc.] 102910/49 [Imp.]		501310/49 [Loc.] 102910/49 [Imp.]	501310/49 [Loc.] 102910/49 [Imp.]	
	- Right	501310/49 [Loc.] 102910/49 [Imp.]		501310/49 [Loc.] 102910/49 [Imp.]	501310/49 [Loc.] 102910/49 [Imp.]	
<b>Pinion Oil Seal</b>		2738 [Loc.] 9718 [Imp.]		2738 [Loc.] 9718 [Imp.]	2738 [Loc.] 9718 [Imp.]	
<b>Diff Kit</b>		PQDK1 [Local – Borg Warner] PQDK2 [Imported]		PQDK1 [Local – Borg Warner] PQDK2 [Imported]	PQDK1 [Local – Borg Warner] PQDK2 [Imported]	

## GEARBOX & DIFFERENTIAL APPLICATIONS

APPLICATIONS	LOCATION	ISUZU KB230 2.3 D/cab P/up KB250D 2.5 Fleetside, LE, D/Cab P/up 4JA1	ISUZU KB280DT 2.8 D/cab LE, LX, Frontier P/up Turbo 4JB1	ISUZU 4X4	ISUZU 4X4 KB230 2.3 P/up 4ZD1 KB250D 2.5 LE, D/cab P/up 4JA1	ISUZU 4X4 KB280DT 2.8 LE, LX, D/cab P/up Turbo 4JB1
<b>Years</b>		<b>89-04</b>	<b>89-04</b>		<b>89-04</b>	<b>89-04</b>
<b>Gearbox Bearings</b>		<b>6208ZNR 63/32ZNR BD25-9C3 6204ZZ B20-122C3 6206ZZ NR1</b>	<b>63082RSN 63072RSN 22TM07 BD25-9 62062RSC3</b>		<b>6208ZNR 63/32ZNR BD25-9C3 6204ZZ B20-122C3 6206ZZ NR1</b>	<b>63082RSN 63072RSN 22TM07 BD25-9 62062RSC3</b>
<b>Gearbox Oil Seal</b>	- Front	<b>9771</b>	<b>9771</b>		<b>9771</b>	<b>9771</b>
	- Rear	<b>274308</b>	<b>274308</b>		<b>274308</b>	<b>274308</b>
<b>Gearbox Kit</b>		<b>PQGBK1</b>	<b>PQGBK2</b>		<b>PQGBK1</b>	<b>PQGBK2</b>
<b>Diff Pinion Bearing</b>	- Front	<b>86610/49 [Loc.] 802011+48 [Imp.]</b>	<b>86610/49 [Loc.] 802011+48 [Imp.]</b>		<b>86610/49 [Loc.] 802011+48 [Imp.]</b>	<b>86610/49 [Loc.] 802011+48 [Imp.]</b>
	- Rear	<b>88610/49 [Both]</b>	<b>88610/49 [Both]</b>		<b>88610/49 [Both]</b>	<b>88610/49 [Both]</b>
<b>Diff Carrier Bearing</b>	- Left	<b>501310/49 [Loc.] 102910/49 [Imp.]</b>	<b>501310/49 [Loc.] 102910/49 [Imp.]</b>		<b>501310/49 [Loc.] 102910/49 [Imp.]</b>	<b>501310/49 [Loc.] 102910/49 [Imp.]</b>
	- Right	<b>501310/49 [Loc.] 102910/49 [Imp.]</b>	<b>501310/49 [Loc.] 102910/49 [Imp.]</b>		<b>501310/49 [Loc.] 102910/49 [Imp.]</b>	<b>501310/49 [Loc.] 102910/49 [Imp.]</b>
<b>Pinion Oil Seal</b>		<b>2738 [Loc.] 9718 [Imp.]</b>	<b>2738 [Loc.] 9718 [Imp.]</b>		<b>2738 [Loc.] 9718 [Imp.]</b>	<b>2738 [Loc.] 9718 [Imp.]</b>
<b>Diff Kit</b>		<b>PQDK1 [Local – Borg Warner] PQDK2 [Imported]</b>	<b>PQDK1 [Local – Borg Warner] PQDK2 [Imported]</b>		<b>PQDK1 [Local – Borg Warner] PQDK2 [Imported]</b>	<b>PQDK1 [Local – Borg Warner] PQDK2 [Imported]</b>

APPLICATIONS	LOCATION	MAZDA COMMERCIAL	MAZDA B2500 2.5D, Turbo Dies. D/cab, DRIFTER, SLX P/up WL4 Dies., Turbo	MAZDA DRIFTER 2.5Td, Hi Ride, SL SLE, SLX D/cab, Hi Trail D/cab P/up WL4 Dies. Turbo	MAZDA 4X4	MAZDA 4X4 B2500 2.5D, Turbo Dies. D/cab DRIFTER, SLX P/up WL4 Dies. Turbo
<b>Years</b>			<b>97-00</b>	<b>00-09</b>		<b>97-00</b>
<b>Gearbox Bearings</b>			<b>255820-5NR 63/28C3 63/32NRC3 63072RSN 025-57N 63/22C3 NR2/3/4</b>	<b>255820-5NR 63/28C3 63/32NRC3 63072RSN 025-57N 63/22C3 NR2/3/4</b>		<b>255820-5NR 63/28C3 63/32NRC3 63072RSN 025-57N 63/22C3 NR2/3/4</b>
<b>Gearbox Oil Seal</b>	- Front		<b>274307</b>	<b>274307</b>		<b>274308</b>
	- Rear		<b>9838</b>	<b>9838</b>		<b>9858 9838 [Ext. Housing]</b>
<b>Gearbox Kit</b>			<b>PQGBK3</b>	<b>PQGBK3</b>		<b>PQGBK3</b>
<b>Diff Pinion Bearing</b>	- Front		<b>86610/49 [Loc.] 802011+48 [Imp.]</b>	<b>86610/49 [Loc.] 802011+48 [Imp.]</b>		<b>86610/49 [Loc.] 802011+48 [Imp.]</b>
	- Rear		<b>88610/49 [Both]</b>	<b>88610/49 [Both]</b>		<b>88610/49 [Both]</b>
<b>Diff Carrier Bearing</b>	- Left		<b>501310/49 [Loc.] 102910/49 [Imp.]</b>	<b>501310/49 [Loc.] 102910/49 [Imp.]</b>		<b>501310/49 [Loc.] 102910/49 [Imp.]</b>
	- Right		<b>501310/49 [Loc.] 102910/49 [Imp.]</b>	<b>501310/49 [Loc.] 102910/49 [Imp.]</b>		<b>501310/49 [Loc.] 102910/49 [Imp.]</b>
<b>Pinion Oil Seal</b>			<b>2738 [Loc.] 9718 [Imp.]</b>	<b>2738 [Loc.] 9718 [Imp.]</b>		<b>2738 [Loc.] 9718 [Imp.]</b>
<b>Diff Kit</b>			<b>PQDK1 [Local – Borg Warner] PQDK2 [Imported]</b>	<b>PQDK1 [Local – Borg Warner] PQDK2 [Imported]</b>		<b>PQDK1 [Local – Borg Warner] PQDK2 [Imported]</b>



## GEARBOX & DIFFERENTIAL APPLICATIONS

APPLICATIONS	LOCATION	MAZDA 4X4 DRIFTER 2.5Td S/D/cab, DL, SL, SLE, SLX P/up WL4 Dies./ Turbo Dies.	NISSAN COMMERCIAL	NISSAN 1-TONNER/ HARDBODY AW/D21 1.6 L16S-J 1.8 L18S-R 2.0 NA20 2.4 Z24/S	NISSAN 1-TONNER/ HARDBODY AW/D21 2.5D TD25i 2.7D TD27 3.0 VG30E	NISSAN HARDBODY QW/D22 2.0 NA20S 2.0i KA20 2.4 Z24, KA24E/DE
<b>Years</b>		<b>02-09</b>		<b>88-98</b>	<b>88-98</b>	<b>98-10</b>
<b>Gearbox Bearings</b>		255820-5NR 63/28C3 63/32NRC3 63072RSN 025-57N 63/22C3 NR2/3/4		6306NRC3 6306ZZ 6305C3 B22-19C3 6205C3 62042RSC3	6306NRC3 6306ZZ 6305C3 B22-19C3 6205C3 62042RSC3	6306NRC3 6306ZZ 6305C3 B22-19C3 6205C3 62042RSC3
<b>Gearbox Oil Seal</b>	- Front	274308		304508	304508	304508
	- Rear	9858 9838 [Ext. Housing]		355010	355010	355010
<b>Gearbox Kit</b>		<b>PQGBK3</b>		<b>PQGBK4</b>	<b>PQGBK4</b>	<b>PQGBK4</b>
<b>Diff Pinion Bearing</b>	- Front	86610/49 [Loc.] 802011+48 [Imp.]		86610/49 [Loc.] 802011+48 [Imp.]	86610/49 [Loc.] 802011+48 [Imp.]	86610/49 [Loc.] 802011+48 [Imp.]
	- Rear	88610/49 [Both]		88610/49 [Both]	88610/49 [Both]	88610/49 [Both]
<b>Diff Carrier Bearing</b>	- Left	501310/49 [Loc.] 102910/49 [Imp.]		501310/49 [Loc.] 102910/49 [Imp.]	501310/49 [Loc.] 102910/49 [Imp.]	501310/49 [Loc.] 102910/49 [Imp.]
	- Right	501310/49 [Loc.] 102910/49 [Imp.]		501310/49 [Loc.] 102910/49 [Imp.]	501310/49 [Loc.] 102910/49 [Imp.]	501310/49 [Loc.] 102910/49 [Imp.]
<b>Pinion Oil Seal</b>		2738 [Loc.] 9718 [Imp.]		2738 [Loc.] 9718 [Imp.]	2738 [Loc.] 9718 [Imp.]	2738 [Loc.] 9718 [Imp.]
<b>Diff Kit</b>		PQDK1 [Local – Borg Warner] PQDK2 [Imported]		PQDK1 [Local – Borg Warner] PQDK2 [Imported]	PQDK1 [Local – Borg Warner] PQDK2 [Imported]	PQDK1 [Local – Borg Warner] PQDK2 [Imported]

APPLICATIONS	LOCATION	NISSAN HARDBODY QW/D22 2.7D TD27i 3.0, i VG30E 3.0TD ZD30 3.2 QD32 3.3i VG33E	NISSAN SANI AW/D21 2.4, i Z24 2.5 TD25 2.7D, TD TD27 3.0 VG30E	NISSAN 4X4	NISSAN 4X4 1-TONNER/ HARDBODY AW/D21 2.4 Z24S 2.7 TD27 3.0 VG30E	NISSAN 4X4 HARDBODY QW/D22 2.4i KA24E 2.7 TD27 3.0 VG30E 3.0TD ZD30
<b>Years</b>		<b>98-10</b>	<b>89-99</b>		<b>88-98</b>	<b>98-10</b>
<b>Gearbox Bearings</b>		6306NRC3 6306ZZ 6305C3 B22-19C3 6205C3 62042RSC3	6306NRC3 6306ZZ 6305C3 B22-19C3 6205C3 62042RSC3		6306NRC3 6306ZZ 6305C3 B22-19C3 6205C3 62042RSC3	6306NRC3 6306ZZ 6305C3 B22-19C3 6205C3 62042RSC3
<b>Gearbox Oil Seal</b>	- Front	304508	304508		304508	304508
	- Rear	355010	355010		355010	355010
<b>Gearbox Kit</b>		<b>PQGBK4</b>	<b>PQGBK4</b>		<b>PQGBK4</b>	<b>PQGBK4</b>
<b>Diff Pinion Bearing</b>	- Front	86610/49 [Loc.] 802011+48 [Imp.]	86610/49 [Loc.] 802011+48 [Imp.]		86610/49 [Loc.] 802011+48 [Imp.]	86610/49 [Loc.] 802011+48 [Imp.]
	- Rear	88610/49 [Both]	88610/49 [Both]		88610/49 [Both]	88610/49 [Both]
<b>Diff Carrier Bearing</b>	- Left	501310/49 [Loc.] 102910/49 [Imp.]	501310/49 [Loc.] 102910/49 [Imp.]		501310/49 [Loc.] 102910/49 [Imp.]	501310/49 [Loc.] 102910/49 [Imp.]
	- Right	501310/49 [Loc.] 102910/49 [Imp.]	501310/49 [Loc.] 102910/49 [Imp.]		501310/49 [Loc.] 102910/49 [Imp.]	501310/49 [Loc.] 102910/49 [Imp.]
<b>Pinion Oil Seal</b>		2738 [Loc.] 9718 [Imp.]	2738 [Loc.] 9718 [Imp.]		2738 [Loc.] 9718 [Imp.]	2738 [Loc.] 9718 [Imp.]
<b>Diff Kit</b>		PQDK1 [Local – Borg Warner] PQDK2 [Imported]	PQDK1 [Local – Borg Warner] PQDK2 [Imported]		PQDK1 [Local – Borg Warner] PQDK2 [Imported]	PQDK1 [Local – Borg Warner] PQDK2 [Imported]



## GEARBOX & DIFFERENTIAL APPLICATIONS

APPLICATIONS	LOCATION	NISSAN 4X4 HARDBODY QW/D22 3.2 3.2D QD32 3.3i VG33 4.2 TD42	NISSAN 4X4 SANI AW/D21 Series 2.2 Z22 2.4 Z24 2.7 TD27 3.0 VG30E	TOYOTA COMMERCIAL	TOYOTA HIACE YH51/61 2.0 Wagon, P/van 3Y Pet. YH53/63 2.2 P/van, Van, Wagon 4Y Pet.	TOYOTA HILUX YN57 2.0 SR5, SRX P/up 3Y Pet. RZN147 2.0 D/cab, DLX, Raider, S, SR, SRX P/up1RZ Pet.
<b>Years</b>		<b>98-10</b>	<b>86-98</b>		<b>88-08</b>	<b>88-05</b>
<b>Gearbox Bearings</b>		<b>6306NRC3 6306ZZ 6305C3 B22-19C3 6205C3 62042RSC3</b>	<b>6306NRC3 6306ZZ 6305C3 B22-19C3 6205C3 62042RSC3</b>		<b>32TM03NXC3 30TM11NC3 NUPK2205 31RUKSS2NRJ</b>	<b>32TM03NXC3 30TM11NC3 NUPK2205 31RUKSS2NRJ</b>
<b>Gearbox Oil Seal</b>	- Front	<b>304508</b>	<b>304508</b>		<b>304508</b>	<b>304508</b>
	- Rear	<b>355010</b>	<b>355010</b>		<b>385811</b>	<b>385811</b>
<b>Gearbox Kit</b>		<b>PQGBK4</b>	<b>PQGBK4</b>		<b>PQGBK5</b>	<b>PQGBK5</b>
<b>Diff Pinion Bearing</b>	- Front	<b>86610/49 [Loc.] 802011+48 [Imp.]</b>	<b>86610/49 [Loc.] 802011+48 [Imp.]</b>		<b>86610/49 [Loc.] 802011+48 [Imp.]</b>	<b>86610/49 [Loc.] 802011+48 [Imp.]</b>
	- Rear	<b>88610/49 [Both]</b>	<b>88610/49 [Both]</b>		<b>88610/49 [Both]</b>	<b>88610/49 [Both]</b>
<b>Diff Carrier Bearing</b>	- Left	<b>501310/49 [Loc.] 102910/49 [Imp.]</b>	<b>501310/49 [Loc.] 102910/49 [Imp.]</b>		<b>501310/49 [Loc.] 102910/49 [Imp.]</b>	<b>501310/49 [Loc.] 102910/49 [Imp.]</b>
	- Right	<b>501310/49 [Loc.] 102910/49 [Imp.]</b>	<b>501310/49 [Loc.] 102910/49 [Imp.]</b>		<b>501310/49 [Loc.] 102910/49 [Imp.]</b>	<b>501310/49 [Loc.] 102910/49 [Imp.]</b>
<b>Pinion Oil Seal</b>		<b>2738 [Loc.] 9718 [Imp.]</b>	<b>2738 [Loc.] 9718 [Imp.]</b>		<b>2738 [Loc.] 9718 [Imp.]</b>	<b>2738 [Loc.] 9718 [Imp.]</b>
<b>Diff Kit</b>		<b>PQDK1 [Local – Borg Warner] PQDK2 [Imported]</b>	<b>PQDK1 [Local – Borg Warner] PQDK2 [Imported]</b>		<b>PQDK1 [Local – Borg Warner] PQDK2 [Imported]</b>	<b>PQDK1 [Local – Borg Warner] PQDK2 [Imported]</b>

APPLICATIONS	LOCATION	TOYOTA HILUX LN50/51/55 2.2 P/up L Dies. 2.4 D/cab, Raider P/up 2L Dies. YN58 2.2 Raider, SRX P/up 4Y Pet.	TOYOTA HILUX RN58 (94-98) 2.4 S P/up 22R Pet. LN140/145 2.4i DLX, P/up 2L Dies. RZN194 2.7i D/cab, Raider, SRX, Raider, P/up 3RZFE	TOYOTA QUANTUM 2.5 D-4D, "Family" S-long MPV, Van 2KD-FTV 2.7, "Family", S-long "Ses'fikile" MPV, Van 2TR-FE Pet. 2.5 D-4D P/van 2KD-FTV 2.7 P/van 2TR-FE	TOYOTA 4X4	TOYOTA 4X4 HILUX YN67 2.2 D/cab, Raider D/cab P/up 4Y Pet. LN65/RN67 2.4 D/cab, Raider D/cab P/up 2L Dies. 22R Pet.
<b>Years</b>		<b>88-98</b>	<b>94-05</b>	<b>2005-</b>		<b>88-98</b>
<b>Gearbox Bearings</b>		<b>32TM03NXC3 30TM11NC3 NUPK2205 31RUKSS2NRJ</b>	<b>32TM03NXC3 30TM11NC3 NUPK2205 31RUKSS2NRJ</b>			<b>32TM03NXC3 30TM11NC3 NUPK2205 31RUKSS2NRJ</b>
<b>Gearbox Oil Seal</b>	- Front	<b>304508</b>	<b>304508</b>			<b>304508 385811</b>
	- Rear	<b>385811</b>	<b>385811</b>			
<b>Gearbox Kit</b>		<b>PQGBK5</b>	<b>PQGBK5</b>			<b>PQGBK5</b>
<b>Diff Pinion Bearing</b>	- Front	<b>86610/49 [Loc.] 802011+48 [Imp.]</b>	<b>86610/49 [Loc.] 802011+48 [Imp.]</b>	<b>STA3072 [Loc.]</b>		<b>86610/49 [Loc.] 802011+48 [Imp.]</b>
	- Rear	<b>88610/49 [Both]</b>	<b>88610/49 [Both]</b>	<b>TR070904-1 [Loc.]</b>		<b>88610/49 [Both]</b>
<b>Diff Carrier Bearing</b>	- Left	<b>501310/49 [Loc.] 102910/49 [Imp.]</b>	<b>501310/49 [Loc.] 102910/49 [Imp.]</b>	<b>TR100802 [Loc.]</b>		<b>501310/49 [Loc.] 102910/49 [Imp.]</b>
	- Right	<b>501310/49 [Loc.] 102910/49 [Imp.]</b>	<b>501310/49 [Loc.] 102910/49 [Imp.]</b>			<b>501310/49 [Loc.] 102910/49 [Imp.]</b>
<b>Pinion Oil Seal</b>		<b>2738 [Loc.] 9718 [Imp.]</b>	<b>2738 [Loc.] 9718 [Imp.]</b>	<b>9359</b>		<b>2738 [Loc.] 9718 [Imp.]</b>
<b>Diff Kit</b>		<b>PQDK1 [Local – Borg Warner] PQDK2 [Imported]</b>	<b>PQDK1 [Local – Borg Warner] PQDK2 [Imported]</b>	<b>PQDK6 [Local – Borg Warner]</b>		<b>PQDK1 [Local – Borg Warner] PQDK2 [Imported]</b>

Vehicle Applications	Page
Alfa Romeo	1-3
Audi	4-14
BMW	15-24
C.A.M / Chana	25
Chery	26
Chevrolet	27-29
Chrysler	30-31
Citroen	32-34
Daewoo	35-36
Daihatsu	37-38
Dodge	39
Fiat	40-43
Ford	44-57
Geely / GWM	58-59
Honda	60-65
Hyundai	66-73
Isuzu / Iveco	74-79
Jeep	80-81
Kia	82-88
Land Rover / Lexus	89-92
Mahindra	93
Mazda	94-104
Mercedes-Benz	105-111
Mitsubishi	112-116
Nissan	117-131
Opel	132-139
Peugeot / Proton	140-144
Renault	145-154
Seat / Ssang Yong / Subaru / Suzuki / Tata	155-162
Toyota	163-190
Volkswagen	191-205
Volvo	206-212

APPLICATIONS	LOCATION	ALFA ROMEO 145 2.0 Quadrofolgio AR32301	ALFA ROMEO 146 2.0 Ti Twin Spark AR67204	ALFA ROMEO 147 1.6 Progression, TS AR32104 1.9 JTD 2.0 Distinctive, Selespeed TS AR3231	ALFA ROMEO 155 2.0 TS AR32301 2.5 V6 AR67301
		YEARS	96-01	96-99	01-10
Front Wheel Bearing	- Inner	12131ASB	12131 [Non ABS] 12131ASB [ASB]	40747 [1.6 and 1.9JTD]	12131 [2.0] 12131ASB [2.0 ASB] GB12955 [2.5]
	- Outer				
Front Wheel Oil Seal	- Inner	Sealed Bearing	Sealed Bearing	Sealed Bearing	Sealed Bearing
	- Outer				
Front Wheel Kit		PQ474	PQ472 [Non ABS] PQ474 [ASB]	PQ589 [1.6, 1.9JTD]	PQ472 [2.0] PQ474 [2.0 ASB] PQ477 [2.5]
Front Wheel Hub / Stub Axle					477HUB
Alternator / Generator Bearing	- Front				
	- Rear				
Concentric / Thurst Bearing		RB9816	RB9816	Concentric Slave Cylinder	RB9816 [2.0] RB9819 [2.5]
Diff Carrier Bearing	- Left				32009
	- Right				32009
Diff Pinion Bearing	- Front				
	- Rear				
Propshaft Support Bearing					
Pulley Bearing					
Spigot Shaft Bearing					
V-Belt Tensioner					
Drive Shaft Oil Seal	- Left	9960	9960	9960	9960 [2.0] 9959 [2.5]
	- Right	9959	9959	9959	9959 [2.0] 9961 [2.5]
Gearbox Oil Seal	- Front	9570	9570	9570	9570 [2.0]
	- Rear				
Pinion Oil Seal					
Spark Plug Tube Seal					
Rear Main Bearing Oil Seal		9958	9958	9958 [2.0]	9958 [2.0] 9962 [2.5]
Timing Cover / Cam Oil Seal		304207 [Cam] 9417 [Cam] 9957 [T/Cover]	304207 [Cam] 9417 [Cam] 9957 [T/Cover]	304207 [Cam] 9417 [Cam] 9957 [T/Cover]	304207 [Cam 2.0] 9417 [Cam 2.0] 9957 [T/Cover 2.0] 324710 [Aux. Shaft 2.5] 486510 [T/Cover 2.5] 9715 [Cam 2.5]
Rear Wheel Bearing	- Inner	HUB019 [with integrated ABS sensor]	HUB019 [with integrated ABS sensor] HUB021 [Gear type ABS]	HUB044 [99-06] Bearing ID: 35mm from Chassis: 3402368 [with integrated ABS sensor]HUB061 [2.0] Bearing ID: 35mm from Chassis: 3402367 [with integrated ABS sensor]	HUB021 [Gear type ABS] HUB022 [with integrated ABS sensor]
	- Outer				
Rear Wheel Oil Seal	- Inner	HUB UNIT	HUB UNIT	HUB UNIT	HUB UNIT
	- Outer				
Rear Wheel Kit		PQ465 [4 Studs]	PQ465 [4 Studs] PQ475 [4 Studs]	PQ590 [ID: 30mm] [ASB Chasis: 3402368] [5 Studs] PQ517 [ID: 35mm] [ASB Chasis: 3402367]	PQ475 [4 Studs] PQ476 [4 Studs]
Rear Wheel Hub / Stub Axle					

APPLICATIONS	LOCATION	ALFA ROMEO 156	ALFA ROMEO 159	ALFA ROMEO GTV / SPIDER 2.0	ALFA ROMEO GTV / SPIDER 3.0 V6
		2.0 Twin Spark Selespeed Sportswagon AR32301 2.5 V6 AR32401, AR3240 Sportswagon	1.8 TBi 1.9 JTS 2.2 JTS 2.4 JTDM Q-tronic 3.2 Distinctive, V6 Q4, V6 Ti		
YEARS		98-07	05-13	96-06	99-04
Front Wheel Bearing	- Inner	<b>HUB215</b> [with integrated ABS sensor]	<b>HUB218</b> [with integrated ABS sensor]	<b>12131</b> [Non ABS] <b>12131ASB</b> [ASB]	<b>GB12955</b> [99-03]
	- Outer				
Front Wheel Oil Seal	- Inner	HUB UNIT	HUB UNIT	Sealed Bearing	Sealed Bearing
	- Outer				
Front Wheel Kit		<b>PQ555</b> [4 Studs]	<b>PQ560</b> [5 Studs]	<b>PQ472</b> [Non ABS] <b>PQ474</b> [ASB]	<b>PQ477</b>
Front Wheel Hub / Stub Axle					<b>477HUB</b>
Alternator / Generator Bearing	- Front				
	- Rear				
Concentric / Thurst Bearing		<b>RB9816</b> [2.0] Concentric Slave Cylinder	Concentric Slave Cylinder	<b>RB9816</b>	
Diff Carrier Bearing	- Left				
	- Right				
Diff Pinion Bearing	- Front				
	- Rear				
Propshaft Support Bearing					
Pulley Bearing					
Spigot Shaft Bearing					
V-Belt Tensioner					
Drive Shaft Oil Seal	- Left	<b>9960</b> [2.0] <b>9959</b> [2.5]		<b>9960</b>	
	- Right	<b>9959</b> [2.0] <b>9961</b> [2.5]		<b>9959</b>	
Gearbox Oil Seal	- Front			<b>9570</b>	
	- Rear				
Pinion Oil Seal					
Spark Plug Tube Seal					
Rear Main Bearing Oil Seal		<b>9958</b> [2.0] <b>9962</b> [2.5]		<b>9958</b>	<b>9962</b>
Timing Cover / Cam Oil Seal		<b>304207</b> [Cam 2.0] <b>9417</b> [Cam 2.5] <b>9957</b> [T/Cover]		<b>304207</b> [Cam No. 1] <b>9417</b> [Cam No.2] <b>9957</b> [T/Cover]	<b>486510</b> [T/Cover]
Rear Wheel Bearing	- Inner	<b>HUB044</b> [99-06] Bearing ID: 35mm from 2004- Chassis: 644569 [with integrated ABS sensor] <b>HUB061</b> [2.5 V6] Bearing ID: 35mm [with integrated ABS sensor]	<b>HUB218</b> [3.2 JTS Q4] [with integrated ABS sensor] <b>HUB219</b> [with integrated ABS sensor]	<b>HUB037</b> [Non ABS]	<b>HUB037</b> [Non ABS]
	- Outer				
Rear Wheel Oil Seal	- Inner	HUB UNIT	HUB UNIT	HUB UNIT	HUB UNIT
	- Outer				
Rear Wheel Kit		<b>PQ590</b> [ID: 30mm] [ASB Chasis: 3402368] [5 Studs] <b>PQ517</b> [ID: 35mm] [ASB Chasis: 3402367]	<b>PQ560</b> [3.2 JTS Q4] [5 Studs] <b>PQ563</b> [5 Studs]	<b>PQ529</b>	<b>PQ529</b>
Rear Wheel Hub / Stub Axle					

APPLICATIONS	LOCATION	ALFA ROMEO GIULIETTA	ALFA ROMEO MITO		
		1.4 TB, Multiair, 940 A2.000, Progression 940 B7.000 1.8 TBi Quadrifoglio 940 A1.000	1.4 TB		
YEARS		2011-	2009-		
Front Wheel Bearing	- Inner	<b>HUB216</b> [with integrated ABS sensor]	<b>12131ASB</b> [ASB]		
	- Outer				
Front Wheel Oil Seal	- Inner	HUB UNIT	Sealed Bearing		
	- Outer				
Front Wheel Kit		<b>PQ546</b>	<b>PQ474</b> [ASB]		
Front Wheel Hub / Stub Axle					
Alternator / Generator Bearing	- Front				
	- Rear				
Concentric / Thurst Bearing			<b>Concentric Slave Cylinder</b>		
Diff Carrier Bearing	- Left				
	- Right				
Diff Pinion Bearing	- Front				
	- Rear				
Propshaft Support Bearing					
Pulley Bearing					
Spigot Shaft Bearing					
V-Belt Tensioner					
Drive Shaft Oil Seal	- Left				
	- Right				
Gearbox Oil Seal	- Front				
	- Rear				
Pinion Oil Seal					
Spark Plug Tube Seal					
Rear Main Bearing Oil Seal					
Timing Cover / Cam Oil Seal					
Rear Wheel Bearing	- Inner	<b>HUB217</b> [with integrated ABS sensor]	<b>HUB019</b> [with integrated ABS sensor]		
	- Outer				
Rear Wheel Oil Seal	- Inner	HUB UNIT	HUB UNIT		
	- Outer				
Rear Wheel Kit		<b>PQ547</b> [5 Studs]	<b>PQ465</b> [4 Studs]		
Rear Wheel Hub / Stub Axle					

APPLICATIONS	LOCATION	AUDI 100/4 1.6 LS YV 100/5 1.9 WH 200 2.1 GLS, GLX 400 1.8 JW 500 2.1/2.2 WB, WC SE PR	AUDI 500 2.2 E PR 2.3 E, SE, AAR 2.8 SEL AAH	AUDI A1 1.0 TFSi CHZB 1.2 TFSi CBZA 1.4 TFSi CAXA/CAVG 1.6 TDi CAYC 1.8 TFSi DAJB	AUDI A1 1.0 25 TFSi DKLA, DLAC 1.0 30 TFSi DKJA, DKRF 1.5 35 TFSi DADA, DPCA 2.0 40 TFSi CZPC, DKZC
YEARS		77-92	92-94	11-18	2018-
Front Wheel Bearing	- Inner	309245	633817	HUB103 [ID: 30mm] [with integrated ABS sensor] HUB108 [ID: 28.6mm] [with integrated ABS sensor]	HUB103 [with integrated ABS sensor] HUB412 [with integrated ABS sensor]
	- Outer				
Front Wheel Oil Seal	- Inner	Sealed Bearing	Sealed Bearing	HUB UNIT	HUB UNIT
	- Outer				
Front Wheel Kit		PQ105	PQ434 [ID: 43mm]	PQ701 [72mm] PQ688 [ID: 29mm] [4 Mount Holes]	PQ701 [72mm] PQ1146 [78mm]
Front Wheel Hub / Stub Axle			434HUB		
Alternator / Generator Bearing	- Front	62032RS			
	- Rear	62012RS			
Concentric / Thurst Bearing		RB9571	RB9854	RB9680	
Diff Carrier Bearing	- Left	501310/49 [Man.] 300811/49 [Auto.]	300811/49		
	- Right	501310/49 [Man.] 300811/49 [Auto.]	300811/49 [Man.] 501310/49 [Auto.]		
Diff Pinion Bearing	- Front	86610/49 [Auto.]			
	- Rear	332197 [Man.] 88010/49 [Auto.]			
Propshaft Support Bearing					
Pulley Bearing					
Spigot Shaft Bearing					
V-Belt Tensioner				VBT012 [1.4]	
Drive Shaft Oil Seal	- Left	456008 [Auto.]	456008		
	- Right	456008 [Auto.]	456008		
Gearbox Oil Seal	- Front	9757 [100 /400 /500]	9757		
	- Rear		9875 [Auto.]		
Pinion Oil Seal					
Spark Plug Tube Seal					
Rear Main Bearing Oil Seal		8510512	8510512	9589FS [1.0] 9573FS [1.2, 1.4 1.6] [PTFE Flange Seal]	9589FS
Timing Cover / Cam Oil Seal		324710 [Cam] 354810 [T/Cover 2.1]	324710 [Cam] 354810 [T/Cover]	9590 [Cam G/Box Side 1.0] 9591 [Cam Timing Side 1.0] 9548 [T/Cover 1.2, 1.6] 9549 [T/Cover 1.4]	9588
Rear Wheel Bearing	- Inner	331274	331274	HUB106 [with integrated ABS sensor]	HUB363 [with integrated ABS sensor]
	- Outer	11910/49	11910/49		
Rear Wheel Oil Seal	- Inner			HUB UNIT	HUB UNIT
	- Outer	405208SP	405208SP		
Rear Wheel Kit		PQ151	PQ151	PQ702 [5 Studs] [Flange Ø: 120mm]	PQ1065
Rear Wheel Hub / Stub Axle				SA702	



APPLICATIONS	LOCATION	AUDI A3 1.8 8L1 AGN 1.8T AGU, BPU	AUDI A3 2.0 FSi BVZ 2.0 FSi 8PA Sportback BLX 2.0 TFSi CCZA, CBFA 2.0 TDi BMM, CLJA 3.2 Quattro, DSG, BUB	AUDI A3 1.4 TFSi CMSA 1.6 TDi CAYC 1.8 TFSi CDAA 1.9 TDi BXE	AUDI A3 1.2 TFSi CJZJ, CJZA 1.4 TFSi CXSA 1.6 TDi CLHA 1.8 TFSi Quattro CJSA, CJSB 2.0 TDi DBGA
YEARS		98-04	03-13	08-13	12-17
Front Wheel Bearing	- Inner	40BWD06	HUB108 [with integrated ABS sensor] HUB177 [280mm Disc] [with integrated ABS sensor]	HUB108 [with integrated ABS sensor] HUB177 [280mm Disc] [with integrated ABS sensor]	HUB258 [288mm Disc] [with integrated ABS sensor] HUB259 [312mm Disc] [with integrated ABS sensor]
	- Outer				
Front Wheel Oil Seal	- Inner	Sealed Bearing	HUB UNIT	HUB UNIT	HUB UNIT
	- Outer				
Front Wheel Kit		PQ449	PQ688 [ID: 29mm] [4 Mount Holes] PQ664 [3 Mount Holes]	PQ688 [ID: 29mm] [4 Mount Holes] PQ664 [3 Mount Holes]	PQ845 [ID: 29mm] [Disc OD: 288mm] [3 Mount Holes] PQ846 [Disc OD: 312mm] [3 Mount Holes]
Front Wheel Hub / Stub Axle		449HUB [ABS Gear] [OD: 133mm]			
Concentric / Thrust Bearing		RB9855	Concentric Slave Cylinder RB9855 [2.0 FSi]	RB9680 [1.4 TFSi] RB9855 [1.6TDi, 1.9 TDi] Concentric Slave Cylinder [1.8 TFSi]	RB9855 RB9680 [1.2, 1.4] Concentric Slave Cylinder [2.0 TDi]
Diff Carrier Bearing	- Left	300811/49 [Man.] 501310/49 [Auto.]	300811/49 [5 Spd.] 503310/49 [6 Spd.]		
	- Right	300811/49 [Man.] 501310/49 [Auto.]	300811/49 [5 Spd.] VWDC487618 [6 Spd.]		
Diff Pinion Bearing	- Front	331274			
	- Rear				
V-Belt Tensioner		VBT001	VBT001 [2.0 FSi]	VBT012	
Drive Shaft Oil Seal	- Left	9302	486208 [5 Spd.] 607408 [6 Spd.] 9239 [Rr.]	486208 [1.4TFSi, 1.6TDi]	607408 [1.6]
	- Right	9302	486208 [5 Spd.] 506508 [Alt. 5 Spd.] 607408 [6 Spd.] 456008 [Rr.]	9230 [1.6] 486208 [1.4]	547308 [1.6]
Gearbox Oil Seal	- Front	223507	243806 [5 Spd.] 223507 [Alt. 5 Spd.] 284207 [6 Spd.]	243808 [1.6TDi]	
	- Rear				
Rear Main Bearing Oil Seal		8510512	9232FS [2.0 Pet] 9229FS [2.0 TDi] 9580FS [2.0 TDi Alt.] 9945FS [2.0 TFSi] 8510511 [3.2]	9229FS [1.9 TDi] 9573FS [1.4 TFSi] 9580FS [1.6 TDi] 9582FS [1.8 TFSi]	9585FS 9586FS [1.6TDi, Alt.] 9589FS [1.2, 1.4] 9592FS [1.8 TFSi]
Timing Cover / Cam Oil Seal		9548 [Cam] 9549 [T/Cover]	9548 [Cam] 9549 [T/Cover]	9548 [Cam 1.8, 1.9] 9549 [T/Cover 1.4, 1.6, 1.9] 9581 [T/Cover 1.8 TFSi]	9548 [Cam] 9590 [Cam 1.2, 1.4] 9591 [Cam 1.2, 1.4 Alt.] 9581 [T/Cover 1.8 TFSi] 9587FS [T/Cover] 9588 [T/Cover 1.2, 1.4]
Rear Wheel Bearing	- Inner	HUB095 [with ABS pulse ring] HUB102 [Non ABS]	HUB100 [2.0][with integrated ABS sensor] HUB108 [3.2][with integrated ABS sensor] HUB109 [with integrated ABS sensor]	HUB100 [with integrated ABS sensor] HUB109 [with integrated ABS sensor]	HUB100 [with integrated ABS sensor] HUB177 [280mm Disc] [with integrated ABS sensor] HUB258 [with integrated ABS sensor]
	- Outer				
Rear Wheel Oil Seal	- Inner	HUB UNIT	HUB UNIT	HUB UNIT	HUB UNIT
	- Outer				
Rear Wheel Kit		PQ450 [5 Studs] PQ684 [5 Studs]	PQ691 [ID: 30mm] [5 Studs] PQ688 [ID: 29mm] [4 Mount Holes] PQ689 [ID: 32mm] [5 Holes]	PQ691 [1.4, 1.6] [ID: 30mm] [5 Studs] PQ689 [ID: 32mm] [5 Holes]	PQ691 [ID: 30mm] [5 Studs] PQ664 [3 Mount Holes] PQ845 [Quattro] [3 Hole mounts]
Rear Wheel Hub / Stub Axle		SA450			

APPLICATIONS	LOCATION	AUDI A3 1.4 TFSi CZCA, CZEA 2.0TDi CRFC	AUDI A4 1.8 8D2, B5 Exec ADR 1.8T APU	AUDI A4 1.8T Avant, Multitronic, BFB, B6 AVJ 8E2 1.9 TDi AVF, Avant B6, 8E5, 8E2	AUDI A4 2.0 Multitronic Avant 8EC, 8E2 ALT 2.0 TDi 125, 8EC BLB, Avant Multitronic 2.0TFSi DTM 147 BGB
YEARS		13-17	95-01	00-08	00-08
Front Wheel Bearing	- Inner	HUB258 [288mm Disc] [with integrated ABS sensor] HUB259 [312mm Disc] [with integrated ABS sensor]	633816	40BWD06 HUB110 [4 Mount Holes]	HUB108 [with integrated ABS sensor]
	- Outer				
Front Wheel Oil Seal	- Inner	HUB UNIT	Sealed Bearing	Sealed Bearing HUB UNIT	HUB UNIT
	- Outer				
Front Wheel Kit		PQ845 [Disc OD: 288mm] [3 Mount Holes] PQ846 [Disc OD: 312mm] [3 Mount Holes]	PQ433	PQ449 PQ693 [ID: 43mm] [Non ASB]	PQ688 [ID: 29mm] [4 Mount Holes]
Front Wheel Hub / Stub Axle			433HUB	449HUB [ABS Gear] [OD: 133mm]	
Alternator / Generator Bearing	- Front				
	- Rear				
Concentric / Thurst Bearing			RB9854	RB9855	RB9855
Diff Carrier Bearing	- Left	300811/49 [13-17]	501310/49	300811/49 [Man.] 501310/49 [Auto.]	300811/49 [5 Spd.] 503310/49 [6 Spd.]
	- Right	300811/49 [13-17]	501310/49	300811/49 [Man.] 501310/49 [Auto.]	300811/49 [5 Spd.] VWDC487618 [6 Spd.]
Diff Pinion Bearing	- Front			331274	
	- Rear				
V-Belt Tensioner					
Drive Shaft Oil Seal	- Left	486207 [13-17] 607408 [2016-]	456008	9302	486208 [5 Spd.] 607408 [6 Spd.]
	- Right	486207 [13-17] 607408 [2016-]	456008	9302	486208 [5 Spd.] 506508 [Alt. 5 Spd.] 607408 [6 Spd.]
Gearbox Oil Seal	- Front	284207 [2016-]	9874	223507 9875	243806 [5 Spd.] 223507 [Alt. 5 Spd.] 284207 [6 Spd.]
	- Rear		9874		
Pinion Oil Seal			324710		
Spark Plug Tube Seal					
Rear Main Bearing Oil Seal		9573FS [13-17] 9586FS [2.0TDi] 9589FS [2016-]	8510512	8510512	9232FS [2.0 Pet] 9229FS [2.0 TDi]
Timing Cover / Cam Oil Seal		9549 [T/Cover] [2016-]	9548 [Cam,T/Cover,Aux.Shaft]	9548 [Cam] 9549 [T/Cover]	9548 [Cam] 9549 [T/Cover]
Rear Wheel Bearing	- Inner	HUB109 [with integrated ABS sensor]	331274	HUB095 [with ABS pulse ring] HUB102 [Non ABS] HUB133 [00-04] [Gear type ABS]	HUB100 [with integrated ABS sensor] HUB133 [Some] [Gear type ABS]
	- Outer		11910/49		
Rear Wheel Oil Seal	- Inner	HUB UNIT		HUB UNIT	HUB UNIT
	- Outer		405208SP		
Rear Wheel Kit		PQ691 [ID: 30mm] [5 Studs]	PQ151	PQ450 [5 Studs] PQ684 [5 Studs] PQ786 [Some]	PQ691 [ID: 30mm] [5 Studs] PQ786 [ID: 32mm] [5 Studs]
Rear Wheel Hub / Stub Axle			SA151		

APPLICATIONS	LOCATION	AUDI A4 3.2 FSi Quattro, 8EC Multitronic Avant, Tiptronic Avant, AUK	AUDI A4 2.4 Multitronic, BDV 3.0 Cabriolet ASN, 8H7 3.0 TDi 8EC Quattro BKN 3.0 TDi Quattro Avant Tiptronic, BKN, ASB	AUDI A4 2.5 TDi 8D/E2 Quattro AFB, Quattro Tiptronic 2.6 8D2 / 8D5 Exec. [95-00] 3.0 Quattro Tiptronic, ASN	AUDI A4 1.8 TFSi CABB, CDHB, CJEB, CDHA, CABA 2.0 T 2.0 TFSi CAEB, CDNC, GLC, CMGB 2.0 TDi BRD, CAGA, CJCA, CMEA, CMFA
YEARS		01-08	02-08	02-08	08-14
Front Wheel Bearing	- Inner	<b>HUB108</b> [with integrated ABS sensor] <b>HUB223</b> [with integrated ABS sensor] <b>HUB110</b> [4 Mount Holes]	<b>HUB110</b> [4 Mount Holes]	<b>633818</b> <b>HUB110</b> [4 Mount Holes]	<b>HUB110</b> [4 Mount Holes] <b>HUB223</b> [with integrated ABS sensor]
	- Outer				
Front Wheel Oil Seal	- Inner	HUB UNIT	HUB UNIT	HUB UNIT Sealed Bearing	HUB UNIT
	- Outer				
Front Wheel Kit		<b>PQ688</b> [ID: 29mm] [4 Mount Holes] <b>PQ694</b> [ID: 62mm] [4 Mount Holes] <b>PQ693</b> [ID: 43mm] [Non ASB]	<b>PQ693</b> [ID: 43mm] [Non ASB]	<b>PQ435</b> <b>PQ693</b> [Quattro] [ID: 43mm] [Non ASB]	<b>PQ693</b> [ID: 43mm] [Non ASB] <b>PQ694</b> [ID: 62mm]
Front Wheel Hub / Stub Axle		<b>694HUB</b> [42 Spline] <b>434HUB</b> [38 Spline]	<b>434HUB</b> [38 Spline]	<b>434HUB</b> [38 Spline]	<b>434HUB</b> [38 Spline] <b>694HUB</b> [42 Spline]
Concentric / Thrust Bearing		<b>Concentric Slave Cylinder</b>	<b>RB9854</b>		<b>RB9854</b>
Diff Carrier Bearing	- Left	<b>300811/49</b> [5 Spd.] <b>503310/49</b> [6 Spd.]	<b>32010</b>	<b>300811/49</b> [Man.] <b>501310/49</b> [Auto.]	
	- Right	<b>300811/49</b> [5 Spd.] <b>VWDC487618</b> [6 Spd.]	<b>503310/49</b>	<b>300811/49</b> [Man.] <b>501310/49</b> [Auto.]	
Diff Pinion Bearing	- Front			<b>30205</b>	
	- Rear				
Drive Shaft Oil Seal	- Left	<b>547308</b> [5 Spd.] <b>607408</b> [6 Spd.] <b>9239</b> [Rr.]	<b>9285</b> [Fr.] <b>456008</b> [Rr.] <b>9239</b> [Rr.]	<b>9285</b> [Fr.] <b>456008</b> [Rr.] <b>9239</b> [Rr.]	
	- Right	<b>547308</b> [5 Spd.] <b>607408</b> [6 Spd.]	<b>9285</b> [Fr.] <b>456008</b> [Rr.]	<b>9285</b> [Fr.] <b>456008</b> [Rr.]	
Gearbox Oil Seal	- Front	<b>243806</b> [5 Spd.] <b>223507</b> [Alt. 5 Spd.] <b>284207</b> [6 Spd.]	<b>9233</b>		
	- Rear			<b>9874</b>	
Pinion Oil Seal				<b>324710</b>	
Rear Main Bearing Oil Seal		<b>8510511</b>	<b>9242</b> <b>9284FS</b> [Alt.]	<b>9284FS</b> [2.5] <b>9990</b> [3.0]	<b>9580FS</b> [TDi] <b>9582FS</b> <b>9229FS</b> [2.0TFSi]
Timing Cover / Cam Oil Seal		<b>9548</b> [Cam] <b>9549</b> [T/Cover]	<b>9548</b> [Cam] <b>9241</b> [T/Cover 3.0] <b>9549</b> [T/Cover]	<b>9548</b> [Cam] <b>9593</b> [Cam 3.0] <b>9549</b> [T/Cover 2.5, 2.6, 2.8, 3.0] <b>9241</b> [T/Cover 2.7, 3.0]	<b>9548</b> [Cam] <b>9549</b> [T/Cover TDi] <b>9581</b> [T/Cover]
Rear Wheel Bearing	- Inner	<b>HUB108</b> [Quattro] [with integrated ABS sensor] <b>HUB109</b> [Std.] [with integrated ABS sensor] <b>HUB133</b> [Some] [Gear type ABS] <b>HUB223</b> [with integrated ABS sensor]	<b>HUB110</b> [4 Mount Holes] <b>HUB111</b> [2.4 & 3.0 pet] [Flange Ø: 130.8 mm] [with integrated ABS sensor] <b>HUB133</b> [Some] [With Gear type ABS]	<b>633816</b> [Quattro] <b>HUB110</b> [4 Mount Holes] <b>HUB133</b> [Some] [With Gear type ABS]	<b>HUB133</b> [With Gear type ABS] <b>HUB224</b> [with integrated ABS sensor]
	- Outer				
Rear Wheel Oil Seal	- Inner	HUB UNIT	Sealed Bearing [Quattro] HUB UNIT	Sealed Bearing [Quattro] HUB UNIT	HUB UNIT
	- Outer				
Rear Wheel Kit		<b>PQ688</b> [ID: 29mm] [4 Mount Holes] [Quattro] <b>PQ689</b> [ID: 32mm] [5 Holes] [Std. ASB] <b>PQ786</b> [Some] [ABS Gear] <b>PQ694</b> [Alt. Quattro]	<b>PQ693</b> [Quattro] [ID: 43mm] [Non ASB] <b>PQ736</b> [5 Holes] <b>PQ786</b> [Some]	<b>PQ433</b> [Quattro] <b>PQ693</b> [Quattro] [ID: 43mm] [Non ASB] <b>PQ786</b> [Some]	<b>PQ786</b> [Flange Ø: 130mm] <b>PQ695</b> [5 Studs] [Flange Ø: 142mm]
Rear Wheel Hub / Stub Axle		<b>694HUB</b> [42 Spline]	<b>434HUB</b> [38 Spline]	<b>433HUB</b> <b>434HUB</b> [38 Spline]	

APPLICATIONS	LOCATION	AUDI A4 2.0 TFSi Quattro CPMA, CDNC 2.0 TDi Quattro CGLC 3.0 TDi Quattro CAPA, CCLA, CCWA, CDUC, CKVB, CKVC	AUDI A4 3.2 FSi 3.2 FSi Quattro AUK, CALA	AUDI A5 2.0 TFSi, TDi 2.0 TFSi Quattro 3.0 TDi Quattro 3.2 FSi Quattro	AUDI A6 2.8 Quattro 4A, AAH, ACK 3.0 Quattro Tiptronic BBJ
YEARS		08-14	06-12	08-14	94-00
Front Wheel Bearing	- Inner	<b>HUB223</b> [with integrated ABS sensor]	<b>HUB110</b> [4 Mount Holes] <b>HUB223</b> [with integrated ABS sensor]	<b>HUB223</b> [with integrated ABS sensor]	<b>633817</b> <b>HUB110</b> [4 Mount Holes]
	- Outer				
Front Wheel Oil Seal	- Inner	HUB UNIT	HUB UNIT	HUB UNIT	Sealed Bearing HUB UNIT
	- Outer				
Front Wheel Kit		<b>PQ694</b> [ID: 62mm]	<b>PQ693</b> [ID: 43mm] [Non ASB] <b>PQ694</b> [ID: 62mm][Quattro]	<b>PQ694</b> [ID: 62mm]	<b>PQ434</b> [ID: 43mm] <b>PQ693</b> [ID: 43mm] [Non ASB]
Front Wheel Hub / Stub Axle		<b>694HUB</b> [42 Spline]	<b>434HUB</b> [38 Spline] <b>694HUB</b> [42 Spline]	<b>694HUB</b> [42 Spline]	<b>434HUB</b> [38 Spline]
Alternator / Generator Bearing	- Front				
	- Rear				
Concentric / Thurst Bearing				<b>RB9854</b>	<b>RB9854</b>
Diff Carrier Bearing	- Left				<b>300811/49</b> [Man.] <b>501310/49</b> [Auto.]
	- Right				<b>300811/49</b> [Man.] <b>501310/49</b> [Auto.]
Diff Pinion Bearing	- Front				<b>30205</b>
	- Rear				
Propshaft Support Bearing					
Pulley Bearing					
Spigot Shaft Bearing					
V-Belt Tensioner					
Drive Shaft Oil Seal	- Left				<b>456008</b>
	- Right				<b>456008</b>
Gearbox Oil Seal	- Front				<b>9924</b>
	- Rear				<b>9874</b>
Pinion Oil Seal					<b>324710</b>
Spark Plug Tube Seal					
Rear Main Bearing Oil Seal		<b>9242</b> [3.0 08-12] <b>9580FS</b> [TDi] <b>9584</b> [3.0 12-14] <b>9582FS</b>	<b>9242</b>	<b>9242</b> [TDi & 3.2 FSi] <b>9580FS</b> [2.0 TDi] <b>9582FS</b> [TFSi] <b>9584</b> [3.0 TDi 12 - 14]	<b>9945FS</b>
Timing Cover / Cam Oil Seal		<b>9548</b> [Cam] <b>9241</b> [T/Cover 3.0] <b>9549</b> [T/Cover TDi] <b>9581</b> [T/Cover]	<b>9226FS</b> [T/Cover 07-08] <b>9581</b> [T/Cover 08-12]	<b>9548</b> [Cam] <b>9226FS</b> [T/Cover 3.2] <b>9241</b> [T/Cover TDi] <b>9549</b> [T/Cover 2.0 TDi] <b>9581</b> [T/Cover TFSi] <b>9583</b> [T/Cover 3.0 TDi 12 - 14]	<b>9548</b> [Cam] <b>9549</b> [T/Cover]
Rear Wheel Bearing	- Inner	<b>HUB223</b> [with integrated ABS sensor]	<b>HUB110</b> [4 Mount Holes] <b>HUB133</b> [with ABS sensor ring] <b>HUB223</b> [with integrated ABS sensor]	<b>HUB223</b> [with integrated ABS sensor] <b>HUB224</b> [with integrated ABS sensor]	<b>633816</b> <b>HUB111</b> [Flange Ø: 130.8 mm] [with integrated ABS sensor]
	- Outer				
Rear Wheel Oil Seal	- Inner	HUB UNIT	HUB UNIT	HUB UNIT	Sealed Bearing HUB UNIT
	- Outer				
Rear Wheel Kit		<b>PQ694</b> [ID: 62mm]	<b>PQ693</b> [Quattro] [ID: 43mm] <b>PQ786</b> [5 Holes] <b>PQ694</b> [Quattro] [ID: 62mm]	<b>PQ694</b> [ID: 62mm] [Quattro] <b>PQ695</b>	<b>PQ433</b> <b>PQ736</b> [5 Holes]
Rear Wheel Hub / Stub Axle		<b>694HUB</b> [42 Spline]	<b>434HUB</b> [38 Spline] <b>694HUB</b> [42 Spline]	<b>694HUB</b> [42 Spline]	<b>433HUB</b>

APPLICATIONS	LOCATION	AUDI A6	AUDI A6	AUDI A6	AUDI A6
		2.4 Avant Multitronic., Tiptronic, AGA, ALF, AML, APS, ARJ 2.5TDi Multitronic Avant SW., BCZ/BDG/ BFC 2.6 ABC	2.7T Quattro AJK, ARE, BES	4.2 Quattro Tiptronic ARS	2.4 BDV 2.5 TDi BCZ, BDG, BFC
YEARS		97-03	00-06	00-08	02-05
Front Wheel Bearing	- Inner	633817	633817 HUB110 [4 Mount Holes]	HUB110 [4 Mount Holes]	633817 [2.4] HUB110 [4 Mount Holes]
	- Outer				
Front Wheel Oil Seal	- Inner	Sealed Bearing	Sealed Bearing HUB UNIT	HUB UNIT	Sealed Bearing HUB UNIT
	- Outer				
Front Wheel Kit		PQ434 [ID: 43mm]	PQ434 [16"] [ID: 43mm] PQ693 [17"or 18"] [ID: 43mm] [Non ASB]	PQ693 [ID: 43mm] [Non ASB]	PQ434 [16"] [ID: 43mm] [2.4] PQ693 [17"or 18"] [ID: 43mm] [Non ASB]
Front Wheel Hub / Stub Axle		434HUB [38 Spline]	434HUB [38 Spline]	434HUB [38 Spline]	434HUB [38 Spline]
Alternator / Generator Bearing	- Front				
	- Rear				
Concentric / Thurst Bearing		RB9854	Auto.		RB9854 [2.4]
Diff Carrier Bearing	- Left	300811/49 [Man.] 501310/49 [Auto.]	300811/49	300811/49 [Man.] 501310/49 [Auto.]	
	- Right	300811/49 [Man.] 501310/49 [Auto.]	300811/49	300811/49 [Man.] 501310/49 [Auto.]	
Diff Pinion Bearing	- Front	30205	30205	30205	
	- Rear				
Propshaft Support Bearing					
Pulley Bearing					
Spigot Shaft Bearing					
V-Belt Tensioner					
Drive Shaft Oil Seal	- Left	456008	9594	456008	9594
	- Right	456008	9594	456008	9594
Gearbox Oil Seal	- Front	9924	9924	9924	
	- Rear	9874	9874	9874	
Pinion Oil Seal		324710	324710	324710	
Spark Plug Tube Seal					
Rear Main Bearing Oil Seal			9242	9206FS	9997FS
Timing Cover / Cam Oil Seal		9548 [Cam] 9549 [T/Cover]	9548 [Cam] 9241 [T/Cover]	9548 [Cam] 9549 [T/Cover]	9548 [Cam] [2.4] 9549 [T/Cover]
Rear Wheel Bearing	- Inner	331274 [Std] 633816 [Quattro]	633817 HUB078 HUB110 [4 Mount Holes]	HUB110 [4 Mount Holes]	HUB111 [Flange Ø: 130.8 mm] [with integrated ABS sensor]
	- Outer	11910/49 [Std]			
Rear Wheel Oil Seal	- Inner	405208SP [Std] Sealed Bearing [Quattro]	Sealed Bearing HUB UNIT	HUB UNIT	HUB UNIT
	- Outer				
Rear Wheel Kit		PQ151 [Std] PQ433 [Quattro]	PQ434 [16"] [ID: 43mm] PQ592 PQ693 [17"or 18"] [ID: 43mm] [Non ASB]	PQ693 [ID: 43mm] [Non ASB]	PQ736 [5 Holes]
Rear Wheel Hub / Stub Axle		433HUB	434HUB [38 Spline]	434HUB [38 Spline]	



APPLICATIONS	LOCATION	AUDI A6 2.4 BDW 3.2 FSi AUK	AUDI A6 2.7 TDi BPP, CANA 2.8 FSi BDx, CCEA 3.0 TDi Quattro ASB 3.0 TFSi Quattro CAJA, CDYA, CDYC	AUDI A6 2.0 TFSi BPJ	AUDI A6 2.0 TDi CGLC, CMGB 2.0 TFSi CDNb
		YEARS	04-09	06-11	09-11
Front Wheel Bearing	- Inner	<b>HUB260</b> [with integrated ABS sensor]	<b>HUB262</b> [with integrated ABS sensor]	<b>HUB260</b> [with integrated ABS sensor]	<b>HUB223</b> [with integrated ABS sensor]
	- Outer				
Front Wheel Oil Seal	- Inner	HUB UNIT	HUB UNIT	HUB UNIT	HUB UNIT
	- Outer				
Front Wheel Kit		<b>PQ847</b> [ID: 43mm]	<b>PQ849</b> [ID: 45mm]	<b>PQ847</b> [ID: 43mm]	<b>PQ694</b> [ID: 62mm]
Front Wheel Hub / Stub Axle		<b>847HUB</b>		<b>847HUB</b>	<b>694HUB</b> [42 Spline]
Alternator / Generator Bearing	- Front				
	- Rear				
Concentric / Thurst Bearing		<b>RB9854</b> [2.4]			
Diff Carrier Bearing	- Left				
	- Right				
Diff Pinion Bearing	- Front				
	- Rear				
Propshaft Support Bearing					
Pulley Bearing					
Spigot Shaft Bearing					
V-Belt Tensioner					
Drive Shaft Oil Seal	- Left	<b>9594</b> [2.4]	<b>9594</b> [2.7 TDi, 2.8 FSi]	<b>9594</b>	<b>9594</b> [TFSi]
	- Right	<b>9594</b> [2.4]	<b>9594</b> [2.7 TDi, 2.8 FSi]	<b>9594</b>	<b>9594</b> [TFSi]
Gearbox Oil Seal	- Front				
	- Rear				
Pinion Oil Seal					
Spark Plug Tube Seal					
Rear Main Bearing Oil Seal		<b>9242</b> [2.4]	<b>9242</b>	<b>9945FS</b>	<b>9580FS</b> [TDi] <b>9582FS</b> [TFSi]
Timing Cover / Cam Oil Seal			<b>9241</b> [T/Cover]	<b>9548</b> [Cam] <b>9549</b> [T/Cover]	<b>9548</b> [Cam] <b>9549</b> [T/Cover TDi] <b>9581</b> [T/Cover TFSi]
Rear Wheel Bearing	- Inner	<b>HUB261</b> [with integrated ABS sensor]	<b>HUB261</b> [2.7 TDi, 2.8 FSi] [with integrated ABS sensor] <b>HUB262</b> [3.0 TDi, TFSi] [with integrated ABS sensor]	<b>HUB261</b> [with integrated ABS sensor]	<b>HUB224</b> [with integrated ABS sensor]
	- Outer				
Rear Wheel Oil Seal	- Inner	HUB UNIT	HUB UNIT	HUB UNIT	HUB UNIT
	- Outer				
Rear Wheel Kit		<b>PQ848</b>	<b>PQ848</b> [2.7 TDi, 2.8 FSi] <b>PQ849</b> [ID: 45mm] [3.0 TDi, TFSi]	<b>PQ848</b>	<b>PQ695</b>
Rear Wheel Hub / Stub Axle					

APPLICATIONS	LOCATION	AUDI A6	AUDI A8	AUDI S3	AUDI S3
		3.0 TDi CLAB 3.0 TDi Quattro CDUC, CDUD, CKVB, CKVC 3.0 TFSi Quattro CGWB, CGWD, CGXB, CTUA	3.7 Tiptronic AQC, 4D2 4.2 Quattro 4E2/8 BFM	1.8T 8L1 Quattro AMK, BAM, APY	2.0TFSi CDLC
YEARS		11-14	95-02	00-04	07-13
Front Wheel Bearing	- Inner	<b>HUB223</b> [with integrated ABS sensor]	<b>633817</b> [Std.] <b>HUB074</b> [Quattro]	<b>40BWD06</b>	<b>HUB108</b> [with integrated ABS sensor]
	- Outer				
Front Wheel Oil Seal	- Inner	HUB UNIT	Sealed Bearing HUB UNIT	Sealed Bearing	HUB UNIT
	- Outer				
Front Wheel Kit		<b>PQ694</b> [ID: 62mm]	<b>PQ434</b> [ID: 43mm] <b>PQ501</b> [Quattro]	<b>PQ449</b>	<b>PQ688</b> [ID: 29mm] [4 Mount Holes]
Front Wheel Hub / Stub Axle		<b>694HUB</b> [42 Spline]	<b>434HUB</b> [38 Spline]	<b>449HUB</b> [ABS Gear] [OD: 133mm]	
Alternator / Generator Bearing	- Front				
	- Rear				
Concentric / Thrust Bearing					<b>Concentric Slave Cylinder</b>
Diff Carrier Bearing	- Left		<b>300811/49</b> [Man.] <b>501310/49</b> [Auto.]	<b>300811/49</b> [Man.] <b>501310/49</b> [Auto.]	<b>503310/49</b>
	- Right		<b>300811/49</b> [Man.] <b>501310/49</b> [Auto.]	<b>300811/49</b> [Man.] <b>501310/49</b> [Auto.]	<b>VWDC487618</b>
Diff Pinion Bearing	- Front		<b>30205</b>	<b>331274</b>	
	- Rear				
Propshaft Support Bearing					
Pulley Bearing					
Spigot Shaft Bearing					
V-Belt Tensioner				<b>VBT001</b>	
Drive Shaft Oil Seal	- Left		<b>456008</b>	<b>456008</b>	<b>546808</b> [Front] <b>9239</b> [Rear]
	- Right		<b>456008</b>	<b>456008</b>	<b>9239</b> [Front/ Rear]
Gearbox Oil Seal	- Front		<b>9924</b>	<b>9874</b>	<b>284207</b>
	- Rear		<b>9874</b>	<b>9874</b>	
Pinion Oil Seal			<b>324710</b>		
Spark Plug Tube Seal					
Rear Main Bearing Oil Seal		<b>9242</b>	<b>9206FS</b>	<b>8510512</b>	<b>9945FS</b>
Timing Cover / Cam Oil Seal		<b>9241</b> [T/Cover] <b>9226FS</b> [T/Cover TFSi]	<b>9548</b> [Cam] <b>9547</b> [T/Cover]	<b>9548</b> [Cam,T/Cover, Aux.Shaft]	<b>9549</b> [T/Cover]
Rear Wheel Bearing	- Inner	<b>HUB223</b> [with integrated ABS sensor] <b>HUB224</b> [with integrated ABS sensor]	<b>633817</b> [Std.] <b>HUB074</b> [Quattro]	<b>40BWD06</b>	<b>HUB108</b> [with integrated ABS sensor]
	- Outer				
Rear Wheel Oil Seal	- Inner	HUB UNIT	Sealed Bearing [Std.] HUB UNIT	Sealed Bearing	HUB UNIT
	- Outer				
Rear Wheel Kit		<b>PQ694</b> [ID: 62mm] [Quattro] <b>PQ695</b>	<b>PQ434</b> [ID: 43mm] <b>PQ501</b> [Quattro]	<b>PQ449</b>	<b>PQ688</b> [ID: 29mm] [4 Mount Holes]
Rear Wheel Hub / Stub Axle		<b>694HUB</b> [42 Spline]		<b>449HUB</b> [ABS Gear] [OD: 133mm]	

<b>APPLICATIONS</b>	<b>LOCATION</b>	<b>AUDI S3 2.0 TFSi CJXB</b>	<b>AUDI S4 2.2T Quattro AAN</b>	<b>AUDI S4 4.2 Quattro, Avant 8E2/E5, S/W, BBK, AQF</b>	<b>AUDI TT 1.8T Coupe, Sport, Roadster, Coupe 8N3/9 APX 1.8T Quattro APX, BAM, BFV</b>
<b>YEARS</b>		<b>13-17</b>	<b>92-95</b>	<b>03-08</b>	<b>00-07</b>
<b>Front Wheel Bearing</b>	- Inner	<b>HUB258</b> [3 Mount Holes] [288mm Front Disc] <b>HUB259</b> [312mm Front Disc]	<b>633817</b> [ID: 43mm]	<b>HUB074</b>	<b>40BWD06</b>
	- Outer				
<b>Front Wheel Oil Seal</b>	- Inner	HUB UNIT	Sealed Bearing	HUB UNIT	Sealed Bearing
	- Outer				
<b>Front Wheel Kit</b>		<b>PQ845 PQ846</b>	<b>PQ434</b>	<b>PQ501</b>	<b>PQ449</b>
<b>Front Wheel Hub / Stub Axle</b>			<b>434HUB</b> [38 Spline]		<b>449HUB</b> [ABS Gear] [OD: 133mm]
<b>Alternator / Generator Bearing</b>	- Front				
	- Rear				
<b>Concentric / Thurst Bearing</b>		<b>Concentric Slave Cylinder</b>	<b>RB9854</b>		<b>RB9855</b>
<b>Diff Carrier Bearing</b>	- Left		<b>300811/49</b> [Man.] <b>501310/49</b> [Auto.]	<b>300811/49</b> [5 Spd.] <b>503310/49</b> [6 Spd.]	<b>300811/49</b>
	- Right		<b>300811/49</b> [Man.] <b>501310/49</b> [Auto.]	<b>300811/49</b> [5 Spd.] <b>VWDC487618</b> [6 Spd.]	<b>300811/49</b>
<b>Diff Pinion Bearing</b>	- Front		<b>30205</b>	<b>30205</b>	
	- Rear				
<b>Propshaft Support Bearing</b>					
<b>Pulley Bearing</b>					
<b>Spigot Shaft Bearing</b>					
<b>V-Belt Tensioner</b>					
<b>Drive Shaft Oil Seal</b>	- Left	<b>607408</b>	<b>456008</b>	<b>456008</b>	<b>486207</b>
	- Right	<b>547308</b>	<b>456008</b>	<b>456008</b>	<b>486207</b>
<b>Gearbox Oil Seal</b>	- Front		<b>9924</b>	<b>9924</b>	<b>223507</b>
	- Rear		<b>9874</b>	<b>9874</b>	
<b>Pinion Oil Seal</b>			<b>324710</b>	<b>324710</b>	
<b>Spark Plug Tube Seal</b>					
<b>Rear Main Bearing Oil Seal</b>		<b>9592FS</b>	<b>8510512</b>	<b>9206FS</b>	<b>9945FS</b> [Quattro]
<b>Timing Cover / Cam Oil Seal</b>			<b>9548</b> [Cam] <b>9549</b> [T/Cover]	<b>9548</b> [Cam] <b>9282</b> [T/Cover]	<b>9548</b> [Cam] <b>9549</b> [T/Cover]
<b>Rear Wheel Bearing</b>	- Inner	<b>HUB177</b> [ID: 29mm] [with integrated ABS sensor] <b>HUB258</b> [288mm Front Disc]	<b>633817</b>	<b>HUB074</b>	<b>40BWD06</b> <b>HUB095</b> [with ABS pulse ring]
	- Outer				
<b>Rear Wheel Oil Seal</b>	- Inner	HUB UNIT	Sealed Bearing	HUB UNIT	HUB UNIT
	- Outer				
<b>Rear Wheel Kit</b>		<b>PQ664</b> [3 Mount Holes] <b>PQ845</b> [3 Mount Holes]	<b>PQ434</b>	<b>PQ501</b>	<b>PQ449</b> [Quattro] <b>PQ450</b> [5 Studs]
<b>Rear Wheel Hub / Stub Axle</b>			<b>434HUB</b> [38 Spline]		<b>449HUB</b> [ABS Gear] [OD: 133mm] <b>SA450</b>

APPLICATIONS	LOCATION	AUDI TT	AUDI TT	AUDI TT	AUDI Q3
		2.0 TFSi BWA 2.0 TTS Quattro CDLA, CDMA	3.2 Coupe, Roadster DSG, BHE, BUB	1.8 TFSi CDAA 2.0 TFSi Quattro CCSA, CETA 2.5 RS Quattro CEPA	2.0 TDi CFFB, CLJA 2.0 TDi Quattro CFGC, CLLB 2.0 TFSi Quattro CCZC, CPSA
YEARS		06-10	04-10	10-15	12-15
Front Wheel Bearing	- Inner	<b>HUB108</b> [with integrated ABS sensor]	<b>HUB108</b> [with integrated ABS sensor]	<b>HUB108</b> [with integrated ABS sensor]	<b>HUB108</b> [with integrated ABS sensor]
	- Outer				
Front Wheel Oil Seal	- Inner	HUB UNIT	HUB UNIT	HUB UNIT	HUB UNIT
	- Outer				
Front Wheel Kit		<b>PQ688</b> [ID: 29mm] [4 Mount Holes]	<b>PQ688</b> [ID: 29mm] [4 Mount Holes]	<b>PQ688</b> [ID: 29mm] [4 Mount Holes]	<b>PQ688</b> [ID: 29mm] [4 Mount Holes]
Front Wheel Hub / Stub Axle					
Alternator / Generator Bearing	- Front				
	- Rear				
Concentric / Thrust Bearing		<b>RB9855</b>	<b>RB9855</b> Concentric Slave Cylinder	<b>RB9855</b>	<b>Concentric Slave</b> Cylinder
Diff Carrier Bearing	- Left	<b>300811/49</b> [5 Spd.] <b>503310/49</b> [6 Spd.]	<b>300811/49</b> [5 Spd.] <b>503310/49</b> [6 Spd.]	<b>300811/49</b> [5 Spd.] <b>503310/49</b> [6 Spd.]	
	- Right	<b>300811/49</b> [5 Spd.] <b>VWDC487618</b> [6 Spd.]	<b>300811/49</b> [5 Spd.] <b>VWDC487618</b> [6 Spd.]	<b>300811/49</b> [5 Spd.] <b>VWDC487618</b> [6 Spd.]	
Diff Pinion Bearing	- Front				
	- Rear				
Propshaft Support Bearing					
Spigot Shaft Bearing					
V-Belt Tensioner					
Drive Shaft Oil Seal	- Left		<b>547308</b> [5 Spd.] <b>607408</b> [6 Spd.]	<b>486208</b> [5 Spd.] <b>607408</b> [6 Spd.]	
	- Right	<b>486208</b> [5 Spd.] <b>607408</b> [6 Spd.]	<b>547308</b> [5 Spd.] <b>607408</b> [6 Spd.]	<b>486208</b> [5 Spd.] <b>607408</b> [6 Spd.]	
Gearbox Oil Seal	- Front	<b>486208</b> [5 Spd.] <b>607408</b> [6 Spd.]	<b>243806</b> [5 Spd.] <b>223507</b> [Alt. 5 Spd.] <b>284207</b> [6 Spd.]	<b>243806</b> [5 Spd.] <b>223507</b> [Alt. 5 Spd.] <b>284207</b> [6 Spd.]	
	- Rear	<b>243806</b> [5 Spd.] <b>223507</b> [Alt. 5 Spd.] <b>284207</b> [6 Spd.]			
Pinion Oil Seal					
Rear Main Bearing Oil Seal		<b>9945FS</b>	<b>8510511</b>	<b>9582FS</b> <b>9584</b> [2.5]	<b>9580FS</b> [2.0 TDi] <b>9582FS</b> [2.0 TFSi]
Timing Cover / Cam Oil Seal		<b>9548</b> [Cam] <b>9549</b> [T/Cover]	<b>9548</b> [Cam] <b>9549</b> [T/Cover]	<b>9548</b> [Cam] <b>9581</b> [T/Cover]	<b>9548</b> [Cam TDi] <b>9549</b> [T/Cover 2.0 TDi] <b>9581</b> [T/Cover 2.0 TFSi]
Rear Wheel Bearing	- Inner	<b>HUB100</b> [with integrated ABS sensor] <b>HUB108</b> [with integrated ABS sensor] <b>HUB109</b> [with integrated ABS sensor]	<b>HUB109</b> [with integrated ABS sensor]	<b>HUB108</b> [with integrated ABS sensor] <b>HUB109</b> [with integrated ABS sensor]	<b>HUB108</b> [with integrated ABS sensor] <b>HUB109</b> [with integrated ABS sensor]
	- Outer				
Rear Wheel Oil Seal	- Inner	HUB UNIT	HUB UNIT	HUB UNIT	HUB UNIT
	- Outer				
Rear Wheel Kit		<b>PQ691</b> [5 Studs] <b>PQ688</b> [ID: 29mm] [4 Mount Holes][Quattro] <b>PQ689</b> [ID: 32mm] [5 Holes]	<b>PQ689</b> [ID: 32mm] [5 Holes]	<b>PQ688</b> [ID: 29mm] [4 Mount Holes] [2.0 TFSi Quattro] <b>PQ689</b> [ID: 32mm] [5 Holes]	<b>PQ688</b> [ID: 29mm] [4 Mount Holes] <b>PQ689</b> [ID: 32mm] [5 Holes]
Rear Wheel Hub / Stub Axle					

APPLICATIONS	LOCATION	AUDI Q5	AUDI Q7		
		2.0 TDi CAHA, CGLB, CMGA, CGLC, CMGB 2.0 TDi, TFSi Quattro 2.0 TFSi CDNB, CNCB, CNCD, CAEB, CPME 3.0 TDi Quattro 3.2 FSi Quattro CALB, CPNB	3.0 TDi BUG, CJGD, CLZB, CRCA, CASA, CCMA, CJGA, CNRB 3.0 TDi, TFSi Quattro 3.0 TFSi CJTB, CJWB, CNAA, CTWA 3.6 FSi Quattro BHK 4.2 FSi, TDi Quattro BAR, CCFA, CCFC, BTR 6.0 TDi Quattro		
YEARS		09-14	06-15		
Front Wheel Bearing	- Inner	<b>HUB223</b> [with integrated ABS sensor]	<b>DAC51VWASB</b>		
	- Outer				
Front Wheel Oil Seal	- Inner	HUB UNIT	Sealed Bearing		
	- Outer				
Front Wheel Kit		<b>PQ694</b> [ID: 62mm]	<b>PQ708</b>		
Front Wheel Hub / Stub Axle		<b>694HUB</b> [42 Spline]	<b>708HUB</b>		
Alternator / Generator Bearing	- Front				
	- Rear				
Concentric / Thurst Bearing		<b>RB9006</b>			
Diff Carrier Bearing	- Left				
	- Right				
Diff Pinion Bearing	- Front				
	- Rear				
Propshaft Support Bearing					
Pulley Bearing					
Spigot Shaft Bearing					
V-Belt Tensioner					
Drive Shaft Oil Seal	- Left				
	- Right				
Gearbox Oil Seal	- Front				
	- Rear				
Pinion Oil Seal					
Spark Plug Tube Seal					
Rear Main Bearing Oil Seal		<b>9580FS</b> [2.0 TDi] <b>9582FS</b> [2.0 TFSi 09-13] <b>9592FS</b> [2.0 TFSi 13-14] <b>9242</b> [3.0 TDi 09-13 & 3.2 FSi] <b>9584</b> [3.0 TDi 13-14]			
Timing Cover / Cam Oil Seal		<b>9226FS</b> [T/Cover 2.0 TFSi 13-14 & 3.2 FSi] <b>9241</b> [T/Cover 3.0 TDi] <b>9548</b> [Cam TDi] <b>9549</b> [T/Cover 2.0 TDi] <b>9581</b> [T/Cover 2.0 TFSi 09-13]			
Rear Wheel Bearing	- Inner	<b>HUB223</b> [with integrated ABS sensor]	<b>DAC51VWASB</b>		
	- Outer				
Rear Wheel Oil Seal	- Inner	HUB UNIT	Sealed Bearing		
	- Outer				
Rear Wheel Kit		<b>PQ694</b> [ID: 62mm]	<b>PQ708</b>		
Rear Wheel Hub / Stub Axle		<b>694HUB</b> [42 Spline]	<b>708HUB</b>		

APPLICATIONS	LOCATION	BMW 1 SERIES E87	BMW 1 SERIES F20/1	BMW 2 SERIES F45	BMW 3 SERIES E30
		116i 1.6 N45 118i 2.0 N46 120i 2.0 N46 120d 2.0 N47 130i 3.0 N52	116i 1.6 N13 118i 1.6 N13 120d 2.0 N47 125i 2.0 N20	218i 1.5i B38A15A 220d 2.0i B47C20A, B47C20B 220i 2.0i B48A20A, B48A20F 225i 2.0i B48A20B	316 1.8 M10 316i 1.6 M40 318i 1.8 M40 320i M20/50 323i M50 325i M52 333i M30
YEARS		04-15	11-16	15-18	83-92
Front Wheel Bearing	- Inner	<b>HUB127</b> [with integrated ABS sensor]	<b>HUB263</b> [with integrated ABS sensor]	<b>HUB400</b>	<b>309971</b> [Non ABS] <b>309981</b> [ABS]
	- Outer				
Front Wheel Oil Seal	- Inner	HUB UNIT	HUB UNIT		HUB UNIT
	- Outer				
Front Wheel Kit		<b>PQ752</b> [5 Studs]	<b>PQ850</b>	<b>PQ1128</b>	<b>PQ200</b> [Non ABS] <b>PQ342</b> [ABS]
Front Wheel Hub / Stub Axle					
Alternator / Generator Bearing	- Front				<b>62032RS</b>
	- Rear				<b>62012RS</b>
Concentric / Thurst Bearing		<b>RB9686</b> <b>RB9636</b> [120d]			<b>RB9803</b>
Diff Carrier Bearing	- Left				<b>501310/49</b>
	- Right				<b>501310/49</b>
Diff Pinion Bearing	- Front				<b>86610/49</b> [83-84] <b>88510/42</b> [84-92]
	- Rear				<b>88610/49</b> [83-84] <b>89410/49</b> [84-92]
Propshaft Support Bearing					<b>6006 2RS</b>
Pulley Bearing					
Spigot Shaft Bearing					<b>6201ZZ</b>
V-Belt Tensioner					
Drive Shaft Oil Seal	- Left	<b>9267</b> [120d,120i, 130i] <b>9264</b> [118i]			<b>9688</b> [318 83-84] <b>9686</b> [Rest 83-84] <b>9683</b> [84-92]
	- Right	<b>9267</b>			<b>9688</b> [318 83-84] <b>9687</b> [Rest 83-84] <b>9683</b> [84-92]
Gearbox Oil Seal	- Front	<b>9249</b> [Man.] [120d] <b>9263</b> [Man.] <b>9253</b> [Auto.]			<b>405207</b> [Man.] <b>9686</b> [Auto.] <b>9687</b> [333i]
	- Rear	<b>9252</b> [Man.] <b>9265</b> [Auto.]			<b>405508</b> [Man.] <b>405810</b> [Auto.]
Pinion Oil Seal		<b>9684</b>			<b>9684</b> [83-84] <b>9685</b> [84-92]
Spark Plug Tube Seal					
Rear Main Bearing Oil Seal		<b>9931</b> [116i, 118i, 120i, 130i]	<b>9330</b> <b>9595</b> [125i]	<b>9598</b>	<b>9430</b>
Timing Cover / Cam Oil Seal		<b>9262</b> [T/Cover] <b>9547</b> [T/Cover][120d]	<b>9281</b> [T/Cover 116i, 118i] <b>9596</b> [T/Cover 125i] <b>9597</b> [Cam 125i]	<b>9599</b>	<b>355511</b> [T/cover 83-89] <b>9925</b> [T/cover 89-92] <b>385007</b> [Cam]
Rear Wheel Bearing	- Inner	<b>309245</b>	<b>309245</b> <b>DAC458541ASB</b>	<b>HUB401</b>	<b>309639</b> [Non ABS] <b>309245</b>
	- Outer				
Rear Wheel Oil Seal	- Inner	Sealed Bearing	Sealed Bearing		Sealed Bearing
	- Outer				
Rear Wheel Kit		<b>PQ912</b> [ID: 42mm] [for vehicles with ABS]	<b>PQ912</b> [ID: 42mm] [for vehicles with ABS] <b>PQ922</b> [ID: 45mm]	<b>PQ1129</b>	<b>PQ106</b> [Non ABS] <b>PQ197</b> [ABS]
Rear Wheel Hub / Stub Axle		<b>197HUB</b> [27 Splines]	<b>912HUB</b> [OD: 42mm] <b>922HUB</b> [OD: 45mm]		<b>106CHUB</b> [OD: 39mm] <b>197BHUB</b> [OD: 42mm] [4 Studs]



APPLICATIONS	LOCATION	BMW 3 SERIES E36	BMW 3 SERIES E36	BMW 3 SERIES E37	BMW 3 SERIES E46
		316i 1.8 Dolphin Shape M40 318i 1.9 M44 320i 2.0 M50 323i 2.5 M52 325i M50 328i 2.8, 3.0 M52 Z3 2.8, 3.0 Roadster	M3 Coupe 6 Cyl.	M3 M Coupe S50	316i 1.8 M40 318i M43 320i, d M54/47 323i M52 325i, it M50 328i M52TU 330d 3.0 M57 330i, Ci, 3.0 M54
YEARS		92-00	01-04	93-01	98-05
Front Wheel Bearing	- Inner	447318B [5 hole Hub]	HUB071 [with integrated ABS sensor]	447318B [5 Hole Hub]	447318B [Others] HUB071 [330 Ci, d] [with integrated ABS sensor]
	- Outer				
Front Wheel Oil Seal	- Inner	HUB UNIT	HUB UNIT	HUB UNIT	HUB UNIT
	- Outer				
Front Wheel Kit		PQ207 [ABS]	PQ527 [5 Studs]	PQ207	PQ207 [ABS] [Others] PQ527 [330 Ci, d] [5 Studs]
Front Wheel Hub / Stub Axle					
Alternator / Generator Bearing	- Front	62032RS		62012RS	
	- Rear	62012RS		62032RS	
Concentric / Thurst Bearing		RB9802			RB9686 [All Exc.330D] RB9685 [330D]
Diff Carrier Bearing	- Left	503310/49		503310/49	
	- Right	503310/49		503310/49	
Diff Pinion Bearing	- Front	88510/42		88510/42	
	- Rear	89410/49		89410/49	
Propshaft Support Bearing		6006 2RS		6006 2RS	
Pulley Bearing					
Spigot Shaft Bearing		6201ZZ		6201 ZZ	
V-Belt Tensioner					
Drive Shaft Oil Seal	- Left	9683	9683		9683
	- Right	9683	9683		9683
Gearbox Oil Seal	- Front	305007	9715	305007	9715
	- Rear	405508		405508	
Pinion Oil Seal		9928		9928	
Spark Plug Tube Seal					
Rear Main Bearing Oil Seal		9430	9931	9430	9931
Timing Cover / Cam Oil Seal		385007 [Cam] 9925 [T/Cover]	446010 [T/Cover]	385007 [Cam] 9925 [T/Cover]	446010 [T/Cover Pet.] 486510 [T/Cover Dies]
Rear Wheel Bearing	- Inner	309639 [Non ABS] 309245 [ABS]	DAC458541	309245	309245 [Others] DAC458541 [330 Ci, d]
	- Outer				
Rear Wheel Oil Seal	- Inner	Sealed Bearing	Sealed Bearing	Sealed Bearing	Sealed Bearing
	- Outer				
Rear Wheel Kit		PQ106 [Non ABS] PQ197 [ABS]	PQ531	PQ197	PQ197 [Others] PQ531 [330 Ci, d]
Rear Wheel Hub / Stub Axle		106BHUB 197AHUB	531HUB		197AHUB 531HUB

APPLICATIONS	LOCATION	BMW 3 SERIES E90 320d 2.0 Sedan & Touring, Start M47 320i 2.0 Sedan & Touring, Start N46	BMW 3 SERIES E90 323i 2.5 Sedan & Touring, Start N52 325i 2.5 Sedan & Touring, Start N52	BMW 3 SERIES E90 330Ci, d 3.0 Convertible N52 / M57 335i, d 3.0 N54 / N55	BMW 3 SERIES F30/1 316i N13B16A 320i 2.0 N20 328i 2.0 N20 330d 3.0 N57D30A 335i 3.0 N55B30A
YEARS		05-13	05-13	05-11	2012-
Front Wheel Bearing	- Inner	<b>HUB127</b> [with integrated ABS sensor]	<b>HUB127</b> [with integrated ABS sensor]	<b>HUB127</b> [with integrated ABS sensor]	<b>HUB263</b> [with integrated ABS sensor]
	- Outer				
Front Wheel Oil Seal	- Inner	HUB UNIT	HUB UNIT	HUB UNIT	HUB UNIT
	- Outer				
Front Wheel Kit		<b>PQ752</b> [5 Studs]	<b>PQ752</b> [5 Studs]	<b>PQ752</b> [5 Studs]	<b>PQ850</b>
Front Wheel Hub / Stub Axle					
Alternator / Generator Bearing	- Front				
	- Rear				
Concentric / Thurst Bearing					
Diff Carrier Bearing	- Left				
	- Right				
Diff Pinion Bearing	- Front				
	- Rear				
Propshaft Support Bearing					
Pulley Bearing					
Spigot Shaft Bearing					
V-Belt Tensioner					
Drive Shaft Oil Seal	- Left	<b>9260</b>	<b>9267</b>	<b>9259</b>	
	- Right	<b>9260</b>	<b>9267</b>	<b>9259</b>	
Gearbox Oil Seal	- Front	<b>9249</b> [Man.] <b>9253</b> [Auto.]	<b>9263</b> [Man.] <b>9253</b> [Auto.]	<b>9253</b>	
	- Rear	<b>9266</b> [Auto] <b>9264</b> [Auto. Alt.] <b>9258</b> [Man.] <b>9265</b> [Ext. Housing o/s]	<b>9266</b> [Auto.] <b>9264</b> [Auto. Alt.] <b>9258</b> [Man.] <b>9265</b> [Ext. Housing o/s]	<b>9266</b> [Alternative] <b>9264</b> [No.1] <b>9265</b> [No.2]	
Pinion Oil Seal		<b>457510</b>	<b>457510</b>	<b>9257</b>	
Spark Plug Tube Seal					
Rear Main Bearing Oil Seal			<b>9931</b>	<b>9931</b>	<b>9280</b> [316i] <b>9595</b> [320i, 328i, 335i] <b>9598</b> [330d]
Timing Cover / Cam Oil Seal		<b>9262</b> [T/Cover Pet.] <b>9547</b> [T/Cover Dies]	<b>9262</b> [T/Cover]	<b>9262</b> [T/Cover 330i] <b>9547</b> [T/Cover 330d, 335]	<b>9597</b> [Cam 328i] <b>9281</b> [T/Cover 316i] <b>9596</b> [T/Cover 320i, 328i, 335i] <b>9599</b> [T/Cover 330d]
Rear Wheel Bearing	- Inner	<b>309245</b>	<b>309245</b> <b>DAC458541ASB</b>	<b>DAC458541ASB</b>	<b>DAC458441ASB</b> <b>309245ASB</b> <b>DAC458541ASB</b>
	- Outer				
Rear Wheel Oil Seal	- Inner	Sealed Bearing	Sealed Bearing	Sealed Bearing	Sealed Bearing
	- Outer				
Rear Wheel Kit		<b>PQ912</b> [ID: 42mm] [for vehicles with ABS]	<b>PQ912</b> [ID: 42mm] [for vehicles with ABS] <b>PQ922</b> [ASB] [ID: 45mm]	<b>PQ922</b>	<b>PQ851</b> [44.8 x 84 x 40.8] <b>PQ912</b> [ID: 42mm] [for vehicles with ABS] <b>PQ922</b> [45 x 85 x 41]
Rear Wheel Hub / Stub Axle		<b>197HUB</b> [ID: 42mm] [27 Spline]	<b>912AHUB</b> [27 Spline] <b>922AHUB</b> [W: 67mm] <b>922BHUB</b> [W: 93mm]	<b>922AHUB</b> [W: 67mm] <b>922BHUB</b> [W: 93mm]	<b>912HUB</b> [OD: 42mm] <b>922HUB</b> [OD: 45mm]

APPLICATIONS	LOCATION	BMW 3 SERIES F30	BMW 3 SERIES F34	BMW 3 SERIES F34	BMW 5 SERIES E28
		318i 1.5 F30N B38 320i 2.0 B48 320d 2.0 N47 330i 2.0 B48 340i 3.0 Sport B58	320i GT 320d GT N47D20C 328i GT N20B20A, N26B20A 335i GT N55B30A	Gran Turismo 320i 2.0 N20 320d 2.0 B47	520i 2.0 M20 525e 2.5 M30 528i 2.8 M30 535i 3.0 M30
YEARS		2015-	2012-	2013-	85-89
Front Wheel Bearing	- Inner	<b>HUB263</b> [with integrated ABS sensor]	<b>HUB263</b> [with integrated ABS sensor]	<b>HUB263</b> [with integrated ABS sensor]	<b>446388</b> [Non ABS] <b>446389</b> [ABS]
	- Outer				
Front Wheel Oil Seal	- Inner		HUB UNIT		
	- Outer				
Front Wheel Kit		<b>PQ850</b>	<b>PQ850</b>	<b>PQ850</b>	<b>PQ202</b> [Non ABS] <b>PQ203</b> [ABS]
Front Wheel Hub / Stub Axle					
Alternator / Generator Bearing	- Front				<b>62032RS</b>
	- Rear				<b>62012RS</b>
Concentric / Thurst Bearing					<b>RB9802</b>
Diff Carrier Bearing	- Left				<b>503310/49</b>
	- Right				<b>503310/49</b>
Diff Pinion Bearing	- Front				<b>88510/42</b>
	- Rear				<b>89410/49</b>
Propshaft Support Bearing					<b>6006 2RS</b>
Pulley Bearing					
Spigot Shaft Bearing					<b>6201 ZZ</b>
V-Belt Tensioner					
Drive Shaft Oil Seal	- Left				
	- Right				
Gearbox Oil Seal	- Front	<b>9146</b> [340i Man.]		<b>9263</b> [320i Man.] <b>9146</b> [320d Man.]	<b>355207</b> [Man.]
	- Rear	<b>9147</b> [340i Man.]		<b>9266</b> [320i Man.] <b>9147</b> [320d Man.]	<b>405508</b> [Man.] <b>405810</b> [Auto]
Pinion Oil Seal		<b>457510</b> [320i, 320d, 330i] <b>9148</b> [340i]		<b>457510</b> [320d]	<b>457510</b>
Spark Plug Tube Seal					
Rear Main Bearing Oil Seal		<b>9142</b> [318i, 320i, 330i, 340i] <b>9598</b> [320d]	<b>9595</b> [320i, 328i, 335i] <b>9598</b> [320d]	<b>9595</b> [T/cover 320i] <b>9598</b> [T/cover 320d]	<b>9430</b>
Timing Cover / Cam Oil Seal		<b>9547</b> [T/cover 320i, 330i, 340i] <b>9599</b> [T/cover 320d]	<b>9597</b> [Cam 328i] <b>9596</b> [T/Cover 320i, 328i, 335i] <b>9599</b> [T/Cover 320d]	<b>9596</b> [T/cover 320i] <b>9599</b> [T/cover 320d]	<b>385007</b> [Cam] <b>486510</b> [T/cover]
Rear Wheel Bearing	- Inner	<b>DAC427537ASB</b> <b>DAC458441ASB</b>	<b>DAC458441ASB</b> <b>309245ASB</b> <b>DAC458541ASB</b>	<b>DAC458441ASB</b>	<b>309946</b> [Drum] <b>309609</b> [Disc]
	- Outer				
Rear Wheel Oil Seal	- Inner	Sealed Bearing	Sealed Bearing	Sealed Bearing	Sealed Bearing
	- Outer				
Rear Wheel Kit		<b>PQ912</b> [ID: 42mm] <b>PQ851</b> [ID: 45mm]	<b>PQ851</b> [44.8 x 84 x 40.8] <b>PQ912</b> [ID: 42mm] [for vehicles with ABS] <b>PQ922</b> [45 x 85 x 41]	<b>PQ851</b> [ID: 45mm]	<b>PQ205</b> [Drum] <b>PQ206</b> [Disc]
Rear Wheel Hub / Stub Axle		<b>1120HUB</b> <b>851HUB</b>	<b>912HUB</b> [OD: 42mm] <b>922HUB</b> [OD: 45mm]	<b>851HUB</b>	

APPLICATIONS	LOCATION	BMW 5 SERIES E34	BMW 5 SERIES E39	BMW 5 SERIES E60/ 61	BMW 5 SERIES F07, F10/ F11, F18
		520i 2.0 M50 525i 2.5 M50 530i 3.0 M60 535i 3.5 M30 540i 4.0 M60	523i 2.5 M52 525i 2.5 M54 528i 2.8 M52 530i, d 3.0 M54/ M57 540i 4.4 M62	520d 2.0 N47 523i 2.5 N52 / N53 525i 2.5 M54 / N52 530i M54 / N52 530d 3.0 M57	520d, GT 523i 528i 530d, GT 535i, GT 535d
YEARS		90-00	98-04	04-10	2011-
Front Wheel Bearing	- Inner	446388 [Non ABS] 447318B [ABS]	HUB068 [Flange Ø: 139mm] [with integrated ABS sensor] HUB264 [Flange Ø: 143mm]	HUB264 [Flange Ø: 143mm]	HUB265
	- Outer				
Front Wheel Oil Seal	- Inner		HUB UNIT	HUB UNIT	HUB UNIT
	- Outer				
Front Wheel Kit		PQ202 [Non ABS] PQ207 [ABS]	PQ524 [Flange Ø: 139mm] PQ852 [Flange Ø: 143mm]	PQ852 [Flange Ø: 143mm]	PQ860
Front Wheel Hub / Stub Axle					
Alternator / Generator Bearing	- Front	62012RS			
	- Rear	62032RS			
Concentric / Thrust Bearing		RB9802	RB9685 [530d] RB9686 [525i, 530i]	RB9685 [530d] RB9686 [523i, 525i, 530i]	
Diff Carrier Bearing	- Left	104910/48			
	- Right	104910/48			
Diff Pinion Bearing	- Front	88510/42			
	- Rear	89410/49			
Propshaft Support Bearing		6006 2RS			
Pulley Bearing					
Spigot Shaft Bearing		6201 ZZ			
V-Belt Tensioner					
Drive Shaft Oil Seal	- Left				
	- Right				
Gearbox Oil Seal	- Front	355207 [Man.]			
	- Rear	405508 [Man.] 405810 [Auto.]			
Pinion Oil Seal		9929			
Spark Plug Tube Seal					
Rear Main Bearing Oil Seal		9430	9931	9035FS [530d] 9598 [520d] 9931 [523i, 525i, 530i]	9595 [523i, 528i -11, 535i] 9598 [520d, 530d, 535d] 9931 [528i 11-]
Timing Cover / Cam Oil Seal		385007 [Cam] 486510 [T/cover]	486510 [T/cover]	9262 [T/cover 523i, 525i, 530i] 9547 [T/cover 530d] 9599 [T/cover 520d]	9262 [T/cover 523i, 528i -11, 535i] 9596 [T/cover 528i 11-] 9599 [T/cover 520d, 530d, 535d]
Rear Wheel Bearing	- Inner	309946 309609	HUB040 [with integrated ABS sensor]	HUB040 [with integrated ABS sensor]	HUB266
	- Outer				
Rear Wheel Oil Seal	- Inner	Sealed Bearing	HUB UNIT	HUB UNIT	HUB UNIT
	- Outer				
Rear Wheel Kit		PQ205 PQ206	PQ525	PQ525	PQ861
Rear Wheel Hub / Stub Axle					861HUB

APPLICATIONS	LOCATION	BMW 7 SERIES	BMW 7 SERIES	BMW 7 SERIES	BMW 8 SERIES
		E23 728, i M30 730 M30 733i M30 735i M90 745i M88	E32 730i M30/60 735i M106 740i M60 750iL M70	E38 740i M60/62 750iL M70	E31 850iL V12 M70
YEARS		78-89	87-95	95-03	91-94
Front Wheel Bearing	- Inner	68110/49 [78-85 Std.] 446389 [85-89 ABS] 446388 [745 ABS]	446420 [87-92] 447318B [92-95]		446420 [91-92] 447318B [93-94]
	- Outer	12710/49 [78-85 Std.]			
Front Wheel Oil Seal	- Inner	9442 [78-85 Std.]			
	- Outer				
Front Wheel Kit		PQ204 [78-85 Std.] PQ203 [85-89 ABS] PQ202 [745 ABS]	PQ441 [87-92] PQ207 [ABS] [92-95]		PQ441 [91-92] PQ207 [ABS] [93-94]
Front Wheel Hub / Stub Axle					
Alternator / Generator Bearing	- Front	62032RS	62012RS	62032RS	62012RS
	- Rear	62012RS	62032RS	62012RS	62032RS
Concentric / Thurst Bearing		RB9802	RB9802		
Diff Carrier Bearing	- Left	503310/49 [78-81] 104910/49 [82-89]	104910/48	104910/48	104910/48
	- Right	503310/49 [78-81] 104910/49 [82-89]	104910/48	104910/48	104910/48
Diff Pinion Bearing	- Front	89410/48 [78-81] 88510/42 [81-89]	88510/42	88510/42	88510/42
	- Rear	803110/49 [78-81] 89410/49 [81-89]	89410/49	89410/49	89410/49
Propshaft Support Bearing		6006 2RS	6006 2RS		
Pulley Bearing					
Spigot Shaft Bearing		6201 ZZ	6201 ZZ		
V-Belt Tensioner					
Drive Shaft Oil Seal	- Left				
	- Right				
Gearbox Oil Seal	- Front	355207 [Man.]	355207 [Man.] 405207 [Auto]		355207 [Man.] 405207 [Auto]
	- Rear	405508 [Man.] 405810 [Auto]	405508 [Man.] 405810 [Auto]		405508 [Man.] 405810 [Auto]
Pinion Oil Seal		457510	457510	457510	457510
Spark Plug Tube Seal					
Rear Main Bearing Oil Seal		9931	9931 [Others] 9932 [750]	9932	9932
Timing Cover / Cam Oil Seal		426212 [T/cover]	284007 [Cam] 426212 [T/cover]		284007 [Cam] 426212 [T/cover]
Rear Wheel Bearing	- Inner	6206 2RS [78-85 Std.] 309609 [85-89 ABS]	309609	DAC458541	DAC458541
	- Outer	6208 2RS [78-85 Std.]			
Rear Wheel Oil Seal	- Inner	426207 [78-85 Std.]	Sealed Bearing	Sealed Bearing	Sealed Bearing
	- Outer	608009 [78-85 Std.]			
Rear Wheel Kit		PQ206 [85-89 ABS]	PQ206	PQ531	PQ531
Rear Wheel Hub / Stub Axle				531HUB	531HUB

APPLICATIONS	LOCATION	BMW M5 Coupe M30 M5 Coupe MS38	BMW M5 V8 Coupe	BMW MINI COOPER R50/R52/56 1.6 Cooper, Convertible, W10B16A, Cooper S, CVT, W11B16A	BMW MINI COOPER R53 1.6 Cooper S W11B16A
YEARS		86-94	99-03	02-09	02-09
Front Wheel Bearing	- Inner	446388 [Std.] 447318B [ABS]	HUB068 [with integrated ABS sensor]	HUB128 [-2006] [12mm Bolt holes] [with integrated ABS sensor] HUB230 [2006-] [14mm Bolt holes] [with integrated ABS sensor]	HUB128 [12mm Bolt holes] [with integrated ABS sensor] HUB230 [14mm Bolt holes] [with integrated ABS sensor]
	- Outer				
Front Wheel Oil Seal	- Inner		HUB UNIT	HUB UNIT	HUB UNIT
	- Outer				
Front Wheel Kit		PQ202 [Std.] PQ207 [ABS]	PQ524 [5 Studs]	PQ739 [4 Studs] PQ741 [4 Studs]	PQ739 [4 Studs] PQ741 [4 Studs]
Front Wheel Hub / Stub Axle					
Alternator / Generator Bearing	- Front	62032RS			
	- Rear	62012RS			
Concentric / Thrust Bearing				RB9689 [Man.]	RB9689
Diff Carrier Bearing	- Left	104910/48			
	- Right	104910/48			
Diff Pinion Bearing	- Front	88510/42			
	- Rear	89410/49			
Propshaft Support Bearing		6006 2RS			
Pulley Bearing					
Spigot Shaft Bearing		6201 ZZ			
V-Belt Tensioner					
Drive Shaft Oil Seal	- Left			9273	
	- Right			9273	
Gearbox Oil Seal	- Front	355207 [Man.]		9270 [Man.] 9271 [Auto.]	9276 [Man.] 9278 [Auto.] 9279 [Auto. Alt.]
	- Rear	405508 [Man.] 405810 [Auto.]		9272 [Auto.]	9274 9277 [Man.]
Pinion Oil Seal		9929			
Spark Plug Tube Seal					
Rear Main Bearing Oil Seal		9430	9931	9268 [R52] 9280 [R56]	9268
Timing Cover / Cam Oil Seal		2838 [Cam] 446210 [T/cover]	486510 [T/cover]	9269 [T/Cover R50/R52] 9281 [T/Cover R56]	9269 [T/cover]
Rear Wheel Bearing	- Inner	309946 [Drum] 309609 [Disc]	HUB040 [with integrated ABS sensor]	HUB129 [12mm Bolt holes] [with integrated ABS sensor] HUB229 [14mm Bolt holes] [with integrated ABS sensor]	HUB129 [12mm Bolt holes] [with integrated ABS sensor] HUB229 [14mm Bolt holes] [with integrated ABS sensor]
	- Outer				
Rear Wheel Oil Seal	- Inner	Sealed Bearing	HUB UNIT	HUB UNIT	HUB UNIT
	- Outer				
Rear Wheel Kit		PQ205 [Drum] PQ206 [Disc]	PQ525	PQ742 [4 Studs] PQ740 [4 Studs]	PQ742 [4 Studs] PQ740 [4 Studs]
Rear Wheel Hub / Stub Axle					



APPLICATIONS	LOCATION	BMW MINI COOPER R55/R57/R58/R59	BMW MINI COOPER R60/R61	BMW X1 4X4 xDrive E84	BMW X3 4X4 E83
		1.6L I4 (One/Cooper) Petrol turbocharged (Cooper S) 1.6L BMW N47 diesel I4 (Cooper D and One D)	1.6L (One/Cooper), (Cooper S) 1.6L BMW N47 diesel (Cooper D and One D) 2.0L BMW N47 diesel (Cooper D Auto. and Cooper SD Models)	18i 2.0 N46 20i 2.0 N20 20d 2.0 N47 23d 2.0 N47 25d 2.0 47 28i 2.0 N20	2.5i SUV M54 E83LCi 2.5si SUV N52N
YEARS		2007-	10-13	09-15	04-07
Front Wheel Bearing	- Inner	HUB230 [with integrated ABS sensor]	HUB232 [with integrated ABS sensor]	HUB127 [with integrated ABS sensor] HUB268 [Gear type ABS]	895978
	- Outer				
Front Wheel Oil Seal	- Inner	HUB UNIT	HUB UNIT	HUB UNIT	Sealed Bearing
	- Outer				
Front Wheel Kit		PQ741 [4 Studs]	PQ748 [4x2] [Short Bolts] [5 Studs]	PQ752 [with integrated ABS sensor] PQ932 [Gear type ABS]	PQ746
Front Wheel Hub / Stub Axle					
Alternator / Generator Bearing	- Front				
	- Rear				
Concentric / Thurst Bearing		RB9690	RB9690		RB9686
Diff Carrier Bearing	- Left				
	- Right				
Diff Pinion Bearing	- Front				
	- Rear				
Propshaft Support Bearing					
Pulley Bearing					
Spigot Shaft Bearing					
V-Belt Tensioner					
Drive Shaft Oil Seal	- Left				9256 [Front] 9267 [Rear]
	- Right				9256 [Front] 9267 [Rear]
Gearbox Oil Seal	- Front				
	- Rear				
Pinion Oil Seal					9255 [Front] 457510 [Rear]
Spark Plug Tube Seal					
Rear Main Bearing Oil Seal		9280	9280	9595 [28i] 9598 [20i, 23d, 25d] 9931 [18i]	9931
Timing Cover / Cam Oil Seal		9281 [T/cover]	9281 [T/cover]	9597 [Cam 28i] 9262 [T/Cover 18i] 9596 [T/Cover 28i] 9599 [T/Cover 20i, d, 23d, 25d]	486510 [T/Cover]
Rear Wheel Bearing	- Inner	HUB231 [with integrated ABS sensor]	HUB232 [4x2] [with integrated ABS sensor] HUB233 [4x2] [with integrated ABS sensor] HUB232 [4x4] [with integrated ABS sensor]	HUB267	DAC458541 902314
	- Outer				
Rear Wheel Oil Seal	- Inner	HUB UNIT	HUB UNIT	HUB UNIT	Sealed Bearing
	- Outer				
Rear Wheel Kit		PQ745 [4 Studs]	PQ748 [Short Bolts] [5 Studs] PQ749 [4x2] PQ750 [Long Bolts] [5 Studs]	PQ931	PQ531 PQ747 Alt.
Rear Wheel Hub / Stub Axle				197BHUB	531HUB

APPLICATIONS	LOCATION	BMW X3 4X4	BMW X3 4X4	BMW X5 4X4	BMW X5 4X4
		E83 2.0d SUV M47N2 E83LCi 3.0d, i SUV M57N2, 3.0si SUV N52N	xDrive F25 20i 2.0 N20 20d 2.0 B47/ N47 28i 2.0 N20 30d 3.0 N57 35i 3.0 N55	E53 3.0d SUV M57N	E53/70 3.0i SUV M54
YEARS		05-10	2010-	01-06	2001-
Front Wheel Bearing	- Inner	895978	HUB270 [Gear type ABS]	895978	895978 [E53] HUB195 [E70] [with integrated ABS sensor]
	- Outer				
Front Wheel Oil Seal	- Inner	Sealed Bearing	HUB UNIT	Sealed Bearing	Sealed Bearing [E53] HUB UNIT [E70]
	- Outer				
Front Wheel Kit		PQ746	PQ934	PQ746	PQ746 [E53] PQ886 [E70][5 Studs]
Front Wheel Hub / Stub Axle					
Alternator / Generator Bearing	- Front				
	- Rear				
Concentric / Thurst Bearing		RB9686 RB9685 [3.0]		RB9685	RB9686
Diff Carrier Bearing	- Left				
	- Right				
Diff Pinion Bearing	- Front				
	- Rear				
Propshaft Support Bearing					
Pulley Bearing					
Spigot Shaft Bearing					
V-Belt Tensioner					
Drive Shaft Oil Seal	- Left	9256 [Front] 9260 [Rear]		9256 [Front] 9259 [Rear]	9256 [Front] 9259 [Rear] 9260 [Rear Alt.]
	- Right	9256 [Front] 9260 [Rear]		9256 [Front] 9259 [Rear]	9256 [Front] 9260 [Rear]
Gearbox Oil Seal	- Front	9249		9250	
	- Rear	9258 9252		9251 9252	9258
Pinion Oil Seal		9255 [Front] 9685 [Rear]		9255 [Front] 9257 [Rear]	457510 [Rear] 9255 [Front]
Spark Plug Tube Seal					
Rear Main Bearing Oil Seal		9035FS [3.0d] 9931 [3.0i]	9595 [3.5] 9598 [2.0, 2.8, 3.0]		9931
Timing Cover / Cam Oil Seal		9547 [T/Cover 2.0d, 3.0d, 3si] 9288 [T/Cover 3.0i]	9262 [T/Cover 3.5] 9599 [T/Cover 2.0, 2.8, 3.0]	9547 [T/Cover]	486510 [T/Cover]
Rear Wheel Bearing	- Inner	DAC458541 902314	HUB269 [with integrated ABS sensor]	HUB194 [with integrated ABS sensor]	HUB194 [E53] [with integrated ABS sensor] HUB196 [E70] [with integrated ABS sensor]
	- Outer				
Rear Wheel Oil Seal	- Inner	Sealed Bearing	HUB UNIT	HUB UNIT	HUB UNIT
	- Outer				
Rear Wheel Kit		PQ531 PQ747 Alt.	PQ933	PQ885	PQ885 [E53] PQ887 [E70]
Rear Wheel Hub / Stub Axle		531HUB			

APPLICATIONS	LOCATION	BMW X5 4X4 E53/70 4.4i SUV N62 4.6iS SUV M62 4.8iS SUV N62	BMW X5 4X4 E70 3.0d SUV M57N	BMW X5 4X4 xDrive F15 30d 3.0 N57 35i 3.0 N55 40d 3.0 N57 50i 4.4 N63	
YEARS		2001-	2007-	2013-	
Front Wheel Bearing	- Inner	<b>895978</b> [E53] <b>HUB195</b> [E70] [with integrated ABS sensor]	<b>HUB195</b> [with integrated ABS sensor]	<b>HUB271</b> [with integrated ABS sensor]	
	- Outer				
Front Wheel Oil Seal	- Inner	Sealed Bearing [E53] HUB UNIT [E70]	HUB UNIT	HUB UNIT	
	- Outer				
Front Wheel Kit		<b>PQ746</b> [E53] <b>PQ886</b> [E70] [5 Studs]	<b>PQ886</b> [5 Studs]	<b>PQ935</b>	
Front Wheel Hub / Stub Axle					
Alternator / Generator Bearing	- Front				
	- Rear				
Concentric / Thurst Bearing					
Diff Carrier Bearing	- Left				
	- Right				
Diff Pinion Bearing	- Front				
	- Rear				
Propshaft Support Bearing					
Pulley Bearing					
Spigot Shaft Bearing					
V-Belt Tensioner					
Drive Shaft Oil Seal	- Left	<b>9256</b> [Front] <b>9260</b> [Rear]	<b>9256</b> [Front] <b>9259</b> [Rear] <b>9260</b> [Rear Alt.]		
	- Right	<b>9256</b> [Front] <b>9260</b> [Rear]	<b>9256</b> [Front] <b>9260</b> [Rear]		
Gearbox Oil Seal	- Front	<b>9253</b> <b>9289</b> [4.6iS]	<b>9253</b>		
	- Rear	<b>9254</b> <b>9290</b> [4.6iS]	<b>9254</b>		
Pinion Oil Seal		<b>9255</b> [Front] <b>9685</b> [Rear]	<b>457510</b> [Rear] <b>9255</b> [Front]		
Spark Plug Tube Seal					
Rear Main Bearing Oil Seal				<b>9595</b> [35i] <b>9598</b> [30d, 40d]	
Timing Cover / Cam Oil Seal		<b>9261</b> [T/Cover] <b>486510</b> [T/Cover] [4.6iS]	<b>9547</b> [T/Cover]	<b>9262</b> [T/Cover 35i] <b>9599</b> [T/Cover 30d, 40d]	
Rear Wheel Bearing	- Inner	<b>HUB194</b> [E53] [with integrated ABS sensor] <b>HUB196</b> [E70] [with integrated ABS sensor]	<b>HUB196</b> [with integrated ABS sensor]	<b>HUB196</b> [with integrated ABS sensor]	
	- Outer				
Rear Wheel Oil Seal	- Inner	HUB UNIT	HUB UNIT	HUB UNIT	
	- Outer				
Rear Wheel Kit		<b>PQ885</b> [E53] <b>PQ887</b> [E70]	<b>PQ887</b>	<b>PQ887</b>	
Rear Wheel Hub / Stub Axle					

APPLICATIONS	LOCATION	C.A.M. INYATHI Jinbei Haise Minibus 2.2i Std.	C.A.M. RHINO 2.2i 2.8i	CHANA STAR 1.0 P/up 1.3 P/up
		YEARS	2007-	2007-
Front Wheel Bearing	- Inner	48510/48	48510/48 102910/49 [Alt.]	HUB130 [Non ABS]
	- Outer	12610/49	12610/49 102910/49 [Alt.]	
Front Wheel Oil Seal	- Inner	506809	506809 506709 [2.8] 9891 [Alt.]	
	- Outer			
Front Wheel Kit		PQ171	PQ171 [2.2] PQ346 [2.8] PQ428 [Alt.]	PQ738 [4 Studs]
Front Wheel Hub / Stub Axle		171HUB	171HUB [2.2]	
Alternator / Generator Bearing	- Front	63032RS		
	- Rear	62012RS		
Concentric / Thurst Bearing				
Diff Carrier Bearing	- Left	102910/49	17831+17887	
	- Right	102910/49	17831+17887	
Diff Pinion Bearing	- Front	86610/49 88610/49 [Some Mod.]	30306	
	- Rear	88610/49 802011/48 [Some Mod.]	30307	
Propshaft Support Bearing				
Pulley Bearing				
Spigot Shaft Bearing		6201 2RS		
V-Belt Tensioner				
Drive Shaft Oil Seal	- Left			
	- Right			
Gearbox Oil Seal	- Front	385811		
	- Rear	385811RK [Kit]		
Pinion Oil Seal		2738 9718 [Some mod.]		
Spark Plug Tube Seal				
Rear Main Bearing Oil Seal		9648		608008
Timing Cover / Cam Oil Seal		426007 [T/Cover]		324708 [T/Cover]
Rear Wheel Bearing	- Inner	6308 2RS + RR42 [Import] U360/399+1852119 [Local]	6308 2RS + RR42 [Import] U360/399+1852119 [Local] 30208 + RR44	6207RS C3
	- Outer			
Rear Wheel Oil Seal	- Inner		9955 [Import Alt.]	486210
	- Outer	9431 [Import] 9415 [Local]	486510 [Import Alt.] 9431 [Import] 9415 [Local]	486210
Rear Wheel Kit		PQ191 [Import Diff.] PQ176 [Local Diff.]	PQ191 [Import Diff.] PQ176 [Local Diff.] PQ430 [Import Diff. Alt.]	PQ681
Rear Wheel Hub / Stub Axle				

APPLICATIONS	LOCATION	CHERY QQ3 0.8 TE, TX 1.1 TXE			
YEARS		2008-			
Front Wheel Bearing	- Inner	309396 DAC356437			
	- Outer				
Front Wheel Oil Seal	- Inner	Sealed Bearing			
	- Outer				
Front Wheel Kit		PQ139 PQ762			
Front Wheel Hub / Stub Axle					
Alternator / Generator Bearing	- Front				
	- Rear				
Concentric / Thurst Bearing					
Diff Carrier Bearing	- Left				
	- Right				
Diff Pinion Bearing	- Front				
	- Rear				
Propshaft Support Bearing					
Pulley Bearing					
Spigot Shaft Bearing					
V-Belt Tensioner					
Drive Shaft Oil Seal	- Left				
	- Right				
Gearbox Oil Seal	- Front				
	- Rear				
Pinion Oil Seal					
Spark Plug Tube Seal					
Rear Main Bearing Oil Seal					
Timing Cover / Cam Oil Seal					
Rear Wheel Bearing	- Inner				
	- Outer				
Rear Wheel Oil Seal	- Inner				
	- Outer				
Rear Wheel Kit					
Rear Wheel Hub / Stub Axle					

**CHEVROLET**

APPLICATIONS	LOCATION	CHEVROLET AVEO 1.5 L, LS, LT 1.6 LS	CHEVROLET CAPTIVA 4X2, 4X4 2.0D LTZ Z20S 2.4 LT Z24SED 3.2 LTZ 10HM	CHEVROLET CAPTIVA 4X2, 4X4 2.2D LTZ 5-dr Dsl AWD AT. 2.2D LT 5-dr Dsl AT. LNQ 2.4 LT, LS 5-dr LE5 3.0 LTZ 5-dr AWD AT.	CHEVROLET CRUZE 1.6 L, LS F16D3 1.8 LS, LT F18D4 2.0D LT Z20S1
YEARS		03-15	07-11	11-17	09-15
Front Wheel Bearing	- Inner	<b>309639</b> <b>309726</b> <b>DAC40FWBAVEO</b> [With integrated ABS sensor]	<b>HUB199</b> [With integrated ABS sensor] [Flange Ø: 151mm]	<b>HUB199</b> [With integrated ABS sensor] [Flange Ø: 151mm] <b>HUB396</b> [With integrated ABS sensor][Flange Ø: 151mm]	<b>HUB201</b> [With integrated ABS sensor] <b>HUB202</b> [With integrated ABS sensor]
	- Outer				
Front Wheel Oil Seal	- Inner	Sealed Bearing	HUB UNIT	HUB UNIT	HUB UNIT
	- Outer				
Front Wheel Kit		<b>PQ106</b> [39x72x37] <b>PQ528</b> [34x64x37] <b>PQ714</b> [40x78x40]	<b>PQ910</b> [5 Studs]	<b>PQ910</b> [5 Studs] <b>PQ1123</b> [5 Studs]	<b>PQ897</b> [15" wheels] [5 Studs][Rim: 5 -Hole 105mm PCD] <b>PQ898</b> [17" wheels] [5 Studs][Rim: 5 -Hole 115mm PCD]
Front Wheel Hub / Stub Axle		<b>106HUB</b> <b>528HUB</b> [4 Studs] <b>714HUB</b> [5 Studs]			
Alternator / Generator Bearing	- Front				
	- Rear				
Concentric / Thrust Bearing		<b>RB9892</b>	<b>Concentric Slave Cylinder</b>	<b>Concentric Slave Cylinder</b>	<b>Concentric Slave Cylinder</b>
Diff Carrier Bearing	- Left				
	- Right				
Diff Pinion Bearing	- Front				
	- Rear				
Propshaft Support Bearing					
Drive Shaft Oil Seal	- Left	<b>9104</b> [OD: 54mm] <b>9974 "Holes"</b> [OD: 55mm]			
	- Right	<b>9104</b> [OD: 54mm] <b>9974 "Holes"</b> [OD: 55mm]			
Gearbox Oil Seal	- Front	<b>9972</b>			
	- Rear				
Rear Main Bearing Oil Seal		<b>9464</b>	<b>9408</b> [2.0D] <b>9914</b> [2.4]	<b>9408</b> [2.2D] <b>9914</b> [2.4] <b>9156</b> [3.0LTZ]	<b>9464</b> [1.6, 1.8] <b>9408</b> [2.0D]
Timing Cover / Cam Oil Seal		<b>354807</b> [Cam 1.5] <b>425607</b> [Cam 1.6] <b>304207</b> [T/Cover 1.5] <b>304208</b> [T/Cover 1.6]	<b>354807</b> [Cam 2.4] <b>365007</b> [Cam 2.0D] <b>9269</b> [T/Cover 2.0D] <b>9328</b> [T/Cover 2.4]	<b>9038</b> [T/Cover 2.2D] <b>9328</b> [T/Cover 2.4] <b>9060</b> [T/Cover 3.0D]	<b>9037</b> [T/Cover 1.6, 1.8] <b>9038</b> [T/Cover 2.0D] <b>354807</b> [Cam 1.6, 1.8]
Rear Wheel Bearing	- Inner	<b>FC12025</b> [03-13] <b>HUB256</b> [05-13] [With integrated ABS sensor] <b>HUB143</b> [2011-] [With integrated ABS sensor] [Flange Ø: 136mm]	<b>HUB200</b> [With integrated ABS sensor] [Flange Ø: 151mm]	<b>HUB200</b> [With integrated ABS sensor] [Flange Ø: 151mm]	<b>HUB192</b> [OD:136mm] [With integrated ABS sensor] <b>HUB193</b> [OD:146mm] [With integrated ABS sensor]
	- Outer				
Rear Wheel Oil Seal	- Inner	Sealed Bearing HUB UNIT	HUB UNIT	HUB UNIT	HUB UNIT
	- Outer				
Rear Wheel Kit		<b>PQ437</b> [-2013] <b>PQ437A</b> [4 Studs] [Comp. Hub & Bearing Unit] <b>PQ437B</b> [Non ABS][1.5 [03-04] <b>PQ793</b> [2011-] [5 Studs]	<b>PQ911</b> [5 Studs]	<b>PQ911</b> [5 Studs]	<b>PQ908</b> [15" & 16" wheels] [5 Studs 105mm PCD] <b>PQ909</b> [17" wheels] [5 Studs 115mm PCD]
Rear Wheel Hub / Stub Axle					



APPLICATIONS	LOCATION	CHEVROLET OPTRA 1.6 Ls F16D3 1.8 Lt T18SED	CHEVROLET ORLANDO 1.8 F18D4	CHEVROLET SONIC 1.3D 1.4 Pet. Hatch / Sedan 1.6 Pet. Hatch / Sedan	CHEVROLET SPARK 0.8 L, LS 1.0 LT, LS
		YEARS	04-11	2011-	11-15
Front Wheel Bearing	- Inner	636096	HUB202 [With integrated ABS sensor]	DAC40FWBAVEO	68111/68149
	- Outer				68111/68149
Front Wheel Oil Seal	- Inner	Sealed Bearing	HUB UNIT	Sealed Bearing	9551 597SPACER
	- Outer				9973
Front Wheel Kit		PQ530	PQ898 [5 Studs] [Rim: 5 -Hole 115mm PCD]	PQ714 [ASB]	PQ597
Front Wheel Hub / Stub Axle		530HUB		714HUB [5 Studs] 714BHUB [4 Studs]	597HUB
Alternator / Generator Bearing	- Front				
	- Rear				
Concentric / Thurst Bearing		Concentric Slave Cylinder	Concentric Slave Cylinder	Concentric Slave Cylinder	RB9606
Diff Carrier Bearing	- Left				
	- Right				
Diff Pinion Bearing	- Front				
	- Rear				
Propshaft Support Bearing					
Pulley Bearing					
Spigot Shaft Bearing					
V-Belt Tensioner					
Drive Shaft Oil Seal	- Left				9671
	- Right				9672
Gearbox Oil Seal	- Front				9972
	- Rear				
Pinion Oil Seal					
Spark Plug Tube Seal					
Rear Main Bearing Oil Seal		9464 [1.6] 9914 [1.8]	9464	9329 [1.3D] 9464 [1.4, 1.6]	608008
Timing Cover / Cam Oil Seal		304208 [T/Cover 1.6] 9037 [T/Cover 1.8] 354807 [Cam 1.8] 425607 [Cam 1.6]	354807 [Cam] 9037 [T/Cover]	354807 [Cam 1.6] 405207 [T/Cover 1.3D] 9328 [T/Cover 1.4] 9037 [T/Cover 1.6]	324708 9971
Rear Wheel Bearing	- Inner	HUB225 [Flange Ø: 139,3 mm] HUB226 [Integrated ABS sensor] [Flange Ø: 139,3 mm]	HUB193 [OD:146mm] [With integrated ABS sensor]	HUB143 [With integrated ABS sensor] [Flange Ø: 136mm] HUB371 [With integrated ABS sensor] [Flange Ø: 130mm]	30205
	- Outer				30204
Rear Wheel Oil Seal	- Inner	HUB UNIT	HUB UNIT	HUB UNIT	Sealed Bearing
	- Outer				405207 9567
Rear Wheel Kit		PQ574 [Non ABS][4 Studs] PQ575 [ABS][4 Studs]	PQ909 [5 Studs 115mm PCD]	PQ793 [5 Studs] [15" Rim] PQ1086 [4 Studs] [14" Rim]	PQ146
Rear Wheel Hub / Stub Axle					

APPLICATIONS	LOCATION	CHEVROLET SPARK	CHEVROLET TRAILBLAZER	CHEVROLET UTILITY	
		1.0 B10S1 1.2 B12D1	4X2, 4X4 2.5D XLD25, LVN 2.8D LWH 3.6 LY7	1.3D 1.4 Pet. 1.8 Pet.	
YEARS		2010-	12-14	11-15	
Front Wheel Bearing	- Inner	309726	Cup + Cone	DAC346737	
	- Outer		Cup + Cone		
Front Wheel Oil Seal	- Inner	Sealed Bearing	9127	Sealed Bearing	
	- Outer		9128		
Front Wheel Kit		PQ528	PQ1105	PQ679	
Front Wheel Hub / Stub Axle		528HUB	1105HUB	679HUB	
Alternator / Generator Bearing	- Front				
	- Rear				
Concentric / Thurst Bearing		RB9606		RB9878	
Diff Carrier Bearing	- Left				
	- Right				
Diff Pinion Bearing	- Front				
	- Rear				
Propshaft Support Bearing					
Pulley Bearing					
Spigot Shaft Bearing					
V-Belt Tensioner					
Drive Shaft Oil Seal	- Left	9671			
	- Right	9672			
Gearbox Oil Seal	- Front	9972		9716	
	- Rear				
Pinion Oil Seal					
Spark Plug Tube Seal					
Rear Main Bearing Oil Seal		608008		9464	
Timing Cover / Cam Oil Seal		9036 [T/Cover 1.2]	9626 [Cam]		
Rear Wheel Bearing	- Inner	FC12025 HUB256 [Gear type ABS]	Cup + Cone	HUB125 [With integrated ABS sensor] HUB026 [Non ABS]	
	- Outer				
Rear Wheel Oil Seal	- Inner	HUB UNIT	9129	HUB UNIT	
	- Outer		9130		
Rear Wheel Kit		PQ437 PQ437A [4 Studs] [Comp. Hub & Bearing Unit]	PQ1106	PQ732 [4 Hole] PQ492 [4 Hole] [Non ABS]	
Rear Wheel Hub / Stub Axle		SA437L/R			

APPLICATIONS	LOCATION	CHRYSLER NEON	CHRYSLER PT-CRUISER	CHRYSLER VOYAGER	CHRYSLER VOYAGER
		1.8 PL 2.0 PL 2.0i R/T	2.0 ECC Pet. 2.2 CRD, EDJ Dies. 2.4 ED2 Pet.	2.0 SE MPV 2.4 SE MPV	2.4 SE MPV 2.4 SWB 3.3 SWB
YEARS		02-06	02-09	97-04	02-07
Front Wheel Bearing	- Inner	DACFWB42CPTC DACFWB40NEON DAC42NEO	DACFWB42CPTC DAC42NEO	574298P HUB084 [Non ABS]	HUB274
	- Outer				
Front Wheel Oil Seal	- Inner	Sealed Bearing	Sealed Bearing	Sealed Bearing HUB UNIT	HUB UNIT
	- Outer				
Front Wheel Kit		PQ692 [W: 39mm] PQ717 [ID: 40mm] PQ937 [W: 33mm]	PQ692 [W: 39mm] PQ937 [W: 33mm]	PQ526 [14" Rims] PQ478 [15" Rims] [5 Studs]	PQ939 [5 Studs] [30 Splines]
Front Wheel Hub / Stub Axle					
Alternator / Generator Bearing	- Front				
	- Rear				
Concentric / Thurst Bearing		RB9616	RB9616	RB9617	
Diff Carrier Bearing	- Left				
	- Right				
Diff Pinion Bearing	- Front				
	- Rear				
Propshaft Support Bearing					
Pulley Bearing					
Spigot Shaft Bearing					
V-Belt Tensioner					
Drive Shaft Oil Seal	- Left				
	- Right				
Gearbox Oil Seal	- Front				
	- Rear				
Pinion Oil Seal					
Spark Plug Tube Seal					
Rear Main Bearing Oil Seal		9268	9041 [2.2 CRD] 9268 [2.0, 2.4]		9268
Timing Cover / Cam Oil Seal		9040 [T/Cover 2.0 R/T] 9269 [T/Cover]	354807 [Cam 2.0, 2.4] 9269 [T/Cover 2.0, 2.4] 9042 [T/Cover 2.2 CRD]		354807 [Cam] 9269 [T/Cover]
Rear Wheel Bearing	- Inner	HUB228 [Ladder Type ABS Bearing]	HUB228 [Ladder Type ABS Bearing]	68111/49	HUB275 [with integrated ABS sensor]
	- Outer			12711/49	
Rear Wheel Oil Seal	- Inner	HUB UNIT	HUB UNIT		HUB UNIT
	- Outer			9941	
Rear Wheel Kit		PQ696 [5 Studs]	PQ696 [5 Studs]	PQ479	PQ940 [5 Studs]
Rear Wheel Hub / Stub Axle					

APPLICATIONS	LOCATION	CHRYSLER GRAND VOYAGER 2.5 SE MPV 3.3 LE, LX, Ltd., SE MPV	CHRYSLER GRAND VOYAGER 2.8 CRD 3.3 3.8		
		YEARS	96-04	2002-	
Front Wheel Bearing	- Inner	574298P HUB084 [Non ABS]	HUB274 [30 Splines] HUB276 [Flange Ø: 162mm] [with integrated ABS sensor] HUB277 [Flange Ø: 161.8mm] [with integrated ABS sensor]		
	- Outer				
Front Wheel Oil Seal	- Inner	Sealed Bearing HUB UNIT	HUB UNIT		
	- Outer				
Front Wheel Kit		PQ526 [14" Rims] PQ478 [15" Rims] [5 Studs]	PQ939 [5 Studs] PQ941 [2.8, 3.8] PQ942 [2.8, 3.8 Alt.]		
Front Wheel Hub / Stub Axle					
Alternator / Generator Bearing	- Front				
	- Rear				
Concentric / Thrust Bearing		RB9617			
Diff Carrier Bearing	- Left				
	- Right				
Diff Pinion Bearing	- Front				
	- Rear				
Propshaft Support Bearing					
Pulley Bearing					
Spigot Shaft Bearing					
V-Belt Tensioner					
Drive Shaft Oil Seal	- Left				
	- Right				
Gearbox Oil Seal	- Front				
	- Rear				
Pinion Oil Seal					
Spark Plug Tube Seal					
Rear Main Bearing Oil Seal					
Timing Cover / Cam Oil Seal					
Rear Wheel Bearing	- Inner	68111/49	HUB275 [with integrated ABS sensor] HUB278 [with integrated ABS sensor] HUB279 [with integrated ABS sensor]		
	- Outer	12711/49			
Rear Wheel Oil Seal	- Inner		HUB UNIT		
	- Outer	9941			
Rear Wheel Kit		PQ479	PQ940 [5 Studs] PQ943 [2.8, 3.8] PQ944 [2.8, 3.8 Alt.]		
Rear Wheel Hub / Stub Axle					

APPLICATIONS	LOCATION	CITROEN BERLINGO	CITROEN C1	CITROEN C2	CITROEN C3
		1.4 P/van TU3JP Pet. 1.6 TU5JP4B 1.6HDi 90LS DV6TED4BU, DV6AUTED4 1.9D LWB P/van XUD9A Dies.	1.0 1KR 1.0i Furio, Play 1KR	1.4 HDi, DV4TD 1.4i VTR TU3JP 1.6i VTS TU5JP4S	1.4i HDi, DV4TED4 1.6i Pluriel, Sensodrive, TU5JP4
YEARS		03-15	06-15	04-10	02-10
Front Wheel Bearing	- Inner	40574 [Non ABS] 40574X	DACFWB107ASB	40547 XGBCITC3	40547 XGBCITC3 [ID:37mm] [with integrated ABS sensor]
	- Outer				
Front Wheel Oil Seal	- Inner	Sealed Bearing	Sealed Bearing	Sealed Bearing	Sealed Bearing
	- Outer				
Front Wheel Kit		PQ483 [ID: 42mm] PQ593 [ASB]	PQ634 [ASB]	PQ604 [Non ABS] PQ776 [ASB]	PQ604 [Non ABS] PQ776 [ASB]
Front Wheel Hub / Stub Axle		483HUB	634HUB	483HUB [25 Spline] [Bearing ID: 42mm] 604HUB [21 Spline] [Bearing ID: 37mm]	483HUB [25 Spline] [Bearing ID: 42mm] 604HUB [21 Spline] [Bearing ID: 37mm]
Alternator / Generator Bearing	- Front				
	- Rear				
Concentric / Thurst Bearing		RB9610 [1.6] RB9671 Concentric Slave Cylinder	RB9692	RB9610	RB9610
Diff Carrier Bearing	- Left				
	- Right				
Diff Pinion Bearing	- Front				
	- Rear				
Propshaft Support Bearing					
Spigot Shaft Bearing					
V-Belt Tensioner					
Drive Shaft Oil Seal	- Left	405810	9699		405810
	- Right	325010	9646		304710
Gearbox Oil Seal	- Front	9981		9981	9981
	- Rear				
Pinion Oil Seal					
Spark Plug Tube Seal					
Rear Main Bearing Oil Seal		8510509 [1.4] 9242 [1.6] 9979 [1.9D]	9305		8510509 [1.4, 1.6] 9242 [1.4 HDi, 1.6 HDi]
Timing Cover / Cam Oil Seal		274707 [Cam 1.6] 355008 [Cam 1.9D] 365007 [Cam 1.4] 426606 [T/Cover 1.4] 9056 [T/Cover 1.9D] 9334 [T/Cover 1.6]	385006 [T/Cover]		274707 [Cam 1.4 HDi] 365007 [Cam 1.4, 1.6] 426607 [T/Cover 1.4, 1.6] 9334 [T/Cover 1.4 HDi, 1.6 HDi]
Rear Wheel Bearing	- Inner	HUB054 HUB055 [Gear type ABS: 29 Teeth] HUB319 [ASB] HUB346 [Gear type ABS: 48 Teeth]	HUB145 [with integrated ABS sensor]	FC12025 HUB122 [with integrated ABS sensor]	FC12025 HUB122 [with integrated ABS sensor]
	- Outer				
Rear Wheel Oil Seal	- Inner	HUB UNIT	HUB UNIT	Sealed Bearing [Drums] HUB UNIT [Discs]	Sealed Bearing [Drums] HUB UNIT [Discs]
	- Outer				
Rear Wheel Kit		PQ623 [Non ABS][4 Studs] PQ624 [ID: 32mm] [4 Studs] PQ1000 [ASB] PQ1041 [4 Holes]	PQ802 [4 Studs]	PQ484A [Drums] [ASB] PQ722 [Discs] [4 Studs]	PQ484A [Drums] [ASB] PQ722 [Discs] [4 Studs]
Rear Wheel Hub / Stub Axle					

APPLICATIONS	LOCATION	CITROEN C3 II	CITROEN C4	CITROEN C4 AIRCROSS	CITROEN C4 PICASSO
		1.2i VTi EB2F 1.4i VTi 1.6i VTi 1.6 HDi, e-HDi	1.6 VTR Coupe' TU5JP4 1.6 Hdi DV6TED4 2.0i VTS Coupe' EW10J4S	1.6 VTi EP6C 1.6 e-Hdi 2.0i Aircross 4B11	1.6 Hdi, THP, VTi
YEARS		2010-	05-10	10-15	11-16
Front Wheel Bearing	- Inner	<b>40574X</b> [with integrated ABS sensor] <b>XGBCITC3</b> [with integrated ABS sensor]	<b>40574X</b> <b>DAC43FWBDC</b> [with integrated ABS sensor]	<b>40574X</b>	<b>DACFWB42C4ASB</b>
	- Outer				
Front Wheel Oil Seal	- Inner	Sealed Bearing	Sealed Bearing	Sealed Bearing	Sealed Bearing
	- Outer				
Front Wheel Kit		<b>PQ593</b> [ID:42mm] <b>PQ776</b> [ID:37mm]	<b>PQ593</b> [ID:42mm] <b>PQ576</b> [ID:43mm]	<b>PQ593</b> [ID:42mm]	<b>PQ1125</b>
Front Wheel Hub / Stub Axle		<b>483HUB</b> [25 Spline] [Bearing ID: 42mm] <b>604HUB</b> [21 Spline] [Bearing ID: 37mm]	<b>483HUB</b> [25 Spline]	<b>483HUB</b> [25 Spline]	
Alternator / Generator Bearing	- Front				
	- Rear				
Concentric / Thurst Bearing		<b>RB9610</b> Concentric Slave Cylinder	<b>RB9610</b> [1.6, 2.0] Concentric Slave Cylinder	<b>RB9610</b> Concentric Slave Cylinder	
Diff Carrier Bearing	- Left				
	- Right				
Diff Pinion Bearing	- Front				
	- Rear				
Propshaft Support Bearing					
Pulley Bearing					
Spigot Shaft Bearing					
V-Belt Tensioner					
Drive Shaft Oil Seal	- Left		<b>405810</b>		
	- Right		<b>9331</b> [1.6, 2.0]		
Gearbox Oil Seal	- Front		<b>9981</b>		
	- Rear				
Pinion Oil Seal					
Spark Plug Tube Seal					
Rear Main Bearing Oil Seal		<b>8510508</b> [1.4, 1.6]	<b>9649</b> [1.6, HDi] <b>9979</b> [2.0] <b>9980</b> [3.0]	<b>8510309</b> [2.0] <b>8510509</b> [1.6, 1.6 Picasso] <b>9242</b> [1.6 e-HDi]	
Timing Cover / Cam Oil Seal		<b>9281</b> [Cam 1.4, 1.6]	<b>274707</b> [Cam 1.6 HDi] <b>9754</b> [Cam 2.0] <b>385007</b> [Cam 1.6 Pet., 3.0] <b>426606</b> [T/Cover 1.6] <b>405508</b> [T/Cover HDi, 2.0] <b>425607</b> [T/Cover 3.0]	<b>274707</b> [Cam 1.6 e-HDi] <b>9281</b> [T/Cover 1.6 Picasso] <b>9328</b> [T/Cover 2.0] <b>9334</b> [T/Cover 1.6 e-HDi]	
Rear Wheel Bearing	- Inner	<b>DACRWB25C3</b> <b>DACRWB207</b>	<b>HUB060</b> [01-04] [with integrated ABS sensor] <b>DACRWB307</b> [04-06] <b>DACRWB207</b> [06-09]	<b>DAC303008</b> <b>HUB287</b> [with integrated ABS sensor] <b>HUB397</b> [with integrated ABS sensor]	<b>HUB398</b> [with integrated ABS sensor] <b>HUB399</b> [with integrated ABS sensor]
	- Outer				
Rear Wheel Oil Seal	- Inner	Sealed Bearing	HUB UNIT Sealed Bearing	Sealed Bearing	
	- Outer				
Rear Wheel Kit		<b>PQ766</b> [ID: 25mm] <b>PQ826</b> [ID: 30mm]	<b>PQ605</b> [4 Studs] <b>PQ883</b> [ID: 25mm] <b>PQ826</b> [ID: 30mm]	<b>PQ999</b> <b>PQ951</b> ALT. <b>PQ1124</b> [5 Holes] [4X4]	<b>PQ1126</b> [Rear disc diameter 268] <b>PQ1127</b> [Rear disc diameter 268]
Rear Wheel Hub / Stub Axle					



APPLICATIONS	LOCATION	CITROEN C5 2.0 SX, EW10J4S 3.0 Exclusive A-T ES9J4S	CITROEN DS3 1.2i VTi EB2F 1.6 VTi EP6C 1.6 e-Hdi 9HP	CITROEN PICASSO, XSARA 1.6 SX TU5JP, HDi 1.8 Picasso Exclusive, EW7J4 2.0 Picasso HDi, VTS, Exclusive, HDi Exclusive DW10/TD	
YEARS		01-05	2010-	03-08	
Front Wheel Bearing	- Inner	<b>40574X</b>	<b>40574X</b> <b>XGBCITC3</b> [with integrated ABS sensor]	<b>40574</b> [Non ABS]	
	- Outer				
Front Wheel Oil Seal	- Inner	Sealed Bearing	Sealed Bearing	Sealed Bearing	
	- Outer				
Front Wheel Kit		<b>PQ593</b> [ASB]	<b>PQ593</b> [ID:42mm] <b>PQ776</b> [ID:37mm]	<b>PQ483</b> [ID: 42mm]	
Front Wheel Hub / Stub Axle		<b>483HUB</b> [25 Spline]	<b>483HUB</b> [25 Spline] [Bearing ID: 42mm] <b>604HUB</b> [21 Spline] [Bearing ID: 37mm]	<b>483HUB</b>	
Alternator / Generator Bearing	- Front				
	- Rear				
Concentric / Thurst Bearing		<b>RB9610</b> [2.0] <b>RB9611</b> [3.0]	<b>RB9610</b> <b>Concentric Slave</b> <b>Cylinder</b>	<b>RB9007</b> [1.6 XSARA] <b>RB9610</b> [1.6HDi, 2.0]	
Diff Carrier Bearing	- Left				
	- Right				
Diff Pinion Bearing	- Front				
	- Rear				
Propshaft Support Bearing					
Drive Shaft Oil Seal	- Left			<b>405810</b> [XSARA]	
	- Right	<b>304710</b> [2.0] <b>325010</b> [3.0]		<b>304710</b> [XSARA]	
Gearbox Oil Seal	- Front				
	- Rear				
Pinion Oil Seal					
Rear Main Bearing Oil Seal		<b>9979</b> [2.0] <b>9980</b> [3.0]	<b>8510509</b>	<b>8510509</b> [1.6] <b>9242</b> [1.6HDi] <b>9352</b> [1.8, 2.0] <b>9979</b> [2.0VTi, HDi]	
Timing Cover / Cam Oil Seal		<b>365007</b> [Cam 2.0] <b>405508</b> [T/Cover HDi, 2.0] <b>425607</b> [T/Cover 3.0]	<b>9281</b> [T/Cover]	<b>385006</b> [Cam 1.6] <b>274707</b> [Cam 1.6HDi] <b>365007</b> [Cam 1.6, 1.8, 2.0] <b>9055</b> [Cam 2.0HDi] <b>426607</b> [T/Cover 1.6] <b>405508</b> [T/Cover 1.8] <b>9056</b> [2.0VTi, HDi] <b>9334</b> [T/Cover 1.6D, 1.8, 2.0D]	
Rear Wheel Bearing	- Inner	<b>HUB072</b>	<b>DACRWB207</b>	<b>HUB059</b> [Gear type ABS] <b>HUB055</b> [Gear type ABS: 29 Teeth] <b>HUB319</b> [ASB][Picasso] <b>HUB346</b> [Gear type ABS: 48 Teeth] <b>HUB347</b> [Gear type ABS: 29 Teeth] <b>HUB348</b> [Gear type ABS: 48 Teeth]	
	- Outer				
Rear Wheel Oil Seal	- Inner	HUB UNIT	Sealed Bearing	HUB UNIT	
	- Outer				
Rear Wheel Kit		<b>PQ594</b>	<b>PQ826</b> [ID: 30mm]	<b>PQ536</b> [ID: 25mm][ABS] [4 Studs] <b>PQ624</b> [ID: 32mm][ABS] [4 Studs] <b>PQ1000</b> [05-06] <b>PQ1041</b> [4 Holes] <b>PQ1042</b> [Flange Ø: 128mm] <b>PQ1043</b> [Flange Ø: 129mm]	
Rear Wheel Hub / Stub Axle					

APPLICATIONS	LOCATION	DAEWOO CIELO 1.5 GL, GLX, GTX 150i L Espero 1.8 CD, C18LE 2.0 CD, C20LE	DAEWOO LANOS I 1.35i S 1.6 SX LANOS II 1.4 S 1.6 SX	DAEWOO MATIZ 800cc S, SE F8CV	DAEWOO NUBIRA I 1.6 SX, 2.0 CDX NUBIRA II 1.6 SX, SX S/W 2.0 CDX, Exec., S/W
YEARS		96-99	97-03	99-03	97-03
Front Wheel Bearing	- Inner	309726 [Cielo] 309639 [Espero]	309639 [Lanos I] 309726 [Lanos II]	68111/68149	309639
	- Outer			68111/68149	
Front Wheel Oil Seal	- Inner	Sealed Bearing	Sealed Bearing	9551	Sealed Bearing
	- Outer			9973	
Front Wheel Kit		PQ107 [Cielo] PQ106 [Espero]	PQ106 [Lanos I] PQ107 [Lanos II]	PQ597	PQ106
Front Wheel Hub / Stub Axle		107HUB 106HUB	106HUB 107HUB	597HUB	106HUB
Alternator / Generator Bearing	- Front	62022RS	62022RS		
	- Rear	60002RS	60002RS		
Concentric / Thurst Bearing		RB9892	RB9892	RB9606	RB9892
Diff Carrier Bearing	- Left	32007	69310/49		69310/49
	- Right	32007	69310/49		69310/49
Diff Pinion Bearing	- Front				
	- Rear				
Propshaft Support Bearing					
Pulley Bearing					
Spigot Shaft Bearing					
V-Belt Tensioner					
Drive Shaft Oil Seal	- Left	9974	9968	9104	
	- Right	9974	9968	9104	
Gearbox Oil Seal	- Front	9717	9717	9972	9717
	- Rear				
Pinion Oil Seal					
Spark Plug Tube Seal					
Rear Main Bearing Oil Seal		9464	9464	608008	9464 [1.6] 9914 [2.0]
Timing Cover / Cam Oil Seal		425607 [Cam] 9967 [T/Cover] 354807 [T/Cover]	425607 [Cam] 304208 [Cam] 354807 [T/Cover]	9971 [Cam & T/Cover]	425607 [Cam] 304208 [Cam] 9715 [T/Cover] 354807 [T/Cover]
Rear Wheel Bearing	- Inner	331274	331274	30205	331274
	- Outer	11710/49	11710/49	30204	11710/49
Rear Wheel Oil Seal	- Inner				
	- Outer	405208SP	405208SP	405207 9567	405208SP
Rear Wheel Kit		PQ108	PQ108	PQ146	PQ108
Rear Wheel Hub / Stub Axle					

APPLICATIONS	LOCATION	DAEWOO NUBIRA 1.6	DAEWOO TACUMA 1.6 SX 2.0 CDX, CDX Plus	DFM Mini Truck	
		YEARS	2002-	01-03	
Front Wheel Bearing	- Inner		636096		
	- Outer				
Front Wheel Oil Seal	- Inner		Sealed Bearing		
	- Outer				
Front Wheel Kit			PQ439	PQ738	
Front Wheel Hub / Stub Axle			439HUB		
Alternator / Generator Bearing	- Front				
	- Rear				
Concentric / Thurst Bearing		Concentric Slave Cylinder	RB9892		
Diff Carrier Bearing	- Left				
	- Right				
Diff Pinion Bearing	- Front				
	- Rear				
Propshaft Support Bearing					
Pulley Bearing					
Spigot Shaft Bearing					
V-Belt Tensioner					
Drive Shaft Oil Seal	- Left				
	- Right				
Gearbox Oil Seal	- Front		9717		
	- Rear				
Pinion Oil Seal					
Spark Plug Tube Seal					
Rear Main Bearing Oil Seal			9464 [1.6] 9914 [2.0]		
Timing Cover / Cam Oil Seal			304208 [Cam] 354807 [T/Cover]		
Rear Wheel Bearing	- Inner		HUB047 [with integrated ABS sensor]		
	- Outer				
Rear Wheel Oil Seal	- Inner		HUB UNIT		
	- Outer				
Rear Wheel Kit			PQ609 [4 Studs]		
Rear Wheel Hub / Stub Axle					

APPLICATIONS	LOCATION	DAIHATSU CHARADE	DAIHATSU CHARADE	DAIHATSU CUORE	DAIHATSU FERROZA
		0.8 CX, CXL G11 CB22, Turbo G21 CB60	1.0 1KR-FE	847cc ED10	1.6 F300HDE
YEARS		83-85	03-11	97-03	98-99
Front Wheel Bearing	- Inner	6305C3	DAC356437	6305C3 DAC356437	32008CP
	- Outer	6305C3		6305C3	32007XP
Front Wheel Oil Seal	- Inner	9606	Sealed Bearing	9606	
	- Outer	9607		9607	
Front Wheel Kit		PQ126	PQ762	PQ126 PQ762 [Alt.]	PQ564
Front Wheel Hub / Stub Axle			762HUB [24 Splines]		
Alternator / Generator Bearing	- Front	62012RS			
	- Rear	62002RS			
Concentric / Thurst Bearing		RB9835	RB9627	RB9835	RB9620
Diff Carrier Bearing	- Left	6008			
	- Right	6208			
Diff Pinion Bearing	- Front				
	- Rear				
Propshaft Support Bearing					
Pulley Bearing					
Spigot Shaft Bearing					
V-Belt Tensioner					
Drive Shaft Oil Seal	- Left				
	- Right				
Gearbox Oil Seal	- Front	253506			
	- Rear				
Pinion Oil Seal					
Spark Plug Tube Seal					
Rear Main Bearing Oil Seal		9608	587410	9776	9648
Timing Cover / Cam Oil Seal		324807 [Cam, T/cover]	9538 [T/Cover] 344606 [Cam]	324807 [Cam, T/cover]	
Rear Wheel Bearing	- Inner	6205 2RS	6304 RSC3	6304 RSC3	358021P+C3
	- Outer	6303 2RSC3	6203 C3	6203 C3	
Rear Wheel Oil Seal	- Inner		304207	304207	
	- Outer				
Rear Wheel Kit			PQ534	PQ534	PQ565
Rear Wheel Hub / Stub Axle					

APPLICATIONS	LOCATION	DAIHATSU GRAN MAX 1.5 I 3SZ-VE	DAIHATSU MATERIA 1.5 1.5 I 3SZ-VE	DAIHATSU SIRION 1.3 K3-VE 1.5 3SZ-VE	DAIHATSU TERIOS 4X2, 4X4 1.3 SUV K3-VE 1.5i Off-Road, 5/7 Seater SUV 3SZ-VE 1.5 3SZ-VE
		YEARS	2009-	07-11	00-14
Front Wheel Bearing	- Inner	DAC38BWDVAZASB	DAC35MAT	6207 C3 [Some] DAC356437	DAC38BWDVAZASB
	- Outer				
Front Wheel Oil Seal	- Inner	Sealed Bearing	Sealed Bearing	Sealed Bearing	Sealed Bearing
	- Outer				
Front Wheel Kit		PQ923 [ASB]	PQ945	PQ763 [Some] PQ762	PQ923 [ASB]
Front Wheel Hub / Stub Axle				762HUB [24 Splines]	
Alternator / Generator Bearing	- Front				
	- Rear				
Concentric / Thurst Bearing				RB9627	RB9627
Diff Carrier Bearing	- Left				
	- Right				
Diff Pinion Bearing	- Front				
	- Rear				
Propshaft Support Bearing					
Pulley Bearing					
Spigot Shaft Bearing					
V-Belt Tensioner				VBT008 [1.3 2005-]	
Drive Shaft Oil Seal	- Left				
	- Right				
Gearbox Oil Seal	- Front				
	- Rear				
Pinion Oil Seal					
Spark Plug Tube Seal					
Rear Main Bearing Oil Seal		9305	9305	9305	9305
Timing Cover / Cam Oil Seal		9765 [T/cover]	9765 [T/cover]	9765 [Cam, T/cover]	385007 [Cam] 9765 [T/cover]
Rear Wheel Bearing	- Inner	HUB130 [Non ABS]	HUB105 [with integrated ABS sensor]	HUB105 [with integrated ABS sensor]	TOY32BCVAVZ + RR55 TOY32BCVAVZ + RR50 [Step Collar]
	- Outer				
Rear Wheel Oil Seal	- Inner	HUB UNIT	HUB UNIT	HUB UNIT	9299
	- Outer				
Rear Wheel Kit		PQ738 [4 Studs]	PQ764 [4 Studs]	PQ764 [4 Studs]	PQ859 PQ783 [Step Collar]
Rear Wheel Hub / Stub Axle					

APPLICATIONS	LOCATION	DODGE CALIBER	DODGE JOURNEY	DODGE NITRO	
		1.8 SE, SXT, EBE 2.0 TD, SXT, CVT, ECN 2.4 RT, SXT, EDA	2.0 CRD, R/T, ECE 2.4 SXT, ED3 2.7 V6 R/T, SXT, EER 3.6 V6 R/T, SXT, ERB	4X4 2.8 CRD ENS 3.7 EKD	
YEARS		06-12	2008-	07-10	
Front Wheel Bearing	- Inner	DAC43FWBDC	HUB221 [with integrated ABS sensor]	HUB280 [with integrated ABS sensor]	
	- Outer				
Front Wheel Oil Seal	- Inner	Sealed Bearing	HUB UNIT	HUB UNIT	
	- Outer				
Front Wheel Kit		PQ576 [ASB]	PQ578 [5 Studs]	PQ946 [5 Studs]	
Front Wheel Hub / Stub Axle					
Alternator / Generator Bearing	- Front				
	- Rear				
Concentric / Thurst Bearing		Concentric Slave Cylinder	Concentric Slave Cylinder		
Diff Carrier Bearing	- Left				
	- Right				
Diff Pinion Bearing	- Front				
	- Rear				
Propshaft Support Bearing					
Pulley Bearing					
Spigot Shaft Bearing					
V-Belt Tensioner					
Drive Shaft Oil Seal	- Left				
	- Right				
Gearbox Oil Seal	- Front				
	- Rear				
Pinion Oil Seal					
Spark Plug Tube Seal					
Rear Main Bearing Oil Seal		9229FS [Diesel] 8510308 [Petrol]	9229FS [Diesel] 8510308 [Petrol] 9301 [2.7]	9065	
Timing Cover / Cam Oil Seal		9548 [Cam] 9549 [T/Cover Diesel] 425507 [T/Cover Petrol]	9548 [Cam] 9549 [T/Cover Diesel] 425507 [T/Cover Petrol] 9575 [T/Cover 2.7]	304707 [Cam] 9241 [T/Cover]	
Rear Wheel Bearing	- Inner	HUB220 [with integrated ABS sensor]	HUB222L/R [with integrated ABS sensor]	D/S35	
	- Outer				
Rear Wheel Oil Seal	- Inner	HUB UNIT	HUB UNIT		
	- Outer				
Rear Wheel Kit		PQ577 [5 Studs]	PQ595L/R [5 Studs]	PQ947	
Rear Wheel Hub / Stub Axle					

APPLICATIONS	LOCATION	FIAT 500	FIAT DOBLO	FIAT MULTIPLA	FIAT PALIO I
		0.9 199 B6.000 1.2 169A4.000 1.4 16V 169A3.000	1.9 Cargo P/van 223A6.000	1.6 Active 1.6 SX 1.9 JTD ELX MPV 182A4.000	1.2 ED, EL, Go!, Paint Ltd. M657BA.12T 178B5.000 1.6 EL, ELX, HL, Weekend S/W, 178B3.000
YEARS		08-15	03-06	03-10	00-05
Front Wheel Bearing	- Inner	<b>12131ASB</b> [with integrated ABS sensor] <b>12306XGB</b> [with integrated ABS sensor]	<b>12131</b> <b>12131ASB</b>	<b>12131</b> [Non ABS] <b>12131ASB</b> [with integrated ABS sensor]	<b>12132</b> [Non ABS] <b>12132ASB</b> [with integrated ABS sensor]
	- Outer				
Front Wheel Oil Seal	- Inner	Sealed Bearing	Sealed Bearing	Sealed Bearing	Sealed Bearing
	- Outer				
Front Wheel Kit		<b>PQ474</b> [1.4, 0.9] [ID: 37mm] <b>PQ567</b> [1.2] [ID: 35mm]	<b>PQ472</b> [Non ABS] <b>PQ474</b> [ABS]	<b>PQ472</b> [ID: 37mm] [Non ABS] <b>PQ474</b> [ID: 37mm]	<b>PQ779</b> [ID: 35mm] <b>PQ780</b>
Front Wheel Hub / Stub Axle		<b>474HUB</b> [25 Spline] <b>567HUB</b> [22 Spline]	<b>895HUB</b> [OD: 37mm]	<b>474HUB</b> [25 Spline] [For PQ472 and PQ474]	<b>779HUB</b> [OD: 35mm] [For PQ779 and PQ780]
Alternator / Generator Bearing	- Front				
	- Rear				
Concentric / Thurst Bearing		<b>RB9003</b> Concentric Slave Cylinder	<b>RB9580</b>	<b>RB9580</b>	<b>RB9003</b>
Diff Carrier Bearing	- Left				
	- Right				
Diff Pinion Bearing	- Front				
	- Rear				
Propshaft Support Bearing					
Pulley Bearing					
Spigot Shaft Bearing			<b>Bush</b>	<b>Bush</b>	<b>Bush</b>
V-Belt Tensioner					
Drive Shaft Oil Seal	- Left	<b>9043</b> <b>9050</b> [1.2]	<b>9960</b>	<b>9960</b>	<b>9977</b>
	- Right	<b>9043</b>	<b>9959</b>	<b>9959</b>	<b>9978</b>
Gearbox Oil Seal	- Front		<b>9570</b>	<b>9570</b>	
	- Rear		<b>9570</b>	<b>9570</b>	<b>9570</b>
Pinion Oil Seal					
Spark Plug Tube Seal					
Rear Main Bearing Oil Seal		<b>748808</b> [1.2] <b>9046</b> [1.4]	<b>748808</b>	<b>748808</b>	<b>748808</b>
Timing Cover / Cam Oil Seal		<b>9045</b> [Cam] <b>9044</b> [T/Cover]	<b>304207</b> [Cam] <b>9957</b> [T/Cover]	<b>304207</b> [Cam] <b>9957</b> [T/Cover]	<b>305207</b> [Cam] <b>304207</b> [Aux. Shaft] <b>233506</b> [T/Cover 1.2] <b>405607</b> [T/Cover 1.6]
Rear Wheel Bearing	- Inner	<b>HUB019</b> [with integrated ABS sensor]	<b>40652S</b> <b>40652SP</b>	<b>HUB019</b> [with integrated ABS sensor] <b>HUB020</b>	<b>HUB019</b> [with integrated ABS sensor] <b>HUB020</b>
	- Outer				
Rear Wheel Oil Seal	- Inner	HUB UNIT	Sealed Bearing	HUB UNIT	HUB UNIT
	- Outer				
Rear Wheel Kit		<b>PQ465</b> [ASB]	<b>PQ599</b> [Non ABS] <b>PQ600</b> [ABS]	<b>PQ465</b> [ASB] <b>PQ473</b> [No ABS]	<b>PQ465</b> [ASB] <b>PQ473</b> [No ABS]
Rear Wheel Hub / Stub Axle					



APPLICATIONS	LOCATION	FIAT PALIO II	FIAT PANDA	FIAT PUNTO	FIAT GRANDE PUNTO I
		1.2 Espresso 178B6.000 1.2 Go!, 178B5.000 1.6 178B3.000 1.7TD, EL.	1.1 Active, 187A1.000 1.2 Dynamic 169A4.000, 188A4.000 1.4 100HP 169A3.000	1.2 Dynamic 188A5.000 1.3D 2U 188 JTD Dynamic, JTD Multijet 188A9.000 1.4 Multiair 16V 1.8 HGT 188A1.000, 188A6.000	1.2 199A4.000 1.3D JTD Dynamic, JTD Multijet 199A3.000 1.4 1.9 Multijet 939A1.000
YEARS		05-10	2006-	04-14	06-10
Front Wheel Bearing	- Inner	12132 [Non ABS] 12132ASB [with integrated ABS sensor]	12131ASB [ASB] 12306GB [NON ASB] 12306XGB [ASB]	DACFWB35PTO [1.2] 12131 [1.3] 12131ASB [ASB] DACFWBOCD	12131ASB [ASB] [Grande Punto I] DACFWBOCD
	- Outer				
Front Wheel Oil Seal	- Inner	Sealed Bearing	Sealed Bearing	Sealed Bearing	Sealed Bearing
	- Outer				
Front Wheel Kit		PQ779 [ID: 35mm] PQ780	PQ474 [1.2 AWD, 1.4] PQ566 [1.1] PQ567 [1.2]	PQ472 [1.3] [Non ABS] PQ474 [1.4, 1.8] [ASB] PQ751 [1.2] [Non ABS] PQ633 [1.2, 1.4] [ASB]	PQ474 [1.3 Dies.] PQ633 [Pet. Models]
Front Wheel Hub / Stub Axle		779HUB [OD: 35mm] [For PQ779 and PQ780]	474HUB [OD: 37mm] 567HUB [OD: 35mm]	474HUB [PQ472, 474] 474BHUB [1.4 99Kw] 474CHUB [1.8 HGT] 567HUB [PQ751] 633HUB [1.4 77Kw]	474BHUB [OD: 37mm] [Grande Punto I] 633HUB [OD: 35mm]
Alternator / Generator Bearing	- Front				
	- Rear				
Concentric / Thurst Bearing		RB9003 [1.2, 1.6] RB9580 [1.7]	RB9003	Concentric Slave Cylinder RB9003 [1.2, 1.4] RB9580 [1.3] RB9816 [1.8]	Concentric Slave Cylinder RB9003 [1.2, 1.4] RB9580 [1.3 06-07]
Drive Shaft Oil Seal	- Left	9977	9977 [1.2 13-, 1.4]	9048 [1.3, 1.8] 9977 [1.2] 9978 [1.4]	9043 [1.2] 9048 [1.3] 9050 [1.4] 9051 [1.9]
	- Right	9978	9978 [1.2 13-, 1.4]	9049 [1.3, 1.8] 9978	9043 [1.2, 1.4] 9049 [1.3] 9051 [1.9]
Gearbox Oil Seal	- Front				
	- Rear	9570	9570		
Rear Main Bearing Oil Seal		748808 [1.2, 1.6] 749010 [1.7D]	748808 [1.1, 1.2, 1.4] 9046 [1.4]	748808 [1.4] 9046 [1.2, 1.4 Multiair] 9329 [1.3] 9958 [1.8]	748808 [1.2, 1.4 5 Spd.] 9329 [1.3] 9046 [1.4 6 Spd.] 9958 [1.9]
Timing Cover / Cam Oil Seal		305207 [Cam] 304207 [Aux. Shaft] 233506 [T/Cover 1.2] 405607 [T/Cover 1.6]	304207 [Cam 1.1, 1.2 05-12] 9045 [Cam 1.2 13-, 1.4] 9044 [T/Cover] 233506 [T/Cover 1.1, 1.2 05-12 Alt.]	304207 [Cam 1.8] 9045 [Cam 1.4] 9047 [Cam 1.4 Multiair] 9052 [Cam 1.8] 9508 [Cam 1.2] 9044 [T/Cover 1.2, 1.4] 405207 [T/Cover 1.3] 9053 [T/Cover 1.8]	9045 [1.4 Cam] 9047 [1.2 Cam] 9044 [T/Cover 1.2, 1.4] 405207 [1.3] 9957 [T/Cover 1.9]
Rear Wheel Bearing	- Inner	HUB021 [ABS GEAR TYPE] HUB019 [with integrated ABS sensor] [Except: 1.2 Espresso]	HUB020 HUB019 [with integrated ABS sensor] 12306XGB [1.2 AWD]	HUB020 HUB019 [Flange Ø: 117mm] [with integrated ABS sensor] HUB227 [Flange Ø: 117mm] [with integrated ABS sensor]	HUB227 [Flange Ø: 120mm] [with integrated ABS sensor]
	- Outer				
Rear Wheel Oil Seal	- Inner	HUB UNIT	HUB UNIT Sealed Bearing	HUB UNIT	HUB UNIT
	- Outer				
Rear Wheel Kit		PQ475 [ASB] PQ465 [ASB] [Except: 1.2 Espresso]	PQ473 [NON ABS] PQ465 [ASB] PQ567 [1.2 AWD]	PQ473 [1.2] [NON ABS] PQ465 [1.3, 1.8 ASB] PQ571 [1.4T] [ASB]	PQ571 [ASB]
Rear Wheel Hub / Stub Axle					

APPLICATIONS	LOCATION	FIAT GRANDE PUNTO II	FIAT SEICENTO	FIAT SIENA I/II	FIAT STILO
		1.2 199A4.000 1.4 16V 1.4 1.4 T-Jet	1.1 S, Sporting 176B2.000	1.2 EL, EL, Plus!, M657BA 12T 1.6 EL, Plus!, ELX HL 178B3.000 1.6 EL+, HL, ELX, 178B3000 1.7TD EL 176A3.000	1.6 Active, MultiWagon, 182B6 1.9 JTD Dynamic, MultiWagon JTD Dynamic 192A1.000, 937A7.000
YEARS		08-12	01-03	00-10	03-06
Front Wheel Bearing	- Inner	DACFWBOCD	12306GB 12306XGB	12132 12132ASB	DAC37STILO
	- Outer				
Front Wheel Oil Seal	- Inner	Sealed Bearing	Sealed Bearing	Sealed Bearing	
	- Outer				
Front Wheel Kit		PQ633	PQ566 [Non ABS] PQ567 [ABS/ASB]	PQ779 [Non ABS] PQ780 [ASB]	PQ1054
Front Wheel Hub / Stub Axle		633HUB [OD: 35mm]	567HUB [OD: 35mm]	779HUB [OD: 35mm] [For PQ779 and PQ780]	474HUB
Alternator / Generator Bearing	- Front				
	- Rear				
Concentric / Thurst Bearing		Concentric Slave Cylinder RB9003 [1.2, 1.4]	RB9003	RB9003 [1.2, 1.6] RB9580 [1.7]	RB9003 [1.6] Concentric Slave Cylinder
Diff Carrier Bearing	- Left				
	- Right				
Diff Pinion Bearing	- Front				
	- Rear				
Propshaft Support Bearing					
Pulley Bearing					
Spigot Shaft Bearing				Bush	Bush
V-Belt Tensioner					
Drive Shaft Oil Seal	- Left	9050 [1.2, 1.4] 9051 [1.4 T-jet,]	9977	9977	9977 [1.6] 9960 [1.9]
	- Right	9043 [1.2, 1.4] 9051 [1.4 T-jet]	9978	9978	9978 [1.6] 9959 [1.9]
Gearbox Oil Seal	- Front		9947		9947 [1.6] 9570 [1.9]
	- Rear			9570	9570
Pinion Oil Seal					
Spark Plug Tube Seal					
Rear Main Bearing Oil Seal		748808 [1.2, 1.4 5 Spd.] 9046 [1.4 6 Spd.] 9958 [1.4 T-jet]	748808	748808	748808
Timing Cover / Cam Oil Seal		9044 [T/Cover 1.2, 1.4] 9045 [1.2, 1.4 Cam] 9957 [T/Cover 1.4 T-jet]	304207 [Cam] 233506 [T/Cover]	233506 [T/Cover] 405607 [T/Cover Alt.] 304207 [Aux. Shaft]	304207 [Cam 1.6] 305207 [Cam 1.9] 405607 [T/Cover 1.6] 9957 [T/Cover 1.9]
Rear Wheel Bearing	- Inner	HUB227 [Flange Ø: 120mm] [with integrated ABS sensor]	HUB070 [Rim: 4 -Hole, Flange Ø: 117mm]	HUB020 HUB021 [ABS GEAR TYPE]	HUB019 [with integrated ABS sensor]
	- Outer				
Rear Wheel Oil Seal	- Inner	HUB UNIT	HUB UNIT	HUB UNIT	HUB UNIT
	- Outer				
Rear Wheel Kit		PQ571 [ASB]	PQ502 [Non ABS]	PQ473 [Non ABS] PQ475 [ABS]	PQ465 [ABS]
Rear Wheel Hub / Stub Axle					

APPLICATIONS	LOCATION	FIAT STRADA	FIAT ULYSSE	FIAT UNO	FIAT UNO
		1.2 EL P/up 1.4 1.6 EL, EL Sporting, ELX P/up 1.7D EL P/up	2.0 MPV XU10 J2/Z	1.4 Turbo 146A	1.0 Cento 156A2 1.1 Espresso P/van 160A3 1.1 Fire, Rio, Mia, Tempo 160A3 1.4 Pacer, Beat, Mia, Tempo, SX 146C1
YEARS		05-10	99-02	90-98	90-05
Front Wheel Bearing	- Inner	DACFWBSTRA	40206GBP 40246ASB	12132	616890
	- Outer				
Front Wheel Oil Seal	- Inner	Sealed Bearing	Sealed Bearing	Sealed Bearing	9432 [Brg. bolt on seal] Sealed Bearing
	- Outer				
Front Wheel Kit		PQ895	PQ568 PQ504ASB	PQ779	PQ393
Front Wheel Hub / Stub Axle		895HUB [OD: 37mm]			393HUB [OD: 30mm]
Alternator / Generator Bearing	- Front			6302ZZ	6302ZZ
	- Rear			6201ZZ	6201ZZ
Concentric / Thurst Bearing		RB9003 [1.2] RB9580 [1.7] RB9602 [1.6]	RB9611	RB9816	RB9813 [Cable 1.1] RB9819 [Cable 1.4] RB9003 [Hyd.]
Diff Carrier Bearing	- Left			639068	639068
	- Right			639062	639062
Diff Pinion Bearing	- Front				
	- Rear				
Propshaft Support Bearing					
Pulley Bearing					
Spigot Shaft Bearing				Bush	Bush
V-Belt Tensioner					
Drive Shaft Oil Seal	- Left	9977	405810		9977
	- Right	9978	304710		9978
Gearbox Oil Seal	- Front			9570 [90-95] 9947 [96-98]	9570 [90-95] 9947 [96-05]
	- Rear	9570			
Pinion Oil Seal					
Spark Plug Tube Seal					
Rear Main Bearing Oil Seal		748808 [1.2, 1.6] 749010 [1.7] 9062 [1.6] [ID: 64mm]	9979	708808	648008 [90-95] 708808 [95-96] 748808 [96-05]
Timing Cover / Cam Oil Seal		304207 [Cam 1.2, 1.6] 9558 [Cam 1.2 Alt.] 305207 [Cam 1.7] 233506 [T/cover 1.2] 9044 [T/cover 1.2 Alt.] 405607 [T/cover 1.6] 9557 [T/cover 1.7]	365007 [Cam] 426207 [T/Cover]	305207 [Cam] 405607 [T/Cover]	304207 [Cam 1.0, 1.1] 305207 [Cam 1.4] 233506 [T/cov. 1.0, 1.1] 405607 [T/Cover 1.4]
Rear Wheel Bearing	- Inner	HUB020	HUB042 HUB043	HUB761	HUB760 [Rim: 4 -Hole] [Flange Ø: 117mm]
	- Outer				
Rear Wheel Oil Seal	- Inner	HUB UNIT	HUB UNIT	HUB UNIT	HUB UNIT
	- Outer				
Rear Wheel Kit		PQ473	PQ569 [Non ABS] PQ570 [ABS]	PQ412	PQ411 [Non ABS]
Rear Wheel Hub / Stub Axle					

APPLICATIONS	LOCATION	FORD BANTAM	FORD BANTAM	FORD "Boet" BANTAM	FORD B-MAX
		1300 P/up Kent 2V 1400 Leisure, Nite P/up CVH/FUA 1600 Leisure Explorer, Nite P/up CVH	130 Explorer P/up B3 160, i Explorer, Leisure, Sport, P/up B6/ F6	ROCAM 1.3i XL, XLT 1.4i TDCi 1.6i XL, XLT, XLE 1.8D XL	1.0 EcoBoost M1JE, M1JH
YEARS		83-94	94-03	02-12	2012-
Front Wheel Bearing	- Inner	68111/573315	69310/45	309639	309639ASB
	- Outer	68111/573315	69310/45		
Front Wheel Oil Seal	- Inner	9449	9444	Sealed Bearing	Sealed Bearing
	- Outer	9450	9445		
Front Wheel Kit		PQ141	PQ184	PQ106	PQ499 [ASB] PQ844
Front Wheel Hub / Stub Axle		141HUB	184HUB SA184L/R	106FHUB SA106FL/R	499AHUB [PCD: 108mm]
Alternator / Generator Bearing	- Front	62032RS	62032RS		
	- Rear	62012RS	62012RS		
Concentric / Thurst Bearing		RB9592	RB9820	Concentric Slave Cylinder	
Diff Carrier Bearing	- Left	29711+49	68111+49		
	- Right	29711+49	68111+49		
Diff Pinion Bearing	- Front	362668			
	- Rear	362351B			
Propshaft Support Bearing					
Pulley Bearing					
Spigot Shaft Bearing					
V-Belt Tensioner					
Drive Shaft Oil Seal	- Left	405510	9654	9678	9554
	- Right	405510	9654	9678	9554
Gearbox Oil Seal	- Front	345007 [1.4, 1.6]	274308		
	- Rear	9467 [1.4, 1.6]			
Pinion Oil Seal					
Spark Plug Tube Seal					
Rear Main Bearing Oil Seal		2825 [1.3] 9452 [1.4, 1.6]	9742 [1.3] 9667 [1.6]	9566FS	9579
Timing Cover / Cam Oil Seal		425607 [Cam 1.4, 1.6] 9634 [T/cover 1.3] 355007 [T/cover 1.4, 1.6]	9682 [Cam, T/cover ] 9666 [Cam, T/cover 1.6] Some Models 9870 [T/cover 1.3, 1.6]	9565 [T/Cover]	9241 [T/Cover]
Rear Wheel Bearing	- Inner	67010+48	67010+48	329013	HUB246 [with integrated ABS sensor]
	- Outer	11910+49	11910+49	329013	
Rear Wheel Oil Seal	- Inner		9644	9644	HUB UNIT
	- Outer	9633	9633		
Rear Wheel Kit		PQ233L/R	PQ233L/R	PQ418	PQ843
Rear Wheel Hub / Stub Axle				SA418	

APPLICATIONS	LOCATION	FORD CORTINA MkIII	FORD CORTINA MkIV	FORD CORTINA MkV	FORD COURIER
		1.6 L P/up Kent 1.6 L, Std., XL Kent 2.0 OHC GT, V4 L, XL, S/W Essex EV20 2.0 V4 P/up Koln T20 2.5 L P/up Essex EV25 2.5 XL, S/W Essex EV25 3.0 GT, L, XL, XLE "Big Six" Essex EV30	1.3 L Kent 1.6 GL, L, S/W Kent 1.6 P/up Kent 2.0 GL, GLE, S/W Koln T20 3.0 V6 Ghia, GLS, S, S/W Essex EV30 3.0 V6 Leisure, P/up Essex EV30	1.3 L Kent 1.6 GL, L, Kent 1.6 P/up Kent 2.0 Ghia, GL Koln T20 2.4 P/up York D24 3.0 V6 GLS, GLS XR6, Essex EV30 3.0 V6 Leisure P/up Essex EV30	1.6 P/up F6 1.8 Chassis cab, Explorer, Std., XLT P/up F8. 2.0 XLT FE. 2.2 D/cab, Explorer, Leisure, Std., XLT P 3.0 V6 D/cab, Explorer, L, Leisure, Std., P/up Essex
YEARS		71-77	77-80	80-86	86-00
Front Wheel Bearing	- Inner	44610/49 [1.6, 2.0, 2.5 L] 331274 [2.5 XL, 3.0]	44610/49 [1.3, 1.6, 2.0] 331274 [3.0]	44610/49 [1.3, 1.6, 2.0] 331274 [3.0]	48510/48
	- Outer	11710/49	11710/49	11710/49	30205
Front Wheel Oil Seal	- Inner	405508	405508	405508	9669
	- Outer				
Front Wheel Kit		PQ120 [1.6, 2.0, 2.5 L] PQ110 [2.5 XL, 3.0]	PQ120 [1.3, 1.6, 2.0] PQ110 [3.0]	PQ120 [1.3, 1.6, 2.0] PQ110 [3.0]	PQ234
Front Wheel Hub / Stub Axle					234HUB
Alternator / Generator Bearing	- Front	62032RS	62032RS	62032RS	62012RS [Pet.] 62022RS [3.0] 63022RS [Dies.]
	- Rear	62012RS	62012RS	62012RS	63022RS [3.0] 63032RS [Pet.] 6201VRS [Dies.]
Concentric / Thurst Bearing		RB9582C	RB9582C	RB9582C	RB9588A [3.0] RB9589 RB9856 [2.2 90-00]
Diff Carrier Bearing	- Left	501310+49	501310+49	501310+49	501310+49
	- Right	501310+49	501310+49	501310+49	501310+49
Diff Pinion Bearing	- Front	86610+49	86610+49	86610+49	86610+49
	- Rear	88610+49	88610+49	88610+49	88610+49
Propshaft Support Bearing		360804	360804	360804	6205ZZ
Pulley Bearing					
Spigot Shaft Bearing		62022RS [2.0]			6202ZZ 62022RS [3.0]
V-Belt Tensioner					
Drive Shaft Oil Seal	- Left				
	- Right				
Gearbox Oil Seal	- Front	2838 [Man.] 9436 [Auto.]	2838 [Man.] 9436 [Auto.]	2838 [Man.] 9436 [Auto.]	274308
	- Rear	4500 [Man. 1.6, 2.0] 4250 [Man. 2.0 L, 2.5, 3.0] 9435 [Auto.]	4500 [Man. 1.6, 2.0] 4250 [Man. 2.5, 3.0] 9435 [Auto.]	4500 [Man. 1.6, 2.0] 4250 [Man. 2.5, 3.0] 9435 [Auto.]	4250 [86-90] [3.0] 9847 [91-97] [3.0] 354814
Pinion Oil Seal		2738	2738	2738	2738
Spark Plug Tube Seal					
Rear Main Bearing Oil Seal		2825	2825	2825	2825 [3.0] 9667
Timing Cover / Cam Oil Seal		5043 [T/cover 1.6] 425607 [T/cover 2.0 GT] 2708 [T/cover 2.0 L, XL, 2.5, 3.0]	5043 [T/cover 1.3, 1.6] 425607 [T/cover 2.0] 2708 [T/cover 3.0]	5043 [T/cover 1.3, 1.6] 425607 [T/cover 2.0] 2708 [T/cover 2.4, 3.0]	2708 [T/Cover] [3.0] 9666 [Cam+T/cover]
Rear Wheel Bearing	- Inner	1700289+RR35	1700289+RR35 U399+360 + 1852119 [3.0]	1700289+RR35 U399+360 + 1852119 [1.6 P/up, 2.4 P/up, 3.0 V6 Leisure P/up]	U399+360 + 1852119
	- Outer				
Rear Wheel Oil Seal	- Inner				
	- Outer	2641	2641 9415 [3.0]	2641 [1.3, 1.6GL, 2.0, 3.0GLS] 9415 [1.6, 2.4, 3.0P/up]	9415
Rear Wheel Kit		PQ145	PQ145 PQ176 [3.0 V6 Leisure P/up]	PQ145 PQ176 [1.6 P/up, 2.4 P/up, 3.0 V6 Leisure P/up]	PQ176
Rear Wheel Hub / Stub Axle					

APPLICATIONS	LOCATION	FORD COURIER 4X2 2.5 Turbo Diesel D/cab, Leisure P/up WL4	FORD COURIER 4X4 2.5TD D/cab, Leisure P/up WL4	FORD COURIER 4X2 3.4 V6 Leisure D/cab, P/up Essex	FORD COURIER 4X4 3.0 V6 Std., XLT, D/ cab, Leisure, Explorer, Exec. P/up Essex 3.4 V6 Leisure, P/up Essex.
		YEARS	96-00	96-00	97-01
Front Wheel Bearing	- Inner	48510/48	102910+49	48510/48	102910+49
	- Outer	30205	69310/49	30205	69310/49
Front Wheel Oil Seal	- Inner	9669	9946	9669	9946
	- Outer		9918		9918
Front Wheel Kit		PQ234	PQ401	PQ234	PQ401
Front Wheel Hub / Stub Axle		234HUB	401HUB	234HUB	401HUB
Alternator / Generator Bearing	- Front	63032RS	63032RS		63032RS [3.0 - only]
	- Rear	60002RS	60002RS		62012RS [3.0 - only]
Concentric / Thurst Bearing		RB9589	RB9589	RB9589	RB9589
Diff Carrier Bearing	- Left	501310+49	32008 [Front Diff] 102910+49 [Rear Diff]	501310+49	32008 [Fr. Diff 3.0, 3.4] 501310+49 [Rr. Imp 3.0] R45 - Z5 [Rr. Local 3.0] 102910+49 [Rr.Diff 3.4]
	- Right	501310+49	32008 [Front Diff] 102910+49 [Rear Diff]	501310+49	32008 [Fr. Diff 3.0, 3.4] 501310+49 [Rr. Imp 3.0] R45-Z5 [Rr. Local 3.0] 102910+49 [Rr.Diff 3.4]
Diff Pinion Bearing	- Front	86610+49	32206 [Front Diff] 86610+49 [Rear Diff]	86610+49	32207 [Fr. Diff 3.0] 32206 [Fr. Diff 3.4] 30306 [Rr. Import 3.0] 86610+49 [Rr. Loc 3.0]
	- Rear	802011+48	32307 [Front Diff] 802011+48 [Rear Diff]	88610+49	32206 [Fr. Diff 3.0] 30307 [Rr. Imp. 3.0] 32307 [Fr. Diff 3.4] 86610+49 [Rr. Loc. 3.0] 802011+48 [Rr. Loc. 3.4]
Propshaft Support Bearing					
Pulley Bearing					
Spigot Shaft Bearing					62022RS [3.0 - only]
V-Belt Tensioner					
Drive Shaft Oil Seal	- Left				
	- Right				
Gearbox Oil Seal	- Front	274308	274308		274308
	- Rear	9838 [Ext. Housing]	9858 9838 [Ext. Housing]		9858 9838 [Ext. Housing]
Pinion Oil Seal		2738 [Rubber] 9718 [Metal]	9832 [Front Diff] 2738 [Rubber - Rr. Diff] 9718 [Metal - Rear Diff]	2738 [Rubber] 9718 [Metal]	9832 [Fr. Diff 3.0, 3.4] 2738 [Rr. 3.0, 3.4] 9839 [Rr. Import 3.0] 9718 [Metal- Rr. Diff 3.4]
Spark Plug Tube Seal					
Rear Main Bearing Oil Seal		9996	9996	2825	2825
Timing Cover / Cam Oil Seal		9994 [Cam] 9995 [T/Cover]	9994 [Cam] 9995 [T/Cover]	2708 [T/cover]	2708 [T/Cover]
Rear Wheel Bearing	- Inner	U399+360 + 1852119	U399+360 + 1852119	U399+360 + 1852119	30208 [Import, only 3.0] U399+360 + 1852119 [Local 3.0, 3.4]
	- Outer				
Rear Wheel Oil Seal	- Inner				9835 [Import 3.0]
	- Outer	9415	9415	9415	9834 [Import 3.0] 9415 [Local 3.0, 3.4]
Rear Wheel Kit		PQ176	PQ176	PQ176	PQ402 [Import 3.0] PQ176 [Local 3.0, 3.4]
Rear Wheel Hub / Stub Axle					

APPLICATIONS	LOCATION	FORD ECOSPORT	FORD ESCORT	FORD ESCORT	FORD ESCORT
		1.0i Ecoboost Petrol, M1JC 1.5 TDCi Diesel, UGJE 1.5i Petrol, UEJB	RWD Mki 1.1 Kent 1.3 GT, L, Super, S/W Kent 1.6 GT, L, XL Kent	Mki/II 1.1 300 P/van Kent 1.3 30, 35, 45 P/van Kent 1.6 45 P/van Kent	RWD MkiI 1.3 L Kent 1.6 GL, Sport Kent RS2000 Koln
YEARS		2013-	68-75	68-81	75-81
Front Wheel Bearing	- Inner	309639ASB	44610/49	44610/49	44610/49
	- Outer		11710/49	11710/49	11710/49
Front Wheel Oil Seal	- Inner	Sealed Bearing	2082 [1.6]	405508 [1.3, 1.6]	405508
	- Outer				
Front Wheel Kit		PQ844 [ASB]	PQ123 [1.1, 1.3]	PQ123 [1.1] PQ120 [1.3, 1.6]	PQ120
Front Wheel Hub / Stub Axle		499AHUB			
Alternator / Generator Bearing	- Front		6202ZZ	62032RS	62032RS
	- Rear			62012RS	62012RS
Concentric / Thurst Bearing		Concentric Slave Cylinder	RB9511 RB9579	RB9511	RB9579 [1.6] RB9582C [2.0]
Diff Carrier Bearing	- Left		48510+49 [Import] 29710+49 [Local]	29710+49	48510+49 [Import] 29710+49 [Local]
	- Right		48510+49 [Import] 29710+49 [Local]	29710+49	48510+49 [Import] 29710+49 [Local]
Diff Pinion Bearing	- Front		88011+43 [Import] 86610+49 [Local]	86610+49	88011+43 [Import] 86610+49 [Local]
	- Rear		88011+43 [Import] 88610+49 [Local]	88610+49	88011+43 [Import] 88610+49 [Local]
Propshaft Support Bearing			360804	360804	360804
Pulley Bearing					
Spigot Shaft Bearing					
V-Belt Tensioner					
Drive Shaft Oil Seal	- Left				
	- Right				
Gearbox Oil Seal	- Front		2838	2838	2838
	- Rear		4500	4500	4500
Pinion Oil Seal			4455 [Import] 2738 [Local]	2738	4455 [Import] 2738 [Local]
Spark Plug Tube Seal					
Rear Main Bearing Oil Seal		9377 [1.5i] 9556 [1.5TDCi] 9579 [1.0]	2825	2825	2825
Timing Cover / Cam Oil Seal		9242 [T/cover 1.5TDCi] 9555 [T/cover 1.5i] 9578 [T/cover 1.0]	5043 [T/cover]	5043 [T/cover]	5043 [T/cover 1.3, 1.6] 425607 [T/cover 2.0] 2708 [T/cover 3.0]
Rear Wheel Bearing	- Inner	HUB246 [with integrated ABS sensor]	361971 [Import] 412971+RR30 [Local]	412971+RR30	361971 [Import] 412971+RR30 [Local]
	- Outer				
Rear Wheel Oil Seal	- Inner	HUB UNIT	Sealed Bearing	Sealed Bearing	Sealed Bearing
	- Outer				
Rear Wheel Kit		PQ843	PQ154 [Local]	PQ154	PQ154 [Local]
Rear Wheel Hub / Stub Axle					



APPLICATIONS	LOCATION	FORD ESCORT FWD MkIII 1.3 GL, L Kent 1.6 GLE, L, Sport, XR3, i HL16CVH	FORD ESCORT FWD MkVI 1.4i H/back, Sedan CVH-PTE 1.6i GL, GLE H/back, Sedan Zetec 1.8i GLi, TDi H/back, Sedan Zetec 1.8TDi Endura	FORD EVEREST 4X2, 4X4 3.0 TDci	FORD FALCON 4.0 GLi, Fairmont, Fairmont, Futura XR6 MPI
		YEARS	81-86	95-00	09-15
Front Wheel Bearing	- Inner	68111/573315	309639	47KWD02A	68110/49
	- Outer	68111/573315			12710/49
Front Wheel Oil Seal	- Inner	9450	Sealed Bearing	9946 9336 [Alt.]	9880
	- Outer	9449		9298	
Front Wheel Kit		PQ141	PQ106	PQ758	PQ436
Front Wheel Hub / Stub Axle		141HUB	106FHUB	758HUB [4x2] 758AHUB [4x4]	
Alternator / Generator Bearing	- Front	62032RS			B8-85DW
	- Rear	62012RS			63032RS
Concentric / Thurst Bearing		RB9511 [1.3] RB9579 [1.6]	RB9592 [1.4 95-97] Hyd. Thrust Brg. [All 97-00]		RB9604
Diff Carrier Bearing	- Left	29710+49	29710+49		102910+49
	- Right	29710+49	29710+49		102910+49
Diff Pinion Bearing	- Front				86610+49
	- Rear				894410+46
Propshaft Support Bearing					
Pulley Bearing					
Spigot Shaft Bearing					
V-Belt Tensioner					
Drive Shaft Oil Seal	- Left	9678	9554		
	- Right	9678	9554		
Gearbox Oil Seal	- Front	345007	224008		9934
	- Rear	9467			
Pinion Oil Seal			9839		9878
Spark Plug Tube Seal					
Rear Main Bearing Oil Seal		9452			9933
Timing Cover / Cam Oil Seal		425607 [Cam] 355007 [T/Cover]	425607 [Cam] 9550 [T/Cover]		
Rear Wheel Bearing	- Inner	331274	329013		U261/298
	- Outer	11710/49	329013		
Rear Wheel Oil Seal	- Inner	405508	9644		9404
	- Outer				
Rear Wheel Kit		PQ110	PQ418		PQ153
Rear Wheel Hub / Stub Axle			SA418		

APPLICATIONS	LOCATION	FORD FIESTA I	FORD FIESTA II	FORD FIESTA III	FORD FIGO
		1.3, i Flair, Flite, Play, Fun Endura-EM5 1.4, i Flair, Trend, Fun Zetec CVH/PTE 1.6, i Ambiente', Flair, Forte' Ghia, Rsi, Sport, Trend	1.4i Trend Zetec 1.6i RSi, TDCi Rocam 2.0 ST, ST150	1.0 Ecoboost 1.4 Sedan 1.4i Ambiente', Trend, Titanium 1.6 Limited 1.6i Ambiente', Sport, Trend, Titanium, TDCi 1.6 Gtdi	1.4 Ambiente', Trend, FXJA/B 1.4 TDCi Ambiente', F6JB/D
YEARS		97-04	04-09	2008-	2010-
Front Wheel Bearing	- Inner	309639	309639 309639ASB	309639ASB	309639ASB
	- Outer				
Front Wheel Oil Seal	- Inner	Sealed Bearing	Sealed Bearing	Sealed Bearing	Sealed Bearing
	- Outer				
Front Wheel Kit		PQ106	PQ106 [1.4] [Non ABS] PQ499 [ASB]	PQ499 [ASB] PQ844 [1.6 GTDi]	PQ499 [ASB]
Front Wheel Hub / Stub Axle		106FHUB	106FHUB	499AHUB [PCD: 108mm] 499BHUB [PCD: 100mm]	499AHUB
Alternator / Generator Bearing	- Front				
	- Rear				
Concentric / Thrust Bearing		Concentric Slave Cylinder	Concentric Slave Cylinder [Automated Manual Trans.]	Concentric Slave Cylinder	Concentric Slave Cylinder
Diff Carrier Bearing	- Left	29710+49			
	- Right	29710+49			
Diff Pinion Bearing	- Front	29711+49			
	- Rear	329149+0017			
Propshaft Support Bearing					
Pulley Bearing					
Spigot Shaft Bearing					
V-Belt Tensioner					
Drive Shaft Oil Seal	- Left	9554	9554	9554	9554
	- Right	9554	9554	9554	9554
Gearbox Oil Seal	- Front	9467			
	- Rear	405508			
Pinion Oil Seal		9839			
Spark Plug Tube Seal					
Rear Main Bearing Oil Seal		2825 [1.3] 9452 [1.4, 1.6]	9242 [1.6 TDCi] 9375 FS [ST150] 9890 [1.6, 2.0]	9242 [1.6TDCi] 9377FS [1.4, 1.6 Pet.] 9579 [1.0]	9890 [1.4 Pet] 9242 [1.4 Dies] 9377FS
Timing Cover / Cam Oil Seal		9634 [Cam 1.3] 425607 [Cam 1.4, 1.6] 9550 [T/Cover 1.4, 1.6]	9376 [Cam 1.6, 2.0] 274707 [Cam 1.6 TDCi] 9334 [T/Cover 1.6 TDCi] 9378 [T/Cover ST150] 9550 [T/Cover 1.6, 2.0]	274707 [Cam 1.6TDCi] 334705 [T/Cover 1.4, 1.6 Pet.] 9334 [T/Cover 1.6TDCi] 9376 [Cam 1.4] 9555 [Cam 1.6 Pet.] 9578 [T/Cover 1.0]	9376 [Cam 1.4 Pet] 274707 [Cam 1.4 Dies] 9550 [T/Cover 1.4 Pet] 9334 [T/Cover 1.4 Dies]
Rear Wheel Bearing	- Inner	329013	FFSB2001	309639ASB HUB141 [with integrated ABS sensor] HUB203 [with integrated ABS sensor]	FFSB2001
	- Outer	329013			
Rear Wheel Oil Seal	- Inner	9644	Sealed Bearing	HUB UNIT	Sealed Bearing
	- Outer				
Rear Wheel Kit		PQ418	PQ500 [Non ASB] PQ500ASB PQ500ASBCOMP [Complete Bearing + Hub Unit]	PQ844 [1.6 GTDi] PQ799 [PCD: 108mm] PQ901 [PCD: 100mm]	PQ500ASB PQ500ASBCOMP [Complete Bearing + Hub Unit]
Rear Wheel Hub / Stub Axle		SA418	SA500 [ABS] SA500A [Non ABS]		

APPLICATIONS	LOCATION	FORD FOCUS I	FORD FOCUS II	FORD FOCUS III	FORD HUSKY
		1.6i 4/5 Door, Ambiente' Zetec S 1.8 TDCi F9DA, F9DB 2.0i 4/5 Door,L Trend, RS, ST170 Zetec E	1.6 Si, Ambiente, Trend. 2.0 Si, Trend., TDCi Ghia, TDCi Si., 2.5 ST. HYDA	1.6i PNDA 1.8 Si, Ambiente, Trend. 2.0 Gdi MGDA 2.0 TDci G6DA, BYD 2.0 Gtdi ST1 & ST2 R9DA	1.8 1 Ton P/up 4G62 2.0 1 Ton P/up, Bus, P/van 4G63
YEARS		00-05	05-09	09-15	85-99
Front Wheel Bearing	- Inner	309639ASB	HUB118 [with integrated ABS sensor]	DACFWBFFS	48510/48
	- Outer				12610/49
Front Wheel Oil Seal	- Inner	Sealed Bearing	HUB UNIT	Sealed Bearing	506509
	- Outer				
Front Wheel Kit		PQ499 [ASB]	PQ723 [5 Studs]	PQ815	PQ190
Front Wheel Hub / Stub Axle		499AHUB		815HUB	
Alternator / Generator Bearing	- Front				62032RS
	- Rear				62012RS
Concentric / Thurst Bearing		Concentric Slave Cylinder		Concentric Slave Cylinder	RB9817 [1.8] RB9861 [2.0]
Diff Carrier Bearing	- Left	572791			501310+49
	- Right	572791			501310+49
Diff Pinion Bearing	- Front	300811+49			86610+49
	- Rear	300811+49			88610+49
Propshaft Support Bearing					
Pulley Bearing					
Spigot Shaft Bearing					6002 2RS
V-Belt Tensioner					
Drive Shaft Oil Seal	- Left	9554	9293 [2.5 ST] 9554		
	- Right	9554	9104 [2.5 ST] 9554		
Gearbox Oil Seal	- Front	9998			304506
	- Rear	274206			365210
Pinion Oil Seal		9998			2738 [Local] 9637 [Import]
Spark Plug Tube Seal					
Rear Main Bearing Oil Seal		9377 [1.6] 9452 [2.0]	9377 [1.6] 9375FS [2.0] 9979 [2.0 TDCi] 9975 [2.5 ST]	9979 [2.0 TDCi] 9375FS [2.0, ST] 9377 [1.6]	9620
Timing Cover / Cam Oil Seal		9538 [Cam 1.6] 425308 [Cam 2.0] 334705 [T/Cover 1.6] 355010 [T/Cover 2.0] 355007 [T/Cover 2.0 Alt.]	9376 [Cam 1.6] 9055 [Cam 2.0 TDCi] 456510 [Cam 2.5 ST] 334705 [T/Cover 1.6] 9378 [T/Cover 2.0] 9056 [T/Cover 2.0 TDCi] 354706 [T/Cover 2.5 ST]	9054 [T/Cover 2.0GDi] 9056 [T/Cover 2.0 TDCi] 9378 [T/Cover 2.0 ST] 334705 [T/Cover 1.6] 9055 [Cam 2.0 TDCi] 9555 [Cam 1.6]	9627 [Cam] 446007 [T/covers]
Rear Wheel Bearing	- Inner	FFSB2001ASB	HUB120 [with integrated ABS sensor] HUB281 [with integrated ABS sensor] HUB282 [with integrated ABS sensor]	HUB257 [with integrated ABS sensor] HUB281 [with integrated ABS sensor]	29710+49 [Import] U399+360 + 1852119 [Local]
	- Outer				29710+49 [Import]
Rear Wheel Oil Seal	- Inner	Sealed Bearing	HUB UNIT	HUB UNIT	
	- Outer				9628 [Import] 9415 [Local]
Rear Wheel Kit		PQ500ASB PQ500ASBCOMP [Complete Bearing + Hub Unit]	PQ725 [W: 100mm] PQ817 [with park assist sensors] PQ854 [W: 109mm] [2.0TDCi 5 Studs]	PQ816 [without park assist sensors] PQ817 [with park assist sensors]	PQ282 [Import] PQ176 [Local]
Rear Wheel Hub / Stub Axle		SA500 [1.6] SA500BL/R	SA500BL/R		

APPLICATIONS	LOCATION	FORD IKON	FORD IKON	FORD KA	FORD KUGA
		1.3, Low, LX CLTA 1.6i, Low, High, LX, CLX CLTA	1.4, Low, LX 1.4 TDCi 1.6i	1.3i Ambiente, Trend, Collection Rocam A9A, A9B	4X2, 4X4 1.5 Ecoboost 1.6 Ecoboost JQMA, JQMB 1.6 Ecoboost Turbo JTMA 2.0 Ecoboost 2.0 TDCi 2.0 TDCi TXDA, TXMA 2.5 Turbo
YEARS		01-06	07-11	05-09	2011-
Front Wheel Bearing	- Inner	309639 309639ASB	309639 309639ASB	309639 309639ASB	DACFWBFFS
	- Outer				
Front Wheel Oil Seal	- Inner	Sealed Bearing	Sealed Bearing	Sealed Bearing	Sealed Bearing
	- Outer				
Front Wheel Kit		PQ106 [Non ABS] PQ499 [ABS/ASB]	PQ106 [Non ABS] PQ499 [ABS/ASB]	PQ106 [Non ABS] PQ499 [ABS/ASB]	PQ815
Front Wheel Hub / Stub Axle		106FHUB 499AHUB	106FHUB 499AHUB	106FHUB 499AHUB	815HUB
Alternator / Generator Bearing	- Front				
	- Rear				
Concentric / Thurst Bearing			Concentric Slave Cylinder	Concentric Slave Cylinder	
Diff Carrier Bearing	- Left	29710+49			
	- Right	29710+49			
Diff Pinion Bearing	- Front	29711+49			
	- Rear	329149+0017			
Propshaft Support Bearing					
Pulley Bearing					
Spigot Shaft Bearing					
V-Belt Tensioner					
Drive Shaft Oil Seal	- Left	9554	9554		
	- Right	9554	9554		
Gearbox Oil Seal	- Front	9467			
	- Rear	405508			
Pinion Oil Seal		9839			
Spark Plug Tube Seal					
Rear Main Bearing Oil Seal		2825	9242 [1.4 TDCi] 9890 [1.4, 1.6]	9537 9537V [Viton]	9377FS [1.5, 1.6] 9770 [2.0 TDCi][4X2]
Timing Cover / Cam Oil Seal		9634 [Cam]	274707 [Cam 1.4 TDCi] 9376 [Cam 1.4, 1.6] 9334 [T/Cover 1.4 TDCi] 9550 [T/Cover 1.4, 1.6] 9565 [T/Cover]	9634 [T/Cover] 9565 [T/Cover]	334705 [T/Cover] 9378 [Cam] [2.0][4X4]
Rear Wheel Bearing	- Inner	329013	FFSB2001	329013	HUB355 [4X2] HUB354 [2.5][4X4] HUB356 [1.6, 2.0] [4X4]
	- Outer	329013		329013	
Rear Wheel Oil Seal	- Inner	9644		9644	HUB UNIT
	- Outer				
Rear Wheel Kit		PQ418	PQ500ASB PQ500ASBCOMP [Complete Bearing + Hub Unit]	PQ418	PQ1052 [4X2] PQ1051 [2.5] [4X4] PQ1053 [1.6, 2.0] [4X4] [27 Splines]
Rear Wheel Hub / Stub Axle		SA418		SA418	

APPLICATIONS	LOCATION	FORD LASER	FORD LASER	FORD LASER	FORD METEOR
		[86-95] 1.3 L, GL, 13, Dash E3 / B3 TRACER [95-02] 1.3 Sedan, H/back –Tonic, Plus B3	1.4 L CHV-FUA 1.5 GL, GLS, Sport E5/B5	[86-95] 1.6, i GL, 16, Sport, TX3 B6/ F6 2.0, i RS FE Tracer [95-02] 1.6 Sedan, H/back – Plus, Sport, Tonic B6/F6	1.3 GL, L, 13 E3/B3 1.4 LX CVH 1.5 GL, GLS E5
YEARS		86-02	86-92	86-02	86-95
Front Wheel Bearing	- Inner	69310/45	69310/45	69310/45	69310/45
	- Outer	69310/45	69310/45	69310/45	69310/45
Front Wheel Oil Seal	- Inner	9444	9444	9444	9444
	- Outer	9445	9445	9445	9445
Front Wheel Kit		PQ184	PQ184	PQ184	PQ184
Front Wheel Hub / Stub Axle		184HUB SA184L/R	184HUB SA184L/R	184HUB SA184L/R	184HUB SA184L/R
Alternator / Generator Bearing	- Front	63022RS [86-90] 63032RS [91-02]	62032RS [1.4] 63022RS [1.5]	6203ZZ [2.0] 6303 ZZ [Sport] 63032RS [Others]	62032RS [1.4] 63022RS [1.3, 1.5] 63032RS [91-95]
	- Rear	B8-85D [86-90] 62012RS [91-02]	62032RS [1.4] B8-85D [1.5]	6201ZZ 62012RS [Others]	B8-85D [1.3, 1.5] 62012RS [91-95] or see Page I 62032RS [1.4]
Concentric / Thurst Bearing		RB9588A	RB9588A [1.4] RB9588 [1.5]	RB9588A RB9820 [2.0]	RB9588A
Diff Carrier Bearing	- Left	68111+49	68111+49	32008 [Tonic, 2.0] 68111+49 [Others]	68111+49
	- Right	68111+49	68111+49	32008 [Tonic, 2.0] 68111+49 [Others]	68111+49
Diff Pinion Bearing	- Front				
	- Rear				
Propshaft Support Bearing					
Pulley Bearing					
Spigot Shaft Bearing		6202ZZ		62022RS 6202ZZ	6202ZZ
V-Belt Tensioner					
Drive Shaft Oil Seal	- Left	9654	9654	9654	9654
	- Right	9654	9654	9654	9654
Gearbox Oil Seal	- Front	244008	244008	244008	244008
	- Rear	244008	244008		244008
Pinion Oil Seal					
Spark Plug Tube Seal					
Rear Main Bearing Oil Seal		708812 [E3] 9742 [B3]	9452 [1.4] 708812 [1.5 E5] 9742 [1.5 B5]	9667 [GL, Tonic, 2.0] 9742 [Sport, TX3]	708812 [1.3, 1.5] 9452 [1.4] 9742 [1.3]
Timing Cover / Cam Oil Seal		9682 [Cam] 405508 [T/cover 86 -90] 9682 [T/cover 91-02]	425607 [Cam 1.4] 9682 [Cam 1.5 B5] 355007 [T/cover 1.4] 405508 [T/cover 1.5 E5] 9682 [T/cover 1.5 B5]	425607 [Cam 86-91] 9666 [T/cover, Cam 92-02] 9682 [T/cover, Cam 92-02]	9682 [Cam] 405508 [T/cover 86-90] 9682 [T/cover 91-95]
Rear Wheel Bearing	- Inner	331274	331274	331274	331274
	- Outer	11910+49	11910+49	11910+49	11910+49
Rear Wheel Oil Seal	- Inner	9447	9447	9447	9447
	- Outer				
Rear Wheel Kit		PQ231L/R	PQ231L/R	PQ231L/R	PQ231L/R
Rear Wheel Hub / Stub Axle		SA231L/R	SA231L/R	SA231L/R	SA231L/R

APPLICATIONS	LOCATION	FORD METEOR	FORD MONDEO	FORD MONDEO	FORD RANCHERO
		1.6, i GL, GLE, GLi, 16, Sport B6/CVH/F6 2.0 8/16V GLE, GLi FE	1.8i LX, Tdi LX Zetec M5 Endura TD 2.0i Aspen, CLX, CLX, Ghia, Trend Zetec M5 2.5i Si Duratec M5	2.0 CJBA, CJBB 2.5 V6 24V LCBD 3.0 ST220 MEBA	4.0 GLi, Outback, XR6 P/up 250
YEARS		86-95	97-01	02-07	97-99
Front Wheel Bearing	- Inner	69310/45	102429	DAC40MOND	68110/49
	- Outer	69310/45			12710/49
Front Wheel Oil Seal	- Inner	9444	Sealed Bearing	Sealed Bearing	9880
	- Outer	9445			
Front Wheel Kit		PQ184	PQ460	PQ855 [ASB]	PQ436
Front Wheel Hub / Stub Axle		184HUB SA184L/R	460HUB	855HUB	
Alternator / Generator Bearing	- Front	6203ZZ [2.0] 6303 ZZ [Sport] 63032RS [Others]			B8-85DW
	- Rear	6201ZZ [Sport] 62012RS [Others] or see Page I			63032RS
Concentric / Thurst Bearing		RB9588A [1.6] RB9820	Concentric Slave Cylinder	Concentric Slave Cylinder	RB9584
Diff Carrier Bearing	- Left	32008 [2.0] 68111+49			102910+49
	- Right	32008 [2.0] 68111+49			102910+49
Diff Pinion Bearing	- Front				86610+49
	- Rear				894410+46
Propshaft Support Bearing					
Pulley Bearing					
Spigot Shaft Bearing		6202ZZ			
V-Belt Tensioner					
Drive Shaft Oil Seal	- Left	9654			
	- Right	9654			
Gearbox Oil Seal	- Front	244008	345007		9934
	- Rear		274206		
Pinion Oil Seal					9878
Spark Plug Tube Seal					
Rear Main Bearing Oil Seal		9742 [GLi] 9667 [Others]	9890	9375FS [2.0] 9058 [2.5, 3.0]	9933
Timing Cover / Cam Oil Seal		9666 [T/cover, Cam] 9682 [T/cover, Cam]	425307 [Cam] 9550 [T/Cover]	9378 [T/Cover 2.0] 9059 [T/Cover 2.5, 3.0]	
Rear Wheel Bearing	- Inner	331274	HUB015 [Non ABS] HUB016 [Gear type ABS]	HUB283 [with integrated ABS sensor]	U261/298
	- Outer	11910+49			9404
Rear Wheel Oil Seal	- Inner	9447	HUB UNIT	HUB UNIT	
	- Outer				
Rear Wheel Kit		PQ231L/R	PQ461 [4 Studs] PQ462 [4 Studs]	PQ856	PQ153
Rear Wheel Hub / Stub Axle		SA231L/R			

APPLICATIONS	LOCATION	FORD RANGER	FORD RANGER	FORD RANGER	FORD RANGER
		1.8 XL, P/up 2.2 XL, P/up	1.8 XL, P/up 2.2 XL, P/up	4X2 2.5 Diesel, Turbo Diesel D/Cab, High Trail, XL, DT XLT High Trail D/Cab, Super Cab	4X2 2.5 Diesel, Turbo Diesel D/Cab, High Trail, XL, DT XLT High Trail D/Cab, Super Cab
YEARS		00-05	04-10	00-09	07-12
Front Wheel Bearing	- Inner	48510/48	102910+49	48510/48 [00-04] 47KWD02A [04-09]	47KWD02A
	- Outer	30205	69310/49	30205 [00-04]	
Front Wheel Oil Seal	- Inner	9669	9946	9669 [00-04] 9946 [04-09] 9336 [04-09 Alt.]	9946 9336 [Alt.]
	- Outer		9918	9298 [04-09]	9298
Front Wheel Kit		PQ234	PQ401	PQ234 [00-04] PQ758 [04-09]	PQ758
Front Wheel Hub / Stub Axle		234HUB	401HUB	234HUB 758HUB	758HUB 758AHUB [28 Splines]
Alternator / Generator Bearing	- Front	62012RS	62012RS	63032RS	
	- Rear	63022RS	63022RS	60002RS	
Concentric / Thurst Bearing		RB9589	RB9589	RB9856	RB9678
Diff Carrier Bearing	- Left	501310+49	501310+49	501310+49	
	- Right	501310+49	501310+49	501310+49	
Diff Pinion Bearing	- Front	86610+49	86610+49	86610+49	
	- Rear	802011+48	802011+48	802011+48	
Propshaft Support Bearing					
Pulley Bearing					
Spigot Shaft Bearing					
V-Belt Tensioner					
Drive Shaft Oil Seal	- Left				
	- Right				
Gearbox Oil Seal	- Front	274308	274308	274308	274307
	- Rear	9654	9654	9838	9838
Pinion Oil Seal		2738 [Rubber] 9718 [Metal]	2738 [Rubber] 9718 [Metal]	2738 [Rubber] 9718 [Metal]	
Spark Plug Tube Seal					
Rear Main Bearing Oil Seal		9667	9667	9996	9511
Timing Cover / Cam Oil Seal		9666 [T/Cover]	9666 [T/Cover]	9994 [Cam] 9995 [T/Cover]	9391[Cam]
Rear Wheel Bearing	- Inner	U399+360 + 1852119	U399+360 + 1852119	U399+360 + 1852119 [00-05] DAC4TCR1 [05-09]	DAC4TCR1
	- Outer				
Rear Wheel Oil Seal	- Inner			Sealed Bearing	Sealed Bearing
	- Outer	9415	9415	9415 [00-05] 9339 [05-09] 9340 [05-09] 9295 [05-09 Alt.]	9339 9340 9295 [Alt.]
Rear Wheel Kit		PQ176	PQ176	PQ176 [00-05] PQ755L/R [05-09]	PQ755L/R
Rear Wheel Hub / Stub Axle					



APPLICATIONS	LOCATION	FORD RANGER 4X2 3.0TDCi Super Cab XLT Hi-Trail. 4.0 SubCab XLT Hi Trail, Super Cab XLT Hi-Trail.	FORD RANGER 4X4 2.5 D/Cab,High Trail, XL, DT XLT High Super Cab 2.5TD Montana D/Cab WL4 3.0TDCi 4.0 Super Cab XLT	FORD RANGER T6 4X2 2.2 D HP, MP 2.5 3.2 D Wildtrack 3.2 TDCi	FORD RANGER T6 4X4 2.2 D HP, MP 3.2 D Wildtrack 3.2 TDCi
YEARS		05-12	00-12	2012-	2012-
Front Wheel Bearing	- Inner	47KWD02A	102910+49 [00-04] 47KWD02A [04-09]	47KWD03ASB DRT45T6 [Alt. 2.2] DRT45T6-50 [Alt. 2.2, 3.2]	47KWD03ASB DRT45T6
	- Outer		69310/49 [00-04]		
Front Wheel Oil Seal	- Inner	9946 9336 [Alt.]	9946 [00-04] 9336 [04-09 Alt.]	9669	9669
	- Outer	9298	9918 [00-04] 9298 [04-09]		
Front Wheel Kit		PQ758	PQ401 [00-04] PQ758 [04-09]	PQ915 [2.2] [ID:47mm] [ASB] PQ949 [ID:45mm] [W:55mm] PQ1091 [W:50mm] [ASB]	PQ915 [3.2] [ID:47mm] [ASB] PQ949 [Alt. 2.2] [ID:45mm] [W:55mm]
Front Wheel Hub / Stub Axle		758HUB 758AHUB [28 Splines]	401HUB 758AHUB [28 Spline] 758BHUB [26 Splines]	758HUB [PQ915] 1091HUB	758AHUB [PQ915]
Alternator / Generator Bearing	- Front		63032RS		
	- Rear		60002RS		
Concentric / Thurst Bearing		Concentric Slave Cylinder	RB9856 [00-07] RB9588A [00-07] RB9701 [00-07 Alt.] RB9678 [07-]	Concentric Slave Cylinder RB9898 [5 Speed]	Concentric Slave Cylinder RB9898 [5 Speed]
Diff Carrier Bearing	- Left		32008 [Front Diff] 102910+49 [Rear Diff]		
	- Right		32008 [Front Diff] 102910+49 [Rear Diff]		
Diff Pinion Bearing	- Front		32206 [Front Diff] 86610+49 [Rear Diff]		
	- Rear		32307 [Front Diff] 802011+48 [Rear Diff]		
Propshaft Support Bearing					
Pulley Bearing					
Drive Shaft Oil Seal	- Left				9516
	- Right				9516
Gearbox Oil Seal	- Front		274308		
	- Rear		9858 9838 [Ext. Housing]		
Pinion Oil Seal			9832 [Front Diff] 2738 [Rubber - Rr. Diff] 9718 [Metal - Rear Diff]		
Rear Main Bearing Oil Seal			9996	9061FS [2.2D, 3.2]	9061FS [2.2D, 3.2]
Timing Cover / Cam Oil Seal			9994 [Cam] 9995 [T/Cover]	9561 [T/cover 2.2, 3.2]	9561 [T/cover 2.2, 3.2]
Rear Wheel Bearing	- Inner	DAC4TCR1	U399+360 + 1852119 [00-05] DAC4TCR1 [05-09]	DRT45T6	DRT45T6
	- Outer				
Rear Wheel Oil Seal	- Inner	Sealed Bearing	Sealed Bearing	9560	9560
	- Outer	9339 9340 9295 [Alt.]	9415 [00-05] 9339 [05-09] 9340 [05-09] 9295 [05-09 Alt.]		
Rear Wheel Kit		PQ755L/R	PQ176 [00-05] PQ755L/R [05-09]	PQ1049	PQ1049
Rear Wheel Hub / Stub Axle				1049HUB	1049HUB

APPLICATIONS	LOCATION	FORD SAPPHIRE	FORD SIERRA	FORD SPECTRON	FORD TELSTAR
		1.6 L Kent 2.0, i GL, GLE, GLEA, GLi, GLi Exec. Koln 3.0 Ghia, GLX Essex	1.6 GL, GL S/W, L Kent 2.0 GL, GL S/W Koln 2.0 LX Koln 2.3 GLE, Cologne 3.0, i GLS, GLX, LX, RS, XR6 Essex	2.2 Bus, P/van F2	2.0 GL, GLE, GLi, Mystique FS/KF 2.5 V6 Ghia, GLi KL TX5 2.5 V6 RSi KL
YEARS		89-93	83-93	91-04	94-99
Front Wheel Bearing	- Inner	68111/573315	68111/573315	48510/48	DAC428045
	- Outer	68111/573315	68111/573315	30205	
Front Wheel Oil Seal	- Inner	9449	9449	9669	Sealed Bearing
	- Outer				9948 [Dust Seal]
Front Wheel Kit		PQ142 [LHS] PQ168 [RHS]	PQ142 [LHS] PQ168 [RHS]	PQ234	PQ427
Front Wheel Hub / Stub Axle				234HUB	427HUB
Alternator / Generator Bearing	- Front	62032RS [1.6] 6203ZZ [2.0] 63022RS [3.0]	62032RS [1.6, 2.3, 3.0] 6203ZZ [2.0 GL] 63022RS [2.0 LX]	62012RS	B8-85DW
	- Rear	62012RS [1.6] 6201ZZ [2.0] 62022RS [3.0] or see Page I	62012RS [1.6, 2.3] 6201ZZ [2.0] 62022RS [2.0 LX] 62032RS [3.0]	63032RS	B17-102
Concentric / Thurst Bearing		RB9582C	RB9582C	RB9856	RB9589
Diff Carrier Bearing	- Left	501310+49	29711+49 [Import] 501310+49 [Local]	501310+49 [Rear import] R45-Z5 [Rear local]	32008
	- Right	501310+49	29711+49 [Import] 501310+49 [Local]	501310+49 [Rear import] R45-Z5 [Rear local]	32008
Diff Pinion Bearing	- Front	86610+49	331139D [Import] 86610+49 [Local]	30306 [Rear import] 86610+49 [Rear local]	
	- Rear	88610+49	331139D [Import] 88610+49 [Local]	30307 [Rear import] 86610+49 [Rear local]	
Propshaft Support Bearing					
Pulley Bearing					
Spigot Shaft Bearing		62022RS	62022RS [2.0 LX]	6202ZZ	
V-Belt Tensioner					
Drive Shaft Oil Seal	- Left	9675 [Diff Seal]	9675 [Diff Seal]		9654 [Diff Seal]
	- Right	9675 [Diff Seal]	9675 [Diff Seal]		9654 [Diff Seal]
Gearbox Oil Seal	- Front	2838 [Man.] 9836 [Auto.]	2838 [Man.] 9836 [Auto.]	274308	345007
	- Rear	9847 [Man.] 9489 [Auto.]	4250 [Man. 2.3] 9847 [Man. 1.6, 2.0, 3.0] 9489 [Auto.]	9838	274206
Pinion Oil Seal		9680	9488 [Import] 9680 [Local]	9839 [Rear import] 2738 [Rear local]	
Spark Plug Tube Seal					
Rear Main Bearing Oil Seal		2825	2825 [1.6, 2.0, 3.0] 9490 [2.3]	9667	9667 [2.0] 9935 [2.5]
Timing Cover / Cam Oil Seal		9627 [Cam 2.0] 9634 [T/covers 1.6] 425607 [T/Cover 2.0] 2708 [T/Cover 3.0]	2708 [T/covers 3.0] 9627 [Cam 2.0 LX] 9634 [T/covers 1.6] 425607 [T/Cover 2.0 GL, LX, 2.3]	9666 [Cam + T/covers]	9666 [T/Covers] 9572 [2.0 FS]
Rear Wheel Bearing	- Inner	328053	328053 [2.0 LX, 3.0] 68111/573315	30208 [Import] U399+360 + 1852119 [Local]	HUB066-39 [Non ABS] HUB066-40 [Gear type ABS]
	- Outer	328053	328053 [2.0 LX, 3.0] 68111/573315		
Rear Wheel Oil Seal	- Inner	9768	9449 9768 [2.0 LX, 3.0]	9835 [Import]	HUB UNIT
	- Outer	9768	9449 9768 [2.0 LX, 3.0]	9834 [Import] 9415 [Local]	
Rear Wheel Kit		PQ400L/R	PQ173 [LHS] PQ174 [RHS] PQ400L/R [2.0 LX, 3.0]	PQ402 [Import] PQ176 [Local]	PQ425 [5 Studs] PQ426 [5 Studs]
Rear Wheel Hub / Stub Axle					

APPLICATIONS	LOCATION	FORD TERRITORY 4X4 4.0 GLi Exec. Koln 4.0ST Turbo	FORD TOURNEO / TRANSIT CONNECT / GRAND CONNECT 1.0 EcoBoost Trend MPV SWB B3GA 1.5 TDCi Ambiente Dsl P-Van LWB XWGA 1.6 TDCi EcoBoost LWB T1GA	FORD TOURNEO / TRANSIT CUSTOM 2.2 Tdci Hi LWB & SWB 2.2 Tdci LOW LWB & SWB 2.2 Tdci Sport SWB	
		YEARS	05-10	2013-	12-18
Front Wheel Bearing	- Inner		DACFWBFF3	HUB415	
	- Outer				
Front Wheel Oil Seal	- Inner		Sealed Bearing	HUB UNIT	
	- Outer				
Front Wheel Kit		PQ1068	PQ815	PQ1151	
Front Wheel Hub / Stub Axle			815HUB		
Alternator / Generator Bearing	- Front				
	- Rear				
Concentric / Thurst Bearing			Concentric Slave Cylinder	Concentric Slave Cylinder	
Diff Carrier Bearing	- Left				
	- Right				
Diff Pinion Bearing	- Front				
	- Rear				
Propshaft Support Bearing					
Pulley Bearing					
Spigot Shaft Bearing					
V-Belt Tensioner					
Drive Shaft Oil Seal	- Left		9554		
	- Right		9554		
Gearbox Oil Seal	- Front				
	- Rear				
Pinion Oil Seal					
Spark Plug Tube Seal					
Rear Main Bearing Oil Seal			9242 [1.5, 1.6] 9579 [1.0]	9061FS	
Timing Cover / Cam Oil Seal			9241 [1.0] 9334 [1.5, 1.6]	9561 [T/Cover]	
Rear Wheel Bearing	- Inner		HUB355	HUB416	
	- Outer				
Rear Wheel Oil Seal	- Inner		HUB UNIT	HUB UNIT	
	- Outer				
Rear Wheel Kit		PQ1069	PQ1052	PQ1152	
Rear Wheel Hub / Stub Axle					

APPLICATIONS	LOCATION	GEELY MK 1.5 MR479QA 1.6 MR481QA
		YEARS
		2010-
Front Wheel Bearing	- Inner	DAC387139
	- Outer	
Front Wheel Oil Seal	- Inner	
	- Outer	
Front Wheel Kit		PQ926
Front Wheel Hub / Stub Axle		
Alternator / Generator Bearing	- Front	
	- Rear	
Concentric / Thurst Bearing		RB9891
Diff Carrier Bearing	- Left	
	- Right	
Diff Pinion Bearing	- Front	
	- Rear	
Propshaft Support Bearing		
Pulley Bearing		
Spigot Shaft Bearing		
V-Belt Tensioner		
Drive Shaft Oil Seal	- Left	
	- Right	
Gearbox Oil Seal	- Front	
	- Rear	
Pinion Oil Seal		
Spark Plug Tube Seal		
Rear Main Bearing Oil Seal		9642
Timing Cover / Cam Oil Seal		
Rear Wheel Bearing	- Inner	
	- Outer	
Rear Wheel Oil Seal	- Inner	
	- Outer	
Rear Wheel Kit		
Rear Wheel Hub / Stub Axle		

APPLICATIONS	LOCATION	GWM CB150 1.5 VVT	GWM DOUBLE CAB LUX 2.2 TDi, MPI, Standard
		YEARS	YEARS
		10-13	2007-
Front Wheel Bearing	- Inner	DAC387139	32007
	- Outer		30205
Front Wheel Oil Seal	- Inner		507009
	- Outer		
Front Wheel Kit		PQ926	PQ759
Front Wheel Hub / Stub Axle			
Alternator / Generator Bearing			
Concentric / Thurst Bearing			
Diff Carrier Bearing	- Left		
	- Right		
Diff Pinion Bearing	- Front		
	- Rear		
Propshaft Support Bearing			
Pulley Bearing			
Spigot Shaft Bearing			
V-Belt Tensioner			
Drive Shaft Oil Seal	- Left		
	- Right		
Gearbox Oil Seal	- Front		
	- Rear		
Pinion Oil Seal			
Spark Plug Tube Seal			
Rear Main Bearing Oil Seal		9096	
Timing Cover / Cam Oil Seal			
Rear Wheel Bearing	- Inner		63082RS
	- Outer		
Rear Wheel Oil Seal	- Inner		
	- Outer		
Rear Wheel Kit			
Rear Wheel Hub / Stub Axle			

APPLICATIONS	LOCATION	GWM FLORID	GWM STEED 3		
		1.5i 1.5 Cross	2.2i S/Cab, D/Cab		
YEARS		09-13	10-13		
Front Wheel Bearing	- Inner	DAC387139	48510/48		
	- Outer		30205		
Front Wheel Oil Seal	- Inner		506711		
	- Outer				
Front Wheel Kit		PQ926	PQ1145		
Front Wheel Hub / Stub Axle					
Alternator / Generator Bearing	- Front				
	- Rear				
Concentric / Thurst Bearing					
Diff Carrier Bearing	- Left				
	- Right				
Diff Pinion Bearing	- Front				
	- Rear				
Propshaft Support Bearing					
Pulley Bearing					
Spigot Shaft Bearing					
V-Belt Tensioner					
Drive Shaft Oil Seal	- Left				
	- Right				
Gearbox Oil Seal	- Front				
	- Rear				
Pinion Oil Seal					
Spark Plug Tube Seal					
Rear Main Bearing Oil Seal		9096	9648		
Timing Cover / Cam Oil Seal			9627		
Rear Wheel Bearing	- Inner				
	- Outer				
Rear Wheel Oil Seal	- Inner				
	- Outer				
Rear Wheel Kit					
Rear Wheel Hub / Stub Axle					

APPLICATIONS	LOCATION	HONDA ACCORD VII 2.0i V-Tec 2.4i V-Tec	HONDA ACCORD VIII 2.0i V-Tec R20A3 2.2 i-D-Tec N22B1/2 2.4i V-Tec K24Z3	HONDA BALLADE SA4 1300 EN4	HONDA BALLADE SC9 "Flip up Lights" 130 EV2 150, i EW 160i DOHC ZC1
YEARS		03-08	08-15	82-85	84-89
Front Wheel Bearing	- Inner	<b>DACFWBHA</b> [with integrated ABS sensor]	<b>DAC52FWBHA</b> [with integrated ABS sensor]	<b>DAC357234</b>	<b>DAC0871</b>
	- Outer				
Front Wheel Oil Seal	- Inner	Sealed Bearing	Sealed Bearing	<b>9472</b>	Sealed Bearing
	- Outer				
Front Wheel Kit		<b>PQ674</b>	<b>PQ809</b>	<b>PQ188</b>	<b>PQ338</b>
Front Wheel Hub / Stub Axle		<b>674HUB</b>	<b>809HUB</b>		<b>338HUB</b>
Alternator / Generator Bearing	- Front			<b>6202ZZ</b>	<b>63032RS</b>
	- Rear			<b>6201ZZ</b>	
Concentric / Thurst Bearing		<b>RB9697</b>	<b>RB9697</b>	<b>RB9881</b>	<b>RB9882</b>
Diff Carrier Bearing	- Left			<b>6207</b>	<b>6207</b> [Man.] <b>6208</b> [Auto.]
	- Right			<b>6207</b>	<b>6207</b> [Man.] <b>6208</b> [Auto.]
Diff Pinion Bearing	- Front				
	- Rear				
Propshaft Support Bearing					
Pulley Bearing					
Spigot Shaft Bearing				<b>60022RS</b>	
V-Belt Tensioner					
Drive Shaft Oil Seal	- Left	<b>9380</b>		<b>9622</b>	<b>9622</b> [Man.] <b>9469</b> [Auto. 150] <b>357609</b> [Auto. 150i] <b>385408</b> [160]
	- Right	<b>9380</b>		<b>9622</b>	<b>9622</b> [Man.] <b>356808</b> [Auto. 150] <b>357609</b> [Auto. 150i] <b>407608</b> [160]
Gearbox Oil Seal	- Front			<b>223507</b> [Man.] <b>9854</b> [Auto.]	<b>223507</b> [Man. 130, 150] <b>9854</b> [Auto.] <b>274207</b> [160]
	- Rear				
Pinion Oil Seal					
Spark Plug Tube Seal					
Rear Main Bearing Oil Seal		<b>9464</b> [2.0] <b>9381</b> [2.2i-CTDi]	<b>8010010</b> <b>9381</b> [2.2 i-dtec] <b>9464</b> [2.4]	<b>9471</b>	<b>8010010</b>
Timing Cover / Cam Oil Seal		<b>9379</b> [T/Cover]	<b>9379</b> [T/Cover]	<b>9837</b> [Cam] <b>9627</b> [T/Cover]	<b>9626</b> <b>9850</b> [Cam 130,150] <b>9857</b> [Cam x 2 160] <b>9853</b> [T/Cover]
Rear Wheel Bearing	- Inner	<b>HUB183</b> [with integrated ABS sensor]	<b>HUB245</b> [with integrated ABS sensor] <b>HUB374</b> [with integrated ABS sensor]	<b>331274</b>	<b>HUB002</b> [Non ABS] [25mm Early] <b>HUB006</b> [Non ABS] [28mm Late]
	- Outer			<b>11910+49</b>	
Rear Wheel Oil Seal	- Inner	HUB UNIT	HUB UNIT		<b>9855</b> [Early] <b>9851</b> [Late] HUB UNIT
	- Outer			<b>425607</b>	
Rear Wheel Kit		<b>PQ866</b> [5 Studs] [Mounting side OD: 74mm]	<b>PQ810</b> [5 Studs] [Flange: 139.5mm] [Mounting side OD: 72mm] <b>PQ1089</b> [5 Studs] [Flange: 152mm] [Mounting side OD: 72mm]	<b>PQ150</b>	<b>PQ404</b> [Early] [4 Studs] <b>PQ405</b> [Late] [4 Studs]
Rear Wheel Hub / Stub Axle					

APPLICATIONS	LOCATION	HONDA BALLADE SH4	HONDA BALLADE SR4	HONDA BALLADE SO4	HONDA BALLADE
		150 16V SOHC D15B3 160i 16V SOHC, DOHC D16A9	150 Encore, Luxline, Spreeline D15B3 160E, i D16A7 180E, i B18B3	150i Encore, Luxline, Spreeline D15Z4 160i Luxline, Spreeline, V-Tec D16Y9, D16Z 180i Luxline B18B4	1.5i L15A7
YEARS		89-92	92-98	96-00	2011-
Front Wheel Bearing	- Inner	DAC0871	DAC387340	DE08A55 [Inner Diameter: 43mm]	DAC38BRIO [with integrated ABS sensor]
	- Outer				
Front Wheel Oil Seal	- Inner	Sealed Bearing	Sealed Bearing	Sealed Bearing	Sealed Bearing
	- Outer				
Front Wheel Kit		PQ338	PQ408 [ID: 38mm]	PQ464 [ID: 43mm]	PQ811
Front Wheel Hub / Stub Axle		338HUB	408HUB [26 Spline]	464HUB [Flange Ø: 139mm]	811HUB
Alternator / Generator Bearing	- Front	63032RS [150]		65012RS	
	- Rear	B8-85D [150] 94912RS [160]	94912RS	63982RS	
Concentric / Thrust Bearing		RB9893	RB9851 [150, 160] RB9658 [180]	RB9851 [150, 160] RB9658 [180]	RB9851
Diff Carrier Bearing	- Left	6207 [150] 6208 [160]	6207 [Man. 150] 6208 [Man. 160, 180,Auto.]	6207 [Man. 150] 6208 [Man. 160, 180,Auto.]	
	- Right	6207 [150] 6208 [160]	6207 [Man. 150] 6208 [Man. 160, 180,Auto.]	6207 [Man. 150] 6208 [Man. 160, 180, Auto.]	
Diff Pinion Bearing	- Front		9622 [Man./Auto.] 9553 [Man./Auto.]	9622 [Man./Auto.] 9553 [Man./Auto.]	
	- Rear		9622 [Man./Auto.] 9848 [Man./Auto.]	9622 [Man./Auto.] 9848 [Man./Auto.]	
Propshaft Support Bearing					
Pulley Bearing					
Spigot Shaft Bearing		6202 2RS	6002 2RS		
V-Belt Tensioner					
Drive Shaft Oil Seal	- Left	9622 [Man. 150, Auto. 150/160] 9852 [Man. 160 SOHC] 405607 [Man. 160 DOHC]	9937	9937	
	- Right	9852 [Man. 150] 357609 [Auto. 150] 406210 [Man. 160] 407609 [Auto. 160]	9937	9937	
Gearbox Oil Seal	- Front	9849 [Man.] 9854 [Auto.]	9849 [Man. 150, 160] 9622 [Man. 180] 9854 [Auto.]	9622 [150, 160] 413807 [180]	
	- Rear		426207 [180]	264208	
Pinion Oil Seal					
Spark Plug Tube Seal					
Rear Main Bearing Oil Seal		8010010	8010010	8010010	9464
Timing Cover / Cam Oil Seal		9626 [Cam SOHC] 9850 [Cam SOHC] 9857 [Cam x 2 DOHC] 9853 [T/Cover]	9626 [Cam SOHC] 9850 [Cam SOHC] 9857 [Cam x 2 DOHC] 9853 [T/Cover]	9626 [Cam SOHC] 9850 [Cam SOHC] 9857 [Cam x 2 DOHC] 9853 [T/Cover]	9382
Rear Wheel Bearing	- Inner	DACF1015 [Non ABS] HUB005-39 [30mm Disc] [Gear type ABS]	DACF1015 [Non ABS] HUB005-39 [30mm Disc] [Gear type ABS]	DACF1015 [Non ABS] HUB005-39 [30mm Disc] [Gear type ABS]	HUB144 [with integrated ABS sensor] [Flange Ø: 139mm] HUB353
	- Outer				
Rear Wheel Oil Seal	- Inner	9851 [Disc only] HUB UNIT	HUB UNIT 9851 [Disc only]	HUB UNIT 9851 [Disc only]	HUB UNIT
	- Outer				
Rear Wheel Kit		PQ406 [30mm Drum] PQ409 [4 Studs]	PQ406 [30mm Drum] PQ409 [4 Studs]	PQ406 [30mm Drum] PQ409 [4 Studs]	PQ785 [ID: 28mm] [4 Studs] PQ1050 [ID: 30mm]
Rear Wheel Hub / Stub Axle					



APPLICATIONS	LOCATION	HONDA BRIO 1.2 L12B1	HONDA CIVIC SO3 150i Luxline, Spreeline D15Z4 160i Luxline, V-Tec D16Z	HONDA CIVIC VII 150i 170i V-Tec	HONDA CIVIC VIII 1.8i VTEC EXi, LXi, VXi, R18A2 2.0 i-VTEC Type "R" K20Z4 2.2CTDi VXi
YEARS		2012-	96-00	03-06	07-13
Front Wheel Bearing	- Inner	<b>DAC38BRIO</b> [with integrated ABS sensor]	<b>DE08A55</b> [ID: 43mm]	<b>DE08A55</b> [ID: 43mm]	<b>DACFWBHC1</b> [1.8] <b>DACFWBHA</b> [2.0] <b>DACFWBHC2</b> [2.2]
	- Outer				
Front Wheel Oil Seal	- Inner	Sealed Bearing	Sealed Bearing	Sealed Bearing	Sealed Bearing
	- Outer				
Front Wheel Kit		<b>PQ811</b>	<b>PQ464</b> [ID: 43mm]	<b>PQ464</b> [ID: 43mm]	<b>PQ682</b> [1.8] [ID: 43mm] <b>PQ674</b> [2.0] [ID: 48mm] <b>PQ683</b> [2.2] [ID: 45mm]
Front Wheel Hub / Stub Axle		<b>811HUB</b>	<b>464HUB</b> [Flange Ø: 139mm]	<b>464HUB</b> [Flange Ø: 139mm]	<b>682HUB</b> <b>683HUB</b> <b>674HUB</b>
Alternator / Generator Bearing	- Front		<b>65012RS</b>	<b>65012RS</b>	
	- Rear		<b>63982RS</b>	<b>63982RS</b>	
Concentric / Thurst Bearing			<b>RB9851</b>	<b>RB9658</b>	<b>RB9851</b> <b>RB9697</b> [Type R, 2.2i]
Diff Carrier Bearing	- Left		<b>6207</b> [Man.] <b>6208</b> [Auto.]	<b>6207</b> [Man.] <b>6208</b> [Auto.]	
	- Right		<b>6207</b> [Man.] <b>6208</b> [Auto.]	<b>6207</b> [Man.] <b>6208</b> [Auto.]	
Diff Pinion Bearing	- Front		<b>9938</b> [Man./Auto.]	<b>9938</b> [Man./Auto.]	<b>9522</b> [1.8, 2.0]
	- Rear		<b>9938</b> [Man./Auto.]	<b>9938</b> [Man./Auto.]	<b>9522</b> [1.8, 2.0]
Propshaft Support Bearing					
Pulley Bearing					
Spigot Shaft Bearing					
V-Belt Tensioner					
Drive Shaft Oil Seal	- Left				
	- Right				
Gearbox Oil Seal	- Front		<b>413807</b> [Man.] <b>9622</b> [Auto.]	<b>413807</b> [Man.] <b>9622</b> [Auto.]	
	- Rear		<b>2838</b> [Man.] <b>9848</b> [Auto.]	<b>2838</b> [Man.] <b>9848</b> [Auto.]	
Pinion Oil Seal					
Spark Plug Tube Seal					
Rear Main Bearing Oil Seal		<b>9464</b>	<b>8010010</b>	<b>8010010</b>	<b>9381</b> [2.2i] <b>9464</b> [1.8, 2.0]
Timing Cover / Cam Oil Seal			<b>9850</b> [Cam x 2] <b>9853</b> [T/Cover]	<b>9850</b> [Cam x 2] <b>385006</b> [T/Cover]	<b>9379</b> [T/Cover] <b>9521</b> [Type R T/Cover]
Rear Wheel Bearing	- Inner	<b>HUB144</b> [with integrated ABS sensor] [Flange Ø: 139mm]	<b>DACF1015</b> [Non ABS] <b>HUB005-39</b> [Gear type ABS]	<b>HUB247</b> [Gear type ABS] <b>HUB248</b> [Gear type ABS]	<b>HUB185</b> [Gear type ABS] <b>HUB361</b> [with integrated ABS sensor]
	- Outer				
Rear Wheel Oil Seal	- Inner		Sealed Bearing <b>9851</b> [Disc only] HUB UNIT	HUB UNIT	HUB UNIT
	- Outer				
Rear Wheel Kit		<b>PQ785</b> [ID: 28mm] [4 Studs]	<b>PQ406</b> [30mm Drum] <b>PQ409</b> [4 Studs]	<b>PQ813</b> [4 Studs] [Discs] <b>PQ814</b> [4 Studs] [Drums]	<b>PQ868</b> [Hatch] [5 Studs] <b>PQ1063</b> [Sedan] [5 Studs]
Rear Wheel Hub / Stub Axle					

APPLICATIONS	LOCATION	HONDA CIVIC IX 1.8 i-VTEC R18Z4	HONDA CR-V I 4X4 2.0 5 Dr. SUV B20B3, B20Z1	HONDA CR-V II 4X4 2.0 K20A4	HONDA CR-V III 4X4 2.0 i-VTEC R20A1 2.2 i-CTDi N22A2 2.2 i-DTEC N22B3 2.4 i-Vtec K24Z1, K24Z4
YEARS		2012-	97-05	05-09	09-12
Front Wheel Bearing	- Inner	DACFWBHC1	DACFWBHCRV [NON-ABS]	DACFWBHCRVASB DAC51CRV	DAC51CRV
	- Outer				
Front Wheel Oil Seal	- Inner	Sealed Bearing	Sealed Bearing	Sealed Bearing	Sealed Bearing
	- Outer				
Front Wheel Kit		PQ682	PQ921	PQ683 [ID: 45mm] PQ919 [ID: 51mm]	PQ919 [ID: 51mm]
Front Wheel Hub / Stub Axle		682HUB		683HUB	919HUB
Alternator / Generator Bearing	- Front				
	- Rear				
Concentric / Thrust Bearing		RB9851	RB9697	RB9697	RB9697
Diff Carrier Bearing	- Left				
	- Right				
Diff Pinion Bearing	- Front		9938 [Fr. Axle] 405810 [Rr. Axle Man.] 407609 [Rr. Axle Auto.]		
	- Rear		9938 [Fr. Axle] 9622 [Rr. Axle]		
Propshaft Support Bearing					
Pulley Bearing					
Spigot Shaft Bearing					
V-Belt Tensioner					
Drive Shaft Oil Seal	- Left			9522	9522
	- Right			9522	9522
Gearbox Oil Seal	- Front		2838 [Man.] 9854 [Auto.]		
	- Rear				
Pinion Oil Seal					
Spark Plug Tube Seal					
Rear Main Bearing Oil Seal			8010010	9464	9381 [2.2] 9464
Timing Cover / Cam Oil Seal			385007 [T/Cover]	9379 [T/Cover]	9379 [T/Cover]
Rear Wheel Bearing	- Inner	HUB185 [Gear type ABS]	HUB210L/R [Non ABS]	DAC387340 DAC387340ASB	HUB249 [with integrated ABS sensor]
	- Outer				
Rear Wheel Oil Seal	- Inner		HUB UNIT	Sealed Bearing	HUB UNIT
	- Outer				
Rear Wheel Kit		PQ868 [5 Studs]	PQ920L/R	PQ408 [ID: 38mm] [Non ASB] PQ784 [ID: 38mm] [ASB]	PQ918 [5 Studs ID: 30mm]
Rear Wheel Hub / Stub Axle				784AHUB	

APPLICATIONS	LOCATION	HONDA CR-V IV 4X2, 4X4 2.0 R20A6, 9 2.0 i-VTEC R20A5, 6, 9 2.2 i-DTEC N22B4 2.4i K24Z9	HONDA FR-V 1.8i R18A1	HONDA JAZZ 1.4 DSi 1.5 V-TEC L15A	HONDA JAZZ 1.3 i-VTEC LX Man., Auto. L13Z1 1.4i L13Z1 1.5 i-VTEC EX L15A
		YEARS	2012-	07-10	03-07
Front Wheel Bearing	- Inner	DAC51CRV	DACFWBHC2	DAC387340ASB	DAC38BRIO
	- Outer				
Front Wheel Oil Seal	- Inner	Sealed Bearing	Sealed Bearing	Sealed Bearing	Sealed Bearing
	- Outer				
Front Wheel Kit		PQ919 [ID: 51mm]	PQ683 [ASB]	PQ784 [ASB]	PQ811
Front Wheel Hub / Stub Axle		919HUB [2.2]	683HUB	784HUB [26 Splines]	811HUB
Alternator / Generator Bearing	- Front				
	- Rear				
Concentric / Thurst Bearing		RB9697	RB9697	RB9851	RB9851
Diff Carrier Bearing	- Left				
	- Right				
Diff Pinion Bearing	- Front				
	- Rear				
Propshaft Support Bearing					
Pulley Bearing					
Spigot Shaft Bearing					
V-Belt Tensioner					
Drive Shaft Oil Seal	- Left			9622	9622
	- Right			9522	9522
Gearbox Oil Seal	- Front				
	- Rear				
Pinion Oil Seal					
Spark Plug Tube Seal					
Rear Main Bearing Oil Seal		9381 [2.2] 9464	9464	9464	9464
Timing Cover / Cam Oil Seal		9521 [T/Cover]	9379 [T/Cover]	9382 [T/Cover]	9554 [T/Cover]
Rear Wheel Bearing	- Inner	HUB249 [with integrated ABS sensor] HUB411 [with integrated ABS sensor]	HUB253 [with integrated ABS sensor]	HUB144 [with integrated ABS sensor] [Flange Ø: 139mm]	HUB352 [with integrated ABS sensor] HUB353 [Discs] [with integrated ABS sensor]
	- Outer				
Rear Wheel Oil Seal	- Inner	HUB UNIT	HUB UNIT	HUB UNIT	HUB UNIT
	- Outer				
Rear Wheel Kit		PQ918 [5 Studs ID: 30mm] PQ1144 [2.0 i-VTEC] PQ1155 [4X4]	PQ913	PQ785 [ID: 28mm] [4 Studs]	PQ930 [ID: 30mm] [Drums] PQ1050 [ID: 30mm] [Discs]
Rear Wheel Hub / Stub Axle					

APPLICATIONS	LOCATION	HONDA JAZZ IV	HONDA ODYSSEY	HONDA PRELUDE	
		1.2 Trend L12B4 1.5 Elegance L15Z2	2.2 5 Dr. S/W 2.3 V-Tec 5 Dr. S/W	1.8 EX ES/ET 2.2 V-Tec, Si F22, A22	
YEARS		2015-	96-02	84-87 [1.8] 91-98 [2.2]	
Front Wheel Bearing	- Inner	DAC38BRIO	DAC387340 DE08A55	DAC387234 [1.8] DAC4484 [2.2]	
	- Outer				
Front Wheel Oil Seal	- Inner	Sealed Bearing	Sealed Bearing	9949 [1.8] Sealed Bearing [2.2]	
	- Outer			9950 [1.8]	
Front Wheel Kit		PQ811	PQ408 [ID: 38mm] PQ464 [ID: 43mm]	PQ561 [1.8] PQ579 [2.2]	
Front Wheel Hub / Stub Axle		811HUB	408HUB [26 Splines] 464HUB [Flange Ø: 139mm]		
Alternator / Generator Bearing	- Front				
	- Rear				
Concentric / Thurst Bearing		RB9851			
Diff Carrier Bearing	- Left				
	- Right				
Diff Pinion Bearing	- Front				
	- Rear				
Propshaft Support Bearing					
Pulley Bearing					
Spigot Shaft Bearing					
V-Belt Tensioner					
Drive Shaft Oil Seal	- Left	9622			
	- Right	9522			
Gearbox Oil Seal	- Front				
	- Rear				
Pinion Oil Seal					
Spark Plug Tube Seal					
Rear Main Bearing Oil Seal			8010010	8010010	
Timing Cover / Cam Oil Seal			385007 [T/Cover]	9850 [Cam 1.8] 2034 [T/Cover 1.8] 405207 [T/Cover 2.2]	
Rear Wheel Bearing	- Inner	HUB413 [with integrated ABS sensor]		331274 [1.8] HUB082 [2.2 ABS] [Gear type ABS]	
	- Outer			11910+49 [1.8]	
Rear Wheel Oil Seal	- Inner	HUB UNIT		425607 [1.8] HUB UNIT [2.2 ABS]	
	- Outer				
Rear Wheel Kit		PQ1149		PQ150 [1.8] PQ580 [2.2 ABS][4 Studs]	
Rear Wheel Hub / Stub Axle					

APPLICATIONS	LOCATION	HYUNDAI ACCENT X3	HYUNDAI ACCENT LC	HYUNDAI ACCENT MC	HYUNDAI ACCENT RB
		1.3 G4EH 1.5 G4EK	1.3 G4EH 1.5 G4EK 1.6 G4ED	1.6 G4ED	1.6 G4FC
YEARS		94-00	00-06	06-11	11-18
Front Wheel Bearing	- Inner	29710+57410 [ID: 38.1mm]	DAC387037	DAC387037	DAC387037 [OD:70mm] DAC38RIO [OD:72mm] [2014-]
	- Outer	29710+57410 [ID: 38.1mm]			
Front Wheel Oil Seal	- Inner	9623	Sealed Bearing	Sealed Bearing	Sealed Bearing
	- Outer	9623			
Front Wheel Kit		PQ189	PQ422	PQ422	PQ422 PQ963 [14-]
Front Wheel Hub / Stub Axle		189HUB	422AHUB	422AHUB	422AHUB
Alternator / Generator Bearing	- Front				
	- Rear				
Concentric / Thurst Bearing		RB9002	RB9002	RB9002	RB9004
Diff Carrier Bearing	- Left				
	- Right				
Diff Pinion Bearing	- Front				
	- Rear				
Propshaft Support Bearing					
Pulley Bearing					
Spigot Shaft Bearing					
V-Belt Tensioner					
Drive Shaft Oil Seal	- Left	9622	9622		
	- Right	9622	9622		
Gearbox Oil Seal	- Front		253506		
	- Rear				
Pinion Oil Seal					
Spark Plug Tube Seal					
Rear Main Bearing Oil Seal		9426	9426	9464	9041
Timing Cover / Cam Oil Seal		9627 [Cam] 354807 [T/Cover]	9627 [Cam][1.3, 1.5] 354807 [T/Cover]	9037 [T/Cover]	9066 [T/Cover]
Rear Wheel Bearing	- Inner	HUB240 [OD: 63mm][Non ABS] HUB940 [Alt.] [OD: 63mm] [Non ABS]	HUB079 [Non ABS] [Flange Ø: 139mm] HUB178 [Gear type ABS] [Flange Ø: 140mm]	HUB241 [2011-] [Gear type ABS] [Flange Ø: 132mm] HUB104 [Non ABS] [Flange Ø: 140mm] HUB186 [with integrated ABS sensor]	HUB241 [Gear Type ABS] HUB186 [with integrated ABS sensor]
	- Outer				
Rear Wheel Oil Seal	- Inner	HUB UNIT	HUB UNIT	HUB UNIT	HUB UNIT
	- Outer				
Rear Wheel Kit		PQ420 [4 Studs] PQ423 [Alt.] [4 Studs]	PQ455 [4 Studs] PQ869 [4 Studs]	PQ697 [4 Studs] PQ777 [4 Studs] PQ870 [4 Studs]	PQ697 [4 Studs] PQ870 [4 Studs]
Rear Wheel Hub / Stub Axle					

APPLICATIONS	LOCATION	HYUNDAI ACCENT V HC	HYUNDAI ATOS	HYUNDAI BAKKIE	HYUNDAI ELANTRA J1
		1.6 G4FG, G4FC Pet.	1.0 Prime G4HC [00-05] 1.1 G4HG [2005-]	2.5i D4BH Dies. 2.6i D4BB Dies. H100 P/Van [00-07] 2.5i D4BH Dies. 2.6i D4BB Dies.	1.6 Exec., G4CR 1.8 Exec., G4CN
YEARS		2018-	00-13	97-01 00-07	93-95
Front Wheel Bearing	- Inner	DAC387437ABS	29710/57410 DAC387037	48510/48	29710/57410
	- Outer		29710/57410	12610/49	29710/57410
Front Wheel Oil Seal	- Inner	Sealed Bearing	9623 Sealed Bearing	506509	9623
	- Outer		9623		9623
Front Wheel Kit		PQ1143	PQ189 PQ422	PQ190	PQ189
Front Wheel Hub / Stub Axle		422BHUB [25 Spline] [OD: 123mm]	189AHUB 422AHUB	190AHUB [H100]	189HUB
Alternator / Generator Bearing	- Front				
	- Rear				
Concentric / Thurst Bearing		RB9679	RB9679	RB9900 [97-03] RB9876 [97-01] RB9698 [2001-] RB9672 [H100]	RB9836
Diff Carrier Bearing	- Left				
	- Right				
Diff Pinion Bearing	- Front				
	- Rear				
Propshaft Support Bearing					
Pulley Bearing					
Spigot Shaft Bearing					
V-Belt Tensioner					
Drive Shaft Oil Seal	- Left	9622	9622		9622
	- Right	9622	9622		9622
Gearbox Oil Seal	- Front		223206	304508	
	- Rear			9636	
Pinion Oil Seal					
Spark Plug Tube Seal					
Rear Main Bearing Oil Seal		9039	9207	9620	9620
Timing Cover / Cam Oil Seal		9666	9626 [Cam]	9627 [Cam] 446007 [T/Cover][Bakkie]	9627 [Cam] 9209 [T/Cover]
Rear Wheel Bearing	- Inner	HUB409	44610+49 HUB079 [Non ABS] [Flange Ø: 139mm] HUB190 [Gear Type ABS] [Flange Ø: 140mm]	U360/399+1852119 [Local] 30208 + RR44 [Import]	TR2852169
	- Outer		11710+49		TR2852169
Rear Wheel Oil Seal	- Inner	HUB UNIT	385206 HUB UNIT	486510 [Import]	385206
	- Outer			9415 [Local] 9955 [Import]	
Rear Wheel Kit		PQ1141	PQ143 PQ455 [4 Studs] PQ881 [4 Studs]	PQ176 [Local] PQ430 [Import] PQ1134 [Bakkie]	PQ421
Rear Wheel Hub / Stub Axle					

APPLICATIONS	LOCATION	HYUNDAI ELANTRA J2	HYUNDAI ELANTRA XD	HYUNDAI ELANTRA HD	HYUNDAI ELANTRA MD/UD
		1.6 RD G4GR 1.8 G4FG 2.0 G4GC	1.6 G4ED 2.0 G4GC, CRDi D4EA	1.6 GLS 2.0 GLS, G4GC	1.6 G4FG 1.8 G4NB
YEARS		95-01	02-07	07-11	11-16
Front Wheel Bearing	- Inner	DAC387037	DACFWBHYELJ4	DACFWBHYELJ4	DACFWBHYI30
	- Outer				
Front Wheel Oil Seal	- Inner	Sealed Bearing	Sealed Bearing	Sealed Bearing	Sealed Bearing
	- Outer				
Front Wheel Kit		PQ422	PQ676 [2.0]	PQ676	PQ767
Front Wheel Hub / Stub Axle		422HUB	676HUB	676HUB	767AHUB
Alternator / Generator Bearing	- Front				
	- Rear				
Concentric / Thurst Bearing		RB9002 [1.6] RB9001 [1.8]	RB9002	RB9002 [1.6] RB9001 [2.0]	
Diff Carrier Bearing	- Left				
	- Right				
Diff Pinion Bearing	- Front				
	- Rear				
Propshaft Support Bearing					
Pulley Bearing					
Spigot Shaft Bearing					
V-Belt Tensioner					
Drive Shaft Oil Seal	- Left	9622	9622		
	- Right	9622	9622		
Gearbox Oil Seal	- Front			253506	
	- Rear				
Pinion Oil Seal					
Spark Plug Tube Seal					
Rear Main Bearing Oil Seal		9620	9620	9426 [1.6] 9620 [2.0]	
Timing Cover / Cam Oil Seal		9627 [Cam] 9209 [T/Cover]	9627 [Cam] 9209 [T/Cover]	355008 [Cam 2.0] 354807 [T/Cover]	
Rear Wheel Bearing	- Inner	HUB940 [Non ABS] [OD: 63mm] HUB947 [Gear Type ABS 29Teeth] [Flange Ø: 139mm]	HUB244 [1.6, 2.0] [Gear Type ABS] HUB136 [02-04][1.6] [Non ABS] [Flange Ø: 139mm]	HUB138 [Gear Type ABS] [Flange Ø: 139mm] HUB234 [2.0 HD][ Ladder Type ABS] [Flange Ø: 148mm]	HUB284 [Gear Type ABS] [Flange Ø: 139mm]
	- Outer				
Rear Wheel Oil Seal	- Inner	HUB UNIT	HUB UNIT	HUB UNIT	HUB UNIT
	- Outer				
Rear Wheel Kit		PQ423 [4 Studs] PQ424 [4 Studs]	PQ774 [Discs, with ABS][4 Studs] PQ789 [Drums, Non ABS][4 Studs]	PQ791 [Discs, With ABS] [4 Studs] PQ768 [2.0 HD][5 Studs]	PQ950 [5 Studs]
Rear Wheel Hub / Stub Axle					



APPLICATIONS	LOCATION	HYUNDAI GETZ	HYUNDAI H1	HYUNDAI i10 PA	HYUNDAI GRAND
		1.3 G4EA 1.4i G4EE 1.5 D3EA, D4FA 1.6 G4ED-G	2.4 G4KC CVVT P/van Man., Wagon 2.5 D4CB CRDi P/van Diesl. Man/Auto.	1.1 G4HG 1.2 G4LA	i10 1.0 G3LA 1.2 G4LA
YEARS		03-12	2009-	08-15	14-19
Front Wheel Bearing	- Inner	DAC387037	HUB239 [Gear Type ABS] [Flange Ø: 161,3mm]	DAC387037	DAC387037
	- Outer				
Front Wheel Oil Seal	- Inner	Sealed Bearing	HUB UNIT	Sealed Bearing	Sealed Bearing
	- Outer				
Front Wheel Kit		PQ422	PQ782 [6 Studs]	PQ422	PQ422
Front Wheel Hub / Stub Axle		422AHUB		422AHUB [25 Spline] [OD: 120mm] 422BHUB [25 Spline] [OD: 123mm] 422CHUB [24 Spline]	422BHUB [25 Spline] [OD: 123mm]
Alternator / Generator Bearing	- Front				
	- Rear				
Concentric / Thurst Bearing		RB9002	RB9698	RB9679	RB9679
Diff Carrier Bearing	- Left				
	- Right				
Diff Pinion Bearing	- Front				
	- Rear				
Propshaft Support Bearing					
Pulley Bearing					
Spigot Shaft Bearing					
V-Belt Tensioner					
Drive Shaft Oil Seal	- Left	9622		9622 9654	9622 9654
	- Right	9622		9622 9654	9622 9654
Gearbox Oil Seal	- Front			9523	
	- Rear				
Pinion Oil Seal					
Spark Plug Tube Seal					
Rear Main Bearing Oil Seal		9620	8510308 [2.4] 9067 [2.5]	9207 [1.1] 9039 [1.2]	9039
Timing Cover / Cam Oil Seal		9627 [Cam] 9209 [T/Cover]	355008 [Cam] 9328 [T/Cover 2.4] 9068 [T/Cover 2.5]	355008 [Cam 1.1] 9384 [T/Cover 1.1] 9666 [T/Cover 1.2]	9666 [T/Cover]
Rear Wheel Bearing	- Inner	HUB104 [Non ABS] [Flange Ø: 140mm] HUB186 [With integrated ABS sensor]	DAC45HYH1ABS	HUB104 [Non ABS] [Flange Ø: 140mm] HUB186 [With integrated ABS sensor] HUB244 [Gear Type ABS]	HUB104 [Non ABS] [Flange Ø: 140mm] HUB186 [With integrated ABS sensor]
	- Outer				
Rear Wheel Oil Seal	- Inner	HUB UNIT	Sealed Bearing	HUB UNIT	HUB UNIT
	- Outer				
Rear Wheel Kit		PQ777 [4 Studs] PQ870 [4 Studs]	PQ775 [ABS]	PQ777 [4 Studs] PQ870 [4 Studs] PQ774	PQ777 [4 Studs] PQ870 [4 Studs]
Rear Wheel Hub / Stub Axle					

APPLICATIONS	LOCATION	HYUNDAI GRAND i10 1.0 G3LA, G3LD	HYUNDAI i20 PB/PBT 1.2 G4LA 1.4 G4FA 1.6 G4FC	HYUNDAI i30 FD/GD 1.6 G4FG, G4GG 1.8 G4NB 2.0 G4GC-G	HYUNDAI iX35 4X2, 4X4 2.0 G4KD 2.0 CRDi D4HA 2.4 G4KE
		YEARS	2019-	2009-	2010-
Front Wheel Bearing	- Inner	DAC38RIO	DAC387037 DAC38RIO	DACFWBHYI30	DACHYTUC1
	- Outer				
Front Wheel Oil Seal	- Inner	Sealed Bearing	Sealed Bearing	Sealed Bearing	Sealed Bearing
	- Outer				
Front Wheel Kit		PQ963	PQ422 [OD: 70mm] PQ963 [OD: 72mm]	PQ767	PQ583 [ID:45mm]
Front Wheel Hub / Stub Axle		422BHUB [25 Spline] [OD: 123mm]	422AHUB [25 Spline] [OD: 123mm] 422BHUB [25 Spline] [OD: 123mm]	767HUB [-2012]	583AHUB
Alternator / Generator Bearing	- Front				
	- Rear				
Concentric / Thurst Bearing		RB9679	RB9679	RB9004	RB9699
Diff Carrier Bearing	- Left				
	- Right				
Diff Pinion Bearing	- Front				
	- Rear				
Propshaft Support Bearing					
Pulley Bearing					
Spigot Shaft Bearing					
V-Belt Tensioner					
Drive Shaft Oil Seal	- Left	9654			
	- Right	9654			
Gearbox Oil Seal	- Front		9523		
	- Rear				
Pinion Oil Seal					
Spark Plug Tube Seal					
Rear Main Bearing Oil Seal		9039	9041	9041 [1.6] 9620 [2.0]	8510308 [2.4]
Timing Cover / Cam Oil Seal		9666	9066 [T/Cover]	9066 [T/Cover 1.6] 355008 [Cam & T/Cover 2.0]	9328 [T/Cover 2.4]
Rear Wheel Bearing	- Inner	HUB421 [With integrated ABS sensor]	HUB241 [2012-] [Gear Type ABS] HUB186 [With integrated ABS sensor]	HUB234 [Ladder Type ABS] [Flange Ø: 148mm] HUB284 Alt. [Gear Type ABS] [Flange Ø: 139mm]	DAC427639 [4X4] HUB235 [Ladder Type ABS] [Flange Ø: 148mm]
	- Outer				
Rear Wheel Oil Seal	- Inner	HUB UNIT	HUB UNIT	HUB UNIT	Sealed Bearing HUB UNIT
	- Outer				
Rear Wheel Kit		PQ1157	PQ697 [4 Studs] PQ870 [4 Studs]	PQ768 [5 Studs] PQ950 [5 Studs] Alt.	PQ521 [4X4] PQ770 [5 Studs]
Rear Wheel Hub / Stub Axle					521HUB [ID: 42mm] [4X4]

APPLICATIONS	LOCATION	HYUNDAI MATRIX	HYUNDAI	HYUNDAI	HYUNDAI
		1.6 GLS G4ED 1.8 G4GB-G	S-COUPE 1.5	SANTA FE' 4X4 2.4 SUV G4JS 2.7 V6 SUV G6BA-G	SANTA FE' 4X2, 4X4 2.2 CRDi D4EB "CM" 2.2 CRDi D4EB, D4HB
YEARS		02-08	94-95	01-05	06-10
Front Wheel Bearing	- Inner	DACFWBHYELJ4	29710/57410	HUB236 [With integrated ABS sensor]	HUB236 [With integrated ABS sensor]
	- Outer		29710/57410		
Front Wheel Oil Seal	- Inner	Sealed Bearing	9623	HUB UNIT	HUB UNIT
	- Outer		9623		
Front Wheel Kit		PQ676	PQ189	PQ805 [5 Studs] [30 Spline]	PQ805 [5 Studs] [30 Spline]
Front Wheel Hub / Stub Axle		676HUB	189HUB		
Alternator / Generator Bearing	- Front				
	- Rear				
Concentric / Thurst Bearing		RB9001	RB9002	RB9001 [01-05] Concentric Slave Cylinder	Concentric Slave Cylinder
Diff Carrier Bearing	- Left				
	- Right				
Diff Pinion Bearing	- Front				
	- Rear				
Propshaft Support Bearing					
Pulley Bearing					
Spigot Shaft Bearing					
V-Belt Tensioner					
Drive Shaft Oil Seal	- Left		9622	9208	
	- Right		9622	9208	
Gearbox Oil Seal	- Front			9857	
	- Rear				
Pinion Oil Seal					
Spark Plug Tube Seal					
Rear Main Bearing Oil Seal			9426	9667	9268
Timing Cover / Cam Oil Seal			9627 [Cam]	304208 [Cam]	365007 [Cam] 9269 [T/Cover]
Rear Wheel Bearing	- Inner	HUB137 [Non ABS] [Flange Ø: 139mm] HUB244 [Gear Type ABS]	HUB940 [Non ABS]	DAC427639	HUB236 [4X4] [With integrated ABS sensor] HUB237 [With integrated ABS sensor]
	- Outer				
Rear Wheel Oil Seal	- Inner	HUB UNIT	HUB UNIT	Sealed Bearing	HUB UNIT
	- Outer				
Rear Wheel Kit		PQ790 [4 Studs] PQ774 [4 Studs]	PQ423 [4 Studs] [OD: 63mm]	PQ521	PQ805 [4X4] [5 Studs] [30 Spline] PQ806 [5 Studs]
Rear Wheel Hub / Stub Axle				521HUB [ID: 42mm]	

APPLICATIONS	LOCATION	HYUNDAI SONATA Y3 2.0 G4CP 2.5 V6 G6BV 3.0 V6 G6AT	HYUNDAI SONATA 2.0 V6 [EF] 2.4 [NF] [05-10] 2.4 G4KC [YF] [2010-] 2.7 V6 [EF]	HYUNDAI TERRACAN 4X4 2.9 CRDi SUV 3.5i V6 SUV	HYUNDAI TIBURON 2.0 G4DF
YEARS		94-04	2001-	03-08	96-10
Front Wheel Bearing	- Inner	DAC408036 [-1995] DAC428036 [95-02] DACHYTUC1 [01-04]	DACHYTUC1	102910/49	DAC387037 DACFWBHYELJ4 [2002-]
	- Outer			102910/49	
Front Wheel Oil Seal	- Inner	Sealed Bearing	Sealed Bearing	9891	Sealed Bearing
	- Outer				
Front Wheel Kit		PQ519 [96-98] PQ889 [98-02] PQ583 [01-04]	PQ583 [ID:45mm] [2.0] [01-04]	PQ428	PQ422 PQ676 [2002-]
Front Wheel Hub / Stub Axle		583HUB [ID:45mm] [4 Studs] 889HUB [ID:42mm]	583AHUB [5 Studs]		422AHUB [up to -2002]
Alternator / Generator Bearing	- Front				
	- Rear				
Concentric / Thurst Bearing		RB9836	RB9699 [EF] Concentric Slave Cylinder	RB9698	RB9001
Diff Carrier Bearing	- Left	501310+49			
	- Right	501310+49			
Diff Pinion Bearing	- Front				
	- Rear				
Propshaft Support Bearing					
Pulley Bearing					
Spigot Shaft Bearing					
V-Belt Tensioner					
Drive Shaft Oil Seal	- Left	9622 [94-95] 9200 [96-02]			9622
	- Right	9622 [94-95] 9200 [96-02]			9622
Gearbox Oil Seal	- Front	253506		9763	
	- Rear				
Pinion Oil Seal					
Spark Plug Tube Seal					
Rear Main Bearing Oil Seal		9620 [2.0] 9667 [2.5, 3.0]			9620
Timing Cover / Cam Oil Seal		9627 [Cam] 446007 [T/Cover]		9385 [T/Cover]	9627 [Cam] 9209 [T/Cover]
Rear Wheel Bearing	- Inner	HUB018 [Gear Type ABS] [Flange Ø: 139mm] HUB242 [Gear Type ABS]	HUB243 [Gear Type ABS] HUB235 [Ladder Type ABS] [Flange Ø: 148mm]		HUB947 [96-01][Gear Type ABS] HUB138 [up to 2002] [Gear Type ABS] [Flange Ø: 139mm] HUB197 [2002-][Gear Type ABS] [Flange Ø: 139mm]
	- Outer				
Rear Wheel Oil Seal	- Inner	HUB UNIT	HUB UNIT		HUB UNIT
	- Outer				
Rear Wheel Kit		PQ612 [4 Studs] PQ716 [4 Studs]	PQ773 [5 Studs] PQ770 [5 Studs]		PQ424 [4 Studs] [ID: 28mm] PQ791 [4 Studs] [ID: 32mm] PQ818 [5 Studs]
Rear Wheel Hub / Stub Axle					

APPLICATIONS	LOCATION	HYUNDAI TUCSON JM 4X2, 4X4 2.0 G4GC 2.0 CRDi D4EA 2.7i V6 G6BA-G	HYUNDAI TUCSON TL, TLE 4X2, 4X4 1.6 GDi G4FD 1.6 T-GDi G4FJ 2.0 CRDi D4HA	HYUNDAI VELOSTER 1.6 GDi G4FD, G4FJ	
		YEARS	04-10	15-20	2013-
Front Wheel Bearing	- Inner	DACHYTUC1	HUB236 [With integrated ABS sensor]	DACFWBHYi30	
	- Outer				
Front Wheel Oil Seal	- Inner	Sealed Bearing	HUB UNIT	Sealed Bearing	
	- Outer				
Front Wheel Kit		PQ583 [ID:45mm]	PQ805	PQ767	
Front Wheel Hub / Stub Axle		583AHUB		767AHUB	
Alternator / Generator Bearing	- Front				
	- Rear				
Concentric / Thurst Bearing		RB9699 [4X2] Concentric Slave Cylinder	RB9004		
Diff Carrier Bearing	- Left				
	- Right				
Diff Pinion Bearing	- Front				
	- Rear				
Propshaft Support Bearing					
Pulley Bearing					
Spigot Shaft Bearing					
V-Belt Tensioner					
Drive Shaft Oil Seal	- Left				
	- Right				
Gearbox Oil Seal	- Front				
	- Rear				
Pinion Oil Seal					
Spark Plug Tube Seal					
Rear Main Bearing Oil Seal		9387 [4X4] 9620	9041		
Timing Cover / Cam Oil Seal		9386 [T/Cover] [4X4] 9627 [Cam] 9209 [T/Cover]	9066		
Rear Wheel Bearing	- Inner	DAC427639 [4X4] HUB235 [Ladder Type] [Flange Ø: 148mm] HUB135 [Gear Type ABS] [Flange Ø: 139mm]	HUB417 [With integrated ABS sensor] HUB418	HUB284 [Gear Type ABS] [Flange Ø: 139mm]	
	- Outer				
Rear Wheel Oil Seal	- Inner	Sealed Bearing HUB UNIT	HUB UNIT	HUB UNIT	
	- Outer				
Rear Wheel Kit		PQ521 [4X4] PQ770 PQ788 [5 Studs]	PQ1153 [4X2] PQ1154 [4X4] [27 Splines]	PQ950 [5 Studs]	
Rear Wheel Hub / Stub Axle		521HUB [ID: 42mm] [4X4]			

APPLICATIONS		LOCATION	ISUZU KB20 1.6 P/up G161Z Pet. <b>KB21</b> 1.6 P/up G161Z Pet. <b>KB22</b> 1.8 P/up G180Z Pet.	ISUZU KBD20 2.0 P/up C190 <b>KBD21</b> 2.0 P/up C190 <b>KBD22</b> 2.2 LE, P/up C223	ISUZU KB23 2.0 P/up G200Z <b>KB24</b> 2.3 LE 4ZD1 <b>KB25</b> 1.6 P/up G161Z <b>KB26</b> 1.6 P/up G161Z 1.8 P/up G180Z	ISUZU KBD23 2.5 LE, P/up 4JA1 <b>KBD25</b> 2.0 P/up C190
YEARS			78-89	78-89	79-89	79-89
Front Wheel Bearing	- Inner		32206	32206 48510+48 [Alt. 87-89]	32206	32206
	- Outer		32304	32304 12610/49 [Alt. 87-89]	32304	32304
Front Wheel Oil Seal	- Inner		9468	9468 506709 [Alt. 87-89]	9468	9468
	- Outer					
Front Wheel Kit			PQ170	PQ170 PQ346 [Alt. 87-89]	PQ170	PQ170
Front Wheel Hub / Stub Axle				346HUB		
Alternator / Generator Bearing	- Front		62022RS [78-83] 63022RS [84-89]	62022RS	62022RS [79-83] 63022RS [84-89]	62022RS
	- Rear		62012RS [78-83] 62022RS [84-89] or see Pg. I	63022RS	62012RS [79-83] 62022RS [84-89]	63022RS [2.0] 63042RS [2.5]
Concentric / Thurst Bearing			RB9562	RB9562	RB9562	RB9888 [23] RB9562 [25]
Diff Carrier Bearing	- Left		501310+49 [Local & Import]	501310+49 [Local & Import]	501310+49	501310+49 [Local & Import]
	- Right		501310+49 [Local & Import]	501310+49 [Local & Import]	501310+49	501310+49 [Local & Import]
Diff Pinion Bearing	- Front		30306 [Import] 86610+49 [Local]	30306 [Import] 86610+49 [Local]	30306 [Import] 86610+49 [Local]	30306 [Import] 86610+49 [Local]
	- Rear		32307 [Import] 88610+49 [Local]	32307 [Import] 88610+49 [Local]	32307 [Import] 88610+49 [Local]	32307 [Import] 88610+49 [Local]
Propshaft Support Bearing			AR5398			
Pulley Bearing						
Spigot Shaft Bearing			62032RS	62022RS	62032RS	62032RS
V-Belt Tensioner						
Drive Shaft Oil Seal	- Left					
	- Right					
Gearbox Oil Seal	- Front		9857	9857	9857	9857
	- Rear		9618	9618	9618 [1.6, 1.8, 2.0] 9771 [2.3]	9618 [2.0] 9771 [2.5]
Pinion Oil Seal			9616 [Import] 2738 [Local]	9616 [Import] 2738 [Local]	9616 [Import] 2738 [Local]	9616 [Import] 2738 [Local]
Spark Plug Tube Seal						
Rear Main Bearing Oil Seal			9777 [1.6] 9484 [1.8]	9484	9484	9484 [2.0] 9602 [Silicone] 9602V [Viton 2.5]
Timing Cover / Cam Oil Seal			9772 [T/cover]	9772 [T/cover]	9772 [T/cover] 405607 [T/cover 2.3]	9772 [T/cover]
Rear Wheel Bearing	- Inner		30208 [Import] U399+360 + 1852119 [Local]	30208 [Import] U399+360 + 1852119 [Local]	30208 [Import] U399+360 + 1852119 [Local]	30208 [Import] U399+360 + 1852119 [Local]
	- Outer					
Rear Wheel Oil Seal	- Inner		9764 [Import]	9764 [Import]	9764 [Import]	9764 [Import]
	- Outer		487009 [Import] 9415 [Local]	487009 [Import] 9415 [Local]	487009 [Import] 9415 [Local]	487009 [Import] 9415 [Local]
Rear Wheel Kit			PQ240 [Import] PQ176 [Local]	PQ176 [Local] PQ240 [Import]	PQ176 [Local] PQ240 [Import]	PQ240 [Import] PQ176 [Local]
Rear Wheel Hub / Stub Axle						

APPLICATIONS	LOCATION	ISUZU KBD26	ISUZU KB27	ISUZU 4X4 KB40	ISUZU 4X4 KBD40
		2.0 P/up C190 KBD27 2.2 C223 KBD28 2.5 4JA1	1.8 P/up G180Z KB28 2.0 P/up G200Z KB29 2.3 P/up 4ZD1	1.6 G161Z KB41 1.6 G161Z 1.8 G180Z KB42 1.8 G180Z KB43 2.0 G200Z KB44 2.3 4ZD1	KBD41 2.0 P/up C190 KBD42 2.2 P/up C223
YEARS		81-89	83-89	79-89	79-89
Front Wheel Bearing	- Inner	32206	32206	32008	32008
	- Outer	32304	32304	32007	32007
Front Wheel Oil Seal	- Inner	9468	506709	9603 [KB40/41/42/43] 9775 [KB44]	9603 [79-86] 9775 [87-89]
	- Outer				
Front Wheel Kit		PQ170	PQ170	PQ241 [KB40/41/42/43]	PQ241 [79-86]
Front Wheel Hub / Stub Axle					
Alternator / Generator Bearing	- Front	63022RS	63022RS	62022RS	62022RS
	- Rear	63042RS [Bush] or see Pg. I	62022RS	62012RS	63022RS
Concentric / Thrust Bearing		RB9562	RB9562	RB9888 [KB44] RB9562 [Rest]	RB9562
Diff Carrier Bearing	- Left	501310+49 [Local & Import]	501310+49	48510+48 [Front axle] 501310+49 [Imp. & Loc. rear axle]	48510+48 [Front axle] 501310+49 [Imp. & Loc. rear axle]
	- Right	501310+49 [Local & Import]	501310+49	48510+48 [Front axle] 501310+49 [Imp. & Loc. rear axle]	48510+48 [Front axle] 501310+49 [Imp. & Loc. rear axle]
Diff Pinion Bearing	- Front	30306 [Import] 86610+49 [Local]	30306 [Import] 86610+49 [Local]	30305 [Front axle] 30306 [Imp. rear axle] 86610+49 [Local rear]	30305 [Front axle] 30306 [Imp. rear axle] 86610+49 [Local rear]
	- Rear	32307 [Import] 88610+49 [Local]	32307 [Import] 88610+49 [Local]	02420+75 [Front axle] 32307 [Imp. rear axle] 88610+49 [Local rear]	02420+75 [Front axle] 32307 [Imp. rear axle] 88610+49 [Local rear]
Propshaft Support Bearing					
Pulley Bearing					
Spigot Shaft Bearing		62032RS	62032RS	62032RS	62032RS
V-Belt Tensioner					
Drive Shaft Oil Seal	- Left				
	- Right				
Gearbox Oil Seal	- Front	9857	9857	9857	9857
	- Rear	9618 [2.0] 9771 [2.2, 2.5]	9618 [1.6, 1.8, 2.0] 9771 [2.3]	9771	9771
Pinion Oil Seal		9616 [Import] 2738 [Local]	9616 [Import] 2738 [Local]	356513 [Front axle] 9616 [Imp. rear axle] 2738 [Local rear]	356513 [Front axle] 9616 [Imp. rear axle] 2738 [Local rear]
Spark Plug Tube Seal					
Rear Main Bearing Oil Seal		9484 [2.0] 9602 [Silicone] 9602V [Viton 2.5]	9484 [1.8, 2.0] 9602 [Silicone] 9602V [Viton 2.3]	9484 [KB40/41/42/43] 9602 [Silicone] 9602V [Viton KB44]	9484
Timing Cover / Cam Oil Seal		9772 [T/cover]	9772 [T/cover 1.8, 2.0] 405607 [T/cover 2.3]	9772 [T/cover]	9772 [T/cover]
Rear Wheel Bearing	- Inner	30208 [Import] U399+360 + 1852119 [Local]	30208 [Import] U399+360 + 1852119 [Local]	30208 [Import] U399+360 + 1852119 [Local]	30208 [Import] U399+360 + 1852119 [Local]
	- Outer				
Rear Wheel Oil Seal	- Inner	9764 [Import]	9764 [Import]	9764 [Import]	9764 [Import]
	- Outer	487009 [Import] 9415 [Local]	487009 [Import] 9415 [Local]	487009 [Import] 9415 [Local]	487009 [Import] 9415 [Local]
Rear Wheel Kit		PQ240 [Import] PQ176 [Local]	PQ176 [Local] PQ240 [Import]	PQ240 [Import] PQ176 [Local]	PQ240 [Import] PQ176 [Local]
Rear Wheel Hub / Stub Axle					



<b>APPLICATIONS</b>	<b>LOCATION</b>	<b>ISUZU KB160</b> 1.6 Fleetside P/up <b>KB200</b> 2.0 LE, Fleetside, D/cab P/up <b>KB220</b> 2.2 LE, P/up <b>KB230</b> 2.3 D/cab P/up	<b>ISUZU 4X4 KB220</b> 2.2 LE P/up <b>KB230</b> 2.3 P/up 4ZD1 <b>KB260</b> 2.6 D/cab, LE, LX <b>KB320</b> 3.2 V6 Frontier LX	<b>ISUZU 4X2</b> <b>KB250D</b> 2.5 Fleetside, LE, D/Cab P/up 4JA1 <b>KB280DT</b> 2.8 D/cab LE, LX, Frontier P/up Turbo 4JB1	<b>ISUZU 4X4</b> <b>KB250D</b> 2.5 LE, D/cab P/up 4JA1 <b>KB280DT</b> 2.8 LE, LX, D/cab P/up Turbo 4JB1
<b>YEARS</b>		<b>89-04</b>	<b>89-04</b>	<b>89-04</b>	<b>89-04</b>
<b>Front Wheel Bearing</b>	- Inner	<b>48510+48</b>	<b>32009</b>	<b>48510+48</b>	<b>32009</b>
	- Outer	<b>12610/49</b>	<b>32008</b>	<b>12610/49</b>	<b>32008</b>
<b>Front Wheel Oil Seal</b>	- Inner	<b>506709</b>	<b>9776</b>	<b>506709</b>	<b>9776</b>
	- Outer				
<b>Front Wheel Kit</b>		<b>PQ346</b>	<b>PQ347</b>	<b>PQ346</b>	<b>PQ347</b>
<b>Front Wheel Hub / Stub Axle</b>		<b>346HUB</b>	<b>347HUB</b>	<b>346HUB</b>	<b>347HUB</b>
<b>Alternator / Generator Bearing</b>	- Front	<b>62022RS</b> [1.6] <b>62032RS</b> [2.0, 2.2, 2.3]	<b>63022RS</b>	<b>6303 2RS</b>	<b>6303 2RS</b>
	- Rear	<b>63022RS</b> or see Pg. I	<b>62022RS</b>	<b>63042RS</b> [Bush 2.5] <b>62022RS</b> [2.8]	<b>63042RS</b> [Bush 2.5] <b>62022RS</b> [2.8]
<b>Concentric / Thurst Bearing</b>		<b>RB9562</b> [160] <b>RB9888</b> [200, 220, 230]	<b>RB9888</b> [220, 230] <b>RB9849</b> [260] <b>RB9848</b> [320]	<b>RB9888</b> [MSG -99] <b>RB9850</b> [MUA -99] <b>RB9605</b> [99-04] <b>RB9849</b> [280]	<b>RB9888</b> [MSG -99] <b>RB9850</b> [MUA -99] <b>RB9605</b> [99-04] <b>RB9849</b> [280]
<b>Diff Carrier Bearing</b>	- Left	<b>501310+49</b>	<b>48510+48</b> [Front axle] <b>501310+49</b> [Rear axle]	<b>501310+49</b> [No Diff Lock] <b>32012</b> [Diff Lock]	<b>48510+48</b> [Front axle] <b>501310+49</b> [Rear axle]
	- Right	<b>501310+49</b>	<b>48510+48</b> [Front axle] <b>501310+49</b> [Rear axle]	<b>501310+49</b> [No Diff Lock] <b>32012</b> [Diff Lock]	<b>48510+48</b> [Front axle] <b>501310+49</b> [Rear axle]
<b>Diff Pinion Bearing</b>	- Front	<b>86610+49</b>	<b>30305</b> [Front axle] <b>86610+49</b> [Rear axle]	<b>86610+49</b>	<b>30305</b> [Front axle] <b>86610+49</b> [Rear axle]
	- Rear	<b>88610+49</b>	<b>02420+75</b> [Fr. 89-91] <b>32307</b> [Fr. 92-] <b>88610+49</b> [Rear axle]	<b>88610+49</b>	<b>02420+75</b> [Fr. 89-91] <b>32307</b> [Fr. 92-04] <b>88610+49</b> [Rear axle]
<b>Propshaft Support Bearing</b>					
<b>Pulley Bearing</b>					
<b>Spigot Shaft Bearing</b>		<b>62032RS</b>	<b>62032RS</b>	<b>62032RS</b>	<b>62032RS</b>
<b>Drive Shaft Oil Seal</b>	- Left				
	- Right				
<b>Gearbox Oil Seal</b>	- Front	<b>9773</b>	<b>9773</b>	<b>9773</b> [2.5] <b>9857</b> [2.8]	<b>9773</b> [2.5] <b>9857</b> [2.8]
	- Rear	<b>9771</b>	<b>9771</b>	<b>9771</b>	<b>9771</b>
<b>Pinion Oil Seal</b>		<b>2738</b>	<b>356513</b> [Fr. axle 2.3] <b>9779</b> [Fr. axle 2.6, 3.2] <b>2738</b> [Rear axle]	<b>2738</b>	<b>356513</b> [Fr. 89-91] <b>9779</b> [Fr. axle 91-04] <b>2738</b> [Rear axle]
<b>Rear Main Bearing Oil Seal</b>		<b>9602</b> [Silicone] <b>9602V</b> [Viton]	<b>9602</b> [Silicone] <b>9602V</b> [Viton 2.2, 2.3, 2.6] <b>9611211</b> [3.2]	<b>9602</b> [Silicone] <b>9602V</b> [Viton]	<b>9602</b> [Silicone] <b>9602V</b> [Viton]
<b>Timing Cover / Cam Oil Seal</b>		<b>9533</b> [Cam] <b>9756</b> [T/cover]	<b>9533</b> [Cam] <b>9756</b> [T/cover 2.2, 2.3, 2.6] <b>425506</b> [T/cover 3.2]	<b>9772</b> [T/cover]	<b>9772</b> [T/cover]
<b>Rear Wheel Bearing</b>	- Inner	<b>U399+360 + 1852119</b>	<b>U399+360 + 1852119</b>	<b>30208</b> [Import] <b>U399+360 + 1852119</b> [Local]	<b>U399+360 + 1852119</b>
	- Outer				
<b>Rear Wheel Oil Seal</b>	- Inner			<b>9764</b> [Import]	
	- Outer	<b>9415</b>	<b>9415</b>	<b>487009</b> [Import] <b>9415</b> [Local]	<b>9415</b>
<b>Rear Wheel Kit</b>		<b>PQ176</b>	<b>PQ176</b>	<b>PQ240</b> [Import] <b>PQ176</b> [Local]	<b>PQ176</b>
<b>Rear Wheel Hub / Stub Axle</b>					

APPLICATIONS	LOCATION	ISUZU KB260 2.6 LE, D/cab, LX P/up 4ZE1 KB320 3.2 LE, D/cab, LX, Frontier, Reef, Blazer P/up 6VD1	ISUZU 4X2 KB200i 2.0 LX KB240i [04-12] 2.4 LX KB250i 2.5 LX	ISUZU 4X4 KB200i 2.0 LX KB240i 2.4 LX, [04-13] KB250i 2.5 LX	ISUZU 4X2 KB250Dc 2.5 KB300TDi 3.0 LX
YEARS		92-04	04-09	04-09	04-09
Front Wheel Bearing	- Inner	48510+48	48510+48 32009XJ	32009 [Non ABS] 32009XJ [ABS]	48510+48 32009XJ
	- Outer	12610/49	12610/49 32008	32008	12610/49 32008
Front Wheel Oil Seal	- Inner	506709	506709 9776	9776	506709 9776
	- Outer				
Front Wheel Kit		PQ346	PQ346 PQ903 [Hi Ride]	PQ347 [Non ABS] PQ903 [ABS]	PQ346 PQ903 [Hi Ride]
Front Wheel Hub / Stub Axle		346HUB	346HUB	347HUB	346HUB
Alternator / Generator Bearing	- Front	62022RS [2.6] 6303 2RS [3.2]			
	- Rear	62022RS			
Concentric / Thurst Bearing		RB9849 [260] RB9848 [320]	RB9677	RB9677	RB9676 RB9677 [KB300]
Diff Carrier Bearing	- Left	501310+49 [No Diff Lock] 32012 [Diff Lock]			
	- Right	501310+49 [No Diff Lock] 32012 [Diff Lock]			
Diff Pinion Bearing	- Front	86610+49			
	- Rear	88610+49			
Propshaft Support Bearing					
Pulley Bearing					
Spigot Shaft Bearing		62032RS			
V-Belt Tensioner					
Drive Shaft Oil Seal	- Left		9563		9563
	- Right		9563		9563
Gearbox Oil Seal	- Front	9857	9773	9773	
	- Rear	9771	9771	9771	
Pinion Oil Seal		2738 [2.6] 9718 [3.2 Blazer only]	9718	9718	9718
Spark Plug Tube Seal					
Rear Main Bearing Oil Seal		9602 [Silicone] 9602V [Viton 2.6] 9611211 [3.2]	9914	9914	9602V
Timing Cover / Cam Oil Seal		9533 [Cam] 9756 [T/cover 2.6] 425506 [T/cover 3.2]	9715 [T/cover]	9715 [T/cover]	9518 [T/cover]
Rear Wheel Bearing	- Inner	U399+360 + 1852119	U399+360 + 1852119A DACRWBISKB + RR60 [ABS Collar]	U399+360 + 1852119A DACRWBISKB + RR60 [ABS Collar]	U399+360 + 1852119A DACRWBISKB + RR60 [ABS Collar] DRT45T6
	- Outer				
Rear Wheel Oil Seal	- Inner				
	- Outer	9415	9415 9563 9564	9415 9563 9564	9415 9563 9564 9560
Rear Wheel Kit		PQ176	PQ176A PQ879	PQ176A PQ879	PQ176A PQ879 PQ1074
Rear Wheel Hub / Stub Axle					

APPLICATIONS		LOCATION	ISUZU 4X4 KB250Dc 2.5 KB300TDi 3.0 LX	ISUZU D-TEQ 4X2 KB300TDi 3.0	ISUZU D-TEQ 4X4 KB300TDi 3.0 D-TEQ	ISUZU RELAY 2.0 P/van, Bus 4ZC1
YEARS			04-09	07-11	07-11	89-95
Front Wheel Bearing	- Inner		32009 [Non ABS] 32009XJ [ABS]	48510+48 32009XJ	32009 [Non ABS]	48510+48
	- Outer		32008	12610/49 32008	32008	12610/49
Front Wheel Oil Seal	- Inner		9776	506709 9776	9776	9603
	- Outer					
Front Wheel Kit			PQ347 [Non ABS] PQ903 [ABS]	PQ346 PQ903 [Hi Ride]	PQ347	PQ243
Front Wheel Hub / Stub Axle			347HUB	346HUB	347HUB	
Alternator / Generator Bearing	- Front					62032RS
	- Rear					62012RS
Concentric / Thurst Bearing			RB9676 RB9677 [KB300TDi]	RB9848	RB9848	RB9562
Diff Carrier Bearing	- Left					501310+49 [Local & Import]
	- Right					501310+49 [Local & Import]
Diff Pinion Bearing	- Front					30306 [Import] 86610+49 [Local]
	- Rear					32307 [Import] 88610+49 [Local]
Propshaft Support Bearing						
Pulley Bearing						
Spigot Shaft Bearing						62032RS
V-Belt Tensioner						
Drive Shaft Oil Seal	- Left		9563			
	- Right		9563			
Gearbox Oil Seal	- Front					9857
	- Rear					9618
Pinion Oil Seal			9718 [KB250Dc]			9616 [Import] 2738 [Local]
Spark Plug Tube Seal						
Rear Main Bearing Oil Seal			9602V	9602V	9602V	9602 [Silicone] 9602V [Viton]
Timing Cover / Cam Oil Seal			9518 [T/cover]	9518 [T/cover]	9518 [T/cover]	304508 [Cam] 9756 [T/cover]
Rear Wheel Bearing	- Inner		U399+360 + 1852119A DACRWBISKB + RR60 [ABS Collar]	DACRWBISKB + RR60 [ABS Collar] DRT45T6	DACRWBISKB + RR60 [ABS Collar]	30208 [Import] U399+360 + 1852119 [Local]
	- Outer					
Rear Wheel Oil Seal	- Inner					9764 [Import]
	- Outer		9415 9563 9564	9563 9564 9560	9563 9564	487009 [Import] 9415 [Local]
Rear Wheel Kit			PQ176A PQ879	PQ879 PQ1074	PQ879	PQ240 [Import] PQ176 [Local]
Rear Wheel Hub / Stub Axle						

APPLICATIONS	LOCATION	ISUZU WFR	IVECO	IVECO TURBO DAILY
		1.8 11FVX/ 12FVX Bus, P/van 4ZB1		2.3 Turbo 35.10, 35.12
YEARS		83-89		1998-
Front Wheel Bearing	- Inner	48510+48		TRBFWBIV1
	- Outer	12610/49		TRBFWBIV2
Front Wheel Oil Seal	- Inner	9603		
	- Outer			
Front Wheel Kit		PQ243		PQ551
Front Wheel Hub / Stub Axle				
Alternator / Generator Bearing	- Front	63022RS		
	- Rear	62022RS		
Concentric / Thurst Bearing		RB9562		
Diff Carrier Bearing	- Left	102910/49		
	- Right	102910/49		
Diff Pinion Bearing	- Front	32012		
	- Rear	88610+49		
Propshaft Support Bearing				
Pulley Bearing				
Spigot Shaft Bearing		62032RS		
V-Belt Tensioner				
Drive Shaft Oil Seal	- Left			
	- Right			
Gearbox Oil Seal	- Front	9773		
	- Rear	9771		
Pinion Oil Seal		9718		
Spark Plug Tube Seal				
Rear Main Bearing Oil Seal		9602 [Silicone] 9602V [Viton]		9525
Timing Cover / Cam Oil Seal		304506 [Cam] 9756 [T/cover]		9524 [T/cover] 9526 [Cam]
Rear Wheel Bearing	- Inner	U399+360 + 1852119		32011 DACRWBOX2 [Alt.]
	- Outer			
Rear Wheel Oil Seal	- Inner			
	- Outer	9415		
Rear Wheel Kit		PQ176		PQ877 PQ878 [Alt.]
Rear Wheel Hub / Stub Axle				

APPLICATIONS	LOCATION	JEEP CHEROKEE (KJ) 2.4 KJ EDI 2.5CRD KJ R425 2.8CRD KJ ENR 3.7 KJ EKG	JEEP CHEROKEE (KJ) 2.8CRD KJ ENS 3.7 KJ EKG	JEEP COMPASS 2.0 ECN 2.0CRD ECD, ECE 2.4 ED3, ERZ	JEEP GRAND CHEROKEE 2.7CRD ENF 3.0CRD EXL 3.6 ERB 3.7 V6 EKG 4.7 V8 EVC, EVA 5.7 EZB
YEARS		02-08	08-15	2007-	05-12
Front Wheel Bearing	- Inner	HUB285 [RHS] HUB286 [LHS]	HUB280	DAC43FWBDC	HUB288 HUB289 [with integrated ABS sensor] HUB291
	- Outer				
Front Wheel Oil Seal	- Inner	HUB UNIT	HUB UNIT	Sealed Bearing	HUB UNIT
	- Outer				
Front Wheel Kit		PQ862 [RHS] PQ863 [LHS]	PQ946 [5 Studs]	PQ576	PQ952 [5 Studs] PQ953 [ABS] [5 Studs] PQ955 [3.7]
Front Wheel Hub / Stub Axle					
Alternator / Generator Bearing	- Front				
	- Rear				
Concentric / Thurst Bearing		RB9702 [2.4, 2.5, 2.8]	RB9702 [2.8]	Concentric Slave Cylinder	
Diff Carrier Bearing	- Left				
	- Right				
Diff Pinion Bearing	- Front				
	- Rear				
Propshaft Support Bearing					
Pulley Bearing					
Spigot Shaft Bearing					
V-Belt Tensioner					
Drive Shaft Oil Seal	- Left				
	- Right				
Gearbox Oil Seal	- Front				
	- Rear				
Pinion Oil Seal					
Spark Plug Tube Seal					
Rear Main Bearing Oil Seal		9039 [2.4] 9040 [2.8] 9064 [3.7]	9064 [3.7] 9065 [2.8]	8510308 [2.0, 2.4] 9229FS [2.0 CRD]	9064 [3.7, 4.7] 9065 [3.0] 9501 [2.7]
Timing Cover / Cam Oil Seal		354807 [Cam 2.4] 9626 [Cam 2.5, 2.8] 9063 [T/Cover 3.7] 9269 [T/Cover 2.4]	9063 [T/Cover 3.7] 9241 [T/Cover 2.8]	9548 [Cam 2.0 CRD] 9549 [T/Cover 2.0 CRD] 9328 [T/Cover 2.0, 2.4]	9042 [T/Cover 2.7, 3.0] 9063 [T/Cover 3.7, 4.7] 9721 [T/Cover 3.6]
Rear Wheel Bearing	- Inner	1559TS	D/S35	HUB220 [2.0 CRD] [with integrated ABS sensor] HUB287 [2.0, 2.4] [with integrated ABS sensor]	1559TS HUB290 [Gear type ABS] DAC52CHERO
	- Outer				
Rear Wheel Oil Seal	- Inner	CYLINDRICAL ROLLER	CYLINDRICAL ROLLER	HUB UNIT	CYLINDRICAL ROLLER HUB UNIT Sealed Bearing
	- Outer				
Rear Wheel Kit		PQ857	PQ947	PQ577 [2.0 CRD] [5 Studs] PQ951 [2.0, 2.4] [5 Studs] [ID:25mm]	PQ857 PQ954 [5 Studs] PQ956 [3.7]
Rear Wheel Hub / Stub Axle					

APPLICATIONS	LOCATION	JEEP PATRIOT 2.0CRD ECD, ECE 2.4 ED3	JEEP WRANGLER (JK) 2.8CRD JK ENS 3.6 JK ERB 3.8 JK EGT 4.0 TJ S01		
		YEARS	2007-	2002-	
Front Wheel Bearing	- Inner	DAC43FWBDC	HUB293 HUB294 [with integrated ABS sensor]		
	- Outer				
Front Wheel Oil Seal	- Inner	Sealed Bearing	HUB UNIT		
	- Outer				
Front Wheel Kit		PQ576	PQ957 [5 Studs] PQ959 [ABS 2011-] [5 Studs]		
Front Wheel Hub / Stub Axle					
Alternator / Generator Bearing	- Front				
	- Rear				
Concentric / Thurst Bearing		Concentric Slave Cylinder			
Diff Carrier Bearing	- Left				
	- Right				
Diff Pinion Bearing	- Front				
	- Rear				
Propshaft Support Bearing					
Pulley Bearing					
Spigot Shaft Bearing					
V-Belt Tensioner					
Drive Shaft Oil Seal	- Left				
	- Right				
Gearbox Oil Seal	- Front				
	- Rear				
Pinion Oil Seal					
Spark Plug Tube Seal					
Rear Main Bearing Oil Seal		8510308 [2.4] 9229FS [2.0]			
Timing Cover / Cam Oil Seal		9548 [Cam 2.0] 9328 [T/Cover 2.4] 9549 [T/Cover 2.0]			
Rear Wheel Bearing	- Inner	HUB287 [with integrated ABS sensor]	D/S35 D/S44		
	- Outer				
Rear Wheel Oil Seal	- Inner	HUB UNIT	CYLINDRICAL ROLLER		
	- Outer				
Rear Wheel Kit		PQ951 [5 Studs]	PQ947 [ID:43.45mm] PQ958 [ID:39mm]		
Rear Wheel Hub / Stub Axle					

APPLICATIONS	LOCATION	KIA CARENS	KIA CARENS	KIA CARNIVAL	KIA CERATO
		1.8 LS 5 Dr. MPV TBD In-Line	2.0 CVVT 2.0 CRDi	2.5 K55, KRv6 2.9 CRDi J3	1.6 LX G4FC 2.0 CRDi
YEARS		00-03	2008-	00-04	04-08
Front Wheel Bearing	- Inner	DAC428045	DACFWBKC	14585/25	DACFWBYELJ4
	- Outer			15578/20	
Front Wheel Oil Seal	- Inner	Sealed Bearing	Sealed Bearing		Sealed Bearing
	- Outer	9948 [Dust seal]		9669	
Front Wheel Kit		PQ427	PQ686	PQ655	PQ676
Front Wheel Hub / Stub Axle					676HUB
Alternator / Generator Bearing	- Front				
	- Rear				
Concentric / Thurst Bearing		RB9001	RB9699 Concentric Slave Cylinder [2.0CRDi]	RB9589	RB9004
Diff Carrier Bearing	- Left	32008		501310/49 [Man. 2.5] 32006 [Auto. 2.5] 32009 [2.9]	
	- Right	32008		501310/49 [Man. 2.5] 32006 [Auto. 2.5] 32009 [2.9]	
Diff Pinion Bearing	- Front				
	- Rear				
Propshaft Support Bearing					
Pulley Bearing					
Spigot Shaft Bearing					
V-Belt Tensioner					
Drive Shaft Oil Seal	- Left	9654			
	- Right	9654			
Gearbox Oil Seal	- Front	9857		9857	
	- Rear				
Pinion Oil Seal					
Spark Plug Tube Seal					
Rear Main Bearing Oil Seal		9221		9996	9041 [1.6] 9837 [2.0]
Timing Cover / Cam Oil Seal		9666 [T/Cover]		9666 [T/Cover]	9066 [T/Cover 1.6] 9836 [T/Cover 2.0]
Rear Wheel Bearing	- Inner	HUB092 [Gear type ABS]	HUB188	HUB093	HUB244 [Gear type ABS]
	- Outer				
Rear Wheel Oil Seal	- Inner	HUB UNIT	HUB UNIT	HUB UNIT	HUB UNIT
	- Outer				
Rear Wheel Kit		PQ654 [4 Studs]	PQ873	PQ656	PQ774 [4 Studs]
Rear Wheel Hub / Stub Axle					



APPLICATIONS	LOCATION	KIA CERATO	KIA CLARUS	KIA K2500i	KIA K2700i
		1.6 LX G4FC 2.0 G4KD	2.0 GLX 4 Dr. Sedan FE	2.5i D4CB	2.7D Workhorse LWB Dies."Bakkie" D/S
YEARS		2008-	98-01	2013-	2004-
Front Wheel Bearing	- Inner	DACFWBHY130	40BWD06	14276+14138A	14276+14138A
	- Outer			32205	30205
Front Wheel Oil Seal	- Inner	Sealed Bearing	Sealed Bearing		
	- Outer			9216	9216
Front Wheel Kit		PQ767	PQ471	PQ1135	PQ680
Front Wheel Hub / Stub Axle		767HUB			680HUB
Alternator / Generator Bearing	- Front				
	- Rear				
Concentric / Thurst Bearing		RB9004	RB9589	RB9698	RB9678
Diff Carrier Bearing	- Left				
	- Right				
Diff Pinion Bearing	- Front				
	- Rear				
Propshaft Support Bearing					
Pulley Bearing					
Spigot Shaft Bearing					
V-Belt Tensioner					
Drive Shaft Oil Seal	- Left		9654		
	- Right		9654		
Gearbox Oil Seal	- Front		9857		
	- Rear				
Pinion Oil Seal					
Spark Plug Tube Seal					
Rear Main Bearing Oil Seal		8510308 [1.6 13-, 2.0] 9041 [1.6 G4FC]	9667		9667
Timing Cover / Cam Oil Seal		9066 [T/Cover 1.6 G4FC] 9328 [T/Cover 1.6 13-, 2.0]	9666 [T/Cover]		9995 [T/Cover]
Rear Wheel Bearing	- Inner	HUB295 [with integrated ABS sensor]	HUB053-41 [Gear type ABS]	32009	32009
	- Outer			32009	32009
Rear Wheel Oil Seal	- Inner	HUB UNIT	HUB UNIT		
	- Outer			9225	9225
Rear Wheel Kit		PQ960 [5 Studs]	PQ642 [4 Studs]	PQ769	PQ769
Rear Wheel Hub / Stub Axle					

APPLICATIONS	LOCATION	KIA OPTIMA	KIA PICANTO	KIA PICANTO	KIA PICANTO
		2.4 G4KJ	1.1 LX, EX 5 Dr. H/back G4HG	1.0 G3LA 1.2 G4LA	1.0 G3LA, G3LD 1.2 G4LA
YEARS		12-14	04-11	11-17	2017-
Front Wheel Bearing	- Inner	DACHYTUC1	DAC387037	DAC36PIC	DAC38RIO
	- Outer				
Front Wheel Oil Seal	- Inner	Sealed Bearing	Sealed Bearing	Sealed Bearing	Sealed Bearing
	- Outer				
Front Wheel Kit		PQ583 [ID:45mm]	PQ422	PQ948	PQ963
Front Wheel Hub / Stub Axle		583BHUB	422AHUB [25 Spline] 422CHUB [24 Spline]	948HUB	422BHUB [25 Spline] [OD: 123mm]
Alternator / Generator Bearing	- Front				
	- Rear				
Concentric / Thurst Bearing			RB9679	RB9679	RB9679
Diff Carrier Bearing	- Left				
	- Right				
Diff Pinion Bearing	- Front				
	- Rear				
Propshaft Support Bearing					
Pulley Bearing					
Spigot Shaft Bearing					
V-Belt Tensioner					
Drive Shaft Oil Seal	- Left		9622		9654
	- Right		9622		9654
Gearbox Oil Seal	- Front				
	- Rear				
Pinion Oil Seal					
Spark Plug Tube Seal					
Rear Main Bearing Oil Seal		8510308	9207		9039
Timing Cover / Cam Oil Seal		9328 [T/Cover]	9627 [Cam] 9209 [T/Cover]	9666 [T/Cover 1.2]	9666
Rear Wheel Bearing	- Inner	HUB235 [Ladder Type ABS] [Flange Ø: 148mm]	HUB104 [Non ABS] HUB186 [with integrated ABS sensor]	HUB241 [1.2][Gear type ABS] [Flange Ø: 132mm] HUB297 [1.0][Non ABS]	HUB421 [With integrated ABS sensor]
	- Outer				
Rear Wheel Oil Seal	- Inner	HUB UNIT	HUB UNIT	HUB UNIT	HUB UNIT
	- Outer				
Rear Wheel Kit		PQ770 [5 Studs]	PQ777 [4 Studs] PQ870 [4 Studs]	PQ697 [1.2] [ABS] PQ962 [1.0] [Non ABS]	PQ1157
Rear Wheel Hub / Stub Axle					

APPLICATIONS	LOCATION	KIA PRIDE	KIA RIO II (JB)	KIA RIO III (UB)	KIA RIO IV (YB)
		1.3i LX 5 Dr. H/back  RIO I 1.3 5 Dr. H/back A3E 1.5 5 Dr. H/back A5D	1.4 High, A5D 1.6 Sport G4ED	1.2 CVVT G4LA 1.4 G4FA	1.2 G4LA 1.4 G4LC
YEARS		98-04	04-11	11-18	2018-
Front Wheel Bearing	- Inner	69310+49	DAC387037	DAC387037 DAC38RIO	DAC387437ABS
	- Outer	69310+49			
Front Wheel Oil Seal	- Inner	9444	Sealed Bearing	Sealed Bearing	Sealed Bearing
	- Outer	9445			
Front Wheel Kit		PQ184N	PQ422	PQ422 [OD:70mm] PQ963 [OD:72mm]	PQ1143
Front Wheel Hub / Stub Axle		184NHUB SA184NL/R	422AHUB	422AHUB	422BHUB [25 Spline] [OD: 123mm]
Alternator / Generator Bearing	- Front				
	- Rear				
Concentric / Thurst Bearing		RB9588A [Rio] RB9820 [Pride]	RB9002	RB9004 [1.4] RB9679 [1.2]	RB9679
Diff Carrier Bearing	- Left	32008 [Pride] 68111/49 [Rio]			
	- Right	32008 [Pride] 68111/49 [Rio]			
Diff Pinion Bearing	- Front				
	- Rear				
Propshaft Support Bearing					
Pulley Bearing					
Spigot Shaft Bearing					
V-Belt Tensioner					
Drive Shaft Oil Seal	- Left	9654			9622
	- Right	9654			9622
Gearbox Oil Seal	- Front	244008			
	- Rear				
Pinion Oil Seal					
Spark Plug Tube Seal					
Rear Main Bearing Oil Seal		9742	9426	9041 [1.4]	9039
Timing Cover / Cam Oil Seal		9682 [Cam & T/Cover 1.3] 345207 [T/Cover 1.4, 1.5]	9666 354807 [T/Cover]	9066 [T/Cover 1.4] 9666 [T/Cover 1.2]	9666
Rear Wheel Bearing	- Inner	44610/49	HUB189 [Non ABS] HUB186 [with integrated ABS sensor]	HUB241 [Gear type ABS] [Flange Ø: 132mm]	HUB409
	- Outer	11710/49 [Pride] 11910/49 [Rio]			
Rear Wheel Oil Seal	- Inner		HUB UNIT	HUB UNIT	HUB UNIT
	- Outer	9447			
Rear Wheel Kit		PQ156 [Pride] PQ217 [Rio]	PQ874 [Non ABS] PQ870 [4 Studs]	PQ697	PQ1141
Rear Wheel Hub / Stub Axle					

APPLICATIONS	LOCATION	KIA SEDONA	KIA SEPHIA	KIA SHUMA I	KIA SORENTO
		2.2 CRDi D4HB 2.5 2.9 CRDi J3 3.8 KV6	1.5i LS, RS 4 Dr. Sedan BFD	1.5i LS 4 Dr. Sedan BFD 1.8i GS 5 Dr. H/back TBD	4X2, 4X4 2.5 CRDi D4CB 3.5 V6 G6DC 3.8 V6
YEARS		04-13	04-05	98-01	03-10
Front Wheel Bearing	- Inner	HUB298 [Non ABS]	40BWD06	40BWD06	DAC427639 [2.5]
	- Outer				
Front Wheel Oil Seal	- Inner	HUB UNIT	Sealed Bearing	Sealed Bearing	Sealed Bearing
	- Outer		9948	9948	
Front Wheel Kit		PQ964 [6 Studs]	PQ471	PQ471	PQ965 [2.5]
Front Wheel Hub / Stub Axle					
Alternator / Generator Bearing	- Front				
	- Rear				
Concentric / Thurst Bearing			RB9589	RB9589	RB9698
Diff Carrier Bearing	- Left			32008	
	- Right		69310+49	32008	
Diff Pinion Bearing	- Front		69310+49		
	- Rear				
Propshaft Support Bearing					
Pulley Bearing					
Spigot Shaft Bearing					
V-Belt Tensioner					
Drive Shaft Oil Seal	- Left		9654	9654	
	- Right		9654	9654	
Gearbox Oil Seal	- Front		244008	9757	
	- Rear				
Pinion Oil Seal					
Spark Plug Tube Seal					
Rear Main Bearing Oil Seal			9742	9742	9067
Timing Cover / Cam Oil Seal			345207 [T/Cover]	345207 [T/Cover 1.5] 9682 [T/Cover 1.8]	9068 [T/Cover]
Rear Wheel Bearing	- Inner	HUB296 [Gear type ABS]	HUB076 [Non ABS] HUB077 [Gear type ABS]	HUB076 [Non ABS] HUB091 [Gear type ABS]	DAC40SOR
	- Outer				
Rear Wheel Oil Seal	- Inner	HUB UNIT	HUB UNIT	HUB UNIT	Sealed Bearing
	- Outer				
Rear Wheel Kit		PQ961 [6 Studs]	PQ582 [4 Studs] PQ584 [4 Studs]	PQ582 [4 Studs] PQ652 [4 Studs]	PQ966 [2.5]
Rear Wheel Hub / Stub Axle					

APPLICATIONS	LOCATION	KIA SORENTO 4X2, 4X4 2.2 D4HB 2.4 3.5 V6 G6DC	KIA SOUL 1.6 G4FC 1.6 CRDi D4FB 2.0 G4KD	KIA SPECTRA 1.6 Exec. A6	KIA SPORTAGE JA 4X4 2.0 SUV 5 Spd. FE Pet.
		YEARS	2006-	2009-	01-03
Front Wheel Bearing	- Inner	<b>HUB236</b> [with integrated ABS sensor] [2.2 4X4]	<b>DACFWBHYI30</b>	<b>40BWD06</b> <b>DAC428045</b>	<b>102910+49</b>
	- Outer				<b>69310+49</b>
Front Wheel Oil Seal	- Inner	HUB UNIT	Sealed Bearing	Sealed Bearing	<b>9543</b>
	- Outer			<b>9948</b>	<b>9544</b>
Front Wheel Kit		<b>PQ805</b> [2.2 4X4]	<b>PQ767</b>	<b>PQ471</b> [ID: 40mm] <b>PQ427</b> [ID: 42mm]	<b>PQ888</b>
Front Wheel Hub / Stub Axle					
Alternator / Generator Bearing	- Front				
	- Rear				
Concentric / Thurst Bearing		<b>Concentric Slave Cylinder</b>	<b>RB9004</b>	<b>RB9002</b>	<b>RB9856</b>
Diff Carrier Bearing	- Left			<b>69310+49</b>	<b>32008</b> [Fr. axle] <b>102910+49</b> [Rr. axle]
	- Right			<b>69310+49</b>	<b>32008</b> [Fr. axle] <b>102910+49</b> [Rr. axle]
Diff Pinion Bearing	- Front				<b>32207</b> [Fr. axle] <b>86610+49</b> [Rr. axle]
	- Rear				<b>32206</b> [Fr. axle] <b>802011+48</b> [Rr. axle]
Propshaft Support Bearing					
Pulley Bearing					
Spigot Shaft Bearing					
V-Belt Tensioner					
Drive Shaft Oil Seal	- Left			<b>9654</b>	<b>9654</b>
	- Right			<b>9654</b>	<b>9654</b>
Gearbox Oil Seal	- Front			<b>9757</b>	<b>9857</b>
	- Rear				
Pinion Oil Seal					<b>9832</b> [Fr. axle] <b>2738</b> [Rr. axle]
Spark Plug Tube Seal					
Rear Main Bearing Oil Seal		<b>9070</b> [2.2]	<b>9041</b> [1.6] <b>9268</b> [1.6CRDi] <b>8510308</b> [2.0]	<b>9742</b>	
Timing Cover / Cam Oil Seal		<b>9069</b> [T/Cover 2.2]	<b>425307</b> [T/Cover 1.6CRDi] <b>9066</b> [T/Cover 1.6] <b>9328</b> [T/Cover 2.0]	<b>345207</b> [T/Cover]	<b>9666</b> [T/Cover]
Rear Wheel Bearing	- Inner	<b>HUB236</b> [with integrated ABS sensor] [2.2 4X4] <b>HUB237</b> [with integrated ABS sensor]	<b>HUB301</b> <b>HUB388</b> [with integrated ABS sensor]	<b>HUB076</b> [Non ABS] <b>HUB091</b> [Gear type ABS]	<b>U399+360 + 1852119</b>
	- Outer				
Rear Wheel Oil Seal	- Inner	HUB UNIT	HUB UNIT	HUB UNIT	
	- Outer				<b>9415</b>
Rear Wheel Kit		<b>PQ805</b> [2.2 4X4] <b>PQ806</b> [2.2 4X2]	<b>PQ1060</b> <b>PQ1112</b> [1.6 2014-]	<b>PQ582</b> [4 Studs] <b>PQ652</b> [4 Studs]	<b>PQ176</b>
Rear Wheel Hub / Stub Axle					

APPLICATIONS	LOCATION	KIA SPORTAGE JE 4X2, 4X4 2.0 SUV G4GC 2.0 CRDi SUV D4EA 2.7 V6 SUV G6BA	KIA SPORTAGE SL 4X2, 4X4 2.0 SUV G4NC 2.0 CRDi D4HA 2.4 G4KE	KIA SPORTAGE IV QL, QLE 4X2, 4X4 1.6 TGD I G4FJ 2.0 G4NA 2.0 CRDi G4HA 2.4 Gdi G4KJ	
		YEARS	04-10	10-15	2015-
Front Wheel Bearing	- Inner	DACHYTUC1	DACHYTUC1	HUB236 [With integrated ABS sensor]	
	- Outer				
Front Wheel Oil Seal	- Inner	Sealed Bearing	Sealed Bearing	HUB UNIT	
	- Outer				
Front Wheel Kit		PQ583	PQ583	PQ805	
Front Wheel Hub / Stub Axle		583BHUB	583BHUB 583CHUB		
Alternator / Generator Bearing	- Front				
	- Rear				
Concentric / Thurst Bearing		RB9699 Concentric Slave Cylinder [Alt.] [4X4]	RB9004 [2.0]	RB9004 [1.6, 2.0]	
Diff Carrier Bearing	- Left				
	- Right				
Diff Pinion Bearing	- Front				
	- Rear				
Propshaft Support Bearing					
Pulley Bearing					
Spigot Shaft Bearing					
V-Belt Tensioner					
Drive Shaft Oil Seal	- Left				
	- Right				
Gearbox Oil Seal	- Front				
	- Rear				
Pinion Oil Seal					
Spark Plug Tube Seal					
Rear Main Bearing Oil Seal		9268 [2.0CRDi, 2.7] 9620 [2.0]	9070 [T/Cover 2.0] 8510308 [2.4]	9041 [1.6]	
Timing Cover / Cam Oil Seal		304208 [Cam 2.7] 355007 [Cam 2.0] 365007 [Cam 2.0CRDi] 355008 [T/Cover 2.0] 9054 [T/Cover 2.7] 9269 [T/Cover 2.0CRDi]	9069 [T/Cover 2.0] 9328 [T/Cover 2.4]	9066 [1.6]	
Rear Wheel Bearing	- Inner	DAC427639 [4X4] HUB135 [Gear type ABS]	DAC427639 [4X4] HUB235 [Ladder Type ABS] [Flange Ø: 148mm]	HUB417 [With integrated ABS sensor] HUB418	
	- Outer				
Rear Wheel Oil Seal	- Inner	Sealed Bearing HUB UNIT	Sealed Bearing HUB UNIT	HUB UNIT	
	- Outer				
Rear Wheel Kit		PQ521 [4X4] PQ788 [5 Studs]	PQ521 [4X4] PQ770 [5 Studs]	PQ1153 [OD: 143mm] PQ1154 [OD: 139mm] [27 Spline]	
Rear Wheel Hub / Stub Axle		521HUB [4X4]			

APPLICATIONS	LOCATION	LAND ROVER 110 SERIES II, IIA, III	LAND ROVER DEFENDER 90	LAND ROVER DEFENDER 90	LAND ROVER DEFENDER 130
		2.6 LWB P/up 6 Cyl. OHI SE Pet. 3.5 LWB "PUP" P/up V8 ADE236 Pet.	2.5 TDi Country 2.8i CSW S/W 3.5 CSW S/W DEFENDER 110 2.5 TD, i TD5 Storm 2.8, i CSW S/W 3.5 CSW S/W	2.2 TD 2.4 TD 2.5 TD5 DEFENDER 110 2.2 TD 2.5 TD, i	2.5TD, i TD5 Storm 3.5 CSW S/W DISCOVERY 2.5TD, i TD5 ES, GS, XS, S S/W 3.5 P/up, S/W 3.9i ES, S P/up, S/W
YEARS		84-96	89-04	2002-	89-04
Front Wheel Bearing	- Inner	2107+212	603011+49	603011+49	603011+49
	- Outer	603011+49	603011+49	603011+49	603011+49
Front Wheel Oil Seal	- Inner		9953	9953	9953
	- Outer		9953	9953	9953
Front Wheel Kit			PQ245	PQ245	PQ245
Front Wheel Hub / Stub Axle					
Alternator / Generator Bearing	- Front				
	- Rear	6202 ZZ			
Concentric / Thurst Bearing		RB9544 [III]	RB9544	Concentric Slave Cylinder RB9544 [2.5]	RB9544
Diff Carrier Bearing	- Left	501310+49 [Front & Rear axle]			
	- Right	501310+49 [Front & Rear axle]			
Diff Pinion Bearing	- Front	803110+46 [Fr. axle] 88610+49 [Rr. axle]			
	- Rear	88610+49 [Fr. axle] 803110+46 [Rr. axle]			
Propshaft Support Bearing					
Pulley Bearing					
Spigot Shaft Bearing					
V-Belt Tensioner					
Drive Shaft Oil Seal	- Left				
	- Right				
Gearbox Oil Seal	- Front	355010	9976 [No.1] 315110 [No.2]		9976 [No.1] 315110 [No.2]
	- Rear	355010			
Pinion Oil Seal		S1128 [Front axle] S2625 [Rear axle]			
Spark Plug Tube Seal					
Rear Main Bearing Oil Seal		9752 [2.6] 8259913 [3.5]		9071FS [2.5 "90"] 9061FS [2.2, 2.4] 9073FS [2.5 "110"]	
Timing Cover / Cam Oil Seal		1373 [T/cover 3.5] 2318 [T/cover 2.6]		365007 [Cam 2.2, 2.4] 405607 [Cam 2.5 Tdi Alt.] 9802 [Cam 2.5 Tdi] 9072 [T/cover 2.5 Td] 9561 [T/cover 2.2, 2.4]	
Rear Wheel Bearing	- Inner	603011+49	603011+49	603011+49	603011+49
	- Outer	603011+49	603011+49	603011+49	603011+49
Rear Wheel Oil Seal	- Inner	9953	9953	9953	9953
	- Outer	9953	9953	9953	9953
Rear Wheel Kit		PQ245	PQ245	PQ245	PQ245
Rear Wheel Hub / Stub Axle					



APPLICATIONS	LOCATION	LAND ROVER DEFENDER 130	LAND ROVER DISCOVERY II	LAND ROVER DISCOVERY III	LAND ROVER FREELANDER
		2.2 TD 2.4 TD 2.5 TD5	2.5 TD5 4.0 V8	2.5 TD V6 2.7 TD V6 4.0 V6 4.4 V8 DISCOVERY IV 3.0D V6 3.0SD V6 3.0TD V6 5.0 V8 5.0P V8	1.8i S/W Pet. 2.0 Di S/W, Td4 SUV Pet. 2.5 V6 SUV KV6 Pet.
YEARS		2002-	99-05	05-09	98-04
Front Wheel Bearing	- Inner	603011+49	HUB299 [with integrated ABS sensor]	HUB302	40246 [Non ASB] 40246ASB [ASB]
	- Outer	603011+49			
Front Wheel Oil Seal	- Inner	9953	HUB UNIT	HUB UNIT	
	- Outer	9953			
Front Wheel Kit		PQ245	PQ967	PQ969	PQ504 [Non ASB] PQ504ASB [ASB]
Front Wheel Hub / Stub Axle					
Alternator / Generator Bearing	- Front				
	- Rear				
Concentric / Thurst Bearing		Concentric Slave Cylinder RB9544 [2.5]	RB9544	Concentric Slave Cylinder [Discovery III]	Concentric Slave Cylinder
Diff Carrier Bearing	- Left				501310+49 [Man.] 32006 [Auto.]
	- Right				501310+49 [Man.] 32006 [Auto.]
Diff Pinion Bearing	- Front				32207 [Fr. axle] 86610+49 [Rr. axle]
	- Rear				32206 [Fr. axle] 802011+48 [Rr. axle]
Propshaft Support Bearing					
Pulley Bearing					
Spigot Shaft Bearing					
V-Belt Tensioner					
Drive Shaft Oil Seal	- Left				
	- Right				
Gearbox Oil Seal	- Front				9857
	- Rear				
Pinion Oil Seal					
Spark Plug Tube Seal					
Rear Main Bearing Oil Seal		9061FS [2.2, 2.4]	9071FS [2.5] 9074 [4.0]	9077FS [2.7TD]	9667 [1.8, 2.0] 9996 [2.5]
Timing Cover / Cam Oil Seal		9561 [2.2, 2.4]	9072 [T/Cover 2.5] 9075 [T/Cover 4.0]	9076 [Cam] [2.7TD] 9550 [T/Cover] [2.7TD]	9666 [T/Cover]
Rear Wheel Bearing	- Inner	603011+49	HUB300 [with integrated ABS sensor]	DAC50DISC	40246 [Non ABS] 40246ASB [ASB]
	- Outer	603011+49			
Rear Wheel Oil Seal	- Inner	9953	HUB UNIT	Sealed Bearing	
	- Outer	9953			
Rear Wheel Kit		PQ245	PQ968	PQ970	PQ504 [Non ABS] PQ504ASB [ASB]
Rear Wheel Hub / Stub Axle					971HUB

APPLICATIONS	LOCATION	LAND ROVER FREELANDER II	LAND ROVER RANGE ROVER	LAND ROVER RANGE ROVER	LAND ROVER RANGE ROVER EVOQUE
		2.0 2.2 D 2.2 TD4 3.2 V6	3.5 V8, Vogue S/W Pet. 4.6 V8 HSE S/W Pet.	3.0TD 3.6 D V8 3.6 TD 4.2 V8 4.4 V8 4.4D V8 5.0 V8	2.0 Si4 2.2 Sd4
YEARS		07-10	79-86 [3.5] 96-04 [4.6]	2002-	2011-
Front Wheel Bearing	- Inner	HUB303 [with integrated ABS sensor]	603011+49	DAC51RANGE	DAC51RANGE
	- Outer		603011+49		
Front Wheel Oil Seal	- Inner	HUB UNIT	9953	Sealed Bearing	Sealed Bearing
	- Outer		9953		
Front Wheel Kit		PQ972	PQ245	PQ973	PQ973
Front Wheel Hub / Stub Axle					
Alternator / Generator Bearing	- Front				
	- Rear				
Concentric / Thurst Bearing		Concentric Slave Cylinder	RB9544		
Diff Carrier Bearing	- Left		501310+49 [Front & Rear axle]		
	- Right		501310+49 [Front & Rear axle]		
Diff Pinion Bearing	- Front		803110+46 [Fr. axle] 88610+49 [Rr. axle]		
	- Rear		88610+49 [Fr. axle] 803110+46 [Rr. axle]		
Propshaft Support Bearing					
Pulley Bearing					
Spigot Shaft Bearing					
V-Belt Tensioner					
Drive Shaft Oil Seal	- Left				
	- Right				
Gearbox Oil Seal	- Front				
	- Rear				
Pinion Oil Seal					
Spark Plug Tube Seal					
Rear Main Bearing Oil Seal		9979 [2.2]	8259913		
Timing Cover / Cam Oil Seal		9055 [Cam 2.2] 9056 [T/Cover 2.2]	1373 [T/cover]		
Rear Wheel Bearing	- Inner	40246ASB [ASB]	603011+49	DAC51RANGE	DAC48EVOQ
	- Outer		603011+49		
Rear Wheel Oil Seal	- Inner	Sealed Bearing	9953	Sealed Bearing	Sealed Bearing
	- Outer		9953		
Rear Wheel Kit		PQ504ASB [ASB]	PQ245	PQ973	PQ974
Rear Wheel Hub / Stub Axle		971HUB [2.2D, TD4]			

APPLICATIONS	LOCATION	LAND ROVER RANGE ROVER SPORT 3.0 D V6 3.0 TD 3.6 V8 3.6 TD V8 4.2 4.4 V8 5.0 V8	LEXUS GS, IS 200 250 300 350 450	LEXUS RX 300 350 400 450
		YEARS	2005-	2002-
Front Wheel Bearing	- Inner	HUB302	DAC32LEX [02-05] DAC49LEX [300 02-05] HUB304 [06-13]	45BWDVER
	- Outer			
Front Wheel Oil Seal	- Inner	HUB UNIT	Sealed Bearing HUB UNIT	Sealed Bearing
	- Outer			
Front Wheel Kit		PQ969	PQ975 [02-05] PQ976 [300 02-05] PQ977L/R [06-13]	PQ792
Front Wheel Hub / Stub Axle				
Alternator / Generator Bearing	- Front			
	- Rear			
Concentric / Thurst Bearing				
Diff Carrier Bearing	- Left			
	- Right			
Diff Pinion Bearing	- Front			
	- Rear			
Propshaft Support Bearing				
Pulley Bearing				
Spigot Shaft Bearing				
V-Belt Tensioner				
Drive Shaft Oil Seal	- Left			
	- Right			
Gearbox Oil Seal	- Front			
	- Rear			
Pinion Oil Seal				
Spark Plug Tube Seal				
Rear Main Bearing Oil Seal				
Timing Cover / Cam Oil Seal				
Rear Wheel Bearing	- Inner	DAC50DISC	DAC35LEX [02-05] DAC49LEX [02-05] HUB305 [06-13]	HUB306
	- Outer			
Rear Wheel Oil Seal	- Inner	Sealed Bearing	Sealed Bearing HUB UNIT	HUB UNIT
	- Outer			
Rear Wheel Kit		PQ970	PQ975 [02-05] PQ979 [02-05] PQ978 [06-13]	PQ980
Rear Wheel Hub / Stub Axle				

LEXUS

APPLICATIONS		LOCATION	MAHINDRA BOLERO 4X2, 4X4 2.5 TD XD3 2.5 TD NEF	MAHINDRA KUV100 1.2 CRD D75 Dies. 1.2 G80 Pet.	MAHINDRA SCORPIO 4X2, 4X4 2.0 2.2 2.2 CRDE 2.5 NEF 2.6 Turbo 2.6 TD /CRDE	MAHINDRA SCORPIO PICK/UP 2.2 CRDE 2.5 2.5 TD 2.5 NEF Tci
YEARS			2005-	2016-	2005-	2006-
Front Wheel Bearing	- Inner		501310+349		501310+349	501310+349
	- Outer		25520+25590		25520+25590	25520+25590
Front Wheel Oil Seal	- Inner		9078		9078	9078
	- Outer					
Front Wheel Kit			PQ981	PQ622	PQ981	PQ981
Front Wheel Hub / Stub Axle			981HUB			
Alternator / Generator Bearing	- Front					
	- Rear					
Concentric / Thurst Bearing						Concentric Slave Cylinder
Diff Carrier Bearing	- Left					
	- Right					
Diff Pinion Bearing	- Front					
	- Rear					
Propshaft Support Bearing						
Pulley Bearing						
Spigot Shaft Bearing						
V-Belt Tensioner						
Drive Shaft Oil Seal	- Left					
	- Right					
Gearbox Oil Seal	- Front					
	- Rear					
Pinion Oil Seal						
Spark Plug Tube Seal						
Rear Main Bearing Oil Seal						
Timing Cover / Cam Oil Seal						
Rear Wheel Bearing	- Inner					
	- Outer				U497/460 + RR21	U497/460 + RR21
Rear Wheel Oil Seal	- Inner					
	- Outer				9502	9502
Rear Wheel Kit					PQ1076	PQ1076
Rear Wheel Hub / Stub Axle						

APPLICATIONS	LOCATION	MAZDA 121 SOHO 1.3, i 3/5 Dr. H/back Endura-EM5 1.4i 3/5 Dr. H/back Zetec CVH/PTE	MAZDA 2 (DE) 1.3 Active, Dynamic 1.5 Dynamic, Individual	MAZDA 2 (DL) 1.5 P5-VPS, P5Y4, P5Y6 1.5D S5Y2, S5Y5, S5Y6, S5Y7, S5Y8	MAZDA 3 (BL, BK) 1.6 Original, Active, Dynamic B6ZE, Z6 2.0 Individual LF17 2.0 BN Series 2.3 2.3 MPS L6KG 2.5 L5-VE
YEARS		97-99	07-15	2015-	04-14
Front Wheel Bearing	- Inner	309639	309639ASB	HUB372 [with integrated ABS sensor]	DACMA5 HUB204 [Some] [with integrated ABS sensor] HUB366 [2.3MPS] [All Wheel Drive] HUB381 [with integrated ABS sensor]
	- Outer				
Front Wheel Oil Seal	- Inner	Sealed Bearing	Sealed Bearing	HUB UNIT	Sealed Bearing HUB UNIT
	- Outer				
Front Wheel Kit		PQ106	PQ499 [ASB]	PQ1087	PQ795 PQ899 [PCD: 114mm][5 Studs] PQ1075 [2.3MPS][All Wheel Drive] PQ1103
Front Wheel Hub / Stub Axle		106FHUB	499AHUB [PCD: 108mm] 499BHUB [PCD: 100mm]		795HUB
Alternator / Generator Bearing	- Front				
	- Rear				
Concentric / Thurst Bearing		Concentric Slave Cylinder	Concentric Slave Cylinder		RB9673 RB9701 [2.3, 2.5]
Diff Carrier Bearing	- Left	29710+49			
	- Right	29710+49			
Diff Pinion Bearing	- Front	29711+49			
	- Rear	329149+0017			
Propshaft Support Bearing					
Pulley Bearing					
Spigot Shaft Bearing					
V-Belt Tensioner					
Drive Shaft Oil Seal	- Left	405508	9654	9654	
	- Right	405508	9654	9654	
Gearbox Oil Seal	- Front	9467	284008		9654 [1.6]
	- Rear	405508			
Pinion Oil Seal		9839			
Spark Plug Tube Seal					
Rear Main Bearing Oil Seal		2825 [1.3] 9452 [1.4]	9742		9742 [1.6] 9375FS [2.0]
Timing Cover / Cam Oil Seal		9634 [Cam 1.3] 425607 [Cam 1.4] 355007 [T/Cover 1.4]	9376 [Cam] 9572 [T/Cover]	9376 [Cam]	9378 [T/Cover 2.0] 9572 [T/Cover 1.6] 9390 [T/Cover MPS] 9376 [Cam 1.6]
Rear Wheel Bearing	- Inner	329013	HUB141 [with integrated ABS sensor] HUB203 [with integrated ABS sensor]	HUB373	HUB198 [with integrated ABS sensor] HUB308 [with integrated ABS sensor]
	- Outer	329013			
Rear Wheel Oil Seal	- Inner	9644	HUB UNIT	HUB UNIT	HUB UNIT
	- Outer				
Rear Wheel Kit		PQ418	PQ799 [PCD: 108mm] PQ901 [PCD: 100mm] [4 Studs]	PQ1088	PQ892 [5 Studs] PQ983 [2014-]
Rear Wheel Hub / Stub Axle					

APPLICATIONS	LOCATION	MAZDA 3 (BM, BN) 1.6 Z6Y1 2.0 PEY7, PEX2	MAZDA 323 FWD 1.3 S, H/back, Sedan E3 1.5 GLC, SL, SLX, Sport H/back, Sedan E5	MAZDA 323 FWD 1.3 L, H/back, Sedan E/B3 1.5, L H/back, Sedan E5 1.6 EGi Hatch, L, Sedan, SL Hatch, SL Sedan, Sport Hatch B6i/F6	MAZDA 323 FWD 2.0 EGi Hatch, SLE Hatch, SLi Sedan 200e Hatch, Sedan 200i Hatch 8/16V FE-2000
		YEARS	2014-	81-88	84-91
Front Wheel Bearing	- Inner	HUB381 [with integrated ABS sensor]	69310/45	69310/45	69310/45 40BWD06 [Alt.]
	- Outer		69310/45	69310/45	69310/45
Front Wheel Oil Seal	- Inner	HUB UNIT	9444	9444	9444 Sealed Bearing [Alt.]
	- Outer		9445	9445	9445
Front Wheel Kit		PQ1103	PQ184	PQ184	PQ184 PQ449 [Alt.]
Front Wheel Hub / Stub Axle			184HUB SA184L/R	184HUB SA184L/R	184HUB SA184L/R
Alternator / Generator Bearing	- Front		62032RS	62032RS	62032RS
	- Rear		62012RS	62012RS	62012RS
Concentric / Thurst Bearing			RB9588A	RB9588A RB9589 [1.6]	RB9589
Diff Carrier Bearing	- Left	68111+49 [1.6] MZ62127 [2.0]	68111+49	68111+49	68111+49 [EGi, SLi, SLE] 32008 [e, i]
	- Right	68111+49 [1.6] MZ62127 [2.0]	68111+49	68111+49	68111+49 [EGi, SLi, SLE] 32008 [e, i]
Diff Pinion Bearing	- Front				
	- Rear				
Propshaft Support Bearing					
Pulley Bearing					
Spigot Shaft Bearing			6202ZZ	6202ZZ	6202ZZ
V-Belt Tensioner					
Drive Shaft Oil Seal	- Left	9131 [2.0] 9654 [1.6]	9654	9654	9654
	- Right	9132 [2.0] 9654 [1.6]	9654	9654	9654
Gearbox Oil Seal	- Front		244008	244008	244008
	- Rear		324810		
Pinion Oil Seal					
Spark Plug Tube Seal					
Rear Main Bearing Oil Seal			708812	708812 9742 [1.6]	9742 [SLE] 9667 [Others]
Timing Cover / Cam Oil Seal			405508 [T/Cover]	405508 [T/Cover 84-88] 9666 [T/Cover 89-91] 9682 [T/Cover 85-91]	9666 [Cam x 2 - DOHC] 9870 [T/Cover]
Rear Wheel Bearing	- Inner	HUB308 [with integrated ABS sensor]	44610+49	331274 44610+49 [Some Mod.]	331274
	- Outer		11710+49	11910+49	11910+49
Rear Wheel Oil Seal	- Inner	HUB UNIT			
	- Outer		9447	9447	9447
Rear Wheel Kit		PQ983	PQ156	PQ231L/R PQ217 [Some Mod.]	PQ231L/R
Rear Wheel Hub / Stub Axle				SA231L/R	SA231L/R

APPLICATIONS	LOCATION	MAZDA 323 FWD 130 Hatch, Midge, Sedan, Sting B3 160, i, S Hatch, Midge, Sedan, Sting F6	MAZDA 323 FWD 130 Hatch, Midge, Sedan, Sting B3 160, i, S Hatch, Midge, Sedan, Sting F6 200i, e Hatch 8/16V FE 2000	MAZDA 5 2.0 Original, Active, Individual	MAZDA 6 2.0 Active, Original, Elegant 2.3 Dynamic,Dynamic Individual, Sporty, Sporty Lux 2.3 MPS AWD 2.5 Dynamic Activematic, Individual
YEARS		90-95	95-05	07-14	03-14
Front Wheel Bearing	- Inner	69310/45	69310/45 40BWD06 [Alt.]	DACMA5	DACMA5 45BWDVER
	- Outer	69310/45	69310/45		
Front Wheel Oil Seal	- Inner	9444	9444 Sealed Bearing [Alt.]	Sealed Bearing	Sealed Bearing
	- Outer	9445	9445		
Front Wheel Kit		PQ184	PQ184 PQ449 [Alt.]	PQ795 [ASB]	PQ795 [OD: 80mm] PQ792 [OD: 84mm][MPS]
Front Wheel Hub / Stub Axle		184HUB SA184L/R	184HUB SA184L/R	795HUB	795AHUB
Alternator / Generator Bearing	- Front	62032RS	62032RS		
	- Rear	62012RS	62012RS		
Concentric / Thurst Bearing		RB9820	RB9820	RB9673 RB9701 [6 Speed]	RB9701
Diff Carrier Bearing	- Left	68111+49 [130] 32008 [160]	68111+49 [130, 160] 32008 [2.0]		
	- Right	68111+49 [130] 32008 [160]	68111+49 [130, 160] 32008 [2.0]		
Diff Pinion Bearing	- Front				
	- Rear				
Propshaft Support Bearing					
Pulley Bearing					
Spigot Shaft Bearing		6202ZZ	6202ZZ		
V-Belt Tensioner					
Drive Shaft Oil Seal	- Left	9654	9654		
	- Right	9654	9654		
Gearbox Oil Seal	- Front	244008	244008	9857	9857
	- Rear				
Pinion Oil Seal					
Spark Plug Tube Seal					
Rear Main Bearing Oil Seal		9742 [130] 9667 [160]	9742 [130, 160] 9667 [2.0]	9375FS	9375FS [2.5]
Timing Cover / Cam Oil Seal		9682 [T/Cover 130] 9870 [T/Cover 130 Alt.] 9666 [T/Cover 160]	9682 [T/Cover, Cam 130, 160] 9870 [T/Cover 130 Alt.] 9666 [T/Cover, Cam 2.0 x 2 - DOHC]	9378 [T/Cover 07-10] 9390 [T/Cover 10-14]	9378 [T/Cover 2008-] 9390 [T/Cover 03-08]
Rear Wheel Bearing	- Inner	331274	331274 44610+49 [Some Mod.]	HUB198 [with integrated ABS sensor]	DAC428045 HUB142 [Gear type ABS] HUB350 [with integrated ABS sensor]
	- Outer	11910+49	11910+49		
Rear Wheel Oil Seal	- Inner			HUB UNIT	HUB UNIT
	- Outer	9447	9447 9633 [Some Mod.]		
Rear Wheel Kit		PQ231L/R	PQ217 PQ231L/R [Some Mod.]	PQ892 [5 Studs]	PQ927 [MPS] PQ800 [5 Studs] PQ1046 [2008-] [5 Studs]
Rear Wheel Hub / Stub Axle		SA231L/R	SA231L/R		

APPLICATIONS	LOCATION	MAZDA 6 (GJ)	MAZDA 626	MAZDA 626	MAZDA 626
		2.0 PEY5 [14-16] 2.2D SHY1 [14-17] 2.5 PYY1, PYZA, PYY8 [14-16]	1.6 S Sedan, Hatch F6 1.8 L Sedan, Hatch F8 2.0 SL, SLE, SLX 2.0i EG, SLi FE Rear Drum brakes	2.0i 16V SLi FE Rear Disc brakes	2.0i 16V Medium High, V6 24V High KF/KS 2.5i V6 Exec. KL MX-6 2.5 V6 KL
YEARS		14-17	83-93	89-93	93-98
Front Wheel Bearing	- Inner	HUB307 [with integrated ABS sensor]	309396	309396	DAC428045
	- Outer				
Front Wheel Oil Seal	- Inner	HUB UNIT	Sealed Bearing	Sealed Bearing	Sealed Bearing
	- Outer				9948 [Dust Seal]
Front Wheel Kit		PQ982	PQ139	PQ139	PQ427
Front Wheel Hub / Stub Axle			139HUB	139HUB	427HUB
Alternator / Generator Bearing	- Front		62032RS 63022RS [2.0, 2.0i]	62032RS	B8-85DW
	- Rear		62012RS B8-85D [2.0, 2.0i]	62012RS	B17-102
Concentric / Thurst Bearing			RB9589	RB9589	RB9589
Diff Carrier Bearing	- Left	MZ62127 MZ63127 [2.2D]	32008	32008	32008
	- Right	MZ62127 MZ60127 [2.2D]	32008	32008	32008
Diff Pinion Bearing	- Front				
	- Rear				
Propshaft Support Bearing					
Pulley Bearing					
Spigot Shaft Bearing			6202ZZ	6202ZZ	
V-Belt Tensioner					
Drive Shaft Oil Seal	- Left	9131	9654	9654	9654 [Diff Seal]
	- Right	9132	9654	9654	9654 [Diff Seal]
Gearbox Oil Seal	- Front		274308	274308	345007
	- Rear				274206
Pinion Oil Seal					
Spark Plug Tube Seal					
Rear Main Bearing Oil Seal			9667 [2.0, 2.0i] 9669	9667	9667 [2.0] 9935 [2.5]
Timing Cover / Cam Oil Seal			9666 [Cam, T/Cover, Crank Fr. 1.8, 2.0, 2.0i]	9666 [Cam, T/Cover]	9572 [T/cover] 9682 [Cam 2.5]
Rear Wheel Bearing	- Inner	HUB308 [with integrated ABS sensor]	44610+49	30KWD01A	HUB066-39 [Non ABS] HUB066-40 [Gear type ABS]
	- Outer		11910+49		
Rear Wheel Oil Seal	- Inner	HUB UNIT			HUB UNIT
	- Outer		9663	9833	
Rear Wheel Kit		PQ983	PQ144	PQ403	PQ425 [5 Studs] PQ426 [5 Studs]
Rear Wheel Hub / Stub Axle					



APPLICATIONS	LOCATION	MAZDA 626 2.0 S/W, Sedan FE	MAZDA Astina 180 Se Hatch BPi	MAZDA B-SERIES B1600 1.6 SWB Magnum P/up F6 Pet. B1800 1.8 SWB/LWB Magnum, Drifter P/up F8 Pet.	MAZDA B-SERIES B2000 2.0 SWB P/up MA Pet. B2200 2.2 SWB/LWB P/up S2 Dies.
		YEARS	98-03	95-00	86-00
Front Wheel Bearing	- Inner	40BWD06A	40BWD06A	48510/48	30206
	- Outer			30205	30204
Front Wheel Oil Seal	- Inner	Sealed Bearing	Sealed Bearing	9669	456505
	- Outer	9948 [Dust Seal]	9948 [Dust Seal]		
Front Wheel Kit		PQ471	PQ471	PQ234	PQ177
Front Wheel Hub / Stub Axle		471HUB	471HUB	234HUB	
Alternator / Generator Bearing	- Front	B17-102	B8-85DW	62012RS	62012RS
	- Rear	B8-85DW	B17-102	63032RS	62032RS
Concentric / Thurst Bearing		RB9589	RB9589	RB9589	RB9589 [Dies.] RB9856 [Pet.]
Diff Carrier Bearing	- Left	68111+49	32008	501310+49	501310+49
	- Right	68111+49	32008	501310+49	501310+49
Diff Pinion Bearing	- Front			86610+49	86610+49
	- Rear			88610+49	88610+49
Propshaft Support Bearing				6205ZZ	6205ZZ
Pulley Bearing					
Spigot Shaft Bearing				6202ZZ	6202ZZ
V-Belt Tensioner					
Drive Shaft Oil Seal	- Left	9654	9654		
	- Right	9654	9654		
Gearbox Oil Seal	- Front	274308	274308	274308	274308
	- Rear			354814	354814
Pinion Oil Seal		9654		2738	2738
Spark Plug Tube Seal					
Rear Main Bearing Oil Seal		9667	9742	9667	8010513 [2.0] 10012513 [2.2]
Timing Cover / Cam Oil Seal		9666 [Cam, T/Cover]	9666 [Cam x 2] 9682 [T/cover]	9666 [Cam, T/Cover]	487012 [T/Cover 2.0] 9629 [T/Cover 2.2]
Rear Wheel Bearing	- Inner	HUB053-41 [Gear type ABS] HUB066-40 [Gear type ABS]	HUB053-41 [Gear type ABS]	U399+360 + 1852119	U399+360 + 1852119
	- Outer				
Rear Wheel Oil Seal	- Inner	HUB UNIT	HUB UNIT		
	- Outer			9415	9415
Rear Wheel Kit		PQ426 [5 Studs] PQ642 [4 Studs]	PQ642 [4 Studs]	PQ176	PQ176
Rear Wheel Hub / Stub Axle					

APPLICATIONS	LOCATION	MAZDA B-SERIES B2600	MAZDA B-SERIES B2600i 4X4	MAZDA B-SERIES B2600 4X4	MAZDA B-SERIES B3000 4X2
		[86-95] 4X2 2.6 LWB D/cab, Magnum, Drifter P/up 4G54 Pet. B2600i [00-01] 2.6i LWB D/cab Drifter, SLX P/up 4G54 Pet.	2.6i V6 LWB Drifter, D/cab Drifter SLX P/up 4G54 Pet.	2.6 V6 LWB D/cab, Magnum, Drifter P/up 4G54 Pet.	3.0 V6 LWB D/cab, Magnum Drifter P/up Essex Pet.
YEARS		86-95 00-01	00-09	86-95	86-97
Front Wheel Bearing	- Inner	48510/48	102910+49	102910+49	48510/48
	- Outer	30205	69310/49	69310/49	30205
Front Wheel Oil Seal	- Inner	9669	9946	9946	9669
	- Outer		9918	9918	
Front Wheel Kit		PQ234	PQ401	PQ401	PQ234
Front Wheel Hub / Stub Axle		234HUB	401HUB	401HUB	234HUB
Alternator / Generator Bearing	- Front	62012RS	62012RS	62012RS	6202 2RS
	- Rear	63022RS	63022RS	63022RS	63022RS
Concentric / Thurst Bearing		RB9588A	RB9588A [00-07] RB9678 [07-09]	RB9589	RB9588A
Diff Carrier Bearing	- Left	501310+49	32008 [Front Diff] 102910+49 [Rear Diff]	32008 [Inner Front Diff] 6202 2RS [Outer Front Diff] R45-Z5 [Rear Diff]	501310+49
	- Right	501310+49	32008 [Front Diff] 102910+49 [Rear Diff]	32008 [Inner Front Diff] 6202 2RS [Outer Front Diff] R45-Z5 [Rear Diff]	501310+49
Diff Pinion Bearing	- Front	86610+49	32206 [Front Diff] 86610+49 [Rear Diff]	32206 [Front Diff] 30306 [Rear Import] 86610+49 [Rear Local]	86610+49
	- Rear	88610+49 [86-95] 802011+48 [2000-]	32307 [Front Diff] 802011+48 [Rear Diff]	32207 [Front Diff] 30307 [Rear Import] 88610+49 [Rear Local]	88610+49
Propshaft Support Bearing		6205ZZ [86-95]		6205ZZ	6205ZZ
Pulley Bearing					
Spigot Shaft Bearing		6202ZZ			6202 2RS
V-Belt Tensioner					
Drive Shaft Oil Seal	- Left				
	- Right				
Gearbox Oil Seal	- Front	274308	274308	274308	274308
	- Rear	354814 [86-95] 9838 [Ext. Housing 2000-]	9858 9838 [Ext. Housing]	9858 9838 [Ext. Housing]	4250 [86-90] 9847 [91-97]
Pinion Oil Seal		2738 [Rubber] 9718 [Metal]	9832 [Front Diff] 2738 [Rubber - Rr. Diff] 9718 [Metal - Rear Diff]	9832 [Front Diff] 9839 [Rear Import] 2738 [Rear Local]	2738
Spark Plug Tube Seal					
Rear Main Bearing Oil Seal		9620 [86-95] 9996 [2000-]	9996	9620	2825
Timing Cover / Cam Oil Seal		9994 [Cam 2000-] 486810 [T/Cover 86-95] 9539 [T/Cover 2000-]	9994 [Cam] 9539 [T/Cover]	486810 [T/Cover]	2708 [T/Cover]
Rear Wheel Bearing	- Inner	U399+360 + 1852119	U399+360 + 1852119	30208 [Import] U399+360 + 1852119 [Local]	U399+360 + 1852119
	- Outer				
Rear Wheel Oil Seal	- Inner			9835 [Import]	
	- Outer	9415	9415	9834 [Import] 9415 [Local]	9415
Rear Wheel Kit		PQ176	PQ176	PQ402 [Import] PQ176 [Local]	PQ176
Rear Wheel Hub / Stub Axle					

APPLICATIONS	LOCATION	MAZDA B-SERIES B3000 4X4	MAZDA B-SERIES B2000	MAZDA B-SERIES B2500 4X2	MAZDA B-SERIES B2500 4X4
		3.0 V6 LWB D/cab, Magnum, Drifter, Magnum Drifter P/up Essex Pet.	2.0 LWB Drifter, Magnum P/up FE Pet. <b>B2200</b> 2.2 LWB D/cab, Drifter, Magnum P/up R2 Dies. 2.2 LWB D/cab, Drifter, Magnum P/up F2 Pet.	2.5 LWB Diesel, Turbo Diesel D/cab, Drifter, SLX P/up WL4 Dies., Turbo	2.5, Td LWB D/Cab, Drifter, SLX P/up WL4 Dies./Turbo Dies.
YEARS		86-97	86-00	97-00	96-99
Front Wheel Bearing	- Inner	102910+49	48510/48	48510/48	102910+49
	- Outer	69310/49	30205	30205	69310/49
Front Wheel Oil Seal	- Inner	9946	9669	9669	9946
	- Outer	9918			9918
Front Wheel Kit		PQ401	PQ234	PQ234	PQ401
Front Wheel Hub / Stub Axle		401HUB	234HUB	234HUB	401HUB
Alternator / Generator Bearing	- Front	62032RS	62012RS [Pet.] 63022RS [Dies.]	63032RS	63032RS
	- Rear	62012RS	63032RS [Pet.] 6201VRS [Dies.]	6000 2RS	6000 2RS
Concentric / Thurst Bearing		RB9589	RB9589 [Dies.] RB9856 [Pet.]	RB9589	RB9589
Diff Carrier Bearing	- Left	32008 [Front Diff] R45-Z5 [Rear Import] 501310+49 [Rear Local]	501310+49	501310+49	32008 [Front Diff] 102910+49 [Rear Diff]
	- Right	32008 [Front Diff] R45-Z5 [Rear Import] 501310+49 [Rear Local]	501310+49	501310+49	32008 [Front Diff] 102910+49 [Rear Diff]
Diff Pinion Bearing	- Front	32207 [Front Diff] 30306 [Rear Import] 86610+49 [Rear Local]	86610+49	86610+49	32206 [Front Diff] 86610+49 [Rear Diff]
	- Rear	32206 [Front Diff] 30307 [Rear Import] 88610+49 [Rear Local]	88610+49	802011+48	32307 [Front Diff] 802011+48 [Rear Diff]
Propshaft Support Bearing		6205ZZ	6205ZZ		
Pulley Bearing					
Spigot Shaft Bearing			6202ZZ		
V-Belt Tensioner					
Drive Shaft Oil Seal	- Left				
	- Right				
Gearbox Oil Seal	- Front	274308	274308	274308	274308
	- Rear	4250 [86-90] 9847 [91-97]	354814	9838 [Ext. Housing]	9858 [Ext. Housing]
Pinion Oil Seal		9832 [Front Diff] 9839 [Rear Import] 2738 [Rear Local]	2738	2738 [Rubber] 9718 [Metal]	9832 [Front Diff] 2738 [Rubber - Rr. Diff] 9718 [Metal - Rear Diff]
Spark Plug Tube Seal					
Rear Main Bearing Oil Seal		2825	9667	9996	9996
Timing Cover / Cam Oil Seal		2708 [T/Cover]	9666 [Cam Pet., T/Cover Both] 9682 [Cam Dies.]	9994 [Cam] 9995 [T/Cover]	9994 [Cam] 9995 [T/Cover]
Rear Wheel Bearing	- Inner	30208 [Import] U399+360 + 1852119 [Local]	U399+360 + 1852119	U399+360 + 1852119	U399+360 + 1852119
	- Outer				
Rear Wheel Oil Seal	- Inner	9835 [Import]			
	- Outer	9834 [Import] 9415 [Local]	9415	9415	9415
Rear Wheel Kit		PQ402 [Import] PQ176 [Local]	PQ176	PQ176	PQ176
Rear Wheel Hub / Stub Axle					

APPLICATIONS	LOCATION	MAZDA B-SERIES B3400 4X2 3.4 V6 LWB Magnum D/cab P/up Essex Pet.	MAZDA B-SERIES B3400 4X4 3.4 V6 LWB Magnum D/ cab P/up Essex	MAZDA BT-50 4X2, 4X4 2500 TDi 2.6i SLE D/cab., S/cab. 3000 CRDi SLE D/cab., Freestyle SLX S/cab., D/cab	MAZDA BT-50 4X2 2.2 MZ-CD P4-AT 2.5 MZI L5-Y3 3.2 MZ-CD P5-AT
		YEARS	96-00	96-01	07-12
Front Wheel Bearing	- Inner	48510/48	102910+49	47KWD02A	DRT45T6
	- Outer	30205	69310/49		
Front Wheel Oil Seal	- Inner	9669	9946	9946 9336 [Alt.]	
	- Outer		9918	9298	
Front Wheel Kit		PQ234	PQ401	PQ758	PQ949
Front Wheel Hub / Stub Axle		234HUB	401HUB	758HUB [4X2] 758AHUB [28 Spline][4X4] 758BHUB [26 Spline] [4X4]	
Alternator / Generator Bearing	- Front				
	- Rear				
Concentric / Thurst Bearing		RB9589	RB9589	RB9701 [3.0]	Concentric Slave Cylinder
Diff Carrier Bearing	- Left	501310+49	32008 [Front Diff] 102910+49 [Rear Diff]		
	- Right	501310+49	32008 [Front Diff] 102910+49 [Rear Diff]		
Diff Pinion Bearing	- Front	86610+49	32206 [Front Diff] 86610+49 [Rear Diff]		
	- Rear	88610+49	32307 [Front Diff] 802011+48 [Rear Diff]		
Propshaft Support Bearing					
Pulley Bearing					
Spigot Shaft Bearing					
V-Belt Tensioner					
Drive Shaft Oil Seal	- Left			9516 [2.5] 9512 [2.6, 3.0]	
	- Right			9516 [2.5] 9512 [2.6, 3.0]	
Gearbox Oil Seal	- Front		274308	274307 [2.5]	
	- Rear		9858 9838 [Ext. Housing]	9838 [2.5] 9517 [2.6, 3.0]	
Pinion Oil Seal		2738 [Rubber] 9718 [Metal]	9832 [Front Diff] 2738 [Rubber - Rr. Diff] 9718 [Metal - Rear Diff]		
Spark Plug Tube Seal					
Rear Main Bearing Oil Seal		2825	2825	9079 [2.6, 3.0 - 4X4] 9511 [2.5 - 4X2] 9996 [2.6, 3.0 - 4X2]	9061FS [2.2, 3.2]
Timing Cover / Cam Oil Seal		2708 [T/Cover]	2708 [T/Cover]	9079 [T/Cover 2.5, 3.0 - 4X2] 9391 [Cam 3.0]	9561 [T/Cover 2.2, 3.2]
Rear Wheel Bearing	- Inner	U399+360 + 1852119	U399+360 + 1852119	DAC4TCR1	
	- Outer				
Rear Wheel Oil Seal	- Inner				
	- Outer	9415	9415	9339 9340	
Rear Wheel Kit		PQ176	PQ176	PQ755L/R	
Rear Wheel Hub / Stub Axle					

APPLICATIONS	LOCATION	MAZDA BT-50 4X4 3.2 MZ-CD P5-AT	MAZDA CX-3 2.0 PEX3	MAZDA CX-5 2.0 PEY4	MAZDA CX-7 2.3 L3-VDT - AWD 2.5 L5-VE
		YEARS	2012-	2015-	12-15
Front Wheel Bearing	- Inner	<b>47KWD02A</b> <b>47KWD03ASB</b>	<b>HUB381</b> [with integrated ABS sensor]	<b>HUB307</b> [with integrated ABS sensor]	<b>45BWDVER</b>
	- Outer				
Front Wheel Oil Seal	- Inner	<b>9946</b> <b>9336</b> [Alt.]	HUB UNIT	HUB UNIT	Sealed Bearing
	- Outer	<b>9298</b>			
Front Wheel Kit		<b>PQ758</b> <b>PQ915</b> [ASB]	<b>PQ1103</b>	<b>PQ982</b>	<b>PQ792</b>
Front Wheel Hub / Stub Axle		<b>758AHUB</b> [28 Spline] <b>758BHUB</b> [26 Spline]			
Alternator / Generator Bearing	- Front				
	- Rear				
Concentric / Thurst Bearing		<b>Concentric Slave Cylinder</b>		<b>RB9701</b>	
Diff Carrier Bearing	- Left				
	- Right				
Diff Pinion Bearing	- Front				
	- Rear				
Propshaft Support Bearing					
Pulley Bearing					
Spigot Shaft Bearing					
V-Belt Tensioner					
Drive Shaft Oil Seal	- Left		<b>9131</b>		
	- Right		<b>9132</b>		
Gearbox Oil Seal	- Front				
	- Rear				
Pinion Oil Seal					
Spark Plug Tube Seal					
Rear Main Bearing Oil Seal		<b>9061FS</b>	<b>9742</b>	<b>9742</b>	<b>9375FS</b>
Timing Cover / Cam Oil Seal		<b>9561</b>	<b>9080</b> [T/Cover]	<b>9080</b> [T/cover]	<b>9290</b>
Rear Wheel Bearing	- Inner		<b>HUB387</b> [with integrated ABS sensor]	<b>HUB308</b> [with integrated ABS sensor] <b>HUB309</b> [4X4]	<b>HUB382</b>
	- Outer				
Rear Wheel Oil Seal	- Inner		HUB UNIT	HUB UNIT	HUB UNIT
	- Outer				
Rear Wheel Kit			<b>PQ1111</b>	<b>PQ983</b> <b>PQ984</b> [4X4]	<b>PQ1046</b> (2.5) <b>PQ1104</b> [2.3 AWD]
Rear Wheel Hub / Stub Axle					

APPLICATIONS	LOCATION	MAZDA DRIFTER	MAZDA DRIFTER	MAZDA DRIFTER	MAZDA
		1.8 SWB/LWB XL P/up Pet. 2.2 SWB/LWB XL P/up Pet.	4X2 2.5Td LWB Hi Ride, SL SLE, SLX D/cab, Hi Ride, Hi Trail D/cab P/up WL4 Dies./Turbo Dies. 2.6i LWB Hi Ride, SL Hi Ride S/cab, SLE, SLX D/cab SLX Hi Ride D/ cab, SLX Hi Trail D/cab P/up Pet.	4X4 2.5Td LWB D/cab, DL, SL, SLE, SLX S/cab, D/cab P/up WL4 Dies./ Turbo Dies. 2.6i V6 LWB SL S/cab, SLE, SLX D/cab P/up 4G54 Pet.	ETUDE [95-00] 160, e, i, iE, iSE Sport 180, e, SE ETUDE [99-04] 160 iE, iSE, Sport, 180 iSE, iSX, Sport
YEARS		00-09	00-09	02-09	95-04
Front Wheel Bearing	- Inner	48510/48 [-2004] 102910+49 [04-09]	48510/48 [-2004] 47KWD02A [04-09]	102910+49 [-2004] 47KWD02A [04-09]	40BWD06A
	- Outer	30205 [-2004] 69310/49 [04-09]	30205 [-2004]	69310/49 [-2004]	
Front Wheel Oil Seal	- Inner	9669 [-2004] 9946 [04-09]	9669 [-2004] 9946 [04-09] 9336 [04-07 Alt]	9946 [04-09] 9336 [04-09 Alt.]	Sealed Bearing
	- Outer	9918 [04-09]	9298 [04-09]	9918 [-2004] 9298 [04-09]	9948 [Dust Seal]
Front Wheel Kit		PQ234 [-2004] PQ401 [04-09]	PQ234 [-2004] PQ758 [04-09]	PQ401 [-2004] PQ758 [04-09]	PQ471
Front Wheel Hub / Stub Axle		234HUB 401HUB	234HUB 758HUB	401HUB 758AHUB [28 Spline]	471HUB
Alternator / Generator Bearing	- Front	62012RS	63032RS [2.5Td] 62012RS [2.6i]	63032RS [2.5Td] 62012RS [2.6i]	B8-85DW
	- Rear	63022RS	6000 2RS [2.5Td] 63022RS [2.6i]	6000 2RS [2.5Td] 63022RS [2.6i]	B17-102
Concentric / Thrust Bearing		RB9589	RB9856 [2.5Td] RB9588A [2.6i]	RB9856 [02-07] [2.5Td] RB9588A [02-07] [2.6i] RB9678 [07-09][2.5Td, 2.6i]	RB9820
Diff Carrier Bearing	- Left	501310+49	501310+49	32008 [Front Diff] 102910+49 [Rear Diff]	68111+49
	- Right	501310+49	501310+49	32008 [Front Diff] 102910+49 [Rear Diff]	68111+49
Diff Pinion Bearing	- Front	86610+49	86610+49	32206 [Front Diff] 86610+49 [Rear Diff]	
	- Rear	802011+48	802011+48	32307 [Front Diff] 802011+48 [Rear Diff]	
Propshaft Support Bearing					
Pulley Bearing					
Spigot Shaft Bearing					
V-Belt Tensioner					
Drive Shaft Oil Seal	- Left				9654
	- Right				9654
Gearbox Oil Seal	- Front	274308	274308	274308	274308
	- Rear	354814	9838 [Ext. Housing]	9858 9838 [Ext. Housing]	
Pinion Oil Seal		2738 [Rubber] 9718 [Metal]	2738 [Rubber] 9718 [Metal]	9832 [Front Diff] 2738 [Rubber - Rr. Diff] 9718 [Metal - Rear Diff]	9654
Rear Main Bearing Oil Seal		9667	9996	9996	9742 [1.6] 9010909 [1.8]
Timing Cover / Cam Oil Seal		9666 [Cam, T/Cover]	9994 [Cam] [2.5Td, 2.6i] 9995 [T/Cover] [2.5Td] 9539 [T/Cover] [2.6i]	9994 [Cam] 9995 [T/Cover]	9666 [Cam, T/Cover]
Rear Wheel Bearing	- Inner	U399+360 + 1852119	U399+360 + 1852119 [00-05] DAC4TCR1 [05-09]	U399+360 + 1852119 [00-05] DAC4TCR1 [05-09]	HUB053-41 [Gear type ABS]
	- Outer				
Rear Wheel Oil Seal	- Inner				HUB UNIT
	- Outer	9415	9415 [00-05] 9339 [05-09] 9340 [05-09]	9415 [00-05] 9339 [05-09] 9340 [05-09]	
Rear Wheel Kit		PQ176	PQ176 [00-05] PQ755L/R [05-09]	PQ176 [00-05] PQ755L/R [05-09]	PQ642 [4 Studs]
Rear Wheel Hub / Stub Axle					

APPLICATIONS	LOCATION	MAZDA MARATHON	MAZDA MX-5	MAZDA RUSTLER	MAZDA RUSTLER
		2.2 LWB Bus, P/van F2 Pet.	1.6 [90-93] 1.8 16V [01-09] 2.0 [05-14]	1.3 SWB P/up Kent 2V Pet. 1.4 SWB P/up CVH/FUA Pet. 1.6 SWB, LX P/up CVH/LUC Pet.	130 SWB Drifter, Explorer P/up B3 Pet. 160, i SWB Explorer, Drifter P/up F6/B6i Pet.
YEARS		91-04	90-09	86-94	94-02
Front Wheel Bearing	- Inner	48510/48	HUB359 [with integrated ABS sensor] HUB360 [with ABS sensor ring]	68111/573315	69310/45
	- Outer	30205		68111/573315	69310/45
Front Wheel Oil Seal	- Inner	9669	HUB UNIT	9449	9444
	- Outer			9450	9445
Front Wheel Kit		PQ234	PQ1061 [2.0][05-14] PQ1062 [1.6, 1.8][Flange Ø: 122mm]	PQ141	PQ184
Front Wheel Hub / Stub Axle		234HUB		141HUB	184HUB SA184L/R
Alternator / Generator Bearing	- Front	62012RS		62032RS	62032RS
	- Rear	63032RS		62012RS	62012RS
Concentric / Thurst Bearing		RB9856		RB9592	RB9820
Diff Carrier Bearing	- Left	501310+49 [Rear import] R45-Z5 [Rear local]		29711+49	68111+49
	- Right	501310+49 [Rear import] R45-Z5 [Rear local]		29711+49	68111+49
Diff Pinion Bearing	- Front	30306 [Rear import] 86610+49 [Rear local]		362668	
	- Rear	30307 [Rear import] 86610+49 [Rear local]		362351B	
Propshaft Support Bearing					
Pulley Bearing					
Spigot Shaft Bearing		6202ZZ			
V-Belt Tensioner					
Drive Shaft Oil Seal	- Left			405510	9654
	- Right			405510	9654
Gearbox Oil Seal	- Front	274308		345007 [1.4, 1.6]	9857
	- Rear	9838		9467 [1.4, 1.6]	
Pinion Oil Seal		9839 [Rear import] 2738 [Rear local]			
Spark Plug Tube Seal					
Rear Main Bearing Oil Seal		9667	9742	2825 [1.3] 9452 [1.4, 1.6]	9742 [1.3] 9667 [1.6]
Timing Cover / Cam Oil Seal		9666 [Cam, T/Cover]	9682 [Cam, T/Cover]	425607 [Cam 1.4, 1.6] 9634 [T/Cover 1.3] 355007 [T/Cover 1.4, 1.6]	9682 [Cam, T/Cover 1.3] 9666 [Cam, T/Cover 1.6] Some Models 9870 [T/Cover 1.3, 1.6]
Rear Wheel Bearing	- Inner	30208 [Import] U399+360 + 1852119 [Local]	40BWD06A DAC428045	67010/48	67010/48
	- Outer			11910+49	11910+49
Rear Wheel Oil Seal	- Inner	9835 [Import]	9948		
	- Outer	9834 [Import] 9415 [Local]		9633	9633
Rear Wheel Kit		PQ402 PQ176 [Local]	PQ471 [1.6, 1.8] PQ927 [2.0][05-14]	PQ233L/R	PQ233L/R
Rear Wheel Hub / Stub Axle					

APPLICATIONS		LOCATION	MERCEDES-BENZ W123 200 M115.938/9 230, E M115.954 240D M616.912 250 M123.920/1 280E M110.983 300D M617.912	MERCEDES-BENZ W124 200E M102.922 220E M111.960 230E M102.982 260E M103.940 280E M104.942 300D M103.985, M606.910 320 Sportline M104.922	MERCEDES-BENZ W124 E Class E200 M102.922 E220 M111.960 E320 Sportline, M104.992	MERCEDES-BENZ W126 280SE M110.987/9 300SE M103.981 380SE M116.963 420SE M116.965 500SE M117.965
YEARS			77-86	86-96	93-96	86-93
Front Wheel Bearing	- Inner		48510/48	68111/49 [280] 67010/48 [Others]	68111/49	48510/48
	- Outer		12610/49	12710/49 [280] 11910/49 [Others]	12710/49	12610/49
Front Wheel Oil Seal	- Inner		507013 [Non ABS] 9942 [ABS]	456412 [All Models]	486412	507013 [Non ABS] 9942 [ABS]
	- Outer					
Front Wheel Kit			PQ278 [Non ABS] PQ480 [ABS]	PQ442 [280] PQ444 [Others]	PQ438	PQ278 [Non ABS] PQ480 [ABS]
Front Wheel Hub / Stub Axle						
Alternator / Generator Bearing	- Front		63032RS	63032RS	63032RS	63032RS
	- Rear		62012RS	62012RS	62012RS	62012RS
Concentric / Thurst Bearing			RB9814	RB9657	RB9657	RB9655 [4 Spd.] RB9814 [5 Spd.]
Diff Carrier Bearing	- Left		503310+49	503310+49	503310+49	503310+49 806610+49
	- Right		503310+49	503310+49	503310+49	503310+49 806610+49
Diff Pinion Bearing	- Front		86610+49	86610+49	86610+49	86610+49
	- Rear		89410+49	802011+48	802011+48	89410+49 [280] 802011+48 [Others]
Propshaft Support Bearing			60062RS	60062RS	60062RS	60062RS
Pulley Bearing						
Spigot Shaft Bearing			6202ZZ	6202ZZ	6202ZZ	6202ZZ
V-Belt Tensioner						
Drive Shaft Oil Seal	- Left		9908 9910	9908	9908	9908
	- Right		9908 9910	9908	9908	9908
Gearbox Oil Seal	- Front					
	- Rear		405510 [Man.] 406210 [Auto.]			
Pinion Oil Seal			407012	9886	9885 9886	407012
Spark Plug Tube Seal						
Rear Main Bearing Oil Seal			9722 [200, 230]	9723	9723	9723 [only 380SE]
Timing Cover / Cam Oil Seal			9724 [T/Cover 200, 230] 9719 [T/Cover 240, 300] 9720 [T/Cover 250] 9721 [T/Cover 280]	9720 [T/Cover]	9720 [T/Cover]	9720 [T/Cover]
Rear Wheel Bearing	- Inner		300811+49	309797 [Sedan] 25469C [S/W]	309797 [Sedan] 25469C [S/W]	300811+49
	- Outer		503310+49			503310+49
Rear Wheel Oil Seal	- Inner		597212	Sealed Bearing	Sealed Bearing	597212
	- Outer		728418			728418
Rear Wheel Kit			PQ277	PQ443 [Sedan] PQ445 [S/W]	PQ443 [Sedan] PQ445 [S/W]	PQ277
Rear Wheel Hub / Stub Axle						



APPLICATIONS		LOCATION	MERCEDES-BENZ W140 S-CLASS S320 M104.990 S420 M119.971 S500 M119.980	MERCEDES-BENZ W163 ML230 5 Dr. SUV M111.977 ML320 5 Dr. SUV, M112.942 ML430 5 Dr. SUV M113.942	MERCEDES-BENZ W164 ML320CDi SUV OM642.940 ML350 SUV OM272.967 ML500 SUV OM273.963 ML63 AMG SUV M156.980	MERCEDES-BENZ W166 ML250 ML350 ML500
YEARS			93-99	98-06	2006-	2012-
Front Wheel Bearing	- Inner		32008	DAC498846	DAC54ML	HUB351 [with integrated ABS sensor]
	- Outer		33205			
Front Wheel Oil Seal	- Inner		557112	Sealed Bearing	Sealed Bearing	HUB UNIT
	- Outer					
Front Wheel Kit			PQ585	PQ558	PQ988	PQ1047
Front Wheel Hub / Stub Axle					988HUB	
Alternator / Generator Bearing	- Front		63032RS			
	- Rear		62012RS			
Concentric / Thurst Bearing				Concentric Slave Cylinder	Concentric Slave Cylinder	
Diff Carrier Bearing	- Left					
	- Right					
Diff Pinion Bearing	- Front					
	- Rear					
Propshaft Support Bearing						
Pulley Bearing						
Spigot Shaft Bearing						
V-Belt Tensioner						
Drive Shaft Oil Seal	- Left					
	- Right					
Gearbox Oil Seal	- Front					
	- Rear					
Pinion Oil Seal						
Spark Plug Tube Seal						
Rear Main Bearing Oil Seal			9964	9964	9397 [ML350 W164] 9500 [Rest W164]	
Timing Cover / Cam Oil Seal			9963 [T/Cover]	9963 [T/Cover]	9721 [T/Cover]	
Rear Wheel Bearing	- Inner		DAC498846	DAC498846	DAC54ML	DAC52ML
	- Outer					
Rear Wheel Oil Seal	- Inner		Sealed Bearing	Sealed Bearing	Sealed Bearing	Sealed Bearing
	- Outer					
Rear Wheel Kit			PQ558	PQ558	PQ988	PQ1048
Rear Wheel Hub / Stub Axle					988HUB	

APPLICATIONS	LOCATION	MERCEDES-BENZ W168	MERCEDES-BENZ W169	MERCEDES-BENZ R170	MERCEDES-BENZ R170
		A-CLASS A160, L Classic, Elegance M166.940 A190, L Elegance M167.690	A-CLASS A170 M266.940 A180 M266.940 A180 CDi OM640.940 A200 M266.960	SLK200 SLK320 M112.947	SLK200K M111.958 SLK320 SLK32 AMG M112.960
YEARS		00-05	05-13	97-02	02-04
Front Wheel Bearing	- Inner	309245TAP	DACFWBMW245	68111/49	68111/49
	- Outer			12710/49	12710/49
Front Wheel Oil Seal	- Inner	Sealed Bearing	Sealed Bearing	486412	486412
	- Outer				
Front Wheel Kit		PQ559	PQ690	PQ438	PQ438
Front Wheel Hub / Stub Axle			690HUB	438HUB	438HUB
Alternator / Generator Bearing	- Front				
	- Rear				
Concentric / Thurst Bearing		Concentric Slave Cylinder	Concentric Slave Cylinder		Concentric Slave Cylinder
Diff Carrier Bearing	- Left			300816+49 [2.0] 503310+49 [3.2]	
	- Right			300816+49 [2.0] 503310+49 [3.2]	
Diff Pinion Bearing	- Front			84510+48 [2.0] 86610+49 [3.2]	
	- Rear			88610+49 [2.0] 802011+48 [3.2]	
Propshaft Support Bearing					
Pulley Bearing					
Spigot Shaft Bearing					
V-Belt Tensioner					
Drive Shaft Oil Seal	- Left				
	- Right				
Gearbox Oil Seal	- Front		9396 [A180CDi,A200CDi Man] 9394 [A180Cdi,A200,CDi Auto] 9395 [A200 Man]		
	- Rear				
Pinion Oil Seal				9885 [2.0] 9886 [3.2]	
Spark Plug Tube Seal					
Rear Main Bearing Oil Seal		9534	9392 [A200] 9534 [A170, A180] 9535 [A180CDi,A200CDi]	9964	9723 [SLK200 K] 9500 [SLK320, 32 AMG]
Timing Cover / Cam Oil Seal		9695 [T/Cover]	406208 [T/Cover CDi] 9395 [T/Cover A180, A200] 9565 [T/Cover A170]	9963 [T/Cover]	9721 [T/Cover SLK200 K] 9042 [T/Cover SLK320, 32 AMG]
Rear Wheel Bearing	- Inner	12271S	HUB179 [With integrated ABS Sensor]	309797	309797
	- Outer				
Rear Wheel Oil Seal	- Inner	Sealed Bearing	HUB UNIT	Sealed Bearing	Sealed Bearing
	- Outer				
Rear Wheel Kit		PQ619	PQ875 [5 Studs]	PQ443	PQ443
Rear Wheel Hub / Stub Axle				443HUB	443HUB

APPLICATIONS	LOCATION	MERCEDES-BENZ R171 SLK200K M271.954/958 SLK350 M272.963/969 SLK55 AMG M113.989	MERCEDES-BENZ R172 SLK250 SLK350 M276.956 SLK55 AMG M152.980	MERCEDES-BENZ W176 A-CLASS A180 A180 CDi A200 A220 CDi A250	MERCEDES-BENZ W201 190E 1.8 M102.920 2.0 M102.922 2.3 Sportline M102.983
		YEARS	04-11	2011-	2013-
Front Wheel Bearing	- Inner	MBCFWB2008	MBCFWB2008	DAC458441ASB	67010/48
	- Outer	MBCFWB2008B	MBCFWB2008B		11710/49
Front Wheel Oil Seal	- Inner	9304	9304	Sealed Bearing	456412
	- Outer				
Front Wheel Kit		PQ797	PQ797	PQ985	PQ441
Front Wheel Hub / Stub Axle				985HUB	
Alternator / Generator Bearing	- Front				63032RS
	- Rear				62012RS
Concentric / Thurst Bearing		Concentric Slave Cylinder	Concentric Slave Cylinder	Concentric Slave Cylinder	Concentric Slave Cylinder RB9814 [1.8, 2.0] RB9657 [2.3]
Diff Carrier Bearing	- Left				
	- Right				
Diff Pinion Bearing	- Front				84510+48 [1.8] 86610+49 [2.0, 2.3]
	- Rear				88610+49 [1.8] 802011+48 [2.0, 2.3]
Propshaft Support Bearing					60062RS
Pulley Bearing					
Spigot Shaft Bearing					6202ZZ
V-Belt Tensioner					
Drive Shaft Oil Seal	- Left				9908
	- Right				9908
Gearbox Oil Seal	- Front				304707
	- Rear				405508
Pinion Oil Seal					9886
Spark Plug Tube Seal					
Rear Main Bearing Oil Seal		9397FS [SLK350, 55 AMG] 9398FS [SLK200 K]		9081 [CDi Auto.] 9082FS [A180, A200, A250] 9326 [CDi Man.]	9964
Timing Cover / Cam Oil Seal		9042 [T/Cover]	9042 [T/Cover]	9207 [T/Cover CDi Auto.] 9565 [T/Cover A180, A200, A250] 9569 [T/Cover CDi Man.]	9963 [T/Cover]
Rear Wheel Bearing	- Inner	309797	309797	HUB310 [With integrated ABS Sensor]	309797
	- Outer				
Rear Wheel Oil Seal	- Inner	Sealed Bearing	Sealed Bearing	HUB UNIT	Sealed Bearing
	- Outer				
Rear Wheel Kit		PQ443	PQ443	PQ986 [5 Studs]	PQ443
Rear Wheel Hub / Stub Axle					

APPLICATIONS	LOCATION	MERCEDES-BENZ W202/3	MERCEDES-BENZ W204	MERCEDES-BENZ W208	MERCEDES-BENZ W210/211
		C-CLASS C180 Classic M111.920 C200 M111.941 C220 M111.961 C230 M111.974 C240 M111.944 C250 M605.910 C270CDi M612.962 C280 M104.941	C-CLASS C180K C200K, CDi C220 CDi C250, CDi C300 C350, CDi C63 AMG	CLK230, M111.973 CLK320, M112.940 CLK430 CLK500	E-CLASS E200, K M111.941/956 E230 M111.970 E240 M112.911 E280 M112.921 E320 M112.941 E320CDi OM646.961 E350 M272.964 E500 M113.967
YEARS		94-08	07-14	98-03	96-10
Front Wheel Bearing	- Inner	68111/49 [W202] MBCFWB2008 [W203]	MBCFWB2008	68111/49	68111/49
	- Outer	12710/49 [W202] MBCFWB2008 B [W203]	MBCFWB2008B	12710/49	12710/49
Front Wheel Oil Seal	- Inner	486412 9304	9304	486412	486412 9401 [W211]
	- Outer				
Front Wheel Kit		PQ438 [W202] PQ797 [W203]	PQ797	PQ438	PQ438 [W210]
Front Wheel Hub / Stub Axle		438HUB 797HUB	797HUB		438HUB
Alternator / Generator Bearing	- Front	63032RS			
	- Rear	62012RS			
Concentric / Thurst Bearing		RB9656 [C180, 200] RB9657 [Others]	Concentric Slave Cylinder	Concentric Slave Cylinder	Concentric Slave Cylinder
Diff Carrier Bearing	- Left	300816+49 503310+49		300816+49 503310+49	300816+49 503310+49 [Alt.] 806610+49 [Alt.] 32011[Alt.]
	- Right	300816+49 503310+49		300816+49 503310+49	300816+49 503310+49 [Alt.] 806610+49 [Alt.] 32011[Alt.]
Diff Pinion Bearing	- Front	84510+48 86610+49		84510+48 86610+49	84510+48 86610+49
	- Rear	802011+48		802011+48	88610+49 [E200/220] 802011+48 [E230/240] 803110/49 [E280/320/430]
Drive Shaft Oil Seal	- Left	9909 [C250 Only], 9907		9907	9908
	- Right	9909 [C250 Only], 9907		9907	9908
Gearbox Oil Seal	- Front	304707		304707	304707 9400 [W211 Man] 9394 [W211 Auto]
	- Rear	405508 [Man.] 406210 [Auto.]		406210 [Auto.]	405508 [Man.] 9399FS [W211 Man/ Auto.] 406210 [Auto.]
Pinion Oil Seal		9885, 9886		9885, 9886	9885, 9886, 9219 [Alt.]
Rear Main Bearing Oil Seal		9964	9083FS [C350 CDi] 9397FS [C300] 9398FS [C180, 200, 250] 9081 [C220 CDi, C250 CDi, C350CDi]	9964	9964 9398FS [W211] 9500 [W211]
Timing Cover / Cam Oil Seal		9963 [T/Cover]	9042 [T/Cover C180, 200, 250, 300, 350 11-, 350 CDi] 9207 [T/Cover C220 CDi, C250 CDi, C350 -11]	9963 [T/Cover]	9963 [T/Cover] 9721 [W211 T/Cover]
Rear Wheel Bearing	- Inner	309797 [Sedan] 25469C [S/W]	HUB140 [Non ABS]	309797	309797 HUB180 [W211] [ABS]
	- Outer				
Rear Wheel Oil Seal	- Inner	Sealed Bearing	HUB UNIT	Sealed Bearing	Sealed Bearing HUB UNIT
	- Outer				
Rear Wheel Kit		PQ443 [Sedan] PQ445 [S/W]	PQ798	PQ443	PQ443 PQ876 [W211]
Rear Wheel Hub / Stub Axle		443HUB			

APPLICATIONS		LOCATION	MERCEDES-BENZ W212 E-CLASS E200, CGi E250, CDi, CGi E350, CDi E400 E500	MERCEDES-BENZ W245 B-CLASS B170 B180 B200 CDI, Turbo	MERCEDES-BENZ W246 B-CLASS B180 B180 CDI B200 B200 CDI B250	MERCEDES-BENZ BM903/4 SPRINTER 308D 2.2 OM 601 LA dies 312D 2.2 OM602 LA dies. 313 2.2 LWB,SWB Bus, P/van OM611 LA Pet.. 412D 2.8 OM612 413CDi 2.2 416CDi 2.2
YEARS			2009-	05-12	2012-	96-06
Front Wheel Bearing	- Inner		32008	DACFWBMW245	DAC458441ASB	33205
	- Outer		12710/49			501310/49
Front Wheel Oil Seal	- Inner			Sealed Bearing	Sealed Bearing	9943
	- Outer					
Front Wheel Kit			PQ987	PQ690	PQ985	PQ481
Front Wheel Hub / Stub Axle				690HUB	985HUB	
Alternator / Generator Bearing	- Front					
	- Rear					
Concentric / Thurst Bearing			Concentric Slave Cylinder	Concentric Slave Cylinder	Concentric Slave Cylinder	Concentric Slave Cylinder
Diff Carrier Bearing	- Left					
	- Right					
Diff Pinion Bearing	- Front					
	- Rear					
Propshaft Support Bearing						
Pulley Bearing						
Spigot Shaft Bearing						
V-Belt Tensioner						
Drive Shaft Oil Seal	- Left					9908
	- Right					9908
Gearbox Oil Seal	- Front			9393 [Man] 9396 [Man B200t, CDi] 9394 [Auto]		2715
	- Rear					
Pinion Oil Seal						9886
Spark Plug Tube Seal						
Rear Main Bearing Oil Seal			9081 [E250 CDi] 9082FS [E200, 250] 9083FS [E350 CDi] 9397FS [E350, 500] 9398FS [E200 CGi]	9534	9081 [CDi Auto.] 9082FS [B180, B200, B250]	9964
Timing Cover / Cam Oil Seal			9042 [T/Cover] [E200 CGi, 350, CDi, 500] 9207 [T/Cover E250 CDi] 9565 [T/Cover E200, 250]	9565 [T/Cover]	9207 [T/Cover CDi Auto.] 9565 [T/Cover B180, B200, B250]	9963 [T/Cover]
Rear Wheel Bearing	- Inner		HUB180 [ABS]	HUB179 [With integrated ABS Sensor]	HUB310 [With integrated ABS Sensor]	32210 [SWB] 329129 [LWB]
	- Outer					32011 [SWB] 329129 [LWB]
Rear Wheel Oil Seal	- Inner		HUB UNIT	HUB UNIT	HUB UNIT	9944 [Both]
	- Outer					
Rear Wheel Kit			PQ876	PQ875 [5 Studs]	PQ986 [5 Studs]	PQ587 [SWB] PQ482 [LWB]
Rear Wheel Hub / Stub Axle			876HUB			

APPLICATIONS	LOCATION	MERCEDES-BENZ BM906 SPRINTER 309 311 315 318 509 511 515 518 Bus, P/van	MERCEDES-BENZ VITO / VIANO W638 113CDi 115CDi 116CDi 120CDi 122CDi	MERCEDES-BENZ VITO / VIANO W639 2.2CDi 3.0CDi 3.5 V6	
		YEARS	2006-	03-06	2006-
Front Wheel Bearing	- Inner	HUB311	309797	HUB313	
	- Outer				
Front Wheel Oil Seal	- Inner	HUB UNIT	Sealed Bearing	HUB UNIT	
	- Outer				
Front Wheel Kit		PQ989	PQ588	PQ991	
Front Wheel Hub / Stub Axle			588HUB		
Alternator / Generator Bearing	- Front				
	- Rear				
Concentric / Thrust Bearing		Concentric Slave Cylinder	Concentric Slave Cylinder	Concentric Slave Cylinder	
Diff Carrier Bearing	- Left				
	- Right				
Diff Pinion Bearing	- Front				
	- Rear				
Propshaft Support Bearing					
Pulley Bearing					
Spigot Shaft Bearing					
V-Belt Tensioner					
Drive Shaft Oil Seal	- Left	9531	9909		
	- Right	9531	9909		
Gearbox Oil Seal	- Front				
	- Rear				
Pinion Oil Seal					
Spark Plug Tube Seal					
Rear Main Bearing Oil Seal		9501	9720	9083FS [3.0 CDi] 9397FS [3.5 V6] 9501 [2.2 CDi 06-11] 9801 [2.2 CDi 2011-]	
Timing Cover / Cam Oil Seal		9042 [T/Cover]	9963 [T/Cover]	9042 [T/Cover Rest] 9207 [T/Cover 2.2 CDi 2011-]	
Rear Wheel Bearing	- Inner	HUB312	309797	DAC50VITO	
	- Outer				
Rear Wheel Oil Seal	- Inner	HUB UNIT	Sealed Bearing	Sealed Bearing	
	- Outer				
Rear Wheel Kit		PQ990	PQ588	PQ992	
Rear Wheel Hub / Stub Axle			588HUB		

APPLICATIONS	LOCATION	MITSUBISHI ASX 2.0 4B11	MITSUBISHI CANTER 2.5 SWB/LWB D/side, Chassis cab 4G55 Dies. 2.6 4G54 Pet. 3.3 4D30A Dies. 3.8 ADE236 Dies.	MITSUBISHI COLT LDV 1.6 SWB/LWB Lo-Line P/up 4G32 Pet. 2.0 4G63 Pet. 2.5D 4D56 Dies. 2.6 WB Hi-Line P/up 4G54 Pet.	MITSUBISHI COLT LDV 2.8D LWB Std., Hi line P/up Dies. 2.8TDi LWB Club CabS cab, Turbo 3.0i V6 LWB Club S/ cab P/up Pet.
		YEARS	2011-	80-97	94-98
Front Wheel Bearing	- Inner	DACFWBDC	30210	48510/48	48510/48
	- Outer		30207	12610/49	12610/49
Front Wheel Oil Seal	- Inner	Sealed Bearing	9456	506509	506509
	- Outer				
Front Wheel Kit		PQ576	PQ281	PQ190	PQ190
Front Wheel Hub / Stub Axle				190HUB	190HUB
Alternator / Generator Bearing	- Front		62032RS	62012RS B8-79D	63032RS B8-85DW
	- Rear		62012RS	63022RS	63022RS
Concentric / Thurst Bearing		Concentric Slave Cylinder	RB9876	RB9817 [1.6] RB9861 [2.0] RB9900 [2.5, 2.6]	RB9660 [2.8] RB9876 [3.0]
Diff Carrier Bearing	- Left		28985+21A	17831+887 [Import] 501310+49 [Local] 102910+49 [Local]	501310+49 [Std.] 17831+887 [Hi Line]
	- Right		28985+21A	17831+887 [Import] 501310+49 [Local] 102910+49 [Local]	501310+49 [Std.] 17831+887 [Hi Line]
Diff Pinion Bearing	- Front		801310+46	M88010SAP [Import] 86610+49 [Local] 88610+49 [Local]	86610+49 [Std.] 88010+43 [Hi Line]
	- Rear		803110+49	HM89410NP [Import] 802011+48 [Local] 88610+49 [Local]	802011+48 [Std.] ETHM89210SAP [Hi Line]
Propshaft Support Bearing		6207 2RS			
Pulley Bearing					
Spigot Shaft Bearing			62032RS		
V-Belt Tensioner					
Drive Shaft Oil Seal	- Left			326512	
	- Right			326512	
Gearbox Oil Seal	- Front		345007	304508	304507
	- Rear		9636 [2.5, 2.6] 9638 [3.3, 3.8]	9636	9218
Pinion Oil Seal			9455	2738 [Import] 9718 [Local]	2738 [Std.] 457212/15 [Hi Line]
Spark Plug Tube Seal					
Rear Main Bearing Oil Seal		8510308	9620 [2.5, 2.6] 9457 [3.3, 3.8]	9426 [1.6] 9620 [2.0, 2.5, 2.6]	9111412 [2.8] 9611412 [2.8 Alt.] 9301 [3.0]
Timing Cover / Cam Oil Seal		9328 [T/Cover]	9666 [Cam 2.5, 2.6] 486810 [T/Cover 2.5, 2.6] 9454 [T/Cover 3.3, 3.8]	9627 [Cam] 446007 [T/Cover]	9627 [Cam] 385006 [T/Cover]
Rear Wheel Bearing	- Inner	HUB314 [with integrated ABS sensor] HUB391 [with integrated ABS sensor]	30212	30208 [Import] U399+360 + 1852119 [Local]	BAK940325 + RR45 [Std.] 46T0808 + RR47 [Hi Line]
	- Outer		30211		
Rear Wheel Oil Seal	- Inner	HUB UNIT	9621	9955 [Import]	
	- Outer		9639	486510 [Import] 9415 [Local]	9415 [Std.] 507509 [Hi Line]
Rear Wheel Kit		PQ577 [OD: 73.8mm] PQ1115 [OD: 77.9mm]		PQ430 [Import] PQ176 [Local]	PQ645 [Std.] PQ646 [Hi Line]
Rear Wheel Hub / Stub Axle					

APPLICATIONS	LOCATION	MITSUBISHI COLT LDV 4X4	MITSUBISHI COLT LDV	MITSUBISHI COLT LDV 4X4	MITSUBISHI COLT LDV
		2.5D LWB Hi-Line P/up 4D56 Dies. 2.6 LWB Lo-/Hi-Line, P/up 4G54 Pet. 3.0 V6 LWB Lo-/Hi- Line D/cab, Rodeo 6G72 Pet.	2.0 LWB Std. P/up 2.0i LWB Hi-Line 2.4i LWB Hi-Line Rodeo S-/D/cab, Hi-Line/Rider P/up Pet. 2.5D 4D56 Dies.	2.4i LWB Hi-Line D/cab, Trailbuster S/cab, P/up Pet.	2.8TDi LWB Pioneer, Rodeo D/cab P/up Turbo Dies. 3.0i V6 LWB Rodeo D/cab P/up Pet.
YEARS		95-98	98-09	98-09	99-09
Front Wheel Bearing	- Inner	102910+49	48510/48	48510/48 [Hi Line] 102910+49 [T. Buster]	48510/48 102910+49
	- Outer	102910+49	12610/49	12610//49 [Hi Line] 102910+49 [T. Buster]	12610/49 102910+49
Front Wheel Oil Seal	- Inner	9891	506509	506509 [Hi Line] 9891 [T. Buster]	506509 9891
	- Outer				
Front Wheel Kit		PQ428	PQ190	PQ190 [Hi Line] PQ428 [T. Buster]	PQ190 PQ428 [2.8]
Front Wheel Hub / Stub Axle		428HUB	190HUB	190HUB 428HUB	190HUB 428HUB [2.8]
Alternator / Generator Bearing	- Front	63022RS 62012RS	63032RS B8-85DW	63032RS B8-85DW	63032RS B8-85DW
	- Rear	62012RS B8-79D 63022RS	63022RS	63022RS	63022RS
Concentric / Thurst Bearing		RB9900 [2.5, 2.6] RB9876 [3.0]			RB9660 [2.8] RB9876 [3.0]
Diff Carrier Bearing	- Left	17831+887 [Fr., Rr.Imp.] 102910+49 [Rr. Local]	501310+49	17831+887 [Fr. & Rr. axle]	17831+887
	- Right	17831+887 [Fr., Rr.Imp.] 102910+49 [Rr. Local]	501310+49	17831+887 [Fr. & Rr. axle]	17831+887
Diff Pinion Bearing	- Front	HM89410NP [Fr. axle] M88010SAP [Rr. Import] 88610+49 [Rr. Local]	86610+49	HM89410NP [Fr. axle] 88610+49 [Rr. axle]	88010+43
	- Rear	M88010NP [Fr. axle] ETHM89210SAP [Rr. Import] 802011+48 [Rr. Local]	802011+48	M88010NP [Fr. axle] ETHM89210SAP [Rr. axle]	ETHM89210SAP
Propshaft Support Bearing					
Spigot Shaft Bearing					
Drive Shaft Oil Seal	- Left	356512	326512	487410	
	- Right	356512	326512	487410	
Gearbox Oil Seal	- Front	304508 [2.5, 2.6] 9763 [3.0]	304507	304507	304506
	- Rear		9636	9636 9218 [Transfer Case]	9217 [Ext. Housing] 456812 [3.0 Auto.]
Pinion Oil Seal		406512 [Fr. 2.5, 2.6] 9952 [Fr. 3.0] 9887 [Rr. Import] 9718 [Rr. Local]	2738	406512 [Fr. axle] 2738 [Rr. Hi Line] 457212/15 [Rr. T. Buster]	457212/15
Spark Plug Tube Seal					
Rear Main Bearing Oil Seal		9620 [2.5, 2.6] 9301 [3.0]	8510308 [2.0, 2.4] 809610 [2.5]	8510308	9111412 [2.8] 9611412 [2.8 Alt.] 9301 [3.0]
Timing Cover / Cam Oil Seal		9627 [Cam] 446007 [T/Cover 2.5, 2.6] 486810 [T/Cover 3.0]	9627 [Cam] 446007 [T/Cover]	9627 [Cam] 446007 [T/Cover]	9627 [Cam] 385006 [T/Cover]
Rear Wheel Bearing	- Inner	30208 [Import] U399+360 + 1852119 [Local]	BAK940325 + RR45	BAK940325 + RR45 [Hi Line] 46T0808 + RR47 [T. Buster]	46T0808 + RR44
	- Outer				
Rear Wheel Oil Seal	- Inner	9955 [Import]			9955
	- Outer	486510 [Import] 9415 [Local]	9415	9415 [Hi Line] 507509 [T. Buster]	507509
Rear Wheel Kit		PQ430 [Import] PQ176 [Local]	PQ645	PQ645 [Hi Line] PQ646 [T. Buster]	PQ647
Rear Wheel Hub / Stub Axle					



APPLICATIONS	LOCATION	MITSUBISHI COLT LDV 4X4 2.8D, TDi LWB Club cab, Trailbuster S/cab, Rodeo /cab P/up Dies./ Turbo Dies. 3.0i V6 LWB Rodeo D/ cab P/up Pet.	MITSUBISHI L300 1.6 Mini Bus, Van 4G32 Pet. 1.8 4G62 Pet. 2.0 P/up 4G63 Pet STARWAGON 2.0 S, SL, SLE, P/up, P/van 4G63 Pet.	MITSUBISHI LANCER 1.6 GLX 4G18 2.0 GLS 4G63	MITSUBISHI LANCER 1.5 4A91 2.0 4B11 2.0 EVO X AWD 4B11 T/C
YEARS		99-09	82-01	03-08	2007-
Front Wheel Bearing	- Inner	102910+49	48510/48	DACFWBMITLAN 40BWD15 [Alt.]	DACFWBDC HUB315 [with integrated ABS sensor]
	- Outer	102910+49	12610/49		
Front Wheel Oil Seal	- Inner	9891	506509	Sealed Bearing	Sealed Bearing HUB UNIT
	- Outer				
Front Wheel Kit		PQ428	PQ190	PQ904 PQ641 [Alt.]	PQ576 PQ994 [EVO X]
Front Wheel Hub / Stub Axle		428HUB			576AHUB
Alternator / Generator Bearing	- Front	63032RS B8-85DW	62032RS		
	- Rear	63022RS	62012RS		
Concentric / Thurst Bearing		RB9660 [2.8] RB9876 [3.0]	RB9817 [1.6] RB9861 [2.0]		Concentric Slave Cylinder
Diff Carrier Bearing	- Left	17831+887 [Fr. axle] 32011 [Rr. axle]	17831+887 [Import] 501310+49 [Local]		
	- Right	17831+887 [Fr. axle] 32011 [Rr. axle]	17831+887 [Import] 501310+49 [Local]		
Diff Pinion Bearing	- Front	HM89410NP [Fr. axle] 88010+43 [Rr. axle]	88010+49 [Import] 86610+49 [Local]		
	- Rear	M88010NP [Fr. axle] 32308CS [Rr. axle]	894410/49 [Import] 88610+49 [Local]		
Propshaft Support Bearing					
Pulley Bearing					
Spigot Shaft Bearing			6002 2RS		
V-Belt Tensioner					
Drive Shaft Oil Seal	- Left	487410			
	- Right	487410			
Gearbox Oil Seal	- Front	304506	304507		
	- Rear	9217 [Ext. Housing] 456812 [3.0 Auto.]	9636		
Pinion Oil Seal		9739 [Fr. axle] 457212/15 [Rr. axle]	9637 [Import] 2738 [Local]		
Spark Plug Tube Seal					
Rear Main Bearing Oil Seal		9111412 [2.8] 9611412 [2.8 Alt.] 9301 [3.0]	9426 [1.6] 9620 [1.8, 2.0]	9426	8510308 [2.0] 9085 [1.5] 9086 [EVO X]
Timing Cover / Cam Oil Seal		9627 [Cam] 385006 [T/Cover] 507411 [T/Cover]	9627 [Cam] 446007 [T/Cover]	355008 [Cam] 9627 [T/Cover 1.6]	9084 [T/Cover 1.5] 9328 [T/Cover 2.0]
Rear Wheel Bearing	- Inner	46T0808 + RR44 [2.8] 46T0808 + RR47 [3.0]	29710+49 [Import] U399+360 + 1852119 [Local]	HUB206 [Gear type ABS] HUB207 [Gear type ABS]	HUB314 [with integrated ABS sensor] HUB316 [with integrated ABS sensor]
	- Outer				
Rear Wheel Oil Seal	- Inner	9955 [Import]		HUB UNIT	HUB UNIT
	- Outer	507509	9628 [Import] 9415 [Local]		
Rear Wheel Kit		PQ647 [2.8] PQ646 [3.0]	PQ282 [Import] PQ176 [Local]	PQ905 [4 Studs] PQ906 [5 Studs]	PQ577 [OD: 73.8mm] PQ995 [EVO X]
Rear Wheel Hub / Stub Axle					

APPLICATIONS	LOCATION	MITSUBISHI OUTLANDER 4X4 2.4 GLS MPV & SUV 4G69	MITSUBISHI OUTLANDER 4X4 2.4 4B12	MITSUBISHI PAJERO 4X4 2.8 TDi 3.0 V6 SWB GLS Wagon 6G72 Pet. 3.5 V6 SWB GLS Wagon 6G74 Pet.	MITSUBISHI PAJERO 4X4 3.2 DI-D 3500 3.8i
		YEARS	03-08	07-14	90-01
Front Wheel Bearing	- Inner	DACFWBMITLAN	DACFWBDC	102910+49	HUB251A
	- Outer			102910+49	
Front Wheel Oil Seal	- Inner	Sealed Bearing	Sealed Bearing	9891	HUB UNIT
	- Outer				
Front Wheel Kit		PQ904	PQ576	PQ428	PQ772A
Front Wheel Hub / Stub Axle				428HUB	Supplied with Bearing
Alternator / Generator Bearing	- Front			B15-86	
	- Rear			62012RS B8-79D 63022RS	
Concentric / Thurst Bearing			Concentric Slave Cylinder	RB9562 [3.0 91-94] RB9876 [3.0 94-01]	RB9660
Diff Carrier Bearing	- Left			17831+887 [Fr. axle] 102910+49 [Rr. axle]	
	- Right			17831+887 [Fr. axle] 102910+49 [Rr. axle]	
Diff Pinion Bearing	- Front			HM89410NP [Fr. axle] M88010+43 [Rr. Import] 88610+49 [Rr. Local]	
	- Rear			M88010NP [Fr. axle] ETHM89210SAP [Rr. Import] 802011+48 [Rr. Local]	
Propshaft Support Bearing					
Pulley Bearing					
Spigot Shaft Bearing					
V-Belt Tensioner					
Drive Shaft Oil Seal	- Left			356512	
	- Right			356512	
Gearbox Oil Seal	- Front			9763	
	- Rear				
Pinion Oil Seal				9952 [Fr. axle] 9987 [Rr. axle] 9718 [Rr. Local]	
Spark Plug Tube Seal					
Rear Main Bearing Oil Seal		8510308	8510308	9667	9087 [3500] 9088 [3.8] 9111412 [3.2]
Timing Cover / Cam Oil Seal		355008 [Cam] 446007 [T/Cover]	9328 [T/Cover]	9627 [Cam] 486810 [T/Cover]	304207 [Cam 3500] 507411 [T/Cover 3.2] 9378 [T/Cover 3500] 9390 [T/Cover 3.8]
Rear Wheel Bearing	- Inner	DACRWBMITOUT	HUB287 [with integrated ABS sensor] HUB316 [with integrated ABS sensor]	30208 [Import] U360/399 + 1852119 [Local]	HUB250
	- Outer				
Rear Wheel Oil Seal	- Inner	Sealed Bearing	HUB UNIT	9955 [Import]	HUB UNIT
	- Outer			486510 [Import] 9415 [Local]	
Rear Wheel Kit		PQ907	PQ951 [ID:25mm] PQ995 [ID:27mm]	PQ430 [Import] PQ176 [Local]	PQ771
Rear Wheel Hub / Stub Axle					Supplied with Bearing

APPLICATIONS	LOCATION	2007-	10-13	2007-	
		2007-	10-13	2007-	
		<b>2007-</b>	<b>10-13</b>	<b>2007-</b>	
Front Wheel Bearing	- Inner	<b>HUB251A</b>	<b>HUB368</b>	<b>HUB182</b> [Non ABS]	
	- Outer				
Front Wheel Oil Seal	- Inner	HUB UNIT	HUB UNIT	HUB UNIT	
	- Outer		<b>9140</b>		
Front Wheel Kit		<b>PQ772A</b>	<b>PQ1078</b>	<b>PQ778</b> [6 Studs] [4 Mount Holes]	
Front Wheel Hub / Stub Axle		Supplied with Bearing		Supplied with Bearing	
Alternator / Generator Bearing	- Front				
	- Rear				
Concentric / Thurst Bearing		<b>RB9660</b>		<b>RB9900</b>	
Diff Carrier Bearing	- Left				
	- Right				
Diff Pinion Bearing	- Front				
	- Rear				
Propshaft Support Bearing					
Pulley Bearing					
Spigot Shaft Bearing					
V-Belt Tensioner					
Drive Shaft Oil Seal	- Left			<b>9519</b>	
	- Right				
Gearbox Oil Seal	- Front				
	- Rear			<b>9217</b>	
Pinion Oil Seal					
Spark Plug Tube Seal					
Rear Main Bearing Oil Seal		<b>9088</b> [3.8] <b>9111412</b> [3.2]		<b>9111412</b> [2.4, 3.2, 3.5] <b>9112</b> [2.5]	
Timing Cover / Cam Oil Seal		<b>507411</b> [T/Cover 3.2] <b>9390</b> [T/Cover 3.8]		<b>446007</b> [T/Cover 2.4, 2.5] <b>507411</b> [T/Cover 3.2, 3.5] <b>9627</b> [Cam 2.5]	
Rear Wheel Bearing	- Inner	<b>HUB250</b> [Alt.] <b>HUB367</b>	<b>HUB250</b> [Alt.] <b>HUB367</b>	<b>46T0808 + RR47</b>	
	- Outer				
Rear Wheel Oil Seal	- Inner	HUB UNIT	HUB UNIT		
	- Outer			<b>507509</b>	
Rear Wheel Kit		<b>PQ771</b> [Alt.] <b>PQ1077</b> [14mm Mounting Holes]	<b>PQ771</b> [Alt.] <b>PQ1077</b> [14mm Mounting Holes]	<b>PQ646</b>	
Rear Wheel Hub / Stub Axle		Supplied with Bearing	Supplied with Bearing		

APPLICATIONS	LOCATION	NISSAN 1-TONNER/ HARDBODY AW/D21 1.6 L16S-J 1.8 L18S-R 2.0 NA20 2.4 Z24/S	NISSAN 1-TONNER/ HARDBODY AW/D21 2.5D TD25i 2.7D TD27 3.0 VG30E	NISSAN 1-TONNER/ HARDBODY AW/D21 4X4 2.4 Z24S	NISSAN 1-TONNER/ HARDBODY AW/D21 4X4 2.7 TD27 3.0 VG30E
		YEARS	88-98	88-98	88-98
Front Wheel Bearing	- Inner	48510+48	48510+48	603011+49	603011+49
	- Outer	12610+49	12610+49	300811+49	300811+49
Front Wheel Oil Seal	- Inner	546513	546513		
	- Outer			9821 9821A Alt.	9821 9821A Alt.
Front Wheel Kit		PQ178	PQ178	PQ352	PQ352
Front Wheel Hub / Stub Axle		178HUB	178HUB	352HUB	352HUB
Alternator / Generator Bearing	- Front	62012RS [Bosch] 62022RS [Hitachi]	62012RS [Bosch] 62022RS [Hitachi]	62012RS [Bosch] 62022RS [Hitachi]	62012RS [Bosch] 62022RS [Hitachi]
	- Rear	62012RS [Hitachi] 63032RS [Bosch]	62012RS [Hitachi] 63032RS [Bosch] B10-50D [3.0 only]	62012RS [Hitachi] 63032RS [Bosch]	62012RS [Hitachi] 63032RS [Bosch]
Concentric / Thurst Bearing		RB9585	RB9805 [2.5] RB9603 [2.7] RB9585 [3.0]	RB9585	RB9603 [2.7] RB9585 [3.0]
Diff Carrier Bearing	- Left	32012X [Diff Lock] 501310+49 [No Diff lock]	32012X [Diff Lock] 501310+49 [No Diff lock]	30208 [Front Diff] 17831+887 [Rear Diff]	30208 [Front Diff] 501310+49 [Rear Diff]
	- Right	32012X [Diff Lock] 501310+49 [No Diff lock]	32012X [Diff Lock] 501310+49 [No Diff lock]	B32-10 [Outer Front Diff] 30208 [Inner Front Diff] 17831+887 [Rear Diff]	30208 [Front Diff] 501310+49 [Rear Diff]
Diff Pinion Bearing	- Front	86610+49	86610+49	32306 [Fr. + Rr. Diff]	32305 [Front Diff] 86610+49 [Rear Diff]
	- Rear	88610+49	88610+49	TR0708-I-N [Front Diff] TR0708-1IRN [Rear Diff]	32307 [Front Diff] 88610+49 [Rear Diff]
Propshaft Support Bearing					
Pulley Bearing					
Spigot Shaft Bearing		Bush			
V-Belt Tensioner					
Drive Shaft Oil Seal	- Left	9692	9692	9863 [Side Shaft L/R Fr.]	9863 [Side Shaft L/R Fr.]
	- Right	9692	9692		
Gearbox Oil Seal	- Front	304508	304508	304508 9823 [Transfer Case]	304508 9823 [Transfer Case]
	- Rear	355012 405810	355012 405810	9680	355010
Pinion Oil Seal		9680 [Diff Lock] 9718 [No Diff lock]	9680 [Diff Lock] 9718 [No Diff lock]	9605 [Front Diff] 9822 [Rear Diff]	9605 [Front Diff] 9680 [Rear Diff]
Spark Plug Tube Seal					
Rear Main Bearing Oil Seal		8010010 [1.6, 1.8] 8010012 [2.0, 2.4]	9814 [2.5, 2.7] 9729 [3.0]	8010012	9814 [2.7] 9729 [3.0]
Timing Cover / Cam Oil Seal		487009 [T/Cover]	9818 [T/Cover 2.5, 2.7] 9728 [T/Cover 3.0] 9866 [Cam 3.0 only]	487009 [T/Cover]	9666 [Cam x 2 3.0] 9818 [T/Cover 2.7] 9728 [T/Cover 3.0]
Rear Wheel Bearing	- Inner	U399+360 + 1852119	U399+360 + 1852119	30208 [Import] U399+360 + 1852119 [Local]	U399+360 + 1852119
	- Outer				
Rear Wheel Oil Seal	- Inner			355511 [Import]	
	- Outer	9415	9415	9813 [Import] 9415 [Local]	9415
Rear Wheel Kit		PQ176	PQ176	PQ351 [Import] PQ176 [Local]	PQ176
Rear Wheel Hub / Stub Axle					

APPLICATIONS	LOCATION	NISSAN 720 D20 1.8 L18S Kingcab, Sport 2.2D SD/Z22 Tracker 2.3 SD23	NISSAN 720 D20 4X4 1.8 L18S 2.0 NA20 2.2 Z22	NISSAN ALMERA 1.5 HR15DE[2013-] 1.6 Comfort, Elegance, Luxury 16DE/GA16DE 1.8 Elegance, Luxury 18DE	NISSAN B140 1.4 A14SP/van, S/W, Deluxe, Std. Sport, CHAMP P/up
YEARS		80-88	80-88	01-06 2013-	80-08
Front Wheel Bearing	- Inner	48510+48	C. 104912/49 [Free Hub 1.8 -84] A., B 603011+49 [Free Hub All -88]	DACFWBNM [2013-] 40BWD15A	44610+49
	- Outer	12610+49	B., D. 104912/49 [Fixed Hub 1.8 -84] A, C. 300811+49 [Free Hub] B., D 603011+49 [Fixed Hub]		11710+49
Front Wheel Oil Seal	- Inner	546513	9612 [C, D 1.8 -84] 9696 [A, B All -88]	Sealed Bearing	486206D [80-83] 425507D [83-08]
	- Outer		9611 [C,D 1.8 -84] 9697 [A, B All -88]		
Front Wheel Kit		PQ178		PQ622 [2013 -] PQ641	PQ232 [80-83] PQ121 [83-08]
Front Wheel Hub / Stub Axle		178HUB		622CHUB [25 Spline] [2013-] 641HUB [25 Spline] 641BHUB [27 Spline]	121HUB
Alternator / Generator Bearing	- Front	6201ZZ	6201ZZ		62032RS
	- Rear	62032RS	62032RS		62012RS
Concentric / Thurst Bearing		RB9585	RB9585	RB9853	RB9585
Diff Carrier Bearing	- Left	30208 [Import] 501310+49 [Local]	30208 [Fr. + Rr. Diffs]	6208 NITI386319	501310+49 [80-93] 30207 [93-08]
	- Right	30208 [Import] 501310+49 [Local]		6208 NITI386319	501310+49 [80-93] 30207 [93-08]
Diff Pinion Bearing	- Front	30306 [Import] 86610+49 [Local]	32305 [Front Diff] 30306 [Imported Rear] 86610+49 [Local Rear]		86610+49 [80-93] 32305 [93-08]
	- Rear	32307 [Import] 88610+49 [Local]	32307 [Fr. + Rr. Diffs]		88610+49 [80-93] 32306 [93-08]
Spigot Shaft Bearing		Bush			Bush
Drive Shaft Oil Seal	- Left	325211	325211	9872	
	- Right	325211	325211	9872	
Gearbox Oil Seal	- Front	304508	304508	9757	304508 [80-93] 244008 [93-08]
	- Rear	355010	355010	9872 [T/case] [OD:56mm] 9306 [T/case] [OD:55mm]	9610
Pinion Oil Seal		457512 [Import] 2738 [Local]	9605 [Front Diff] 457512 [Import Rear] 9680 [Local Rear]		2738 [80-93] 356413 [93-08]
Rear Main Bearing Oil Seal		8010010 [2.2] 8010012 [1.8, 2.3]	8010012	9825 9311 [2013-]	608212
Timing Cover / Cam Oil Seal		487009 [T/Cover 1.8] 588012SP [T/Cover 2.2, 2.3]	487009 [T/Cover]	405207 [T/Cover]	385509 [T/Cover]
Rear Wheel Bearing	- Inner	30208 [Import] U399+360 + 1852119 [Local]	30208 [Import] U399+360 + 1852119 [Local]	HUB097 [Non ABS] HUB098 [Gear Type ABS] HUB205 [Alternative] [Gear Type ABS] DAC255548 [2013-]	412971 + RR30
	- Outer				
Rear Wheel Oil Seal	- Inner	345511 [Axle Shaft]	345511 [Axle Shaft]	HUB UNIT	Sealed Bearing
	- Outer	506711 [Import] 9415 [Local]	506711 [Import] 9415 [Local]		
Rear Wheel Kit		PQ183 [Import] PQ176 [Local]	PQ183 [Import] PQ176 [Local]	PQ640 [ID: 40mm] PQ698 PQ699 [OD: 148mm] PQ902 [OD: 134mm] PQ713 [2013-]	PQ154
Rear Wheel Hub / Stub Axle				SA713	

APPLICATIONS	LOCATION	NISSAN DATSUN GO/ GO+ 1.2 HR12DE	NISSAN E20 1.8 L18 Bus, P/van Coach, Coach GL, GLE, Econolux, Ekonovan, Ekonowagon 2.0 Bus, Van H20	NISSAN HARDBODY QW/D22 2.0 NA20S 2.0i KA20 2.4i Z24, KA24E/DE	NISSAN HARDBODY QW/D22 2.7D TD27i 3.0 i VG30E 3.0TD ZD30 , ZD30D, ZD30DDT 3.2 QD32 3.3i VG33E
		YEARS	2014-	80-96	98-11
Front Wheel Bearing	- Inner	12807S	48510+48	48510+48	48510+48
	- Outer		12610+49	12610+49	12610+49
Front Wheel Oil Seal	- Inner	Sealed Bearing	546513	546513	546513
	- Outer				
Front Wheel Kit		PQ467	PQ178	PQ178	PQ178
Front Wheel Hub / Stub Axle		622CHUB	178HUB	178AHUB [Non ABS]	178AHUB [Non ABS]
Alternator / Generator Bearing	- Front		62032RS	63032RS	63032RS
	- Rear		62012RS	B10-50D	B10-50D
Concentric / Thurst Bearing		Concentric Slave Cylinder	RB9585	RB9801	RB9603 [2.7] RB9801 [3.0 -01] RB9691 [3.0, i 01-08, 3.2, 3.3i] RB9630 [3.0TDi]
Diff Carrier Bearing	- Left		17831+887 [Import LWB] 30208 [Import SWB] 501310+49 [Local]	501310+49	32012X [Diff Lock] 501310+49 [No Diff lock]
	- Right		17831+887 [Import LWB] 30208 [Import SWB] 501310+49 [Local]	501310+49	32012X [Diff Lock] 501310+49 [No Diff lock]
Diff Pinion Bearing	- Front		30306 [Import SWB] 32306 [Import LWB] 86610+49 [Local]	86610+49	86610+49
	- Rear		32307 [Import SWB/LWB] 88610+49 [Local]	88610+49	88610+49
Propshaft Support Bearing					
Spigot Shaft Bearing			Bush		
V-Belt Tensioner					
Drive Shaft Oil Seal	- Left	9158		9692	9692
	- Right			9692	9692
Gearbox Oil Seal	- Front		304508	304508	304508
	- Rear		355010	354712	354712 [2.7, 3.2, 3.3] 405810 [3.0] 9203 [3.0i]
Pinion Oil Seal			427612SP [Import LWB] 457512 [Import SWB] 2738 [Local]	9680	9680 [Diff Lock] 9718 [No Diff lock]
Spigot Shaft Seal		9757			
Rear Main Bearing Oil Seal		9311	8010012	9648	9202FS [2.7, 3.0TD, 3.2, 3.3 -08] 9111FS [Alt. 3.0i, 3.0TD] 9825 [3.0,i 04-10] 9729 [3.0 -04]
Timing Cover / Cam Oil Seal		9966	487009 [T/Cover 1.8] 456812 [T/Cover 2.0]	487009 [T/Cover 2.0 -04] 9868 [T/Cover 98-10]	9126 [T/Cover 3.0] [ID: 52mm] 9666 [Cam] 9728 [T/Cover 3.0] 9818 [T/Cover Others]
Rear Wheel Bearing	- Inner	DAC255548	30208 [Import] U399+360 + 1852119 [Local]	U399+360 + 1852119	U399+360 + 1852119 [98-04] DAC4TCR1 [04-10]
	- Outer				
Rear Wheel Oil Seal	- Inner	Sealed Bearing	345511 [Axle Shaft]		
	- Outer		506711 [Import] 9415 [Local]	9415	9415 [98-04] 9295 9105
Rear Wheel Kit		PQ713	PQ183 [Import] PQ176 [Local]	PQ176	PQ176 [98-04] PQ1055L/R [04-10]
Rear Wheel Hub / Stub Axle		SA713			

APPLICATIONS	LOCATION	NISSAN HARDBODY QW/D22 4X4 2.4i KA24E 2.7 TD27	NISSAN HARDBODY QW/D22 4X4 3.0 VG30E 3.0TD ZD30 , ZD30D, ZD30DDT 3.2 3.2D QD32 3.3i VG33	NISSAN HARDBODY NP300 D22 2.0i, S, SE KA20 2.5TDi, S, SE YD25	NISSAN HARDBODY NP300 D22 2.4i, S/C, D/C Highrider KA24 DE 2.5TDi, S, SE Highrider YD25
		YEARS	98-10	98-10	2008-
Front Wheel Bearing	- Inner	603011+49	603011+49	48510+48	603011+49
	- Outer	300811+49	300811+49	12610+49	300811+49
Front Wheel Oil Seal	- Inner			546513	
	- Outer	9821 9821A Alt.	9821 9821A Alt.		9821 9821A Alt.
Front Wheel Kit		PQ352	PQ352	PQ178	PQ352
Front Wheel Hub / Stub Axle		352HUB	352HUB	178AHUB [Non ABS] SA178L/R	352AHUB
Alternator / Generator Bearing	- Front	63032RS	63032RS	63032RS	63032RS
	- Rear	B10-50D	B10-50D	B10-50D	B10-50D
Concentric / Thurst Bearing		RB9630 [2.4i]	RB9630 [3.0TD] RB9691 [3.0, 3.2, 3.3, 4.2]	RB9801 [2.0] RB9894 [2.5]	RB9630 [2.4] RB9894 [2.5]
Diff Carrier Bearing	- Left	30209 [Front Diff] 17831+887 [Rear Diff]	30209 [Front Diff] 17831+887 [Rear Diff]	501310+49 [2.0] 30209 [2.5]	30209
	- Right	30209 [Front Diff] 17831+887 [Rear Diff]	30209 [Front Diff] 17831+887 [Rear Diff]	501310+49 [2.0] 30209 [2.5]	30209
Diff Pinion Bearing	- Front	32305 [Front Diff] 32306 [Rear Diff]	32305 [Front Diff] 32306 [Rear Diff] 32308 [Rear Diff 3.0]	86610+49 [2.0] 32307 [2.5]	32307
	- Rear	32307 [Front Diff] 32306 [Rear Diff]	32307 [Front Diff] 32306 [Rear Diff]	88610+49 [2.0] 32306 [2.5]	32306
Propshaft Support Bearing					
Spigot Shaft Bearing					
V-Belt Tensioner					
Drive Shaft Oil Seal	- Left	9863 [Side Shaft L/R Fr.]	9863 [Side Shaft LHS Fr. axle]	9692	9692
	- Right		9863 [Side Shaft RHS Fr. axle]	9692	9692
Gearbox Oil Seal	- Front	304508	304508	304508 [2.0] 9823 [2.5]	304508
	- Rear	355010	9203 [Ext. Housing]	354712 [2.0] 9203 [2.5]	9203
Pinion Oil Seal		9212 [Front Diff 2.4] 9213 [Front Diff 2.7] 9201 [Rear Diff]	9212 [Front Diff -2003] 9213 [Front Diff 03-10] 9201 [Rear Diff]	9201 9141 [Alt.]	9201 9141 [Alt.]
Spark Plug Tube Seal					
Rear Main Bearing Oil Seal		9648 [2.4] 9202FS [2.7]	9202FS [3.0TD, 3.2, 3.3 -08] 9111FS [Alt. 3.0] 9825 [3.0,i 04-10] 9729 [3.0 -2004] 9648 [3.0TD -2004]	9648 [2.0] 9729 [2.5]	9729 [2.5] 9730 [2.4]
Timing Cover / Cam Oil Seal		9868 [T/Cover 2.4] 9818 [T/Cover 2.7]	9126 [T/Cover 3.0] [ID: 52mm] 9868 [T/Cover 3.0TD] [ID: 46mm] 9818 [T/Cover Rest]	9309 [T/cover 2.5]	9309 [T/cover 2.5] 9868 [T/cover 2.4]
Rear Wheel Bearing	- Inner	U399+360 + 1852119 [98-04] DAC4TCR1 [04-10]	U399+360 + 1852119 [98-04] DAC4TCR1 [04-10]	DAC4TCR1	DAC4TCR1
	- Outer				
Rear Wheel Oil Seal	- Inner				
	- Outer	9415 [98-04] 9295 9105	9415 [98-04] 9295 9105	9295 9105	9295 9105
Rear Wheel Kit		PQ176 [98-04] PQ1055L/R	PQ176 [98-04] PQ1055L/R	PQ1055L/R	PQ1055L/R
Rear Wheel Hub / Stub Axle					



APPLICATIONS	LOCATION	NISSAN HARDBODY NP300 D22 4X4	NISSAN INTERSTAR	NISSAN JUKE	NISSAN LANGLEY
		2.4i, S/C, D/C, Highrider KA24 DE 2.5TDi, S, SE, Highrider YD25	2.5DCi SR, HR P/Van	4X2, 4X4 1.2 DIG-T HRA2DDT 1.5 dCi K9K 1.6 HR16DE 1.6 DIG-T MR16DDT	1.3 GL E13 1.5 GL, L, SSS, Trebon, Exa Turbo E15
YEARS		2008-	2006-	2010-	83-88
Front Wheel Bearing	- Inner	603011+49	DACFWBNI	HUB150 [with integrated ABS sensor]	68110+49 [1.3] 29710+48 [Imp. 1.5] 29710+49 [Local 1.5]
	- Outer	300811+49			68110+49 [1.3] 29710+48 [Imp. 1.5] 29710+49 [Local 1.5]
Front Wheel Oil Seal	- Inner	9107	Sealed Bearing	HUB UNIT	9418 [1.3] 9419 [Imp./Loc. 1.5]
	- Outer	9821			
Front Wheel Kit		PQ1070	PQ626	PQ631 [5 Studs] [Flange Ø: 136mm]	PQ289 [1.3] PQ290 [Imp. 1.5] PQ109 [Local 1.5]
Front Wheel Hub / Stub Axle					109HUB [Local 1.5]
Alternator / Generator Bearing	- Front	63032RS			62032RS
	- Rear	B10-50D			62002RS
Concentric / Thurst Bearing		RB9630 [2.4] RB9894 [2.5]	Concentric Slave Cylinder	Concentric Slave Cylinder	RB9840
Diff Carrier Bearing	- Left	30208 [Front Diff] 30209 [Rear Diff]			30208
	- Right	30208 [Front Diff] 30209 [Rear Diff]			30208
Diff Pinion Bearing	- Front	32307 [Fr. & Rr.]			6209C3
	- Rear	32305 [Front Diff] 32306 [Rear Diff]			6209C3
Propshaft Support Bearing					
Pulley Bearing					
Spigot Shaft Bearing					Bush
V-Belt Tensioner					
Drive Shaft Oil Seal	- Left		9307		9756
	- Right		9307		9756
Gearbox Oil Seal	- Front	9823			9757
	- Rear	9203			405607
Pinion Oil Seal		9213 [Front Diff] 9201 [Rear Diff] 9141 [Alt.]			9656 [Side Flange]
Spark Plug Tube Seal					
Rear Main Bearing Oil Seal		9729 [2.5] 9730 [2.4]	9308	9311 (1.2, 1.6) 9326 (1.5)	8010010
Timing Cover / Cam Oil Seal		9309 [T/covers 2.5] 9868 [T/covers 2.4]	254207 [Cam] 425406 [T/Cover]	405207 (T/Cover 1.2) 9569 (T/Cover 1.5) 9868 (T/Cover 1.6) 9966 (Cam 1.2, 1.6 HR16DE)	9754 [T/Cover] 9755 [Cam]
Rear Wheel Bearing	- Inner	DAC4TCR1	DACRWBNI	HUB151 [with integrated ABS sensor] HUB152 [with integrated ABS sensor]	331274
	- Outer				11910+49
Rear Wheel Oil Seal	- Inner		Sealed Bearing	HUB UNIT	
	- Outer	9295 9105			9420
Rear Wheel Kit		PQ1055L/R	PQ804	PQ820 [5 Studs] PQ821 [5 Studs] [1.6 DIG-T 4X4]	PQ152
Rear Wheel Hub / Stub Axle					



APPLICATIONS	LOCATION	NISSAN LAUREL	NISSAN LIVINA	NISSAN GRAND	NISSAN MAXIMA
		C31 2.0 CA/L20 2.8 SGL 5L28	1.6 Acenta, +, Visia, X-Gear	LIVINA 1.6 Acenta, + HR16DE	GV Series 300SE VG30E
YEARS		80-87	07-15	08-14	91-97
Front Wheel Bearing	- Inner	67010+48	HUB146 [with integrated ABS sensor]	HUB146 [with integrated ABS sensor]	42BWD06
	- Outer	11910+49			
Front Wheel Oil Seal	- Inner	9491	HUB UNIT	HUB UNIT	9986
	- Outer				9986
Front Wheel Kit		PQ138	PQ621 [Rim: 3 Hole] [4 Studs] [Flange Ø: 136mm]	PQ621 [Rim: 3 Hole] [4 Studs] [Flange Ø: 136mm]	PQ447
Front Wheel Hub / Stub Axle					447HUB
Alternator / Generator Bearing	- Front	62032RS			
	- Rear	62002RS			6302 2RS
Concentric / Thurst Bearing		RB9585	Concentric Slave Cylinder	Concentric Slave Cylinder	
Diff Carrier Bearing	- Left	30208 [Import] 501310+49 [Local]	NITI386319	NITI386319	30208
	- Right	30208 [Import] 501310+49 [Local]	NITI386319	NITI386319	30208
Diff Pinion Bearing	- Front	32305 [Import] 86610+49 [Local]			
	- Rear	32307 [Import] 88610+49 [Local]			
Propshaft Support Bearing					
Pulley Bearing					
Spigot Shaft Bearing		Bush			
V-Belt Tensioner					
Drive Shaft Oil Seal	- Left		9756	9306 [1.6]	
	- Right		9756	9306 [1.6]	
Gearbox Oil Seal	- Front	345007 [Man. 2.0] 406010 [Auto. 2.0] 304508 [2.8]	254207	254207	
	- Rear	355010	9306 [T/case]	9306 [T/case]	
Pinion Oil Seal		457512 [Import] 2738 [Local]			
Spark Plug Tube Seal					
Rear Main Bearing Oil Seal		9729 [2.0] 8010012 [2.8]	9311 [1.6]	9311 [1.6]	9729
Timing Cover / Cam Oil Seal		9728 [T/Cover 2.0] 487009 [T/Cover 2.8]	405207 [T/Cover 1.6]	405207 [T/Cover 1.6]	9666 [Cam] 9728 [T/Cover]
Rear Wheel Bearing	- Inner	B32-10 + RR43 [Import] 1700289 + RR35 [Local]	HUB151 [with integrated ABS sensor]	HUB147 [with integrated ABS sensor]	HUB085 [Gear Type ABS]
	- Outer				
Rear Wheel Oil Seal	- Inner		HUB UNIT	HUB UNIT	HUB UNIT
	- Outer	415607 [Import] 2641 [Local]			
Rear Wheel Kit		PQ186 [Import] PQ145 [Local]	PQ820 [5 Studs]	PQ801 [Flange Ø: 148mm]	PQ446
Rear Wheel Hub / Stub Axle					

APPLICATIONS	LOCATION	NISSAN MAXIMA CA33 & QX Series 2.0 VQ20E 3.0 VQ30DE	NISSAN MICRA (K12) 1.4 Accenta, Accenta+, Accenta Sport, Visia, Comfort, Elegance, SE CR14DE 1.5 dCi Tekna, Acenta K9K	NISSAN MICRA (K13) 1.2 Pet. HR12DE 1.5 dCi Tekna, Acenta HR15DE, K9K	NISSAN MICRA (K14) 0.9 H4B 408, HR09DET 1.0 HR10DDT
		YEARS	96-04	02-10	2010-
Front Wheel Bearing	- Inner	42BWD06	DACFWBNM [ASB]	DACFWBNM [ASB]	DACFWBNM [ASB]
	- Outer				
Front Wheel Oil Seal	- Inner	9986	Sealed Bearing	Sealed Bearing	Sealed Bearing
	- Outer	9986			
Front Wheel Kit		PQ447	PQ622 [ID: 37mm]	PQ622 [ID: 37mm]	PQ622 [ID: 37mm]
Front Wheel Hub / Stub Axle		447AHUB	622HUB [23 Splines] 622CHUB [1.4] [25 Splines]	622CHUB [25 Splines]	622CHUB [25 Splines]
Alternator / Generator Bearing	- Front				
	- Rear				
Concentric / Thrust Bearing		RB9805	Concentric Slave Cylinder	Concentric Slave Cylinder	RB9622
Diff Carrier Bearing	- Left	42KWD01 [2.0] 32009 [3.0]			NITI386319 [Front Diff]
	- Right	42KWD01 [2.0] 32009 [3.0]			NITI386319 [Front Diff]
Diff Pinion Bearing	- Front				
	- Rear				
Propshaft Support Bearing					
Pulley Bearing					
Spigot Shaft Bearing					
V-Belt Tensioner					
Drive Shaft Oil Seal	- Left	9211 9791	9306 9756 [1.4]	9306 9756	9306
	- Right	9211	9306 9756 [1.4]	9306 9756	9306
Gearbox Oil Seal	- Front	9204			
	- Rear	274308			
Pinion Oil Seal					
Spark Plug Tube Seal					
Rear Main Bearing Oil Seal			9311 [1.2] 9648 [1.5 DCi] 9729 [1.4]	9311 [1.2] 9648 [1.5 DCi]	9326
Timing Cover / Cam Oil Seal		9965 [T/Cover]	284205 [Cam 1.5 DCi] 9569 [Cam 1.5 DCi] 405207 [T/Cover 1.4]	284205 [Cam 1.5 DCi] 9569 [Cam 1.5 DCi]	9569 [T/Cover] 284205 [Cam]
Rear Wheel Bearing	- Inner	HUB086 [Gear Type ABS] HUB362 [Gear Type ABS]	FC12784	DAC255548	HUB410
	- Outer				
Rear Wheel Oil Seal	- Inner	HUB UNIT	Sealed Bearing	Sealed Bearing	HUB UNIT
	- Outer				
Rear Wheel Kit		PQ629 PQ1064 [Later Models 2.0]	PQ487 [OD: 52mm]	PQ713 [OD: 55mm]	PQ1141
Rear Wheel Hub / Stub Axle			SA487	SA713 [1.2]	

APPLICATIONS	LOCATION	NISSAN MURANO 3.5 V6 SUV	NISSAN MURANO 4X4 3.5i V6 SUV	NISSAN NAVARA & PATHFINDER D40 4X2 2.5DCi, LE, SE, XE D/Cab P/up 4.0i V6, LE D/Cab P/up	NISSAN NAVARA & PATHFINDER D40/ R51 4X4 2.5DCi D/Cab P/up 3.0DCi V6 4.0i V6, LE D/Cab P/up
YEARS		2005-	05-10 01-15	05-17	05-17
Front Wheel Bearing	- Inner	<b>HUB148</b> [with integrated ABS sensor]	<b>HUB148</b> [with integrated ABS sensor] <b>HUB357</b> [with integrated ABS sensor]	<b>HUB317</b> [with integrated ABS sensor] <b>HUB383</b> [with integrated ABS sensor]	<b>HUB153</b> [with integrated ABS sensor] <b>HUB208</b> [with integrated ABS sensor]
	- Outer				
Front Wheel Oil Seal	- Inner	HUB UNIT	HUB UNIT	HUB UNIT	HUB UNIT
	- Outer				
Front Wheel Kit		<b>PQ630</b> [5 Studs]	<b>PQ630</b> [5 Studs] [29 Spline] <b>PQ1058</b> [2007-] [ID: 30mm] [32 Spline]	<b>PQ996</b> [Metal Cap] [Width: 46mm, OD: 93mm] <b>PQ1107</b> [Metal Cap] [Width: 61mm, OD: 93mm]	<b>PQ632</b> [29 Splines] [Width: 46mm, OD: 93mm] <b>PQ916</b> [29 Splines] [Width: 61mm, OD: 93mm]
Front Wheel Hub / Stub Axle					
Alternator / Generator Bearing	- Front				
	- Rear				
Concentric / Thurst Bearing				<b>RB9630</b> [6 Spd.] <b>RB9894</b> [5 Spd.]	<b>RB9630</b> [2.5]
Diff Carrier Bearing	- Left	<b>NIMURCB</b> [Rear Diff]	<b>NIMURCB</b> [Rear Diff]	<b>NINAS002</b>	<b>NINAA000</b> [Front Diff] <b>NINAS002</b> [Rear Diff]
	- Right	<b>NIMURCB</b> [Rear Diff]	<b>NIMURCB</b> [Rear Diff]	<b>NINAS002</b>	<b>NINAA000</b> [Front Diff] <b>NINAS002</b> [Rear Diff]
Diff Pinion Bearing	- Front	<b>NIMURFPB</b> [Rear Diff]	<b>NIMURFPB</b> [Rear Diff]	<b>NINAS000</b>	<b>NINAA001</b> [Front Diff] <b>NINAS000</b> [Rear Diff]
	- Rear	<b>NIMURRPB</b> [Rear Diff]	<b>NIMURRPB</b> [Rear Diff]	<b>NINAS001</b>	<b>NINAA002</b> [Front Diff] <b>NINAS001</b> [Rear Diff]
Propshaft Support Bearing					
Pulley Bearing					
Spigot Shaft Bearing					
V-Belt Tensioner					
Drive Shaft Oil Seal	- Left	<b>9313</b>	<b>9313</b>		
	- Right	<b>9313</b>	<b>9313</b>		
Gearbox Oil Seal	- Front			<b>9319</b>	<b>9319</b>
	- Rear	<b>9204</b> [T/case]	<b>9204</b> [T/case]	<b>9321</b>	<b>9320</b> <b>9322</b> [T/case R] <b>9323</b> [T/case Fr.] <b>9321</b> [Ext. Housing]
Pinion Oil Seal		<b>9314</b> [Front Diff] <b>9315</b> [Front Diff Alt.] <b>9316</b> [Rear Diff]	<b>9314</b> [Front Diff] <b>9315</b> [Front Diff Alt.] <b>9316</b> [Rear Diff]	<b>9325</b>	<b>9324</b> [Front Diff] <b>9325</b> [Rear Diff]
Spark Plug Tube Seal					
Rear Main Bearing Oil Seal				<b>9825</b>	<b>9729</b> [Pathfinder] <b>9825</b>
Timing Cover / Cam Oil Seal		<b>9965</b> [T/Cover]	<b>9965</b> [T/Cover]	<b>9309</b> [T/Cover 2.5] <b>9965</b> [T/Cover 4.0]	<b>9309</b> [T/Cover 2.5] <b>9965</b> [T/Cover 4.0]
Rear Wheel Bearing	- Inner	<b>HUB149</b> [with integrated ABS sensor]	<b>HUB149</b> [with integrated ABS sensor]	<b>U497+460 + RR21</b> <b>HUB209</b>	<b>U497+460 + RR21</b> <b>HUB209</b>
	- Outer				
Rear Wheel Oil Seal	- Inner	HUB UNIT	HUB UNIT	HUB UNIT	HUB UNIT
	- Outer			<b>9502</b> <b>9562</b>	<b>9502</b> <b>9562</b>
Rear Wheel Kit		<b>PQ807</b>	<b>PQ807</b>	<b>PQ794</b> <b>PQ917</b>	<b>PQ794</b> <b>PQ917</b> [Pathfinder]
Rear Wheel Hub / Stub Axle					

APPLICATIONS	LOCATION	NISSAN NP200 1.5DCi S, SE P/up K9K 1.6 S, SE P/up Pet. 8V K7M, 16V K4M NV200 1.5 DCi 1.6 HR16DE	NISSAN NV350 IMPENDULO 2.5 QR25DE 2.5D YD25DDTi	NISSAN PATROL 4X4 Y60 3.0 VG30E	NISSAN PATROL 4X4 Y61 3.0Di 4.2 TD42
YEARS		2008- 2013-	2013-	95-00	99-04
Front Wheel Bearing	- Inner	DACFWBNM [ASB] HUB408 [NV200]	HUB332	603011+49	603011+49
	- Outer			300811+49	300811+49
Front Wheel Oil Seal	- Inner	Sealed Bearing HUB UNIT	HUB UNIT		
	- Outer			9821 9821A Alt.	9821 9821A Alt.
Front Wheel Kit		PQ622 PQ1138 [NV200]	PQ1021 PQ1021COMP	PQ352	PQ352
Front Wheel Hub / Stub Axle		622HUB [23 Spline] SA622L/R [NP200]	1021HUB	352HUB	352HUB
Alternator / Generator Bearing	- Front			62012RS [Bosch] 62022RS [Hitachi]	63032RS
	- Rear			62012RS [Hitachi] 63032RS [Bosch]	B10-50D
Concentric / Thurst Bearing		RB9622	RB9630	RB9585	RB9630 [3.0D]
Diff Carrier Bearing	- Left	NITI386319 [NV200]	30209	30208 [Front Diff] 501310+49 [Rear Diff]	30209 [Front Diff] 17831+887 [Rear Diff]
	- Right	NITI386319 [NV200]	30209	30208 [Front Diff] 501310+49 [Rear Diff]	30209 [Front Diff] 17831+887 [Rear Diff]
Diff Pinion Bearing	- Front		32306	32305 [Front Diff] 86610+49 [Rear Diff]	32305 [Front Diff] 32308 [Rear Diff 3.0] 32306 [Rear Diff 4.2]
	- Rear		32307	32307 [Front Diff] 88610+49 [Rear Diff]	32307 [Front Diff] 32306 [Rear Diff]
V-Belt Tensioner					
Drive Shaft Oil Seal	- Left	9110 1.5DCi 9306 (1.6 16v)		9863 [Side Shaft LHS Fr. axle]	9863 [Side Shaft LHS Fr. axle]
	- Right	9310 (1.5DCi, 1.6 16v)		9863 [Side Shaft RHS Fr. axle]	9863 [Side Shaft RHS Fr. axle]
Gearbox Oil Seal	- Front			304508 9823 [Transfer Case]	304508
	- Rear	9307		355010	9203 [Ext. Housing]
Pinion Oil Seal			9141	9605 [Front Diff] 9680 [Rear Diff]	9213 [Front Diff 3.0] 9212 [Front Diff 4.2] 9201 [Rear Diff]
Spark Plug Tube Seal					
Rear Main Bearing Oil Seal		9326 [1.5] 9648 [1.6]	9825	9729	9825 [3.0D] 9202FS [4.2]
Timing Cover / Cam Oil Seal		284205 [Cam] 354807 [T/Cover] 9569 [T/Cover DCi]	9868 [T/Cover 2.5D]	9666 [Cam X2] 9728 [T/Cover]	9868 [T/Cover 3.0D] 9818 [T/Cover 4.2]
Rear Wheel Bearing	- Inner	FC12784P DACRWB207 HUB273 [NV200]	DRT42NV350	DACPQBPAT	DACPQBPAT
	- Outer				
Rear Wheel Oil Seal	- Inner	Sealed Bearing	9099	9542	9542
	- Outer		9295	9541	9541
Rear Wheel Kit		PQ487 [ID: 25mm] PQ826 [ID: 30mm] PQ1080 [NV200]	PQ1022	PQ884	PQ884
Rear Wheel Hub / Stub Axle		SA826 [NP200]	1022HUB		

APPLICATIONS	LOCATION	NISSAN PRIMASTAR 1.9 DCi Minibus	NISSAN PRIMERA 160 Si, SE SR16DE 200 GSi, Si, STI, Elegance, Luxury SR20DE	NISSAN PULSAR 1.3 S E13 1.4 DL, GX A14 1.5 GL, Panache, SX E15	NISSAN QASHQAI 4X2 1.5 Dies. K9K 1.6 Pet. HR16DE 2.0 dCi Accent Dies. M1D, M9R 2.0 Accent, n-tec Pet. MR20DE
YEARS		07-11	98-02	80-87	07-13
Front Wheel Bearing	- Inner	DACFWBNP [ASB]	42BWD06	68110+49 [1.3] 29710+48 [Imp. 1.4, 1.5] 29710+49 [Loc. 1.4, 1.5]	HUB150 [with integrated ABS sensor]
	- Outer			68110+49 [1.3] 29710+48 [Imp. 1.4, 1.5] 29710+49 [Loc. 1.4, 1.5]	
Front Wheel Oil Seal	- Inner	Sealed Bearing	9986	9418 [1.3] 9419 [1.4, 1.5]	HUB UNIT
	- Outer		9986		
Front Wheel Kit		PQ625	PQ447	PQ289 [1.3] PQ290 [Imp. 1.4, 1.5] PQ109 [Loc. 1.4, 1.5]	PQ631 [5 Studs] [Flange Ø: 136mm]
Front Wheel Hub / Stub Axle			447AHUB	109HUB	
Alternator / Generator Bearing	- Front		62012RS	62032RS	
	- Rear		62012RS	62002RS	
Concentric / Thurst Bearing		Concentric Slave Cylinder	RB9840 [1.6] RB9853 [2.0]	RB9800 [1.4] RB9840 [1.3, 1.5]	Concentric Slave Cylinder
Diff Carrier Bearing	- Left		32008 [98-00] 32010 [00-02]	30208	NITI386319 [Fr. Diff]
	- Right		32008 [98-00] 32010 [00-02]	30208	NITI386319 [Fr. Diff]
Diff Pinion Bearing	- Front			6209C3	
	- Rear			6209C3	
Propshaft Support Bearing					
Pulley Bearing					
Spigot Shaft Bearing			Bush	Bush	
V-Belt Tensioner					
Drive Shaft Oil Seal	- Left	9307	254008	325211	9306 [1.6] 9211 [2.0]
	- Right	9307	254008	325211	9306 [1.6] 9211 [2.0]
Gearbox Oil Seal	- Front		9871	9757	9871 [1.6] 9317 [2.0]
	- Rear				
Pinion Oil Seal			9872	9656 [Side Flange]	
Spark Plug Tube Seal					
Rear Main Bearing Oil Seal		9308	9825	8010010 [1.3] 608212 [1.4, 1.5]	9311 [1.6, 2.0] 9326 [1.5DCi] 9342 [2.0DCi]
Timing Cover / Cam Oil Seal		254207 [Cam] 425406 [T/Cover]	405207 [T/Cover 1.6] 9210 [T/Cover 2.0]	9754 [T/Cover 1.3, 1.5] 385509 [T/Cover 1.4] 9755 [Cam All]	284205 [Cam 1.5DCi] 9569 [T/Cover 1.5DCi] 405207 [T/Cover 1.6] 9343 [T/Cover 2.0 DCi] 9868 [T/Cover 2.0 Pet.]
Rear Wheel Bearing	- Inner	DACRWBNP	HUB083 [Gear Type ABS] HUB087 [Non ABS]	331274	HUB151 [with integrated ABS sensor]
	- Outer			11910+49	
Rear Wheel Oil Seal	- Inner	Sealed Bearing	HUB UNIT		HUB UNIT
	- Outer			9420	
Rear Wheel Kit		PQ803	PQ640 PQ639 [1.6]	PQ152	PQ820 [5 Studs]
Rear Wheel Hub / Stub Axle					

APPLICATIONS	LOCATION	NISSAN QASHQAI 4X4	NISSAN QASHQAI 4X2, 4X4	NISSAN SABRE	NISSAN SANI
		2.0 DCi Accent, Tekna SUV M1D, M9R	1.2 DIG-T HRA2DDT 1.5 dCi Accent, Tekna K9K 1.6 dCi Accent Dies. R9M 1.6 DIG-T Accent Pet. MR16DDT 2.0 I Pet. MR20DD	160 GX, GXi GA16DS 200 GXi SR20DE	AW/D21 4X4 2.4, i Z24 2.5 TD25 2.7D, TD TD27 3.0 VG30E
YEARS		07-13	2013-	94-02	89-99
Front Wheel Bearing	- Inner	<b>HUB150</b> [with integrated ABS sensor]	<b>HUB392</b> [with integrated ABS sensor]	<b>38003</b>	<b>48510+48</b>
	- Outer				<b>12610+49</b>
Front Wheel Oil Seal	- Inner	HUB UNIT	HUB UNIT	<b>9867</b>	<b>546513</b>
	- Outer			<b>9940</b>	
Front Wheel Kit		<b>PQ631</b> [5 Studs] [Flange Ø: 136mm]	<b>PQ1116</b> [5 Studs] [Flange Ø: 136mm] [without plate]	<b>PQ414</b>	<b>PQ178</b>
Front Wheel Hub / Stub Axle				<b>414HUB</b>	<b>178AHUB</b>
Alternator / Generator Bearing	- Front			<b>62012RS</b>	<b>62012RS</b> [Bosch] <b>62022RS</b> [Hitachi]
	- Rear			<b>63032RS</b>	<b>62012RS</b> [Hitachi] <b>63032RS</b> [Bosch] <b>B10-50D</b> [2.7, 3.0] or see Pg. I
Concentric / Thrust Bearing		<b>Concentric Slave Cylinder</b>	<b>Concentric Slave Cylinder</b>	<b>RB9840</b> [94-97 1.6] <b>RB9853</b> [98-02 1.6 & 2.0 all years]	<b>RB9585</b> [2.4, 3.0] <b>RB9603</b> [2.7] <b>RB9805</b> [2.5]
Diff Carrier Bearing	- Left	<b>NIQA500</b> [Front Diff] <b>NIMURCB</b> [Rear Diff]	<b>NITI386319</b> [Fr. Diff]	<b>30208</b> [1.6] <b>32010</b> [2.0]	<b>32012X</b> [Diff Lock] <b>501310+49</b> [No Diff Lock]
	- Right		<b>NITI386319</b> [Fr. Diff]	<b>30208</b> [1.6] <b>32010</b> [2.0]	
Diff Pinion Bearing	- Front	<b>NIQAN500</b> [Rear Diff]			<b>86610+49</b>
	- Rear	<b>NIMURRPB</b> [Rear Diff]			<b>88610+49</b>
Drive Shaft Oil Seal	- Left	<b>9211</b>	<b>9204</b> [1.6] <b>9306</b> <b>9211</b> [2.0]	<b>405607</b> [1.6] <b>9871</b> [2.0]	<b>9692</b>
	- Right		<b>9204</b> [1.6] <b>9306</b> <b>9211</b> [2.0]	<b>405607</b> [1.6] <b>9871</b> [2.0]	
Gearbox Oil Seal	- Front	<b>9317</b>	<b>9871</b> [1.6] <b>9317</b> [2.0]	<b>9757</b>	<b>304508</b>
	- Rear				<b>354712</b> [2.7, 3.0] <b>355012</b> <b>405810</b>
Pinion Oil Seal		<b>9318</b> [Rear Diff]			<b>9680</b> [Diff Lock] <b>9718</b> [No Diff Lock]
Rear Main Bearing Oil Seal		<b>9342</b>	<b>9311</b> [1.2, 1.6 DIG-T, 2.0] <b>9326</b> [1.5]	<b>9729</b> [1.6] <b>9825</b> [2.0]	<b>8010012</b> [2.4] <b>9202FS</b> [2.7] <b>9729</b> [3.0] <b>9814</b> [2.5]
Timing Cover / Cam Oil Seal		<b>9343</b> [T/Cover]	<b>284205</b> [Cam 1.5DCi] <b>405207</b> [T/Cover 1.2] <b>9343</b> [T/Cover 1.6] <b>9569</b> [T/Cover 1.5] <b>9868</b> [T/Cover] [1.6 DIG-T, 2.0]	<b>405207</b> [T/Cover 1.6] <b>9868</b> [T/Cover 2.0]	<b>487009</b> [T/Cover 2.4] <b>9728</b> [T/Cover 2.5, 3.0] <b>9818</b> [T/Cover 2.7] <b>9666</b> [Cam]
Rear Wheel Bearing	- Inner	<b>HUB152</b> [with integrated ABS sensor]	<b>HUB151</b> [with integrated ABS sensor] <b>HUB393</b> [with integrated ABS sensor]	<b>HUB080</b> [1.6] [Non ABS] <b>HUB081</b> [2.0] [Gear Type ABS]	<b>U399+360 + 1852119</b>
	- Outer				
Rear Wheel Oil Seal	- Inner	HUB UNIT	HUB UNIT	HUB UNIT	
	- Outer				<b>9415</b>
Rear Wheel Kit		<b>PQ821</b> [5 Studs]	<b>PQ820</b> [5 Studs] [1.6dci 4X4] <b>PQ1117</b> [5 Studs]	<b>PQ415</b> [1.6] [Non ABS] <b>PQ416</b> [2.0] [Gear Type ABS]	<b>PQ176</b>
Rear Wheel Hub / Stub Axle					

APPLICATIONS	LOCATION	NISSAN SANI AW/D21 4X4 2.2 Z22 2.4 Z24 2.7 TD27 3.0 VG30E	NISSAN SENTRA 1.3 GL, SX E13S 1.6 GL, GX, GXE GXEi Coupe, SGLi E16E/S	NISSAN SENTRA 1.8i Coupe, Sedan Exec. CA18DE	NISSAN SENTRA 140, i, GX, GXi, Si GA14DNE / DS 160 GSi, GX, GXi, SE, Si GA16DE/DNE/ DS
		YEARS	86-98	87-92	89-92
Front Wheel Bearing	- Inner	603011+49	DAC80WD8	DAC80WD8	38003
	- Outer	300811+49			
Front Wheel Oil Seal	- Inner		Sealed Bearing	Sealed Bearing	9867
	- Outer	9821 9821A Alt.			9940
Front Wheel Kit		PQ352	PQ335	PQ335	PQ414
Front Wheel Hub / Stub Axle		352HUB	335HUB	335HUB	414HUB
Alternator / Generator Bearing	- Front	62012RS [Bosch] 62022RS [Hitachi]	63032RS	63032RS	62032RS
	- Rear	62012RS [Hitachi] 63032RS [Bosch]	62012RS	B10-50D	62012RS
Concentric / Thurst Bearing		RB9585 [All, not 2.7] RB9603 [2.7]	RB9894 [1.3] RB9853 [1.6]	RB9818	RB9840
Diff Carrier Bearing	- Left	30208 [Front Diff] 501310+49 [Rear Diff]	30208 [1.3] 32013 [1.6]	32008/57407	30208 [Man.] 32010X [Auto.] 6208 [Auto.]
	- Right	30208 [Front Diff] 501310+49 [Rear Diff]	30208 [1.3] 32013 [1.6]	32008/57407	30208 [Man.] 32010X [Auto.] 6208 [Auto.]
Diff Pinion Bearing	- Front	32305 [Front Diff] 32306 [Front + Rear Diff 2.4] 86610+49 [Rear Diff]			
	- Rear	32307 [Front Diff] TR0708-I-N [Front Diff 2.4] 86610+49 [Rear Diff] TR0708-1IRN [Rear Diff 2.4]			
Spigot Shaft Bearing		Bush			
Drive Shaft Oil Seal	- Left	9863 [Side Shaft LHS Fr. axle]	9756	9816	9756 [1.4] 9866 [1.6]
	- Right	9863 [Side Shaft RHS Fr. axle]	9756	9816	9756 [1.4] 9866 [1.6]
Gearbox Oil Seal	- Front	304508 9823 [Transfer Case]	9757 [Man] 9812 [Auto.]	9857	9757
	- Rear	355010 [All, not 2.4] 9680 [2.4]	405607		
Pinion Oil Seal		9605 [Front Diff] 9680 [Rear Diff]			
Spark Plug Tube Seal			9574	9574 [GA18DE]	9574 [GA16DE]
Rear Main Bearing Oil Seal		8010012 [2.2, 2.4] 9814 [2.7] 9729 [3.0]	8010010	9825	9825 [1.4] 9729 [1.6]
Timing Cover / Cam Oil Seal		9666 [Cam 3.0] 487009 [T/Cover 2.2, 2.4] 9818 [T/Cover 2.7] 9728 [T/Cover 3.0]	9754 [T/Cover] 9755 [Cam] 9824 [Intermediate Shaft]	405207 [Cam + T/Cover]	405207 [T/Cover]
Rear Wheel Bearing	- Inner	30208 [2.2, 2.4] U399+360 + 1852119 [Rest]	DAC01WD10 DAC01WD7 [1.6 GXE, GXEi]	DAC01WD7	HUB080 [Non ABS]
	- Outer				
Rear Wheel Oil Seal	- Inner	355511 [2.2, 2.4]	Sealed Bearing	Sealed Bearing	HUB UNIT
	- Outer	9813 [2.2, 2.4] 9415 [Rest]	9758	9758	
Rear Wheel Kit		PQ351 [2.2, 2.4] PQ176 [Rest]	PQ340 PQ339 [1.6 GXE, GXEi]	PQ339	PQ415
Rear Wheel Hub / Stub Axle					



APPLICATIONS	LOCATION	NISSAN SENTRA	NISSAN SENTRA	NISSAN SKYLINE	NISSAN SKYLINE
		200 GSi, STi SR20DE	1.6 HR16DE	R30 1.8 L18 2.0 GL L20 R31 2.0 GL, GLE CA20	R30 2.8 GLX, GTX L28/2
YEARS		92-02	2013-	82-87 [R30] 87-92 [R31]	83-86
Front Wheel Bearing	- Inner	38003	HUB150 [with integrated ABS sensor]	67010+48	67010+48
	- Outer			11910+49	11910+49
Front Wheel Oil Seal	- Inner	9867	HUB UNIT	9491 [82-87] 9694 [87-92]	9491
	- Outer	9940			
Front Wheel Kit		PQ414	PQ631 [5 Studs] [Flange Ø: 136mm]	PQ138 [82-87] PQ288 [87-92]	PQ138
Front Wheel Hub / Stub Axle		414HUB			
Alternator / Generator Bearing	- Front	63032RS		62032RS [82-87] 63032RS [87-92]	62032RS
	- Rear	B10-50D		62002RS [82-87] 62012RS [87-92]	62002RS
Concentric / Thrust Bearing		RB9853	Concentric Slave Cylinder	RB9801	RB9801
Diff Carrier Bearing	- Left	32010X		30207 [Import 1.8] 30208 [Import 2.0] 501310+49 [Local All]	30208
	- Right	32010X		30207 [Import 1.8] 30208 [Import 2.0] 501310+49 [Local All]	30208
Diff Pinion Bearing	- Front			32305 [Import 1.8] 30305 [Import 2.0] 86610+49 [Local All]	32305
	- Rear			32306 [Import 1.8] 32307 [Import 2.0] 88610+49 [Local All]	32307
Propshaft Support Bearing					
Pulley Bearing					
V-Belt Tensioner					
Drive Shaft Oil Seal	- Left	9871	9306		9692 [Diff Seal]
	- Right	9872	9306		9692 [Diff Seal]
Gearbox Oil Seal	- Front	9757		304508 [Man.] 9817 [Auto.]	304508 [Man.] 9817 [Auto.]
	- Rear	9871		355010	355010
Pinion Oil Seal				356413 [Import 1.8] 457512 [Import 2.0] 9680 [Local All]	9693
Spark Plug Tube Seal					
Rear Main Bearing Oil Seal		9825	9311	8010012 [82-87] 9729 [87-92]	8010012
Timing Cover / Cam Oil Seal		9868 [T/Cover]	9966 [Cam]	487009 [T/Cover 82-87] 9728 [T/Cover 87-92] 9666 [Cam]	487009 [T/Cover]
Rear Wheel Bearing	- Inner	HUB080 [Non ABS] HUB081 [Gear Type ABS]	HUB395	B32-10 + RR43 [Import] 1700289 + RR35 [Local]	62062RS
	- Outer				63062RS
Rear Wheel Oil Seal	- Inner	HUB UNIT	HUB UNIT	415607 [Import] 2641 [Local]	
	- Outer				9695
Rear Wheel Kit		PQ415 PQ416 [ABS]	PQ1122	PQ186 [Import] PQ145 [Local]	PQ287
Rear Wheel Hub / Stub Axle					



APPLICATIONS	LOCATION	NISSAN SKYLINE	NISSAN STANZA	NISSAN	NISSAN TIIDA
		R31 2.0 SGLi, SGLi RB20E 3.0 SGLi RB30E With I.R.S.	1.6 DL, Resort, S/W L16 1.8 GL, Resort, S/W SSS L18	TERRANO II 4X4 2.7 TD27	1.6 Acenta, Visia, + HR16DE 1.8 Acenta MR18DE
YEARS		87-92	80-84	00-02	06-13
Front Wheel Bearing	- Inner	67010+48	67010+48	603011+49	HUB146 [with integrated ABS sensor]
	- Outer	11910+49	11910+49	300811+49	
Front Wheel Oil Seal	- Inner	9694	486206D		HUB UNIT
	- Outer			9821 9821A Alt.	
Front Wheel Kit		PQ288	PQ134	PQ352	PQ621 [Rim: 3 Hole] [4 Studs] [Flange Ø: 136mm]
Front Wheel Hub / Stub Axle				352HUB	
Alternator / Generator Bearing	- Front	63032RS	62012RS	63032RS	
	- Rear	62012RS	62002RS	B10-50D	
Concentric / Thurst Bearing		RB9585	RB9561	RB9603	Concentric Slave Cylinder
Diff Carrier Bearing	- Left	30208 [Import IRS] 102910+49 [Local IRS]	30206 [Import] 29710+49 [Local]	30209 [Front Diff] 17831+887 [Rear Diff]	NITI386319
	- Right	30208 [Import IRS] 102910+49 [Local IRS]	30206 [Import] 29710+49 [Local]		NITI386319
Diff Pinion Bearing	- Front	32305 [Import IRS] 86610+49 [Local IRS]	30305 [Import] 86610+49 [Local]	32305 [Front Diff] 32306 [Rear Diff]	
	- Rear	32307 [Import IRS] 88610+49 [Local IRS]	32206 [Import] 88610+49 [Local]	32307 [Front Diff] 32306 [Rear Diff]	
Propshaft Support Bearing					
Pulley Bearing					
Spigot Shaft Bearing				Bush	
V-Belt Tensioner					
Drive Shaft Oil Seal	- Left	9692 [Diff Seal]		9863 [Side Shaft LHS Fr. axle]	9306 [1.6] 9310 [1.8]
	- Right	9692 [Diff Seal]		9863 [Side Shaft RHS Fr. axle]	9306 [1.6] 9310 [1.8]
Gearbox Oil Seal	- Front	304508 [Man.] 9817 [Auto.]	345007	304508	254207
	- Rear	355010	355010		9306 [T/case]
Pinion Oil Seal		9693 [Import IRS] 9718 [Local IRS]	325812 [Import] 2738 [Local]	9212 [Front Diff] 9201 [Rear Diff]	
Spark Plug Tube Seal					
Rear Main Bearing Oil Seal		9729 [2.0] 8010012 [3.0]	8010012	9202FS	9311
Timing Cover / Cam Oil Seal		405207 [Cam + T/Cover]	487009 [T/Cover]	9818 [T/Cover] 9126 [T/Cover 3.0] [ID: 52mm]	405207 [T/Cover 1.6] 9868 [T/Cover 1.8]
Rear Wheel Bearing	- Inner	62062RS	83294 C4 + RR43 [Import] 412971 + RR30 [Local]	U399+360 + 1852119	HUB147 [with integrated ABS sensor] HUB414 [with integrated ABS sensor]
	- Outer	63062RS [87-90] 35BW05 [90-92]			
Rear Wheel Oil Seal	- Inner		415607 [Import] Sealed [Local]		HUB UNIT
	- Outer	9695		9415	
Rear Wheel Kit		PQ287 [Import IRS]	PQ186 [Import] PQ154 [Local]	PQ176	PQ801 [Flange Ø: 148mm] PQ1150 [Flange Ø: 134mm]
Rear Wheel Hub / Stub Axle					

APPLICATIONS	LOCATION	NISSAN X-TRAIL 4X2, 4X4 T30 2.0 QR20DE MPV 2.0 MPV 20DE 2.2D SE, SEL MPV 2.5 25DE MPV	NISSAN X-TRAIL 4X2, 4X4 T31 2.0 XE SUV MR20DE Pet. 2.0dCi XE SUV M1D/ M9R 830/832 2.5 CVT LE, LE, SE SUV QR25DE	NISSAN X-TRAIL 4X2 T32 1.6 Dci R9M 2.0 CVT 6 speed MR20DD	NISSAN X-TRAIL 4X4 T32 1.6 Dci R9M 2.5 QR25DE
		YEARS	01-09	08-14	2014-
Front Wheel Bearing	- Inner	43BWD12	HUB150 [with integrated ABS sensor]		
	- Outer				
Front Wheel Oil Seal	- Inner	Sealed Bearing	HUB UNIT	HUB UNIT	HUB UNIT
	- Outer				
Front Wheel Kit		PQ756	PQ631 [5 Studs] [Flange Ø: 136mm]	PQ1140	PQ1140
Front Wheel Hub / Stub Axle		756HUB			
Alternator / Generator Bearing	- Front				
	- Rear				
Concentric / Thurst Bearing		RB9691	Concentric Slave Cylinder	Concentric Slave Cylinder	Concentric Slave Cylinder
Diff Carrier Bearing	- Left				
	- Right				
Diff Pinion Bearing	- Front				
	- Rear				
Propshaft Support Bearing					
Pulley Bearing					
Spigot Shaft Bearing					
V-Belt Tensioner					
Drive Shaft Oil Seal	- Left			9204 [1.6 Diff transfer case] 9310 [2.0 Diff clutch housing] 9306 [Diff transfer case]	9179 [Rr. diff side] 9204 [1.6 Diff transfer case] 9872 [2.5 Diff transfer case]
	- Right			9211 [1.6 Fr. diff clutch housing] 9310 [2.0 Diff clutch housing] 9306 [Diff transfer case]	9179 [Rr. diff side] 9211 [1.6 Fr. diff clutch housing] 9872 [2.5 Diff transfer case]
Gearbox Oil Seal	- Front			9317 [16] 254207 [2.0]	9317 [16]
	- Rear				
Pinion Oil Seal		9318 [4X4]			9178
Spark Plug Tube Seal					
Rear Main Bearing Oil Seal		9825	9311 [2.0DCi] 9342 [2.0D] 9825 [4X4]	9177FS [1.6Dci] 9311 [2.0]	9177FS [1.6Dci] 9825 [2.5SE]
Timing Cover / Cam Oil Seal		9868 [T/Cover 2.0, 2.5] 9309 [T/Cover 2.2]	9343 [T/Cover 2.0D] 9868 [T/Cover 2.0DCi]	9343 [T/Cover 1.6Dci] 9868 [T/Cover 2.0]	9343 [1.6Dci Fr. Crank/T/ Cover] 9180 [2.5 T/Cover]
Rear Wheel Bearing	- Inner	DACRWBXT DAC9113X [4X4]	HUB151 [with integrated ABS sensor] HUB152 [with integrated ABS sensor]	HUB151 [with integrated ABS sensor]	HUB152 [with integrated ABS sensor]
	- Outer				
Rear Wheel Oil Seal	- Inner	Sealed Bearing	HUB UNIT	HUB UNIT	HUB UNIT
	- Outer				
Rear Wheel Kit		PQ891 PQ757 [4X4]	PQ820 [5 Studs] PQ821 [5 Studs] [4X4]	PQ820 [5 Studs]	PQ821 [5 Studs]
Rear Wheel Hub / Stub Axle		757HUB [4X4]			

APPLICATIONS	LOCATION	OPEL ADAM 1.0T Jam, Glam, Rocks B10XFT 1.4 B14XER, A14XER Adam S 1.4T B14NEH	OPEL ASCONA 1.3 L 13NV/SC 1.6 GL 16SH 1.8 GLS 18L	OPEL ASTRA F 140i, iS 14NV 160i, iE, iS, Estate 16NZ 180i, iE 18SE/ XE, XL 200i, e, ts 20SE/ XE	OPEL ASTRA G 1.6 CS, Classic CD, CDE, Comfort C16SEL 1.8 Classic CDE, Caravan CD S/W, Elegance, Irmscher X18XE1
YEARS		2014-	82-87	93-99	99-06
Front Wheel Bearing	- Inner	DACFWBNM DACFWBOCD	309726 [1.3] 309639 [1.6, 1.8]	309639 [1.8, 2.0] 636114 [1.4, 1.6] 636096 [Some & 2.0ts]	HUB025 [Non ABS] HUB027 [With integrated ABS Sensor] HUB181 [With integrated ABS Sensor]
	- Outer				
Front Wheel Oil Seal	- Inner	Sealed Bearing	Sealed Bearing	Sealed Bearing	HUB UNIT
	- Outer				
Front Wheel Kit		PQ474 [ID: 37mm] PQ633 [ID: 35mm]	PQ122 [1.3] PQ106 [1.6, 1.8]	PQ106 [1.8, 2.0] PQ417 [1.4, 1.6] PQ439 [Some & 2.0ts]	PQ491 PQ493 [ID: 25.5mm] PQ678 [ID: 26mm]
Front Wheel Hub / Stub Axle		474AHUB [1.4 T] [25 Spline] [5 Studs] 622BHUB [25 Spline] [4 Stud] 633HUB [1.0, 1.4] [22 Spline] [4 Studs]	122HUB 106HUB	106HUB 122HUB [PQ417] 439HUB	
Alternator / Generator Bearing	- Front		62032RS	62032RS	63032RS
	- Rear		62012RS	63032RS	60032RS
Concentric / Thurst Bearing			RB9525 [1.3] RB9852 [1.6, 1.8]	RB9878 [1.4, 1.6] RB9892 [1.8, 2.0]	Concentric Slave Cylinder
Diff Carrier Bearing	- Left		32007	32007 [1.4, 1.6] 69310+49 [1.8, 2.0]	32007
	- Right		32007	32007 [1.4, 1.6] 69310+49 [1.8, 2.0]	32007
Diff Pinion Bearing	- Front				
	- Rear				
Propshaft Support Bearing					
Spigot Shaft Bearing			BNIB493353		Bush
Drive Shaft Oil Seal	- Left	9104 [1.0] 9051 [1.4]	6305C3 [Drive Shaft Support Brg.1.3, 1.8] 362680A [Drive Shaft Support Brg. 1.6] 9479	9646 [1.4, 1.6] 355510 [1.8, 2.0]	9974
	- Right	9104 [1.0] 9051 [1.4]	6305C3 [Drive Shaft Support Brg.1.3, 1.8] 362680A [Drive Shaft Support Brg. 1.6] 9479	9646 [1.4, 1.6] 355510 [1.8, 2.0]	9974
Gearbox Oil Seal	- Front				
	- Rear		9499 [1.6 only]		
Rear Main Bearing Oil Seal		9464 [1.4]	9464 [1.3] 9473 [1.6, 1.8]	9464 [1.4, 1.6] 9914 [1.8, 2.0]	9464 [1.6] 9917 [1.8]
Timing Cover / Cam Oil Seal		9328 [T/Cover]	354807 [Cam] 9967 [T/Cover - Silicone 1.3] 9715 [T/Cover 1.6, 1.8]	354807 [Cam 1.4, 1.6] 9967 [T/Cover Silicone 1.4, 1.6] 9715 [T/Cover 1.8, 2.0]	354807 [Cam x2] 9037 [T/Cover 1.6] 9715 [T/Cover 1.8]
Rear Wheel Bearing	- Inner	HUB155 [Drums] [With integrated ABS Sensor] HUB156 [Discs] [With integrated ABS Sensor]	331274	331274	HUB026 [Non ABS] HUB096 [With integrated ABS Sensor]
	- Outer		11710+49	11710+49	
Rear Wheel Oil Seal	- Inner	HUB UNIT			HUB UNIT
	- Outer		405208SP	405208SP	
Rear Wheel Kit		PQ823 [4 Studs] PQ824 [5 Studs]	PQ108	PQ108	PQ492 [4 Studs] PQ677 [4 Studs]
Rear Wheel Hub / Stub Axle					

APPLICATIONS	LOCATION	OPEL ASTRA G	OPEL ASTRA H	OPEL ASTRA H	OPEL ASTRA J
		2.0 Coupe', CSX X20XEV 2.2i Classic Exec.	1.4 Essentia, Z14XEP 1.6 Classic Club, Elegance, Enjoy, Essentia, Sport Z16XEP 1.8 Enjoy, GTC, GTC Sport, Twintop, Enjoy, Z18XER	1.9 CDTi Enjoy, GTC, CDTi, GTC CDTi Sport 2.0 Coupe' Turbo, GSi, GTC Turbo, GTC Turbo OPC, GTC Turbo Sport, Turbo Sport, Twin top	1.4T A14NET, B14NET 1.6i A16LET
YEARS		99-05	04-10	04-10	2010-
Front Wheel Bearing	- Inner	<b>HUB045</b> [No ABS] <b>HUB027</b> [With integrated ABS Sensor]	<b>HUB123</b> [With integrated ABS Sensor] <b>HUB124</b> [With integrated ABS Sensor]	<b>HUB123</b> [With integrated ABS Sensor] <b>HUB124</b> [With integrated ABS Sensor] <b>HUB318</b> [With integrated ABS Sensor]	<b>HUB201</b> [With integrated ABS sensor] <b>HUB202</b> [Rim: 5 -Hole 115mm PCD] [With integrated ABS sensor]
	- Outer				
Front Wheel Oil Seal	- Inner	HUB UNIT	HUB UNIT	HUB UNIT	HUB UNIT
	- Outer				
Front Wheel Kit		<b>PQ602</b> <b>PQ493</b> [5 Studs]	<b>PQ730</b> [4 Studs] <b>PQ731</b> [5 Studs]	<b>PQ730</b> [ID:28mm] [4 Studs] <b>PQ731</b> [ID:25mm] [5 Studs] <b>PQ997</b> [ID:33mm] [5 Studs]	<b>PQ897</b> [PCD:105mm] <b>PQ898</b> [PCD:115mm]
Front Wheel Hub / Stub Axle					
Alternator / Generator Bearing	- Front	<b>63032RS</b>			
	- Rear	<b>60032RS</b>			
Concentric / Thurst Bearing		Concentric Slave Cylinder	Concentric Slave Cylinder	Concentric Slave Cylinder	Concentric Slave Cylinder
Diff Carrier Bearing	- Left	<b>501310+49</b>			
	- Right	<b>501310+49</b>			
Diff Pinion Bearing	- Front				
	- Rear				
Propshaft Support Bearing					
Pulley Bearing					
Spigot Shaft Bearing		<b>Bush</b>			
V-Belt Tensioner					
Drive Shaft Oil Seal	- Left	<b>9974</b>	<b>9974</b>	<b>9974</b>	
	- Right	<b>9974</b>	<b>9974</b>	<b>9974</b>	
Gearbox Oil Seal	- Front	<b>9717</b>			
	- Rear				
Pinion Oil Seal					
Spark Plug Tube Seal					
Rear Main Bearing Oil Seal		<b>9914</b>	<b>9464</b>	<b>9914</b> [2.0] <b>9958</b> [1.9]	<b>9464</b>
Timing Cover / Cam Oil Seal		<b>354807</b> [Cam] <b>9715</b> [T/Cover]	<b>354807</b> [Cam x2] <b>9037</b> [T/Cover]	<b>354807</b> [Cam 2.0 x2] <b>9053</b> [T/Cover 1.9] <b>9715</b> [T/Cover 2.0] <b>9809</b> [Cam 1.9]	<b>354807</b> [Cam 1.6 x2] <b>9037</b> [T/Cover 1.6] <b>9328</b> [T/Cover 1.4]
Rear Wheel Bearing	- Inner	<b>HUB046</b> [No ABS] <b>HUB028</b> [With integrated ABS Sensor]	<b>HUB125</b> [With integrated ABS Sensor] <b>HUB126</b> [With integrated ABS Sensor]	<b>HUB125</b> [With integrated ABS Sensor] <b>HUB126</b> [With integrated ABS Sensor]	<b>HUB192</b> [OD:136mm] [With integrated ABS sensor] <b>HUB193</b> [OD:146mm] [With integrated ABS sensor]
	- Outer				
Rear Wheel Oil Seal	- Inner	HUB UNIT	HUB UNIT	HUB UNIT	
	- Outer				
Rear Wheel Kit		<b>PQ495</b> [5 Studs] <b>PQ494</b> [5 Studs]	<b>PQ732</b> [4 Studs] <b>PQ733</b> [5 Studs]	<b>PQ732</b> [4 Studs] <b>PQ733</b> [5 Studs]	<b>PQ908</b> [5 Studs PCD:105mm] <b>PQ909</b> [5 Studs PCD:115mm]
Rear Wheel Hub / Stub Axle					

APPLICATIONS	LOCATION	OPEL CORSA B	OPEL CORSA C	OPEL CORSA D	OPEL CORSA E
		130, i, Lite, iE, iS, Chill Hatch / Sedan 13NE 140i, Classic, Active, Lite, Lite+, Comfort, Chill, Sport, S 14NE, Hatch/ Sedan 160, i, iE, Classic, GSi, i Sport, S Hatch/ Sedan, 16SE 1.8i GSi Hatch	140i Classic, Comfort, Chill, Classic Essentia, Hatch Club, Sport, Lite Sport, S14NE 160i Classic, Classic Elegance, Classic CD, CDE, Sport,16SE 1.7TDi Sport, Classic, CDTi Enjoy, Hatch CDTi Elegance, Classic DTi Elegance X17D 1.8i GSi Hatch, Classic	1.3CDTi Enjoy 1.4i Essentia, Enjoy, Cosmo, Sport 1.6i Sport, OPC	1.0 T B10XFT, F10XFT 1.4 T B14XEL 1.4 T B14NEH [2017-]
YEARS		96-03	03-08	08-15	2015-
Front Wheel Bearing	- Inner	636114 309639	DAC346737	DACFWBNM DACFWBOCD	12131ASB DACFWBOCD
	- Outer				
Front Wheel Oil Seal	- Inner	Sealed Bearing	Sealed Bearing	Sealed Bearing	
	- Outer				
Front Wheel Kit		PQ417 [1.3, 1.4, 1.6] PQ106 [1.8]	PQ679	PQ622 [ID: 37mm] PQ633 [ID: 35mm] [1.4]	PQ474 [ID: 37mm] PQ633 [ID: 35mm]
Front Wheel Hub / Stub Axle		106HUB 122HUB [PQ417]	679HUB	474AHUB [1.4, 1.6] [5 Hole] [25 Spline] 622BHUB [1.3] [25 Spline] [4 Hole] 633HUB [1.4] [22 Spline] [4 Studs]	474AHUB [5 Hole] [25 Spline] 622BHUB [4 Hole] [25 Spline] 633HUB [1.4] [22 Spline] [4 Studs]
Alternator / Generator Bearing	- Front	62032RS	62032RS		
	- Rear	63032RS	63032RS		
Concentric / Thurst Bearing		RB9878	Concentric Slave Cylinder	Concentric Slave Cylinder	
Diff Carrier Bearing	- Left	32007	32007		
	- Right	32007	32007		
Diff Pinion Bearing	- Front				
	- Rear				
Propshaft Support Bearing					
Pulley Bearing					
Spigot Shaft Bearing		Retainer	Retainer		
V-Belt Tensioner					
Drive Shaft Oil Seal	- Left	9646	9646	9974	
	- Right	9646	9646	9974	
Gearbox Oil Seal	- Front				
	- Rear				
Pinion Oil Seal					
Rear Main Bearing Oil Seal		9464 [1.3, 1.4, 1.6] 9914 [1.8]	9464 [1.4, 1.6] 9917 [1.7] 9914 [1.8]	9329 [1.3] 9464 [1.4, 1.6]	
Timing Cover / Cam Oil Seal		354807 [Cam] 9967 [T/Cover - Silicone] 9715 [T/Cover 1.8 only]	354807 [Cam All, not 1.7] 9966 [Cam 1.7] 9967 [T/Cover - Silicone] 9715 [T/Cover 1.8 only]	354807 [Cam - All] 405207 [T/Cover - 1.3] 9328 [T/Cover - 1.4] 9037 [T/Cover - 1.6]	
Rear Wheel Bearing	- Inner	331274	OC40650 [Drums] HUB026 [Discs] [Non ABS] HUB096 [Discs] [ABS] HUB154 [Discs Alt.] [Non ABS]	HUB155 [Drums] [With integrated ABS Sensor] HUB156 [Discs] [With integrated ABS Sensor]	HUB155 [Drums] [With integrated ABS Sensor] HUB156 [Discs] [With integrated ABS Sensor]
	- Outer	11710+49			
Rear Wheel Oil Seal	- Inner		Sealed Bearing [Drums] HUB UNIT [Discs]	HUB UNIT	HUB UNIT
	- Outer	405208SP			
Rear Wheel Kit		PQ108	PQ711 [Drums] PQ492 [4 Studs] PQ677 [Discs ABS 1.4, 1.6] [4 Studs] PQ822 [Discs Alt.][4 Studs]	PQ823 [4 Studs] PQ824 [5 Studs]	PQ823 [4 Studs] PQ824 [5 Studs]
Rear Wheel Hub / Stub Axle		108HUB SA108C			SA823 [Drums] SA824 [Discs]

APPLICATIONS	LOCATION	OPEL CORSA LDV	OPEL CORSA LDV II	OPEL CORSA P/VAN	OPEL KADETT D, E
		130i Utility P/up 13NE 1.4i Utility, S P/up 14NE 1.6i Utility Sport P/up 16NZ 1.7D Utility P/up X17D	1.4i Utility, Club Sport, S P/up 14XE 1.7DTi Utility Club, Sport P/up 1.8i Utility Club, Sport P/up	1.3i Pronto 13NE 1.4i Combo P/van	1.2 L 12NS, 1.3 Cub, GL, GLS, LS, Rebel 13NV 140 CL, Cub 14NE/ NV 1.6 GL, GLS, GSE, L, Rebel, Cub 16SH/ SE 160i, GSi Aspen 16SE
YEARS		97-04	03-10	99-00 [Pronto] 2006- [Combo]	80-93
Front Wheel Bearing	- Inner	636114	DAC346737	636114 [Pronto] DAC346737 [Combo]	309726 309639
	- Outer				
Front Wheel Oil Seal	- Inner	Sealed Bearing	Sealed Bearing	Sealed Bearing	Sealed Bearing
	- Outer				
Front Wheel Kit		PQ417	PQ679	PQ417 [Pronto] PQ679 [Combo]	PQ122 PQ106 [Alt. 1.6]
Front Wheel Hub / Stub Axle		122HUB	679HUB	122HUB [PQ417] 679HUB	122HUB 106HUB
Alternator / Generator Bearing	- Front	62032RS	62032RS	62032RS	62032RS
	- Rear	63032RS	63032RS	63032RS	62012RS
Concentric / Thurst Bearing		RB9878	Concentric Slave Cylinder	RB9878 [Pronto] Concentric Slave Cylinder	RB9525 [80-85 1.2, 1.3] RB9878 [85-93 1.3, 1.4] RB9852 [1.6]
Diff Carrier Bearing	- Left	32007	32007	32007	32007
	- Right	32007	32007	32007	32007
Diff Pinion Bearing	- Front				
	- Rear				
Propshaft Support Bearing					
Pulley Bearing					
Spigot Shaft Bearing		Retainer		Retainer [Pronto]	BNIB493353
V-Belt Tensioner					
Drive Shaft Oil Seal	- Left	9646	9646	9646	6305C3 [Drive Shaft Support Brg.] 9495 [80-85 – 1.2, 1.3] 9497 [85-93 – 1.3, 1.4]
	- Right	9646	9646	9646	6305C3 [Drive Shaft Support Brg.] 9495 [80-85 – 1.2, 1.3] 9497 [85-93 – All]
Gearbox Oil Seal	- Front				213207 [85-93 1.3, 1.4] 9717 [1.6]
	- Rear				
Pinion Oil Seal					
Spark Plug Tube Seal					
Rear Main Bearing Oil Seal		9464 [1.3, 1.4, 1.6] 9917 [1.7]	9464 [1.4] 9917 [1.7] 9914 [1.8]	9464	9496 [1.2] 9464 [1.3, 1.4, 1.6] 9473 [Alt. 1.6]
Timing Cover / Cam Oil Seal		354807 [Cam 1.3, 1.4, 1.6] 9967 [T/Cover - Silicone] 9966 [Cam, T/Cover -1.7]	354807 [Cam 1.4] 9967 [T/Cover - Silicone] 9966 [Cam, T/Cover -1.7] 9715 [T/Cover 1.8 only]	354807 [Cam] 9967 [T/Cover – Silicone]	354807 [Cam] 9967 [T/Cover - Silicone] 9715 [T/Cover 1.6 only]
Rear Wheel Bearing	- Inner	331274	OC40650 HUB026 [Some] [Non ABS]	331274 [Pronto] HUB026 [Combo] [Non ABS]	331274
	- Outer	11710+49		11710+49 [Pronto]	11710+49
Rear Wheel Oil Seal	- Inner		Sealed Bearing HUB UNIT [Some]	405208SP [Pronto] HUB UNIT [Combo]	
	- Outer	405208SP			405208SP
Rear Wheel Kit		PQ108	PQ711 PQ492 [Some] [4 Studs]	PQ108 [Pronto] PQ492 [Combo] [4 Studs]	PQ108
Rear Wheel Hub / Stub Axle			SA711		

APPLICATIONS	LOCATION	OPEL KADETT D, E	OPEL KADETT E	OPEL KADETT F	OPEL KADETT F
		1.8 GTE 18E, L 18LV, GSi Hatch 18L, GLX 18SV, GSi 18E/ SE	2.0 GSi 20XE, SGI 20SEH 200, iS 20SE, Boss 20SEH, CD 20SHE, GSi, Super Boss 20SEH	140, S 14NE 160i, iS, GSi, Aspen 16SV/ NZ	180i, iE, GSi 18SE 200is 20XE
YEARS		84-93	87-93	93-99	93-99
Front Wheel Bearing	- Inner	309639	309639	636114	309639 [1.8, 200is] 636096 [200ts]
	- Outer				
Front Wheel Oil Seal	- Inner	Sealed Bearing	Sealed Bearing	Sealed Bearing	Sealed Bearing
	- Outer				
Front Wheel Kit		PQ106	PQ106	PQ417	PQ106 [1.8, 200is] PQ439 [200ts]
Front Wheel Hub / Stub Axle		106HUB	106HUB	122HUB	106HUB 439HUB
Alternator / Generator Bearing	- Front	62032RS [84-89] 63022RS [89-93]	62032RS 6203ZZ [Alt.]	62032RS [1.4] 63022RS [1.6]	62032RS
	- Rear	62032RS [84-89] 63022RS [89-93]	62032RS 6203ZZ [Alt.]	63032RS [1.4] 62022RS [1.6]	63032RS
Concentric / Thurst Bearing		RB9852 [84-89] RB9892 [89-93]	RB9892	RB9878	RB9892
Diff Carrier Bearing	- Left	32007	32007	32007	69310+49
	- Right	32007	32007	32007	69310+49
Diff Pinion Bearing	- Front				
	- Rear				
Propshaft Support Bearing					
Pulley Bearing					
Spigot Shaft Bearing		BNIB493353 [84-85]			
V-Belt Tensioner					
Drive Shaft Oil Seal	- Left	6305C3 [84-85] [Drive Shaft Support Brg.] 9497 [84-85]		9646	355510
	- Right	6305C3 [84-85] [Drive Shaft Support Brg.] 9497 [84-85]		9646	355510
Gearbox Oil Seal	- Front		9717	9717 [1.6]	
	- Rear				
Pinion Oil Seal					
Spark Plug Tube Seal					
Rear Main Bearing Oil Seal		9473 [84-89] 9914 [89-93]	9914	9464	9914
Timing Cover / Cam Oil Seal		354807 [Cam] 9715 [T/Cover]	354807 [Cam Belt End] 557008 [Dist. End] 9715 [T/Cover] 9627 [T/Cover only CD]	354807 [Cam] 9715 [T/Cover] 9967 [T/Cover - Silicone]	354807 [Cam Belt End] 557008 [Dist. End] 9715 [T/Cover 1.8] 9627 [T/Cover 2.0]
Rear Wheel Bearing	- Inner	331274	331274	331274	331274
	- Outer	11710+49	11710+49	11710+49	11710+49
Rear Wheel Oil Seal	- Inner				
	- Outer	405208SP	405208SP	405208SP	405208SP
Rear Wheel Kit		PQ108	PQ108	PQ108	PQ108
Rear Wheel Hub / Stub Axle					



APPLICATIONS	LOCATION	OPEL MERIVA	OPEL MERIVA	OPEL MOKKA	OPEL MONZA
		1.3 CDTi Enjoy 1.4 Essentia, Enjoy 1.6 Club, Comfort, Enjoy MPV Z16SE/-XE 1.7 CDTi Enjoy, Elegance 1.8 Elegance MPV Easytronic	1.4T	1.4T A14NET, B14NET	160 GSi, i Aspen 16SE/ NZ, CLS 16SV
YEARS		03-09	12-15	15-16	86-93
Front Wheel Bearing	- Inner	<b>DACFWBOCD</b> [ASB 1.3 only] <b>DAC346737</b> [Rest]	<b>DAC40FWBAVEO</b>	<b>DAC40FWBAVEO</b>	<b>309726</b>
	- Outer				
Front Wheel Oil Seal	- Inner	Sealed Bearing	Sealed Bearing	Sealed Bearing	Sealed Bearing
	- Outer				
Front Wheel Kit		<b>PQ679</b> [Rest]	<b>PQ714</b>	<b>PQ714</b>	<b>PQ122</b>
Front Wheel Hub / Stub Axle		<b>679HUB</b>		<b>714HUB</b>	<b>122HUB</b>
Alternator / Generator Bearing	- Front				<b>63022RS</b>
	- Rear				<b>62022RS</b>
Concentric / Thurst Bearing		<b>Concentric Slave Cylinder</b>	<b>Concentric Slave Cylinder</b>		<b>RB9852</b> [16SE, SV] <b>RB9878</b> [16NZ]
Diff Carrier Bearing	- Left				<b>32007</b>
	- Right				<b>32007</b>
Diff Pinion Bearing	- Front				
	- Rear				
Propshaft Support Bearing					
Pulley Bearing					
Spigot Shaft Bearing					
V-Belt Tensioner					
Drive Shaft Oil Seal	- Left	<b>9974</b>		<b>9051</b>	
	- Right	<b>9974</b>		<b>9051</b>	
Gearbox Oil Seal	- Front				<b>9716</b> [86-90] <b>213207</b> [90-93]
	- Rear				
Pinion Oil Seal					
Spark Plug Tube Seal					
Rear Main Bearing Oil Seal		<b>9329</b> [1.3] <b>9464</b> [1.4, 1.6] <b>9917</b> [1.7] <b>9914</b> [1.8]	<b>9464</b>	<b>9464</b>	<b>9464</b> [GLS, CLS] <b>9473</b> [GSi, Aspen]
Timing Cover / Cam Oil Seal		<b>354807</b> [Cam - All, not 1.7] <b>9966</b> [Cam 1.7] <b>405207</b> [T/Cover - 1.3] <b>9967</b> [T/Cover - Silicone] <b>9715</b> [T/Cover 1.8 only]	<b>9328</b> [T/Cover]		<b>354807</b> [Cam] <b>9967</b> [T/Cover - Silicone]
Rear Wheel Bearing	- Inner	<b>HUB026</b> [1.4, 1.6] [Non ABS] <b>HUB096</b> [1.4, 1.6] [With integrated ABS Sensor] <b>HUB028</b> [1.7, 1.8] [With integrated ABS Sensor]	<b>HUB126</b> [With integrated ABS Sensor]		<b>331274</b>
	- Outer				<b>11710+49</b>
Rear Wheel Oil Seal	- Inner	HUB UNIT	HUB UNIT		
	- Outer				<b>405208SP</b>
Rear Wheel Kit		<b>PQ492</b> [4 Studs] <b>PQ677</b> [4 Studs] <b>PQ494</b> [5 Studs]	<b>PQ733</b> [5 Studs]	<b>PQ793</b>	<b>PQ108</b>
Rear Wheel Hub / Stub Axle					



APPLICATIONS	LOCATION	OPEL MONZA	OPEL OMEGA	OPEL REKORD	OPEL VIVARO
		1.8 CLX, GLE, GLX, Convertible, GLi 18SE/ SV 2.0 CD, CLi 2.0XE, CLE, GLE 20SE/V	2.2i Y22XE 2.6i Elegance Y26SE	2.0 Berlina, GL, GLS, L, S/W CIH 2.0i CLE, CLS, GL, GLE, Irmscher 2.2E CIH 380i, V6 CD, GSi 38GE	1.9CDTi P/Van 2.0i P/van
YEARS		86-93	01-04	82-95	06-15
Front Wheel Bearing	- Inner	309639	HUB069	67010/48	DACFWBNP [ASB] DAC45VIV2 [ASB]
	- Outer			11910/49	
Front Wheel Oil Seal	- Inner	Sealed Bearing	HUB UNIT	4465 9462	Sealed Bearing
	- Outer				
Front Wheel Kit		PQ106		PQ131 [4465] PQ137 [9462]	PQ625 [OD: 88mm] PQ998 [OD: 86mm]
Front Wheel Hub / Stub Axle		106HUB			
Alternator / Generator Bearing	- Front	62032RS [86-89] 63022RS [89-93] 6203ZZ [only 2.0 CD]		62032RS	
	- Rear	62032RS [86-89] 63022RS [89-93] 6203ZZ [only 2.0 CD]		62012RS	
Concentric / Thurst Bearing		RB9852 [86-90] RB9892 [90-93]		RB9525 [2.0, 2.2 82-88] RB9878 [2.0, 2.2 88-95] RB9861 [3.8]	Concentric Slave Cylinder
Diff Carrier Bearing	- Left	32007		501310+49	
	- Right	32007		501310+49	
Diff Pinion Bearing	- Front			86610/49	
	- Rear			88610/49	
Propshaft Support Bearing					
Pulley Bearing					
Spigot Shaft Bearing				491627	
V-Belt Tensioner					
Drive Shaft Oil Seal	- Left				9307
	- Right				9307
Gearbox Oil Seal	- Front	9717		9443 [Man.] 9477 [Auto.]	
	- Rear			335010 [Man.] 9478 [Auto.]	
Pinion Oil Seal				2738	
Spark Plug Tube Seal					
Rear Main Bearing Oil Seal		9914		9475	9649
Timing Cover / Cam Oil Seal		354807 [Cam Belt End] 557008 [Dist. End] 9715 [T/Cover 1.8, 2.0] 9627 [T/Cover 2.0 CD]		456010 [T/Cover 2.0] 456009 [T/Cover 2.2, 3.8]	254207 [Cam 1.9] 425406 [T/Cover 1.9] 9341 [Cam 2.0]
Rear Wheel Bearing	- Inner	331274	636096	1700289 + RR35	DACRWBNP
	- Outer	11710+49			
Rear Wheel Oil Seal	- Inner		Sealed Bearing		Sealed Bearing
	- Outer	405208SP		2641	
Rear Wheel Kit		PQ108	PQ439	PQ145	PQ803
Rear Wheel Hub / Stub Axle					

APPLICATIONS	LOCATION	OPEL ZAFIRA I	OPEL ZAFIRA II	OPEL ZAFIRA III	
		1.8i CD, Enjoy, Elegance MPV Z18XE/-1	1.6 Essentia MPV 1.8i Enjoy, Elegance MPV Z18XE/-1 1.9CDTi Elegance 2.0i Turbo OPC 2.2i Enjoy, Elegance MPV Z22SE	1.4 1.6 1.6D 2.0	
YEARS		01-05	05-09	2011-	
Front Wheel Bearing	- Inner	<b>HUB025</b> [Non ABS] <b>HUB027</b> [With integrated ABS Sensor] <b>HUB181</b> [With integrated ABS Sensor]	<b>HUB123</b> [With integrated ABS Sensor] <b>HUB124</b> [With integrated ABS Sensor]		
	- Outer				
Front Wheel Oil Seal	- Inner	HUB UNIT	HUB UNIT		
	- Outer				
Front Wheel Kit		<b>PQ491</b> [Non ABS] [4 Studs] <b>PQ493</b> [5 Studs] <b>PQ678</b> [4 Studs]	<b>PQ730</b> [4 Studs] <b>PQ731</b> [5 Studs]		
Front Wheel Hub / Stub Axle					
Alternator / Generator Bearing	- Front	<b>63032RS</b>			
	- Rear	<b>60032RS</b>			
Concentric / Thurst Bearing		<b>Concentric Slave Cylinder</b>	<b>Concentric Slave Cylinder</b>	<b>Concentric Slave Cylinder</b>	
Diff Carrier Bearing	- Left	<b>32007</b>			
	- Right	<b>32007</b>			
Diff Pinion Bearing	- Front				
	- Rear				
Propshaft Support Bearing					
Pulley Bearing					
Spigot Shaft Bearing					
V-Belt Tensioner					
Drive Shaft Oil Seal	- Left	<b>9974</b>	<b>9974</b>		
	- Right	<b>9974</b>	<b>9974</b>		
Gearbox Oil Seal	- Front				
	- Rear				
Pinion Oil Seal					
Spark Plug Tube Seal					
Rear Main Bearing Oil Seal		<b>9917</b>	<b>9464</b> [1.6] <b>9917</b> [1.8] <b>9914</b> [1.9, 2.0, 2.2]		
Timing Cover / Cam Oil Seal		<b>354807</b> [Cam] <b>9715</b> [T/Cover]	<b>354807</b> [Cam]		
Rear Wheel Bearing	- Inner	<b>HUB026</b> [Non ABS] <b>HUB096</b> [With integrated ABS Sensor]	<b>HUB125</b> [With integrated ABS Sensor] <b>HUB126</b> [With integrated ABS Sensor]		
	- Outer				
Rear Wheel Oil Seal	- Inner	HUB UNIT	HUB UNIT		
	- Outer				
Rear Wheel Kit		<b>PQ492</b> [4 Studs] <b>PQ677</b> [4 Studs]	<b>PQ732</b> [4 Studs] <b>PQ733</b> [5 Studs]		
Rear Wheel Hub / Stub Axle					

APPLICATIONS	LOCATION	PEUGEOT 107	PEUGEOT 1007	PEUGEOT 206	PEUGEOT 206
		1.0 XR, XR+, X-Line	1.6 MPV TU5JP4	1.4 X-Line, XS-Line, XS-Line HDi, Popart, Popart+ TU3JP 1.6 XS-Line, CC, SW XS, XT, XT Premium TU5JP4	2.0 CC, GTi, 180 EW10J4, XT HDi DW10TD
YEARS		06-16	05-08	01-08	01-08
Front Wheel Bearing	- Inner	DACPQB107	XGBCitC3	40547	40574 [Non ABS]
	- Outer				
Front Wheel Oil Seal	- Inner	Sealed Bearing	Sealed Bearing	Sealed Bearing	Sealed Bearing
	- Outer				
Front Wheel Kit		PQ634	PQ776	PQ604	PQ483 [ID: 42mm]
Front Wheel Hub / Stub Axle		634HUB		604HUB	483HUB
Alternator / Generator Bearing	- Front				
	- Rear				
Concentric / Thurst Bearing		RB9692	RB9610	RB9610 [1.6] RB9674 [1.4]	RB9610
Diff Carrier Bearing	- Left				
	- Right				
Diff Pinion Bearing	- Front				
	- Rear				
Propshaft Support Bearing					
Pulley Bearing					
Spigot Shaft Bearing					
V-Belt Tensioner					
Drive Shaft Oil Seal	- Left	9699	405810	405810	405810
	- Right	9646	304710	304710	304710
Gearbox Oil Seal	- Front		9331 405810	9981	9981
	- Rear				
Pinion Oil Seal					
Spark Plug Tube Seal					
Rear Main Bearing Oil Seal		9305	9649 [Polyacrylate] 9330 [Teflon]	9649	9979
Timing Cover / Cam Oil Seal		385006 [T/Cover]	385007 [Cam] 426606 [T/Cover]	9754 [Cam] 426606 [T/Cover]	9754 [Cam] 405508 [T/Cover]
Rear Wheel Bearing	- Inner	HUB145 [with integrated ABS sensor]	FC12025 [Drums] HUB122 [Discs] [with integrated ABS sensor]	FC12025 [01-03] HUB122 [03-06] [with integrated ABS sensor]	FC12025 [01-03 Diesel] HUB058 [01-03 Petrol] [Gear type ABS] HUB122 [03-06 All] [with integrated ABS sensor]
	- Outer				
Rear Wheel Oil Seal	- Inner	HUB UNIT	Sealed Bearing [Drums] HUB UNIT [Discs]	Sealed Bearing [01-03] HUB UNIT [03-06]	Sealed Bearing [01-03 Diesel] HUB UNIT [01-06]
	- Outer				
Rear Wheel Kit		PQ802 [4 Studs]	PQ825 [Drums] PQ722 [Discs] [4 Studs]	PQ484 [01-03] PQ722 [03-06] [4 Studs]	PQ484 [01-03 Diesel] PQ503 [01-03 Petrol] [4 Studs] PQ722 [03-06 All] [4 Studs]
Rear Wheel Hub / Stub Axle					

APPLICATIONS	LOCATION	PEUGEOT 206	PEUGEOT 207	PEUGEOT 208	PEUGEOT 306
		2.0 HDi	1.4i XL, XR, XR+, Urban, Active 1.4 HDi 1.6i XS, GTi, CC Sport 1 & 2, HDi XS, Dynamic, VTi Dynamic 1.6 HDi	1.0 VTi 1.2 VTi 1.6 VTi, HDi 1.6 GTi	1.6 XT S/W TU5JP 2.0 Cabrio, XSi XU10J4R/ RS/, XU10J2/K
YEARS		04-06	06-13	2012-	95-03
Front Wheel Bearing	- Inner	40574	40574X [ID: 42mm] XGBCITC3 [ID: 37mm]	40574X [ID: 42mm] XGBCITC3 [ID: 37mm]	40574 [Non ABS] 40582P [Non ABS]
	- Outer				
Front Wheel Oil Seal	- Inner	Sealed Bearing	Sealed Bearing	Sealed Bearing	Sealed Bearing
	- Outer				
Front Wheel Kit		PQ483 [ID: 42mm]	PQ593 [Std. Susp.] PQ776 [HD Susp.]	PQ593 PQ776 [Some]	PQ483 [ID: 42mm] PQ535 [ID: 35mm]
Front Wheel Hub / Stub Axle		483HUB	483HUB [ID: 42mm] 604HUB [ID: 37mm]	483HUB [ID: 42mm] 604HUB [ID: 37mm]	483HUB
Alternator / Generator Bearing	- Front				
	- Rear				
Concentric / Thurst Bearing		RB9610	Concentric Slave Cylinder RB9610	RB9610 [1.2] Concentric Slave Cylinder	RB9610 [1.6] RB9611 [2.0]
Diff Carrier Bearing	- Left				
	- Right				
Diff Pinion Bearing	- Front				
	- Rear				
Propshaft Support Bearing					
Pulley Bearing					
Spigot Shaft Bearing					
V-Belt Tensioner					
Drive Shaft Oil Seal	- Left		405810		405810
	- Right		304710		304710
Gearbox Oil Seal	- Front		9331 405810		9981
	- Rear				
Pinion Oil Seal					
Spark Plug Tube Seal					
Rear Main Bearing Oil Seal		9979	8510508 [1.4] 9242 [1.4, 1.6 HDi & 1.6 Pet.]	9280 [1.6 GTi] 9242 [1.6 HDi]	9649 [1.6] 9979 [2.0]
Timing Cover / Cam Oil Seal		9055 [Cam] 426207 [T/Cover]	9281 [T/Cover 1.4 09-, 1.6 07-] 9332 [Cam 1.4 Pet.] 9333 [Cam 1.4 Pet.] 9334 [T/Cover 1.4 & 1.6 HDi] 274707 [Cam 1.4 & 1.6 HDi] 385006 [Cam 1.6] 426606 [T/Cover 1.4 09-, 1.6] 426607 [T/Cover ]	9281 [T/Cover 1.6 GTi] 274707 [Cam 1.6 HDi] 9334 [T/Cover 1.6 HDi]	9754 [Cam] 426606 [T/Cover 1.6] 426207 [T/Cover 2.0]
Rear Wheel Bearing	- Inner	FC12025	DACRWB207 [Drums] HUB060 [Discs] [with integrated ABS sensor]	DACRWB207 [Disc] DACRWB25C3 [Drums]	FC12025 [Drums] HUB059 [Discs] [Gear type ABS]
	- Outer				
Rear Wheel Oil Seal	- Inner		Sealed Bearing [Drums] HUB UNIT [Discs]	Sealed Bearing	Sealed Bearing [Drums] HUB UNIT [Discs]
	- Outer				
Rear Wheel Kit		PQ484	PQ826 [Drums] PQ605 [Discs] [4 Studs]	PQ826 [Discs] [1.6 GTi] PQ766 [Drums]	PQ484 [Drums] PQ536 [Discs] [4 Studs]
Rear Wheel Hub / Stub Axle					

APPLICATIONS	LOCATION	PEUGEOT 307	PEUGEOT 308	PEUGEOT 3008	PEUGEOT 405
		1.6 Estate, X-Line, XR, XT TU5JP4, HDi, X-Line HDi, XS HD EW10J4 2.0 CC, CC 100/ 130/ 180, XS, S/W EW10J4 XS HDi DW10TD	1.6i X-Line, XS, XT, CC, S/W, XS HDi 1.6 VTi [10-13] 1.6 GTi [10-14] 2.0 HDi 308CC 1.6THP [10-14]	1.6 2.0 HDi	1.6 GR XU52C/K 1.8 GR XU7JP/LZ 2.0 SRi XU7J2/CL
YEARS		01-08	2008-	2010-	95-97
Front Wheel Bearing	- Inner	40574X	40574X DAC45PGTi	40574X	40574 [Non ABS]
	- Outer				
Front Wheel Oil Seal	- Inner	Sealed Bearing	Sealed Bearing	Sealed Bearing	Sealed Bearing
	- Outer				
Front Wheel Kit		PQ593	PQ593 PQ1092 [1.6 GTi]	PQ593	PQ483 [ID: 42mm]
Front Wheel Hub / Stub Axle			483HUB	483HUB	483HUB
Alternator / Generator Bearing	- Front				
	- Rear				
Concentric / Thurst Bearing		RB9610	Concentric Slave Cylinder RB9610 [1.6 5 Spd.] RB9693 [2.0 HDi]	Concentric Slave Cylinder RB9610 [1.6 5 Spd.] RB9693 [2.0 HDi]	RB9611
Diff Carrier Bearing	- Left				
	- Right				
Diff Pinion Bearing	- Front				
	- Rear				
Propshaft Support Bearing					
Pulley Bearing					
Spigot Shaft Bearing					
V-Belt Tensioner					
Drive Shaft Oil Seal	- Left	405810			405810
	- Right	304710			304710
Gearbox Oil Seal	- Front	9981			9981
	- Rear				
Pinion Oil Seal					
Spark Plug Tube Seal					
Rear Main Bearing Oil Seal		9649 [1.6] 9979 [2.0]	9979 [2.0 HDi] 9242 [All except 2.0 HDi] 9280 [1.6]	9979 [2.0 HDi] 9242 [1.6]	9667 [1.6] 9979 [1.8, 2.0]
Timing Cover / Cam Oil Seal		385007 [Cam 1.6] 9754 [Cam 2.0 XS] 274707 [Cam 2.0 HdI] 426606 [T/Cover 1.6] 405508 [T/Cover 2.0 HdI] 426207 [T/Cover 2.0 XS]	9055 [Cam 2.0 HDi] 9056 [T/Cover 2.0 HDi] 9281 [T/Cover All except 2.0 HDi]	274707 [Cam 2.0 HDi] 9056 [T/Cover 2.0 HDi] 9334 [T/Cover 1.6]	385007 [Cam 1.6] 9754 [Cam 1.8, 2.0] 426207 [T/Cover]
Rear Wheel Bearing	- Inner	HUB060 [01-04] [with integrated ABS sensor] DACPQB307 [04-06] DACPQB207 [06-08]	DAC303008 HUB376 [1.6 GTi]	DAC303008	
	- Outer				
Rear Wheel Oil Seal	- Inner	HUB UNIT [01-04] Sealed Bearing [04-08]	Sealed Bearing HUB UNIT	Sealed Bearing	HUB UNIT
	- Outer				
Rear Wheel Kit		PQ605 [01-04] [4 Studs] PQ883 [04-06] PQ826 [06-08]	PQ999 PQ1093	PQ999	
Rear Wheel Hub / Stub Axle					

APPLICATIONS	LOCATION	PEUGEOT 406	PEUGEOT 605	PEUGEOT BOXER	PEUGEOT BOXER
		2.0 Coupe, Estate, SLi, ST, ST Comfort, Estate, STi, Si EW10J4R/ XU10J4R/ XU10J2TE 3.0 ST, SV Executive ES9J4S	3.0 V6 SRI ZPJ/LZ	2.5TD 1.8 Ton Delivery Van DJ5TED	2.2Hdi P2ZDTE 3.0Hdi F30DT, F1CE0481D BOXER 350 [01-08] 2.8 8140.43S/ F28DTCR
YEARS		96-05	96-98	98-01	06-17
Front Wheel Bearing	- Inner	40574 [Non ABS]	309797	JXCA25678	DACFWBBOX1 [2.8] [49 x 84 x 48] [1.4Ton] DACFWBBOX2 [2.8] [55 x 90 x 60] [1.8Ton] DAC55BOX [ASB] [2.2, 3.0] [55 x 90 x 54]
	- Outer			JXCA25678	
Front Wheel Oil Seal	- Inner	Sealed Bearing	Sealed Bearing	638012	Sealed Bearing
	- Outer			698510 [69mm Shaft] 709014 [70mm Shaft]	
Front Wheel Kit		PQ483 [ID: 42mm]	PQ542	PQ606 [69mm Shaft] PQ610 [70mm Shaft]	PQ611 [49 x 84 x 48] PQ615 [55 x 90 x 60] PQ1001 [55 x 90 x 54]
Front Wheel Hub / Stub Axle		483HUB			
Alternator / Generator Bearing	- Front				
	- Rear				
Concentric / Thurst Bearing		RB9611			Concentric Slave Cylinder RB9693 [2.2 Hdi]
Diff Carrier Bearing	- Left				
	- Right				
Diff Pinion Bearing	- Front				
	- Rear				
Propshaft Support Bearing					
Pulley Bearing					
Spigot Shaft Bearing					
V-Belt Tensioner					
Drive Shaft Oil Seal	- Left	405810	355511	355511	
	- Right	304710	436010	436010	
Gearbox Oil Seal	- Front	9981			
	- Rear				
Pinion Oil Seal					
Spark Plug Tube Seal					
Rear Main Bearing Oil Seal		9979 [2.0]	9648	9982 [1.9] 9980 [2.5]	9061FS [2.2 Hdi] 9090 [3.0 Hdi]
Timing Cover / Cam Oil Seal		9754 [Cam 2.0] 9763 [Cam 3.0] 426207 [T/Cover 2.0] 405508 [T/Cover 3.0]	9763 [Cam] 426207 [T/Cover]	355007 [Cam] 648806 [T/Cover]	9060 [T/Cover 3.0 Hdi] 9561 [T/Cover 2.2 Hdi]
Rear Wheel Bearing	- Inner			10R33A	HUB157 [1.2 - 1.6Ton] [No HD Susp.] [with integrated ABS sensor] HUB158 [1.6 - 2Ton] [HD Susp.] [with integrated ABS sensor] DRT42BOX28
	- Outer			32206	
Rear Wheel Oil Seal	- Inner	HUB UNIT	HUB UNIT	587515	HUB UNIT
	- Outer				
Rear Wheel Kit				PQ607	PQ828 [1.2 - 1.6Ton] [5 Studs] PQ829 [1.6 - 2Ton] [5 Studs] PQ1094 [2.8]
Rear Wheel Hub / Stub Axle					

APPLICATIONS	LOCATION	PEUGEOT PARTNER 1.6 , HDi 1.9D 2.0 HDI	Proton Arena 1.5 GL, GLX
YEARS		03-10	2006-
Front Wheel Bearing	- Inner	40574 [1.9D, 2.0 HDi] [Non ABS] 40574X	DAC40PRO
	- Outer		
Front Wheel Oil Seal	- Inner	Sealed Bearing	
	- Outer		
Front Wheel Kit		PQ483 [ID: 42mm] PQ593	PQ1066
Front Wheel Hub / Stub Axle		483HUB	
Alternator / Generator Bearing	- Front		
	- Rear		
Concentric / Thurst Bearing		RB9610 RB9611 [1.9D, 2.0 HDi Alt.] Concentric Slave Cylinder	
Diff Carrier Bearing	- Left		
	- Right		
Diff Pinion Bearing	- Front		
	- Rear		
Propshaft Support Bearing			
Pulley Bearing			
Spigot Shaft Bearing			
V-Belt Tensioner			
Drive Shaft Oil Seal	- Left		
	- Right		
Gearbox Oil Seal	- Front		
	- Rear		
Pinion Oil Seal			
Spark Plug Tube Seal			
Rear Main Bearing Oil Seal		8510508 [1.6] 9979 [1.9D, 2.0 HDi] 9242 [1.6 Alt., 1.6 HDi]	
Timing Cover / Cam Oil Seal		274707 [Cam 1.6 HDi] 426607 [T/Cover 1.6] 385006 [Cam 1.6] 365007 [Cam 1.6 Alt.] 9055 [Cam 2.0 HDi] 9056 [T/Cover 1.9D, 2.0 HDi] 9334 [T/Cover 1.6 HDi] 9627 [Cam 1.9D]	
Rear Wheel Bearing	- Inner	DAC303008 HUB054 [1.9D] HUB319 [2.0 HDi]	HUB364
	- Outer		
Rear Wheel Oil Seal	- Inner	HUB UNIT Sealed Bearing	
	- Outer		
Rear Wheel Kit		PQ999 PQ623 [1.9D] PQ1000 [2.0 HDi]	PQ1067
Rear Wheel Hub / Stub Axle			

PROTON

APPLICATIONS	LOCATION	RENAULT CAPTUR	RENAULT CLIO I, II	RENAULT CLIO I, II	RENAULT CLIO I, II
		0.9 TCe H4B400 1.2 TCe H5F408 1.5 DCi K9K	1.2 Authentique, Expression, Generation, Va Va Voom D4F706 1.4 Alaise, Privilège, Expression, RT, Va Va Voom K4J7/EJ634	1.5 DCi Expression., K9K700/-702 1.6 Expression, Dynamique, Privilège, Sport K4M744/-745/-748 [99-04]	2.0 Sport F4R 3.0 V6 Sport F7R
YEARS		2016-	99-09	99-10	01-09
Front Wheel Bearing	- Inner	DACFWBNM [ASB] GB40880	GB12004 [OD: 65mm] [Non ABS -04] 12807S [OD: 72mm] [Non ABS -04] GB40880 [OD: 77mm] [04-09] DACFWBNM [OD: 72mm] [ABS -04]	GB12004 [OD: 65mm] [Non ABS -04] 12807S [OD: 72mm] [Non ABS -04] GB40880 [OD: 77mm] [04-09] DACFWBNM [OD: 72mm] [ABS -04]	GB12004 [OD: 65mm] [Non ABS -04] 12807S [OD: 72mm] [Non ABS -04] GB40880 [OD: 77mm] [04-09] DACFWBNM [OD: 72mm] [ABS -04]
	- Outer				
Front Wheel Oil Seal	- Inner	Sealed Bearing	Sealed Bearing	Sealed Bearing	Sealed Bearing
	- Outer				
Front Wheel Kit		PQ622 [ID: 37mm] [0.9] PQ727 [ID: 42mm] [1.2, 1.5]	PQ309 [Non ABS -04] PQ467 [Non ABS -04 Alt.] PQ727 [04-09] PQ622 [ABS]	PQ309 [Non ABS -04] PQ467 [Non ABS -04 Alt.] PQ727 [04-09] PQ622 [ABS]	PQ309 [Non ABS -04] PQ467 [Non ABS -04 Alt.] PQ727 [04-09] PQ622 [ABS]
Front Wheel Hub / Stub Axle		622HUB [23 Spline] 727HUB [25 Spline]	309HUB 467HUB 727HUB 622HUB [23 Spline]	309HUB 467HUB 727HUB 622HUB [23 Spline]	309HUB 467HUB 727HUB 622HUB [23 Spline]
Alternator / Generator Bearing	- Front				
	- Rear				
Concentric / Thrust Bearing		RB9622 [1.5]	RB9622 [99-06] Concentric Slave Cylinder	RB9622 [99-06] RB9883 [Alt. 99-06] Concentric Slave Cylinder	RB9622 [01-06] Concentric Slave Cylinder
Diff Carrier Bearing	- Left				
	- Right				
Diff Pinion Bearing	- Front				
	- Rear				
Propshaft Support Bearing					
Pulley Bearing					
Spigot Shaft Bearing					
Drive Shaft Oil Seal	- Left	9306	9306	9306	
	- Right	9306	9306	9306	
Gearbox Oil Seal	- Front				
	- Rear		9307	9307	9307
Pinion Oil Seal					
Spark Plug Tube Seal					
Rear Main Bearing Oil Seal		9311 [0.9, 1.2] 9326 [1.5]	708607 [1.2] 9338 [1.2 Alt.] 9648 [1.4]	9648 [1.5] 9982 [1.6]	9982 [2.0] 9648 [3.0]
Timing Cover / Cam Oil Seal		9569 [1.5] 9966 [0.9] 405207 [1.2]	284205 [Cam 1.2] 9337 [Cam 1.2 Alt.] 304207 [Cam 1.4] 324406 [T/Cover 1.2] 354706 [T/Cover 1.4]	284205 [Cam 1.5] 304207 [Cam 1.6] 354706 [T/Cover]	304207 [Cam 2.0] 9763 [Cam 3.0] 425406 [T/Cover 2.0] 426207 [T/Cover 3.0]
Rear Wheel Bearing	- Inner	DAC30DUST	FC12025 [Drums -04] FC12784 [Discs -04] DAC255545 [04-06]	FC12025 [Drums -04] FC12784 [Drums -04] DAC255545 [Disc 06-]	FC12784 [Discs -04] DAC255545 [04-06]
	- Outer				
Rear Wheel Oil Seal	- Inner	Sealed Bearing	Sealed Bearing	Sealed Bearing	Sealed Bearing
	- Outer				
Rear Wheel Kit		PQ1004	PQ310 [Drums] PQ487 [OD: 52mm] PQ712 [OD: 55mm]	PQ310 [Drums] PQ487 [OD: 52mm] PQ712 [OD: 55mm]	PQ487 [OD: 52mm] PQ712 [OD: 55mm]
Rear Wheel Hub / Stub Axle		SA1004			



APPLICATIONS	LOCATION	RENAULT CLIO III 1.4 Expression, Extreme 1.5 DCi Expression., K9K770 1.6 Expression, Dynamique, Extreme K4M 748 2.0	RENAULT CLIO III 2.0 Sport, R27, Ltd. Edition F4R832/830	RENAULT CLIO IV 0.9T H4B 1.2 D4F	RENAULT DUSTER 4X2, 4X4 1.5 DCi K9K 1.6 K4M
YEARS		06-10	07-14	2013-	2013-
Front Wheel Bearing	- Inner	DACFWBNM [1.4, 1.6] [OD: 72mm] GB40880 [1.4, 1.5 1.6] [OD: 77mm]	GB40880 [-10] DAC45MEG2 [10-]	DACFWBNM	DAC42DUST
	- Outer				
Front Wheel Oil Seal	- Inner	Sealed Bearing	Sealed Bearing	Sealed Bearing	Sealed Bearing
	- Outer				
Front Wheel Kit		PQ622 [1.4, 1.6] PQ727 [1.4, 1.5, 1.6]	PQ727 [-10] PQ1008 [10-] [4 Mount holes]	PQ622	PQ1002
Front Wheel Hub / Stub Axle		622HUB [23 Spline] 622AHUB [21 Spline] 622BHUB [25 Spline] 727HUB	727HUB [25 Spline] [-10] 1008HUB	622HUB [23 Spline]	1002HUB
Alternator / Generator Bearing	- Front				
	- Rear				
Concentric / Thurst Bearing		Concentric Slave Cylinder	Concentric Slave Cylinder	Concentric Slave Cylinder	Concentric Slave Cylinder
Diff Carrier Bearing	- Left				
	- Right				
Diff Pinion Bearing	- Front				
	- Rear				
Propshaft Support Bearing					
Pulley Bearing					
Spigot Shaft Bearing					
V-Belt Tensioner					
Drive Shaft Oil Seal	- Left	9483	9310 [2.0 Alt. 10-] 9554 [2.0 10-]		
	- Right	9483	9310 [2.0 Alt. 10-] 9554 [2.0 10-]		
Gearbox Oil Seal	- Front				
	- Rear	9307	287010 [-10]		
Pinion Oil Seal					
Spark Plug Tube Seal					
Rear Main Bearing Oil Seal		9648 [1.4, 1.6] 9326 [1.5]	8510508 [10-] 9982 [-10]		9648
Timing Cover / Cam Oil Seal		9091 [Cam] 304207 [Cam 1.6 Alt.] 9569 [T/Cover]	304207 [Cam -10] 9378 [Cam 10-] 425406 [T/Cover]		284205 [Cam] 9569 [T/Cover]
Rear Wheel Bearing	- Inner	FC12025 DAC255545 [Discs]	DAC255545 [-10] FC12784 [10-]	DAC255543 [HD Susp.] FC12784 [Std. Susp.]	DAC42DUST2 DAC30DUST
	- Outer				
Rear Wheel Oil Seal	- Inner	Sealed Bearing	Sealed Bearing	Sealed Bearing	Sealed Bearing
	- Outer				
Rear Wheel Kit		PQ310 [OD: 52mm] PQ712 [OD: 55mm]	PQ712 [-10] [OD: 55mm] PQ487 [10-] [OD: 52mm]	PQ720 [HD Susp.] [OD: 55mm] PQ487 [Std. Susp.] [OD: 52mm]	PQ1003 [4X4] PQ1004 [4X2]
Rear Wheel Hub / Stub Axle					1002HUB [4X4] SA1004 [4X2]

APPLICATIONS	LOCATION	RENAULT ESPACE	RENAULT FLUENCE	RENAULT KADJAR 4X2, 4X4	RENAULT KANGOO
		2.0 Authentique Expression, RXE, RXT MPV J7R, F4R 3.0 L7X727 3.0 Previl	1.6 K4M 2.0 M4R	1.2 TCe H5F408 1.5 dCi K9K 1.6 dCi R9M	1.4 Express van E7J780 1.5dCi Express van K9K700
YEARS		96-08	11-16	2015-	01-10
Front Wheel Bearing	- Inner	<b>HUB056</b> [Non ABS]	<b>DAC42DUST</b>	<b>HUB392</b> [with integrated ABS sensor]	<b>12807S</b>
	- Outer				
Front Wheel Oil Seal	- Inner	HUB UNIT	Sealed Bearing	HUB UNIT	Sealed Bearing
	- Outer				
Front Wheel Kit		<b>PQ548</b> [6 Studs]	<b>PQ1002</b>	<b>PQ1116</b> [5 Studs] [Flange Ø: 136mm]	<b>PQ467</b> [ID: 37mm] [Non ABS]
Front Wheel Hub / Stub Axle		<b>727HUB</b> [25 Spline] [2.0 J7R, F4R, 3.0 L7X727]	<b>1002HUB</b>		<b>467HUB</b>
Alternator / Generator Bearing	- Front				
	- Rear				
Concentric / Thurst Bearing		<b>RB9622</b>	<b>Concentric Slave Cylinder</b>	<b>Concentric Slave Cylinder</b>	<b>Concentric Slave Cylinder</b>
Diff Carrier Bearing	- Left				
	- Right				
Diff Pinion Bearing	- Front				
	- Rear				
Propshaft Support Bearing					
Pulley Bearing					
Spigot Shaft Bearing					
V-Belt Tensioner					
Drive Shaft Oil Seal	- Left				
	- Right				
Gearbox Oil Seal	- Front	<b>304007</b> [2.0 J7R, F4R, 3.0 L7X727]			<b>9307</b>
	- Rear	<b>287010</b>			
Pinion Oil Seal					
Spark Plug Tube Seal					
Rear Main Bearing Oil Seal		<b>9648</b> [3.0 Previl] <b>9982</b> [J7R] <b>9011011</b> [F4R]	<b>9311</b> [2.0] <b>9648</b> [1.6]	<b>9177FS</b> [1.6] <b>9326</b> [1.5]	<b>9326</b> [1.5] <b>9648</b> [1.4]
Timing Cover / Cam Oil Seal		<b>9763</b> [Cam] [3.0 Previl] <b>354807</b> [Cam] [2.0 J7R, F4R, 3.0 L7X727] <b>425406</b> [T/Cover] [2.0 J7R, F4R, 3.0 L7X727] <b>426207</b> [T/Cover] [3.0 Previl]	<b>9091</b> [Cam 1.6] <b>9569</b> [T/Cover 1.6] <b>9868</b> [T/Cover 2.0]	<b>9343</b> [1.6] <b>9569</b> [1.5] <b>9966</b> [1.2]	<b>304207</b> [Cam 1.4] <b>284205</b> [Cam 1.5] <b>354706</b> [T/Cover]
Rear Wheel Bearing	- Inner	<b>HUB041</b> [Drums] [Non ABS] <b>HUB050</b> [Discs] [Gear type ABS]		<b>HUB393</b> [with integrated ABS sensor]	<b>12271S</b> <b>DAC255543</b>
	- Outer				
Rear Wheel Oil Seal	- Inner	HUB UNIT		HUB UNIT	Sealed Bearing
	- Outer				
Rear Wheel Kit		<b>PQ468</b> [Drums] [4 Studs] <b>PQ550</b> [Discs] [4 Studs]		<b>PQ1117</b> [5 Studs]	<b>PQ614</b> [01-03] <b>PQ720</b> [2003-]
Rear Wheel Hub / Stub Axle					

APPLICATIONS	LOCATION	RENAULT KANGOO 1.4 Multix Authentique MPV E7J780 1.5DCi	RENAULT KANGOO 1.6	RENAULT KOLEOS 2.5 Dynamique SUV	RENAULT KOLEOS 4X4 2.0dCi Dynamique Premium SUV 2.5 Dynamique, Premium CVT SUV
YEARS		03-10	11-13	2009-	2009-
Front Wheel Bearing	- Inner	<b>12807S</b> [Non ABS] <b>DACFWBNM</b> [ASB]	<b>DACFWBNM</b>	<b>HUB150</b> [with integrated ABS sensor] [Flange Ø: 136]	<b>HUB150</b> [with integrated ABS sensor] [Flange Ø: 136]
	- Outer				
Front Wheel Oil Seal	- Inner	Sealed Bearing	Sealed Bearing	HUB UNIT	HUB UNIT
	- Outer				
Front Wheel Kit		<b>PQ467</b> [ID: 37mm] [Non ABS] <b>PQ622</b> [ASB]	<b>PQ622</b> [ASB]	<b>PQ631</b> [5 Studs] [Flange Ø: 136mm]	<b>PQ631</b> [5 Studs] [Flange Ø: 136mm]
Front Wheel Hub / Stub Axle		<b>467HUB</b> <b>622HUB</b> [23 Spline]	<b>622HUB</b> [23 Spline]		
Alternator / Generator Bearing	- Front				
	- Rear				
Concentric / Thurst Bearing		<b>Concentric Slave Cylinder</b> <b>RB9622</b> [1.5DCi Alt.]	<b>Concentric Slave Cylinder</b>	<b>Concentric Slave Cylinder</b>	<b>Concentric Slave Cylinder</b>
Diff Carrier Bearing	- Left				
	- Right				
Diff Pinion Bearing	- Front				
	- Rear				
Propshaft Support Bearing					
Pulley Bearing					
Spigot Shaft Bearing					
V-Belt Tensioner					
Drive Shaft Oil Seal	- Left				
	- Right				
Gearbox Oil Seal	- Front	<b>9307</b>			
	- Rear				
Pinion Oil Seal					
Spark Plug Tube Seal					
Rear Main Bearing Oil Seal		<b>9648</b>	<b>9648</b>	<b>9825</b>	<b>9342</b> [2.0] <b>9825</b> [2.5]
Timing Cover / Cam Oil Seal		<b>284205</b> [Cam 1.5DCi] <b>304207</b> [Cam 1.4] <b>9569</b> [T/Cover]	<b>304207</b> [Cam] <b>9569</b> [T/Cover]	<b>9868</b> [T/Cover]	<b>9343</b> [T/cover 2.0] <b>9868</b> [T/cover 2.5]
Rear Wheel Bearing	- Inner	<b>DAC255543</b> [Non ABS] <b>HUB320</b> [Gear type ABS] <b>HUB321</b> [Gear type ABS]	<b>DAC30DUST</b>	<b>HUB151</b>	<b>HUB152</b>
	- Outer				
Rear Wheel Oil Seal	- Inner	Sealed Bearing	Sealed Bearing	HUB UNIT	HUB UNIT
	- Outer				
Rear Wheel Kit		<b>PQ720</b> [Non ABS] <b>PQ1005</b> [26 Teeth] <b>PQ1006</b> [44 Teeth]	<b>PQ1004</b>	<b>PQ820</b> [5 Studs]	<b>PQ821</b> [5 Studs]
Rear Wheel Hub / Stub Axle					

APPLICATIONS	LOCATION	RENAULT KWID 1.0 B4D 404	RENAULT LAGUNA I	RENAULT LAGUNA I	RENAULT LAGUNA II
			1.6 RT, RTE K4M720 1.8 RN, RN Estate, Authentique, Expression F4P7 RT B568/-9F3P/-P6 1.9dCi F9Q716 2.0 RT, RT Estate, RXE, Expression K4M720/724, N7Q700	3.0 Privilege, RXT L7X731 L7X700	1.8 Authentique, Expression 1.9dCi, Dynamic 2.0T Dynamic, Expression 3.0 Privilege, Initial
YEARS		2015-	96-07	96-02	01-09
Front Wheel Bearing	- Inner	<b>DACKWID1</b> <b>DACKWID3</b> [with integrated ABS sensor]	<b>12807S</b> [Std. Axle] <b>GB40250</b> [Heavy Duty Axle] <b>DAC408440</b>	<b>12807S</b> [Std. Axle] <b>GB40250</b> [Heavy Duty Axle]	<b>HUB159</b> [with integrated ABS sensor] <b>DAC45MEG</b>
	- Outer				
Front Wheel Oil Seal	- Inner	Sealed Bearing	Sealed Bearing	Sealed Bearing	HUB UNIT Sealed Bearing
	- Outer				
Front Wheel Kit		<b>PQ1118</b> [OD: 61.85mm] <b>PQ1147</b> [OD: 63.85mm] [ASB]	<b>PQ467</b> [ID: 37mm] [Std. Axle] [Non ABS] <b>PQ466</b> [ID: 40mm] [Heavy Duty Axle] [Non ABS] <b>PQ1085</b> [ID: 40mm] [ABS]	<b>PQ467</b> [ID: 37mm] [Std. Axle] [Non ABS] <b>PQ466</b> [ID: 40mm] [Heavy Duty Axle] [Non ABS]	<b>PQ635</b> [5 Studs] <b>PQ1097</b> [ABS]
Front Wheel Hub / Stub Axle		<b>1118HUB</b>	<b>467HUB</b>	<b>467HUB</b>	
Alternator / Generator Bearing	- Front				
	- Rear				
Concentric / Thrust Bearing		<b>RB9622</b>	<b>RB9622</b> <b>RB9883</b> [Alt.]	<b>RB9623</b>	Concentric Slave Cylinder
Diff Carrier Bearing	- Left				
	- Right				
Diff Pinion Bearing	- Front				
	- Rear				
Propshaft Support Bearing					
Pulley Bearing					
Spigot Shaft Bearing					
Drive Shaft Oil Seal	- Left	<b>9161</b>	<b>9306</b>		
	- Right	<b>9161</b>	<b>9306</b>		
Gearbox Oil Seal	- Front		<b>304007</b> [1.9, 2.0]	<b>254207</b>	
	- Rear		<b>9307</b> [1.6, 1.8, 2.0] <b>287010</b> [1.8, 1.9] <b>506509</b> [2.0]	<b>9983</b>	
Rear Main Bearing Oil Seal		<b>9160</b>	<b>9648</b> [1.6] <b>9982</b> <b>8510508</b> [1.8, 1.9, 2.0]	<b>9648</b>	<b>9308</b>
Timing Cover / Cam Oil Seal		<b>9159</b> [T/cover / Front Crank]	<b>284205</b> [Cam 1.6] <b>254207</b> [Cam Front 1.8, 1.9, 2.0] <b>224507</b> [Cam Rear 1.8, 1.9, 2.0] <b>354706</b> [T/Cover 1.6] <b>425406</b> [T/Cover 1.8, 1.9, 2.0]	<b>426207</b> [T/Cover] <b>9763</b> [Cam]	<b>9341</b> [Cam] <b>425406</b> [T/Cover]
Rear Wheel Bearing	- Inner	<b>DACKWID2</b> <b>DACKWID4</b>	<b>12271S</b> [Drums, Non ABS] <b>HUB051</b> [Discs, Gear type ABS] <b>HUB377</b> [Flange Ø: 132.6mm] <b>HUB378</b> [Flange Ø: 132.8mm] <b>HUB379</b> [Flange Ø: 132.9mm]	<b>HUB051</b> [Discs] [Gear type ABS]	<b>DACRWB207</b>
	- Outer				
Rear Wheel Oil Seal	- Inner	Sealed Bearing	Sealed Bearing HUB UNIT	HUB UNIT	
	- Outer				
Rear Wheel Kit		<b>PQ1119</b> [ID: 22mm] <b>PQ1148</b> [ID: 25mm]	<b>PQ614</b> [Drums, Non ABS] <b>PQ616</b> [Discs] [4 Studs] <b>PQ1095</b> [1.6] <b>PQ1096</b> [1.8] [4 Holes] <b>PQ1099</b> [2.0] [5 Holes]	<b>PQ616</b> [4 Studs]	<b>PQ1098</b> [ABS]
Rear Wheel Hub / Stub Axle		<b>SA1119</b>			

APPLICATIONS	LOCATION	RENAULT LOGAN 1.6 Expression	RENAULT MEGANE I 1.6 Classic RXE, RT, RXT, RSi Coupe, RN Hatch, RT Coupe, Hatch, RXE, RXI Cabriolet K7M700/ 02/-03	RENAULT MEGANE I 2.0 Coupe 8/16V F3R710/50, RXE, RSi Coupe, Cabriolet F3R796/ -7/-8	RENAULT MEGANE II 1.4 Authentique, Dynamique E7J626/-50
YEARS		2009-	96-02	96-02	02-10
Front Wheel Bearing	- Inner	DACFWBNM DACFWBRLP	12807S [Std. Axle] GB40250 [Heavy Duty Axle]	12807S [Std. Axle] GB40250 [Heavy Duty Axle]	12807S [Std. Axle -06] GB40250 [OD: 84mm] [Heavy Duty Axle -06] DACFWBNM [OD: 72mm] [ASB 06-]
	- Outer				
Front Wheel Oil Seal	- Inner	Sealed Bearing	Sealed Bearing	Sealed Bearing	Sealed Bearing
	- Outer				
Front Wheel Kit		PQ622 PQ637 [Non ABS]	PQ467 [Std. Axle] [ID: 37mm] [Non ABS] PQ466 [ID: 40mm] [Heavy Duty Axle]	PQ467 [Std. Axle] [ID: 37mm] [Non ABS] PQ466 [ID: 40mm] [Heavy Duty Axle]	PQ467 [Std. Axle -06] [ID: 37mm] [Non ABS] PQ466 [ID: 40mm] [Heavy Duty Axle -06] [Non ABS] PQ622 [06-]
Front Wheel Hub / Stub Axle		622HUB [23 Spline] 622AHUB [21 Spline]	467HUB	467HUB	467HUB 622AHUB [21 Spline]
Alternator / Generator Bearing	- Front				
	- Rear				
Concentric / Thurst Bearing		Concentric Slave Cylinder	RB9622	RB9622	RB9622 [02-06] Concentric Slave Cylinder
Diff Carrier Bearing	- Left				
	- Right				
Diff Pinion Bearing	- Front				
	- Rear				
Propshaft Support Bearing					
Pulley Bearing					
Spigot Shaft Bearing					
V-Belt Tensioner					
Drive Shaft Oil Seal	- Left		9306		9306
	- Right		9306		9306
Gearbox Oil Seal	- Front			304007	
	- Rear	9307	9307	287010	9307
Pinion Oil Seal					
Spark Plug Tube Seal					
Rear Main Bearing Oil Seal		9648	9648	9982 8510508	9648
Timing Cover / Cam Oil Seal		284205 [Cam] 9569 [T/Cover]	304207 [Cam] 354706 [T/Cover]	254207 [Cam Front] 224507 [Cam Rear] 425406 [T/Cover]	284205 [Cam] 354706 [T/Cover]
Rear Wheel Bearing	- Inner	FC12784 [OD:52] DAC255543 [OD:55]	FC12784 [OD: 52mm] [Non ABS] HUB049 [Gear type ABS] FC40725 [OD: 62mm]	HUB041 [Non ABS] HUB049 [Gear type ABS]	FC12784 DAC255545
	- Outer				
Rear Wheel Oil Seal	- Inner	Sealed Bearing	Sealed Bearing HUB UNIT	HUB UNIT	Sealed Bearing
	- Outer				
Rear Wheel Kit		PQ487 [OD:52] PQ720 [OD:55]	PQ487 [OD: 52mm] [Non ABS] PQ469 [4 Studs] PQ853 [OD: 62mm]	PQ468 [Non ABS][4 Studs] PQ469 [4 Studs]	PQ487 [Non ABS] PQ712 [Non ABS]
Rear Wheel Hub / Stub Axle					

APPLICATIONS	LOCATION	RENAULT MEGANE II	RENAULT MEGANE II	RENAULT MEGANE III	RENAULT MODUS
		1.5dCi Authentique, Shake it! K9K722 1.6 Classic Privilege, Expression, Dynamique, Authentique, Shake it! CC Dynamique K4M701, K4M760/ -1	1.9dCi CC, Dynamique, Privilege, Dynamic + F9Q800 2.0 Classic Dynamique, Dynamique + , Privilege, CC Privilege, GT F7R710 /-77 2.0T Sport, F1 Team R26 LE, SE, Coupe Dynamique	1.2 GT-LINE Turbo 1.4Tce 1.6, DCi 2.0 RB7, RS 250, RS 265	1.2 Authentique D4F706 1.4 Dynamique, Expressio K4J770 1.6 Expression K4M761-11
YEARS		02-10	02-10	2010-	05-08
Front Wheel Bearing	- Inner	<b>GB40880</b> [OD: 77mm] [ASB Type Brg.] <b>DACFWBNM</b> [OD: 72mm][ASB 06-]	<b>GB40880</b> [OD: 77mm] [ASB Type Brg. 1.9, 2.0T] <b>DACFWBNM</b> [OD: 72mm] [ASB Type Brg. 2.0] <b>DACFWBNP</b> [2.0 Alt.]	<b>DAC42DUST</b> [1.4, 1.6] <b>DAC45MEG</b> [ASB] [45 x 83 x 39] <b>DAC45MEG2</b> [ASB] [45 x 107 x 40]	<b>DACFWBNM</b> [ASB]
	- Outer				
Front Wheel Oil Seal	- Inner	Sealed Bearing	Sealed Bearing	Sealed Bearing	Sealed Bearing
	- Outer				
Front Wheel Kit		<b>PQ727</b> <b>PQ622</b> [06-]	<b>PQ727</b> [1.9, 2.0T] <b>PQ622</b> [2.0] <b>PQ625</b> [2.0T Alt.]	<b>PQ1002</b> [1.4, 1.6] <b>PQ1007</b> [2.0] <b>PQ1008</b> [2.0 Alt.]	<b>PQ622</b> [ASB]
Front Wheel Hub / Stub Axle		<b>727HUB</b> [25 Spline] <b>622AHUB</b> [21 Spline]	<b>727HUB</b> [25 Spline] <b>622AHUB</b> [21 Spline]	<b>1007HUB</b> <b>1008HUB</b>	<b>622HUB</b> [23 Spline]
Alternator / Generator Bearing	- Front				
	- Rear				
Concentric / Thurst Bearing		<b>RB9622</b> [02-06] <b>Concentric Slave Cylinder</b>	<b>RB9622</b> [02-06] <b>Concentric Slave Cylinder</b>	<b>Concentric Slave Cylinder</b>	<b>Concentric Slave Cylinder</b>
Diff Carrier Bearing	- Left				
	- Right				
Diff Pinion Bearing	- Front				
	- Rear				
Propshaft Support Bearing					
Pulley Bearing					
Spigot Shaft Bearing					
V-Belt Tensioner					
Drive Shaft Oil Seal	- Left	<b>9306</b>			<b>9306</b>
	- Right	<b>9306</b>			<b>9306</b>
Gearbox Oil Seal	- Front		<b>304007</b>		
	- Rear	<b>9307</b>	<b>287010</b> <b>506509</b>		<b>9307</b>
Pinion Oil Seal					
Spark Plug Tube Seal					
Rear Main Bearing Oil Seal		<b>9326</b> [1.5] <b>9648</b> [1.6]	<b>9982</b> <b>8510508</b>	<b>9308</b> [2.0] <b>9311</b> [1.4] <b>9648</b> [1.6] <b>9825</b> [1.6 Alt.]	<b>9338</b> [1.2] <b>9648</b> [1.4, 1.6]
Timing Cover / Cam Oil Seal		<b>254207</b> [Cam Fr.] <b>224507</b> [Cam Rr.] <b>304207</b> [Cam 1.6 Some] <b>425406</b> [T/Cover]	<b>254207</b> [Cam Fr. 1.9] <b>224507</b> [Cam Rr. 1.9] <b>9341</b> [Cam 2.0] <b>425406</b> [T/Cover]	<b>405207</b> [T/Cover 1.4] <b>425406</b> [T/Cover 2.0] <b>9569</b> [T/Cover 1.6] <b>9091</b> [Cam 1.6] <b>9341</b> [Cam 2.0]	<b>284205</b> [Cam 1.2, 1.4] <b>304207</b> [Cam 1.6] <b>324406</b> [T/Cover 1.2] <b>354706</b> [T/Cover 1.4, 1.6]
Rear Wheel Bearing	- Inner	<b>DAC255545</b> <b>DAC255548</b> [Alt.]	<b>DAC255545</b> <b>DAC255548</b> [Alt.]	<b>DAC255548</b>	<b>FC12025</b> [Drums] <b>DAC255545</b> [Discs]
	- Outer				
Rear Wheel Oil Seal	- Inner	Sealed Bearing	Sealed Bearing	Sealed Bearing	Sealed Bearing
	- Outer				
Rear Wheel Kit		<b>PQ712</b> <b>PQ713</b> [Alt.]	<b>PQ712</b> [2.0T] <b>PQ713</b> [Alt.]	<b>PQ713</b>	<b>PQ486</b> [Drums] <b>PQ712</b> [Discs]
Rear Wheel Hub / Stub Axle					

APPLICATIONS	LOCATION	RENAULT R5 1.3 Panel Van 810-25 [80-85] 1.3 GTL, LS, LSS, TS 810-25 1.4 TS 847-C2J	RENAULT R9 1.4 GTL, TL, TSE C1/2/3J 1.7 TXE F2/3N R11 1.4 TS, TX, TXE C1/2/3J 1.7 TX, TXE F2/3N	RENAULT SANDERO 1.4 Authentique 1.6 Cup, Dynamique, Expression, Pack	RENAULT SCENIC I 1.4 RTE 1.6 RT, RXE 1.9 dCi 2.0 RXE, RXi
YEARS		75-85	83-86	09-15	98-02
Front Wheel Bearing	- Inner	6206 2RS	GB12004	12807S [Non ABS] DACFWBNM [ABS/ASB] DACFWBRLP	12807S [Std. Axle] GB40250 [Heavy Duty Axle]
	- Outer	6206 2RS			
Front Wheel Oil Seal	- Inner		Sealed Bearing	Sealed Bearing	Sealed Bearing
	- Outer				
Front Wheel Kit		PQ125	PQ309	PQ467 [ID: 37mm] [Non ABS] PQ622 [ABS/ASB] PQ637 [Non ABS]	PQ467 [Std. Axle] [ID: 37mm][Non ABS] PQ466 [ID: 40mm] [Heavy Duty Axle] [Non ABS]
Front Wheel Hub / Stub Axle			309HUB	622HUB [23 Spline] 622AHUB [21 Spline]	467HUB [21 Spline] 622HUB [23 Spline 1.6, 1.9, 2.0]
Alternator / Generator Bearing	- Front	62032RS	62032RS		
	- Rear	62012RS	62012RS		
Concentric / Thurst Bearing		RB9036 [75-85]	RB9859 [1.4] RB9880 [1.7]	RB9622	RB9622 Concentric Slave Cylinder
Diff Carrier Bearing	- Left	30207	6008C3		
	- Right	30207 442562 [75-85]	6008C3		
Diff Pinion Bearing	- Front				
	- Rear				
Propshaft Support Bearing					
Pulley Bearing					
Spigot Shaft Bearing					
V-Belt Tensioner					
Drive Shaft Oil Seal	- Left	9652	9483		
	- Right	9652	9483		
Gearbox Oil Seal	- Front	172808			
	- Rear				9307 [1.4, 1.6] 506509 [2.0]
Pinion Oil Seal					
Spark Plug Tube Seal					
Rear Main Bearing Oil Seal		709010 [1.3] 8010012 [1.4]	8010012 [1.4] 8510512 [1.7]	9648	9648 [1.4, 1.6] 9982 [2.0]
Timing Cover / Cam Oil Seal		304208 [Cam]	9481 [T/Cover 1.4] 506809 [T/Cover 1.7]	304207 [Cam] 354706 [T/Cover]	224507 [Cam Rear 2.0] 254207 [Cam Front 2.0] 304207 [Cam 1.4, 1.6] 354706 [T/Cover 1.4, 1.6] 425406 [T/Cover 2.0]
Rear Wheel Bearing	- Inner	30205 [75-76] 32005 [77-85]	FC12025	FC12784 DAC255543	HUB041 [Non ABS] HUB049 [Gear type ABS] FC40725 [OD: 62mm]
	- Outer	30204 [75-76] 32004 [77-85]			
Rear Wheel Oil Seal	- Inner	485804 [75-76] 9653 [77-85]	Sealed Bearing	Sealed Bearing	HUB UNIT
	- Outer				
Rear Wheel Kit			PQ310	PQ487 [OD: 52mm] PQ720 [OD: 55mm]	PQ468 [Non ABS] [4 Studs] PQ469 [ABS][4 Studs] PQ853 [OD: 62mm]
Rear Wheel Hub / Stub Axle					



APPLICATIONS	LOCATION	RENAULT SCENIC II	RENAULT SCENIC II	RENAULT SCENIC II	RENAULT SCENIC III
		1.4 Authentique K4J750	1.6 Authentique, Expression, Joie de Vivre K4M761/782	1.6 Authentique, Expression, Joie de Vivre K4M761/782	1.9dCI Dynamique, Expression, Navigator MPV F9Q812
		GRAND SCENIC	GRAND SCENIC	GRAND SCENIC	GRAND SCENIC
		1.6 [07-08]	1.6 [07-08]	1.6 [07-08]	1.6 [07-08]
		1.9dCI Dynamic, Privilège MPV F9Q740	1.9dCI Dynamic, Privilège MPV F9Q740	1.9dCI Dynamic, Privilège MPV F9Q740	1.9dCI Dynamic, Privilège MPV F9Q740
		2.0 Expression MPV 4FR740/-1	2.0 Expression MPV 4FR740/-1	2.0 Expression MPV 4FR740/-1	2.0 Expression MPV 4FR740/-1
YEARS		01-04	02-10	02-10	11-13
Front Wheel Bearing	- Inner	<b>12807S</b> [Std. Axle] <b>GB40250</b> [Heavy Duty Axle]	<b>GB40880</b> [OD: 77mm] [ASB Type Brg.] <b>DACFWBNM</b> [OD: 72mm] [ASB 06-][Scenic II 1.6]	<b>GB40880</b> [OD: 77mm] [ASB Type Brg. 1.9] <b>DACFWBNM</b> [OD: 72mm] [ASB Type Brg. 2.0]	<b>DAC42DUST</b> [OD:80mm] <b>DAC45MEG</b> [OD:83mm]
	- Outer				
Front Wheel Oil Seal	- Inner	Sealed Bearing	Sealed Bearing	Sealed Bearing	Sealed Bearing
	- Outer				
Front Wheel Kit		<b>PQ467</b> [Std. Axle] [ID: 37mm] [Non ABS] <b>PQ466</b> [ID: 40mm] [Heavy Duty Axle] [Non ABS]	<b>PQ727</b> <b>PQ622</b> [06-][ASB] [Scenic II 1.6]	<b>PQ727</b> [1.9] <b>PQ622</b> [2.0] [ASB]	<b>PQ1002</b> [OD:80mm] <b>PQ1007</b> [OD:83mm]
Front Wheel Hub / Stub Axle		<b>467HUB</b> [21 Spline]	<b>727HUB</b> [25 Spline] <b>622AHUB</b> [21 Spline] [Scenic II 1.6]	<b>727HUB</b> [25 Spline] <b>622AHUB</b> [21 Spline]	<b>1002HUB</b>
Alternator / Generator Bearing	- Front				
	- Rear				
Concentric / Thurst Bearing		<b>RB9622</b>	<b>RB9622</b> [02-06] [Scenic II 1.6] <b>Concentric Slave Cylinder</b>	<b>RB9622</b> [02-06] <b>Concentric Slave Cylinder</b>	<b>Concentric Slave Cylinder</b>
Diff Carrier Bearing	- Left				
	- Right				
Diff Pinion Bearing	- Front				
	- Rear				
Propshaft Support Bearing					
Pulley Bearing					
Spigot Shaft Bearing					
V-Belt Tensioner					
Drive Shaft Oil Seal	- Left				<b>9483</b> [1.6]
	- Right				<b>9483</b> [1.6]
Gearbox Oil Seal	- Front		<b>304007</b> [Scenic II 1.6]	<b>304007</b>	
	- Rear	<b>9307</b>	<b>9307</b>	<b>287010</b>	
Pinion Oil Seal					
Rear Main Bearing Oil Seal		<b>9648</b>	<b>9648</b> [1.6] <b>9982</b> [1.9]	<b>9982</b> <b>8510508</b>	<b>9308</b> [1.9 dCI] <b>9648</b> [1.6]
Timing Cover / Cam Oil Seal		<b>284205</b> [Cam] <b>354706</b> [T/Cover]	<b>284205</b> [Cam] [Scenic II 1.6] <b>354706</b> [T/Cover] [Scenic II 1.6] <b>254207</b> [Cam Fr.] [1.9] <b>224507</b> [Cam Rr.] [1.9] <b>425406</b> [T/Cover] [1.9]	<b>254207</b> [Cam Fr. 1.9] <b>224507</b> [Cam Rr. 1.9] <b>9341</b> [Cam 2.0] <b>425406</b> [T/Cover]	<b>254207</b> [Cam 1.9 dCI] <b>9091</b> [Cam 1.6] <b>425406</b> [T/Cover 1.9 dCI] <b>9569</b> [T/Cover 1.6]
Rear Wheel Bearing	- Inner	<b>HUB041</b> [Non ABS] <b>HUB049</b> [Gear type ABS]	<b>DAC255545</b> <b>DAC255548</b> [Alt.] <b>DACRWB207</b> [Scenic II 1.6]	<b>DAC255545</b> <b>DAC255548</b> [Alt.]	<b>DACRWB207</b>
	- Outer				
Rear Wheel Oil Seal	- Inner	HUB UNIT	Sealed Bearing	Sealed Bearing	Sealed Bearing
	- Outer				
Rear Wheel Kit		<b>PQ468</b> [Non ABS] [4 Studs] <b>PQ469</b> [ABS][4 Studs]	<b>PQ712</b> <b>PQ713</b> [Alt.] <b>PQ826</b> [Scenic II 1.6]	<b>PQ712</b> <b>PQ713</b> [Alt.]	<b>PQ826</b>
Rear Wheel Hub / Stub Axle					



APPLICATIONS	LOCATION	RENAULT TRAFIC	RENAULT TWINGO		
		1.9dCi 100 P/Van F9Q760	1.2 Dynamique, D4F772 1.6 RS K4M854		
YEARS		05-07	08-13		
Front Wheel Bearing	- Inner	DACFWBNP [ASB]	DACFWBNM [ASB Type Brg. 1.2] GB40880 [ASB Type Brg. 1.6]		
	- Outer				
Front Wheel Oil Seal	- Inner	Sealed Bearing	Sealed Bearing		
	- Outer				
Front Wheel Kit		PQ625	PQ622 [1.2] PQ727 [1.6]		
Front Wheel Hub / Stub Axle			622AHUB [21 Spline] 727HUB [25 Spline]		
Alternator / Generator Bearing	- Front				
	- Rear				
Concentric / Thurst Bearing		Concentric Slave Cylinder	RB9622 [1.2] Concentric Slave Cylinder		
Diff Carrier Bearing	- Left				
	- Right				
Diff Pinion Bearing	- Front				
	- Rear				
Propshaft Support Bearing					
Pulley Bearing					
Spigot Shaft Bearing					
V-Belt Tensioner					
Drive Shaft Oil Seal	- Left	9307			
	- Right	9307			
Gearbox Oil Seal	- Front				
	- Rear		9307		
Pinion Oil Seal					
Spark Plug Tube Seal					
Rear Main Bearing Oil Seal		9308	708607 [1.2] 9338 [1.2 Alt.] 9648 [1.6]		
Timing Cover / Cam Oil Seal		254207 [Cam] 425406 [T/cover]	9337 [Cam 1.2] 9344 [Cam 1.6] 284205 [Cam 1.6 Alt.] 324406 [T/Cover 1.2] 354706 [T/Cover 1.6]		
Rear Wheel Bearing	- Inner	DACRWBNP	FC12784 DAC255545		
	- Outer				
Rear Wheel Oil Seal	- Inner	Sealed Bearing	Sealed Bearing		
	- Outer				
Rear Wheel Kit		PQ803	PQ487 [OD:52mm] PQ712 [55mm]		
Rear Wheel Hub / Stub Axle					

APPLICATIONS	LOCATION	SEAT ALTEA	SEAT IBIZA	SEAT LEON	
		2.0FSi Tiptronic 2.0TDi Man., DSG Auto.	1.4 Sport, BXW 1.6 Sport, BAH 1.8T Cupra, BBU 1.9TDi 96, 118 Cupra 2.0 AZL, BBX, BPX, BLK, ASZ, BLT	2.0 FSi 2.0T, FSi Cupra 2.0T FSi 2.0TDi	
YEARS		06-09	06-09	06-09	
Front Wheel Bearing	- Inner	<b>HUB108</b> [with integrated ABS sensor]	<b>HUB103</b> [with integrated ABS sensor]	<b>HUB103</b> [with integrated ABS sensor]	
	- Outer				
Front Wheel Oil Seal	- Inner	HUB UNIT	HUB UNIT	HUB UNIT	
	- Outer				
Front Wheel Kit		<b>PQ688</b> [ID: 29] [5 Hole - 36 Spline]	<b>PQ701</b> [72mm]	<b>PQ701</b> [72mm]	
Front Wheel Hub / Stub Axle					
Alternator / Generator Bearing	- Front				
	- Rear				
Concentric / Thrust Bearing		<b>RB9855</b> [FSi] Concentric Slave Cylinder	Concentric Slave Cylinder <b>RB9855</b> [1.8T]	Concentric Slave Cylinder <b>RB9855</b> [FSi, T]	
Diff Carrier Bearing	- Left	<b>300811+49</b> [FSi] <b>503310+49</b> [TDi]	<b>VWDC386518</b> [5 Spd.] <b>503310+49</b> [6 Spd.]	<b>VWDC386518</b> [5 Spd.] <b>503310+49</b> [6 Spd.]	
	- Right	<b>300811+49</b> [FSi] <b>VWDC487618</b> [TDi]	<b>VWDC386518</b> [5 Spd.] <b>503310+49</b> [6 Spd.]	<b>VWDC386518</b> [5 Spd.] <b>503310+49</b> [6 Spd.]	
Diff Pinion Bearing	- Front				
	- Rear				
Propshaft Support Bearing					
Pulley Bearing					
Spigot Shaft Bearing					
V-Belt Tensioner					
Drive Shaft Oil Seal	- Left	<b>607408</b>	<b>506508</b> [5 Spd.] <b>607408</b> [6 Spd.] <b>486208</b> [Auto.]	<b>506508</b> [5 Spd.] <b>607408</b> [6 Spd.] <b>486208</b> [Auto.]	
	- Right	<b>547308</b> <b>607408</b> [Alt.]	<b>607408</b> [5 Spd.] <b>506510</b> [6 Spd.] <b>506508</b> [6 Spd. Alt.] <b>9230</b> [Auto.] <b>9302</b> [Auto. Alt.]	<b>607408</b> [5 Spd.] <b>506510</b> [6 Spd.] <b>506508</b> [6 Spd. Alt.] <b>9230</b> [Auto.] <b>9302</b> [Auto. Alt.]	
Gearbox Oil Seal	- Front	<b>223507</b> [5 Spd.] <b>284207</b> [6 Spd.]	<b>243806</b> [5 Spd.] <b>223507</b> [Alt. 5 Spd.] <b>284207</b> [6 Spd.]		
	- Rear				
Pinion Oil Seal					
Spark Plug Tube Seal					
Rear Main Bearing Oil Seal		<b>9228FS</b> [FSi] <b>9229FS</b> [TDi]	<b>9237FS</b> [1.4] <b>9231FS</b> [1.6] <b>9945FS</b> [1.8T, 1.9, 2.0]	<b>9229FS</b> [TDi] <b>9945FS</b> [FSi, T]	
Timing Cover / Cam Oil Seal		<b>9548</b> [Cam] <b>9549</b> [T/Cover]	<b>9238</b> [Cam 1.4] <b>9248</b> [Cam 1.6] <b>9548</b> [Cam 1.8T, 1.9, 2.0] <b>9236</b> [T/cover 1.4] <b>9549</b> [T/cover All, except 1.4]	<b>9548</b> [Cam] <b>9549</b> [T/Cover]	
Rear Wheel Bearing	- Inner	<b>HUB100</b> [with integrated ABS sensor]	<b>HUB106</b> [with integrated ABS sensor]	<b>HUB106</b> [with integrated ABS sensor]	
	- Outer				
Rear Wheel Oil Seal	- Inner	HUB UNIT	HUB UNIT	HUB UNIT	
	- Outer				
Rear Wheel Kit		<b>PQ691</b> [5 Hole]	<b>PQ702</b> [5 Hole]	<b>PQ702</b> [5 Hole]	
Rear Wheel Hub / Stub Axle			<b>SA702</b>		

APPLICATIONS	LOCATION	SSANGYONG ACTYON 2.0 2.3	SSANGYONG KORANDO 2.3 K230 EL, Open Top S/W 2.9 K290 EL, TDi, Open Top S/W 3.2 K320 EL S/W MUSO 2.3 E230 EL S/W 2.9 602, EL, EX, TDi, Exec., E290 TDi, Exec. 3.2 E320 EL Exec.	SSANGYONG KYRON 2.0 D20DT 2.7 D27DT	
		YEARS	2006 -	95-04	06-12
Front Wheel Bearing	- Inner		32009 32209 [Alt.]		
	- Outer		32008 32208 [Alt.]		
Front Wheel Oil Seal	- Inner				
	- Outer				
Front Wheel Kit					
Front Wheel Hub / Stub Axle					
Alternator / Generator Bearing	- Front				
	- Rear				
Concentric / Thrust Bearing		Concentric Slave Cylinder	RB9656	Concentric Slave Cylinder	
Diff Carrier Bearing	- Left		25577/23 [Rr. Diff] 501310+49 [Fr. Diff]		
	- Right		25577/23 [Rr. Diff] 501310+49 [Fr. Diff]		
Diff Pinion Bearing	- Front		86610+49 [Fr. Diff] 88010+43 [Rr. Diff]		
	- Rear		86610+49 [Fr. Diff] 89410+46 [Rr. Diff]		
Propshaft Support Bearing					
Pulley Bearing					
Spigot Shaft Bearing					
V-Belt Tensioner					
Drive Shaft Oil Seal	- Left				
	- Right				
Gearbox Oil Seal	- Front				
	- Rear				
Pinion Oil Seal					
Spark Plug Tube Seal					
Rear Main Bearing Oil Seal			9964		
Timing Cover / Cam Oil Seal			9963 [T/Cover]		
Rear Wheel Bearing	- Inner		U399+360 + 1852119		
	- Outer				
Rear Wheel Oil Seal	- Inner				
	- Outer		9415		
Rear Wheel Kit			PQ176		
Rear Wheel Hub / Stub Axle					

APPLICATIONS	LOCATION	SUBARU FORESTER AWD	SUBARU IMPREZA AWD	SUBARU LEGACY AWD	SUBARU OUTBACK AWD
		2.0 D, X, XT 2.5 S, X, XS, XT	1.5 R 2.0 GX, R, RS, WRX, WRX STI 2.5 RS, WRX, WRX STI	2.0 i 2.5 GT, i	2.0D 2.5 3.0R 3.6R
YEARS		2002-2013-	2004-	2004-	2004-
Front Wheel Bearing	- Inner	HUB322 HUB406 [with integrated ABS sensor] DRT42FOR	HUB334 [WRX STI] [with integrated ABS sensor] DRT42FOR	HUB322 [with integrated ABS sensor]	HUB322 [with integrated ABS sensor]
	- Outer				
Front Wheel Oil Seal	- Inner	HUB UNIT Sealed Bearing	HUB UNIT Sealed Bearing	HUB UNIT	HUB UNIT
	- Outer				
Front Wheel Kit		PQ1009 PQ1023 PQ1136 [2013-]	PQ1026 [WRX STI] PQ1023	PQ1009	PQ1009
Front Wheel Hub / Stub Axle					
Alternator / Generator Bearing	- Front				
	- Rear				
Concentric / Thrust Bearing					
Diff Carrier Bearing	- Left				
	- Right				
Diff Pinion Bearing	- Front				
	- Rear				
Propshaft Support Bearing					
Pulley Bearing					
Spigot Shaft Bearing					
V-Belt Tensioner					
Drive Shaft Oil Seal	- Left				
	- Right				
Gearbox Oil Seal	- Front				
	- Rear				
Pinion Oil Seal					
Spark Plug Tube Seal					
Rear Main Bearing Oil Seal					
Timing Cover / Cam Oil Seal					
Rear Wheel Bearing	- Inner	HUB323 HUB407 DRT38FOR	DRT38FOR DRT42IMP [WRX STI]	HUB323	HUB323 HUB333 [04-09] [with integrated ABS sensor]
	- Outer				
Rear Wheel Oil Seal	- Inner	HUB UNIT Sealed Bearing	Sealed Bearing	HUB UNIT	HUB UNIT
	- Outer				
Rear Wheel Kit		PQ1010 PQ1024 PQ1137 [2013-]	PQ1024 PQ1027 [WRX STI]	PQ1010	PQ1010 PQ1025 [04-09] [with integrated ABS sensor]
Rear Wheel Hub / Stub Axle					

APPLICATIONS	LOCATION	SUBARU XV AWD 2.0i FB20B			
YEARS		2012-			
Front Wheel Bearing	- Inner	<b>HUB322</b> <b>HUB406</b> [with integrated ABS sensor]			
	- Outer				
Front Wheel Oil Seal	- Inner	<b>HUB UNIT</b>			
	- Outer				
Front Wheel Kit		<b>PQ1009</b> <b>PQ1136</b>			
Front Wheel Hub / Stub Axle					
Alternator / Generator Bearing	- Front				
	- Rear				
Concentric / Thurst Bearing					
Diff Carrier Bearing	- Left				
	- Right				
Diff Pinion Bearing	- Front				
	- Rear				
Propshaft Support Bearing					
Pulley Bearing					
Spigot Shaft Bearing					
V-Belt Tensioner					
Drive Shaft Oil Seal	- Left				
	- Right				
Gearbox Oil Seal	- Front				
	- Rear				
Pinion Oil Seal					
Spark Plug Tube Seal					
Rear Main Bearing Oil Seal					
Timing Cover / Cam Oil Seal					
Rear Wheel Bearing	- Inner	<b>HUB407</b> [with integrated ABS sensor]			
	- Outer				
Rear Wheel Oil Seal	- Inner	<b>HUB UNIT</b>			
	- Outer				
Rear Wheel Kit		<b>PQ1137</b>			
Rear Wheel Hub / Stub Axle					

APPLICATIONS	LOCATION	SUZUKI ALTO 1.0 K10B	SUZUKI CELERIO 1.0 K10B	SUZUKI ERTIGA 1.4 VVT Pet. K14B 1.5 VVT Pet. K15B	SUZUKI GRAND VITARA 4X4 2.0 J20A 2.4 J20A 2.5 V6 H2S1 3.2 V6 N32A
		YEARS	09-15	2015-	2012-
Front Wheel Bearing	- Inner	DAC35ALTO	DAC35ALTO	DACFWBSSX [ASB]	HUB335 [with integrated ABS sensor]
	- Outer			Sealed Bearing	
Front Wheel Oil Seal	- Inner	Sealed Bearing	Sealed Bearing		HUB UNIT
	- Outer				
Front Wheel Kit		PQ1028	PQ1028	PQ659 [ASB] [ID: 45mm]	PQ1030
Front Wheel Hub / Stub Axle		1028HUB			
Alternator / Generator Bearing	- Front				
	- Rear				
Concentric / Thrust Bearing		RB9606	RB9606		Concentric Slave Cylinder
Diff Carrier Bearing	- Left				
	- Right				
Diff Pinion Bearing	- Front				
	- Rear				
Propshaft Support Bearing					
Pulley Bearing					
Spigot Shaft Bearing					
V-Belt Tensioner					
Drive Shaft Oil Seal	- Left				
	- Right				
Gearbox Oil Seal	- Front				
	- Rear				
Pinion Oil Seal					
Spark Plug Tube Seal					
Rear Main Bearing Oil Seal		9098	9098		
Timing Cover / Cam Oil Seal		9349 [T/Cover]	9349 [T/Cover]		
Rear Wheel Bearing	- Inner	DAC25ALTO	DAC25ALTO	HUB420 [with integrated ABS sensor]	HUB335 [with integrated ABS sensor]
	- Outer				
Rear Wheel Oil Seal	- Inner	Sealed Bearing	Sealed Bearing	HUB UNIT	HUB UNIT
	- Outer				
Rear Wheel Kit		PQ1029	PQ1029	PQ1156	PQ1030
Rear Wheel Hub / Stub Axle					

APPLICATIONS	LOCATION	SUZUKI JIMNY 4X4 1.3i SUV M13A 1.5 K15B	SUZUKI SWIFT 1.5i GL, GLS M15A 1.5 RS415 1.6 RS416	SUZUKI SWIFT 1.2 GA, GL K12M 1.2 AZG12 1.4 GL, GLS, SE K14B 1.4 AZG/AZH 1.6, i M16A	SUZUKI SX4 4X2 1.6 GL, GLX, MA16A [2014-] 2.0i Hatch J2OA, J2OB
		YEARS	2014-	08-11	11-18
Front Wheel Bearing	- Inner	DACFWBSJ	DACFWBSS	DACFWBSS DACFWBSSX [ASB]	DACFWBSSX [ASB]
	- Outer				
Front Wheel Oil Seal	- Inner	9347	Sealed Bearing	Sealed Bearing	Sealed Bearing
	- Outer				
Front Wheel Kit		PQ651	PQ653 [ID: 40mm]	PQ653 [ID: 40mm] PQ659 [ASB] [ID: 45mm]	PQ659 [ASB] [ID: 45mm]
Front Wheel Hub / Stub Axle			653HUB	653HUB 659AHUB	659HUB [No Studs]
Alternator / Generator Bearing	- Front		60022RS		60022RS
	- Rear				
Concentric / Thurst Bearing		RB9694	RB9695	Concentric Slave Cylinder	Concentric Slave Cylinder
Diff Carrier Bearing	- Left				
	- Right				
Diff Pinion Bearing	- Front				
	- Rear				
Propshaft Support Bearing					
Pulley Bearing					
Spigot Shaft Bearing			60022RS [1.5 GLS]		60022RS [2.0 J2OA, J2OB, 1.6 M16A]
V-Belt Tensioner					
Drive Shaft Oil Seal	- Left		9162	9162 [1.2 AZG12] 9165 [1.4 AZG/AZH, 1.6 M16A]	9162 [J2OA, J2OB] [5 Speed] 9165 [J2OA, J2OB][6 Speed] 9166 [M16A 2014-] [5 & 6 Speed] 9173 [1.6 M16A][6 Speed]
	- Right		9162	9162 [1.2 AZG12] 9165 [1.4 AZG/AZH] 9166 [1.6 M16A]	9165 [M16A 2014-] [6 Speed] 9166 [J2OA, J2OB] [6 Speed] 9169 [J2OA, J2OB] [5 Speed]
Gearbox Oil Seal	- Front			9163 [1.2 AZG12] 9164 [1.4 AZG/AZH, 1.6 AZG/AZH]	9164 [M16A 2014-, 5 Speed, 2.0 J2OA, J2OB, 5 & 6 Speed] 9172 [1.6 M16A][6 Speed]
	- Rear				
Rear Main Bearing Oil Seal		9345 9346	9346	9346 9098 [1.2]	9168 [2.0 J2OA] 9171 [2.0 J2OB]
Timing Cover / Cam Oil Seal		324708 [Cam] 324708 [T/Cover]	9349 [T/Cover]	9349 [T/Cover]	9167 [2.0 J2OA, T/Cover, Crank Fr.] 9170 [2.0 J2OB, T/Cover, Crank Fr.]
Rear Wheel Bearing	- Inner	RWBSJ13 + RR53 [Non ABS] RWBSJ13ABS + RR54 [ABS]	DACRWBSS	HUB164 HUB375 [with integrated ABS sensor]	HUB164 HUB369 [with integrated ABS sensor]
	- Outer				
Rear Wheel Oil Seal	- Inner	476209 [Non ABS] 9348 [ABS]	Sealed Bearing	HUB UNIT	HUB UNIT
	- Outer				
Rear Wheel Kit		PQ832 [Non ABS] PQ833 [ABS] PQ1139 [ABS]	PQ836	PQ837 [5 Stud] PQ1090 [4 Stud]	PQ837 [1.6] PQ1079 [2.0]
Rear Wheel Hub / Stub Axle					

APPLICATIONS	LOCATION	SUZUKI SX4 4X4	TATA BOLT	TATA INDICA /	TATA SAFARI 4X2,
		1.6 GL, GLX, MA16A 2.0i Hatch J2OA, J2OB	1.2T XMS, XT	VISTA 1.4 LEi, LSi, LX, LXi 1.4TDi DLX, DLS Indigo 1.4 GLS S/W 1.4TDi DLX S/W	4X4 2.2 CRDi GLS, GLX Diesel
YEARS		10-16	2015-	2005-	2007-
Front Wheel Bearing	- Inner	DACFWBSSX [ASB]	DACFWBTB	309639 633295	48510+48 [4X2] 501310+49 [4X4]
	- Outer	Sealed Bearing			
Front Wheel Oil Seal	- Inner			Sealed Bearing	30205 [4X2] 603011+49 [4X4]
	- Outer				
Front Wheel Kit		PQ659 [ASB] [ID: 45mm]	PQ1071	PQ734 PQ779	PQ700 [4X2] PQ709 [4X4]
Front Wheel Hub / Stub Axle		659AHUB	1071HUB		
Alternator / Generator Bearing	- Front				
	- Rear				
Concentric / Thurst Bearing		Concentric Slave Cylinder		RB9674	
Diff Carrier Bearing	- Left				
	- Right				
Diff Pinion Bearing	- Front				
	- Rear				
Propshaft Support Bearing					
Pulley Bearing					
Spigot Shaft Bearing		60022RS [2.0 J2OA, J2OB, 1.6 M16A]			
V-Belt Tensioner					
Drive Shaft Oil Seal	- Left	9162 [J2OA, J2OB] [5 Speed] 9165 [J2OA, J2OB][6 Speed] 9166 [M16A 2014-] [5 & 6 Speed] 9173 [1.6 M16A][6 Speed]			
	- Right	9165 [M16A 2014-] [6 Speed] 9166 [J2OA, J2OB] [6 Speed] 9169 [J2OA, J2OB] [5 Speed]			
Gearbox Oil Seal	- Front	9164 [M16A 2014-, 5 Speed, 2.0 J2OA, J2OB, 5 & 6 Speed] 9172 [1.6 M16A][6 Speed]			
	- Rear				
Pinion Oil Seal					
Spark Plug Tube Seal					
Rear Main Bearing Oil Seal		9168 [2.0 J20A] 9171 [2.0 J20B]		8510509	
Timing Cover / Cam Oil Seal		9167 [2.0 J20A, T/Cover, Crank Fr.] 9170 [2.0 J20B, T/Cover, Crank Fr.]		355007 [Cam]	
Rear Wheel Bearing	- Inner	HUB365	DACRWBTI	30205 DACRWBTI	
	- Outer				
Rear Wheel Oil Seal	- Inner	HUB UNIT			
	- Outer			405508	
Rear Wheel Kit		PQ1073 [2.0]	PQ880	PQ735 PQ880	
Rear Wheel Hub / Stub Axle			SA880	SA880	

TATA



APPLICATIONS	LOCATION	TATA SUPER ACE	TATA TELCOLINE	TATA XENON	
		1.4TD	4X2, 4X4 2.0 Turbo Diesel S/Cab, D/cab P/up	2.0TDi 3.0TDi	
YEARS		2012-	04-10	2008-	
Front Wheel Bearing	- Inner	48510+48	48510+48 [4X2] 501310+49 [4X4]	48510+48	
	- Outer	30205	30205 [4X2] 603011+49 [4X4]	30205	
Front Wheel Oil Seal	- Inner	506808	506808 [4X2] 9988 [4X4]	506808	
	- Outer				
Front Wheel Kit		PQ700	PQ700 [4X2] PQ709 [4X4]	PQ700	
Front Wheel Hub / Stub Axle					
Alternator / Generator Bearing	- Front				
	- Rear				
Concentric / Thurst Bearing			RB9675		
Diff Carrier Bearing	- Left				
	- Right				
Diff Pinion Bearing	- Front				
	- Rear				
Propshaft Support Bearing					
Pulley Bearing					
Spigot Shaft Bearing					
V-Belt Tensioner					
Drive Shaft Oil Seal	- Left				
	- Right				
Gearbox Oil Seal	- Front				
	- Rear				
Pinion Oil Seal					
Spark Plug Tube Seal					
Rear Main Bearing Oil Seal			9352		
Timing Cover / Cam Oil Seal			9536 [T/Cover] 9627 [Cam]		
Rear Wheel Bearing	- Inner		U497/460 + RR21 [Some]		
	- Outer				
Rear Wheel Oil Seal	- Inner				
	- Outer				
Rear Wheel Kit					
Rear Wheel Hub / Stub Axle					

APPLICATIONS	LOCATION	TOYOTA 86	TOYOTA AURIS	TOYOTA AVANZA	TOYOTA AVANZA
		2.0 FA20D	1.3 1.4i RS, RT 1.6i RS, RT 1.8i RS, RX 2.0Di D-4D RS, RX	1.3i P/Van, S, SX MPV K3VE 1.5i SX, TX MPV 3SZVE	1.3 S, SX MPV 3K3VE 1.3 S P/Van 3K3VE 1.5 SX, TX MPV 3SZVE
YEARS		2012-	2007-	06-12	12-16
Front Wheel Bearing	- Inner	<b>HUB322</b> [with integrated ABS sensor]	<b>HUB165</b> [1.3, 1.4, 1.6, 1.8] [with integrated ABS sensor] <b>HUB166</b> [2.0] [with integrated ABS sensor]	<b>DAC30BWDVAZ</b> <b>DAC38BWDVAZASB</b> [1.5i]	<b>DAC38BWDVAZASB</b>
	- Outer				
Front Wheel Oil Seal	- Inner	HUB UNIT	HUB UNIT	Sealed Bearing	Sealed Bearing
	- Outer				
Front Wheel Kit		<b>PQ1009</b>	<b>PQ660</b> [1.3, 1.4, 1.6, 1.8] [5 Studs] [26 Splines] <b>PQ661</b> [2.0] [5 Studs] [30 Splines]	<b>PQ781</b> <b>PQ923</b> [ASB 2011-]	<b>PQ923</b>
Front Wheel Hub / Stub Axle				<b>781HUB</b> <b>923HUB</b> [Disc Spigot ID: 91mm] [solid discs]	<b>923HUB</b> [Disc Spigot ID: 91mm] [solid discs]
Alternator / Generator Bearing	- Front				
	- Rear				
Concentric / Thrust Bearing			<b>RB9891</b> [1.4, 1.6, 1.8] <b>RB9005</b> [2.0D-4D] <b>Concentric Slave</b> <b>Cylinder</b> [1.3]	<b>RB9627</b>	<b>RB9627A</b>
Diff Carrier Bearing	- Left			<b>AVZ44KB721</b>	<b>AVZ44KB721</b>
	- Right			<b>AVZ44KB721</b>	<b>AVZ44KB721</b>
Diff Pinion Bearing	- Front			<b>AVZPF0506</b>	<b>AVZPF0506</b>
	- Rear			<b>AVZPF3072</b>	<b>AVZPF3072</b>
Propshaft Support Bearing					
Pulley Bearing					
Spigot Shaft Bearing					
V-Belt Tensioner				<b>VBT008</b> <b>VBT016</b> [1.5i]	
Drive Shaft Oil Seal	- Left		<b>9699</b> [1.3, 1.4, 1.6] <b>9214</b> [1.8, 2.0]		
	- Right		<b>9646</b> [1.3, 1.4, 1.6] <b>9214</b> [1.8, 2.0]		
Gearbox Oil Seal	- Front			<b>9121</b>	<b>9121</b>
	- Rear		<b>304207</b>	<b>9122</b> <b>9123</b> [Ext. Housing]	<b>9122</b> <b>9123</b> [Ext. Housing Man.] <b>9125</b> [Ext. Housing Auto.]
Pinion Oil Seal				<b>9124</b>	<b>9124</b>
Rear Main Bearing Oil Seal			<b>9092FS</b> [1.3, 1.6] <b>9351</b> [1.8] <b>9354</b> [2.0]	<b>9305</b>	<b>9305</b>
Timing Cover / Cam Oil Seal			<b>9804</b> [Cam 1.4, 1.6, 1.8] <b>9576</b> [T/Cover 1.3, 1.6] <b>385006</b> [T/Cover 1.8] <b>9350</b> [T/Cover 2.0]	<b>253807</b> [Cam] <b>385007</b> [Cam][1.5i] <b>9765</b> [T/Cover]	<b>9765</b> [T/Cover]
Rear Wheel Bearing	- Inner	<b>HUB323</b>	<b>HUB167</b> [Jap. make] [with integrated ABS sensor] <b>HUB168</b> [UK make] [with integrated ABS sensor]	<b>TOY32BCVAVZ +</b> <b>RR55</b> <b>TOY32BCVAVZ +</b> <b>RR50</b> [1.5i]	<b>TOY32BCVAVZ +</b> <b>RR50</b>
	- Outer				
Rear Wheel Oil Seal	- Inner	HUB UNIT	HUB UNIT	<b>9299</b>	<b>9299</b>
	- Outer				
Rear Wheel Kit		<b>PQ1010</b>	<b>PQ838</b> [Metal end cap] <b>PQ839</b> [2.0] [Plastic ribbed end cap]	<b>PQ859</b> <b>PQ783</b> [1.5i]	<b>PQ783</b>
Rear Wheel Hub / Stub Axle					

APPLICATIONS	LOCATION	TOYOTA AVANZA	TOYOTA AVENSIS	TOYOTA AYGO	TOYOTA C-HR
		1.3 S, SX MPV 1NRVE 1.3 S P/Van 1NRVE 1.5 SX, TX MPV 2NRVE	2.0i Advanced 2.2 D4D Exclusive 2.4i Exclusive	1.0 Fresh, Inferno, Wild 3/5-door, X-Cite, X-Play 1KR	1.2 T 8NR-FTS
YEARS		2015-	06-09	2011-	2017-
Front Wheel Bearing	- Inner	DAC38BWDVAZASB	40BWD12 45BWDVER [2.2]	DACFWB107ASB	HUB402
	- Outer				
Front Wheel Oil Seal	- Inner	Sealed Bearing	Sealed Bearing	Sealed Bearing	HUB UNIT
	- Outer				
Front Wheel Kit		PQ923	PQ598 PQ792 [2.2]	PQ634	PQ1130 [5 Studs]
Front Wheel Hub / Stub Axle		923AHUB [Disc Spigot ID: 87mm] [ventilated discs]	598BHUB [5 Studs]	634HUB	
Alternator / Generator Bearing	- Front				
	- Rear				
Concentric / Thurst Bearing		RB9627A	RB9008 [2.0] RB9005 [2.2]	RB9692	Concentric Slave Cylinder
Diff Carrier Bearing	- Left	AVZ44KB721			
	- Right	AVZ44KB721			
Diff Pinion Bearing	- Front	AVZPF0506			
	- Rear	AVZPF3072			
Propshaft Support Bearing					
Pulley Bearing					
Spigot Shaft Bearing					
V-Belt Tensioner					
Drive Shaft Oil Seal	- Left		9214 [2.4] 9805 [2.0, 2.2]		9115
	- Right		9214 [2.0, 2.2, 2.4i] 9353 [2.0, 2.2 Alt.]	9646	9355
Gearbox Oil Seal	- Front	9121			
	- Rear	9122 9123 [Ext. Housing Man.] 9125 [Ext. Housing Auto.]	304207		
Pinion Oil Seal		9124			
Spark Plug Tube Seal					
Rear Main Bearing Oil Seal		9095	9093 9354 [2.2]	9305	9157
Timing Cover / Cam Oil Seal		9094 [T/Cover]	385007 [Cam 2.0, 2.2] 385006 [T/Cover 2.0] 9804 [T/Cover 2.4] 9350 [T/Cover 2.2]	385006 [T/Cover]	9094 [T/Cover]
Rear Wheel Bearing	- Inner	TOY32BCVAVZ + RR50	HUB169 HUB255 [2.2] [with integrated ABS sensor]	HUB145 [with integrated ABS sensor]	HUB403
	- Outer				
Rear Wheel Oil Seal	- Inner	9299	HUB UNIT	HUB UNIT	HUB UNIT
	- Outer				
Rear Wheel Kit		PQ783	PQ840 [5 Studs] PQ819 [2.2] [5 Studs]	PQ802 [4 Studs]	PQ1131 [5 Studs]
Rear Wheel Hub / Stub Axle					

APPLICATIONS	LOCATION	TOYOTA CAMRY I	TOYOTA CAMRY I	TOYOTA CAMRY II	TOYOTA CONDOR
		SXV10/11 R 200i Si 3S-FE 220 SEi, Si, 5S-FE	MCV10/ VCV10 300SEi 1MZ-FE / 3VZ-FE, Quad Cam	2.0 2.4i XLi 3.0 GLX 1MZ-FE	4X2 1.6 Estate, TE, 5L 1.8 2Y 2.0i Estate, TE, 1RZ Pet. 2.4i Estate, TE, TX 2RZ-E 3.0D Estate, TE, 5L Dies.
YEARS		92-01	94-01	01-06	00-05
Front Wheel Bearing	- Inner	43BWD06	43BWD06	45BWDVER	67010+48
	- Outer				11910+49
Front Wheel Oil Seal	- Inner	Sealed Bearing	Sealed Bearing	Sealed Bearing	9442
	- Outer				
Front Wheel Kit		PQ353	PQ353	PQ792	PQ136
Front Wheel Hub / Stub Axle		353HUB [30 Spline] 353AHUB [26 Spline]	353HUB [30 Spline] 353AHUB [26 Spline]	792HUB	
Alternator / Generator Bearing	- Front	64032RS [92-97] 62022RS [97-01]	62012RS [92-97] 64032RS [97-01]	B17-99DDW8C	
	- Rear	62012RS C3	62022RS [92-97] 62012RS [97-01]		
Concentric / Thurst Bearing		RB9866	RB9890	RB9866	RB9896 [1.6, 1.8, 2.0] RB9804 [2.4i] RB9628 [3.0]
Diff Carrier Bearing	- Left	44KB721	TR100902D-2-N		17831+887
	- Right	TRA080702N	ST5791-N [Man.] ST5793-N [Auto. -97] 50KB904 [Auto. 97-01]		17831+887
Diff Pinion Bearing	- Front	TR070602S-N	ST3668YR1-N		86610+49
	- Rear	30208	30208		88610+49
Propshaft Support Bearing					
Pulley Bearing					
Spigot Shaft Bearing					62012RS
V-Belt Tensioner				VBT005 [2.4]	
Drive Shaft Oil Seal	- Left	9799	9810 [Man.] 9805 [Auto.]	9214	
	- Right	9799	9810 [Man.] 9805 [Auto.]	9215	
Gearbox Oil Seal	- Front	304207 [Man.] 385509 [Auto.]	304207 [Man.] 9810 [Auto.]	9810 [Auto. 3.0]	304508
	- Rear				385811
Pinion Oil Seal		9666 [Auto. 92-01] 9646 [Auto. Alt.]			2738
Spark Plug Tube Seal					
Rear Main Bearing Oil Seal		9649	9807	9093 [2.4] 9807 [3.0]	9648 [1.6, 1.8, 2.0] 9649 [2.4, 3.0]
Timing Cover / Cam Oil Seal		9804 [Cam] 426007 [T/Cover]	9804 [Cam x 2 92-97] 9789 [Cam x 2 97-01]	405507 [T/Cover 3.0] 9789 [Cam 3.0] 9804 [Cam 2.4, 3.0 & T/Cover 2.4]	426007 [T/Cover] 9643 [Cam 2.4i]
Rear Wheel Bearing	- Inner	DACF1097C	HUB017 [Gear type ABS]	HUB094 [2.0] HUB324 [RHS] [with integrated ABS sensor] HUB325 [LHS] [with integrated ABS sensor]	35BW10+C014P
	- Outer				
Rear Wheel Oil Seal	- Inner	Sealed Bearing	HUB UNIT	HUB UNIT	9985
	- Outer				9601
Rear Wheel Kit		PQ360	PQ463 [5 Studs]	PQ657 [2.0] PQ1011 [RHS] PQ1012 [LHS]	PQ628
Rear Wheel Hub / Stub Axle					

APPLICATIONS		LOCATION	TOYOTA CONDOR 4X4 2.4i Estate, TX Estate 2RZ-E 3.0 Estate, TX Estate 5L	TOYOTA CONQUEST / TAZZ EE80 [85-93] 1.3 GL, GS, L, S 2EL EE90R [93-01] 130 Sport, Tazz, Edition, Zipp, Tropique Tazz EE90R [01-06] 130 Edition, Ruby, Tropique, Sport, McTazz, XE 2E	TOYOTA CONQUEST / TAZZ AE82R [85-88] 1.6 GL, RS, RSi 4A-L, A-GEL AE92R [88-01] 160i LS, RS, RSi, Sport, RSE, Tazz 4A-F, A-FE, A-GE AE92R [01-06] 160i Edition, Sport, Tazz, XE 4AFE	TOYOTA CONQUEST AE93 180i RS, RSi, Sport 7A-FE
YEARS			00-05	85-06	85-88 [AE82] 88-06 [AE92]	93-96
Front Wheel Bearing	- Inner		46T090A	38003 [85-88] DAC387233 [88-06]	38003 [85-88] DAC387233 [88-06]	DAC387233
	- Outer					
Front Wheel Oil Seal	- Inner			9645 [Kit] [85-88] 9795 [Kit] [88-06]	9645 [Kit] [85-88] 9795 [Kit] [88-06]	9795 [Kit]
	- Outer		9984			
Front Wheel Kit			PQ627	PQ313 [85-88] PQ377 [88-06]	PQ313 [85-88] PQ377 [88-06]	PQ377
Front Wheel Hub / Stub Axle			627HUB	377HUB [Brake disc ID: 54mm] 377AHUB [Brake disc ID: 55mm]	377HUB [Brake disc ID: 54mm] 377AHUB [Brake disc ID: 55mm]	377HUB [Brake disc ID: 54mm] 377AHUB [Brake disc ID: 55mm]
Alternator / Generator Bearing	- Front			63032RS	3192RS [RSE, RSi] 63032RS [Others]	3192RS
	- Rear			62012RS	2792RS [RSE, RSi] 62012RS [Others]	2792RS
Concentric / Thurst Bearing			RB9804 [2.4] RB9628 [3.0]	RB9863 [85-00] RB9670 [00-06]	RB9863 [85-88] RB9891 [88-06]	RB9891
Diff Carrier Bearing	- Left		32915 [Fr. axle] 17831+887 [Rr. axle]	038KC68 [Man.] 038KB [Auto.]	038KB [85-88] 038KC68 [86-06]	039KC68
	- Right		32915 [Fr. axle] 17831+887 [Rr. axle]	TRA080702N [Man.] TR080702JN [Man.] 038KB [Auto.]	TRA080702N TR080702JN	TRA080702N
Diff Pinion Bearing	- Front		30306 [Fr. & Rr. axle]		R30-9 [Auto.]	
	- Rear		TR070904-1 [Fr. axle] 32307 [Rr. axle]		32006 [Auto.]	
Propshaft Support Bearing						
Pulley Bearing						
Spigot Shaft Bearing			62012RS			
V-Belt Tensioner						
Drive Shaft Oil Seal	- Left			9699	9699	9699
	- Right			9646	9646	9646
Gearbox Oil Seal	- Front		304508	253708	253708 [Man.] 385509 [Auto.]	253708 [Man.] 385509 [Auto.]
	- Rear		385811			
Pinion Oil Seal			9800 [Fr. axle] 2738 [Rr. axle]			
Spark Plug Tube Seal					9552 [AE92]	
Rear Main Bearing Oil Seal			9649	9703	9642	9642
Timing Cover / Cam Oil Seal			426007 [T/Cover] 9643 [Cam]	9765 [Cam, T/Cover]	9643 [T/Cover] 9765 [Cam, x 2 if DOHC]	9643 [T/Cover] 9765 [Cam x2]
Rear Wheel Bearing	- Inner		35BW10+C014P	28006 [85-91] HUB012 [91-06][Non ABS]	28006 [85-91] HUB012 [91-06][Non ABS]	HUB014 [ABS Ring Gear]
	- Outer					
Rear Wheel Oil Seal	- Inner		9985	9644 [85-91] HUB UNIT [91-06]	9644 [85-91] HUB UNIT [91-06]	HUB UNIT
	- Outer		9601			
Rear Wheel Kit			PQ628	PQ314 [85-91] PQ452 [91-06][4 Studs]	PQ314 [85-91] PQ452 [91-06][4 Studs]	PQ456 [4 Studs]
Rear Wheel Hub / Stub Axle				314HUB 452HUB [OD: 140mm] 452AHUB [OD: 125mm]	314HUB 452HUB [OD: 140mm] 452AHUB [OD: 125mm]	

APPLICATIONS	LOCATION	TOYOTA CONQUEST EE90	TOYOTA COROLLA RWD	TOYOTA COROLLA	TOYOTA COROLLA
		130 Carri P/van, 2E	TE31 1.6 Sprinter, SR4/5, Black Hawk, Silver Wolf 2T AE/TE71 1.6 GL, S/W, GLS Sprinter, SE 2T, TB TE72 1.8 GLS, SE 3T	TE71 1.6 P/van 2T	KE70 1.3 P/van 4K
YEARS		98-06	80-88	83-89	84-88
Front Wheel Bearing	- Inner	DAC387233	331274	44610+49	331274
	- Outer		11710+49	11710+49	11710+49
Front Wheel Oil Seal	- Inner	9795 [Kit]	9485	405207	9485
	- Outer				
Front Wheel Kit		PQ377	PQ113	PQ311	PQ113
Front Wheel Hub / Stub Axle		377HUB [Brake disc ID: 54mm] 377AHUB [Brake disc ID: 55mm]			
Alternator / Generator Bearing	- Front	63032RS	62032RS	62032RS	62032RS
	- Rear	62012RS	62012RS	62012RS	62012RS
Concentric / Thurst Bearing		RB9863	RB9548	RB9548	RB9586
Diff Carrier Bearing	- Left	038KC68	29710+49	17831+887 [Imp.] 29710+49 [Local]	48510+48 [Imp.] 29710+49 [Local]
	- Right	TRA080702N	29710+49	17831+887 [Imp.] 29710+49 [Local]	48510+48 [Imp.] 29710+49 [Local]
Diff Pinion Bearing	- Front		86610+49	30306 [Imp.] 86610+49 [Local]	30306 [Imp.] 86610+49 [Local]
	- Rear		88610+49	32307 [Imp.] 88610+49 [Local]	32307 [Imp.] 88610+49 [Local]
Propshaft Support Bearing					
Pulley Bearing					
Spigot Shaft Bearing				6001ZZ	6001ZZ
V-Belt Tensioner					
Drive Shaft Oil Seal	- Left	9699			
	- Right	9646			
Gearbox Oil Seal	- Front	253708	253807 [Man.] 385509 [Auto.]	253807	253807
	- Rear		325211 [Man.] 385811 [Auto.]	325211	325211
Pinion Oil Seal			2738	355511 [Imp.] 2738 [Local]	355511 [Imp.] 2738 [Local]
Spark Plug Tube Seal					
Rear Main Bearing Oil Seal		9703	7510013	7510013	9642
Timing Cover / Cam Oil Seal		9765 [Cam +T/Cover]	385811 [T/Cover]	385811 [T/Cover]	385811 [T/Cover]
Rear Wheel Bearing	- Inner	HUB012 [Non ABS]	412971 + RR30 [Sedan] 1700289 + RR35 [S/W]	88506 + RR29 [Imp.] 412971 + RR30 [Local]	B32-10 + RR43 [Imp.] 412971 + RR30 [Local]
	- Outer				
Rear Wheel Oil Seal	- Inner	HUB UNIT	Sealed Bearing [Sedan] 2641 [S/W]	526509 [Imp.] Sealed Bearing [Local]	415607 [Imp.] Sealed Bearing [Local]
	- Outer				
Rear Wheel Kit		PQ452 [Non ABS]	PQ154 [Sedan] PQ145 [S/W]	PQ154 [Local]	PQ186 [Imp.] PQ154 [Local]
Rear Wheel Hub / Stub Axle		452HUB [OD: 140mm] 452AHUB [OD: 125mm]			

APPLICATIONS	LOCATION	TOYOTA COROLLA FWD AE82R	TOYOTA COROLLA FWD AE/EE80R [84-88]	TOYOTA COROLLA FWD AE92R	TOYOTA COROLLA FWD AE93R
		1.6 GL, GLE, GLi, GLS, GLX, Avante, GLE, GLi, S/W 4A-L, A-GEL	1.3 GL, L, 2A-L, E-L EE90R [88-96] 1.3 GL, GLE, L, Sprinter 2E-L, E EE110R [96-02] 130 GLE, Sprinter 2E	1.6, 160 GL, GLE, GLi, Exec., GLS, Exec., GLX, Sport Sprinter 4A-F, A-FE, A-GE	180i GL, GLE, GSE, GSX, Sprinter 7A-FE
YEARS		84-88	84-02	88-96	93-96
Front Wheel Bearing	- Inner	38003	38003 [85-88] DAC387233 [88-02]	DAC387233	DAC387233
	- Outer				
Front Wheel Oil Seal	- Inner	9645 [Kit]	9645 [Kit] [85-88] 9795 [Kit] [88-02]	9795 [Kit]	9795 [Kit]
	- Outer				
Front Wheel Kit		PQ313	PQ313 [85-88] PQ377 [88-02]	PQ377	PQ377
Front Wheel Hub / Stub Axle		377HUB [Brake disc ID: 54mm]	377HUB [Brake disc ID: 54mm] 377AHUB [Brake disc ID: 55mm]	377HUB [Brake disc ID: 54mm] 377AHUB [Brake disc ID: 55mm]	377HUB [Brake disc ID: 54mm] 377AHUB [Brake disc ID: 55mm]
Alternator / Generator Bearing	- Front	3192RS 63032RS [Others]	63032RS [84-96] 63112RS [96-02]	3192RS 63032RS [Others]	3192RS
	- Rear	2792RS 62012RS [Others] or see Page I	62012RS [84-96] 62022RS [96-02]	2792RS 62012RS [Others] or see Page I	2792RS or see Page I
Concentric / Thurst Bearing		RB9863	RB9863 [84-00] RB9670 [00-02]	RB9863 [88-93] RB9891 [93-96]	RB9891
Diff Carrier Bearing	- Left	038KB [84-86] 038KC68 [86-88]	038KC68 [88-96]	038KC68 [Man.] 038KB [Auto.]	038KC68 [Man.] 038KB [Auto.]
	- Right	038KB [Auto. 3 Spd.] TRA080702N [Others]	TRA080702N TR080702JN	TRA080702N [Man.] TR080702JN [Man.] 038KB [Auto.]	TRA080702N [Man.] TR080702JN [Man.] 038KB [Auto.]
Diff Pinion Bearing	- Front	30208 [Auto. 3 Spd.] 32006 [Auto. 4 Spd.]	32006 [96-02]	30208 [Auto. 3 Spd.] 32006 [Auto. 4 Spd.]	32006 [Auto.]
	- Rear	32007 [Auto. 3 Spd.] R30-9 [Auto. 4 Spd.]	R30-9 [96-02]	32007 [Auto. 3 Spd.] R30-9 [Auto. 4 Spd.]	R30-9 [Auto.]
Propshaft Support Bearing					
Pulley Bearing					
Spigot Shaft Bearing					
V-Belt Tensioner					
Drive Shaft Oil Seal	- Left	9699	9699	9699	9699
	- Right	9646	9646	9646	9646
Gearbox Oil Seal	- Front	253708 [Man.] 385509 [Auto.]	253807	253708 [Man.] 385509 [Auto.]	253708 [Man.] 385509 [Auto.]
	- Rear				
Pinion Oil Seal					
Spark Plug Tube Seal				9552	
Rear Main Bearing Oil Seal		9642	9642 [84-88] 9703 [88-02]	9642 [88-96]	9642
Timing Cover / Cam Oil Seal		9643 [T/Cover] 9765 [Cam]	9643 [T/Cover 84-88] 9765 [Cam, T/Cover]	9643 [T/Cover 88-93] 446510 [T/Cover 93-96] 9765 [Cam]	9643 [T/Cover] 9765 [Cam Exhaust] 9224 [Cam Intake]
Rear Wheel Bearing	- Inner	28006	28006 [84-91] HUB012 [91-02] [Non ABS]	28006 [88-91] HUB012 [91-96] [Non ABS]	HUB012 [Drums] [Non ABS] HUB014 [Discs] [ABS Ring Gear]
	- Outer				
Rear Wheel Oil Seal	- Inner	9644	9644 [84-91] HUB UNIT [91-02]	9644 [88-91] HUB UNIT [91-96]	HUB UNIT
	- Outer				
Rear Wheel Kit		PQ314	PQ314 [84-91] PQ452 [91-02][4 Studs]	PQ314 [88-91] PQ452 [91-96][4 Studs]	PQ452 [Drums][4 Studs] PQ456 [Discs][4 Studs]
Rear Wheel Hub / Stub Axle		314HUB	314HUB 452HUB [OD: 140mm] 452AHUB [OD: 125mm]	314HUB 452HUB [OD: 140mm] 452AHUB [OD: 125mm]	452HUB [OD: 140mm] 452AHUB [OD: 125mm]



APPLICATIONS	LOCATION	TOYOTA COROLLA FWD AE111R	TOYOTA COROLLA FWD F11	TOYOTA COROLLA FWD	TOYOTA COROLLA FWD
		160i GL, GLE, RSi, RXi 4A-FE, A-GE AE112 180i GLE, GSE 7A-FE	140i GLE, GLS, Sprinter 4ZZ-FE KS1 160i GLE, GLS, GSX, Sprinter VVT-i 3ZZ-FE DOHC GF2 180i GLE, GLS, GSX, Sprinter VVT-I 1ZZ-FE DOHC	1.3 Advanced, Impact, Professional 1.4D Esteem 1NDTV, Prestige 1.6i Professional, Advanced 1ZRFE 1.8 Exclusive, Pristage 2ZR-FE	2.0 2.0D D-4D Advanced, Exclusive
YEARS		96-02	02-08	2007-	07-14
Front Wheel Bearing	- Inner	DAC387233	40BWD12	HUB165 [with integrated ABS sensor]	40BWD12 HUB166 [D-4D] [with integrated ABS sensor]
	- Outer				
Front Wheel Oil Seal	- Inner	9795 [Kit] [Non ABS] 9895 [Kit] [ABS]	Sealed Bearing	HUB UNIT	Sealed Bearing HUB UNIT
	- Outer				
Front Wheel Kit		PQ377 [Non ABS] PQ453 [ABS]	PQ598	PQ660 [5 Studs]	PQ598 PQ661 [5 Studs] [30 Spline]
Front Wheel Hub / Stub Axle		377HUB [Brake disc ID: 54mm] 377AHUB [Brake disc ID: 55mm]	598HUB		
Alternator / Generator Bearing	- Front	63112RS			
	- Rear	62022RS or see Page I			
Concentric / Thurst Bearing		RB9891	RB9670	Concentric Slave Cylinder	Concentric Slave Cylinder
Diff Carrier Bearing	- Left	038KC68 [Man.]			
	- Right	TRA080702N TR080702JN [Man./ Auto.]			
Diff Pinion Bearing	- Front	R30-9 [Auto.]			
	- Rear	32006 [Auto.]			
Propshaft Support Bearing					
Spigot Shaft Bearing					
V-Belt Tensioner			VBT004 [GLE, GLS, GXS]	VBT004	
Drive Shaft Oil Seal	- Left	9699	9699	9355 [1.8] 9699	9214
	- Right	9646	9646	9355 [1.8] 9646	9214
Gearbox Oil Seal	- Front	253708 [Man.] 385509 [Auto.]	253708	304207	304207
	- Rear		385811		
Pinion Oil Seal					
Rear Main Bearing Oil Seal		9642 [160i]	9220	9092FS [1.3] 9220 [1.4] 9351 [1.6, 1.8]	9351 9354 [D-4D]
Timing Cover / Cam Oil Seal		9643 [T/Cover] 9765 [Cam Exhaust] 9224 [Cam Intake]	9804 [Cam + T/Cover][140i, 180i] 9643 [T/Cover][160i, 180i] 9765 [Cam Exhaust][160i] 9224 [Cam Intake][160i]	9804 [T/Cover / Cam 1.4] 9576 [T/Cover 1.3] 385006 [T/Cover 1.6, 1.8]	385006 [T/Cover 2.0] 9350 [T/Cover 2.0 D-4D]
Rear Wheel Bearing	- Inner	HUB012 [Drums] [Non ABS] HUB014 [Discs] [ABS Ring Gear]	HUB101 [Non ABS] [140i, 160i] HUB090 [with integrated ABS sensor]	HUB167 [Jap. Mod] [with integrated ABS sensor] HUB168 [S.A Mod] [with integrated ABS sensor]	HUB168 [with integrated ABS sensor]
	- Outer				
Rear Wheel Oil Seal	- Inner	HUB UNIT	HUB UNIT	HUB UNIT	HUB UNIT
	- Outer				
Rear Wheel Kit		PQ452 [Drums] [4 Studs] PQ456 [Discs][4 Studs]	PQ703 [Non ABS] [4 Studs] [140i, 160i] PQ650 [ABS] [4 Studs]	PQ838 [Metal end cap] [5 Studs] PQ839 [5 Studs] [Plastic ribbed end cap]	PQ839 [5 Studs] [Plastic ribbed end cap]
Rear Wheel Hub / Stub Axle		452HUB [OD: 140mm] 452AHUB [OD: 125mm]			



APPLICATIONS	LOCATION	TOYOTA COROLLA QUEST FWD 1.6 Auto, Plus	TOYOTA COROLLA VERSO ZZE122 160i S, SX MPV 180i SX, SX MMT, TX, TX MMT MPV 1ZZ-FE	TOYOTA COROLLA VERSO 1.6 3ZZ-FE 1.8 1ZZ-FE 2.0 D-4D 1CD-FTV	TOYOTA CRESSIDA TX30 1.8 DX 3T TX62 1.8 L, LS 3T YX70 1.8 LS, Exec.
		YEARS	2014-	04-09	09-14
Front Wheel Bearing	- Inner	HUB165 [with integrated ABS sensor]	40BWD12 45BWDVER [Alt.]	HUB165 [1.6, 1.8] [with integrated ABS sensor] HUB166 [D-4D] [with integrated ABS sensor]	67010+48
	- Outer				11910+49
Front Wheel Oil Seal	- Inner	HUB UNIT	Sealed Bearing	HUB UNIT	9442
	- Outer				
Front Wheel Kit		PQ660 [5 Studs]	PQ598 PQ792 [Alt.]	PQ660 [1.6, 1.8] [5 Studs] [26 Spline] PQ661 [5 Studs] [30 Spline]	PQ136
Front Wheel Hub / Stub Axle			598HUB 792HUB		136BHUB
Alternator / Generator Bearing	- Front				62032RS
	- Rear				62012RS
Concentric / Thurst Bearing		RB9891	RB9661 RB9670 [Alt.]	RB9005 [2.0D-4D] Concentric Slave Cylinder [1.6, 1.8]	RB9548
Diff Carrier Bearing	- Left				29710+49
	- Right				29710+49
Diff Pinion Bearing	- Front				86610+49
	- Rear				88610+49
Propshaft Support Bearing					
Pulley Bearing					
Spigot Shaft Bearing					6001ZZ [3T] 62012RS [2Y]
V-Belt Tensioner			VBT004 [1.6]	VBT004 [1.6 2009]	
Drive Shaft Oil Seal	- Left	9799	9699		
	- Right	9799	9646		
Gearbox Oil Seal	- Front		253708		304508
	- Rear		385811		385811 [Man.] 385811RK [Kit Auto.]
Pinion Oil Seal					2738
Spark Plug Tube Seal					
Rear Main Bearing Oil Seal		9351	9220	9351 9354 [D-4D]	7510013 [3T] 9648 [2Y]
Timing Cover / Cam Oil Seal		385006 385008	9643 [T/Cover] 9804 [Cam]	385006 [T/Cover 1.6, 1.8] 9350 [T/Cover 2.0 D-4D]	385811 [T/Cover 3T] 426007 [T/Cover 2Y]
Rear Wheel Bearing	- Inner	HUB167 [with integrated ABS sensor]	HUB139 [with integrated ABS sensor]	HUB254 [with integrated ABS sensor] HUB168	412971 + RR30 [3T] 1700289 + RR35 [2Y]
	- Outer				
Rear Wheel Oil Seal	- Inner	HUB UNIT	HUB UNIT	HUB UNIT	Sealed Bearing [3T] 2641 [2Y]
	- Outer				
Rear Wheel Kit		PQ838 [5 Studs]	PQ796 [OD: 139.8mm] [5 Studs]	PQ812 [OD: 152mm] [5 Studs] PQ839	PQ154 [3T] PQ145 [2Y]
Rear Wheel Hub / Stub Axle					

APPLICATIONS	LOCATION	TOYOTA CRESSIDA RX60 2.0 GL, GLE, GLX, S/W 21R RX70, YX72 2.0 GL, GL, GLE, GLX	TOYOTA CRESSIDA GX60 2.0 GLi6 1G-E GX7 2.0 GLi6 1G-E, 1G-FE	TOYOTA CRESSIDA MX63 2.8i 5M-E MX73 2.8i RSi, RSi Exec. 5M-GE	TOYOTA CRESSIDA MX75 3.0i ECT, GLS 7MG-E
		YEARS	81-92	83-92	84-89
Front Wheel Bearing	- Inner	67010+48	67010+48	67010+48	67010+48
	- Outer	11910+49	11910+49	11910+49	11910+49
Front Wheel Oil Seal	- Inner	9442	9442	9442	9442
	- Outer				
Front Wheel Kit		PQ136	PQ136	PQ136	PQ136
Front Wheel Hub / Stub Axle		136BHUB	136BHUB	136BHUB	136BHUB
Alternator / Generator Bearing	- Front	62032RS	62032RS	62032RS	62032RS
	- Rear	62012RS	62012RS	62012RS	62012RS
Concentric / Thurst Bearing		RB9548 [RX60] RB9804 [RX70, YX72]	RB9548 [GX60] RB9896 [GX71]	RB9548	RB9896
Diff Carrier Bearing	- Left	29710+49 [Sedan] 501310+49 [S/W]	R45-Z2 [Man.]	R45-Z2	50KB8301
	- Right	29710+49 [Sedan] 501310+49 [S/W]	R45-Z2 [Man.]	R45-Z2	50KB8301
Diff Pinion Bearing	- Front	86610+49	30306 [Man.] 86610+49 [Auto.]	30306	TR0607J-1
	- Rear	88610+49	32307 [Man. 83-89] TR0708-1YR-N [Man. 89-92] 88610+49 [Auto.]	32307	TR070904-1
Propshaft Support Bearing					
Pulley Bearing					
Spigot Shaft Bearing		62012RS [21R] 6001ZZ [3Y]	60012RS	62012RS	60012RS
V-Belt Tensioner					
Drive Shaft Oil Seal	- Left		9706 [Diff Seal]	9706 [Diff Seal]	9783 [Diff Seal]
	- Right		9706 [Diff Seal]	9706 [Diff Seal]	9783 [Diff Seal]
Gearbox Oil Seal	- Front	304508	304508	304508	304508 [Man.] 385509 [Auto.]
	- Rear	385811 [Man.] 385811RK [Kit Auto.]	385811 [Man.] 385811RK [Kit Auto.]	385811 [Man.] 385811RK [Kit Auto.]	385811 [Man.] 405810 [Auto.]
Pinion Oil Seal		2738	387411 [Man.] 9707 [Auto.]	387411	387411
Spark Plug Tube Seal					
Rear Main Bearing Oil Seal		8010012	8010012 [21R] 9648 [3Y]	8010012	8010012
Timing Cover / Cam Oil Seal		456812 [T/Cover]	456812 [T/Cover 21R] 426007 [T/Cover 3Y]	9704 [Cam MX73] 456812 [T/Cover MX63] 487012 [T/Cover MX73]	9765 [Cam] 9669 [Crank Front] 426007 [T/Cover]
Rear Wheel Bearing	- Inner	412971 + RR30 [81-86 GL, GLE, GLX] 1700289 + RR35 [Rest]	32006JR	32006JR	32006JR
	- Outer		68111/49	68111/49	68111/49
Rear Wheel Oil Seal	- Inner	Sealed Bearing [81-86 GL, GLE, GLX] 2641 [Rest]	9748	9748	9748
	- Outer		486209	486209	486209
Rear Wheel Kit		PQ154 [81-86 GL, GLE, GLX] PQ145 [Rest]	PQ315	PQ315	PQ315
Rear Wheel Hub / Stub Axle					

APPLICATIONS	LOCATION	TOYOTA CRESSIDA RX72 2.4 GL, GL S/W, GLE, GLE S/W 22R	TOYOTA CRESSIDA RX73 2.4 GLE, GLE S/W 22R With I.R.S. (Independent Rear Suspension)	TOYOTA ETIOS 1.5 xi/xs 5-door [12-13] 1.5 2NRFE [2013-]	TOYOTA FJ CRUISER 4X4 4.0 v6
		YEARS	87-92	87-92	2012-
Front Wheel Bearing	- Inner	67010+48	67010+48	HUB214L/R [with integrated ABS sensor]	HUB171 [with integrated ABS sensor]
	- Outer	11910+49	11910+49		
Front Wheel Oil Seal	- Inner	9442	9442	HUB UNIT	HUB UNIT
	- Outer				
Front Wheel Kit		PQ136	PQ136	PQ572L/R [4 Studs]	PQ663 [ASB]
Front Wheel Hub / Stub Axle		136BHUB	136BHUB		
Alternator / Generator Bearing	- Front	62032RS	62032RS		
	- Rear	62012RS	62012RS		
Concentric / Thurst Bearing		RB9804	RB9804	RB9661 RB9670 [Alt.]	
Diff Carrier Bearing	- Left	501310+49	R45-Z2 [Imp. IRS]		
	- Right	501310+49	R45-Z2 [Imp. IRS]		
Diff Pinion Bearing	- Front	86610+49	30306 [Imp. IRS]		
	- Rear	88610+49	TR0708-1YR-N [Imp. IRS]		
Propshaft Support Bearing					
Pulley Bearing					
Spigot Shaft Bearing		62012RS	62012RS		
V-Belt Tensioner					VBT007
Drive Shaft Oil Seal	- Left		9706 [Diff Seal]	9699 [2012-]	
	- Right		9706 [Diff Seal]	9646 [2013-] 9104 [12-13]	
Gearbox Oil Seal	- Front	304508 [Man.] 385509 [Auto.]	304508 [Man.] 385509 [Auto.]	9356 [2012-]	
	- Rear	385811 [Man.] 385811RK [Kit Auto.]	385811 [Man.] 385811RK [Kit Auto.]		
Pinion Oil Seal		2738	387411 [Imp. IRS]		
Spark Plug Tube Seal					
Rear Main Bearing Oil Seal		7510013 [83-89] 9703 [89-92]	9648	9095	9358
Timing Cover / Cam Oil Seal		385007 [Cam 83-89] 9765 [Cam 89-92] 456812 [T/Cover]	456812 [T/Cover]	9094 [T/Cover]	426007 [T/Cover]
Rear Wheel Bearing	- Inner	1700289 + RR35	32006JR	HUB213 [with integrated ABS sensor]	HUB175L/R [with integrated ABS sensor]
	- Outer		68111/49		
Rear Wheel Oil Seal	- Inner	2641	9748	HUB UNIT	HUB UNIT
	- Outer		486209		
Rear Wheel Kit		PQ145	PQ315	PQ573 [4 Studs]	PQ842L/R
Rear Wheel Hub / Stub Axle					

APPLICATIONS	LOCATION	TOYOTA FORTUNER 4X2 3.0 D-4D SUV 1KD-FTV 4.0 V6, Epic SUV 1GR-FE Pet.	TOYOTA FORTUNER 4X4 3.0 D-4D SUV 1KD-FTV 4.0 V6, Epic SUV 1GR-FE	TOYOTA FORTUNER 4X2, 4X4 2.5D-4D 2KD-FTV 3.0D-4D 1KD-FTV	TOYOTA FORTUNER 4X2, 4X4 4.0 V6 1GR-FE 4.0 V6 Raised Body 1GR-FE
YEARS		06-11	06-11	11-16	11-16
Front Wheel Bearing	- Inner	HUB131 [NON ASB] HUB171 [with integrated ABS sensor]	HUB131 [NON ASB] HUB171 [with integrated ABS sensor]	HUB131 [NON ASB]	HUB131
	- Outer				
Front Wheel Oil Seal	- Inner	9287 9577	9287 9577	9287 9577 [4x4]	9287 [4x2, 4x4] 9577 [4x4]
	- Outer				
Front Wheel Kit		PQ761 [NON ASB] PQ663 [ASB]	PQ761 PQ663 [ASB]	PQ761	PQ761
Front Wheel Hub / Stub Axle		761AHUB 663HUB	761AHUB 663HUB	761HUB + RR62 [4x4] 761AHUB [4x2]	761HUB + RR62 [4x4] 761AHUB [4x2]
Concentric / Thrust Bearing			RB9671 RB9628 [3.0]	RB9671 [2KD-FTV] RB9628 [1KD-FTV]	
Diff Carrier Bearing	- Left	TR100802	32915 [Fr. Diff] TR100802 [Rr. Diff]	32915 [Rr. Diff]	STA5383 [Fr. Diff] 4x4 32915 [Rr. Diff] 4x2
	- Right	TR100802	32915 [Fr. Diff] TR100802 [Rr. Diff]	TR100802 [Rr. Diff]	FH438017 [Fr. Diff] 4x4 TR100802 [Rr. Diff] 4x2
Diff Pinion Bearing	- Front	STA3072	STA3072 [Fr. & Rr. axle]	TR070904-1 [Fr. Diff 2.5 3.0 4x4] STA3072 [Rr. Diff 2.5 3.0 4x2, 4x4]	TR070904-1 [Fr. Diff] STA3072 [Rr. Diff]
	- Rear	TR070904-1	TR070904-1 [Fr. & Rr. axle] STA5383 [Rr. Alt.]	STA3072 [Fr. Diff 3.0 4x4] TR070904-1 [Rr. Diff 2.5 3.0 4x4]	STA3072 [Fr. Diff] TR070904-1 [Rr. Diff]
V-Belt Tensioner			VBT007 [4.0] VBT009 [3.0]		VBT010
Drive Shaft Oil Seal	- Left		9108 9117 [CV Joint Seal]	9117 [CV Joint Seal][4x4]	9117 [CV Joint Seal][4X4]
	- Right		9109 9117 [CV Joint Seal]	9117 [CV Joint Seal][4X4]	9117 [CV Joint Seal][4X4]
Gearbox Oil Seal	- Front	9503	9503 304508 [3.0]	9503 [2.5, 3.0] 304508 [3.0]	
	- Rear		9504 [Transfer case] 9505 [Ext. Housing]	9540 [2.5 Man. ext. housing] 9119 [2.5 Auto. ext. housing] 9504 [3.0 ext. housing] 9505 [Transfer housing]	9119 [ext. housing] 9118 [Transfer housing]
Pinion Oil Seal		9359	9359 [Fr. & Rr.]	9568 2.5 [ID: 48mm] 9359 2.5, 3.0 [ID: 41mm]	9359
Rear Main Bearing Oil Seal		9790 [2.5, 3.0] 9358 [4.0]	9649 [3.0] 9790 [3.0 1KD-FTV] 9358 [4.0]	9790 [2.5, 3.0 1KD-FTV] 9649 [3.0]	
Timing Cover / Cam Oil Seal		426007 [T/Cover 4.0] 9286 [T/Cover 3.0] 9303 [Cam 3.0] 657907 [Aux. Pulley 3.0]	426007 [T/Cover 3.0, 4.0] 9286 [T/Cover 3.0 1KD-FTV] 9303 [Cam 3.0] 657907 [Aux. Pulley 3.0]	426007 [T/Cover 3.0] 9286 [T/Cover 2.5, 3.0 1KD-FTV] 9303 [Cam] 657907 [Aux. Pulley 3.0]	
Rear Wheel Bearing	- Inner	40BCV09 + RR42 [Local 06-09] DG409026P + RR42 [Imported 06-09] TOY42KWD + RR51 [09-]	40BCV09 + RR42 [Local 06-09] DG409026P + RR42 [Imported 06-09] TOY42KWD + RR51 [09-11]	TOY42KWD + RR51	TOY42KWD + RR51
	- Outer				
Rear Wheel Oil Seal	- Inner	9416 [06-09] 507009 [06-09] 9406 [09-]	9416 [06-09] 507009 [06-09] 9406 [09-11]	9406	9406
	- Outer	9416 [06-09] 9403 [09-]	9416 [06-09] 9403 [09-]	9403	9403
Rear Wheel Kit		PQ649 [Local 06-09] PQ865 [Imp. 06-09] PQ896 [09-]	PQ649 [Local 06-09] PQ865 [Imp. 06-09] PQ896 [09-11]	PQ896	PQ896
Rear Wheel Hub / Stub Axle		896HUB	896HUB	896HUB	896HUB

APPLICATIONS	LOCATION	TOYOTA FORTUNER 4X2	TOYOTA FORTUNER 4X4	TOYOTA HIACE	TOYOTA HIACE
		2.4GD Raised Body 2GD-FTV 2.7 VVTi Raised Body 2TR-FE 2.8GD Raised Body 1GD-FTV	2.8GD DSi Raised Body 1GD-FTV 3.0D-4D 1KD-FTV 4.0 V6 1GR-FE	YH50/60 1.8 SWB / LWB P/van, LS Wagon 2Y Pet.	YH51/61 2.0 SWB/LWB 16 Seater Commuter, Super 10 Seater Custom Wagon, P/van 3Y Pet.
YEARS		2015-	2015-	83-91	83-86
Front Wheel Bearing	- Inner	HUB171 (with integrated ABS sensor)	HUB171 (with integrated ABS sensor)	48510+48	48510+48
	- Outer			12610+49	12610+49
Front Wheel Oil Seal	- Inner			506809	506809
	- Outer				
Front Wheel Kit		PQ663	PQ663	PQ171	PQ171
Front Wheel Hub / Stub Axle		663HUB 663AHUB	663HUB	171HUB	171HUB
Alternator / Generator Bearing	- Front			62032RS	62032RS
	- Rear			62012RS	62012RS
Concentric / Thurst Bearing		RB9663	RB9663	RB9548	RB9548
Diff Carrier Bearing	- Left	5383+5082 [Rr. Diff]	STA5383 [Fr. Diff] 5383+5082 [Rr. Diff]	501310+49 [83-87] 102910+49 [87-91]	17831+887 [Imported] 501310+49 [Local]
	- Right	4076+5076 [Rr. Diff]	STA5383 [Fr. Diff] 4076+5076 [Rr. Diff]	501310+49 [83-87] 102910+49 [87-91]	17831+887 [Imported] 501310+49 [Local]
Diff Pinion Bearing	- Front	3680+3580 [Rr. Diff]	TR070904-1 [Fr. Diff] 3680+3580 [Rr. Diff]	86610+49 [83-87] 86610+49 [87-91]	30306 [Imported 83-85] TRA0607-N [Imp. 86] 86610+49 [Local]
	- Rear	TR091004 [Rr. Diff]	STA3072 [Fr. Diff] TR091004 [Rr. Diff]	86610+49 [83-87] 86610+49 [87-91]	32307 [Imported 83-85] TRA07083C-N [Imp. 86] 86610+49 [Local]
Propshaft Support Bearing					
Pulley Bearing					
Spigot Shaft Bearing				62012RS	62012RS
V-Belt Tensioner			VBT010 [4.0]		
Drive Shaft Oil Seal	- Left		9117 [CV Joint Seal]		
	- Right		9117 [CV Joint Seal]		
Gearbox Oil Seal	- Front			324807	304508
	- Rear	9119 [ext. housing]	9118 [Transfer housing] 9119 [ext. housing]	385811 385811RK [Kit]	385811 385811RK [Kit]
Pinion Oil Seal		9120	9120	2738	387411 [Imported] 2738 [Local]
Spark Plug Tube Seal					
Rear Main Bearing Oil Seal		9790	9790	9648	9648
Timing Cover / Cam Oil Seal		9286 [T/Cover]	9286 [T/Cover]	426007 [T/Cover]	426007 [T/Cover]
Rear Wheel Bearing	- Inner	DRT42REVO + RR51	DRT42REVO + RR51	U399+360 + 1852119	63082RS + RR42 [Imported] U399+360 + 1852119 [Local]
	- Outer				
Rear Wheel Oil Seal	- Inner	9406	9406		507009 [Imported]
	- Outer	9403	9403	9415	9431 [Imported] 9415 [Local]
Rear Wheel Kit		PQ1082	PQ1082	PQ176	PQ191 [Imported] PQ176 [Local]
Rear Wheel Hub / Stub Axle		1082L/RHUB	1082L/RHUB		

APPLICATIONS	LOCATION	TOYOTA HIACE YH53/63 2.2 SWB/LWB P/van, Van, LS, GLX, Exec. Wagon 4Y Pet. All Imp. Models	TOYOTA HIACE YH53/63 2.2 SWB/LWB P/van, Van, LS, Super T/14/16, GLX, Exec. Wagon, Siyaya Bus, P/van 4Y Pet. All Local Models	TOYOTA HILUX LN30/40/50/51/55 2.2 SWB/LWB P/up L Dies. 2.4 SWB/LWB D/cab, Raider P/up 2L Dies., YN58 2.2 LWB D/cab, Raider, SRX P/up 4Y Pet.	TOYOTA HILUX 4X4 YN67 2.2 LWB D/cab, Raider D/cab P/up 4Y Pet.
		YEARS	86-88	88-09	79-98
Front Wheel Bearing	- Inner	48510+48	48510+48	48510+48	104910+48
	- Outer	12610+49	12610+49	12610+49	102910+49
Front Wheel Oil Seal	- Inner	506809	506809	506809	9437
	- Outer				9437A
Front Wheel Kit		PQ171	PQ171	PQ171	PQ318
Front Wheel Hub / Stub Axle		171HUB	171HUB	171HUB	318HUB
Alternator / Generator Bearing	- Front	62032RS [86-87] 63032RS [87-88]	63032RS	62032RS [Diesel] 63032RS [Petrol]	63032RS
	- Rear	62012RS	62012RS	62012RS	62012RS
Concentric / Thrust Bearing		RB9548	RB9896	RB9583 [LN30/40] RB9548 [LN50/55] RB9896 [YN58] RB9804 [LN51]	RB9548 [86-88] RB9896 [88-94]
Diff Carrier Bearing	- Left	17831+887	102910+49	17831+887 [Imported] 501310+49 [Local]	17831+887 [Fr. axle, Imported Rr.] 501310+49 [Local Rr.]
	- Right	17831+887	102910+49	17831+887 [Imported] 501310+49 [Local]	17831+887 [Fr. axle, Imported Rr.] 501310+49 [Local Rr.]
Diff Pinion Bearing	- Front	TRA0607-N	86610+49 88610+49 [Some mod.]	30306 [Imported] 86610+49 [Local]	30306 [Fr. axle, Imported Rr.] 86610+49 [Local Rr.]
	- Rear	TRA07083C-N	86610+49 802011+48 [Some mod.]	32307 [Imported] 88610+49 [Local]	32307 [Fr. axle, Imported Rr.] 88610+49 [Local Rr.]
Propshaft Support Bearing					
Pulley Bearing					
Spigot Shaft Bearing		62012RS	62012RS	62012RS	62012RS
V-Belt Tensioner					
Drive Shaft Oil Seal	- Left				9766
	- Right				9766
Gearbox Oil Seal	- Front	304508	304508	324808 [4 Spd.] 304508 [5 Spd.]	304508 385811 [Transfer case]
	- Rear	385811 385811RK [Kit]	385811 385811RK [Kit]	385811 385811RK [Kit]	385811
Pinion Oil Seal		387411	2738 9718 [Some mod.]	387411 [Imported] 2738 [Local]	387411 [Imp. Fr./Rr.] 2738 [Local Rr.]
Spark Plug Tube Seal					
Rear Main Bearing Oil Seal		9648	9648	9649 [Diesel] 9648 [Petrol]	9648
Timing Cover / Cam Oil Seal		426007 [T/Cover]	426007 [T/Cover]	426007 [T/Cover]	426007 [T/Cover]
Rear Wheel Bearing	- Inner	63082RS + RR42	U399+360 + 1852119	63082RS + RR42 [Imported] U399+360 + 1852119 [Local]	63082RS + RR42 [Imported] U399+360 + 1852119 [Local]
	- Outer				
Rear Wheel Oil Seal	- Inner	507009		507009 [Imported]	507009 [Imported]
	- Outer	9431	9415	9431 [Imported] 9415 [Local]	9431 [Imported] 9415 [Local]
Rear Wheel Kit		PQ191	PQ176	PQ191 [Imported] PQ176 [Local]	PQ191 [Imported] PQ176 [Local]
Rear Wheel Hub / Stub Axle					

APPLICATIONS	LOCATION	TOYOTA HILUX YN51/56 [87-98] 1.8 SWB/LWB D/cab, S, SR, Raider P/up 2Y Pet. YN140 1.8 SWB/LWB D/cab, Raider, S, SRX P/up 2Y Pet.	TOYOTA HILUX 4X4 LN65 2.4 LWB D/cab, Raider D/cab P/up 2L Dies.	TOYOTA HILUX 4X4 RN67 2.4 LWB D/cab, Raider D/cab P/up 22R Pet.	TOYOTA HILUX RN58 [94-98] 2.4 22R Pet. LN140/145 [98-05] 2.4i DLX, P/up 2L Dies. RZN194 [98-05] 2.7i LWB D/cab, Raider, SRX, Legend35 Raider, 3RZFE Pet.
		YEARS	86-05	89-98	94-98
Front Wheel Bearing	- Inner	48510+48	104910+48	104910+48	48510+48 [2.4] 102910+49 [2.7]
	- Outer	12610+49	102910+49	102910+49	12610+49 [2.4] 104910+48 [2.7]
Front Wheel Oil Seal	- Inner	506809	9437	9883	506809 [2.4] 9883 [2.7]
	- Outer		9437A		
Front Wheel Kit		PQ171	PQ318	PQ432	PQ171 [2.4] PQ432 [2.7]
Front Wheel Hub / Stub Axle		171HUB	318HUB	432HUB	171HUB 432HUB
Alternator / Generator Bearing	- Front	63022RS			62022RS
	- Rear	62032RS	6304 2RS		62032RS
Concentric / Thurst Bearing		RB9548 [87-88] RB9896 [88-05]	RB9804	RB9804	RB9804 [2.4] RB9896 [2.7]
Diff Carrier Bearing	- Left	17831+887 [Imported] 501310+49 [Local]	17831+887 [Fr. Diff] 102910+49 [Rr. Diff]	32915	17831+887
	- Right	17831+887 [Imported] 501310+49 [Local]	17831+887 [Fr. Diff] 102910+49 [Rr. Diff]	32915	17831+887
Diff Pinion Bearing	- Front	30306 [Imported] 86610+49 [Local]	30306 [Fr. axle] 32307 [Imported Rr.] 86610+49 [Local Rr.]	30306 [Fr. & Rr. axle]	86610+49
	- Rear	32307 [Imported] 88610+49 [Local]	32307 [Fr. axle, Imported Rr.] 88610+49 [Local Rr.]	TR0708-1YR-N [Fr. axle] TR070904-1 [Rr. axle]	88610+49
Propshaft Support Bearing					
Pulley Bearing					
Spigot Shaft Bearing		62012RS	62012RS	62012RS	62012RS
V-Belt Tensioner					
Drive Shaft Oil Seal	- Left		9766		
	- Right				
Gearbox Oil Seal	- Front	324808 [4 Spd.] 304508 [5 Spd.]	304508 385811 [Transfer case]	304508	304508
	- Rear	385811 385811RK [Kit]	385811	385811	385811 385811RK [Kit]
Pinion Oil Seal		387411 [Imported] 2738 [Local]	9800 [Imp. Fr. & Rr.] 2738 [Local Rr.]	9800 [Fr. axle] 9800 / 2738 [Rr. axle]	2738
Spark Plug Tube Seal					9552 [2.7]
Rear Main Bearing Oil Seal		9648	9649	9648	9648 [Petrol 2.4] 9649 [Diesel 2.4] 9223 [2.7]
Timing Cover / Cam Oil Seal		426007 [T/Cover]	426007 [T/Cover]	456812 [T/Cover]	9643 [Cam Diesel] 456812 [T/Cover Pet.] 426007 [T/Cover Dies.] 486807 [T/Cover 2.7]
Rear Wheel Bearing	- Inner	63082RS + RR42 [Imported] U399+360 + 1852119 [Local]	63082RS + RR42 [Imported] U399+360 + 1852119 [Local]	63082RS + RR42 [Imported] U399+360 + 1852119 [Local]	U399+360 + 1852119
	- Outer				
Rear Wheel Oil Seal	- Inner	507009 [Imported]	507009 [Imported]	507009 [Imported]	
	- Outer	9431 [Imported] 9415 [Local]	9431 [Imported] 9415 [Local]	9431 [Imported] 9415 [Local]	9415
Rear Wheel Kit		PQ191 [Imported] PQ176 [Local]	PQ191 [Imported] PQ176 [Local]	PQ191 [Imported] PQ176 [Local]	PQ176
Rear Wheel Hub / Stub Axle					



APPLICATIONS	LOCATION	TOYOTA HILUX 4X2 LN57 2.8D LWB D/cab, Raider P/up 3L Dies.	TOYOTA HILUX 4X4 LN67 2.8D LWB, D/cab, Raider D/cab P/up 3L Dies.	TOYOTA HILUX RZN147 2.0 SWB/LWB D/cab, DLX, Raider, S, SR, SRX P/up 1RZ Pet.	TOYOTA HILUX LN192R 3.0D LWB Raider D-E, Raider DLX D/cab D-E, Legend35 Raider, P/up 5L Dies. 3.0iD LWB Raider, Raider D/cab, P/up KZ-TE Dies.
		YEARS	95-98	95-98	98-05
Front Wheel Bearing	- Inner	48510+48	104910+48	48510+48	102910+49
	- Outer	12610+49	102910+49	12610+49	104910+48
Front Wheel Oil Seal	- Inner	506809	9437	506809	9883
	- Outer				
Front Wheel Kit		PQ171	PQ318	PQ171	PQ432
Front Wheel Hub / Stub Axle		171HUB	318HUB	171HUB	432HUB
Alternator / Generator Bearing	- Front		6304 2RS	62022RS	62022RS
	- Rear	6304 2RS		62032RS	62032RS
Concentric / Thurst Bearing		RB9628	RB9628	RB9896	RB9628
Diff Carrier Bearing	- Left	102910+49	17831+887 [Fr. axle] 102910+49 [Rr. axle]	17831+887	17831+887
	- Right	102910+49	17831+887 [Fr. axle] 102910+49 [Rr. axle]	17831+887	17831+887
Diff Pinion Bearing	- Front	86610+49	32307 [Fr. axle] 86610+49 [Rr. axle]	86610+49	86610+49
	- Rear	88610+49	30306 [Fr. axle] 88610+49 [Rr. axle]	88610+49	88610+49
Propshaft Support Bearing					
Pulley Bearing					
Spigot Shaft Bearing		62012RS	62012RS	62012RS	62012RS
V-Belt Tensioner					
Drive Shaft Oil Seal	- Left				
	- Right				
Gearbox Oil Seal	- Front	304508	304508	304508	304508
	- Rear	385811 385811RK [Kit]	385811	385811 385811RK [Kit]	385811 385811RK [Kit] 9540 [KZTE] [ID: 40mm]
Pinion Oil Seal		2738	9800 [Fr. axle] 2738 [Rr. axle]	2738	2738
Spark Plug Tube Seal					
Rear Main Bearing Oil Seal		9649	9649	9223	9649
Timing Cover / Cam Oil Seal		426007 [T/Cover]	426007 [Cam] 486807 [T/Cover]	486807 [T/Cover]	426007 [T/Cover]
Rear Wheel Bearing	- Inner	U399+360 + 1852119	U399+360 + 1852119	U399+360 + 1852119	U399+360 + 1852119
	- Outer				
Rear Wheel Oil Seal	- Inner				
	- Outer	9403	9415	9415	9415
Rear Wheel Kit		PQ176	PQ176	PQ176	PQ176
Rear Wheel Hub / Stub Axle					



APPLICATIONS	LOCATION	TOYOTA HILUX 4X4	TOYOTA HILUX 4X4 LN167	TOYOTA HILUX "VIGO" 4X2	TOYOTA HILUX "VIGO" 4X2
		RZN169 2.7i LWB D/cab, DLX S/cab, Raider S/D/cab, SRX D/cab, Legend 35 LWB P/up 3RZFE Pet.	3.0D D/cab D-E, DLX, S/D/cab DE, Raider DE, Legend35 LWB P/up 5L Dies. 3.0iD LWB Raider S/cab & KZ-TE D/cab P/up, Legend35	2.0i U16/17 S/Cab, S, SRX LWB Pet. P/up 1TR-FE Pet.	2.5TDi D-4D S/Cab, S, SRX, S/Cab, S/Cab SRX HO, Raised Body Raider, D/Cab LWB 2KD-FTV
YEARS		98-05	98-05	05-09	05-09
Front Wheel Bearing	- Inner	104910+48	104910+48	43KWD07	43KWD07 [Std.] HUB131 [Raised Body] [Non ABS] HUB171 [with integrated ABS sensor]
	- Outer	102910+49	102910+49		
Front Wheel Oil Seal	- Inner	9883 9113	9883 9113		9287 9577 [Raised Body]
	- Outer			9300	9300 [Std.]
Front Wheel Kit		PQ431	PQ431	PQ760	PQ760 [Std.] PQ761 [Raised Body] PQ663 [ASB]
Front Wheel Hub / Stub Axle		432HUB	432HUB	760HUB	761AHUB 663HUB
Alternator / Generator Bearing	- Front	62022RS	62022RS		
	- Rear	62032RS	62032RS		
Concentric / Thurst Bearing		RB9896	RB9628	RB9896	RB9645
Diff Carrier Bearing	- Left	17831+887 [Rr. axle with no Diff lock] 32915 [Rr. axle with Diff lock]	17831+887 [Rr. axle with no Diff lock] 32915 [Rr. axle with Diff lock]	TR100802	TR100802
	- Right	17831+887 [Rr. no Diff lock] 32915 [Rr. axle with Diff lock]	17831+887 [Rr. axle with no Diff lock] 32915 [Rr. axle with Diff lock]	TR100802	TR100802
Diff Pinion Bearing	- Front	30306 [Fr. & Rr. axle] [With or W/o Diff lock]	30306 [Fr. & Rr. axle] [With or W/o Diff lock]	STA3072	STA3072
	- Rear	TR0708-1YR-N [Fr. axle] 32307 [Rr. axle with no Diff lock] TR070904-1 [Rr. axle with Diff lock]	TR0708-1YR-N [Fr. axle] 32307 [Rr. axle with no Diff lock] TR070904-1 [Rr. axle with Diff lock]	TR070904-1	TR070904-1
Spigot Shaft Bearing		62012RS	62012RS		
V-Belt Tensioner		VBT006		VBT007	VBT009
Drive Shaft Oil Seal	- Left		9540 [Gearbox]		
	- Right		9540 [Gearbox]		
Gearbox Oil Seal	- Front	304508	304508	9503	9503
	- Rear	385811	385811	385811 385811RK [Kit]	9540 [Ext. Housing]
Pinion Oil Seal		9800 [Fr. & Rr. axle] [With or W/o Diff lock] 2738 [Rr. axle w/o Diff lock]	9800 [Fr. & Rr. axle] [With or W/o Diff lock] 2738 [Rr. axle w/o Diff lock]	9359 [ID: 41mm] 9568 [ID: 48mm]	9359 [ID: 41mm] 9568 [ID: 48mm]
Rear Main Bearing Oil Seal		9223	9649	9223	9790
Timing Cover / Cam Oil Seal		426007 [T/Cover]	426007 [T/Cover]	486807 [T/Cover] 657907 [Aux. Pulley]	9643 [Cam seal] 9286 [Diesel T/Cover] 657907 [Aux. Pulley]
Rear Wheel Bearing	- Inner	40BCV09 + RR42 [Imported] U399+360 + 1852119 [Local]	40BCV09 + RR42 [Imported] U399+360 + 1852119 [Local]	40BCV09 + RR42 [Local] DG409026P + RR42 [Imported]	40BCV09 + RR42 [Local] DG409026P + RR42 [Imported]
	- Outer				
Rear Wheel Oil Seal	- Inner	507009 [Imported]	507009 [Imported]	507009	507009
	- Outer	9416 [Imported] 9415 [Local]	9416 [Imported] 9415 [Local]	9416	9416
Rear Wheel Kit		PQ649 [Imported] PQ649ABS PQ176 [Local]	PQ649 [Imported] PQ649ABS PQ176 [Local]	PQ649 [Local] PQ649ABS PQ865 [Imported]	PQ649 [Local] PQ649ABS PQ865 [Imported]
Rear Wheel Hub / Stub Axle		649HUB	649HUB		649HUB

APPLICATIONS	LOCATION	TOYOTA HILUX "VIGO" 4X2	TOYOTA HILUX "VIGO" 4X4	TOYOTA HILUX "VIGO" 4X2	TOYOTA HILUX "VIGO" 4X4
		3.0 D-4D TDi Raider, D/C Raider, Raised Body LWB P/up 1KD-FTV Dies. 4.0i D/Cab Raider Raised Body LWB P/ up GR-FE Pet.	3.0 D-4D TDi D/C Raider 1KD-FTV Dies., LWB P/up, 4.0 D/Cab Raider 1GR-FE Pet. LWB P/up	2.7i S/Cab Raider, D/ Cab Raider, S/Cab HO Raised Body LWB P/up 2TR-FE Pet.	2.5TDi D-4D S/Cab, D/Cab SRX, Legend40 2KD-FTV Dies. LWB P/up
YEARS		05-09	05-09	05-11	05-15
Front Wheel Bearing	- Inner	HUB131 HUB171 [with integrated ABS sensor]	HUB131 HUB171 [with integrated ABS sensor]	43KWD07 [Std.] HUB131 [Raised Body] [Non ABS] HUB171 [with integrated ABS sensor]	HUB131 HUB171 [with integrated ABS sensor]
	- Outer				
Front Wheel Oil Seal	- Inner	9287 9577	9287 9577	9287 9577 [Raised Body]	9287 9577
	- Outer			9300 [Std.]	
Front Wheel Kit		PQ761 PQ663 [ASB]	PQ761 PQ663 [ASB]	PQ760 [Std.] PQ761 [Raised Body] PQ663 [ASB]	PQ761 PQ663 [ASB]
Front Wheel Hub / Stub Axle		761AHUB 663HUB	761HUB + RR62 663HUB	761AHUB 663HUB	761HUB + RR62 663HUB
Alternator / Generator Bearing	- Front				
	- Rear				
Concentric / Thurst Bearing		RB9671	RB9671	RB9804	RB9645
Diff Carrier Bearing	- Left	TR100802	32915 [Fr. Diff] TR100802 [Rr. Diff]	TR100802	32915 [Fr. Diff] TR100802 [Rr. Diff]
	- Right	TR100802	32915 [Fr. Diff] TR100802 [Rr. Diff]	TR100802	32915 [Fr. Diff] TR100802 [Rr. Diff]
Diff Pinion Bearing	- Front	STA3072	STA3072 [Fr. & Rr. axle]	STA3072	STA3072 [Fr. & Rr. axle]
	- Rear	TR070904-1	TR070904-1 [Fr. & Rr. axle] STA5383 [Alt.]	TR070904-1	TR070904-1 [Fr. & Rr. Axle] STA5383 [Alt.]
Propshaft Support Bearing					
Spigot Shaft Bearing					
V-Belt Tensioner		VBT010 [4.0]	VBT010 [4.0]	VBT006	VBT009
Drive Shaft Oil Seal	- Left		9108 9117 [CV Joint Seal]		9108 9117 [CV Joint Seal]
	- Right		9109 9117 [CV Joint Seal]		9109 9117 [CV Joint Seal]
Gearbox Oil Seal	- Front	9503	9503	9503	9503
	- Rear	9540	9504 [Transfer case] 9505 [Ext. Housing]	9540	9504 [Transfer case] 9505 [Ext. Housing]
Pinion Oil Seal		9359 [ID: 41mm] 9568 [ID: 48mm]	9359 [Fr. & Rr.]	9359 [ID: 41mm] 9568 [ID: 48mm]	9359 [Fr. & Rr.]
Rear Main Bearing Oil Seal		9790	9790 [3.0] 9358 [4.0]	9223	9223 [ID: 88mm] 9790 [ID: 95mm]
Timing Cover / Cam Oil Seal		9286 [Diesel T/Cover] 657907 [Aux. Pulley]	9286 [T/Cover] 657907 [Aux. Pulley]	9643 486807 [Petrol Fr. Crankshaft] 657907	9643 [Cam seal 2.5 only] 9286 [T/Cover] 657907 [Aux. Pulley]
Rear Wheel Bearing	- Inner	40BCV09 + RR42 [Local] DG409026P + RR42 [Imported]	40BCV09 + RR42 [Local] DG409026P + RR42 [Imported]	40BCV09 + RR42 [Local] DG409026P + RR42 [Imported]	40BCV09 + RR42 [Local 06-09] DG409026P + RR42 [Imported 06-09] TOY42KWD + RR51 [09-]
	- Outer				
Rear Wheel Oil Seal	- Inner	507009	507009	507009	507009 [06-09] 9406 [09-]
	- Outer	9416	9416	9416	9416 [06-09] 9403 [09-]
Rear Wheel Kit		PQ649 [Local] PQ649ABS PQ865 [Imported]	PQ649 [Local] PQ649ABS PQ865 [Imported]	PQ649 [Local] PQ649ABS PQ865 [Imported]	PQ649 [Local 06-09] PQ649ABS PQ865 [Imp. 06-09] PQ896 [09-]
Rear Wheel Hub / Stub Axle		649HUB	649HUB	649HUB	649HUB

APPLICATIONS	LOCATION	TOYOTA HILUX "VIGO" 4X4 2.7i S/Cab SRX, Legend40 2TR-FE Pet. LWB P/up	TOYOTA HILUX "VIGO" 4X4 3.0D-4D TDi D/C xtra cab, Raider, Legend40 1KD-FTV Dies. LWB 4.0 D/Cab Raider, 1GR-FE Pet.	TOYOTA HILUX "VIGO" 2.0i S/Cab, S, SRX LWB Pet. P/up 1TR-FE Pet.	TOYOTA HILUX "VIGO" 2.5TDi D-4D S/Cab, S, SRX, S/Cab, S/Cab SRX HO, Raised Body Raider, D/Cab LWB P/up 2KD-FTV 2.7i Raised Body Raider, D/Cab LWB P/up 2TR-FE Pet.
YEARS		05-15	2009-	09-11	09-11
Front Wheel Bearing	- Inner	HUB131 HUB171 [with integrated ABS sensor]	HUB131 HUB171 [with integrated ABS sensor]	43KWD07	43KWD07 [Std.] HUB131 [Raised Body][Non ABS] HUB171 [with integrated ABS sensor]
	- Outer				
Front Wheel Oil Seal	- Inner	9287 9577	9287 9577		9287 9577 [Raised Body]
	- Outer			9300	9300 [Std.]
Front Wheel Kit		PQ761 PQ663 [ASB]	PQ761 PQ663 [ASB]	PQ760	PQ760 [Std.] PQ761 [Raised Body] PQ663 [ASB]
Front Wheel Hub / Stub Axle		761HUB + RR62 663HUB	761HUB + RR62 663HUB	760HUB	761AHUB 663HUB
Alternator / Generator Bearing	- Front				
	- Rear				
Concentric / Thurst Bearing		RB9804	RB9671	RB9896	RB9645 [2.5] RB9804 [2.7]
Diff Carrier Bearing	- Left	32915 [Fr. Diff] TR100802 [Rr. Diff]	32915 [Fr. Diff] TR100802 [Rr. Diff]	TR100802	TR100802
	- Right	32915 [Fr. Diff] TR100802 [Rr. Diff]	32915 [Fr. Diff] TR100802 [Rr. Diff]	TR100802	TR100802
Diff Pinion Bearing	- Front	STA3072 [Fr. & Rr. axle]	STA3072 [Fr. & Rr. axle]	STA3072	STA3072
	- Rear	TR070904-1 [Fr. & Rr. axle] STA5383 [Alt.]	TR070904-1 [Fr. & Rr. axle] STA5383 [Alt.]	TR070904-1	TR070904-1
Propshaft Support Bearing					
V-Belt Tensioner		VBT007		VBT007	VBT009 [2.5] VBT006 [2.7]
Drive Shaft Oil Seal	- Left	9108 9117 [CV Joint Seal]	9108 9117 [CV Joint Seal]		
	- Right	9109 9117 [CV Joint Seal]	9109 9117 [CV Joint Seal]		
Gearbox Oil Seal	- Front	9503	9503	304508	9503
	- Rear	9504 [Transfer case] 9505 [Ext. Housing]	9504 [Transfer case] 9505 [Ext. Housing]	385811 385811RK [Kit]	9540
Pinion Oil Seal		9359 [Fr. & Rr.]	9359 [Fr. & Rr.]	9359 [ID: 41mm] 9568 [ID: 48mm]	9359 [ID: 41mm] 9568 [ID: 48mm]
Rear Main Bearing Oil Seal		9223 [ID: 88mm] 9790 [ID: 95mm]	9790	9223	9790 [2.5] 9223 [2.7]
Timing Cover / Cam Oil Seal		9286 [T/Cover] 657907 [Aux. Pulley]	9286 [T/Cover] 657907 [Aux. Pulley]	486807 [T/Cover] 657907 [Aux. Pulley]	9643 [Cam seal] 9286 [Diesel T/Cover] 657907 [Aux. Pulley] 486807 [Petrol Fr. Crankshaft]
Rear Wheel Bearing	- Inner	40BCV09 + RR42 [Local 06-09] DG409026P + RR42 [Imported 06-09] TOY42KWD + RR51 [09-]	TOY42KWD + RR51	TOY42KWD + RR51	TOY42KWD + RR51
	- Outer				
Rear Wheel Oil Seal	- Inner	507009 [06-09] 9406 [09-]	9406	9406	9406
	- Outer	9416 [06-09] 9403 [09-]	9403	9403	9403
Rear Wheel Kit		PQ649 [Local 06-09] PQ649ABS PQ865 [Imp. 06-09] PQ896 [09-]	PQ896	PQ896	PQ896
Rear Wheel Hub / Stub Axle		649HUB		896HUB	

APPLICATIONS	LOCATION	TOYOTA HILUX "VIGO"	TOYOTA HILUX 4X2	TOYOTA HILUX 4X4	TOYOTA HILUX 4X2
		3.0D-4D TDi D/C Raised Body Raider, Xtra cab, Legend40 LWB P/up KD-FTV Dies. 4.0i D/C Raised Body Raider, Legend40 LWB P/up 1GR-FE Pet.	2.0 VVTi 1TR-FE 5 Spd Man. S/cab 2.5D-4D Raised Body, Std. Body 2KD-FTV 5 Spd Man.	2.5D-4D Raised Body 2KD-FTV 5 Spd man.	2.7 VVTi 2TR-FE 3.0D-4D 1KD-FTV 4.0 1GR-FE
YEARS		09-16	11-16	11-16	11-16
Front Wheel Bearing	- Inner	HUB131 HUB171 [with integrated ABS sensor]	43KWD07	HUB131	HUB131
	- Outer				
Front Wheel Oil Seal	- Inner	9287 9577	9287	9287 9577	9287 9577
	- Outer		9300		
Front Wheel Kit		PQ761 PQ663 [ASB]	PQ760	PQ761	PQ761
Front Wheel Hub / Stub Axle		761AHUB 663HUB	761AHUB [Std. Body] 760AHUB	761HUB + RR62	761AHUB
Alternator / Generator Bearing	- Front				
	- Rear				
Concentric / Thurst Bearing		RB9671	RB9896 [2.0] RB9671 [2.5] RB9645 [2.5 Alt.]	RB9671 RB9645 Alt.	RB9671
Diff Carrier Bearing	- Left	TR100802	32915 [Rear]	32915 [Rear]	32915 [Rr. Diff 3.0, 4.0]
	- Right	TR100802	TR100802 [Rear]	TR100802 [Rear]	TR100802 [Rr. Diff 3.0, 4.0]
Diff Pinion Bearing	- Front	STA3072	STA3072 [Rear]	TR070904-1 [Front Axle] STA3072 [Rear]	STA3072 [Rr. Diff 3.0, 4.0]
	- Rear	TR070904-1	TR070904-1 [Rear]	TR070904-1 [Rear] STA3072 [Front]	TR070904-1 [Rr. Diff 3.0, 4.0]
Propshaft Support Bearing					
Pulley Bearing					
Spigot Shaft Bearing					
V-Belt Tensioner			VBT009 [2.5]	VBT009	
Drive Shaft Oil Seal	- Left			9117 [CV Joint Seal]	
	- Right			9117 [CV Joint Seal]	
Gearbox Oil Seal	- Front	9503	9503 [2.5] 304508 [2.0, 2.5 Alt.]	9503 304508 Alt.	9503
	- Rear	9540	9540 [Ext. Housing 2.5]	9504 [Transfer case] 9505 [Ext. Housing]	9540 [Ext. Housin 2.7, 3.0] 9119 [Ext. Housing 4.0]
Pinion Oil Seal		9359 [ID: 41mm] 9568 [ID: 48mm]	9359 [ID: 41mm 2.5 Rr.] 9568 [ID: 48mm Fr.]	9568 [ID: 48mm] [Front] 9359 [ID: 41mm] [Rear]	9359 [ID: 41mm Fr. & Rr.]
Spark Plug Tube Seal					
Rear Main Bearing Oil Seal		9790 [3.0] 9358 [4.0]	9223 [2.0] 9790 [2.5]	9790	9223 [2.7] 9790 [3.0, 4.0]
Timing Cover / Cam Oil Seal		9286 [T/Cover] 657907 [Aux. Pulley]	486807 [T/Cover 2.0] 9286 [T/Cover 2.5] 657907 [Aux. Pulley]	9286 [T/Cover]	486807 [T/Cover 2.7] 9286 [T/Cover 3.0] 657907 [Aux. Pulley 3.0]
Rear Wheel Bearing	- Inner	TOY42KWD + RR51	TOY42KWD + RR51	TOY42KWD + RR51	TOY42KWD + RR51
	- Outer				
Rear Wheel Oil Seal	- Inner	9406	9406	9406	9406
	- Outer	9403	9403	9403	9403
Rear Wheel Kit		PQ896	PQ896	PQ896	PQ896
Rear Wheel Hub / Stub Axle			896HUB	896HUB	896HUB

APPLICATIONS	LOCATION	TOYOTA HILUX 4X4 3.0D-4D 1KD-FTV 4.0 1GR-FE	TOYOTA HILUX “REVO” 4X2 2.0 VVTi 1TR-FE 2.4 GD-6 Raised Body 2GD-FTV 2.7 VVTi Raised Body 2TR-FE	TOYOTA HILUX “REVO” 4X4 2.4 GD-6 2GD-FTV	TOYOTA HILUX “REVO” 4X2 2.8 GD-6 Raised Body 1GD-FTV 4.0 V6 Raised Body 1GR-FE
		YEARS	11-16	2016-	2016-
Front Wheel Bearing	- Inner	HUB131	43KWD07 [2.0, 2.4 Std. Body] HUB171 [2.4, 2.7 Raised Body]	HUB171	HUB171
	- Outer				
Front Wheel Oil Seal	- Inner	9287 9577		9577	9577
	- Outer		9300 [2.0, 2.4 Std. Body] 9287 [2.4, 2.7 Raised Body]	9287	9287
Front Wheel Kit		PQ761	PQ760 PQ663	PQ663	PQ663
Front Wheel Hub / Stub Axle		761HUB + RR62	760HUB [2.0, 2.4 Std. Body] 663AHUB [2.4, 2.7 Raised Body]	663HUB	663AHUB
Alternator / Generator Bearing	- Front				
	- Rear				
Concentric / Thurst Bearing		RB9671	RB9663 [2.0, 2.4]	RB9663	RB9663
Diff Carrier Bearing	- Left	STA5383 [Fr. Diff] 32915 [Rr. Diff]	5383+5083 [Rr. Diff]	STA5383 [Fr. Diff] 5383+5083 [Rr. Diff]	5383+5083 [Rr. Diff]
	- Right	FH438017 [Fr. Diff] TR100802 [Rr. Diff]	4076+5076 [Rr. Diff]	STA5383 [Fr. Diff] 4076+5076 [Rr. Diff]	4076+5076 [Rr. Diff]
Diff Pinion Bearing	- Front	TR070904-1 [Fr. Diff] STA3072 [Rr. Diff]	3680+3580 [Rr. Diff]	TR070904-1 [Fr. Diff] 3680+3580 [Rr. Diff]	3680+3580 [Rr. Diff]
	- Rear	TR070904-1 [Rr. Diff] STA3072 [Fr. Diff]	TR091004 [Rr. Diff]	STA3072 [Fr. Diff] TR091004 [Rr. Diff]	TR091004 [Rr. Diff]
Propshaft Support Bearing					
Pulley Bearing					
Spigot Shaft Bearing					
V-Belt Tensioner					
Drive Shaft Oil Seal	- Left	9117 [CV Joint Seal]	9135	9117 [CV Joint Seal] 9135	9135
	- Right	9117 [CV Joint Seal]	9136	9117 [CV Joint Seal] 9136	9136
Gearbox Oil Seal	- Front	9503	9503 [2.0, 2.4, 2.7] 9133 [2.4 Raised Body]	9133	9133 [2.8]
	- Rear	9505 [Ext. Housing]	9540 [Ext. Housing]	9116 [Ext. Housing]	9540 [Ext. Housing 2.8 Man.] 9119 [Ext. Housing Auto.]
Pinion Oil Seal		9359 [ID: 41mm] [Fr. & Rr]	9120 [Rr. Diff] 9134 [Fr. Diff 2.4]	9120 [Rr. Diff] 9134 [Fr. Diff]	9120 [Rr. Diff] 9134 [Fr. Diff 4.0]
Spark Plug Tube Seal					
Rear Main Bearing Oil Seal		9790	9223 [2.0] 9790	9790	9790 [2.8] 9358 [4.0]
Timing Cover / Cam Oil Seal		9286 [T/Cover] [3.0] 657907 [Aux. Pulley] [3.0]	9138 [T/Cover 2.7] 9286 [T/Cover 2.0, 2.4]	9286 [T/Cover]	9118 [T/Cover]
Rear Wheel Bearing	- Inner	TOY42KWD + RR51	DRT42REVO + RR51	DRT42REVO + RR51	DRT42REVO + RR51
	- Outer				
Rear Wheel Oil Seal	- Inner	9406	9406	9406	9406
	- Outer	9403	9403	9403	9403
Rear Wheel Kit		PQ896	PQ1082	PQ1082	PQ1082
Rear Wheel Hub / Stub Axle		896HUB	1082AHUB	1082AHUB	1082AHUB

APPLICATIONS	LOCATION	TOYOTA HILUX "REVO" 4X4 2.8 GD-6 Raised Body 1GD-FTV 4.0 V6 Raised Body 1GR-FE	TOYOTA LAND CRUISER 4X4 FJ80 4.0 DLX, GX, VX P/up 3F/F-E Pet.	TOYOTA LAND CRUISER 4X4 FZJ/HZJ75 4.2 GX S/W, P/up 1FZF/HZ Dies.	TOYOTA LAND CRUISER 4X4 FZJ80 4.5 Std., GX, VX, Turbo S/W, P/up 1FZ-FE Dies., Turbo Dies.
YEARS		2016-	90-92	91-97	92-95
Front Wheel Bearing	- Inner	HUB171	104910+48	104910+48	104910+48
	- Outer		102910+49	102910+49	102910+49
Front Wheel Oil Seal	- Inner	9577	9437 9437A [Alternative]	9437 9437A [Alternative]	9437 9437A [Alternative]
	- Outer	9287			
Front Wheel Kit		PQ663	PQ318	PQ318	PQ318
Front Wheel Hub / Stub Axle		663HUB	318CHUB		318CHUB
Alternator / Generator Bearing	- Front		62012RS [80 Amp] 62032RS [65 Amp] PQ10192 [90 Amp]	6304 2RS	62032RS [65 Amp] PQ10192 [90 Amp] PQ10192 [55 Amp]
	- Rear		62012RS	62022RS	62022RS
Concentric / Thurst Bearing		RB9663	RB9636	RB9637	RB9638 [92-96] RB9639 [96-04]
Diff Carrier Bearing	- Left	STA5383 [Fr. Diff] 5383+5083 [Rr. Diff]	TR100802 [Fr. & Rr. Axle No Diff Lock] 32915 [Fr. & Rr. Axle with Diff Lock]	17831+887 [Fr./Rr. axle]	TR100802 [Fr. & Rr. Axle No Diff Lock] 32915 [Fr. & Rr. Axle with Diff Lock]
	- Right	STA5383 [Fr. Diff] 4076+5076 [Rr. Diff]	TR100802 [Fr. & Rr. Axle No Diff Lock] 32915 [Fr. & Rr. Axle with Diff Lock]	17831+887 [Fr./Rr. axle]	TR100802 [Fr. & Rr. Axle No Diff Lock] 32915 [Fr. & Rr. Axle with Diff Lock]
Diff Pinion Bearing	- Front	TR070904-1 [Fr. Diff] 3680+3580 [Rr. Diff]	TR070904-1 [Fr. axle] 30306 [Rr. axle]	TR070904-1 [Fr./Rr. axle]	TR070904-1 [Fr. axle] 30306 [Rr. axle]
	- Rear	STA3072 [Fr. Diff] TR091004 [Rr. Diff]	TR0607J-1 [Fr. axle] 32010 [Rr. axle]	TR070904-1 [Fr./Rr. axle]	TR0607J-1 [Fr. axle] 32010 [Rr. axle]
Spigot Shaft Bearing			62022RS	62022RS	62022RS
V-Belt Tensioner					
Drive Shaft Oil Seal	- Left	9117 [CV Joint Seal] 9135			
	- Right	9117 [CV Joint Seal] 9136			
Gearbox Oil Seal	- Front	9133 [2.8]	426007	324807 [1HZ] 354807 [1FZF]	354807 [Man.] 426007 [Auto.] 486208 [T/case Both]
	- Rear	9116 [Ext. Housing]	9921 [Ext. Housing]	9919 [Fr. Ext. Housing] 486208 [Rr. Ext. ousing]	9919 [Ext. Housing 1] 486208 [Ext. Housing 2]
Pinion Oil Seal		9120 [Rr. Diff] 9134 [4.0 Fr. Diff]	9800 [Fr. & Rr. axle]	9800 [Fr./Rr. axle]	9800 [Fr./Rr. axle]
Spark Plug Tube Seal				9552 [93-99]	
Rear Main Bearing Oil Seal		9790 [2.8] 9358 [4.0]	9903	9790 [1HZ] 9897 [1FZF]	9897
Timing Cover / Cam Oil Seal		9286 [T/Cover]	9902 [T/Cover]	9898 [Cam x 2] 9899 [T/Cover 1FZF] 9900 [T/Cover 1HZ]	9989 [T/Cover]
Rear Wheel Bearing	- Inner	DRT42REVO + RR51	104910+48 [Full or Semi Fl. Axle]	RNU0727	104910+48 [Full or Semi Fl. Axle]
	- Outer		102910+49 [Full Floating Axle] 104910+48 [Semi Floating Axle]		102910+49 [Full Floating Axle] 104910+48 [Semi Floating Axle]
Rear Wheel Oil Seal	- Inner	9406	9437 [Full Floating Axle only, with Rr. Drums] 62858/17 [FullFloating Axle only, with Rr. Discs]		9437 [Full Floating Axle only, with Rr. Drums] 62858/17 [Full Floating Axle only, with Rr. Discs]
	- Outer	9403	9673 [Full Floating Axle] 9641 [Semi Fl. Axle]	9641	9673 [Full Floating Axle] 9641 [Semi Floating Axle]
Rear Wheel Kit		PQ1082	PQ666 [Full float Drums] PQ667 [Full float. Discs] PQ669 [Semi float.]	PQ327	PQ666 [Full float Drums] PQ667 [Full float. Discs] PQ669 [Semi float.]
Rear Wheel Hub / Stub Axle		1082AHUB			



APPLICATIONS	LOCATION	TOYOTA LAND CRUISER 4X4 FZJ80 4.5 Std., GX, VX, Turbo S/W, P/up 1FZ-FE Dies., Turbo Dies.	TOYOTA LAND CRUISER 4X4 FZJ105 4.5 Std., GX, Turbo P/up, S/W 1FZ-FE Dies., Turbo Dies.	TOYOTA LAND CRUISER 4X4 FZJ105 4.5 V8 VX, Turbo P/up, S/W 2UZ-FE Pet.	TOYOTA LAND CRUISER 4X4 HDJ/HZJ80 4.2 GX, Turbo S/W, P/up1HD-FT, 1HZ Dies., T. Dies.
YEARS		95-06	95-98	98-06	90-95
Front Wheel Bearing	- Inner	104910+48	104910+48	104910+48	104910+48
	- Outer	102910+49	102910+49	102910+49	102910+49
Front Wheel Oil Seal	- Inner	9437 9437A [Alternative]	9437 9437A [Alternative]	9991	9437 9437A [Alternative]
	- Outer				
Front Wheel Kit		PQ318	PQ318	PQ675	PQ318
Front Wheel Hub / Stub Axle		318CHUB			
Alternator / Generator Bearing	- Front	62032RS [65 Amp] PQ10192 [90 Amp] PQ10192. [55 Amp]	462 2RS [70 Amp] PQ10192 [80, 100, 120 Amp]	462 2RS [70 Amp] PQ10192 [80, 100, 120 Amp]	62032RS [65 Amp] 6501 2RS [80 Amp] PQ10192 [90 Amp]
	- Rear	62022RS	62022RS	63982RS	62022RS
Concentric / Thurst Bearing		RB9638 [95-96] RB9639 [96-04]	RB9638 [95-96] RB9639 [96-98]	RB9639	RB9637 [HDJ80] RB9640 [HZJ80]
Diff Carrier Bearing	- Left	TR100802 [Fr. & Rr. Axle No Diff Lock] 32915 [Fr. & Rr. Axle with Diff Lock]	17831+887 [Fr. & Rr. Axle No Diff Lock] 28985+21SA [Fr. & Rr. Axle with Diff Lock]	32010 [Fr. & Rr. axle No Diff Lock] 28985+21SA [Fr. & Rr. Axle with Diff Lock]	TR100802 [Fr. & Rr. Axle No Diff Lock] 32915 [Fr. & Rr. Axle with Diff Lock]
	- Right	TR100802 [Fr. & Rr. Axle No Diff Lock] 32915 [Fr. & Rr. Axle with Diff Lock]	17831+887 [Fr. & Rr. Axle No Diff Lock] 28985+21SA [Fr. & Rr. Axle with Diff Lock]	32010 [Fr. & Rr. axle No Diff Lock] 28985+21SA [Fr. & Rr. Axle with Diff Lock]	TR100802 [Fr. & Rr. Axle No Diff Lock] 32915 [Fr. & Rr. Axle with Diff Lock]
Diff Pinion Bearing	- Front	TR070904-1 [Fr. axle] 30306 [Rr. axle]	TR070904-1 [Fr. axle] STA3072 [Rr. axle]	STA3072 [Fr. & Rr. axle]	TR0607J-1 [Fr. axle] 32010 [Rr. axle]
	- Rear	STA3072 [Fr. axle] STF4090 [Rr. axle]	TR0607J-1 [Fr. axle] STF4090 [Rr. axle]	TR0607J-1 [Fr. axle] STF4090 [Rr. axle]	
Propshaft Support Bearing					
Pulley Bearing					
Spigot Shaft Bearing		62022RS	62022RS	62022RS	62022RS
V-Belt Tensioner					
Drive Shaft Oil Seal	- Left				
	- Right				
Gearbox Oil Seal	- Front	354807 [Man.] 426007 [Auto.] 486208 [T/case Both]	325307 [Man.] 426007 [Auto.] 486208 [T/case Both]	9503 [Man.] 426007 [Auto.] 486208 [T/case Both]	354807 [Man.] 426007 [Auto.] 486208 [T/case Both]
	- Rear	9919 [Ext. Housing 1] 486208 [Ext. Housing 2]	9919 [Ext. Housing Fr.] 9649 [Ext. Housing Rr.]	9919 [Ext. Housing Fr.] 9649 [Ext. Housing Rr.]	9919 [Ext. Housing 1] 486208 [Ext. Housing 2]
Pinion Oil Seal		9804 [Fr. & Rr. axle]	9804 [Fr. & Rr. axle]	9804 [Fr. & Rr. axle]	9800 [Fr./Rr. axle]
Spark Plug Tube Seal					
Rear Main Bearing Oil Seal		9897	9897	9790	9790
Timing Cover / Cam Oil Seal		9989 [T/Cover]	9989 [T/Cover]	9900 [T/Cover] 9898 [T/Cover]	9900 [T/Cover Man.] 9898 [T/Cover Auto.]
Rear Wheel Bearing	- Inner	104910+48 [Full or Semi Fl. Axle]	104910+48 [Drums/Discs]	DAC488944 [Drums] 104910+48 [Discs]	104910+48 [Full or Semi Fl. Axle]
	- Outer	102910+49 [Full Floating Axle] 104910+48 [Semi Floating Axle]	102910+49 [Drums/Discs]	102910+49 [Discs]	102910+49 [Full Floating Axle] 104910+48 [Semi Floating Axle]
Rear Wheel Oil Seal	- Inner	9437 [Full Floating Axle only, with Rr. Drums] 62858/17 [Full Floating Axle only, with Rr. Discs]	9437 [Drums] 62858/17 [Discs]	9437 [Drums] 62858/17 [Discs]	9437 [Full Floating Axle only, with Rr. Drums] 62858/17 [Full Floating Axle only, with Rr. Discs]
	- Outer	9673 [Full Floating Axle] 9641 [Semi Floating Axle]	364609 [Drums/Discs]	9205 [Drums] 587007 [Discs]	9673 [Full Floating Axle] 9641 [Semi Floating Axle]
Rear Wheel Kit		PQ666 [Full float Drums] PQ667 [Full float. Discs] PQ669 [Semi float.]	PQ658 [Drums] PQ671 [Discs]	PQ672 [Drums] PQ673 [Discs]	PQ666 [Full float Drums] PQ667 [Full float. Discs] PQ669 [Semi float.]
Rear Wheel Hub / Stub Axle					

APPLICATIONS	LOCATION	TOYOTA LAND CRUISER 4X4 HDJ/HZJ80 4.2 Std., GX, VX, Turbo S/W, P/up 1HD-FT, 1HZ Dies., Turbo Dies.	TOYOTA LAND CRUISER 4X4 HDJ100 4.2 Std., GX, VX S/W, 1HZ Pet. 4.5 4.7 V8	TOYOTA LAND CRUISER 4X4 HDJ200 4.5 D-4D 4.6 V8 4.7 V8	TOYOTA LAND CRUISER 4X4 HZJ76 4.2D
YEARS		95-01	97-04	2007-	2009-
Front Wheel Bearing	- Inner	104910+48	104910+48	HUB328	104910+48
	- Outer	102910+49	102910+49		102910+49
Front Wheel Oil Seal	- Inner	9437 9437A [Alternative]	9437 9437A [Alternative]	9363	9437 9437A [Alternative]
	- Outer			9364	
Front Wheel Kit		PQ318	PQ318	PQ1015	PQ318
Front Wheel Hub / Stub Axle		318CHUB	318BHUB	1015HUB	318DHUB
Alternator / Generator Bearing	- Front	62032RS [65 Amp] 6501 2RS [80 Amp] PQ10192 [90 Amp]	462 2RS [70 Amp] PQ10192 [80, 100, 120 Amp]		
	- Rear	62022RS	62022RS		
Concentric / Thrust Bearing		RB9637 [HDJ80] RB9640 [HZJ80]	RB9637		RB9643
Diff Carrier Bearing	- Left	TR100802 [Fr. & Rr. Axle No Diff Lock] 32915 [Fr. & Rr. Axle with Diff Lock]	TR100802 [Fr. & Rr. Axle No Diff Lock] 32915 [Fr. & Rr. Axle with Diff Lock]	TR100802 [Front axle]	
	- Right	TR100802 [Fr. & Rr. Axle No Diff Lock] 32915 [Fr. & Rr. Axle with Diff Lock]	TR100802 [Fr. & Rr. Axle No Diff Lock] 32915 [Fr. & Rr. Axle with Diff Lock]	32915 [Front axle]	
Diff Pinion Bearing	- Front	TR070904-1 [Fr. axle] 30306 [Rr. axle]	TR070904-1 [Fr. axle] STA3072 [Rr. axle]	TR070904-1 [Front axle]	
	- Rear	STA3072 [Fr. axle] STF4090 [Rr. axle]	TR0607J-1 [Fr. axle] STF4090 [Rr. axle]	STA3072 [Front axle]	
Propshaft Support Bearing					
Pulley Bearing					
Spigot Shaft Bearing		62022RS	62022RS		
V-Belt Tensioner					
Drive Shaft Oil Seal	- Left				
	- Right				
Gearbox Oil Seal	- Front	354807 [Man.] 426007 [Auto.] 486208 [T/case Both]	354807 [Man.] 426007 [Auto.] 486208 [T/case Both]		
	- Rear	9919 [Ext. Housing 1] 486208 [Ext. Housing 2]	9919 [Fr. Ext. Housing] 486208 [Rr. Ext. Housing]		
Pinion Oil Seal		9804 [Fr./Rr. axle]	9804 [Fr./Rr. axle]	9359	
Spark Plug Tube Seal					
Rear Main Bearing Oil Seal		9790	9790	9790	
Timing Cover / Cam Oil Seal		9900 [T/Cover Man.] 9898 [T/Cover Auto.]	9900 [T/Cover]	9898 9900 [T/Cover]	
Rear Wheel Bearing	- Inner	104910+48 [Full or Semi Fl. Axle]	DAC488944 [Drums] 104910+48 [Discs]	HUB326 [LHS] [with integrated ABS sensor] HUB327 [RHS] [with integrated ABS sensor]	DAC488944
	- Outer	102910+49 [Full Floating Axle] RNU0727 [Semi Floating Axle]	102910+49 [Discs]		
Rear Wheel Oil Seal	- Inner	9437 [Full Floating Axle only, with Rr. Drums] 62858/17 [Full Floating Axle only, with Rr. Discs]	9437 [Drums] 62858/17 [Discs]	9369 [RHS] 9371 [LHS]	9437
	- Outer	9673 [Full Floating Axle] 9641 [Semi Floating Axle]	364609 [Drums/Discs]		364609
Rear Wheel Kit		PQ666 [Full float Drums] PQ667 [Full float. Discs] PQ669 [Semi float.]	PQ670 [Drums] PQ671 [Discs]	PQ1013 [LHS] PQ1014 [RHS]	PQ670
Rear Wheel Hub / Stub Axle					



APPLICATIONS	LOCATION	TOYOTA LAND CRUISER 4X4 HZJ105 4.2 Std., GX DSL, Turbo P/up, S/W 1HZ Dies., Turbo Dies.	TOYOTA LAND CRUISER 4X4 PHJ75 3.9 DLX, GX, GX Turbo P/up Perkins236 2H Dies FJ75 4.0 DLX, GX, VX 3F/F-E Pet., HJ75	TOYOTA LAND CRUISER 4X4 UZJ100 4.5 V8 Std., GX, VX S/W, P/up 2UZ-FE Pet.	TOYOTA LAND CRUISER 4X4 PRADO 90/95 3.0 1KZ-TE GX, GX TDi S/W Dies., VX S/W Pet. 3.4 V6 GX, VX S/W Pet. 5VZ-FE
YEARS		98-06	85-92	98-06	97-04
Front Wheel Bearing	- Inner	104910+48	104910+48	104910+48	DRT54PRADO
	- Outer	102910+49	102910+49	102910+49	
Front Wheel Oil Seal	- Inner	9437 9437A [Alternative]	9437 9437A [Alternative]	9437 9437A [Alternative]	
	- Outer				
Front Wheel Kit		PQ318	PQ318	PQ318	PQ1057
Front Wheel Hub / Stub Axle				318BHUB	1057HUB
Alternator / Generator Bearing	- Front	462 2RS [70 Amp] PQ10192 [80, 100,120 Amp]	62012RS [80 Amp] 62032RS [65 Amp] PQ10192 [90 Amp]	462 2RS [70 Amp] PQ10192 [80, 100,120 Amp]	PQ10192
	- Rear	62022RS	62012RS	62022RS	62022RS
Concentric / Thurst Bearing		RB9643	RB9887 [PHJ75] RB9636 [FJ75]	RB9637	RB9671 [3.0]
Diff Carrier Bearing	- Left	17831+887 [Fr. & Rr. Axle No Diff Lock] 28985+21SA [Fr. & Rr. Axle with Diff Lock]	17831+887 [Fr. & Rr. axle]	TR100802 [Fr. & Rr. Axle No Diff Lock] 32915 [Fr. & Rr. Axle with Diff Lock]	17831+887 [Fr. & Rr. axle, No Diff Lock] 28985+21SA [Fr. & Rr. Axle, with Diff Lock]
	- Right	17831+887 [Fr. & Rr. Axle No Diff Lock] 28985+21SA [Fr. & Rr. Axle with Diff Lock]	17831+887 [Fr. & Rr. axle]	TR100802 [Fr. & Rr. Axle No Diff Lock] 32915 [Fr. & Rr. Axle with Diff Lock]	17831+887 [Fr. & Rr. axle, No Diff Lock] 28985+21SA [Fr. & Rr. Axle, with Diff Lock]
Diff Pinion Bearing	- Front	TR070904-1 [Fr. axle] STA3072 [Rr. axle]	30308 [Fr. axle 85-90] TR070904-1 [Fr. axle 90-92] 30306 [Rr. axle]	TR070904-1 [Fr. axle] STA3072 [Rr. axle]	TR070904-1 [Fr. axle] STF4090 [Rr. axle]
	- Rear	TR0607J-1 [Fr. axle] STF4090 [Rr. axle]	30306 [Fr. axle 85-90] TR070904-1 [Fr. axle 90-92] 30308 [Rr. axle]	TR0607J-1 [Fr. axle] STF4090 [Rr. axle]	TR0607J-1 [Fr. axle] STF4090 [Rr. axle]
Propshaft Support Bearing					
Pulley Bearing					
Spigot Shaft Bearing		62022RS	62022RS	62022RS	62022RS
V-Belt Tensioner					
Drive Shaft Oil Seal	- Left				
	- Right				
Gearbox Oil Seal	- Front	9503 [Man.] 426007 [Auto.] 486208 [T/case Both]	9920	354807 [Man.] 426007 [Auto.] 486208 [T/case Both]	
	- Rear	9919 [Ext. Housing Fr.] 9649 [Ext. Housing Rr.]	9921 [Ext. Housing]	9919 [Ext. Housing Fr.] 9649 [Ext. Housing Rr.]	
Pinion Oil Seal		9804 [Fr./Rr. axle]	387411 [Fr. /Rr. 85-90] 9800 [Fr./Rr. 90-92]	9804 [Fr. & Rr. axle]	9804 [Fr. & Rr. axle]
Spark Plug Tube Seal					
Rear Main Bearing Oil Seal		9790	9752 [85-86] 9903 [87-92]	9993	9790
Timing Cover / Cam Oil Seal		9900 [T/Cover]	507212 [T/Cover Pet.] 9902 [T/Cover Dies.]	9900 [T/Cover]	9900 [T/Cover Man.] 9898 [T/Cover Auto.]
Rear Wheel Bearing	- Inner	104910+48 [Drums/Discs]	RNU0727	DAC488944 [Drums] 104910+48 [Discs]	DRT40PRAD
	- Outer	102910+49 [Drums/Discs]		102910+49 [Discs]	
Rear Wheel Oil Seal	- Inner	9437 [Drums] 62858/17 [Discs]		9437 [Drums] 62858/17 [Discs]	
	- Outer	364609 [Drums/Discs]	9641	364609 [Drums/Discs]	
Rear Wheel Kit		PQ658 [Drums] PQ671 [Discs]	PQ327 [Semi floating]	PQ670 [Drums] PQ671 [Discs]	PQ1101 [97-04]
Rear Wheel Hub / Stub Axle					

APPLICATIONS	LOCATION	TOYOTA LAND CRUISER 4X4 PRADO 120 3.0D 1KZ-TE VX S/W 4.0 1GR-FE GX, VX S/W	TOYOTA LAND CRUISER 4X4 PRADO 150 3.0TDi 1KD-FTV 4.0 V6 VVTi 1GR-FE	TOYOTA QUANTUM 2.5 D-4D, "Family", S-long MPV, Van 2KD-FTV Dies. 2.7 "Family", S-long "Ses'fikile" MPV, Van 2TR- FE Pet.	TOYOTA RAV4 I 4X4 SXA10/11 2.0 3/5 Dr. SWB SUV 3S-FE Pet.
YEARS		02-10	2009-	2005-	94-01
Front Wheel Bearing	- Inner	HUB171 [with integrated ABS sensor] HUB328 [3.0]	HUB171 [with integrated ABS sensor]	HUB099	38003
	- Outer				
Front Wheel Oil Seal	- Inner	9363	9363	HUB UNIT	
	- Outer	9364	9364		9645 [Kit non ABS] 9913 [Kit ABS]
Front Wheel Kit		PQ663 [ABS]	PQ663 [ABS]	PQ728 PQ728COMP [Complete Assembled Unit] [No Disc]	PQ313 [Non ABS] PQ313A [ABS]
Front Wheel Hub / Stub Axle		663HUB	663HUB	099HUB SA728L/R	313AHUB
Alternator / Generator Bearing	- Front			63032RS [2.7]	63112RS
	- Rear				62022RS
Concentric / Thurst Bearing		RB9696 [3.0]	RB9696 [3.0]	RB9671 [2.5] RB9804 [2.7]	RB9866
Diff Carrier Bearing	- Left			TR100802	R41Z-170A [Fr. & Rr. axle]
	- Right			TR100802	R41Z-170A [Fr. & Rr. axle]
Diff Pinion Bearing	- Front			TR070904-1	86610+49 [Fr. & Rr. axle]
	- Rear			STA3072	86610+49 [Fr. & Rr. axle]
Propshaft Support Bearing					
Pulley Bearing				6302RMX For VBT011	
Spigot Shaft Bearing				62012RS [2.7]	
V-Belt Tensioner				VBT006 [2.7] VBT007 [2.7] [Pulley Only] VBT009 [2.5]	
Drive Shaft Oil Seal	- Left	9359 [Fr. axle] 9360 [Rr. axle]			9901
	- Right	9359 [Fr. axle] 9360 [Rr. axle]			9901
Gearbox Oil Seal	- Front			9503	
	- Rear			9540	385811 [Ext. Housing]
Pinion Oil Seal				9359	9666 [Auto. 95-97] 9808 [Auto. 97-02]
Spark Plug Tube Seal					
Rear Main Bearing Oil Seal		9790		9790 [2.5] 9223 [2.7]	9649
Timing Cover / Cam Oil Seal		9303 [Cam] 506810 [T/Cover] 9357 [T/Cover Alt.]		9286 [T/Cover 2.5] 9303 [Cam 2.5] 486807 [T/Cover 2.7] 657907 [Aux. Pulley]	9804 [Cam] 426007 [T/Cover]
Rear Wheel Bearing	- Inner	HUB174R [RHS] [with integrated ABS sensor] HUB175L [LHS] [with integrated ABS sensor]	HUB174R [RHS] [with integrated ABS sensor] HUB175L [LHS] [with integrated ABS sensor]	409026RS + RR42	HUB010
	- Outer				
Rear Wheel Oil Seal	- Inner	9369 [RHS] 9371 [LHS]	9369 [RHS] 9371 [LHS]	507009	HUB UNIT
	- Outer	9370 [RHS] 9372 [LHS]	9370 [RHS] 9372 [LHS]	9416	
Rear Wheel Kit		PQ842L/R	PQ842L/R	PQ729 [Brg., seals] PQ729ABS PQ729A [Brg., Hub, no seals]	PQ457
Rear Wheel Hub / Stub Axle				729HUB	

APPLICATIONS	LOCATION	TOYOTA RAV4 II 4X2, 4X4 ZCA20 1.8 SUV 1ZZFE ACA20 2.0 SUV 1AZ-FE	TOYOTA RAV4 III 4X4 2.0i 1AZ-FE GX, VX, Fierce SUV 2.2i D-4D 2AD-FTV GX, VX SUV	TOYOTA RAV4 IV 4X2, 4X4 2.0 2.2D 2AD-FTV 2.5 2AR-FE	TOYOTA RUNX 140i RT, RS, Sport 4ZZ-FE 160i RS, RT, RX, Sport 3ZZ-FE 180i RSi, RX 1ZZ-FE
		YEARS	02-06	06-13	2013-
Front Wheel Bearing	- Inner	43BWD06	HUB165 [with integrated ABS sensor] HUB166 [with integrated ABS sensor]	HUB165 [with integrated ABS sensor]	40BWD12
	- Outer				
Front Wheel Oil Seal	- Inner	Sealed Bearing	HUB UNIT	HUB UNIT	Sealed Bearing
	- Outer				
Front Wheel Kit		PQ353	PQ660 [Auto.] [5 Studs] [26 Spline] PQ661 [Man.] [5 Studs] [30 Spline]	PQ661 [5 Studs] [30 Spline]	PQ598
Front Wheel Hub / Stub Axle		353HUB [2.0] [4X4]			598HUB
Alternator / Generator Bearing	- Front	64032RS			
	- Rear	62022RS			
Concentric / Thurst Bearing		RB9866	RB9866 [2.0] RB9890 [2.2D]	Concentric slave cylinder RB9005 [2.2D]	RB9670
Diff Carrier Bearing	- Left	17831+887 [Fr. & Rr. axle]			
	- Right	17831+887 [Fr. & Rr. axle]			
Diff Pinion Bearing	- Front	86610+49 [Fr. & Rr. axle]			
	- Rear	88610+49 [Fr. & Rr. axle]			
Propshaft Support Bearing					
Pulley Bearing					
Spigot Shaft Bearing					
V-Belt Tensioner					VBT004
Drive Shaft Oil Seal	- Left	597008	9373 [Fr. axle] 9374 [Rr. axle]		9699
	- Right	597008	9373 [Fr. axle] 9374 [Rr. axle]		9646
Gearbox Oil Seal	- Front	385509	304207		253708
	- Rear	385811			385811
Pinion Oil Seal		9666			
Spark Plug Tube Seal					
Rear Main Bearing Oil Seal		9649	9667	9351 [2.0] 9354 [2.2D]	9220
Timing Cover / Cam Oil Seal		9748 [T/Cover] 9804 [Cam]	9804 [Cam] 385006 [T/Cover 2.0] 9804 [T/Cover 2.2]	385006 [T/Cover] [2.0] 9350 [T/Cover 2.2D]	9643 [T/Cover] 9765 [Cam 1.4, 1.6i] 9804 [Cam 1.8i]
Rear Wheel Bearing	- Inner	HUB211 [with integrated ABS sensor] HUB088 [Non ABS] HUB089 [2.0] [4X4]	HUB329 [with integrated ABS sensor]	HUB329 [2.0] [with integrated ABS sensor] HUB330 [2.2D, 2.5] [with integrated ABS sensor]	HUB090 [with integrated ABS sensor] HUB101 [Non ABS]
	- Outer				
Rear Wheel Oil Seal	- Inner	HUB UNIT	HUB UNIT	HUB UNIT	HUB UNIT
	- Outer				
Rear Wheel Kit		PQ929 [5 Studs] PQ643 [5 Studs] PQ644 [2.0] [4X4]	PQ1016 [5 Studs] [4x4]	PQ1017 [5 Studs] [2.0] [4x2] PQ1016 [5 Studs] [4x4]	PQ650 [ABS] [4 Studs] PQ703 [Non ABS] [4 Studs]
Rear Wheel Hub / Stub Axle					

APPLICATIONS	LOCATION	TOYOTA STALLION	TOYOTA STOUT	TOYOTA TUV	TOYOTA YARIS
		KF50 1.5 SR5, Commuter, Bus, P/up, P/van 5K Pet. YF50 1.8 SR5, P/up, P/van, Van 2Y Pet. LF50 2.4D P/up 2L5F Dies.	RK110 2.0 SWB P/up 5R Pet.	KF20 1.3 Chassis Cab, P/up, P/van, Bus 4K Pet. 1.5 P/up 5K Pet.	1.0 T1, 1.3 T3, +, Spirit, T3 Spirit - Saloon & Hatch 2NZ-FE 1.8 TS Hatch
YEARS		87-04	79-89	82-87	05-10
Front Wheel Bearing	- Inner	67010+48	57305	44610+49	DAC4017A [ASB]
	- Outer	11910+49		11710+49	
Front Wheel Oil Seal	- Inner	9442	9750		Sealed Bearing
	- Outer			405207	
Front Wheel Kit		PQ136		PQ311	PQ715
Front Wheel Hub / Stub Axle					715HUB
Alternator / Generator Bearing	- Front	6202ZZ [1.5] 63022RS [1.8, 2.4]	62032RS	62032RS	
	- Rear	6201ZZ [1.5] 62012RS [1.8, 2.4]	62012RS	62012RS	
Concentric / Thurst Bearing		RB9548 [1.5 87-88] RB9896 [1.5 89-91, 1.8] RB9804 [2.4]	RB9535 [79-80] RB9548 [80-89]	RB9583	RB9692 [1.0, 1.3] RB9891 [1.8]
Diff Carrier Bearing	- Left	17831+887 [Imported] 501310+49 [Local]	17831+887	17831+887 [Imported] 501310+49 [Local]	
	- Right	17831+887 [Imported] 501310+49 [Local]	17831+887	17831+887 [Imported] 501310+49 [Local]	
Diff Pinion Bearing	- Front	30306 [Imported] 86610+49 [Local]	30306	30306 [Imported] 86610+49 [Local]	
	- Rear	30306 [Imported] 86610+49 [Local]	30308	32307 [Imported] 88610+49 [Local]	
Propshaft Support Bearing			62062RS	60012RS	
Pulley Bearing					
Spigot Shaft Bearing		62012RS	62012RS		
V-Belt Tensioner					
Drive Shaft Oil Seal	- Left				9699 [1.0, 1.3] 9355 [1.8]
	- Right				9646 [1.0, 1.3] 9355 [1.8]
Gearbox Oil Seal	- Front	324808 [4 Spd.] 304508 [5 Spd.]	9740	253807	9356
	- Rear	385811	386509	324409	
Pinion Oil Seal		387411 [Imported] 2738 [Local]	387411	387411 [Imported] 2738 [Local]	
Spark Plug Tube Seal					
Rear Main Bearing Oil Seal		9642 [1.5] 9648 [1.8] 9649 [2.4]	8010012	9642	9305 [1.0, 1.3] 9351 [1.8]
Timing Cover / Cam Oil Seal		9643 [Cam] 9705 [T/Cover 1.5] 426007 [T/Cover 1.8, 2.4]	456812 [T/Cover]	385811 [T/Cover 1.3] 9705 [T/Cover 1.5]	253807 [Cam 1.0, 1.3] 385006 [T/Cover 1.0] 9765 [T/Cover 1.3] 9804 [Cam + T/Cover 1.8]
Rear Wheel Bearing	- Inner	B35-53AC4 + C014 [Imported] U399+360 + 1852119 [Local]	RNU0727	B35-53AC4 + C014 [Imported] U399+360 + 1852119 [Local]	HUB107 [with integrated ABS sensor]
	- Outer				
Rear Wheel Oil Seal	- Inner				HUB UNIT
	- Outer	9601 [Imported] 9415 [Local]	9641	9601 [Imported] 9415 [Local]	
Rear Wheel Kit		PQ312 [Imported] PQ176 [Local]	PQ327	PQ312 [Imported] PQ176 [Local]	PQ719 [4 Studs]
Rear Wheel Hub / Stub Axle					

APPLICATIONS	LOCATION	TOYOTA YARIS	TOYOTA YARIS	TOYOTA VENTURE	
		1.0 1.3 ZEN3 1.5 Hybrid	1.5 2NR-FE Pet.	YF50 1.8 8/10 Seater P/van 2Y Pet. 2.2 10 Seater, GLE, Getaway 9 Seater S/W 4Y Pet. LF50 2.4D 10 Seater S/W 2L5F Dies.	
YEARS		10-18	2018-	91-04	
Front Wheel Bearing	- Inner	DAC4017A [ASB]	HUB404L/R [with integrated ABS sensor]	67010+48	
	- Outer			11910+49	
Front Wheel Oil Seal	- Inner	Sealed Bearing	HUB UNIT	9442	
	- Outer				
Front Wheel Kit		PQ715	PQ1132L/R	PQ136	
Front Wheel Hub / Stub Axle		715HUB		136HUB [90-95] 136AHUB [95-04]	
Alternator / Generator Bearing	- Front			63022RS	
	- Rear			62012RS	
Concentric / Thurst Bearing		RB9692 [1.0 Alt. & 1.3] RB9891 [1.3 ZEN 3] Concentric Slave Cylinder [1.0]		RB9896 [1.8, 2.2] RB9804 [2.4]	
Diff Carrier Bearing	- Left			501310+49	
	- Right			501310+49	
Diff Pinion Bearing	- Front			86610+49	
	- Rear			88610+49	
Propshaft Support Bearing				60012RS	
Pulley Bearing					
Spigot Shaft Bearing				62012RS	
V-Belt Tensioner					
Drive Shaft Oil Seal	- Left				
	- Right				
Gearbox Oil Seal	- Front			304508	
	- Rear			385811	
Pinion Oil Seal				2738	
Spark Plug Tube Seal					
Rear Main Bearing Oil Seal		9092FS [1.3] 9096 [1.3 ZEN 3, 1.5] 9305 [1.0]		9648 [1.8, 2.2] 9649 [2.4]	
Timing Cover / Cam Oil Seal		385006 [T/Cover 1.0] 9576 [T/Cover 1.3]		9643 [Cam] 426007 [T/Cover]	
Rear Wheel Bearing	- Inner	HUB107 [with integrated ABS sensor] HUB254 [1.5 Hybrid] [with integrated ABS sensor]	HUB405 [with integrated ABS sensor]	U399+360 + 1852119	
	- Outer				
Rear Wheel Oil Seal	- Inner	HUB UNIT	HUB UNIT		
	- Outer			9415	
Rear Wheel Kit		PQ719 [4 Studs] PQ812 [1.5 Hybrid]	PQ1133	PQ176	
Rear Wheel Hub / Stub Axle					

APPLICATIONS	LOCATION	VW AMAROK 4X2, 4X4 2.0 TSi [11-14] 2.0 TDi 2.0 Bi-TDi	VW BEETLE 1.8T Coupe APH, 2.0i Cabriolet, Highline AZJ	VW BEETLE 1.2 TSi 1.4 TSi	VW CADDY 1.6 SWB, Caddy Club P/up JK Dies., HM Pet. 1.8 SWB L, Sport P/ up HV Pet.
YEARS		10-16	00-12	2012-	81-97
Front Wheel Bearing	- Inner	DAC49VWAMASB	40BWD06	HUB108 [288mm Disc] [with integrated ABS sensor]	309726
	- Outer				
Front Wheel Oil Seal	- Inner	Sealed Bearing	Sealed Bearing	HUB UNIT	Sealed Bearing
	- Outer				
Front Wheel Kit		PQ834	PQ449	PQ688 [ID: 29mm] [4 Mount Holes]	PQ107
Front Wheel Hub / Stub Axle		834HUB	449HUB [ABS Gear] [OD 133mm]		107HUB
Alternator / Generator Bearing	- Front				62022RS
	- Rear				62012RS
Concentric / Thurst Bearing		Concentric Slave Cylinder	RB9855	RB9680 [1.2 TSi] RB9855 [1.4 TSi]	RB9574
Diff Carrier Bearing	- Left		501310+49 [1.8 Man.] 300811+49 [2.0 Auto.] VWDC386518 [2.0]		29710+49
	- Right		501310+49 [1.8 Man.] 300811+49 [2.0 Auto.] VWDC386518 [2.0]		29710+49
Diff Pinion Bearing	- Front		331274		331274 [Left]
	- Rear				330757 [Right]
Propshaft Support Bearing					
Pulley Bearing					
Spigot Shaft Bearing					
V-Belt Tensioner					
Drive Shaft Oil Seal	- Left		9302 [1.8] 607408 [2.0]		9770 [Kit]
	- Right		9302 [1.8] 506508 [2.0]		9770 [Kit]
Gearbox Oil Seal	- Front		243806 [1.8] 223507 [2.0 Man.] 9875 [2.0 Auto.]		224008
	- Rear		345208		
Pinion Oil Seal					233506
Spark Plug Tube Seal					
Rear Main Bearing Oil Seal		9580FS [Diesel] [4X2, 4X4] 9582FS [Petrol] [4X2]	8510512 [00-03] 9945FS [03-]	9573FS	8510512
Timing Cover / Cam Oil Seal		456008 [T/cover Petrol] [4X2] 9548 [Cam Diesel] [4X2, 4X4] 9549 [T/cover Diesel] [4X2, 4X4]	9548 [Cam] 9549 [T/cover]	9548 [Cam] 9549 [T/cover]	324710 [Cam,T/Cover, Int. Shaft]
Rear Wheel Bearing	- Inner	DAC46RWWAM	HUB102 [Non ABS] HUB095 [with ABS pulse ring]	HUB100 [with integrated ABS sensor] HUB109 [with integrated ABS sensor]	331274
	- Outer				11910+49
Rear Wheel Oil Seal	- Inner	Sealed Bearing	HUB UNIT	HUB UNIT	
	- Outer				405208SP
Rear Wheel Kit		PQ835	PQ450 [5 Studs] PQ684 [5 Studs]	PQ689 [ID: 32mm] [5 Holes] PQ691 [ID: 30mm] [5 Studs]	PQ151
Rear Wheel Hub / Stub Axle			SA450		

APPLICATIONS	LOCATION	VW CADDY 1.6i Club, Citi, P/up HM Pet.	VW CADDY 1.6i Life Van, MPV BGU 1.9TDi Life, Maxi Van, MPV BJB 2.0SDi Van, P/van BDJ 2.0TDi	VW CC 2.0TSi 2.0TDi 3.6 V6 FSi 4Motion	VW CITI GOLF 1.3 L ET/GY 1.6 Blues, Chico, Chico Lux, Deco, Designa, L, Ritz, Shuttle, Sonic, Sport HM, HV, FR 1.6iL, Life, VeloCiti, TenaCiti, CitiStorm, - Sport, - Rox, Rhythm, MKI AFX 1.8 CTi, Designa, L Sport BZF
YEARS		97-03	2004-	2009-	83-09
Front Wheel Bearing	- Inner	311316	HUB108 [288mm Disc] [with integrated ABS sensor] HUB177 [280mm Disc] [with integrated ABS sensor]	HUB108 [288mm Disc] [with integrated ABS sensor]	309726
	- Outer				
Front Wheel Oil Seal	- Inner	Sealed Bearing	HUB UNIT	HUB UNIT	Sealed Bearing
	- Outer				
Front Wheel Kit		PQ440	PQ664 [36 Spline] [3 Mount Holes] PQ688 [ID: 29mm] [4 Mount Holes]	PQ688 [ID: 29mm] [4 Mount Holes]	PQ107
Front Wheel Hub / Stub Axle		440HUB			107HUB SA107L/R
Alternator / Generator Bearing	- Front	62022RS			62032RS
	- Rear	62012RS			62012RS
Concentric / Thurst Bearing		RB9574	RB9680 [1.6i] RB9855 [1.9TDi, 2.0 TDi]	Concentric Slave Cylinder	RB9574
Diff Carrier Bearing	- Left	300811+49 VWDC386518 [Some mod.]	VWDC386518 [1.6i] 300811+49 [1.9, 2.0SDi]		330757 [1.3] 29710+49
	- Right	300811+49 VWDC386518 [Some mod.]	VWDC386518 [1.6i] 300811+49 [1.9, 2.0SDi]		330757 [1.3] 29710+49
Diff Pinion Bearing	- Front	331274 [Left]			331274 [Left] 330757C/VQ051 [Centre] 361895 [Left] [1.3]
	- Rear	330757 [Right]			330757 [Right] 492179 [Right] [1.3]
Spigot Shaft Bearing					VW Bush
Drive Shaft Oil Seal	- Left	9770 [Kit] 577107 [Alt.]	486208		9770 [Kit]
	- Right	9770 [Kit] 9302 [Alt.]	486208 9230 [Alt.]		9770 [Kit]
Gearbox Oil Seal	- Front	224008 223507 [Alt.]	243806 [1.6i] 223507 [1.9, 2.0SDi]		223507 [1.3] 224008 9856 [Pushrod]
	- Rear				
Pinion Oil Seal		233506			233506
Rear Main Bearing Oil Seal		9945FS	9228FS [1.6i, 2.0TDi] 9229FS [1.9TDi] 9580FS [2.0SDi, 2.0TDi 5M G/Box]	8510511 [3.6] 9580FS [Diesel] 9582FS [Petrol]	8510512
Timing Cover / Cam Oil Seal		324710 [Cam] 354810 [T/Cover]	9548 [Cam] 9549 [T/cover]	456008 [T/cover Petrol] 9548 [Cam Diesel] 9549 [T/cover Diesel]	324710 [Cam, T/Cover, Intermed. Shaft]
Rear Wheel Bearing	- Inner	HUB113 [with integrated ABS sensor]	HUB100 [with integrated ABS sensor] HUB109 [with integrated ABS sensor]	HUB108 [288mm Disc] [4Motion] [with integrated ABS sensor] HUB109 [with integrated ABS sensor]	331274
	- Outer				11710+49
Rear Wheel Oil Seal	- Inner	HUB UNIT	HUB UNIT	HUB UNIT	405208SP 405208 [1.6i 99-09]
	- Outer				
Rear Wheel Kit		PQ704 [4 Holes]	PQ689 [ID: 32mm] [5 Holes] PQ691 [ID: 30mm] [5 Studs]	PQ688 [ID: 29mm] [4 Mount Holes] PQ689 [ID: 32mm][5 Holes]	PQ108
Rear Wheel Hub / Stub Axle					SA108



APPLICATIONS		LOCATION	VW CITI GOLF 1.3 L Shuttle, Chico, Chico Lux ET/ GY/ AJD, [87-03] 1.4, iL, Chico, Rhythm, Citi com, VeloCiti, TenaCiti, CitiStorm, - Sport, Rox, Rhythm, Wolf, - XCite, Billabong AGY/ BSV [99-09]	VW CRAFTER 4X4 2.5TDi 35 Series SWB P/van, 50 HR Series LWB/ XLWB P/van	VW CRAFTER 2.0 TDi, Bi-TDi "35" 2.0 TDi, Bi-TDi "50"	VW EOS 1.4 TSi 2.0 FSi, TSi, TFSi
YEARS			87-09	07-12	2012-	07-12
Front Wheel Bearing	- Inner		309726	DRT51CRAFT	HUB311 [Std. Suspension] HUB331 [HD Suspension]	HUB108 [288mm Disc] [with integrated ABS sensor]
	- Outer					
Front Wheel Oil Seal	- Inner		Sealed Bearing	Sealed Bearing		HUB UNIT
	- Outer					
Front Wheel Kit			PQ107	PQ1020	PQ989 [Std. Suspension] PQ1018 [HD Suspension]	PQ688 [ID: 29mm] [4 Mount Holes]
Front Wheel Hub / Stub Axle			107HUB SA107L/R			
Alternator / Generator Bearing	- Front		63032RS			
	- Rear		6203ZZ			
Concentric / Thurst Bearing			RB9574	Concentric Slave Cylinder	Concentric Slave Cylinder	Concentric Slave Cylinder RB9855 [1.4 TSi]
Diff Carrier Bearing	- Left		29710+49			
	- Right		29710+49			
Diff Pinion Bearing	- Front		331274 [Left] 330757C/VQ051 [Centre]			
	- Rear		330757 [Right]			
Propshaft Support Bearing						
Pulley Bearing						
Spigot Shaft Bearing			VW Bush			
V-Belt Tensioner						
Drive Shaft Oil Seal	- Left		9770 [Kit]			
	- Right		9770 [Kit]			
Gearbox Oil Seal	- Front		224008 9856 [Pushrod]			
	- Rear					
Pinion Oil Seal			233506			
Spark Plug Tube Seal						
Rear Main Bearing Oil Seal			8510512	9097FS [Alt.] 9507FS	9580FS	9573FS [1.4] 9945FS [2.0]
Timing Cover / Cam Oil Seal			324710 [Cam,T/Cover, Intermed. Shaft]	9548 [Cam] 9549 [T/cover]	9548 [Cam] 9549 [T/cover]	9548 [Cam 2.0] 9549 [T/cover]
Rear Wheel Bearing	- Inner		331274	HUB312	TRB55CRAFT	HUB109 [with integrated ABS sensor]
	- Outer		11710+49		TRB60CRAFT	
Rear Wheel Oil Seal	- Inner			HUB UNIT		HUB UNIT
	- Outer		405208SP 405208 [1.4i 99-09]			
Rear Wheel Kit			PQ108	PQ990	PQ1019	PQ689 [ID: 32mm] [5 Holes]
Rear Wheel Hub / Stub Axle			SA108			



APPLICATIONS	LOCATION	VW FOX	VW GOLF I	VW GOLF II	VW GOLF III
		1.3 L, L Trippa GY 1.6 L HM 1.8 L Sport HV	1.1 GL, L, LS ET/EG 1.3 GL, L, LS GF 1.5 GL Diesel, GLS, LS CK/ EM/ JB 1.6 GL Diesel, GT, GTS, GTX JK/ CR FR 1.8 GTi EV	1.3 CL GY 1.6 CSL HM 1.8 8/16V CSX, GTS, GTi KR, EV 2.0 8/16V GTi AAL	1.6 GS ACG 1.8 GSX, GTS ACH 2.0 GTi, Exec. 2E 2.8 VR6, Exec. AAA
YEARS		87-96	78-84	84-92	92-99
Front Wheel Bearing	- Inner	309726	309726	311309 [84-89] 311443 [89-92]	311443
	- Outer				
Front Wheel Oil Seal	- Inner	Sealed Bearing	Sealed Bearing	Sealed Bearing	Sealed Bearing
	- Outer				
Front Wheel Kit		PQ107	PQ107	PQ169 [84-89] PQ167 [89-92]	PQ167
Front Wheel Hub / Stub Axle		107HUB SA107L/R	107HUB SA107L/R	169HUB [Bearing ID: 35mm] 167HUB [Bearing ID: 40mm]	167HUB [Bearing ID: 40mm] 167AHUB [2.8 VR6]
Alternator / Generator Bearing	- Front	62032RS	62032RS	62032RS	62032RS [1.6, 2.0, 2.8] 6203ZZ [1.8]
	- Rear	62012RS	62012RS	62012RS	62012RS [1.6, 2.0, 2.8] 6201ZZ [1.8]
Concentric / Thurst Bearing		RB9574	RB9573 [1.1] RB9574	RB9574 [1.3, 1.6, 1.8] RB9855 [2.0]	RB9574 [1.6, 1.8, 2.0] RB9855 [2.8]
Diff Carrier Bearing	- Left	29710+49	29710+49 330757 [1.1, 1.3]	29710+49 [1.3, 1.6, 1.8] 300811+49 [2.0]	29710+49 [1.6, 1.8, 2.0] 300811+49 [2.8]
	- Right	29710+49	29710+49 330757 [1.1, 1.3]	29710+49 [1.3, 1.6, 1.8] 300811+49 [2.0]	29710+49 [1.6, 1.8, 2.0] 300811+49 [2.8]
Diff Pinion Bearing	- Front	331274 [Left] 330757C/VQ051 [Centre]	361895 [Left] [1.1, 1.3] 331274 [Left] 330757C/VQ051 [Centre]	331274 [Left] 330757C/VQ051 [Centre]	331274 [Left Man.] 67010+48 [Left Auto.] [1.6, 1.8]
	- Rear	330757 [Right Man.] 67010+48 [Right Auto.]	492179 [Right] [1.1, 1.3] 330757 [Right Man.] 67010+48 [Right Auto.]	330757 [Right Man.] 67010+48 [Right Auto.] [1.8, 2.0]	67010+48 [Right]
Propshaft Support Bearing					
Pulley Bearing					
Spigot Shaft Bearing		VW Bush	VW Bush [1.1, 1.3]		
V-Belt Tensioner					
Drive Shaft Oil Seal	- Left	9770 [Kit Man.] 366010 [Auto.]	9770 [Kit Man.] 366010 [Auto.]	9770 [Kit 1.3, 1.6, 1.8] 9829 [2.0]	9770 [Kit 1.6, 1.8, 2.0] 9829 [2.8]
	- Right	9770 [Kit Man.] 366010 [Auto.]	9770 [Kit Man.] 366010 [Auto.]	9770 [Kit 1.3, 1.6, 1.8] 9829 [2.0]	9770 [Kit 1.6, 1.8, 2.0] 9829 [2.8]
Gearbox Oil Seal	- Front	224008 [Man.] 9830 [Auto.] 9856 [Pushrod]	223507 [1.1, 1.3] 244008	224008 [Man.] 9830 [Auto.] [1.8, 2.0] 9856 [Pushrod]	224008 [1.6, 1.8, 2.0] 9830 [Auto.] [1.6, 1.8] 9865 [2.8] 9856 [Pushrod]
	- Rear				
Pinion Oil Seal		233506	233506	233506	233506
Spark Plug Tube Seal					
Rear Main Bearing Oil Seal		8510512	8510512	8510512	8510512
Timing Cover / Cam Oil Seal		324710 [Cam,T/Cover, Intermed. Shaft]	324710 [Cam,T/Cover, Intermed. Shaft]	324710 [Cam,T/Cover, Intermed. Shaft]	324710 [Cam,T/Cover, Intermed. Shaft]
Rear Wheel Bearing	- Inner	331274	331274	331274	331274
	- Outer	11710+49	11710+49	11710+49	11710+49
Rear Wheel Oil Seal	- Inner				
	- Outer	405208SP	405208SP	405208SP	405208SP
Rear Wheel Kit		PQ108	PQ108	PQ108	PQ108
Rear Wheel Hub / Stub Axle		SA108	SA108		

APPLICATIONS	LOCATION	VW GOLF IV 1.6i Comfortline, Std., Estate AKL 1.8, T GTi, Highline AGU/ AGN 1.9 TDi Highline, Estate AHF 2.0i Cabrio, Highline APK	VW GOLF V 1.6i Comfortline, Tiptronic, Trendline BGU 1.9TDi Comfortline, Highline 2.0i Comfortline, GTI, GTI Trendline DSG/ AXX/BWA 2.0FSi Sport, Sport Tiptronic AXW, 2.0TDi, Sport DSG/ BKD	VW GOLF VI 1.4TSi Comfortline, Trendline, Highline 1.6i Comfortline, Trendline 1.6TDi	VW GOLF VI 2.0i GTi, Tiptronic 2.0TSi 4Motion 2.0TDi Highline, DSG
YEARS		99-04	04-09	09-13	09-13
Front Wheel Bearing	- Inner	40BWD06	HUB108 [288mm Disc] [with integrated ABS sensor] HUB177 [280mm Disc] [with integrated ABS sensor] [2.0i, FSi, TDi]	HUB108 [288mm Disc] [with integrated ABS sensor] HUB177 [280mm Disc] [with integrated ABS sensor]	HUB108 [288mm Disc] [with integrated ABS sensor] HUB177 [280mm Disc] [with integrated ABS sensor]
	- Outer				
Front Wheel Oil Seal	- Inner	Sealed Bearing	HUB UNIT	HUB UNIT	HUB UNIT
	- Outer				
Front Wheel Kit		PQ449	PQ688 [ID: 29mm] [4 Mount Holes] PQ664 [3 Mount Holes] [2.0i, FSi, TDi]	PQ688 [ID: 29mm] [4 Mount Holes] PQ664 [3 Mount Holes]	PQ688 [ID: 29mm] [4 Mount Holes] PQ664 [3 Mount Holes]
Front Wheel Hub / Stub Axle		449HUB [ABS Gear] [OD: 133mm]			
Concentric / Thrust Bearing		RB9574 [1.6] RB9855 [1.8, 1.9, 2.0]	Concentric Slave Cylinder [Diesel] RB9855 [1.9, 2.0FSi]	RB9640 [MQ200 Trans.] RB9680 [1.6] RB9855 [1.4 MQ250 Trans., 1.6TDi]	Concentric Slave Cylinder
Diff Carrier Bearing	- Left	501310+49 [Man.] 300811+49 [Auto.]	503310+49 [Man.] 300811+49 [Tiptronic, DSG]	503310+49 [Man.] 300811+49 [Tiptronic, DSG]	503310+49 [Man.] 300811+49 [Tiptronic, DSG]
	- Right	501310+49 [Man.] 300811+49 [Auto.]	300811+49 [Tipt., DSG] VWDC386518 [Man. 5 Spd.] VWDC487618 [Man. 6 Spd.]	300811+49 [Tipt., DSG] VWDC386518 [Man. 5 Spd.] VWDC487618 [Man. 6 Spd.]	300811+49 [Tipt., DSG] VWDC386518 [Man. 5 Spd.] VWDC487618 [Man. 6 Spd.]
Diff Pinion Bearing	- Front	331274 [Left]			
	- Rear				
V-Belt Tensioner		VBT001 VBT002 [1.9]	VBT001 [1.6, TDi] VBT012 [comfortline, Trendline]	VBT001 VBT012 [1.4]	
Drive Shaft Oil Seal	- Left	506508 [1.6] 9302 [1.8, 1.9, 2.0]	607408 [Man.] 486208 [Tiptronic, DSG]	607408 [Man.] 486208 [Tiptronic, DSG]	607408 [Man.] 486208 [Tiptronic, DSG]
	- Right	506508 [1.6] 9302 [1.8, 1.9, 2.0]	506508 [Man.] 486208 [Tiptronic, DSG]	506508 [Man.] 486208 [Tiptronic, DSG]	506508 [Man.] 486208 [Tiptronic, DSG]
Gearbox Oil Seal	- Front	244008 [Man. 1.6] 223507 [Man. 1.8, 1.9, 2.0] 9875 [Auto.]	243806 [5 Spd.] 223507 [Alt. 5 Spd.] 284207 [6 Spd.]	243806 [5 Spd.] 223507 [Alt. 5 Spd.] 284207 [6 Spd.]	243806 [5 Spd.] 223507 [Alt. 5 Spd.] 284207 [6 Spd.]
	- Rear	345208			
Pinion Oil Seal		345208 [Auto. only]			
Rear Main Bearing Oil Seal		8510512 [99-03] 9945FS [03-05]	9229FS [Diesel] 9231FS [1.6] 9232FS [Petrol]	9228FS [1.6] 9573FS [1.4] 9580FS [1.6TDi]	9580FS [2.0TDi] 9582FS [2.0GTi] 9945FS [2.0TSi 4Motion]
Timing Cover / Cam Oil Seal		9548 [Cam] 9549 [T/cover]	9548 [Cam] 9549 [T/cover]	9548 [Cam] 9549 [T/cover]	456008 [T/cover 2.0GTi] 9548 [Cam 2.0TDi] 9549 [T/cover]
Rear Wheel Bearing	- Inner	HUB102 [Non ABS] HUB095 [with ABS pulse ring]	HUB100 [with integrated ABS sensor] HUB109 [with integrated ABS sensor]	HUB100 [with integrated ABS sensor] HUB109 [with integrated ABS sensor] HUB363 [with integrated ABS sensor]	HUB100 [with integrated ABS sensor] HUB108 [288mm Disc] [with integrated ABS sensor] HUB109 [with integrated ABS sensor]
Rear Wheel Oil Seal	- Inner	HUB UNIT	HUB UNIT	HUB UNIT	HUB UNIT
	- Outer				
Rear Wheel Kit		PQ684 [5 Studs] PQ450 [5 Studs]	PQ691 [ID: 30mm] [5 Studs] PQ689 [ID: 32mm] [5 Holes]	PQ691 [ID: 30mm] [5 Studs] PQ689 [ID: 32mm] [5 Holes] PQ1065 [ID: 28mm]	PQ691 [ID: 30mm][5 Studs] PQ688 [ID: 29mm] [4 Mount Holes][4Motion] PQ689 [ID: 32mm][5 Holes]
Rear Wheel Hub / Stub Axle		SA450			

APPLICATIONS	LOCATION	VW GOLF VII	VW JETTA I	VW JETTA II	VW JETTA III
		1.2TSi 1.4TSi 2.0 GTi 2.0TDi	1.3 GL, GX ET/ GF 1.5 GLS/ GLX JB 1.6 GLS EM 1.8 GLi DX	1.6 CSL HM, 1.8 8/16V CLi, CLi Exec., CLX, CSi, CSX EV/KR 2.0 8/16V CLi, Exec. AAL	1.6 CSL ACG 1.8 CLX/ CSX ACH 2.0 CLi, Exec. 2E 2.8 VR6 Exec. AAA
YEARS		2013-	80-85	85-92	92-99
Front Wheel Bearing	- Inner	<b>HUB177</b> [288mm Disc] [with integrated ABS sensor] <b>HUB259</b> [312mm Disc] [with integrated ABS sensor]	<b>309726</b>	<b>311309</b> [85-88] <b>311443</b> [88-92]	<b>311443</b>
	- Outer				
Front Wheel Oil Seal	- Inner	HUB UNIT	Sealed Bearing	Sealed Bearing	Sealed Bearing
	- Outer				
Front Wheel Kit		<b>PQ664</b> [36 Spline][3 Mount Holes] <b>PQ846</b> [312mm Disc] GTi	<b>PQ107</b>	<b>PQ169</b> [85-88] <b>PQ167</b> [88-92]	<b>PQ167</b>
Front Wheel Hub / Stub Axle			<b>107HUB</b> <b>SA107L/R</b>	<b>169HUB</b> [Bearing ID:35mm] <b>167HUB</b> [Bearing ID:40mm]	<b>167HUB</b> [Bearing ID: 40mm] <b>167AHUB</b> [VR6] [Bearing ID: 40mm]
Alternator / Generator Bearing	- Front		<b>62032RS</b>	<b>62032RS</b>	<b>62032RS</b> <b>6203ZZ</b> [1.8]
	- Rear		<b>62012RS</b>	<b>62012RS</b>	<b>62012RS</b> <b>6201ZZ</b> [1.8]
Concentric / Thurst Bearing		<b>RB9680</b> [1.2, 1.4] <b>RB9855</b> [1.4 Alt., 2.0TDi]	<b>RB9574</b>	<b>RB9574</b> <b>RB9855</b> [2.0]	<b>RB9574</b> <b>RB9855</b> [2.8]
Diff Carrier Bearing	- Left		<b>29710+49</b> <b>330757</b> [1.3]	<b>29710+49</b> <b>300811+49</b> [2.0]	<b>29710+49</b> <b>300811+49</b> [2.8]
	- Right		<b>29710+49</b> <b>330757</b> [1.3]	<b>29710+49</b> <b>300811+49</b> [2.0]	<b>29710+49</b> <b>300811+49</b> [2.8]
Diff Pinion Bearing	- Front		<b>361895</b> [Left] [1.3] <b>331274</b> [Left] <b>330757C/VQ051</b> [Centre]	<b>331274</b> [Left Man.] <b>67010+48</b> [Left Auto.] <b>330757C/VQ051</b> [Centre]	<b>331274</b> [Left Man.] <b>67010+48</b> [Left Auto.] [1.6, 1.8]
	- Rear		<b>492179</b> [Right] [1.3] <b>330757</b> [Right Man.] <b>67010+48</b> [Right Auto.]	<b>330757</b> [Right Man.] <b>67010+48</b> [Right Auto.]	<b>67010+48</b> [Right] [1.6, 1.8]
Spigot Shaft Bearing			<b>VW Bush</b>		
Drive Shaft Oil Seal	- Left		<b>9770</b> [Kit]	<b>9770</b> [Kit] <b>9829</b> [2.0]	<b>9770</b> [Kit] <b>9829</b> [2.8]
	- Right		<b>9770</b> [Kit]	<b>9770</b> [Kit] <b>9829</b> [2.0]	<b>9770</b> [Kit] <b>9829</b> [2.8]
Gearbox Oil Seal	- Front		<b>223507</b> [1.3] <b>224008</b>	<b>224008</b> [Man.] <b>9830</b> [Auto.] <b>9856</b> [Pushrod]	<b>224008</b> [Man.] <b>9830</b> [Auto.] <b>9856</b> [Pushrod] <b>9865</b> [2.8]
	- Rear				
Pinion Oil Seal			<b>233506</b>	<b>233506</b> [Man.] <b>9845</b> [Auto.]	
Rear Main Bearing Oil Seal		<b>9586FS</b> [2.0TDi] <b>9589FS</b> [1.2, 1.4]	<b>8510512</b>	<b>8510512</b>	<b>8510512</b>
Timing Cover / Cam Oil Seal		<b>9587FS</b> [T/cover 2.0TDi] <b>9588</b> [T/cover 1.2, 1.4] <b>9548</b> [Cam 2.0TDi] <b>9590</b> [Cam 1.2, 1.4 Trans. Side] <b>9592FS</b> [Cam 1.2, 1.4 Timing Side]	<b>324710</b> [Cam,T/Cover, Intermed. Shaft]	<b>324710</b> [Cam,T/Cover, Intermed. Shaft]	<b>324710</b> [Cam,T/Cover, Intermed. Shaft]
Rear Wheel Bearing	- Inner	<b>HUB100</b> [with integrated ABS sensor] <b>HUB258</b> [288mm Disc] [with integrated ABS sensor]	<b>331274</b>	<b>331274</b>	<b>331274</b>
	- Outer		<b>11710+49</b>	<b>11710+49</b>	<b>11710+49</b>
Rear Wheel Oil Seal	- Inner	HUB UNIT			
	- Outer		<b>405208SP</b>	<b>405208SP</b>	<b>405208SP</b>
Rear Wheel Kit		<b>PQ691</b> [ID: 30mm][5 Studs] <b>PQ845</b> [ID: 29mm] [Disc OD: 288mm] [3 Holes]	<b>PQ108</b>	<b>PQ108</b>	<b>PQ108</b>
Rear Wheel Hub / Stub Axle			<b>SA108</b>		

APPLICATIONS		LOCATION	VW JETTA IV 1.6i Comfortline, Std. AKL 1.8T Highline, Exec AGU 1.9 TDi Highline AHF 2.0i Highline APK 2.3 V5 AGZ	VW JETTA V 1.4TSi [09-11] 1.6TDi [09-11] 1.6i Comfortline, Tiptronic, Trendline 1.9TDi Comfortline, Comfortline DSG	VW JETTA V 2.0i Trendline, Comfortline 2.0FSi Sportline, 2.0 T FSi Sportline DSG, 2.0TDi Sportline	VW JETTA VI 1.2TSi 1.4TSi 1.6TDi 2.0TDi
YEARS			99-06	2006-	2006-	2011-
Front Wheel Bearing	- Inner		<b>40BWD06</b>	<b>HUB108</b> [288mm Disc] [with integrated ABS sensor]	<b>HUB108</b> [288mm Disc] [with integrated ABS sensor]	<b>HUB108</b> [288mm Disc] [with integrated ABS sensor]
	- Outer					
Front Wheel Oil Seal	- Inner		Sealed Bearing	HUB UNIT	HUB UNIT	HUB UNIT
	- Outer					
Front Wheel Kit			<b>PQ449</b>	<b>PQ688</b> [ID: 29mm] [4 Mount Holes]	<b>PQ688</b> [ID: 29mm] [4 Mount Holes]	<b>PQ688</b> [ID: 29mm] [4 Mount Holes]
Front Wheel Hub / Stub Axle			<b>449HUB</b> [ABS Gear] [OD: 133mm]			
Alternator / Generator Bearing	- Front					
	- Rear					
Concentric / Thrust Bearing			<b>RB9574</b> [1.6] <b>RB9855</b> [1.8, 1.9, 2.0] <b>Concentric Slave Cylinder</b> [2.3]	<b>Concentric Slave Cylinder</b> [1.6] <b>RB9855</b> [1.9]	<b>Concentric Slave Cylinder</b> [Diesel] <b>RB9855</b> [Petrol]	<b>RB9680</b> [1.2] <b>RB9640</b> [MQ200 Trans.] <b>RB9855</b> [1.4 MQ250 Trans., 1.6TDi] <b>Concentric Slave Cylinder</b> [TDi -11] [TDi 11-]
Diff Carrier Bearing	- Left		<b>501310+49</b> [Man.] <b>300811+49</b> [Auto.]	<b>300811+49</b>	<b>503310+49</b> [Man.] <b>300811+49</b> [Tipt., DSG]	
	- Right		<b>501310+49</b> [Man.] <b>300811+49</b> [Auto.]	<b>VWDC386518</b> [1.6] <b>300811+49</b> [1.9]	<b>300811+49</b> [Tipt., DSG] <b>VWDC386518</b> [Man. 5 Spd.] <b>VWDC487618</b> [Man. 6 Spd.]	
Diff Pinion Bearing	- Front		<b>331274</b> [Left]			
	- Rear					
Propshaft Support Bearing						
Pulley Bearing						
Spigot Shaft Bearing						
V-Belt Tensioner			<b>VBT001</b> [1.6, 1.8T, 2.0]			<b>VBT012</b> [1.4]
Drive Shaft Oil Seal	- Left		<b>506508</b> [1.6] <b>9302</b> [1.8, 1.9, 2.0, 2.3]	<b>607408</b> [Man.] <b>486208</b> [Tiptronic]	<b>607408</b> [Man.] <b>486208</b> [Tipt., DSG]	
	- Right		<b>506508</b> [1.6] <b>9302</b> [1.8, 1.9, 2.0, 2.3]	<b>506508</b> [Man.] <b>486208</b> [Tiptronic]	<b>506508</b> [Man.] <b>486208</b> [Tipt., DSG]	
Gearbox Oil Seal	- Front		<b>244008</b> [Man. 1.6] <b>223507</b> [Man. 1.8, 1.9, 2.0, 2.3] <b>9875</b> [Auto.]	<b>243806</b> [5 Spd.] <b>223507</b> [Alt. 5 Spd.] <b>284207</b> [6 Spd.]	<b>243806</b> [5 Spd.] <b>223507</b> [Alt. 5 Spd.] <b>284207</b> [6 Spd.]	
	- Rear		<b>345208</b>			
Pinion Oil Seal			<b>345208</b> [Auto. only]			
Spark Plug Tube Seal						
Rear Main Bearing Oil Seal			<b>8510512</b> [99-03] <b>9945FS</b> [03-05]	<b>9231FS</b> [1.6] <b>9229FS</b> [1.9]	<b>9229FS</b> [Diesel] <b>9232FS</b> [Petrol]	<b>9573FS</b> [1.2, 1.4] <b>9580FS</b> [1.9, 2.0TDi]
Timing Cover / Cam Oil Seal			<b>9548</b> [Cam] <b>9549</b> [T/cover]	<b>9548</b> [Cam] <b>9549</b> [T/cover]	<b>9548</b> [Cam] <b>9549</b> [T/cover]	<b>9548</b> [Cam] <b>9549</b> [T/cover]
Rear Wheel Bearing	- Inner		<b>HUB102</b> [Non ABS] <b>HUB095</b> [with ABS pulse ring]	<b>HUB100</b> [with integrated ABS sensor] <b>HUB109</b> [with integrated ABS sensor]	<b>HUB100</b> [with integrated ABS sensor] <b>HUB109</b> [with integrated ABS sensor]	<b>HUB100</b> [with integrated ABS sensor] <b>HUB109</b> [with integrated ABS sensor]
	- Outer					
Rear Wheel Oil Seal	- Inner		HUB UNIT	HUB UNIT	HUB UNIT	HUB UNIT
	- Outer					
Rear Wheel Kit			<b>PQ684</b> [5 Studs] <b>PQ450</b> [5 Studs]	<b>PQ691</b> [ID: 30mm] [5 Studs] <b>PQ689</b> [ID: 32mm] [5 Holes]	<b>PQ691</b> [ID: 30mm] [5 Studs] <b>PQ689</b> [ID: 32mm] [5 Holes]	<b>PQ691</b> [ID: 30mm] [5 Studs] <b>PQ689</b> [ID: 32mm] [5 Holes]
Rear Wheel Hub / Stub Axle			<b>SA450</b>			

APPLICATIONS	LOCATION	VW KOMBI T2	VW KOMBI T3 4X2	VW KOMBI T3	VW KOMBI T3
		2.0, L Exec., Microbus, Kamper, P/up, P/van CU, CJ Pet. T3 1.9 Microbus, P/van DG Pet.	2.1 Fi Caravelle, Microbus DJ Pet. 2.3i Microbus, Volksiebus AFU Pet. 2.5i Microbus, Caravelle AAY Pet. 2.6i Microbus, Caravelle, Exclusive, ADV Pet.	4X4 2.1 Fi Syncro Caravelle DJ Pet.	1.8 P/van, GUS, Volksiebus AAX Pet.
YEARS		75-89	85-04	89-93	89-99
Front Wheel Bearing	- Inner	300811+49	300811+49	305988	300811+49
	- Outer	11910+49 [75-83] 12710+49 [84-89]	12710+49		12710+49
Front Wheel Oil Seal	- Inner	9417	9417	Sealed Bearing	9417
	- Outer				
Front Wheel Kit		PQ180 [75-83] PQ181 [84-89]	PQ181	PQ458	PQ181
Front Wheel Hub / Stub Axle					
Alternator / Generator Bearing	- Front	62022RS	62022RS	62022RS	6203ZZ
	- Rear	62012RS	62012RS	62012RS	
Concentric / Thurst Bearing		RB9571	RB9571	RB9571	RB9571
Diff Carrier Bearing	- Left	32010X [Man.] 300811+49 [Auto.]	32010X [Man.] 300811+49 [Auto.]	32010X [Man.] 300811+49 [Auto.]	32010X [Man.] 300811+49 [Auto.]
	- Right	32010X [Man.] 300811+49 [Auto.]	32010X [Man.] 300811+49 [Auto.]	32010X [Man.] 300811+49 [Auto.]	32010X [Man.] 300811+49 [Auto.]
Diff Pinion Bearing	- Front	86610+49 [Auto.]	86610+49 [Auto.]	86610+49 [Auto.]	
	- Rear	86610+49 [Auto.]	86610+49 [Auto.]	86610+49 [Auto.]	
Propshaft Support Bearing					
Pulley Bearing					
Spigot Shaft Bearing					
V-Belt Tensioner					
Drive Shaft Oil Seal	- Left	457215 [Man.] 456008 [Auto.]	457215 [Man.] 456008 [Auto.]	457215 [Man.] 456008 [Auto.]	457215
	- Right	457215 [Man.] 456008 [Auto.]	457215 [Man.] 456008 [Auto.]	457215 [Man.] 456008 [Auto.]	457215
Gearbox Oil Seal	- Front	224016	224016 [Man.] 425507 [Auto.]	224016 [Man.] 425507 [Auto.]	224016
	- Rear				
Pinion Oil Seal			304207 [Auto. Front] 385407 [Auto. Rear]	304207 [Auto. Front] 385407 [Auto. Rear]	304207 [Auto. Front] 385407 [Auto. Rear]
Rear Main Bearing Oil Seal		759512	759512 [2.1] 9945FS	759512	9945FS
Timing Cover / Cam Oil Seal		426210 [T/Cover 2.0] 486810 [T/Cover 1.9]	486810 [T/Cover] [2.1] 9548 [Cam] 9549 [T/covers]	486810 [T/Cover]	324710 [Cam, T/Cover, Intermed. Shaft]
Rear Wheel Bearing	- Inner	6207C3	6207C3	6207C3	6207C3
	- Outer	308+203	308+203	308+203	308+203
Rear Wheel Oil Seal	- Inner	487279	487279	487279	487279
	- Outer	487279	487279	487279	487279
Rear Wheel Kit		PQ182	PQ182	PQ182	PQ182
Rear Wheel Hub / Stub Axle					

APPLICATIONS	LOCATION	VW KOMBI T4	VW KOMBI T5	VW KOMBI T5	VW PASSAT I & II
		2.5Tdi Microbus, Caravelle, Trend, High ACV, AAB Dies., Turbo Dies.	1.9TDi Beach, Van, P/van, S/Cab P/up SWB, D/Cab P/up LWB, Crew Bus AXC Dies. 2.5TDi Beach, California, Caravelle, 96/128, S/Cab, D/cab, HO P/up SWB/ LWB P/up, Crew Bus P/van, Van, AXD Dies. 3.2 Caravelle, S/Cab, D/ cab P/up BDL	2.0TDi 2.0 BitDi	1.3 L, LS H/back, Sedan, Variant ZF 1.5 GL, LS Fastback, S/W CK 1.6 GL, GLS, LS, LX Fastback, S/W, Sedan, Coupe, Variant, YN/YP/ WN 1.8 CL Sedan, S/W JV/ KR
YEARS		99-06	04-10	2010-	74-87
Front Wheel Bearing	- Inner	DAC458045	HUB114 [with integrated ABS sensor]	HUB114 [with integrated ABS sensor]	309396
	- Outer				
Front Wheel Oil Seal	- Inner	Sealed Bearing	HUB UNIT	HUB UNIT	Sealed Bearing
	- Outer				
Front Wheel Kit		PQ496	PQ705 [5 Holes]	PQ705 [5 Holes]	PQ139
Front Wheel Hub / Stub Axle		496HUB			
Alternator / Generator Bearing	- Front				62032RS
	- Rear				62012RS
Concentric / Thurst Bearing		RB9855 [AAB] Concentric Slave Cylinder [Hyd. Assy. ACV]	RB9855 [1.9] Concentric Slave Cylinder [Hyd. Assy - 2.5, 3.2]	RB9855 [Alt.] Concentric Slave Cylinder	RB9571
Diff Carrier Bearing	- Left	503310+49	32010		29710+49 [Man.] 300811+49 [Auto.]
	- Right	503310+49	32010		29710+49 [Man.] 300811+49 [Auto.]
Diff Pinion Bearing	- Front				316697C [Left Man.] 86610+49 [Left Auto.]
	- Rear				305862CA [Right Man. 74-81] 332286B [Right Man. 81-87] 86610+49 [Right Auto.]
Propshaft Support Bearing					
Pulley Bearing					
Spigot Shaft Bearing					
V-Belt Tensioner					
Drive Shaft Oil Seal	- Left	456008	607408 [5 & 6 Spd.] 9239 [Rr.] [2.5 4X4]		405209 [Man.] 456008 [Auto.]
	- Right	456008	506508 [5 Spd.] 607408 [6 Spd.] 9240 [Rr.] [2.5 4X4]		405209 [Man.] 456008 [Auto.]
Gearbox Oil Seal	- Front	223507	223507 [5 Spd.] 304608 [6 Spd.]		203510SP
	- Rear	456510			
Pinion Oil Seal					9759 [81-87]
Spark Plug Tube Seal					
Rear Main Bearing Oil Seal		9945FS	9945FS [1.9, 2.5] 8510511 [3.2]	9580FS	8510512
Timing Cover / Cam Oil Seal		9548 [Cam] 9549 [T/cover]	9548 [Cam] 9549 [T/cover]	9548 [Cam] 9549 [T/cover]	324710 [Cam, T/Cover]
Rear Wheel Bearing	- Inner	DAC458045	HUB116	HUB114 [with integrated ABS sensor]	331274
	- Outer				11710+49
Rear Wheel Oil Seal	- Inner	Sealed Bearing	HUB UNIT	HUB UNIT	
	- Outer				405208SP
Rear Wheel Kit		PQ496A	PQ707	PQ705 [5 Holes]	PQ108
Rear Wheel Hub / Stub Axle		496HUB			



APPLICATIONS	LOCATION	VW PASSAT I & II	VW PASSAT IV	VW PASSAT IV	VW PASSAT IV
		1.9 GLS H/back, GLX Sedan, S/W WN 2.2 CLi, CLX SG/MX	1.8T AEB	2.3 V5 AZX	2.8, 4 Motion, Quattro, Tiptronic ACK/ AMX 3.2 V6 Sportline DSG AXZ
YEARS		81-87	99-05	03-05	99-05
Front Wheel Bearing	- Inner	309396	633817	HUB110	633816 [2.8] 633817 [3.2]
	- Outer				
Front Wheel Oil Seal	- Inner	Sealed Bearing	Sealed Bearing	HUB UNIT	Sealed Bearing
	- Outer				
Front Wheel Kit		PQ139	PQ434	PQ693 [4 Mount holes]	PQ433 [2.8] PQ434 [3.2]
Front Wheel Hub / Stub Axle			434HUB [Bearing ID: 43mm]		433HUB [Bearing ID: 39mm] 434HUB [Bearing ID: 43mm]
Alternator / Generator Bearing	- Front	62032RS			
	- Rear	62012RS			
Concentric / Thurst Bearing		RB9571	RB9854	RB9854	RB9854 [2.8]
Diff Carrier Bearing	- Left	501310+49 [Man.] 29710+49 [Auto.]	503310+49	300811+49	300811+49 [Fr. & Rr. Axle 2.8] 32010 [Fr. Axle 3.2] 501310+49 [Rr. Axle 3.2]
	- Right	501310+49 [Man.] 29710+49 [Auto.]	503310+49	300811+49	300811+49 [Fr. & Rr. Axle 2.8] 32010 [Fr. Axle 3.2] 501310+49 [Rr. Axle 3.2]
Diff Pinion Bearing	- Front	316697C [Left Man.] 86610+49 [Left Auto.]			VWFP087A [Rr. Axle 2.8]
	- Rear	305862CA [Right Man. 1.9] 332286B [Right Man. 2.2] 88010/48 [Right Auto.]			VWRP1831 [Rr. Axle 2.8]
Propshaft Support Bearing					
Pulley Bearing					
Spigot Shaft Bearing					
V-Belt Tensioner			VBT003		
Drive Shaft Oil Seal	- Left	405209 [Man.] 456008 [Auto.]	456008	456008 9235 [Alt.]	456008 [Fr. 99-02] 9235 [Fr. 02-05]
	- Right	405209 [Man.] 456008 [Auto.]	456008	9770 9234 [Alt.]	456008 [Fr. 99-02] 9234 [Fr. 02-05]
Gearbox Oil Seal	- Front	9757	9924	9757 9233 [Alt.]	9924
	- Rear				
Pinion Oil Seal		9759			324710 [Rr. Axle 2.8]
Spark Plug Tube Seal					
Rear Main Bearing Oil Seal		8510512	9945FS [Man.] 8510512 [Auto.]	8510511	9997FS [Kit]
Timing Cover / Cam Oil Seal		324710 [Cam, Intermediate Shaft] 354810 [T/Cover]	9548 [Cam, T/Cover]	9548 [Cam] 9549 [T/covers]	9548 [Cam] 9549 [T/covers]
Rear Wheel Bearing	- Inner	331274	633816	HUB111 [Flange Ø: 130.8mm] [with integrated ABS sensor]	633816 [2.8] HUB112 [3.2]
	- Outer	11710+49			
Rear Wheel Oil Seal	- Inner			HUB UNIT	Sealed Bearing [2.8] HUB UNIT
	- Outer	405208SP			
Rear Wheel Kit		PQ108	PQ433	PQ736 [5 Holes]	PQ433 [2.8] PQ737 [3.2]
Rear Wheel Hub / Stub Axle			433HUB [Bearing ID: 39mm]		433HUB [Bearing ID: 39mm]

APPLICATIONS	LOCATION	VW PASSAT V	VW PASSAT B7	VW POLO 6N	VW POLO 9N
		1.9TDi Comfortline AVB 2.0FSi Comfortline, Tipt., Highline BCR BLY 2.0 T FSi Sportline Tiptronic AXX/BPY 2.0TDi Highline, DSG BKP/BMP 3.2 V6 Auto. DSG [05-10]	1.8TSi 2.0TSi 2.0TDi	1.4 Classic, Playa Lux AEX 1.6 Classic, Playa, Lux AEE 1.8 Classic, Playa, Lux ADZ	1.4TDi, Classic, Trendline AMF 1.4TDi Classic, Trendline ARC 1.4i Trendline, Comfortline, AUA/ BBY, BLM 1.6i Comfortline, SE, Classic Comfortline, Tipt Trendline, Classic Lux BTS/ AFV, BAH 1.8T GTi, Classic Trendline AKK
YEARS		05-11	08-11	96-03	02-10
Front Wheel Bearing	- Inner	HUB110	HUB108 [288mm Disc] [with integrated ABS sensor]	311316 [1.4, 1.6] 311443 [1.8]	HUB103 [with integrated ABS sensor]
	- Outer				
Front Wheel Oil Seal	- Inner	HUB UNIT	HUB UNIT	Sealed Bearing	HUB UNIT
	- Outer				
Front Wheel Kit		PQ693 [4 Mount holes]	PQ688 [ID: 29mm] [4 Mount Holes]	PQ440 [1.4, 1.6] PQ167 [1.8]	PQ701 [72mm]
Front Wheel Hub / Stub Axle				440HUB 167HUB	
Alternator / Generator Bearing	- Front			62032RS [1.4, 1.6] 6203ZZ [1.8]	
	- Rear			62012RS [1.4, 1.6] 6201ZZ [1.8]	
Concentric / Thurst Bearing		RB9854	RB9855 [1.8TSi] Concentric Slave Cylinder [2.0TSi, TDi]	RB9574	RB9680 [with guide sleeve] RB9855 [Diesel & 1.8GTi] Concentric Slave Cylinder [Petrol – To job 7045070]
Diff Carrier Bearing	- Left	501310+49		300811+49	300811+49
	- Right	32010 [5 Spd.] 300811+49 [6 Spd.]		300811+49	300811+49 VWDC386518 [Some mod.]
Diff Pinion Bearing	- Front				
	- Rear				
V-Belt Tensioner		VBT001 [2.0FSi]		VBT001 [1.6]	VBT001 [1.8 GTi]
Drive Shaft Oil Seal	- Left	456008 9235 [Alt. Auto.]		9770 [Kit 1.6]	607408
	- Right	456008 [Man.] 9770 [Auto.] 9234 [Alt. Auto.]		9770 [Kit 1.6]	506508
Gearbox Oil Seal	- Front	9757 9233 [Alt.]		9905	243806 223507 [Alt.]
	- Rear				
Rear Main Bearing Oil Seal		9945FS [Diesel] 9232FS [Petrol]	9229FS [2.0TSi] 9580FS [2.0TDi -11] 9582FS [1.8TSi, 2.0TDi 11-]	9945FS	9945FS [Diesel, 1.8GTi] 9237FS Alt. 9199FS [1.4, 1.6]
Timing Cover / Cam Oil Seal		9548 [Cam] 9549 [T/cover]	456008 [T/Cover 2.0TSi, TDi] 9548 [Cam 2.0TSi, TDi -11] 9549 [T/Cover 1.8TSi, 2.0TDi]	9548 [Cam, T/Cover]	9236 [T/Cover 1.6] 9238 [Cam 1.6] 9548 [Cam Diesel, 1.8GTi] 9549 [T/Cover Diesel, 1.8GTi]
Rear Wheel Bearing	- Inner	HUB111 [Flange Ø: 130.8 mm] [with integrated ABS sensor]	HUB109 [with integrated ABS sensor]	331274	HUB106 [with integrated ABS sensor] HUB363 [with integrated ABS sensor]
	- Outer			11710+49	
Rear Wheel Oil Seal	- Inner	HUB UNIT	HUB UNIT		HUB UNIT
	- Outer			405208SP	
Rear Wheel Kit		PQ736 [5 Holes]	PQ689 [ID: 32mm] [5 Holes]	PQ108	PQ702 [5 Hole] PQ1065 [1.6 TDi]
Rear Wheel Hub / Stub Axle					SA702



APPLICATIONS	LOCATION	VW POLO 9N	VW POLO VIVO	VW POLO 6R	VW POLO
		1.9TDi Highline, Classic Highline, Sportline, ATD/AXR 2.0i Highline, Classic Highline BBX Cross Polo [07-10] 1.6TDi 1.9TDi	1.4 CLPA, CLPB 1.6 CLSA	1.2TDi CFWA 1.4 CLSA, CLPB 1.4TSi GTI CTHE 1.6 CLSA 1.6TDi [09-15]	1.2 Trendline DSG Petrol CBZB 1.2 Man. CGPA/ CGPB [10-15] 1.2TSi Comfortline Man. CBZC [2013-]
YEARS		02-10	2010-	10-15	2011-
Front Wheel Bearing	- Inner	HUB103 [with integrated ABS sensor]	HUB103 [with integrated ABS sensor]	HUB103 [with integrated ABS sensor]	HUB103 [with integrated ABS sensor]
	- Outer				
Front Wheel Oil Seal	- Inner	HUB UNIT	HUB UNIT	HUB UNIT	HUB UNIT
	- Outer				
Front Wheel Kit		PQ701 [72mm]	PQ701 [72mm]	PQ701 [72mm]	PQ701 [72mm]
Front Wheel Hub / Stub Axle					
Alternator / Generator Bearing	- Front				
	- Rear				
Concentric / Thurst Bearing		RB9680 [with guide sleeve] RB9855 [Diesel] Concentric Slave Cylinder		RB9680 [Petrol] RB9855 [Diesel]	
Diff Carrier Bearing	- Left	300811+49			
	- Right	300811+49 VWDC386518 [Some mod.]			
Diff Pinion Bearing	- Front				
	- Rear				
Propshaft Support Bearing					
Pulley Bearing					
Spigot Shaft Bearing					
V-Belt Tensioner			VBT012	VBT012	
Drive Shaft Oil Seal	- Left	607408			
	- Right	506508			
Gearbox Oil Seal	- Front	243806 223507 [Alt.]			
	- Rear				
Rear Main Bearing Oil Seal		9229FS [Plug in sensor] 9573FS [1.6TDi CrossPolo] 9945FS		9573FS [Petrol]	
Timing Cover / Cam Oil Seal		9548 [Cam] 9549 [T/Cover]		9236 [OD: 42mm] [T/Cover 1.4] 9238 [Cam 1.4] 9548 [Cam 1.2TDi] 9549 [OD: 48mm] [T/Cover 1.2TDi, 1.4 Alt., 1.6]	
Rear Wheel Bearing	- Inner	HUB102 [Non ABS] HUB106 [with integrated ABS sensor] HUB363 [with integrated ABS sensor]	HUB106 [with integrated ABS sensor] HUB363 [with integrated ABS sensor]	HUB106 [with integrated ABS sensor]	HUB095 [with integrated ABS sensor] HUB106 [with integrated ABS sensor]
	- Outer				
Rear Wheel Oil Seal	- Inner	HUB UNIT	HUB UNIT	HUB UNIT	HUB UNIT
	- Outer				
Rear Wheel Kit		PQ450 [1.6TDi CrossPolo Alt.] PQ702 [5 Hole] PQ1065 [ID: 28mm]	PQ702 [5 Hole] PQ1065 [ID: 28mm]	PQ702 [5 Hole]	PQ450 PQ702
Rear Wheel Hub / Stub Axle		SA702	SA702	SA702	SA450 SA702

APPLICATIONS	LOCATION	VW POLO 6C / GP 1.0TSi CHZB, CHYA, CHYB 1.2TSi CJZC/ CJZD 1.4 CDDA/ CGGB/ CLPA 1.4TDi CUTA/ CYZB 1.5TDi CWXC, CWXB 1.6TDi CLSA 1.8TSi GTi DAJA	VW POLO VI (AW1, BZ1) 1.0 TSi CHZL, DKLA 1.6 TDi DGTC, DGTD 2.0 GTi CZPC, DKZC	VW POLO "VIVO" GT 1.0 TSi CHZC	VW SCIROCCO 1.4TSi 2.0TSi, DSG 2.0TSi R
YEARS		2014-	2016-	2018-	2009-
Front Wheel Bearing	- Inner	<b>309639ASB</b> <b>HUB103</b> [with integrated ABS sensor]	<b>HUB103</b> [with integrated ABS sensor] <b>HUB412</b> [with integrated ABS sensor]	<b>HUB103</b> [with integrated ABS sensor]	<b>HUB177</b> [288mm Disc] [with integrated ABS sensor] <b>HUB108</b> [288mm Disc] [with integrated ABS sensor]
	- Outer				
Front Wheel Oil Seal	- Inner	Sealed Bearing HUB UNIT	HUB UNIT	HUB UNIT	HUB UNIT
	- Outer				
Front Wheel Kit		<b>PQ499</b> <b>PQ701</b> [72mm]	<b>PQ701</b> [72mm] <b>PQ1146</b> [78mm]	<b>PQ701</b> [72mm]	<b>PQ664</b> [36 Spline] [3 Mount Holes] <b>PQ688</b> [ID: 29mm] [4 Mount Holes]
Front Wheel Hub / Stub Axle					
Alternator / Generator Bearing	- Front				
	- Rear				
Concentric / Thrust Bearing		<b>RB9855</b> [Diesel]			<b>Concentric Slave Cylinder</b>
Diff Carrier Bearing	- Left				<b>503310+49</b> [Man.] <b>300811+49</b> [Tiptronic, DSG]
	- Right				<b>300811+49</b> [Tipt., DSG] <b>VWDC386518</b> [Man. 5 Spd.] <b>VWDC487618</b> [Man. 6 Spd.]
Diff Pinion Bearing	- Front				
	- Rear				
Propshaft Support Bearing					
Pulley Bearing					
Spigot Shaft Bearing					
V-Belt Tensioner					
Drive Shaft Oil Seal	- Left				<b>607408</b> [Man.] <b>486208</b> [Tiptronic, DSG]
	- Right				<b>506508</b> [Man.] <b>486208</b> [Tiptronic, DSG]
Gearbox Oil Seal	- Front				<b>243806</b> [5 Spd.] <b>223507</b> [Alt. 5 Spd.] <b>284207</b> [6 Spd.]
	- Rear				
Rear Main Bearing Oil Seal		<b>9580FS</b> [1.6TDi]			<b>9573FS</b> [1.4TSi] <b>9582FS</b> [2.0TSi] <b>9945FS</b> [2.0R]
Timing Cover / Cam Oil Seal		<b>9548</b> [Cam 1.6TDi] <b>9549</b> [T/Cover 1.6TDi]			<b>456008</b> [T/cover 2.0TSi] <b>9548</b> [Cam 2.0R] <b>9549</b> [T/cover 1.4TSi, 2.0R]
Rear Wheel Bearing	- Inner	<b>HUB106</b> [with integrated ABS sensor] <b>HUB363</b> [with integrated ABS sensor]	<b>HUB106</b> [with integrated ABS sensor] <b>HUB363</b> [with integrated ABS sensor]	<b>HUB106</b> [with integrated ABS sensor]	<b>HUB100</b> [with integrated ABS sensor] <b>HUB109</b> [with integrated ABS sensor]
	- Outer				
Rear Wheel Oil Seal	- Inner	HUB UNIT	HUB UNIT	HUB UNIT	HUB UNIT
	- Outer				
Rear Wheel Kit		<b>PQ702</b> [5 Hole] <b>PQ1065</b> [ID: 28mm]	<b>PQ702</b> <b>PQ1065</b>	<b>PQ702</b>	<b>PQ691</b> [ID: 30mm] [5 Studs] <b>PQ689</b> [ID: 32mm] [5 Holes]
Rear Wheel Hub / Stub Axle		<b>SA702</b>	<b>SA702</b>	<b>SA702</b>	

APPLICATIONS	LOCATION	VW SHARAN	VW TIGUAN 4X2	VW TIGUAN 4X4	VW TIGUAN 4X4
		1.8T MPV AJH 1.9TDi MPV ASZ, 2.8 MPV AAA	1.4TSi Trend & Fun 5Dr. SUV 2.0TSi 2.0TDi	1.4TSi Track & Field, Trend & Fun 5Dr. SUV	2.0TSi Track & Field, Sport & Style Man., Tiptronic 5Dr. SUV, 2.0TDi Track & Field, Sport & Style Man., Tiptronic 5Dr. SUV
YEARS		99-08	08-17	08-17	08-17
Front Wheel Bearing	- Inner	VWS1999	HUB177 [288mm Disc] [with integrated ABS sensor] HUB108 [288mm Disc] [with integrated ABS sensor]	HUB108 [with integrated ABS sensor]	HUB108 [288mm Disc] [with integrated ABS sensor]
	- Outer				
Front Wheel Oil Seal	- Inner	Sealed Bearing	HUB UNIT	HUB UNIT	HUB UNIT
	- Outer				
Front Wheel Kit		PQ513	PQ664 [36 Spline] [3 Mount Holes] PQ688 [ID: 29mm] [4 Mount Holes]	PQ688 [ID: 29mm] [4 Mount Holes]	PQ688 [ID: 29mm] [4 Mount Holes]
Front Wheel Hub / Stub Axle		513HUB			
Alternator / Generator Bearing	- Front				
	- Rear				
Concentric / Thurst Bearing		Concentric Slave Cylinder	RB9855	RB9855	Concentric Slave Cylinder
Diff Carrier Bearing	- Left	32008	503310+49	503310+49 [Fr.]	503310+49 [Man. Fr.] 300811+49 [Tiptronic, DSG Fr.]
	- Right	32008	VWDC386518	VWDC386518 [Fr.]	300811+49 [Tipt., DSG Fr.] VWDC38651 [Man. 5 Spd. Fr.] VWDC487618 [Man. 6 Spd. Fr.]
Diff Pinion Bearing	- Front	503310+49			
	- Rear	416359+147197			
Propshaft Support Bearing					
Pulley Bearing					
Spigot Shaft Bearing					
V-Belt Tensioner			VBT012 [1.4]		
Drive Shaft Oil Seal	- Left	456008	607408	607408 [Fr.]	607408 [Man. Fr.] 486208 [Tiptronic, DSG Fr.]
	- Right	456008 [1.8, 2.8] 607408 [1.9TDi]	506508	506508 [Fr.]	506508 [Man. Fr.] 486208 [Tiptronic, DSG Fr.]
Gearbox Oil Seal	- Front	223507	243806 223507 [Alt.]	243806 223507 [Alt.]	243806 [5 Spd.] 223507 [Alt. 5 Spd.] 284207 [6 Spd.]
	- Rear	456510			
Pinion Oil Seal					
Spark Plug Tube Seal					
Rear Main Bearing Oil Seal		9945FS [Kit 1.8T] 9229FS [1.9TDi] 9649 [2.8]	9237FS	9237FS	9229FS [Diesel] 9232FS [Petrol]
Timing Cover / Cam Oil Seal		9548 [Cam] 9549 [T/Cover] 9875 [Oilpump o/s]	9548 [Cam] 9549 [T/Cover]	9548 [Cam] 9549 [T/cover]	9548 [Cam] 9549 [T/cover]
Rear Wheel Bearing	- Inner	VWS1999	HUB100 [with integrated ABS sensor] HUB109 [with integrated ABS sensor]	HUB108 [with integrated ABS sensor]	HUB108 [288mm Disc] [with integrated ABS sensor]
	- Outer				
Rear Wheel Oil Seal	- Inner	Sealed Bearing	HUB UNIT	HUB UNIT	HUB UNIT
	- Outer				
Rear Wheel Kit		PQ514	PQ691 [ID: 30mm] [5 Studs] PQ689 [ID: 32mm] [5 Holes]	PQ688 [ID: 29mm] [4 Mount Holes]	PQ688 [ID: 29mm] [4 Mount Holes]
Rear Wheel Hub / Stub Axle		514HUB			

APPLICATIONS		LOCATION	VW TOUAREG 4X4 2.5TDi R5 SUV BAC/ BPE 3.0TDi SUV BKS 3.6 FSi SUV BHK/ BHL 4.2 FSi SUV AXQ 5.0TDi SUV AYH	VW TOURAN 1.9TDi TrendLine DSG MPV 2.0FSi HighLine MPV AXW 2.0TDi HighLine, DSG MPV	VW TOURAN 1.2TSi 1.4TSi 2.0TDi	VW UP 1.0 CHYB
YEARS			04-11	04-11	2011-	2015-
Front Wheel Bearing	- Inner		<b>HUB114</b> [2.5] [with integrated ABS sensor] <b>DAC51VWASB</b> [3.0, 3.6, 4.2, 5.0]	<b>HUB108</b> [288mm Disc] [with integrated ABS sensor]	<b>HUB108</b> [with integrated ABS sensor]	<b>DAC36UP</b>
	- Outer					
Front Wheel Oil Seal	- Inner		Sealed Bearing HUB UNIT	HUB UNIT	HUB UNIT	Sealed Bearing
	- Outer					
Front Wheel Kit			<b>PQ705</b> [2.5] [5 Holes] <b>PQ708</b> [3.0, 3.6, 4.2, 5.0]	<b>PQ688</b> [ID: 29mm] [4 Mount Holes]	<b>PQ688</b> [ID: 29mm] [4 Mount Holes]	<b>PQ1044</b>
Front Wheel Hub / Stub Axle			<b>708HUB</b>			<b>1044HUB</b>
Alternator / Generator Bearing	- Front					
	- Rear					
Concentric / Thrust Bearing			<b>RB9681</b>	<b>RB9680</b> [1.6] <b>RB9855</b> [2.0FSi] <b>Concentric Slave Cylinder</b>	<b>RB9680</b> [1.2TSi] <b>RB9588</b> [1.4TSi] <b>Concentric Slave Cylinder</b>	<b>RB9680</b>
Diff Carrier Bearing	- Left			<b>300811+49</b> [Man.] <b>503310+49</b> [Auto.]		
	- Right			<b>300811+49</b> [Man.] <b>VWDC487618</b> [Auto.]		
Diff Pinion Bearing	- Front					
	- Rear					
Propshaft Support Bearing						
Pulley Bearing						
Spigot Shaft Bearing						
V-Belt Tensioner				<b>VB001</b> [2.0FSi]		
Drive Shaft Oil Seal	- Left		<b>9243</b> [Fr.] <b>9245</b> [Rr. No Diff Lock] <b>9247</b> [Rr. With Diff Lock]	<b>607408</b> <b>547308</b> [Some mod.]		
	- Right		<b>9243</b> [Fr.] <b>9246</b> [Rr. With or W/o Diff Lock]	<b>607408</b> <b>486208</b> [Some mod.]		
Gearbox Oil Seal	- Front		<b>407009</b>	<b>243806</b> [5 Spd.] <b>223507</b> [Alt. 5 Spd.] <b>284207</b> [6 Spd.]		
	- Rear		<b>417209</b> [Man.] <b>417211</b> [Auto.]			
Pinion Oil Seal			<b>9244</b> [Rr. Axle]			
Rear Main Bearing Oil Seal			<b>9242</b> [2.5, 3.0] <b>9206FS</b> [3.6, 4.2]	<b>9228FS</b> [1.6, 2.0FSi, 2.0TDi] <b>9229FS</b> [1.9TDi]	<b>9573FS</b> [1.2, 1.4TSi] <b>9580FS</b> [2.0TDi]	<b>9589FS</b>
Timing Cover / Cam Oil Seal			<b>9548</b> [Cam] <b>9241</b> [T/Cover 2.5, 3.0] <b>9547</b> [T/Cover 3.6, 4.2] <b>637609</b> [T/Cover 5.0]	<b>9548</b> [Cam] <b>9549</b> [T/Cover]		<b>9588</b> [T/covers] <b>9590</b> [Cam G/Box Side] <b>9591</b> [Cam Timing Side]
Rear Wheel Bearing	- Inner		<b>DAC51VWASB</b> [All, except 5.0] <b>HUB114</b> [5.0] [with integrated ABS sensor]	<b>HUB109</b> [with integrated ABS sensor]	<b>HUB109</b> [with integrated ABS sensor]	<b>HUB349</b> [with integrated ABS sensor]
	- Outer					
Rear Wheel Oil Seal	- Inner		Sealed Bearing HUB UNIT	HUB UNIT	HUB UNIT	HUB UNIT
	- Outer					
Rear Wheel Kit			<b>PQ705</b> [5.0] [5 Holes] <b>PQ708</b> [All, except 5.0]	<b>PQ689</b> [ID: 32mm] [5 Holes]	<b>PQ689</b> [ID: 32mm] [5 Holes]	<b>PQ1045</b>
Rear Wheel Hub / Stub Axle			<b>708HUB</b>			

APPLICATIONS	LOCATION	VOLVO 850	VOLVO 960	VOLVO C30	VOLVO C70
		2.3 T-5S, R Sedan B5234 T2/ T4 2.4 GLT Sedan B5254S	2.9 Sedan B6304	1.6 Man. 1.8 Man. 2.0, R-Design, Powershift Man., Geartronic 2.5i T5, R-Design Man., Geartronic	2.3 Cabrio, Coupe B5234 T3/ T9
YEARS		94-97	94-97	08-13	99-06
Front Wheel Bearing	- Inner	HUB029	HUB031 HUB032 [with integrated ABS sensor] HUB036 [Non ABS]	HUB336 [with integrated ABS sensor]	HUB035
	- Outer				
Front Wheel Oil Seal	- Inner	HUB UNIT	HUB UNIT	HUB UNIT	HUB UNIT
	- Outer				
Front Wheel Kit		PQ515 [5 Studs]	PQ552 [Non ABS][4 Studs] PQ553 [5 Studs] [Flange Ø: 136mm] PQ557 [Non ABS]	PQ1031 [5 Studs]	PQ508 [5 Studs]
Front Wheel Hub / Stub Axle					
Alternator / Generator Bearing	- Front				
	- Rear				
Concentric / Thurst Bearing				Concentric Slave Cylinder	
Diff Carrier Bearing	- Left				
	- Right				
Diff Pinion Bearing	- Front				
	- Rear				
Propshaft Support Bearing					
Pulley Bearing					
Spigot Shaft Bearing					
V-Belt Tensioner					
Drive Shaft Oil Seal	- Left			9292 [OD: 65mm] 9293 [OD: 60mm]	
	- Right			9292 [OD: 65mm] 9293 [OD: 60mm]	
Gearbox Oil Seal	- Front			9294	
	- Rear				
Pinion Oil Seal					
Spark Plug Tube Seal					
Rear Main Bearing Oil Seal				9242 [D2] 9377FS [1.6] 9375FS [1.8, 2.0] 9975 [2.5]	9975
Timing Cover / Cam Oil Seal				9376 [1.6 - Cam] 274707 [Cam D2] 456507 [2.5 - Cam No. 1 Fr.] 516507 [2.5 - Cam No. 2 Fr.] 9626 [2.5 - Cam Rr.] 334705 [T/Cover 1.6] 9334 [T/Cover D2] 9378 [T/Cover 1.8, 2.0] 354706 [T/Cover 2.5]	354706 [T/Cover] 456507 [Cam No. 1 Fr.] 516507 [Cam No. 2 Fr.] 9626 [Cam1, 2 Rr.]
Rear Wheel Bearing	- Inner	HUB030 [Gear type ABS]	331459 [Rigid Axle] 309797 [Multi-Link Axle]	HUB120 [with integrated ABS sensor]	309797
	- Outer				
Rear Wheel Oil Seal	- Inner		9415 [Rigid Axle] Sealed Bearing [Multi-Link Axle]	HUB UNIT	Sealed Bearing
	- Outer				
Rear Wheel Kit		PQ617 [5 Studs] [Flange Ø: 136mm]	PQ554 [Rigid Axle] PQ618 [Multi-Link Axle]	PQ725 [5 Studs] [PCD: 108mm]	PQ618
Rear Wheel Hub / Stub Axle					

APPLICATIONS	LOCATION	VOLVO C70	VOLVO S40	VOLVO S40	VOLVO S60
		2.5T T5	2.0T 4Dr. Sedan B4204 T2/T3 V40 2.0T Estate B4204S	1.8 Sedan 2.0 Sedan 2.0D VS Sedan D4204T 2.4 VS D5 Sedan D5252 T16/ D5244 T3 2.4i B5244S4 2.5i D5 Sedan Man Geartronic	2.0T Turbo B5204T5 2.3 T5 B5234 T3 2.4 2.4T B5244T3 2.5T Turbo
YEARS		04-13	97-04	2004-	01-09
Front Wheel Bearing	- Inner	HUB075 HUB336 [with integrated ABS sensor]	DAC4080 [97-98] 633966 [98-04]	HUB336 [with integrated ABS sensor]	HUB075
	- Outer				
Front Wheel Oil Seal	- Inner	HUB UNIT	9545 [97-98] 9546 [97-98] Sealed Bearing [98-04]	HUB UNIT	HUB UNIT
	- Outer				
Front Wheel Kit		PQ509 [5 Studs] PQ1031 [5 Studs]	PQ507 [97-98] PQ506 [98-04]	PQ1031 [5 Studs]	PQ509 [5 Studs]
Front Wheel Hub / Stub Axle			506HUB		
Alternator / Generator Bearing	- Front				
	- Rear				
Concentric / Thurst Bearing		Concentric Slave Cylinder	Concentric Slave Cylinder	Concentric Slave Cylinder	Concentric Slave Cylinder
Diff Carrier Bearing	- Left				
	- Right				
Diff Pinion Bearing	- Front				
	- Rear				
Propshaft Support Bearing					
Pulley Bearing					
Spigot Shaft Bearing					
Drive Shaft Oil Seal	- Left			9292 [OD: 65mm] 9293 [OD: 60mm]	
	- Right			9292 [OD: 65mm] 9293 [OD: 60mm]	
Gearbox Oil Seal	- Front			9294	
	- Rear				
Pinion Oil Seal					
Rear Main Bearing Oil Seal		9975	9975	9979 [2.0D] 9242 [D2] 9375FS [1.8, 2.0 Pet.] 9975 [2.4, 2.5]	9975
Timing Cover / Cam Oil Seal		304707 [Cam] 455707 [Cam Alt.]	455707 [Cam Front] 9626 [Cam Rear] 354706 [T/Cover]	274707 [Cam D2] 456507 [Cam No.1 Fr. 2.4, 2.5] 516507 [Cam No.2 Fr. 2.4, 2.5] 9055 [Cam 2.0D] 9056 [T/Cover 2.0D] 9100 [Cam D4, D5] 9334 [T/Cover D2] 9626 [Cam Rr. 2.5] 9378 [T/Cover 1.8, 2.0 Pet.] 426207 [T/Cover 2.0D] 354706 [T/Cover 2.4, 2.5]	9100 [Cam 2.4 D5] 304707 [Cam x2] 456507 [Cam x1] 516507 [Cam x1] 354706 [T/Cover]
Rear Wheel Bearing	- Inner	HUB073 [with integrated ABS sensor] HUB120 [with integrated ABS sensor]	HUB033	HUB120 [with integrated ABS sensor] HUB282 [with integrated ABS sensor]	HUB073 [with integrated ABS sensor]
	- Outer				
Rear Wheel Oil Seal	- Inner	HUB UNIT	HUB UNIT	HUB UNIT	HUB UNIT
	- Outer				
Rear Wheel Kit		PQ510 [5 Studs] [PCD: 106.5mm] PQ725 [5 Studs] [PCD: 108mm]	PQ556 [4 Studs] [Flange Ø: 140mm]	PQ725 [5 Studs] [PCD: 108mm] PQ854	PQ510 [5 Studs] [PCD: 106.5mm]
Rear Wheel Hub / Stub Axle					

APPLICATIONS	LOCATION	VOLVO S60 4X4 2.5R B5254 T4 3.0 T6 V70 2.5T R B5254T	VOLVO S60 1.6 T3, T4 2.0 D3, D4, T5, T6 2.4 D5 V60 1.6 T3, T4 2.0 D3, D4, T5, T6 2.4 D5 3.0 T6 AWD	VOLVO S70 2.3 T5 Cabrio, Coupe B5434T4 2.4 Cabrio, Coupe B5254S V70 2.3 T5 Estate B5434T4 2.4,T Estate B5254S 2.5T Estate	VOLVO S80 2.4T TS D5244T 2.5T D5252T 2.9 TS Executive
YEARS		03-06	2010-	97-04	02-06
Front Wheel Bearing	- Inner	HUB075	HUB339 [with integrated ABS sensor]	HUB034 [97-98] HUB035	HUB075
	- Outer				
Front Wheel Oil Seal	- Inner	HUB UNIT	HUB UNIT	HUB UNIT	HUB UNIT
	- Outer				
Front Wheel Kit		PQ509 [5 Studs]	PQ1034 [5 Studs]	PQ505 [97-98] [4 Studs] PQ508 [98-04] [5 Studs]	PQ509 [5 Studs]
Front Wheel Hub / Stub Axle					
Alternator / Generator Bearing	- Front				
	- Rear				
Concentric / Thurst Bearing		Concentric Slave Cylinder	Concentric Slave Cylinder	Concentric Slave Cylinder	Concentric Slave Cylinder
Diff Carrier Bearing	- Left				
	- Right				
Diff Pinion Bearing	- Front				
	- Rear				
Propshaft Support Bearing					
Pulley Bearing					
Spigot Shaft Bearing					
V-Belt Tensioner					
Drive Shaft Oil Seal	- Left				
	- Right				
Gearbox Oil Seal	- Front				
	- Rear				
Pinion Oil Seal					
Spark Plug Tube Seal					
Rear Main Bearing Oil Seal		9975	9101 [2.4 D5 11-] 9375FS [2.0 T5] 9377FS [1.6 T3, T4] 9975 [2.0 D3, D4, 2.4 D5 -11]	9975	9975
Timing Cover / Cam Oil Seal		304707 [Cam] 455707 [Cam Alt.]	334705 [T/Cover 1.6 T3, T4] 354706 [T/Cover 2.0 D3, D4, 2.4 D5] 9378 [T/Cover 2.0 T5] 9100 [Cam 2.0 D3, D4, 2.4 D5] 9555 [Cam 1.6 T3, T4]	354706 [T/Cover] 456507 [Cam No. 1 Fr.] 516507 [Cam No. 2 Fr.] 9626 [Cam No. 1 & 2 Rr.]	354706 [T/Cover] 456507 [Cam No. 1 Fr.] 516507 [Cam No. 2 Fr.] 9626 [Cam No. 1 & 2 Rr.]
Rear Wheel Bearing	- Inner	HUB073 [S60] [with integrated ABS sensor] HUB121 [V70] [with integrated ABS sensor]	HUB340 [with integrated ABS sensor] HUB341 [2.0T, 3.0 T6 AWD]	309797	HUB073 [with integrated ABS sensor]
	- Outer				
Rear Wheel Oil Seal	- Inner	HUB UNIT	HUB UNIT	Sealed Bearing	HUB UNIT
	- Outer				
Rear Wheel Kit		PQ510 [S60] [5 Studs] [PCD: 106.5mm] PQ726 [V70] [5 Studs]	PQ1035 [5 Studs] PQ1036 [2.0T, 3.0 T6 AWD]	PQ618	PQ510 [5 Studs] [PCD: 106.5mm]
Rear Wheel Hub / Stub Axle					



APPLICATIONS	LOCATION	VOLVO S90	VOLVO V40	VOLVO V50	VOLVO V70
		2.9 X44 B6304S V90 2.9 X44 B6304S	1.6 D2 1.8 D3 1.6 T3, T4 2.0 T5 2.5 T5	1.8 [05-06] 2.0D B5244S 2.0i [06-12] 2.4 D5 [06-09] 2.4i B5244S [04-09] 2.5i T5 B5254T [04-12] <i>All models available in Manual or Geartronic</i>	2.0T P80 Sedan, Estate B5204 T5 2.4T [01-03] 2.5T P80 Sedan, Estate B5254T
YEARS		97-00	2012-	04-12	04-08
Front Wheel Bearing	- Inner	HUB031	HUB337 [with integrated ABS sensor]	HUB118 [with integrated ABS sensor]	HUB075
	- Outer				
Front Wheel Oil Seal	- Inner	HUB UNIT	HUB UNIT	HUB UNIT	HUB UNIT
	- Outer				
Front Wheel Kit		PQ552 [4 Studs]	PQ1032 [5 Studs]	PQ723 [5 Studs]	PQ509 [5 Studs]
Front Wheel Hub / Stub Axle					
Alternator / Generator Bearing	- Front				
	- Rear				
Concentric / Thurst Bearing			Concentric Slave Cylinder	Concentric Slave Cylinder	Concentric Slave Cylinder
Diff Carrier Bearing	- Left				
	- Right				
Diff Pinion Bearing	- Front				
	- Rear				
Propshaft Support Bearing					
Pulley Bearing					
Spigot Shaft Bearing					
V-Belt Tensioner					
Drive Shaft Oil Seal	- Left			9292 [OD: 65mm] 9293 [OD: 60mm]	
	- Right			9292 [OD: 65mm] 9293 [OD: 60mm]	
Gearbox Oil Seal	- Front			9294	
	- Rear				
Pinion Oil Seal					
Spark Plug Tube Seal					
Rear Main Bearing Oil Seal		9975	9101 [2.0 D3, T5] 9242 [1.6 D2] 9377FS [1.6 T3, T4] 9975 [2.5 T5]	9375FS [2.0 Pet.] 9979 [2.0D] 9975 [2.4, 2.5]	9975
Timing Cover / Cam Oil Seal		354706 [T/Cover] 456507 [Cam No. 1 Fr.] 516507 [Cam No. 2 Fr.] 9626 [Cam No. 1 & 2 Rr.]	274707 [Cam 1.6D] 516507 [2.5 T5] 9100 [Cam 1.8 D3, 2.0 T5] 9555 [Cam 1.6 T3, T4] 9334 [T/Cover 1.6 D2] 334705 [T/Cover 1.6 T3, T4] 354706 [T/Cover 2.0 D3, T5, 2.5 T5]	274707 [Cam 2.0D] 456507 [Cam No. 1 Fr. 2.4, 2.5] 516507 [Cam No. 2 Fr. 2.4, 2.5] 9626 [Cam Rr. 2.5] 9378 [T/Cover. 2.0 Pet.] 426207 [T/Cover 2.0D] 354706 [T/Cover 2.4, 2.5]	304707 [Cam] 455707 [Cam Alt.]
Rear Wheel Bearing	- Inner	309797	HUB338 [with integrated ABS sensor]	HUB120 [with integrated ABS sensor]	HUB073 [with integrated ABS sensor]
	- Outer				
Rear Wheel Oil Seal	- Inner	Sealed Bearing	HUB UNIT	HUB UNIT	HUB UNIT
	- Outer				
Rear Wheel Kit		PQ618	PQ1033 [5 Studs]	PQ725 [5 Studs] [PCD: 108mm]	PQ510 [5 Studs] [PCD: 106.5mm]
Rear Wheel Hub / Stub Axle					

APPLICATIONS	LOCATION	VOLVO V70 4X4	VOLVO XC60	VOLVO XC60 4X4	VOLVO XC60
		2.4 XC Estate B5254S <b>XC70</b> 2.5T Estate <b>XC90</b> 2.9 T6 5/7 Seater Estate B6304	2.0T [10-11] 2.4D [09-10] T5 [11-14] <b>XC90</b> 2.4 D5 [04-06]	3.0T D5 [09-10] <b>XC90</b> 3.2 [07-11]	2.0T B4204T6 [10-11] 2.0 D3/4 D5204T2/3 [11-14] 2.0 D4 B4204T5/14 [2014-] 2.0 T5 B4204T7/11 [11-14] 2.0 T6 B4204T9 [14-16] 2.4 D5244T14 [09-10]
YEARS		00-06	04-14	07-11	2009-
Front Wheel Bearing	- Inner	<b>HUB035</b>	<b>HUB344</b>	<b>HUB345</b> <b>HUB344</b>	<b>HUB339</b> [with integrated ABS sensor]
	- Outer				
Front Wheel Oil Seal	- Inner	HUB UNIT	HUB UNIT	HUB UNIT	HUB UNIT
	- Outer				
Front Wheel Kit		<b>PQ508</b> [5 Studs]	<b>PQ1039</b> [XC90]	<b>PQ1040</b> [XC90] [40 Spline] <b>PQ1039</b> [XC90] [36 Spline]	<b>PQ1034</b> [5 Studs]
Front Wheel Hub / Stub Axle					
Alternator / Generator Bearing	- Front				
	- Rear				
Concentric / Thurst Bearing		<b>Concentric Slave Cylinder</b>			
Diff Carrier Bearing	- Left				
	- Right				
Diff Pinion Bearing	- Front				
	- Rear				
Propshaft Support Bearing					
Pulley Bearing					
Spigot Shaft Bearing					
V-Belt Tensioner					
Drive Shaft Oil Seal	- Left				
	- Right				
Gearbox Oil Seal	- Front				
	- Rear				
Pinion Oil Seal					
Spark Plug Tube Seal					
Rear Main Bearing Oil Seal		<b>9975</b>		<b>9103</b> [3.2]	<b>9103</b>
Timing Cover / Cam Oil Seal		<b>354706</b> [T/Cover] <b>456507</b> [Cam No. 1 Fr.] <b>516507</b> [Cam No. 2 Fr.] <b>9626</b> [Cam1, 2 Rr.]		<b>9102</b> [3.2]	<b>9102</b> [2.0T6]
Rear Wheel Bearing	- Inner	<b>309797</b>	<b>HUB342</b>	<b>HUB343</b>	
	- Outer				
Rear Wheel Oil Seal	- Inner	Sealed Bearing	HUB UNIT	HUB UNIT	
	- Outer				
Rear Wheel Kit		<b>PQ618</b>	<b>PQ1037</b> [XC60]	<b>PQ1038</b> [XC60]	
Rear Wheel Hub / Stub Axle					

APPLICATIONS	LOCATION	VOLVO XC60 4X4	VOLVO XC70 4X4	VOLVO XC90 4X4	VOLVO XC90 4X4
		2.0 T5 B4204T11 [2014-] 2.0 T6 B4204T9 [2015-] 2.4 D5 D5244T10/11/15/20/22 3.0T B6304T2 [09-10] 3.0 T6 B6304T3/4 [10-14]	2.5T P80 Estate B5254T XC90 2.4 D5 5 & 7 Seater SUV D5244T 2.5T 5 & 7 Seater SUV B5254T3	2.4 D5 D5244T4/5 [04-11] 2.5T B5254T2 [03-11] 2.9 T6 B6294T [03-06] 4.4 V8 B8444S [06-11]	2.4 D5 D5244T18 [11-14] 2.5 B5254T2 [12-14] 3.2 B6324S/5 [07-11]
YEARS		2009-	04-08	03-11	07-14
Front Wheel Bearing	- Inner	HUB339	HUB075	HUB344 HUB345	HUB344 HUB345
	- Outer				
Front Wheel Oil Seal	- Inner	HUB UNIT	HUB UNIT	HUB UNIT	HUB UNIT
	- Outer				
Front Wheel Kit		PQ1034	PQ509 [5 Studs]	PQ1039 [36 Splines] PQ1040 [40 Splines]	PQ1039 [36 Splines] [2.4, 2.5] PQ1040 [40 Splines]
Front Wheel Hub / Stub Axle					
Alternator / Generator Bearing	- Front				
	- Rear				
Concentric / Thrust Bearing			Concentric Slave Cylinder		
Diff Carrier Bearing	- Left				
	- Right				
Diff Pinion Bearing	- Front				
	- Rear				
Propshaft Support Bearing					
Pulley Bearing					
Spigot Shaft Bearing					
V-Belt Tensioner					
Drive Shaft Oil Seal	- Left				
	- Right				
Gearbox Oil Seal	- Front				
	- Rear				
Pinion Oil Seal					
Spark Plug Tube Seal					
Rear Main Bearing Oil Seal		9103 [3.0T]	9975		
Timing Cover / Cam Oil Seal		9102 [3.0T]	304707 [Cam] 455707 [Cam Alt.]		
Rear Wheel Bearing	- Inner		HUB121 [with integrated ABS sensor]	HUB121 [with integrated ABS sensor] HUB386 [with integrated ABS sensor]	HUB121 [with integrated ABS sensor]
	- Outer				
Rear Wheel Oil Seal	- Inner		HUB UNIT	HUB UNIT	HUB UNIT
	- Outer				
Rear Wheel Kit			PQ726 [5 Studs]	PQ726 [5 Hole] PQ1110 [2.5T] [5 Hole]	PQ1110 [5 Hole]
Rear Wheel Hub / Stub Axle					

APPLICATIONS	LOCATION	VOLVO XC90 4X2, 4X4 2.0 D5 D4204T11/14/23 2.0 T5/6 B4204T23/27			
YEARS		2015-			
Front Wheel Bearing	- Inner	HUB384			
	- Outer				
Front Wheel Oil Seal	- Inner	HUB UNIT			
	- Outer				
Front Wheel Kit		PQ1108			
Front Wheel Hub / Stub Axle					
Alternator / Generator Bearing	- Front				
	- Rear				
Concentric / Thurst Bearing					
Diff Carrier Bearing	- Left				
	- Right				
Diff Pinion Bearing	- Front				
	- Rear				
Propshaft Support Bearing					
Pulley Bearing					
Spigot Shaft Bearing					
V-Belt Tensioner					
Drive Shaft Oil Seal	- Left				
	- Right				
Gearbox Oil Seal	- Front				
	- Rear				
Pinion Oil Seal					
Spark Plug Tube Seal					
Rear Main Bearing Oil Seal					
Timing Cover / Cam Oil Seal					
Rear Wheel Bearing	- Inner	HUB384 HUB385			
	- Outer				
Rear Wheel Oil Seal	- Inner	HUB UNIT			
	- Outer				
Rear Wheel Kit		PQ1108 PQ1109 [4X2]			
Rear Wheel Hub / Stub Axle					

HOW TO MEASURE OUR PARTQUIP THRUST BEARINGS

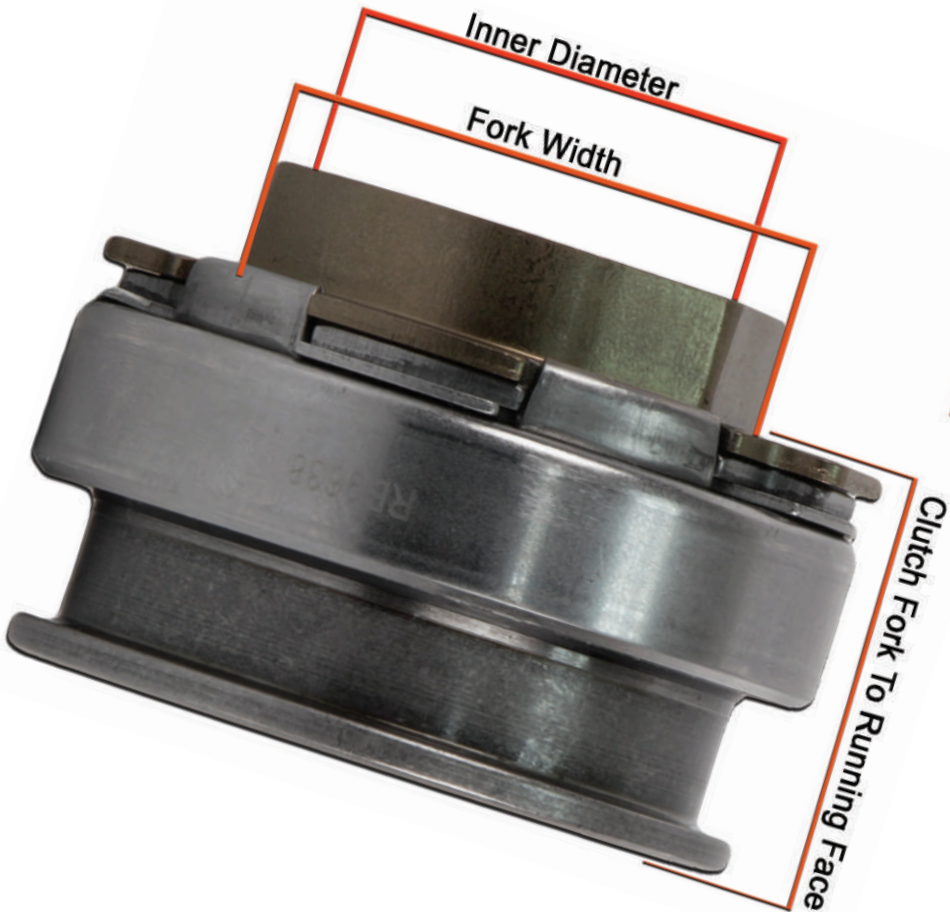
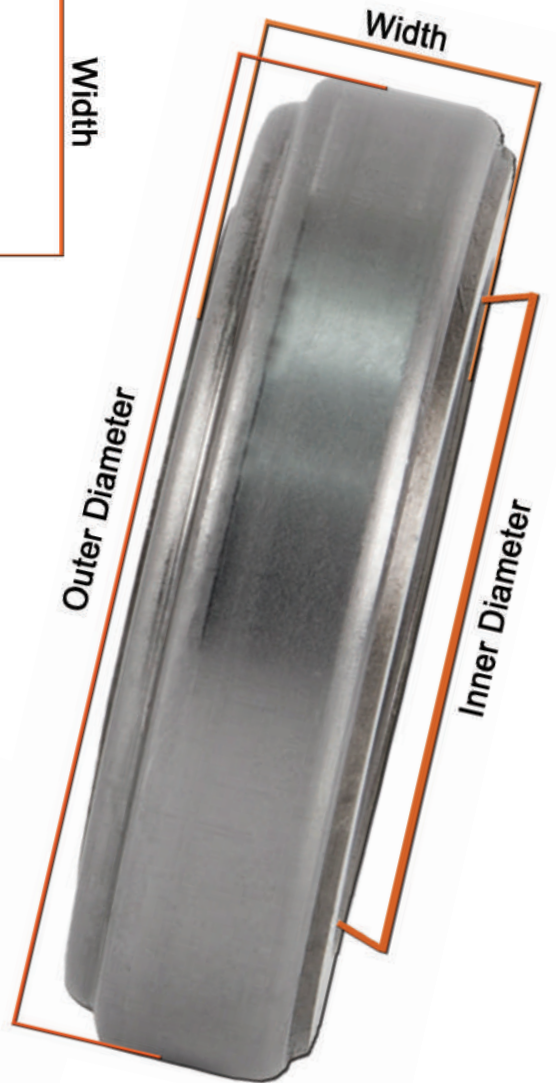
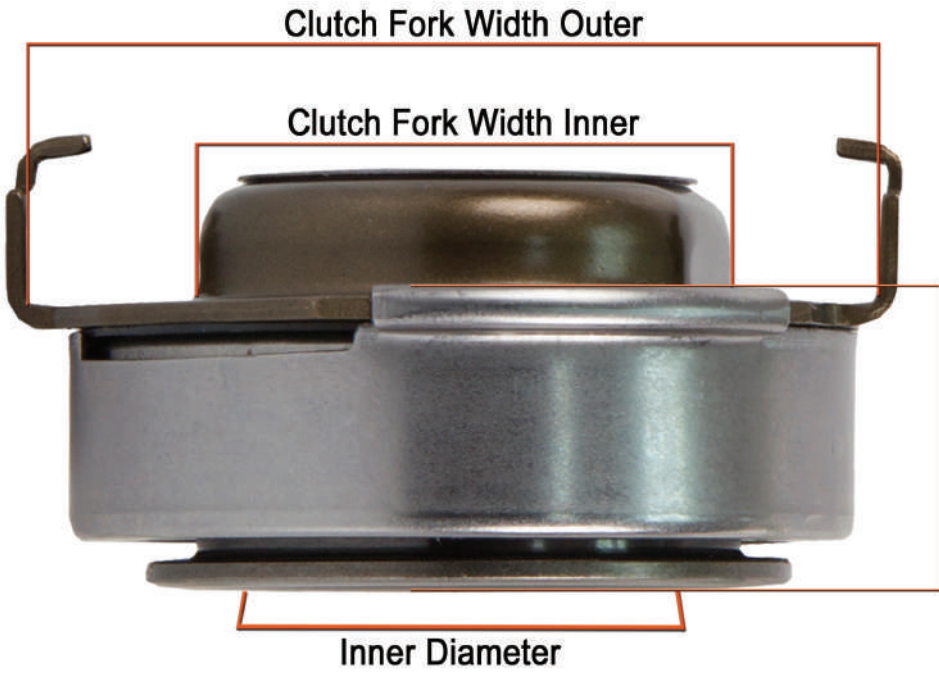









# BUYERS GUIDE - THRUST BEARINGS

	<b>RB9001</b>			<b>RB9002</b>	
	Inner Diameter:	27.5mm		Inner Diameter:	32.5mm
	Height:	21.5mm		Clutch Fork to Running Face:	23.5mm
	Clutch Fork Width: <i>Inner Diameter</i>	64mm		Clutch Fork Width: <i>Inner Diameter</i>	46.5mm
	Clutch Fork Width: <i>Outer Diameter</i>	83.5mm		Clutch Fork Width: <i>Outer Diameter</i>	-
Hyundai Elantra J2 1.8 GL, GLS, S/W, Matrix 1.8, Tiburon 2.0, FX, 2.7 (95-01), Santa Fe 2.4, 2.7 V6 SUV (01-06), Kia Carens 1.8i, 2.0i (00-06), Cerato 2.0CRDi (03-06) <b>Round Face Thrust Bearing</b>			Hyundai (94-06) Accent 1.3, 1.5, 1.6 (94-06), Elantra J2 1.6 (95-01), Elantra J3 1.6, 1.8, 2.0 (01-06), Elantra J4 1.6, 2.0 (2006-), Getz 1.3i, 1.4i, 1.5d., 1.6 (2003-), i20 1.4, 1.6 (2008-), Matrix 1.6 (02-07), Kia Cerato 1.6, 2.0 (03-08), Rio II 1.4, High, 1.6i, Sport (2004-), Spectra 1.6 (01-03) <b>Round Face Thrust Bearing</b>		
	<b>RB9003</b>			<b>RB9031</b>	
	Inner Diameter:	24mm		Inner Diameter:	33mm
	Clutch Fork to Running Face:	17mm		Outer Diameter:	86.5mm
	Clutch Fork Width: <i>Inner Diameter</i>	30mm		Width:	19.5mm
	<b>Round Face Thrust Bearing</b>			<b>Flat Face Thrust Bearing</b>	
Fiat Palio / Siena I/II 1.2, 1.6 (00-10), Panda 1.1, 1.2, 1.3, 1.4 (2006-), Punto 1.2, 1.3 (2004-), Stilo 1.6 Active, Multiwagon (03-07), Uno 1.0 Cento, 1.1 Fire, Mia, Rio, Tempo, 1.4 Beat, Mia, Pacer, Pacer SX, Tempo SX, Espresso P/van (91-05), Seicento 1.1 (01-03), Strada 1.2, 1.6 P/up (05-10), 500 1.2, 1.4 (08-15) (All Models With Hydraulic Clutch)			Audi 90 1.8 (68-72), VW Beetle 1.2, 1.3, 1.5, 1.6 DL, Fun Bug, Jeans, L, Lux Bug, S, SP, Super Bug (61-79)		
	<b>RB9517</b>			<b>RB9525</b>	
	Inner Diameter:	45mm		Inner Diameter:	35mm
	Outer Diameter:	73.5mm		Clutch Fork to Running Face:	19mm
	Width:	16mm		Clutch Fork Width: <i>Inner Diameter</i>	41.5mm
	<b>Flat Face Thrust Bearing</b>			<b>Round Face Thrust Bearing</b>	
Toyota Land Cruiser 3.6 P/up (75-81)			Chevrolet Chevir 1.6 (81-82), Rekord 2.0, 2.3, Berlina (80-82), Opel Ascona 1.3, L (82-87), Commodore 2.8, GL, L, 3.0, E (82-88), Kadett 1.1, Viva, 1.2, L, 1.3, Cub, GL, GLS, LS, Rebel (66-87), Rekord 2.0, Berlina, GL, GLS, L, S/W, 2.1 (82-88), Senator 3.0E (82-87)		
	<b>RB9538</b>			<b>RB9543</b>	
	Inner Diameter:	54.5mm		Inner Diameter:	52.5mm
	Outer Diameter:	88mm		Outer Diameter:	94mm
	Width:	19mm		Width:	19.5mm
	<b>Flat Face Thrust Bearing</b>			<b>Flat Face Thrust Bearing</b>	
Isuzu SBR, JCR & TXD Series (76-82)			Toyota Dyna 3.0 (86-90)		

## BUYERS GUIDE - THRUST BEARINGS

	<b>RB9543D</b>			<b>RB9544</b>	
	Inner Diameter:	52mm		Inner Diameter:	40mm
	Outer Diameter:	97mm		Clutch Fork to Running Face:	35.5mm
	Width:	26mm		Clutch Fork Width:	42.5mm
	Round Face Thrust Bearing			Round Face Thrust Bearing	
Toyota Land Cruiser 3.9 GX, Turbo P/up, 4.0 DLX, GX P/up, 4.2 P/up (75-90)			Land Rover Series III 88" 2.25 P/up, Series III 109" 2.25, P/up, 2.6 P/up, Series III 110" 2.6, 3.5 V8 P/up (60-86), Discovery 3.5 P/up, 3.9 (90-95), Range Rover 3.5, Classic (79-93)		
	<b>RB9548</b>			<b>RB9549</b>	
	Inner Diameter:	40mm		Inner Diameter:	45mm
	Outer Diameter:	67mm		Outer Diameter:	76.5mm
	Width:	20mm		Width:	23mm
	Round Face Thrust Bearing			Round Face Thrust Bearing	
Toyota Corolla 1.2, 1.6 GL, S/W, GLS Sprinter, P/van, SE, SR4, 1.8, GLS, SE (77-88), Corona 1.8, 1.9 RT83, RT102 (77-80), Cressida 1.8 2.0, 2.8i, RSi (77-92), Dyna 2.0, 2.2 (85-87), Hiace 1.6 12 seater Bus, P/van, 1.8, 2.0 Bus, Wagon, Bus, P/van, Super 10 Seater Custom Wagon, Turbo, 2.2 16 Seater Commuter (80-88), Hilux 1.6 P/up, 1.8, S P/up, 2.0 D/cab, 2.2 D/cab, Raider P/up, 2.4 D/cab, Raider P/up (81-88), Stallion 1.5 P/up, P/van (86-88), Stout 2.0 P/up (80-88)			Toyota Dyna 3.0, Turbo, 3.8, 4.0 (76-90)		
	<b>RB9561</b>			<b>RB9562</b>	
	Inner Diameter:	40mm		Inner Diameter:	38mm
	Outer Diameter:	67mm		Outer Diameter:	67mm
	Width:	18mm		Width:	16mm
	Round Face Thrust Bearing			Round Face Thrust Bearing	
Nissan 1200 Coupe, GX, 120Y DL, SDX, P/up, 1400 S/W, 140Y, GX, S/W, 140Z, Coupe, \ 1600 GL, SSS, 1600J, D/L, S/W, 160U, SSS, 160Y, GX Coupe, 160Z, Coupe, 1800 GL, 1800J, SSS, 180U, SSS, GL (71-80), Stanza 1.6, DL, Resort, 1.8, GL, SSS, Resort (80-84)			Isuzu KB160, KB21, KB22, KB23, KB25 LE, KB26, KB27, KB28, KBD21, KBD22, KBD26, KBD27, KBD28, KB41, KB42, KB43, KBD41, KBD42, Relay 2.0 Bus, WFR 1.8 11FVX Bus, P/van, 12FVX Bus (89-95), Mitsubishi Colt 1.6 Galant GL, GS (72-84), Pajero 3.0 GLS Wagon (94-95), Suzuki SJ410 Samurai S/W (83-90), Toyota Corona Mkl 1.8, 1.9, GSL, 2.0 (69-78)		
	<b>RB9565</b>			<b>RB9568</b>	
	Inner Diameter:	65mm		Inner Diameter:	33.5mm
	Outer Diameter:	102mm		Height:	24mm
	Width:	22.5mm		Clutch Fork Width: Inner Diameter	-
	Flat Face Thrust Bearing			Clutch Fork Width: Outer Diameter	65.5mm
Nissan CK20, PD6, CK41, CW41 (73-81)			Peugeot 404 1.8, 1618, GL, P/up, 2.0 (74-80), 504 1.8, GR, L, S/W, 2.0, GL, Ti, 2.3, GLD (71-85)		
			Round Face Thrust Bearing		



# BUYERS GUIDE - THRUST BEARINGS

	<b>RB9571</b>		<b>RB9574</b>																
	<table border="1" style="width: 100%; border-collapse: collapse;"> <tr> <td style="width: 30%;">Inner Diameter:</td> <td>34.5mm</td> </tr> <tr> <td>Clutch Fork to Running Face:</td> <td>14mm</td> </tr> <tr> <td>Clutch Fork Width:</td> <td>70.5mm</td> </tr> <tr> <td colspan="2" style="text-align: center;">Flat Face Thrust Bearing</td> </tr> </table>	Inner Diameter:	34.5mm	Clutch Fork to Running Face:	14mm	Clutch Fork Width:	70.5mm	Flat Face Thrust Bearing			<table border="1" style="width: 100%; border-collapse: collapse;"> <tr> <td style="width: 30%;">Inner Diameter:</td> <td>-</td> </tr> <tr> <td>Outer Diameter:</td> <td>33mm</td> </tr> <tr> <td>Width:</td> <td>18mm</td> </tr> </table>	Inner Diameter:	-	Outer Diameter:	33mm	Width:	18mm		
Inner Diameter:	34.5mm																		
Clutch Fork to Running Face:	14mm																		
Clutch Fork Width:	70.5mm																		
Flat Face Thrust Bearing																			
Inner Diameter:	-																		
Outer Diameter:	33mm																		
Width:	18mm																		
<p>Audi 80 1.6, 100 1.6, 1.9, 2.0 (76-93), VW Beetle 1.3 Some Models (66-70), Kombi 1.2, 1.5, 1.6, 1.7, 1.8, 1.9 Microbus, P/van, 2.0L, Exec., Bus, Kamper, P/up, P/van, 2.1 Fi Caravelle, Syncro, T3 2.3i Volksiebus, 2.5i, T3 2.5i Caravelle, Microbus (57-99), Passat 1.3, 1.5, 1.6, GL Fastback, S/W, L Sedan, GLS Fastback, S/W, Sedan (76-87)</p>		<p>VW Citi Golf 1.3, Chico, Lux, L, Shuttle, 1.4i, L, 1.6, i, Blues, Chico, Lux, Deco, Designa, L, Ritz, Shuttle, Sonic, Sport, 1.6i, L, 1.8, CTi, Designa, L Sport, Fox 1.3, L, Trippa, 1.6, L, 1.8, L Sport (83-09), Golf Caddy 1.6 P/up, 1.8, L, Sport P/up (81-95), Golf I 1.3, 1.5, 1.6, 1.8 Diesel GTi, Golf II 1.3 CL, 1.6 CSL, 1.8 CSX, GTi, GTS, Golf III 1.6 GS, 1.8 GSX, GTS, 2.0 GTi, Exec., Golf IV 1.6i Comfortline, Std. (78-04), Jetta I 1.3 GL, GX, 1.5 GLS, GLX, 1.8 GLi, Jetta II 1.6 CSL, 1.8 CLi, Exec., CLX, CSi, CSX, Jetta III 1.6 CSL, 1.8 CLX, CSX, 2.0 CLi, Exec., Jetta IV 1.6i, Comfortline, Std. (80-05), Polo 1.4i 1.6i 1.8 (96-02)</p>																	
	<b>RB9582C</b>		<b>RB9583</b>																
	<table border="1" style="width: 100%; border-collapse: collapse;"> <tr> <td style="width: 30%;">Inner Diameter:</td> <td>34mm</td> </tr> <tr> <td>Clutch Fork to Running Face:</td> <td>21.5mm</td> </tr> <tr> <td>Clutch Fork Width:</td> <td>51mm</td> </tr> <tr> <td colspan="2" style="text-align: center;">Flat Face Thrust Bearing</td> </tr> </table>	Inner Diameter:	34mm	Clutch Fork to Running Face:	21.5mm	Clutch Fork Width:	51mm	Flat Face Thrust Bearing			<table border="1" style="width: 100%; border-collapse: collapse;"> <tr> <td style="width: 30%;">Inner Diameter:</td> <td>40mm</td> </tr> <tr> <td>Outer Diameter:</td> <td>64mm</td> </tr> <tr> <td>Width:</td> <td>16mm</td> </tr> <tr> <td colspan="2" style="text-align: center;">Round Face Thrust Bearing</td> </tr> </table>	Inner Diameter:	40mm	Outer Diameter:	64mm	Width:	16mm	Round Face Thrust Bearing	
Inner Diameter:	34mm																		
Clutch Fork to Running Face:	21.5mm																		
Clutch Fork Width:	51mm																		
Flat Face Thrust Bearing																			
Inner Diameter:	40mm																		
Outer Diameter:	64mm																		
Width:	16mm																		
Round Face Thrust Bearing																			
<p>Ford Cortina MkIII 1.6, P/up, XL, 2.0, GT, P/up, 2.5, L, P/up, S/W, XL, 3.0 GT, XLE, Cortina MkIV 1.3, L, 1.6 1 Ton, GL, L, S/W, 3.0 1 Ton, GL S/W, GLS, S/W, S, Cortina MkV 1.3, L, 1.6 1 Ton, GL, L S/W, 2.0 Ghia, GL, S/W, 2.4 1 Ton, 3.0 GLS, S/W, XR6 (71-86), Courier 3.0 D/cab, Explorer, Leisure P/up (86-97), Escort 2.0, RS2000 (78-80), Granada 2.0 GL, GLE, 2.5 L, 3.0 Coupe, Ghia, GXL, L, XL (78-85), Sapphire 1.6 L, 2.0 GL, 3.0 Ghia, GLX (84-93), Sierra 1.6 GL, S/W, 2.0, 2.3, 3.0 (83-93), Mazda B3000 Magnum D/cab, Drifter P/up (86-97)</p>		<p>Mazda B1500 P/up, F1000 P/up, Van, F1300 P/up (69-80), Toyota Corona MKI, MKII 1.7, 1.8, SL, 2.0, GSL (71-80), Hiace 1.6 P/Van, Super 10, 2.0 P/van (71-81), Hilux 1.6 P/up, 2.0 P/up, 2.2 P/up (73-84), TUV 1.3 P/up, P/van, Bus, 1.5 P/up, P/van, Bus (82-87)</p>																	
	<b>RB9584</b>		<b>RB9585</b>																
	<table border="1" style="width: 100%; border-collapse: collapse;"> <tr> <td style="width: 30%;">Inner Diameter:</td> <td>45mm</td> </tr> <tr> <td>Outer Diameter:</td> <td>74mm</td> </tr> <tr> <td>Width:</td> <td>18mm</td> </tr> <tr> <td colspan="2" style="text-align: center;">Round Face Thrust Bearing</td> </tr> </table>	Inner Diameter:	45mm	Outer Diameter:	74mm	Width:	18mm	Round Face Thrust Bearing			<table border="1" style="width: 100%; border-collapse: collapse;"> <tr> <td style="width: 30%;">Inner Diameter:</td> <td>40mm</td> </tr> <tr> <td>Outer Diameter:</td> <td>75mm</td> </tr> <tr> <td>Width:</td> <td>19mm</td> </tr> <tr> <td colspan="2" style="text-align: center;">Round Face Thrust Bearing</td> </tr> </table>	Inner Diameter:	40mm	Outer Diameter:	75mm	Width:	19mm	Round Face Thrust Bearing	
Inner Diameter:	45mm																		
Outer Diameter:	74mm																		
Width:	18mm																		
Round Face Thrust Bearing																			
Inner Diameter:	40mm																		
Outer Diameter:	75mm																		
Width:	19mm																		
Round Face Thrust Bearing																			
<p>Chevrolet LUV 1.6 (72-78), Ford Ranchero 4.1 P/up (68-76), Mazda 616 Coupe, Sedan (71-74), B1600 P/up (71-82), E2000, E3000 (67-81)</p>		<p>Nissan 1400 P/van, 200 L, 240C, 260C, 280GL, L, SGL, 280ZX, 300ZX, 620 1.5, 680 2.2, 720 1.8 Kingcab, 2.0 King Cab, Tracker, 2.2 Tracker, 2.3 (80-88), B120 P/up P/van, B140 Champ, Sport, Std. (71-08), Caball C240, C340, Cabstar 2800 (75-90), E20 1.5, 1.6 15 Seat bus, Coach, P/van, 1.8, 16, 2.0 Bus, Van, Wagon (73-95), Hardbody 1.6, 1.8, 2.0 Custom, 2.4 Custom, Hi Rider, Twin cab, Tracker, 3.0 Patrol, Twin cab (88-98), Laurel 2.0, 2.8, SGL (80-87), Safari 160 Wagon (82-90), Sani 2.2 S/W, 2.4 D/cab, Hi Rider S/W, 3.0 D/cab, Exec., Mk II Exec. S/W, Patrol, S/W (88-98), Skyline 2.0 SGLi, 3.0 (87-92)</p>																	
	<b>RB9586</b>		<b>RB9588</b>																
	<table border="1" style="width: 100%; border-collapse: collapse;"> <tr> <td style="width: 30%;">Inner Diameter:</td> <td>33mm</td> </tr> <tr> <td>Outer Diameter:</td> <td>60mm</td> </tr> <tr> <td colspan="2" style="text-align: center;">Round Face Thrust Bearing</td> </tr> </table>	Inner Diameter:	33mm	Outer Diameter:	60mm	Round Face Thrust Bearing			<table border="1" style="width: 100%; border-collapse: collapse;"> <tr> <td style="width: 30%;">Inner Diameter:</td> <td>33mm</td> </tr> <tr> <td>Clutch Fork to Running Face:</td> <td>25mm</td> </tr> <tr> <td>Clutch Fork Width:</td> <td>77.5mm</td> </tr> <tr> <td colspan="2" style="text-align: center;">Outer Diameter</td> </tr> </table>	Inner Diameter:	33mm	Clutch Fork to Running Face:	25mm	Clutch Fork Width:	77.5mm	Outer Diameter			
Inner Diameter:	33mm																		
Outer Diameter:	60mm																		
Round Face Thrust Bearing																			
Inner Diameter:	33mm																		
Clutch Fork to Running Face:	25mm																		
Clutch Fork Width:	77.5mm																		
Outer Diameter																			
<p>Toyota Corolla 1.2 P/up, P/van, 1.3 GL, L, LS, 1.6 (72-88)</p>		<p>Ford Laser 1.5, 1.6i, TX3 (85-89), Mazda 323 1.3 GLC Hatchback, L Hatchback, S Hatchback, Sedan, 1.4 GLC Hatchback, 1.5 L Hatch, Sedan, SL Sedan, SLX Sedan, Sport Hatchback, 1.6 GLC Hatchback (77-86)</p> <p style="text-align: center;">Round Face Thrust Bearing</p>																	

## BUYERS GUIDE - THRUST BEARINGS

	<b>RB9588A</b>			<b>RB9589</b>	
	Inner Diameter:	33mm		Inner Diameter:	36mm
	Clutch Fork to Running Face:	25mm		Height:	-
	Clutch Fork Width: <i>Inner Diameter</i>	42mm		Clutch Fork Width: <i>Inner Diameter</i>	26mm
	Clutch Fork Width: <i>Outer Diameter</i>	70mm	Clutch Fork Width: <i>Outer Diameter</i>	77mm	
<p>Ford Laser 1.3, 1.4 L, 1.5, 1.6 GL, Sport, i (86-92), Meteor 1.3, 1.4, 1.5, 1.6 (86-92), Kia Rio I 1.3, 1.4, 1.5 (00-05), Mazda 323 1.3, 1.5, 1.6 EGi Hatch, L Sedan, SL Hatch, Sedan, Sport Hatch, 2.0 EGi Hatch, SLE Hatch, SLi Sedan (86-91), B2600 D/cab, B3000 D/cab, Magnum, Drifter P/up (86-01), Drifter 2.6i (00-07)</p> <p style="text-align: center;"><b>Round Face Thrust Bearing</b></p>			<p>Ford Telstar 2.0, 2.5 Ghia, GLi, TX5 2.5 RSi (93-98), Courier 1.6 P/up, 1.8, 2.0, 2.2 XLT P/up, 2.5TD, 3.0, 3.4 Leisure D/cab P/up (86-00), Ranger 1.8, 2.2 (00-07), Kia Carnival 2.5 (96-04), Clarus 2.0 (98-02), Sephia 1.8 (98-02), Shuma 1.8 (98-02), Mazda 626 1.6, Sedan, 1.8 L Hatch, 2.0, 2.0i Medium, High, 2.5i V6, Exec. (83-98), Astina 180Se (95-04), MX6 2.5i V6 (93-98), B-Series (82-02), Drifter 1.8, 2.2, T2000, Truck, T3000 SWB, LWB Truck (00-07)</p> <p style="text-align: center;"><b>Round Face Thrust Bearing</b></p>		
	<b>RB9592</b>			<b>RB9599</b>	
	Inner Diameter:	30mm		Inner Diameter:	70mm
	Height:	26.5mm		Outer Diameter:	117mm
	Clutch Fork Width: <i>Inner Diameter</i>	-		Width:	27mm
	Clutch Fork Width: <i>Outer Diameter</i>	90.5mm	<b>Flat Face Thrust Bearing</b>		
<p>Ford Bantam 1.3, 1.4 Leisure P/up, 1.6 P/up (83-94), Escort 1.3 GL, L, 1.6 GLE, L, Sport, XR3, XR3i, 1.4i Hatchback, Sedan, 1.6i GL Hatchback, Sedan, GLE Hatchback, Sedan 1.8i GLi, TDi (81-00), Mazda Rustler 1.3, 1.4 Leisure P/up, 1.6 LX P/up (86-94)</p> <p style="text-align: center;"><b>Round Face Thrust Bearing</b></p>			<p>Hino &amp; Mitsubishi Heavy Duty Trucks (74-85)</p>		
	<b>RB9603</b>			<b>RB9605</b>	
	Inner Diameter:	33.5mm		Inner Diameter:	32mm
	Clutch Fork to Running Face:	21mm		Clutch Fork to Running Face:	37.5mm
	Clutch Fork Width: <i>Inner Diameter</i>	68.5mm		Clutch Fork Width: <i>Inner Diameter</i>	40mm
	<b>Round Face Thrust Bearing</b>		<b>Round Face Thrust Bearing</b>		
<p>Nissan Hardbody 2.7 D/cab, Hi-Rider, Twin cab, SE D/cab P/up (88-08), Sani 2.7 Mk II, Exec. S/W (96-99)</p>			<p>Isuzu KB250D Std., LE, D/cab P/up (99-04)</p>		
	<b>RB9606</b>			<b>RB9610</b>	
	Inner Diameter:	28mm		Inner Diameter:	24.5mm
	Clutch Fork to Running Face:	22mm		Clutch Fork to Running Face:	18mm
	Clutch Fork Width: <i>Inner Diameter</i>	-		Clutch Fork Width: <i>Inner Diameter</i>	29mm
	Clutch Fork Width: <i>Outer Diameter</i>	55.5mm	<b>Round Face Thrust Bearing</b>		
<p>Chevrolet Spark 0.8 L, LS, 1.0 LS, LT (2003-), Daewoo Matiz 800cc S, SE (99-03), Suzuki Celerio 1.0 K10B (2015-)</p> <p style="text-align: center;"><b>Round Face Thrust Bearing</b></p>			<p>Citroen C2/C3/C4 - All (01-09), C5 2.0 SX (01-05), Xsara/Picasso 1.6, 1.8, 2.0, HDi (01-06), Peugeot 1007 1.6 (05-08), 206 (01-06), 207 - All (2006-), 306 1.6 (95-03), 307 1.6, 2.0 (01-08), 308 Some Models (2008-)</p>		

# BUYERS GUIDE - THRUST BEARINGS

 Use RB9674	<b>RB9611</b>		<b>RB9616</b>		
	Inner Diameter:		24.5mm	Inner Diameter:	31mm
	Clutch Fork to Running Face:		21mm	Clutch Fork to Running Face:	20.5mm
	Clutch Fork Width: <i>Inner Diameter</i>		-	Clutch Fork Width: <i>Inner Diameter</i>	45mm
Clutch Fork Width: <i>Outer Diameter</i>		61.5mm	Round Face Thrust Bearing		
Citroen Berlingo 1.4, 1.9D (03-09), C5 3.0 V6 Exclusive (01-05), Fiat Ulysse 2.0 MPV (99-02), Peugeot 306 2.0 XSi, 405 1.6 GR, 1.8 GR, 2.0 SRI (95-01), 406 2.0 ST Estate, SLi, ST, STi, 3.0 SV V6 (96-04)		Chrysler Neon 2.0i (96-02), PT Cruiser 1.6, 2.0, 2.4 (96-04)			
 NO PICTURE AVAILABLE AT TIME OF PRINT	<b>RB9617</b>		<b>RB9622</b>		
	Inner Diameter:		-	Inner Diameter:	26.5mm
	Clutch Fork to Running Face:		-	Clutch Fork to Running Face:	18mm
	Clutch Fork Width: <i>Inner Diameter</i>		-	Clutch Fork Width: <i>Inner Diameter</i>	30mm
		Round Face Thrust Bearing			
Chrysler Voyager 2.0, 4.4 SE MPV (96-04)		Nissan NP200 1.5, 1.6 (2008-), Renault Captur 1.5 Dci K9K (2016-), Clio 1.2, 1.4, 1.5, 1.6, 2.0, 3.0 (99-06), Espace 2.0, 3.0 (96-08), Kangoo 1.5DCi (03-10), Laguna I 1.6, 1.8, 1.9DCi, 2.0 (96-07), Kwid (2015-), Megane I 1.6, 2.0, Megane II 1.4, 1.5Dci, 1.6, 1.9DCi, 2.0, T (96-06), Sandero 1.4, 1.6 (09-15), Scenic I/II 1.4, 1.6, 1.9d, 2.0 (98-06), Twingo 1.2 (08-13)			
 NO PICTURE AVAILABLE AT TIME OF PRINT	<b>RB9623</b>	 NO PICTURE AVAILABLE AT TIME OF PRINT	<b>RB9624</b>		
	Inner Diameter:		-	Inner Diameter:	-
	Height:		-	Height:	-
	Clutch Fork Width: <i>Inner Diameter</i>		-	Clutch Fork Width: <i>Inner Diameter</i>	-
Clutch Fork Width: <i>Outer Diameter</i>		-	Clutch Fork Width: <i>Outer Diameter</i>		
Renault Laguna 3.0 V6 (96-98)		Renault Espace 2.0 Alize S/W (96-97)			
 NO PICTURE AVAILABLE AT TIME OF PRINT	<b>RB9626</b>		<b>RB9627</b>		
	Inner Diameter:		-	Inner Diameter:	28.5mm
	Clutch Fork to Running Face:		-	Clutch Fork to Running Face:	22mm
	Clutch Fork Width:		-	Clutch Fork Width: <i>Inner Diameter</i>	45mm
Round Face Thrust Bearing		Round Face Thrust Bearing			
Daihatsu Rocky 2.8, SE MPV (97-02)		Daihatsu Charade 1.0, Copen 1.3 (03-09), Gran Move 847, 1.0, 1.5 (97-02), Feroza 1.6 MPV (98-99), Materia 1.5 (2007-), Move 847 S/W (97-00), Terios 1.3, 1.5i (97-11), Sirion 1.0, 1.3, 1.5 (98-08), YRV 1.3, 1.5 (01-08), Toyota Avanza 1.3, 1.5 (2006-)			
 NO PICTURE AVAILABLE AT TIME OF PRINT	<b>RB9627A</b>		<b>RB9628</b>		
	Inner Diameter:		-	Inner Diameter:	35.5mm
	Clutch Fork to Running Face:		-	Clutch Fork to Running Face:	24mm
	Clutch Fork Width:		-	Clutch Fork Width:	44mm
New Number		Round Face Thrust Bearing			
Toyota Avanza 1.3, 1.5 (12-16)		Toyota Conдор 3.0D S/W - 4X2, 4X4 (00-05), Hilux 2.8 Raider, D/cab P/up, 3.0D Raider, D/cab P/up - 4X2, 4X4 (98-05)			



# BUYERS GUIDE - THRUST BEARINGS

	<b>RB9630</b>		 <b>NO PICTURE AVAILABLE AT TIME OF PRINT</b>	<b>RB9635</b>	
	Inner Diameter:	40mm		Inner Diameter:	-
	Outer Diameter:	81.3mm		Clutch Fork to Running Face:	-
	Width:	19mm		Clutch Fork Width:	-
	Round Face Thrust Bearing			Round Face Thrust Bearing	
Nissan Hardbody 3.0i D /Cab, King Cab, D/Cab Hi-Rider, King Cab Hi-Rider (01-08), NP300 Hardbody 2.4i P/up(2008-), Navara/ Pathfinder 2.5DCi D/cab(2005-), NV350 (2013-)			Toyota Dyna 4.0 (99-02)		
	<b>RB9636</b>			<b>RB9637</b>	
	Inner Diameter:	38.5mm		Inner Diameter:	38.5mm
	Clutch Fork to Running Face:	34.5mm		Clutch Fork to Running Face:	47mm
	Clutch Fork Width:	48mm		Clutch Fork Width:	48mm
	Round Face Thrust Bearing			Round Face Thrust Bearing	
Toyota Land Cruiser 4.0 P/up (90-92)			Toyota Land Cruiser 4.2 GX, VX P/up, TDi S/W, 4.5 VX S/W V8 (90-06)		
	<b>RB9638</b>		 <b>NO PICTURE AVAILABLE AT TIME OF PRINT</b>	<b>RB9639</b>	
	Inner Diameter:	38mm		Inner Diameter:	-
	Clutch Fork to Running Face:	38mm		Clutch Fork to Running Face:	-
	Clutch Fork Width:	48mm		Clutch Fork Width:	-
	Round Face Thrust Bearing			Round Face Thrust Bearing	
Toyota Land Cruiser 4.5 P/up (92-96)			Toyota Land Cruiser 4.5 Std., GX P/up (96-06)		
	<b>RB9640</b>			<b>RB9643</b>	
	Inner Diameter:	38.5mm		Inner Diameter:	35.5mm
	Clutch Fork to Running Face:	53.5mm		Clutch Fork to Running Face:	48mm
	Clutch Fork Width:	48mm		Clutch Fork Width:	48mm
	Round Face Thrust Bearing			Round Face Thrust Bearing	
Toyota Land Cruiser 4.2 Std., GX P/up (90-01)			Toyota Land Cruiser 4.2 Std., GX P/up (98-06)		
	<b>RB9645</b>			<b>RB9655</b>	
	Inner Diameter:	35.5mm		Use RB9814	
	Clutch Fork to Running Face:	34mm			
	Clutch Fork Width:	44mm			
	Round Face Thrust Bearing				
Toyota Hilux 2.5 TDi D/cab SRX HO, S/Cab SRX HO P/up - 4X2, 4X4 (2005-)			Mercedes-Benz W126 Series 280S, SE, SEL (Only 4 Spd. Models) (79-85)		

# BUYERS GUIDE - THRUST BEARINGS

	<b>RB9656</b>			<b>RB9657</b>	
	Inner Diameter:	34.4mm		Inner Diameter:	34mm
	Clutch Fork to Running Face:	25mm		Clutch Fork to Running Face:	23mm
	Clutch Fork Width: <i>Inner Diameter</i>	38mm		Clutch Fork Width:	45.5mm
	Flat Face Thrust Bearing			Flat Face Thrust Bearing	
Mercedes-Benz W202 C180, C200 (93-00), Ssangyong Korando K230EL, K320EL, K602EL (97-04), Musso E230EL, 602 EL, TDi, Exec., E320EL Exec. S/W, SUV (95-04)			Mercedes-Benz W124 200E, 220, 230, 250D, 260E, 280, 300D, 320E (89-93), E200, E220, E280, E320, Sportline (93-95), W201 190E, 2.3, 2.6 Sportline (86-96), W202 C220, C250, C280 (93-00)		
	<b>RB9658</b>			<b>RB9660</b>	
	Inner Diameter:	35mm		Inner Diameter:	33.5mm
	Clutch Fork to Running Face:	26mm		Overall Width:	41.8mm
	Clutch Fork Width: <i>Inner Diameter</i>	-		Clutch Fork Width: <i>Inner Diameter</i>	69mm
	Clutch Fork Width: <i>Outer Diameter</i>	71.5mm		Clutch Fork Width: <i>Outer Diameter</i>	95.5mm
Round Face Thrust Bearing		Round Face Thrust Bearing			
Honda Ballade 160i SO4 Series Luxline, 180i SO4 Luxline (96-00), Civic 160i V-Tec. (96-00)			Mitsubishi Colt LDV 2.8TD Pioneer D/C Hi Rider - 4X2, Rodeo D/C Pull Type, 2.8TD Rodeo D/C, 2.8 Hi-Line R.Body, 2.8TDi Rodeo D/C - 4X4 (98-09)		
	<b>RB9661</b>		 <p style="text-align: center; font-weight: bold; font-size: 1.2em;">NO PICTURE AVAILABLE AT TIME OF PRINT</p>	<b>RB9663</b>	
	Inner Diameter:	33mm		Inner Diameter:	-
	Clutch Fork to Running Face:	22mm		Clutch Fork to Running Face:	-
	Clutch Fork Width: <i>Outer Diameter</i>	74mm		Clutch Fork Width:	-
	Round Face Thrust Bearing			New number	
Toyota Etios (2012-), Corolla Verso (05-10)			Toyota Fortuner 2.4TD, 2.7, 2.8TD, 3.0D-4D, 4.0 V6 - 4X2, 4X4 (15-16)		
	<b>RB9665</b>			<b>RB9670</b>	
	Inner Diameter:	-		Inner Diameter:	33mm
	Clutch Fork to Running Face:	-		Clutch Fork to Running Face:	22mm
	Clutch Fork Width:	-		Clutch Fork Width: <i>Inner Diameter</i>	-
	Use RB9878			Clutch Fork Width: <i>Outer Diameter</i>	70mm
Round Face Thrust Bearing		Round Face Thrust Bearing			
Chevrolet Utility 1.3L (LDP), 1.4L (LQ5) (2015-), 1.8L (LJ1) (2012-)			Toyota Corolla 1.4i GLE, GLS, Sprinter, 1.6i GLE, GLS, GSX, Sprinter, 1.8i GLE, GLS, GSX, Sprinter (02-08), Corolla Verso 60i, 180i (2005-), Tazz 130 Sport, 130XE, 130 (00-06), Runx 1.4i R, RT, RS, Sport, 1.6i RT, RS, RX, Sport, 1.8i RSi, RX, 2.0i RSi. (03-08)		

## BUYERS GUIDE - THRUST BEARINGS

	<b>RB9671</b>			<b>RB9672</b>	
	Inner Diameter:	35mm		Inner Diameter:	-
	Clutch Fork to Running Face:	27mm		Clutch Fork to Running Face:	-
	Clutch Fork Width:	44mm		Clutch Fork Width:	-
Round Face Thrust Bearing					
<p>Toyota Fortuner 3.0iD, 4.0i V6 SUV (2006-), Hilux 3.0iD &amp; 4.0i V6 P/up - All - 4X2, 4X4 (2005-), Quantum 2.5 D-4D MPV P/van (2005-)</p>			<p>Same as RB9698 on some 2.5 Hyundai bakkie or P/van models alternative RB9876 Hyundai bakkies with round lights, older models. OR RB9900 for bakkie models 1997-</p>		
	<b>RB9673</b>			<b>RB9674</b>	
	Inner Diameter:	29.5mm		Inner Diameter:	24.5mm
	Clutch Fork to Running Face:	18mm		Clutch Fork to Running Face:	21mm
	Clutch Fork Width: <i>Inner Diameter</i>	48mm		Clutch Fork Width: <i>Inner Diameter</i>	-
		-		Clutch Fork Width: <i>Outer Diameter</i>	61.5mm
Flat Face Thrust Bearing			Round Face Thrust Bearing		
<p>Mazda 3 1.6i Original, Active, Dynamic, Sport Dynamic, 2.0i Individual, Sport Individual, Sport Original (2004-), 5 2.0 MPV (2007-)</p>			<p>Tata Indica 1.4i LEi, LSi, LX, LXi, Indigo 1.4i GLS S/W, GLX S/W (2005-)</p>		
	<b>RB9675</b>			<b>RB9676</b>	
	Inner Diameter:	34mm		Inner Diameter:	32.5mm
	Clutch Fork to Running Face:	35mm		Clutch Fork to Running Face:	30mm
	Clutch Fork Width:	41mm		Clutch Fork Width: <i>Inner Diameter</i>	40mm
Flat Face Thrust Bearing			Round Face Thrust Bearing		
<p>Tata Telcoline 2.0TD S/Cab, D/Cab P/up (2004-), Peugeot 207 2.0Di S/Cab, D Cab P/up (2007-)</p>			<p>Isuzu KB250 2.5 LE, Fleetside (2004-)</p>		
	<b>RB9677</b>			<b>RB9678</b>	
	Inner Diameter:	32.5mm		Inner Diameter:	36mm
	Clutch Fork to Running Face:	25mm		Height:	24mm
	Clutch Fork Width: <i>Inner Diameter</i>	40mm		Clutch Fork Width: <i>Inner Diameter</i>	45mm
	Clutch Fork Width: <i>Outer Diameter</i>	-		Clutch Fork Width: <i>Outer Diameter</i>	77.5mm
Round Face Thrust Bearing			Round Face Thrust Bearing		
<p>Isuzu KB200i 2.0 Fleetside (2004-)</p>			<p>Kia K2700i WorkHorse (2004-)</p>		



# BUYERS GUIDE - THRUST BEARINGS

	<b>RB9679</b>			<b>RB9680</b>	
	Inner Diameter:	28mm		Inner Diameter:	26mm
	Clutch Fork to Running Face:	20mm		Clutch Fork to Running Face:	19mm
	Clutch Fork Width:	40mm		Clutch Fork Width:	34.5mm
	Round Face Thrust Bearing			Round Face Thrust Bearing	
Hyundai Accent 1.6 G4FG Pet. ( 2017-), Atos 1.0 Prime, 1.1 (2000-), i10 PA 1.1 G3LA, 1.2 G4LA (08-15), 1.1 G3LA, 1.2 G4LA (2017-), i20 PB/ BT 1.2, 1.4, 1.6 (2009-), Kia Picanto 1.1 (2004-), Picanto III (JA) 1.0 G3LA, G3LD Pet., 1.2 G4LA Pet. (2017-), Rio IV 1.2 G4LA Pet., 1.4 G4LC Pet. ( 2017-)			Audi A1 1.0 TFSi, 1.2 TFSi, 1.4 TFSi, 1.6 TDi, 1.8 TFSi (11-18), Seat Altea 1.6, Seat Ibiza/Leon 1.4, 1.6, 2.0 Pet. (06-08), VW Caddy 1.6 , 2.0 SDi (2005-), Golf 5 1.6, 2.0 Pet. - Only BDK Model (2004-), Polo - All, Except 1.4TDI (02-07)		
	<b>RB9681</b>			<b>RB9686</b>	
	Inner Diameter:	-		Inner Diameter:	40.5mm
	Clutch Fork to Running Face:	-		Clutch Fork to Running Face:	25mm
	Clutch Fork Width:	-		Clutch Fork Width: <i>Inner Diameter</i>	46mm
	Round Face Thrust Bearing			Flat Face Thrust Bearing	
Audi Q7 3.6i (2006-), VW Touareg 2.5TDi, 3.0TDi (2004-)			BMW E53 X5 3.0i (2001-), E83 X3 2.0d, 2.0i 2.5i, 3.0i (2004-), E87 1 Series 116i, 118d, 120d (2005-)		
	<b>RB9691</b>			<b>RB9692</b>	
	Inner Diameter:	33.5mm		Inner Diameter:	33mm
	Height:	16mm		Clutch Fork Width: <i>Inner Diameter</i>	24mm
	Clutch Fork Width: <i>Inner Diameter</i>	68.5mm		Clutch Fork Width: <i>Outer Diameter</i>	66mm
	Round Face Thrust Bearing			Round Face Thrust Bearing	
Nissan Hardbody 3.0i, D, 3.2i, 3.3i P/up (98-05), X-Trail 2.0, 2.2D, 2.5 (01-08)			Citroen C1 1.0i Furio, Play (2007-), Peugeot 107 1.0i, 1.4 HDi (2007-), Toyota Aygo 1.0 Fresh, Inferno, Wild 3/5-door, X-Cite, X-Play (2007-), Yaris 1.0, 1.3 (2005-)		
	<b>RB9694</b>			<b>RB9697</b>	
	Inner Diameter:	33.5mm		Inner Diameter:	35.5mm
	Clutch Fork to Running Face:	24mm		Height:	18mm
	Clutch Fork Width: <i>Inner Diameter</i>	42.5mm		Clutch Fork Width: <i>Inner Diameter</i>	41mm
		-		Clutch Fork Width: <i>Outer Diameter</i>	72mm
Round Face Thrust Bearing		Round Face Thrust Bearing			
Suzuki Jimny 1.3 SUV (2009-)			Honda Accord VII 2.0i, 2.4i, 2.2i (2004-), Civic 2.0 Type R, 2.2 CTDi (2006-), CR-V II 2.0 K20A4 - 4X4 (05-09), CR-V III 2.0 i-VTEC R20A1, 2.2 i-CTDi N22A2, 2.2 i-DTEC N22B3, 2.4 i-Vtec K24Z1, K24Z4 - 4X4 (09-12), CR-V IV 2.0 R20A6, 9, 2.0 i-VTEC R20A5, 6, 9, 2.2 i-DTEC N22B4, 2.4i K24Z9 - 4X2, 4X4 (2012-)		



## BUYERS GUIDE - THRUST BEARINGS

	<b>RB9698</b>			<b>RB9699</b>	
	Inner Diameter:	37.5mm		Inner Diameter:	32mm
	Height:	31mm		Height:	21mm
	Clutch Fork Width: <i>Inner Diameter</i>	56mm		Clutch Fork Width: <i>Inner Diameter</i>	46mm
	Clutch Fork Width: <i>Outer Diameter</i>	101mm		Clutch Fork Width: <i>Outer Diameter</i>	62mm
	Round Face Thrust Bearing			Round Face Thrust Bearing	
Hyundai Bakkie (2001-), Terrecan 2.9 CRDi, 3.5i V6 - 4X4 (03-08)			Hyundai Tucson 2.0i, CRDi (04-06), iX35 2.0i G4KD 4X2 (2010-), Kia Carens 2.0CVVTi, Sportage 2.0 4X2 (05-06)		
	<b>RB9700</b>			<b>RB9701</b>	
	Inner Diameter:	35mm		Use RB9678	
	Clutch Fork to Running Face:	27mm			
	Clutch Fork Width: <i>Inner Diameter</i>	44mm			
	Round Face Thrust Bearing				
Toyota Fortuner 2.5D-4D, 3.0iD, D-4D, 4.0i V6 SUV (2006-), Hilux 3.0iD & 4.0i V6 P/up - All - 4X2, 4X4 (2005-)			Ford Ranger 2.5D, TD, 3.0TDCi, 4.0 - Some (00-07) Mazda 6 2.0, 2.3 (03-08), Drifter 2.5D, TD, 3.0TDCi (00-07)		
Use RB9671					
	<b>RB9721</b>			<b>RB9801</b>	
	Inner Diameter:	35mm		Inner Diameter:	40mm
	Outer Diameter:	71.5mm		Outer Diameter:	82mm
	Width:	47.5mm		Width:	23.5mm
	Round Face Thrust Bearing			Round Face Thrust Bearing	
Chevrolet 1900 LS, 2500, 3800, 4100 (72-78), Chevair 2.0, DL, 2.3, GL, SR, Commodore 3.8 GL, L, El Camino 4.1, 5.0, El Toro 4.1, Firenza 2.5, GT, Hatch 1900 De Luxe, LS (76-82), Kommando 4.1, Nomad 2.5, Rekord 2.3, GL, L (72-75)			Nissan Skyline 2.0 GL, GLE (87-92), Hardbody 2.0 SL, P/up, 2.4 SE D/cab P/up, 2.4i SL, D/cab P/up, 3.0i SE, D/cab, SL P/up (98-08), NP300 Hardbody 2.0i P/up (2008-), Sani 2.4 S/W, 3.0 Di GL Patrol S/W (98-99)		
	<b>RB9802</b>			<b>RB9803</b>	
	Inner Diameter:	38.5mm		Inner Diameter:	37mm
	Clutch Fork to Running Face:	25.5mm		Clutch Fork to Running Face:	-
	Clutch Fork Width:	46mm		Clutch Fork Width:	-
	Flat Face Thrust Bearing			Round Face Thrust Bearing	
BMW 2500, 3.0 L, 316i, 318i, S, 320i, Diesel, 323i, Ci Coupe, 325i, Ci Coupe, Convertible, TDS, 328i, Convertible, Individual, 333i, 518, 520i, 523i, 525, 525e, 525i, 528i, 530, 535i, 540i, Edition, 635 Csi (69-99), 728, 728i, 735i, 745i, 850i, L, M3, M5, M535i (78-87), Z3 2.8 Roadster, Coupe (97-00)			BMW 316, 316i, 318i, Cabriolet, 323i, 325i, iS Shadowline, Cabriolet (86-93), 518, 518i, 520 (75-85)		

## BUYERS GUIDE - THRUST BEARINGS









	<b>RB9804</b>			<b>RB9805</b>	
	Inner Diameter:	35mm		Inner Diameter:	33.5mm
	Clutch Fork to Running Face:	30.5mm		Height:	25mm
	Clutch Fork Width:	44.5mm		Clutch Fork Width: <i>Inner Diameter</i>	68.5mm
	Round Face Thrust Bearing			Round Face Thrust Bearing	
Toyota Condor 2.4i S/W - 4X2, 4X4 (00-05), Cressida 2.0 GL, S/W, GLE, GLX (86-87), 2.4, GL, GL S/W, GLE, GLE S/W (87-92), Dyna 2.2, 2.4 (86-94), Hilux 2400D Raider, D/cab, S D/cab, S, SR D/cab, SRX Raider P/up (89-05), Hilux "Vigo" 2.7i P/up (2005-), Stallion 2400 P/up (95-04), Stout 2.4 P/up (88-89), Venture 2400 10 Seater Wagon, S/W (95-04), Quantum 2.7 MPV, P/van (2005-)			Nissan Maxima 2.0 QX (97-04), 3.0 QX (00-04), Hardbody 2.5 Custom, D/cab, Hi-Rider, Twin cab P/up (88-98)		
	<b>RB9813</b>			<b>RB9814</b>	
	Inner Diameter:	24mm		Inner Diameter:	34.5mm
	Height:	26mm		Clutch Fork to Running Face:	25mm
	Clutch Fork Width: <i>Inner Diameter</i>	-		Clutch Fork Width:	37.5mm
	Clutch Fork Width: <i>Outer Diameter</i>	82mm			-
Round Face Thrust Bearing		Round Face Thrust Bearing			
Fiat Uno 1100 Fire (With Cable Operated Clutch) (90-91)			Mercedes-Benz W123/126 200 D, E, 220 D, E, 230 E, S (66-95), 230/4, 230/6, 240, 250, 260, 280 (75-77), 300 D, E, 320, 380, 500, W201 190E 1.8, 2.0 (77-94)		
	<b>RB9816</b>			<b>RB9817</b>	
	Inner Diameter:	28mm		Inner Diameter:	32mm
	Clutch Fork to Running Face:	39.5mm		Clutch Fork to Running Face:	36.5mm
	Clutch Fork Width: <i>Inner Diameter</i>	-		Clutch Fork Width:	46mm
	Clutch Fork Width: <i>Outer Diameter</i>	90.5mm			-
Round Face Thrust Bearing		Round Face Thrust Bearing			
Alfa Romeo 155 2.0 TS, 2.5 V6 (96-98), 156 2.0 TS, 2.5 V6 (98-04), GTV 2.0, Spider (96-04), Fiat Punto 1.8 (2004-), Uno 1.4 Turbo (With Hydraulic Operated Clutch) (90-98)			Ford Husky 1.8 P/up, P/van, Mini Bus (85-87), Mazda 323 1.6 GLX Hatchback (79-81), Mitsubishi Colt 2.0, Galant GLX, GSI (72-84), Colt LDV 1.6 Lo-Line P/up (94-98), L3001.8 Mini Bus, P/up, P/van (82-87)		
	<b>RB9819</b>			<b>RB9820</b>	
	Inner Diameter:	28mm		Inner Diameter:	30mm
	Height:	26mm		Height:	21mm
	Clutch Fork Width: <i>Inner Diameter</i>	-		Clutch Fork Width: <i>Inner Diameter</i>	38mm
	Clutch Fork Width: <i>Outer Diameter</i>	90mm			-
Round Face Thrust Bearing		Round Face Thrust Bearing			
Alfa Romeo 145 2.0 Quadrifoglio (96-01), 146 2.0 Ti (96-99), 155 2.0 TS, 2.5 V6 (96-04), 156 2.0 TS, 2.5 V6 (96-98), 164 3.0 V6 Super (98-04), GTV 2.0, Spider, 3.0 V6 (93-02), Fiat Uno 1.4 Pacer, SX (With Cable Operated Clutch). (90-91)			Ford Bantam 130, 160, i, Leisure P/up, 13, 16, 1.6i, Sport, 2.0 GLE, i, RS (92-02), Kia Pride 1.3 LX (98-99), Mazda 323 130 Hatch, Midge, Sedan, Sting, 160, 200e Sedan, i Hatch, Sedan, iE Sedan (90-05), Etude 160, e, i, iE, 180e, Se (95-04), Rustler 130, 160, i, Explorer, Drifter (94-02)		

## BUYERS GUIDE - THRUST BEARINGS

	<b>RB9835</b>			<b>RB9836</b>	
	Inner Diameter:	35mm		Inner Diameter:	32mm
	Outer Diameter:	56.5mm		Height:	22mm
	Width:	14mm		Clutch Fork Width: <i>Inner Diameter</i>	34.5mm
		-		Clutch Fork Width: <i>Outer Diameter</i>	60.5mm
Round Face Thrust Bearing			Round Face Thrust Bearing		
Daihatsu Charade 1.0 CX, CXL, Turbo (83-85), Cuore 847 5 door Hatchback (97-99)			Hyundai Elantra J1 1.6 GLS Exec., 1.8, Exec., GLi (93-95), Sonata 2.0, GL, GLS (94-02), Mitsubishi Tredia 1.4, S, 1.6, SL, 1.8, SLX, Turbo, Vortex (83-86)		
	<b>RB9840</b>			<b>RB9848</b>	
	Inner Diameter:	33mm		Inner Diameter:	32mm
	Height:	13mm		Height:	34.5mm
	Clutch Fork Width: <i>Inner Diameter</i>	68mm		Clutch Fork Width: <i>Inner Diameter</i>	69mm
		-		Clutch Fork Width: <i>Outer Diameter</i>	96mm
Round Face Thrust Bearing			Round Face Thrust Bearing		
Nissan Langley 1.3 (86-88), 1.5 (83-88), Primera 160Si (98-02), Pulsar 1.3 S (83-86), 1.5, GL, Panache (82-87), Sabre 160GX, GXi (94-97), Sentra 140 (92-02)			Isuzu KB320 D/cab LE, Frontier LE, Reef LE P/up, S/W (98-04)		
	<b>RB9849</b>			<b>RB9850</b>	
	Inner Diameter:	41mm		Inner Diameter:	35mm
	Outer Diameter:	81.5mm		Outer Diameter:	77mm
	Width:	19mm		Width:	24.5mm
	Round Face Thrust Bearing			Round Face Thrust Bearing	
Isuzu KB260 LE D/cab, KB280DT D/cab, LE, Frontier, Reef P/up, S/W (92-04)			Isuzu KB250D Std., LE, D/cab P/up (Only Some Models With MUA G/box) (97-04)		
	<b>RB9851</b>			<b>RB9852</b>	
	Inner Diameter:	31mm		Inner Diameter:	38mm
	Height:	25mm		Clutch Fork to Running Face:	17mm
	Clutch Fork Width: <i>Inner Diameter</i>	37mm		Clutch Fork Width:	46mm
	Clutch Fork Width: <i>Outer Diameter</i>	68mm			-
Round Face Thrust Bearing			Round Face Thrust Bearing		
Honda Ballade 150 Encore, Luxline, Spreeline, 150i Encore, Luxline, Spreeline, 160E, 160i Luxline, Spreeline, V-Tec, 180E, 180i Luxline, Spreeline (92-96), Civic 150i Luxline, Spreeline, 160i Luxline, V-Tec (96-00), Civic 1.8i, 2.0i (2006-), Jazz 1.4, 1.5 VTEC (2004-), Jazz IV 1.2 Trend L12B4, 1.5 Elegance L15Z2 (2015-)			Opel Ascona 1.6 GL, 1.8 GLS (82-87), Kadett 1.6 GL, GLS, L, Rebel, 1.8 GLX, GTE, L, 71-76 Manta 1.6 GT, 1.9 DL (82-93), Monza 1.6 GLS, 1.8 GLE, GLi, GLX (86-93)		



# BUYERS GUIDE - THRUST BEARINGS

	<b>RB9853</b>			<b>RB9854</b>	
	Inner Diameter:	33mm		Inner Diameter:	34.5mm
	Clutch Fork to Running Face:	13mm		Clutch Fork to Running Face:	25mm
	Clutch Fork Width:	67.5mm		<i>Clutch Fork Width:</i>	46.5mm
	Round Face Thrust Bearing			Flat Face Thrust Bearing	
<p>Nissan Almera 160 Comfort, 180 Luxury (01-06), Primera 200Si, STi (98-02), Sabre 160GX, GXi, 200GX (94-02), Sentra 1.6 GL, GX, GXE, GXEi Coupe, SGLi, 160GXi, Si, 200GSi, STi (87-02)</p>			<p>Audi 500 2.2 SE, 2.8 SEL (92-94), A4 1.8, Exec., T, Sport, 2.6, Exec., 2.8, Exec. (95-02), S4 Avant, Quattro 2.0 ALT &amp; BGB Engines, 3.0 BBJ Engine (05-09), A6 2.4, 2.6, 2.8, E, Exec. (94-02), S4 2.2, Quattro (92-94), VW Passat 1.8T, 1.9TDi, 2.0FSi, TDi, T FSI, 2.3 V5, 2.8 V6 (99-08)</p>		
	<b>RB9855</b>			<b>RB9856</b>	
	Inner Diameter:	31.5mm		Inner Diameter:	36mm
	Clutch Fork to Running Face:	22mm		Height:	26mm
	Clutch Fork Width: <i>Inner Diameter</i>	42mm		Clutch Fork Width: <i>Inner Diameter</i>	-
	Flat Face Thrust Bearing			Clutch Fork Width: <i>Outer Diameter</i>	77mm
<p>Audi A3 1.8, T (98-03), VW Beetle 1.8T, 2.0i Coupe (2000-), Caddy (2005-), Golf II 2.0 GTi (90-92), Golf III 2.8 VR6 (93-99), Golf IV 1.8T, GTi, Highline, 1.9 TDi Highline, 2.0 (99-04), Golf V 1.9TDi Comfortline, DSG, 2.0i, FSi, Sport, Sport Tiptronic (04-09), Golf VI Jetta II 2.0 CLi 16V (2009-), Jetta III 2.8 VR6 Exec. (93-99), Jetta IV 1.9 TDi Highline, 2.0i Highline (99-06), Jetta V 1.9TDi, Sport, Polo 1.4TDi Classic (2005-), Kombi 2.5TDi Microbus T4 (All, Except Models With ACV Engine) (99-04), 1.9TDi Bus, Van, P/van, P/up (2004-), Scirocco, Tiguan 1.4TSi (2009-)</p>			<p>Ford Courier 2.2 Explorer XLT, Leisure, XLT, Std., 2.5TD (86-00), Ranger 2.5TD, 3.0TDCi, 4.0i V6 (00-07), Spectron 2.2 Bus, P/van (91-04), Kia Sportage 2.0 SUV (99-03), Mazda B2200 Explorer XLT, Leisure, XLT, Std., B2500 TD (86-00), Drifter 2.5TD - 4X4 (00-07), Marathon 2.2 Bus, P/van (91-04)</p> <p style="text-align: center;">Use RB9589</p>		
	<b>RB9861</b>			<b>RB9863</b>	
	Inner Diameter:	32mm		Inner Diameter:	33mm
	Clutch Fork to Running Face:	31mm		Clutch Fork to Running Face:	21.5mm
	Clutch Fork Width: <i>Inner Diameter</i>	46mm		Clutch Fork Width: <i>Inner Diameter</i>	-
	Round Face Thrust Bearing			Clutch Fork Width: <i>Outer Diameter</i>	70mm
<p>Ford Husky 2.0 Bus, P/up, P/van (85-88), Mitsubishi Colt 2.6 Galant (79-84), Colt LDV 2.0 D/cab Lo-Line, Hi-Line P/up (97-98), L300 2.0 P/up, P/van (83-02), Starwagon 2.0, S, SL, SLE Bus, P/up, P/van (86-98), Opel Rekord 380i CD, GSi (91-95)</p>			<p>Toyota Conquest 1.3 GL, GS, L, S, 130, Carri P/van, Sport, Tazz, Tropicque, Zipp, 1.6 GL, RS, RSi, Sport (85-06), Corolla 1.3 GL, L, Sprinter, 130, GLE, 1.6 Avante GLi, GL, GLE, S/W, GLi Exec., Sprinter, GLS, Sprinter, Sport (84-00)</p>		
	<b>RB9866</b>			<b>RB9876</b>	
	Inner Diameter:	35mm		Inner Diameter:	37mm
	Height:	25mm		Height:	31.5mm
	Clutch Fork Width: <i>Inner Diameter</i>	-		Clutch Fork Width: <i>Inner Diameter</i>	55mm
	Clutch Fork Width: <i>Outer Diameter</i>	79mm		-	-
Round Face Thrust Bearing		Round Face Thrust Bearing			
<p>Toyota Camry 200i, Si, 220SEi, Si (92-06), Rav4 I/ II 2.0 SUV (94-06), Rav4 III 2.0i S/W/ SUV (2006-)</p>			<p>Mitsubishi Canter 2.5, 3.3 (80-87), Colt LDV 3.0 D/cab Lo-Line, Hi-Line, Rodeo, Club/Cab, D/cab (95-09), Pajero 3.0 GLS Wagon (93-95), Hyundai Bakkie 2.5i, 2.6i. (Older Model) With Round Lights</p>		

## BUYERS GUIDE - THRUST BEARINGS

	<b>RB9878</b>		<b>RB9880</b>		
	Inner Diameter:		36mm	Inner Diameter:	26.5mm
	Clutch Fork to Running Face:		18mm	Clutch Fork to Running Face:	19.5mm
	Clutch Fork Width:		41mm	Clutch Fork Width: <i>Inner Diameter</i>	30mm
			-	Clutch Fork Width: <i>Outer Diameter</i>	-
	<b>Flat Face Thrust Bearing</b>		<b>Round Face Thrust Bearing</b>		
<p>Opel Astra 140, i, iS, 160i, Estate, iE, , iS (93-99), Corsa 130 Chill, i, Lite, iS, iE, 160 iE, GSi, Sport, 140i, Classic, Lite, 160iE, Classic 96-08, Corsa LDV 130 Utility P/up, 140i Utility P/up, 160i S Utility P/up, 1.7D Utility P/up (97-09), Kadett 1.3, Cub, GL, LS, Rebel,140, CL, Cub, S, GSE, 160 Cub, GSi, i, Aspen, iS, GSE (87-99), Monza 160 GSi, i Aspen, CLS (90-93), Rekord 2.0, GL, 2.0i GLE, Irmscher, 2.2, E (86-95)</p>		<p>Renault Clio 1.4 RT, 1.6 Sport (99-06), Laguna 1.6 RTE, 1.8 RN, RT, 2.0 RT, RXE, RXT (96-07), R9 1.7 TXE R11 1.4TS, TX, TXE, 1.7 TX, TXE (84-86)</p>			
	<b>RB9882</b>		<b>RB9888</b>		
	Inner Diameter:		29mm	Inner Diameter:	37mm
	Clutch Fork to Running Face:		21.5mm	Outer Diameter:	67mm
	Clutch Fork Width: <i>Inner Diameter</i>		31.5mm	Width:	21mm
	Clutch Fork Width: <i>Outer Diameter</i>		47mm		-
	<b>Round Face Thrust Bearing</b>		<b>Round Face Thrust Bearing</b>		
<p>Honda Ballade 130 "Flip up Lights", 150, i, "Flip up Lights", 160i "Flip up Lights" (84-89)</p>		<p>Isuzu KB200 Fleetside, LE P/up, KB230 P/up, KB24 LE P/up (87-97), KB250D P/up (Some Models With MSG G/box), KB29 P/up, KB44 LE P/up, KBD23 P/up. (97-04)</p> <p style="text-align: center;">Please note – Collar not included</p>			
	<b>RB9890</b>		<b>RB9891</b>		
	Inner Diameter:		36mm	Inner Diameter:	33mm
	Height:		25mm	Clutch Fork to Running Face:	22mm
	Clutch Fork Width: <i>Inner Diameter</i>		-	Clutch Fork Width: <i>Inner Diameter</i>	-
	Clutch Fork Width: <i>Outer Diameter</i>		79.5mm	Clutch Fork Width: <i>Outer Diameter</i>	79mm
	<b>Round Face Thrust Bearing</b>		<b>Round Face Thrust Bearing</b>		
<p>Toyota Camry 300SEi (92-01), Rav4 III 2.2D (2006-)</p>		<p>Toyota Auris 1.4, 1.6, 1.8, 2.0D (2007-), Conquest 1.3 L, S, 160i RS, Sport, 180i Sport (92-98), Corolla 160 GL, GLE, i GLE,b RSi, Rxi, Sprinter, GLi Exec., GLS Exec.,180i GLE, GSE, GSX, GL, Sprinter (1993-), Yaris 1.8 (2008-)</p>			
	<b>RB9892</b>		<b>RB9893</b>		
	Inner Diameter:		38mm	Inner Diameter:	31mm
	Clutch Fork to Running Face:		17mm	Height:	27.5mm
	Clutch Fork Width:		46mm	Clutch Fork Width: <i>Inner Diameter</i>	36mm
			-	Clutch Fork Width: <i>Outer Diameter</i>	53.5mm
	<b>Flat Face Thrust Bearing</b>		<b>Round Face Thrust Bearing</b>		
<p>Chevrolet Aveo 1.5 LS, LT (2003-), Daewoo Cielo 150 GL, GLX, Espero 1.8 CD, 2.0 CD (96-98), Lanos 1.35i, S, 1.6 SX, Nubira 2.0 CDX (97-02), Opel Astra 180i, iE, 200i, Estate, iE, ts (93-99), Calibra 2.0 (92-95), Kadett 180i, iE, GSi, 200 Boss, Super Boss, CD, GSi, iS, tS, GSi, SGi (85-99), Monza 1.8 CLX, Convertible, 2.0 Cabrio, CD, CLi, GLi (86-93)</p>		<p>Honda Ballade 150, 160i (89-92)</p>			

## BUYERS GUIDE - THRUST BEARINGS

	<b>RB9894</b>			<b>RB9895</b>	
	Inner Diameter:	33.5mm		Use RB9853	
	Clutch Fork to Running Face:	18mm			
	Clutch Fork Width:	67.5mm			
Round Face Thrust Bearing					
Nissan Sentra 1.3 GL, SX (87-92), Hardbody 4.2 LDF, Patrol P/up (98-08), NP300 Hardbody 2.5TDi P/up (2008-)			Nissan Almera 160 Comfort, 180 Luxury (01-06), Primera 200Si, STi (98-02), Sabre 160GX, GXi, 200GXi (94-02), Sentra 1.6 GL, GX, GXE, GXEi Coupe, SGLi, 160GXi, Si, 200GSi, STi (87-02)		
	<b>RB9896</b>			<b>RB9897</b>	
	Inner Diameter:	35.5mm		Use RB9589	
	Clutch Fork to Running Face:	33.5mm			
	Clutch Fork Width:	44mm			
Round Face Thrust Bearing					
Toyota Cressida 2.0 GLi6, Exec., 3.0 GLS, i ECT (86-92), Condor 1.8 S/W (00-05), Hiace 1.8 LS Wagon, P/van, LS 10 Seater Wagon, P/van, Super10 Super14 (88-08), Hilux 1.8 D/cab, S, SR, Raider P/up, 2.0, S, SR D/cab P/up, 2.2 D/cab, Raider D/cab, SRX P/up, 2.7i Raider, D/cab, SRX P/up (91-05), Hilux "Vigo" 2.0i P/up (2005-), Previa 2.4 S/W (95-98), Stallion 1.5 Commuter, Bus, SR5 (90-91), 1.8, SR5 (91-04), Venture (91-04)			Kia Sportage 2.0i, 2.0CRDi, 2.7 SUV (04-06)		
	<b>RB9899</b>			<b>RB9900</b>	
	Inner Diameter:	34mm		Inner Diameter:	32mm
	Height:	-		Clutch Fork to Running Face:	27mm
	Clutch Fork Width: <i>Inner Diameter</i>	-		Clutch Fork Width:	46mm
Clutch Fork Width: <i>Outer Diameter</i>		-	Round Face Thrust Bearing		
Suzuki SJ413 1.3, 1.6 Samurai - 4X4 (86-91), Swift SF413 1.3, 1.6 - 4X4 (92-97), Vitara SE416 1.6 - 4X4 (88-92)			Hyundai Bakkie/H100 2.5 & 2.6 P/up, P/van (1997-), Mitsubishi Colt LDV 2.5, 2.6, 2.0, 2.0i, 2.0 Std Single, 2.0i Std, Hi-Line S/C P/up - 4X2, 4X4 (94-09), Triton 2.4MPI, 2.5DiD, 3.2DiD, 3.5 V6 P/up - 4X2, 4X4 (2007-)		
		<b>6207ZZ</b>			
		Inner Diameter:	35mm		
		Outer Diameter:	72mm		
		Width:	17mm		
		Round Face Thrust Bearing			
Land Rover Series II, IIA 88" 2.25 SWB P/up, Series II, IIA 109" 2.25 SWB, LWB P/up (58-78)					







































## BUYERS GUIDE - HUBS

Part Number		Picture & Application		Holes/Studs	Spigot Diameter	
<b>099HUB</b>		 	Toyota Quantum 2.5D Family P/can, Bus, 2.7 Family, Ses'Fikile P/van, Bus (2005-) - Fr. Hub	<b>6 Bolt Holes:</b> M10 x 1.5	Disc centre spigot:	106mm
Bearing:	HUB099			<b>6 Studs:</b> M10 x 1.25		
Bearing ID:	54mm			<b>Splines:</b>	<b>Notes:</b>	
Outer Diameter:	180mm					
Height:	101.3mm 140mm				<b>PQ728</b> PCD: 127mm/ PCD: 140mm	
<b>106HUB</b>		 	Chevrolet Aveo (03-15), Daewoo Espero (96-99), Lanos I,II, Nubira I, II (97-03). Opel Ascona 1.6, 1.8 (82-87), Astra F 1.8, 2.0 (93-99), Corsa B 1.3, 1.4, 1.6 (96-03), Kadett D, E 1.6, 1.8, 2.0 (80-93), Kadett F (93-99), Monza 1.8, 2.0 (86-93)	<b>Bolt Holes:</b> 4: M12 x 1.5 2: M13 x 1.5 1: M6 x 1	Disc centre spigot:	56.5mm
Bearing:	309639			<b>Splines:</b>		
Bearing ID:	39mm					
Outer Diameter:	120mm			33		
Height:	59mm 81mm				<b>PQ106</b> PCD: 100mm	
<b>106BHUB</b>		 	BMW 3 Series E36/Dolphin Shape - Only Models With Rear Drums (92-99)	<b>5 Bolt Holes:</b> M12 x 1.5	Disc centre spigot:	72.5mm/ 75mm
Bearing:	309639			<b>1 Bolt Holes:</b> M8 x 1.25		
Bearing ID:	39mm			<b>Splines:</b>	<b>Notes:</b>	
Outer Diameter:	145mm			27		
Height:	54mm 73mm				<b>PQ106</b> PCD: 104mm/ PCD: 120 mm	
<b>106CHUB</b>		 	BMW 3 Series E30 - Models Without ABS (83-92) - Rr. Hub	<b>4 Bolt Holes:</b> M12 x 1.5	Disc centre spigot:	57mm/ 62mm
Bearing:	309639			<b>1 Bolt Holes:</b> M8 x 1.25		
Bearing ID:	39mm			<b>Splines:</b>	<b>Notes:</b>	
Outer Diameter:	138mm			27		
Height:	65.5mm 87mm				<b>PQ106</b> PCD: 100mm	
<b>106FHUB</b>		 	Ford Escort 1.4, 1.6, 1.8 (95-00), Fiesta I 1.3, 1.4, 1.6 (97-04), Fiesta II 1.4,1.6, 2.0 (04-09), Ikon 1.3, 1.6 (01-06), Ikon 1.4, 1.6 (07-11), KA 1.3 (05-09), Bantam "Boet" 1.3, 1.4, 1.6, 1.8d (02-12), Mazda 121 Soho 1.3, 1.4 (97-99) - Fr. Hub	<b>4 Studs:</b> M12 x 1.5	Disc centre spigot:	63mm
Bearing:	309639			<b>Splines:</b>		
Bearing ID:	39mm					
Outer Diameter:	131mm			25		
Height:	74mm 85.5mm				<b>PQ106</b> NON ABS PQ499 ABS PCD:108mm	

## BUYERS GUIDE - HUBS











Part Number		Picture & Application		Holes/Studs	Spigot Diameter		
<b>107HUB</b>		 	Bolt Holes: 4: M12 x 1.5 2: M6 x 1	Disc centre spigot:	57mm/ 65mm		
Bearing:	309726				<b>Splines:</b>  22	<b>Notes:</b>	
Bearing ID:	34mm			<b>PQ107</b> <i>PCD: 100mm</i>			
Outer Diameter:	120.5mm						
Height:	54.5mm 73.5mm			Daewoo Cielo 1.5 (96-99), Lanos II 1.4 S, 1.6 SX (97-03), VW Citi Golf 1.3, 1.4 1.6, iL, 1.8 (83-09), Fox 1.3, 1.6, 1.8 (87-96), Golf I 1.1, 1.3, 1.5, 1.6, 1.8 (78-84), Jetta I 1.3, 1.5, 1.6, 1.8, 81-97 Caddy 1.6, 1.8 (80-85) - Fr. Hub			
<b>108HUB</b>		 	Bolt Holes: 4: M12 x 1.5 2: M6 x 1	Disc centre spigot:	57mm		
Bearings:	331274 11710/49				<b>Splines:</b>  Notes:	<b>PQ108</b> <i>PCD: 100mm</i>	
Shaft OD:	69.4mm						
Outer Diameter:	136mm						
Height:	62.3mm 80mm			Opel Corsa B 1.3, 1.4, 1.6, 1.8 (96-03) - Rr. Hub			
<b>109HUB</b>		 	<b>4 Bolt Holes:</b> M8 x 1.25	Disc centre spigot:			
Bearing:	29710/49				<b>4 Studs:</b> M12 x 1.25	<b>Notes:</b>	
Bearing ID:	38.1mm		<b>Splines:</b>  24	<b>PQ109</b> <i>PCD: 96mm</i> <i>PCD: 114mm</i>			
Outer Diameter:	158mm						
Height:	64mm 94mm		Nissan Langley 1.5 (9-83-88), Pulsar 1.4, 1.5 [Local] (80-57) - Fr. Hub				
<b>121HUB</b>		 	<b>4 Bolt Holes:</b> M10 x 1.5	Disc centre spigot:	70mm		
Bearings:	44610/49 11710/49				<b>4 Studs:</b> M12 x 1.5	<b>Notes:</b>	
Shaft OD:	50.3mm 60mm		<b>Splines:</b>  Notes:	<b>PQ121</b> <i>PCD: 114mm</i>			
Outer Diameter:	153.5mm						
Height:	52 88.5mm		Nissan B140 1.4 A14S, P/van, Deluxe, Std., Sport, CHAMP P/up (80-08) - Fr. Hub				
<b>122HUB</b>		 	Bolt Holes: 4: M12 x 1.5 2: M13 x 1.5 1: M6 x 1	Disc centre spigot:	56.5mm		
Bearings:	309726 636114				<b>Splines:</b>  22	<b>Notes:</b>	
Bearing ID:	34mm			<b>PQ122</b> <b>PQ417</b> <i>PCD: 100mm</i>			
Outer Diameter:	120mm						
Height:	56mm 78mm			Chevrolet Corsa Utility (2010-), Opel Ascona 1.3L (82-87), Astra F 1.4, 1.6 (93-99), Corsa B 1.3, 1.4, 1.6 (96-03), Kadett D, E, F (80-99), Monza 1.6 (86-93), Corsa LDV II Utility (97-04), Corsa Pronto 1.3i (99-00) - Fr. Hub			

## BUYERS GUIDE - HUBS











Part Number		Picture & Application		Holes/Studs	Spigot Diameter		
<b>136HUB</b>		 	Toyota Venture 1.8 (8/10 Seater) P/van (90-96) - Fr. Hub	<b>4 Bolt Holes:</b> M10 x 1.5	Disc centre spigot:	57mm/ 60mm	
Bearings:	67010/48 11910/49			<b>4 Studs:</b> M12 x 1.5			
Shaft OD:	71mm			<b>Splines:</b>	<b>Notes:</b>		
Outer Diameter:	159mm				<b>PQ136</b> PCD: 94mm PCD: 114mm		
Height:	96mm 101mm						
<b>136AHUB</b>		 	Toyota Venture 2.2 Getaway, GLE P/van, Bus, 2.4D P/van (95-04) - Fr. Hub	<b>4 Bolt Holes:</b> M10 x 1.5	Disc centre spigot:	56mm/ 60mm	
Bearings:	67010/48 11910/49			<b>4 Studs:</b> M12 x 1.5			
Shaft OD:	70.8mm			<b>Splines:</b>	<b>Notes:</b>		
Outer Diameter:	159mm				<b>PQ136</b> PCD: 100mm PCD: 140 mm		
Height:	96mm 100.4mm						
<b>136BHUB</b>		 	Toyota Cressida 1.8L, 1.8LS, 2.0GL, GLE, GLX, 2.0GLi6, Exec.(6Cly.) 2.4GL, GLE, 2.8i, RSi, Exec, 3.0GLS, 3.0i ECT (80-92) - Fr. Hub	<b>4 Bolt Holes:</b> M10 x 1.5	Disc centre spigot:	76mm	
Bearings:	67010/48 11910/49			<b>Splines:</b>			<b>Notes:</b>
Shaft OD:	45.2mm 59.1mm				<b>PQ136</b> PCD: mm		
Outer Diameter:	160mm						
Height:	96mm						
<b>139HUB</b>		 	Mazda 626 1.6 Sedan, S, Coupe, Hatch SL, 1.8L, 2.0SL, SLX, SLE, EG <i>i</i> , SL <i>i</i> (83-93) - Fr. Hub	<b>4 Bolt Holes:</b> M9 x 1.25	Disc centre spigot:	75mm	
Bearing:	309396			<b>4 Studs:</b> M12 x 1.5			
Bearing ID:	39mm			<b>Splines:</b>	<b>Notes:</b>		
Outer Diameter:	154mm			26	<b>PQ139</b> PCD: 114mm		
Height:	93mm						
<b>141HUB</b>		 	Ford Escort FWD MkIII 1.3, 1.6 (81-86), Bantam 1.3, 1.4 Leisure, 1.6 (83-94), Mazda Rustler 1.3, 1.4, 1.6LX (86-94) - Fr. Hub	<b>4 Bolt Holes:</b> M12 x 1.5	Disc centre spigot:	63mm	
Bearing:	68111 /573315			<b>Splines:</b>			<b>Notes:</b>
Bearing ID:	35mm			23	<b>PQ141</b> PCD: 108mm PCD: 107mm		
Outer Diameter:	105mm 122mm						
Height:	62.8mm 81.5mm						







## BUYERS GUIDE - HUBS

Part Number		Picture & Application		Holes/Studs	Spigot Diameter	
<b>167HUB</b>		 	VW Golf II/Jetta II 1.3, 1.6, 1.8 16V, 2.016V (89-92), Golf III/Jetta III 1.6, 1.8, 2.0 (92-99), Polo 1.8 Playa, Classic Lux (96-03) - Fr. Hub	<b>Bolt Holes:</b> 4 M12 x 1.5 1 M6 x 1	Disc centre spigot:	57mm/ 65mm
Bearing:	311443					
Bearing ID:	40mm			<b>Splines:</b>  22	<b>Notes:</b>  PQ167 PCD: 100mm	
Outer Diameter:	120mm					
Height:	55mm 74mm					
<b>169HUB</b>		 	VW Golf II/Jetta II 1.3, 1.6, 1.8 8/16V, 2.0 8/16V (84-89) - Fr. Hub	<b>Bolt Holes:</b> 4 M12 x 1.5 1 M6 x 1	Disc centre spigot:	57mm/ 65mm
Bearing:	311309					
Bearing ID:	35mm			<b>Splines:</b>  22	<b>Notes:</b>  PQ169 PCD: 100mm	
Outer Diameter:	120mm					
Height:	54.5mm 73mm					
<b>171HUB</b>		 	C.A.M Inyathi, Rhino 2.2i (2007-), Hiace 1.8, 2.0, 2.2 [All Import/ Local Models] (86-09), Hilux 1.8, 2.0, 2.2, 2.4, 2.7i, 2.8D (79-05)- Fr. Hub	<b>5 Bolt Holes:</b> M10 x 1.5	Disc centre spigot:	61mm/ 67mm
Bearing:	48510/48					
Shaft OD:	50mm 64.5mm			<b>5 Studs:</b> M12 x 1.5	<b>Notes:</b>  PQ171 PCD: 114mm	
Outer Diameter:	159.7mm					
Height:	100mm 107mm					
<b>178HUB</b>		 	Nissan E20 1.8, 2.0 (80-96), 720 D20 (80-88), 1-Tonner/ Hardbody AW/ D21 1.6, 1.8, 2.0, 2.4, 2.5D, 2.7D, 3.0 (88-98), QW/ D22 2.0, i, 2.4i, 2.7D, 3.0i, TD, 3.2, 3.3i (98-11), NP300 (2008-) - Fr. Hub	<b>6 Bolt Holes:</b> M10 x 1.25	Disc centre spigot:	63mm/ 90mm
Bearings:	48510/48 12610/49					
Shaft OD:	80mm			<b>Splines:</b>  22	<b>Notes:</b>  PQ178 PCD: 103mm PCD: 140mm	
Outer Diameter:	183.5mm					
Height:	73.8mm 96mm					
<b>178AHUB</b>		 	Nissan Hardbody QW/ D22 2.0i, 2.4i, 2.7D, 3.0i, TD, 3.2, 3.3i, - 4X2 (98-11), NP300 2.0, 2.5TDi (2008-), Sani 2.4, i, 2.5, 2.7D, 3.0 (89-99) - Fr. Hub	<b>6 Bolt Holes:</b> M10 x 1.25	Disc centre spigot:	100mm
Bearings:	48510/48 12610/49					
Shaft OD:	79mm/ 80mm			<b>Splines:</b>  22	<b>Notes:</b>  PQ178 PCD: 103mm PCD: 140mm	
Outer Diameter:	184mm					
Height:	74mm 97mm					

## BUYERS GUIDE - HUBS







Part Number		Picture & Application		Holes/Studs	Spigot Diameter	
<b>184HUB</b>		 	<b>4 Studs:</b> M12 x 1.5  <b>Splines:</b>  24	Disc centre spigot:	59.5mm	<b>Notes:</b>  <b>PQ184</b> <i>PCD: 94mm</i> <i>PCD: 114mm</i>
Bearing:	69310/45					
Bearing ID:	38mm					
Outer Diameter:	152mm					
Height:	66.5mm 92.5mm					
		Ford Laser 1.3, 1.4, 1.6, 2.0, Meteor 1.3, 1.4, 1.5, 1.6, 2.0 (86-95), Bantam 1.3, 1.6 (94-03), Mazda 323 FWD 1.3, 1.5, 1.6, 2.0 Hatch, Sedan, 1.3, 1.6 Midge, Sting Hatch, Sedan (81-05), Rustler 1.3, 1.6 Drifter (94-02) - Fr. Hub				
<b>184NHUB</b>		 	<b>4 Studs:</b>  <b>Splines:</b>  24	Disc centre spigot:	54mm 55mm	<b>Notes:</b>  <b>PQ184N</b> <i>PCD: 100mm</i>
Bearing:	69310/49					
Bearing ID:	38mm					
Outer Diameter:	122mm					
Height:	72.4mm 90mm					
		Kia Pride 1.3i, Rio I 1.3, 1.5 (98-04) - Fr. Hub				
<b>189HUB</b>		 	<b>4 Bolt Holes:</b> M10 x 1.25  <b>4 Studs:</b> M12 x 1.5  <b>Splines:</b>  25	Disc centre spigot:	67mm	<b>Notes:</b>  <b>PQ189</b> <i>PCD: 104mm</i> <i>PCD: 114mm</i>
Bearing:	29710+ 57410					
Bearing ID:	38mm					
Outer Diameter:	154mm					
Height:	70.5mm 85.5mm					
		Hyundai Accent 1.3 G4EH, 1.5 G4EK (94-00), Elantra J1 1.6 G4CR, 1.8 G4CN (93-95), S Coupe 1.5 (94-95) - Fr. Hub				
<b>189AHUB</b>		 	<b>4 Studs:</b> M12 x 1.5  <b>Splines:</b>  25	Disc centre spigot:		<b>Notes:</b>  <b>PQ189</b> <i>PCD: 114mm</i>
Bearing:	29710/ 57410					
Bearing ID:	38mm					
Outer Diameter:	141mm					
Height:	78mm					
		Hyundai Atos 1.0 Prime (00-05), 1.1 (2005-) - Fr. Hub				
<b>190HUB</b>		 	<b>6 Bolt Holes:</b> 10mm  <b>6 Studs:</b> M12 x 1.25  <b>Splines:</b>  25	Disc centre spigot:	84mm	<b>Notes:</b>  <b>PQ190</b> <i>PCD: mm</i>
Bearings:	48510/48 12610/49					
Shaft OD:	50mm 65.1mm					
Outer Diameter:	185mm					
Height:	100mm					
		Mitsubishi Colt LDV 1.6, 2.0, 2.4i, 2.5D, 2.6, 2.8D, TDi, 3.0i V6 P/up - 4X2, 4X4 (94-09) - Fr. Hub				

# BUYERS GUIDE - HUBS





Part Number		Picture & Application		Holes/Studs	Spigot Diameter		
<b>190AHUB</b>			<b>5 Bolt Holes:</b> M10 x 1.25 <b>5 Bolt Holes:</b> M14 x 1.25	Disc centre spigot:	61mm/ 67mm		
Bearings:	48510/48 12610/49				<b>Splines:</b>	<b>Notes:</b>	
Shaft OD:	85mm			<b>PQ190</b> PCD: 108mm PCD: 120mm			
Outer Diameter:	162mm						
Height:	73mm 99.5mm						
<b>197HUB</b>			<b>5 Bolt Holes:</b> M12 x 1.5 <b>1 Hole:</b> M8 x 1.25	Disc centre spigot:	72.5mm/ 75mm		
Bearing:	309245				<b>Splines:</b>	<b>Notes:</b>	
Bearing ID:	42mm		<b>PQ197</b> PCD: 104mm PCD: 120mm				
Outer Diameter:	145mm						
Height:	60mm 79mm						BMW 1 Series E87 1.6i, 1.8i, 2.0i, 2.0 N47, 3.0i (04-15), 3 Series E90 320d, 320i (05-13) - Rr. Hub
<b>197AHUB</b>			<b>5 Bolt Holes:</b> M10 x 1.5 <b>1 Bolt Holes:</b> M7 x 1.25	Disc centre spigot:	72.5mm/ 75mm		
Bearing:	309245				<b>Splines:</b>	<b>Notes:</b>	
Bearing ID:	42mm		<b>PQ197</b> PCD: 120mm				
Outer Diameter:	145mm						
Height:	54mm 73mm						BMW 3 Series E36 Dolphin Shape 316i, 318i, 320i, 323i, 325i, 328i, Z3 (92-00), E46 316i, 318i, 320i, 323i, 325i, 328i, 33.d, ,330i (98-05) - Rr. Hub
<b>197BHUB</b>		Arriving Soon!		Disc centre spigot:	79mm		
Bearing:	309245	<b>Splines:</b>	<b>Notes:</b>				
Bearing ID:	42mm		<b>PQ197</b> PCD: mm				
Outer Diameter:	145mm						
Height:	73mm	BMW 3 Series - E36, E46 (1983-), X1 18d/i, 20d, 23d, 25i (2009-) - Rr. Hub					
<b>234HUB</b>			<b>6 Bolt Holes:</b> M10 x 1.25 M12.4 x 1.5	Disc centre spigot:	82mm/ 93mm		
Bearings:	48510/48 30205				<b>Splines:</b>	<b>Notes:</b>	
Shaft OD:	86mm		<b>PQ234</b> PCD: 108mm PCD: 140mm				
Outer Diameter:	184mm						
Height:	74.2mm 91mm						Ford Courier - All (86-00), 3.4 (97-01), Ranger 1.8, 2.2, 2.5 (00-05), Spectron 2.2 (91-04), Mazda B-Series 1.6, 1.8, 2.0, 2.2, 2.5, 3.0, 3.4, 00-01 2.6i (86-00), Drifter 1.8, 2.2, 2.5Td, 2.6i (-2004), Marathon 2.2 (91-04)- Fr. Hub













## BUYERS GUIDE - HUBS

Part Number		Picture & Application		Holes/Studs	Spigot Diameter	
<b>309HUB</b>		 	Renault Clio I/II 1.2, 1.4, 1.5, 1.6, 2.0, 3.0 (99-04), R9/R11 1.4, 1.7 (83-86) - Fr. Hub	<b>4 Bolt Holes:</b> M12 x 1.5	Disc centre spigot:	61mm
Bearing:	GB12004			<b>2 Bolt Holes:</b> M8 x 1.25		
Bearing ID:	35mm			<b>Splines:</b>	<b>Notes:</b>	
Outer Diameter:	121mm			21	<b>PQ309</b> <i>PCD: mm</i>	
Height:	75mm					
<b>313AHUB</b>		 	Toyota Rav4 I 2.0 (94-01) - Fr. Hub	<b>5 Studs:</b> M12 x 1.5	Disc centre spigot:	60mm/ 62mm
Bearing:	38003			<b>Splines:</b>		
Bearing ID:	38mm			26	<b>PQ313</b> <i>PCD: 114mm</i>	
Outer Diameter:	140mm					
Height:	75mm 90mm					
<b>314HUB</b>		<b>Arriving Soon!</b>			Disc centre spigot:	
Bearing:	28006			<b>Splines:</b>		
Bearing OD:	61mm				<b>PQ314</b> <i>PCD: mm</i>	
Outer Diameter:						
Height:				Toyota Conquest 1.3, 1.6 (85-91), Corolla 1.3, 1.6 (84-91) - Rr. Hub		
<b>318HUB</b>		 	Toyota Hilux 2.2 Raider, 2.4D D/C P/up, Raider, 2.8D Raider D/C P/up - 4X4 (86-98) - Fr. Hub	<b>Bolt Holes:</b> 6 M8 x 1.25mm 2 M10 x 1.25mm	Disc centre spigot:	105mm
Bearing:	104910/48 102910/49			<b>6 Studs:</b> M8 x 1.25		
Shaft OD:	93mm			<b>Splines:</b>	<b>Notes:</b>	
Outer Diameter:	186mm				<b>PQ318</b> <i>PCD: 140mm</i>	
Height:	57mm 117mm					
<b>318AHUB</b>		<b>Arriving Soon!</b>			Disc centre spigot:	
Bearing:	104910/48 102910/49			<b>Splines:</b>		
Bearing OD:	73.4mm 82.5mm				<b>PQ318</b> <i>PCD: mm</i>	
Outer Diameter:						
Height:				Toyota Land Cruiser 100 4.0 (98-06), FZJ/UZJ100 4.2 (02-08) - Fr. Hub		





















# BUYERS GUIDE - HUBS

Part Number		Picture & Application		Holes/Studs	Spigot Diameter		
<b>318BHUB</b>		<b>Arriving Soon!</b>			Disc centre spigot:		
Bearings:	104910/48 102910/49						
Bearing OD:	73.4mm 82.5mm			<b>Splines:</b>	<b>Notes:</b>		
Outer Diameter:	184mm				<b>PQ318 PCD: mm</b>		
Height:	107mm			Toyota Land Cruiser HDJ100 4.2, 4.5, 4.7 (97-04), UZJ100 4.5 - 4X4 (98-06) - Fr. Hub			
<b>318CHUB</b>		<b>Arriving Soon!</b>			Disc centre spigot:		
Bearings:	104910/48 102910/49						
Bearing OD:	73.4mm 82.5mm			<b>Splines:</b>	<b>Notes:</b>		
Outer Diameter:					<b>PQ318 PCD: mm</b>		
Height:				Toyota Land Cruiser FJ80 4.0 (90-92), FZJ80 4.5 (92-06), HDJ/ HZJ80 4.2 - 4X4 (95-01) - Fr. Hub			
<b>318DHUB</b>		<b>Arriving Soon!</b>			Disc centre spigot:		
Bearings:	104910/48 102910/49						
Bearing OD:	73.4mm 82.5mm			<b>Splines:</b>	<b>Notes:</b>		
Outer Diameter:					<b>PQ318 PCD: mm</b>		
Height:				Toyota Land Cruiser HZJ76 4.2D 4X4 (2009-) - Fr. Hub			
<b>335HUB</b>				<b>4 Studs:</b> M12 x 1.5	Disc centre spigot:	59mm/ 61mm	
Bearing:	DAC80WD8	<b>Nissan Sentra 1.3 GL, SX, 1.6 GL, GX, 1.8i (87-92) - Fr. Hub</b>					
Bearing ID:	38mm			<b>Splines:</b>	<b>Notes:</b>		
Outer Diameter:	120.5mm			25	<b>PQ335 PCD: 100mm</b>		
Height:	81.5mm 96.5mm						
<b>346HUB</b>				<b>6 Bolt Holes:</b> M12 x 1.5	Disc centre spigot:	66mm/ 92mm	
Bearings:	48510/48 12610/49	<b>Isuzu KB160, KB200, KB220, KB230, KB260, KB320, KB250D, KB280DT (89-04), KBD20, 21, 22 (87-89), KB200i, KB250i, Dc, KB300TDi (04-09), KB240i - 4X2 (04-12) - Fr. Hub</b>					
Shaft OD:	80mm			<b>6 Studs:</b> M12 x 1.5	<b>Notes:</b>		
Outer Diameter:	183.5mm			<b>Splines:</b>	<b>PQ346 PCD: 108mm PCD: 138mm</b>		
Height:	58mm 95mm						

## BUYERS GUIDE - HUBS











Part Number		Picture & Application		Holes/Studs	Spigot Diameter		
<b>347HUB</b>		 	Isuzu KB220, KB230, KB250D, KB260, KB280DT, KB320 (89-04), KB200i, KB240i, KB300TDi (04-09), KB250i, KB300TDi - 4X4 (04-13) - Fr. Hub	<b>6 Bolt Holes:</b> M12 x 1.5	Disc centre spigot:	99.4mm	
Bearings:	32009 32008			<b>6 Studs:</b> M10 x 1.25			
Shaft OD:	68mm 75mm			<b>Splines:</b>	<b>Notes:</b>		
Outer Diameter:	184mm				<b>PQ347</b> <i>PCD: 140mm</i>		
Height:	58.5mm 90.7mm						
<b>352HUB</b>		 	Nissan Hardbody/1-Tonner 2.4, i, 2.7, 3.0, TD, 3.2, D, 3.3i - 4X4 (88-98), Patrol 3.0, Di, 4.2 4X4 (95-00), Sani 2.2, 2.4, 2.7, 3.0 (86-98), Terrano II 2.7 4X4 (00-02) - Fr. Hub	<b>6 Studs:</b> M12 x 1.5	Disc centre spigot:	100mm	
Bearings:	603011/49 300811/49			<b>Splines:</b>			<b>Notes:</b>
Shaft OD:	100mm				<b>PQ352</b> <i>PCD: 139mm</i>		
Outer Diameter:	183.5mm						
Height:	85mm 86mm						
<b>352AHUB</b>		 	Nissan Hardbody NP300 - All Std. Body Models - 4X2 (2008-) - Fr. Hub	<b>6 Studs:</b> M12 x 1.25	Disc centre spigot:	100mm	
Bearing:	603011/49 300811/49			<b>Splines:</b>			<b>Notes:</b>
Shaft OD:	100mm				<b>PQ352</b> <i>PCD: 140mm</i>		
Outer Diameter:	181mm						
Height:	89mm 86.7mm						
<b>353HUB</b>		 	Toyota Camry I 200i, 220 (92-01), 300SEi (94-01), Rav4 II 2.0 - 4X4 (02-06) - Fr. Hub	<b>5 Studs:</b> M12 x 1.5	Disc centre spigot:	60mm/ 61.8mm	
Bearing:	43BWD06			<b>Splines:</b>			<b>Notes:</b>
Bearing ID:	43mm				<b>PQ353</b> <i>PCD: 114mm</i>		
Outer Diameter:	139mm			30			
Height:	61.7mm 76mm						
<b>353AHUB</b>		 	Toyota Camry I 200i, 220 (92-01), 300SEi, 02-06 RAV4 II 2.0 - 4X4 (94-01) - Fr. Hub	<b>5 Studs:</b> M10 x 1.25	Disc centre spigot:	60mm/ 61.8mm	
Bearings:	43BWD06			<b>Splines:</b>			<b>Notes:</b>
Bearing ID:	43mm				<b>PQ353</b> <i>The difference between 353HUB &amp; 353AHUB is the spline count!</i>		
Outer Diameter:	139mm			26			
Height:	61.7mm 76mm						

# BUYERS GUIDE - HUBS



Part Number		Picture & Application		Holes/Studs	Spigot Diameter	
<b>377HUB</b>		 	 	<b>4 Studs:</b> M12 x 1.5	Disc centre spigot:	54mm
Bearings:	38003 DAC387233				<b>Splines:</b>	<b>Notes:</b>
Bearing ID:	38mm			26		<b>PQ313 / PQ377</b> <i>PCD: 100mm</i> <i>Takes brake disc with 54mm ID</i>
Outer Diameter:	125mm				Toyota Conquest EE80/90R 1.3, Tazz 1.3, AE82R 1.6, AE92R 1.6i Tazz (88-06), AE93 1.8i (93-96), Corolla FWD AE82R 1.6, AE/EE80R/EE90R/EE110R 1.3 (84-02), AE92R 1.6 (88-96), AE93R 1.8i (93-96), AE111R 1.6i, 1.8i (96-02), Conquest 130 Carri P/van (98-06) - Fr. Hub	
Height:	61mm 91mm					
<b>377AHUB</b>		 	 	<b>4 Studs:</b> M12 x 1.5	Disc centre spigot:	55mm
Bearing:	38003 DAC387233				<b>Splines:</b>	<b>Notes:</b>
Bearing ID:	38mm			26		<b>PQ377</b> <i>PCD: 100mm</i> <i>Takes brake disc with 55mm ID</i>
Outer Diameter:	125mm				Toyota Conquest EE80/90R 1.3, Tazz 1.3, AE82R 1.6, AE92R 1.6i Tazz (88-06), AE93 1.8i (93-96), Corolla FWD AE82R 1.6, AE/EE80R/EE90R/EE110R 1.3 (84-02), AE92R 1.6 (88-96), AE93R 1.8i (93-96), AE111R 1.6i, 1.8i (96-02), Conquest 130 Carri P/van (98-06) - Fr. Hub	
Height:	61mm 90.5mm					
<b>393HUB</b>		 	 	<b>Bolt Holes:</b> 4 M12 x 1.25 2 M8 x 1.25	Disc centre spigot:	58mm
Bearings:	616890				<b>Splines:</b>	<b>Notes:</b>
Bearing ID:	30mm			20		<b>PQ393</b> <i>PCD: 98mm</i>
Outer Diameter:	117mm				Fiat Uno 1.0 Cento, 1100 Fire, Mia, Rio, Tempo, 1400 Beat, Mia, Pacer, SX, Tempo SX, Pacer SX (90-05), Uno 1.1 Espresso P/van (93-05) - Fr. Hub	
Height:	58mm 78mm					
<b>401HUB</b>		 	 	<b>Bolt Holes:</b> 6 M12 6 M10 x 1.25 6 M8 x 1.25	Disc centre spigot:	89mm/ 93mm
Bearing:	102910/49 69310/49				<b>Splines:</b>	<b>Notes:</b>
Shaft OD:	80mm			26		<b>PQ401</b> <i>PCD: 116mm</i> <i>PCD: 140mm</i>
Outer Diameter:	184.5mm				Ford Courier 2.5TD, 3.0 V6, 3.4 V6 - 4X4 (96-00), Ranger 1.8, 2.2 - 4X2 (04-10), Ranger 2.5, TD, 3.0TDCi, 4.0 4X4 (00-12), Mazda Drifter 1.8, 2.2, 2.5Td, 2.6i - 4X2, 4X4 (04-09), B-Series 2.5, 2.6, i, 3.0, 3.4 V6 - 4X4 (96-09) - Fr. Hub	
Height:	79.5mm 97mm					
<b>408HUB</b>		 	 	<b>4 Studs:</b> M12 x 1.5	Disc centre spigot:	56mm/ 61mm
Bearing:	DAC387340				<b>Splines:</b>	<b>Notes:</b>
Bearing ID:	38mm			26		<b>PQ408</b> <i>PCD: 100mm</i>
Outer Diameter:	121mm				Honda Ballade SO4 150, 160E, i, 180E, i (92-98), Odyssey 2.2, 2.3 V-Tec (96-02) - Fr. Hub	
Height:	54mm 84.5mm					



















## BUYERS GUIDE - HUBS

Part Number		Picture & Application		Holes/Studs	Spigot Diameter	
<b>414HUB</b>		 	<p><b>4 Studs:</b> M12 x 1.25</p> <p><b>Splines:</b> 25</p>	Disc centre spigot:	59mm/ 61mm	
Bearing:	38003				<b>Notes:</b>	<b>PQ414</b> <i>PCD: 100mm</i>
Bearing ID:	38mm					
Outer Diameter:	122mm					
Height:	57.5mm 90mm			Nissan Sabre 160 GX, GXi, 200GXi (94-02), Sentra 140, GX, GXi, Si, 160, GX, GSi, GXEi, SE, Si, 200 GSi, STi (92-02) - Fr. Hub		
<b>422HUB</b>		 	<p><b>4 Bolt Holes:</b> 10mm</p> <p><b>4 Studs:</b> M12 x 1.5</p> <p><b>Splines:</b> 25</p>	Disc centre spigot:	67mm	
Bearing:	DAC387037				<b>Notes:</b>	<b>PQ422</b> <i>PCD: 114mm</i>
Bearing ID:	38mm					
Outer Diameter:	150mm					
Height:	63mm 72.7mm			Hyundai Elantra J2 1.6 G4GR, 1.8 G4FG, 2.0 G4GC (95-01) - Fr. Hub		
<b>422AHUB</b>		 	<p><b>2 Bolt Holes:</b> M6 x 1.00</p> <p><b>4 Studs:</b> M12 x 1.5</p> <p><b>Splines:</b> 25</p>	Disc centre spigot:	54mm/ 62mm	
Bearing:	DAC387037				<b>Notes:</b>	<b>PQ422</b> <i>PCD: 100mm</i>
Bearing ID:	38.3mm					
Outer Diameter:	120mm					
Height:	57mm 92mm			Hyundai Accent 1.3, 1.5, 1.6 (2000-), Atos 1.0, 1.1 (00-13), Getz 1.3, 1.4i, 1.5i, 1.6i (03-12), i10 PA 1.1, 1.2 (08-15), i20 PB/BT 1.2, 1.4, 1.6 (2009-), Hyundai Triburon 2.0 (2002-), Kia Picanto 1.1 (04-11), Rio II 1.2, 1.4, 1.6 (2004-) - Fr. Hub		
<b>422BHUB</b>		 	<p><b>2 Bolt Holes:</b> M6 x 1</p> <p><b>4 Studs:</b> M12 x 1.5</p> <p><b>Splines:</b> 25</p>	Disc centre spigot:	54mm/ 62.2mm	
Bearing:	DAC387037				<b>Notes:</b>	<b>PQ422</b> <i>PCD: 100 mm</i>
Bearing ID:	38mm					
Outer Diameter:	123mm					
Height:	60mm 95.5mm			Hyundai Accent 1.6 G4FG Pet. (2017-), i10 PA 1.1 G3LA, 1.2 G4LA (08-15), Grand i10 1.1 G3LA, 1.2 G4LA (2017-), i20 PB/BT 1.2, 1.4, 1.6 (2009-), Kia Picanto III (JA) 1.0 G3LA, G3LD Pet., 1.2 G4LA Pet. (2017-), Rio IV 1.2 G4LA Pet., 1.4 G4LC Pet. (2017-) - Fr. Hub		
<b>422CHUB</b>		 	<p><b>2 Bolt Holes:</b> M6 x 1.5</p> <p><b>4 Studs:</b> M12 x 1.5</p> <p><b>Splines:</b> 24</p>	Disc centre spigot:	54mm/ 62.2mm	
Bearing:	DAC387037				<b>Notes:</b>	<b>PQ422</b> <i>PCD: 100mm</i>
Bearing ID:	38mm					
Outer Diameter:	121.5mm					
Height:	57mm 92.3mm			Hyundai i10 PA 1.1, 1.2 (08-15), Kia Picanto 1.1 (04-11) - Fr. Hub		

## BUYERS GUIDE - HUBS



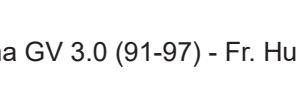

Part Number		Picture & Application		Holes/Studs	Spigot Diameter	
<b>427HUB</b>		 	Ford Telstar 2.0, 2.5, TX5 2.5 (94-99), Mazda 626 2.0i, 2.5i, MX6 2.5 (93-98) - Fr. Hub	<b>5 Studs:</b> M12 x 1.5	Disc centre spigot:	67mm/ 72mm
Bearings:	DAC428045					
Bearing ID:	42mm			<b>PQ427</b> PCD: 114mm		
Outer Diameter:	140mm					
Height:	67mm 102.5mm					
<b>428HUB</b>		 	Mitsubishi Colt LDV 2.8TDi - 4X2 (99-09), Colt LDV 2.4i, 2.5D, 2.6, 2.8D, 3.0, i V6 - 4X4 (95-09), Pajero 2.8TDi, 3.0 V6, 3.5 (90-01) - Fr. Hub	<b>Bolt Holes:</b> 6 M10 x 1.25	Disc centre spigot:	105.5mm
Bearing:	48510/48 102910+49 12610/49 102910+49					
Shaft OD:	86mm			<b>PQ428</b> PCD: 140mm		
Outer Diameter:	185mm					
Height:	70mm 105mm					
<b>432HUB</b>		 	Toyota Hilux RZN194, RZN169 2.7, i, LN192R, LN167 3.0D, iD (98-05), RN67 2.4 - 4X2, 4X4 (94-98) - Fr. Hub	<b>Bolt Holes:</b> 6 M10 x 1.25 6 M12 x 1.50	Disc centre spigot:	105mm/ 106mm
Bearing:	48510/48 102910+49 12610/49 102910+49					
Bearing ID:				<b>PQ432</b> PCD: 140.5mm		
Outer Diameter:	186mm					
Height:	90mm 115mm					
<b>433HUB</b>		 	Audi A4 1.8, T (95-01), A4 2.5TDi Quattro, 3.0 Quattro (02-08), A6 (94-03), VW Passat IV 1.8T, 2.8 Quattro (99-05) - Fr. & Rr. Hub	<b>Bolt Holes:</b> 5 M14 x 1.25	Disc centre spigot:	57mm/ 68mm
Bearing:	633816					
Bearing ID:	39mm			<b>PQ433</b> PCD: 112mm		
Outer Diameter:	130.5mm					
Height:	53.7mm 74mm					
<b>434HUB</b>		 	Audi 500 2.2, 2.3, 2.8 (92-94), A6 2.4, 2.5TDi, 2.6, 2.8, 3.0 (97-03), A6 2.4 16" (02-05), A6 2.7T 16" (00-06), A8 3.7 (95-02), S4 2.2T (92-95), VW Passat IV 2.3, 2.8, 3.2 V6 (99-05) - Fr. & Rr. Hub	<b>Bolt Holes:</b> 5 M14 x 1.5	Disc centre spigot:	57mm/ 68mm
Bearing:	633817					
Bearing ID:	43mm/ 45mm			<b>PQ434</b> PCD: 112mm		
Outer Diameter:	130.5mm					
Height:	54.2mm 75mm					

## BUYERS GUIDE - HUBS











Part Number		Picture & Application		Holes/Studs	Spigot Diameter	
<b>438HUB</b>		 	 		Disc centre spigot:	
Bearing:	68111/49 12710/49				<b>Splines:</b>	<b>Notes:</b>
Bearing ID:				<b>PQ438</b> <i>PCD: mm</i>		
Outer Diameter:					Mercedes-Benz R170 SLK200K M111.958, SLK30, SLK32 AMG M112.960 (02-04) - Fr. Hub	
<b>439HUB</b>		 	 	<b>Bolt Holes:</b> <b>4:</b> M10 x 1.5mm <b>1:</b> M5x 1.25mm	Disc centre spigot:	56.5mm
Bearing:	636096				<b>Splines:</b>	<b>Notes:</b>
Bearing ID:	39mm			33		<b>PQ439</b> <i>PCD: 100mm</i>
Outer Diameter:	120mm				Daewoo Tacuma 1.6, 2.0 (01-03), Opel Astra F 2.0ts, Kadett F 2.0ts (93-99) - Fr. Hub	
<b>440HUB</b>		 	 	<b>Bolt Holes:</b> <b>4:</b> M12 x 1.5 <b>2:</b> M6 x 1	Disc centre spigot:	57mm/ 65mm
Bearing:	309726				<b>Splines:</b>	<b>Notes:</b>
Bearing ID:	34mm			22		<b>PQ107</b> <i>PCD: 100mm</i> <b>USE 107HUB</b>
Outer Diameter:	120.5mm				VW Polo 6N 1.4, 1.6 (96-03), Caddy 1.6i (97-03) - Fr. Hub	
<b>443HUB</b>		 	 		Disc centre spigot:	
Bearing:	309797				<b>Splines:</b>	<b>Notes:</b>
Bearing ID:	45mm			25		<b>PQ443</b> <i>PCD: mm</i>
Outer Diameter:					Mercedes-Benz W170 SLK200, SLK320 M112.947, R170 SLK200K M111.958, SLK320, SLK32 AMG M112.960 (97-04), W202/3 C-Class C180, C200, C220, C230, C240, C250, C270CDi, C280 (94-08) - Rr. Hub Sedan	
<b>447HUB</b>		 		<b>4 Studs:</b> M12 x 1.25	Disc centre spigot:	66mm 68mm
Bearing:	42BWD06				<b>Splines:</b>	<b>Notes:</b>
Bearing ID:	42mm			27		<b>PQ447</b> <i>PCD: 113.8mm</i>
Outer Diameter:	135.7mm				Nissan Maxima GV 3.0 (91-97) - Fr. Hub	
Height:	57mm					
Height:	89mm					











## BUYERS GUIDE - HUBS

Part Number		Picture & Application		Holes/Studs	Spigot Diameter	
<b>447AHUB</b>		<b>Arriving Soon!</b>		<b>5 Studs:</b>	Disc centre spigot:	
Bearing:	42BWD06				<b>Splines:</b>	<b>Notes:</b>
Bearing ID:	42mm					
Outer Diameter:						
Height:				Nissan CA33, QX Maxima 2.0, 3.0 (96-04), Primera 1.6, 2.0 (98-02) - Fr. Hub		
<b>449HUB</b>			<b>Bolt Holes:</b> 5: M12 x 1.5 1: M6 x 1.0	Disc centre spigot:	57mm/ 65mm	
Bearing:	40BWD06			<b>Splines:</b>	<b>Notes:</b>	
Bearing ID:	40mm					
Outer Diameter:	126.5mm			36		<b>PQ449</b> <i>PCD: 100mm</i>
Height:	55mm 74mm		Audi A3 1.8, T (98-04), Audi A4 1.8T, 1.9TDi (00-08), Audi S3 1.8T (00-04), TT 1.8T (00-07) - Fr. & Rr. Hub, VW Beetle 1.8T, 2.0i (00-12), Golf IV 1.6i, 1.8, T, GTi, 1.9TDi, 2.0i (99-04), Jetta IV 1.6i, 1.8, T, 1.9TDi, 2.0i, 2.3 V5 (99-06) - Fr. Hub			<b>ABS Gear:</b> <b>OD: 134mm</b>
<b>452HUB</b>			<b>Bolt Holes:</b> 2 M24 1 M15	Disc centre spigot:	54mm	
Bearing:	HUB012			<b>4 Studs:</b> M12 x 1.5	<b>Notes:</b>	
Bearing ID:	28mm					
Outer Diameter:	140mm					
Height:	87.5mm 118mm		Toyota EE90R Conquest / Tazz 1.3, AE92R 1.6 (91-06), Corolla FWD EE90R, EE110R 130, AE111R 1.6i, AE112 1.8i (91-02), AE92R 1.6, AE93R 1.8i, (91-96) Conquest EE90 130i Carri P/van (98-06) - Rr. Hub			<b>PQ452</b> <i>PCD: 100mm</i>
<b>452AHUB</b>			<b>Bolt Holes:</b> 2 M24 1 M15	Disc centre spigot:	54mm	
Bearing:	HUB012			<b>4 Studs:</b> M12 x 1.5	<b>Notes:</b>	
Bearing ID:	28mm					
Outer Diameter:	125mm					
Height:	87.5mm 118mm		Toyota EE90R Conquest / Tazz 1.3, AE92R 1.6 (91-06), Corolla FWD EE90R, EE110R 130, AE111R 1.6i, AE112 1.8i (91-02), AE92R 1.6, AE93R 1.8i (91-96) Conquest EE90 130i Carri P/van (98-06) - Rr. Hub			<b>PQ452</b> <i>PCD: 100mm</i>
<b>460HUB</b>			<b>4 Studs:</b> M12 x 1.5mm	Disc centre spigot:	62.5mm/ 63.6mm	
Bearing:	102429			<b>Splines:</b>	<b>Notes:</b>	
Bearing ID:	40mm					
Outer Diameter:	134mm			27		<b>PQ460</b> <i>PCD: 108mm</i>
Height:	56mm 86.5mm		Ford Mondeo 1.8i, 2.0i, 2.5i (97-01) - Fr. Hub			









## BUYERS GUIDE - HUBS

Part Number		Picture & Application		Holes/Studs	Spigot Diameter	
<b>464HUB</b>		 	<p><b>4 Studs:</b> M12 x 1.5mm</p> <p><b>Splines:</b> 26</p>	Disc centre spigot:	56mm/ 64mm	
Bearing:	DE08A55				<b>Notes:</b>	<b>PQ464</b> PCD: 100mm
Bearing ID:	43mm					
Outer Diameter:	139mm					
Height:	55mm 89mm			Honda Ballade 150i, 160i, 180i (96-00), Civic SO3 150i, 160i VII 150i, 170i V-Tec (96-06), Odyssey 2.2, 2.3 V-Tec (96-02) - Fr. Hub		
<b>467HUB</b>		 	<p><b>4 Bolt Holes:</b> M12 x 1.5mm</p> <p><b>4 Studs:</b> M12 x 1.5</p> <p><b>Splines:</b> 21</p>	Disc centre spigot:	60mm/ 60.5mm	
Bearing:	12807S				<b>Notes:</b>	<b>PQ467</b> PCD: 99mm
Bearing ID:	37mm					
Outer Diameter:	121mm					
Height:	54mm 75mm			Renault Clio I, II 1.2, 1.4, 1.5, 1.6, 2.0, 3.0 (99-04), Kangoo 1.4, 1.5Dci, 1.5Dci (01-10), Laguna I 1.6, 1.8, 1.9dCi, 2.0, 3.0 (96-09), Megane I 1.6, 2.0 (96-02), Megane II 1.4 (02-10), Scenic I, II 1.4, 1.6, 2.0 (98-04) - Fr. Hub		
<b>471HUB</b>		 	<p><b>4 Studs:</b> M12 x 1.5</p> <p><b>Splines:</b> 26</p>	Disc centre spigot:	54mm/ 55mm	
Bearing:	40BWD06A				<b>Notes:</b>	<b>PQ471</b> PCD: 99mm
Bearing ID:	40mm					
Outer Diameter:	122mm					
Height:	58.5mm 90.5mm			Mazda 626 2.0 (98-03), Astina 180 (95-00), Etude 160, 180 (95-04) - Fr. Hub		
<b>474HUB</b>		 	<p><b>Splines:</b> 25</p>	Disc centre spigot:	59mm	
Bearing:	12131ASB				<b>Notes:</b>	<b>PQ474</b> PCD: mm
Bearing ID:	37mm					
Outer Diameter:	117mm					
Height:	74mm			Fiat 500 0.9 199 B6.000, 1.4 16V 169A3.000 (08-15), Multipla 1.6 Active, 1.6 SX, 1.9 JTD ELX MPV 182A4.000 (03-10), Panda 1.2, 1.4 (2006), Punto 1.3, 1.4, 1.8 (04-13), Stilo 1.6, 1.9 (03-06) - Fr. Hub		
<b>474AHUB</b>		 	<p><b>5 Bolt Holes:</b> M12 x 1.5mm</p> <p><b>Splines:</b> 25</p>	Disc centre spigot:		
Bearing:	12131ASB				<b>Notes:</b>	<b>PQ474</b> PCD: mm
Bearing ID:	37mm					
Outer Diameter:						
Height:				Opel Adam 1.0T B10XFT, 1.4 B14XER, A14XER (2014-), Corsa D 1.4 Essentia, Enjoy, Cosmo, Sport, 1.6i Sport (08-15), Corsa E 1.4 T B14NEH (2017-) - Fr. Hub		

## BUYERS GUIDE - HUBS









Part Number		Picture & Application		Holes/Studs	Spigot Diameter			
<b>474BHUB</b>		 		25	Disc centre spigot:	60mm		
Bearing:	12131ASB				<b>Splines:</b>	<b>Notes:</b>	<b>PQ474</b> <i>PCD: mm</i>	
Bearing ID:	37mm							
Outer Diameter:	120mm							
Height:	72mm	Fiat Punto 1.4 Multiair (2006-), Grande Punto 1.2 199A4.000, 1.3D JTD Dynamic, JTD Multijet 199A2.000, 199A3.000, 1.4, 1.9 Multijet 939A1.000 (04-13) - Fr. Hub						
<b>477HUB</b>		<b>Arriving Soon!</b>			Disc centre spigot:			
Bearing:	GB12955				<b>Splines:</b>	<b>Notes:</b>	<b>PQ477</b> <i>PCD: mm</i> <b>USE 474HUB</b>	
Bearing ID:	42mm							
Outer Diameter:								
Height:		Alfa Romeo 155 2.5 (96-99), GTV/Spider 3.0 V6 (99-04), Fiat 500 1.2, 1.4 (08-15), Multipla 1.9 (03-06), Panda 1.2, 1.4 (2006-), Punto 1.3, 1.4, 1.8 (04-13), Stilo 1.6, 1.9 (03-06) - Fr. Hub						
<b>483HUB</b>		 		25	<b>Bolt Holes:</b> 4: M12 x 1.25mm 2: M6 x 1.mm	Disc centre spigot:	66mm	
Bearing:	40547				<b>Splines:</b>	<b>Notes:</b>	<b>PQ483</b> <i>PCD: 108 mm</i>	
Bearing ID:	42mm							
Outer Diameter:	128mm							
Height:	66mm	Citroen C2 (04-10), C3 I, II (2002-), C4 (05-15), C5 (01-05), DS3 (2010-), Picasso (03-06), Xsara (03-08), Berlingo (03-15), Peugeot 206 2.0 (01-08), 207 (06-13), 208 (2012-), 306 (95-03), 308 (2008-), 308CC (10-14), 3008 (2010-), 405 (95-97), 406 (96-05), Partner - All (03-10) - Fr. Hub						
<b>496HUB</b>		 		38mm	Disc centre spigot:			
Bearings:					<b>Splines:</b>	<b>Notes:</b>	<b>PQ496</b> <i>PCD:</i>	
Bearing ID:								
Outer Diameter:								
Height:		VW Kombi T4 2.5Tdi Microbus, Caravelle, Trend, High ACV, AAB Dies., Turbo Dies. (99-06) - Fr. & Rr Hub						
<b>499AHUB</b>		 		25	<b>4 Studs:</b> M12 x 1.5	Disc centre spigot:	54mm 55mm	
Bearing:	309639ASB				<b>Splines:</b>	<b>Notes:</b>	<b>PQ499</b> <i>PCD: 108mm</i>	
Bearing ID:	39mm							
Outer Diameter:	131.2mm							
Height:	73.5mm 89.7mm	Ford B-Max 1.0 EcoBoost M1JE, M1JH (2015-), Fiesta III (2008-), Figo (2010-), Focus II (00-05), Ikon (01-11), KA (05-09), Mazda 2 (DE) (07-15) - Fr. Hub						

## BUYERS GUIDE - HUBS









Part Number		Picture & Application		Holes/Studs	Spigot Diameter			
<b>499BHUB</b>		 	4 Studs: M12 x 1.5	Disc centre spigot:	54mm/ 55mm			
Bearing:	309639 ASB				Splines:	Notes:		
Bearing ID:	39mm			25				
Outer Diameter:	128mm			Ford Fiesta III 1.0, 1.4, i, 1.6, i, Gtdi (2008-), Mazda 2 (DE) 1.3, 1.5 (07-15) - Fr. Hub		<b>PQ499</b> PCD: 100mm		
Height:	73mm 91mm							
<b>506HUB</b>		Arriving Soon!		4 Studs: M12 x 1.5	Disc centre spigot:	67mm		
Bearing:	633966					Splines:	Notes:	
Bearing ID:	40mm				25			
Outer Diameter:	143mm				Volvo S40 2.0T, V40 2.0T (98-04) - Fr. Hub		<b>PQ506</b> PCD: 114mm	
Height:								
<b>513HUB</b>		 	4 Studs: M12 x 1.5	Disc centre spigot:				
Bearing:	VWS1999				Splines:	Notes:		
Bearing ID:	43mm			38				
Outer Diameter:				VW Sharan 1.8T, 1.8TDi, 2.8MPV (99-08) - Fr. Hub		<b>PQ513</b> PCD: mm		
Height:								
<b>521HUB</b>		 	5 Bolt Holes: 2 M6 x 1.0  5 Studs: M12 x 1.5	Disc centre spigot:	67mm/ 76mm			
Bearing:	DAC427639				Splines:	Notes:		
Bearing ID:	42mm			27				
Outer Diameter:	147.8mm			Hyundai iX35 2.0, 2.4 - 4X4 (2010-), Santa Fe 2.4, 2.7 4X4 (01-05), Tucson 2.0, 2.7i - 4X4 (04-10), Kia Sportage JE 2.0, 2.7 - 4X4 (04-10) - Rr Hub		<b>PQ521</b> PCD: 114mm		
Height:	66mm 80.5mm							
<b>528HUB</b>		 	4 Studs: M12 x 1.5	Disc centre spigot:	56.5mm/ 59mm			
Bearing:	309726				Splines:	Notes:		
Bearing ID:	34mm			22				
Outer Diameter:	120.5mm			Chevrolet Aveo 1.5, 1.6 (03-15), Spark 1.0, 1.2 (2010-) - Fr. Hub		<b>PQ528</b> PCD: 100mm		
Height:	56mm 78mm							



# BUYERS GUIDE - HUBS











Part Number		Picture & Application		Holes/Studs	Spigot Diameter	
<b>530HUB</b>		<b>Arriving Soon!</b>			Disc centre spigot:	
Bearing:	636096			<b>Splines:</b>	<b>Notes:</b>	
Bearing ID:	39mm					
Outer Diameter:					<b>PQ530</b> <i>PCD: mm</i>	
Height:						
		Chevrolet Optra 1.6 Ls F16D3, 1.8 Lt T18SED (04-11) - Fr. Hub				
<b>531HUB</b>					Disc centre spigot:	79mm
Bearing:	DAC 458541			<b>Splines:</b>	<b>Notes:</b>	
Bearing ID:	45mm					
Outer Diameter:				30	<b>PQ531</b> <i>PCD: mm</i>	
Height:						
				BMW E46 330Ci, d (98-05), E31 (91-94), E38 (95-03), M3 (01-04), X3 (05-10) - Rr. Hub		
<b>567HUB</b>				<b>Bolt Holes:</b> 2: M6 x 1.mm	Disc centre spigot:	
Bearing:	12306GB 12306XGBP DACFW-B35PTO			<b>4 Holes:</b> M12 x 1.25		
Bearing ID:	35mm			<b>Splines:</b>	<b>Notes:</b>	
Outer Diameter:	116mm				22	<b>PQ566</b> <b>PQ567</b> <b>PQ751</b> <i>PCD: 98mm</i>
Height:	62.3mm					
				Fiat 500 1.2 (08-15), Panda 1.1 [PQ566], 1.2 [PQ567] (2006-), Punto 1.2 [PQ751] (04-13), Seicento (01-03) - Fr. Hub		
<b>576AHUB</b>					Disc centre spigot:	
Bearing:	DAC43FWB-DC			<b>Splines:</b>	<b>Notes:</b>	
Bearing ID:	43mm					
Outer Diameter:	139.8mm			28mm	<b>PQ576</b> <i>PCD: 114.3mm</i>	
Height:						
				Citroen C4 1.6, 2.0 (05-16), Mitsubishi Lancer 1.5, 2.0, Outlander I, II (07-13) - Fr. Hub		
<b>583HUB</b>				<b>2 Bolt Holes:</b> M8 x 1.25	Disc centre spigot:	69mm
Bearings:	DACHY TUC1			<b>4 Studs:</b> M12 x 1.5		
Bearing ID:	45mm			<b>Splines:</b>	<b>Notes:</b>	
Outer Diameter:	139mm				27	<b>PQ583</b> <i>PCD: mm</i>
Height:	73mm					
	92mm			Hyundai Sonata Y3 (01-04) - Fr Hub		

## BUYERS GUIDE - HUBS









Part Number		Picture & Application		Holes/Studs	Spigot Diameter	
<b>583AHUB</b>		 	Bolt Holes: 2: M6 x 1  5 Studs: M12 x 1.5  Splines:  27	Disc centre spigot:	69mm	
Bearing:	DACHY TUC1					
Bearing ID:	45mm					
Outer Diameter:	136.8mm					
Height:	60mm 75.5mm					
		Hyundai iX35 - 4X2, 4X4 (2010-), Sonata (EF) (01-04), Tucson JM 2.0 - 4X2, 4X4 (04-10) - Fr. Hub		<b>PQ583</b> PCD: 114mm		
<b>583BHUB</b>		 	Bolt Holes: 2: M6 x 1  5 Studs: M12 x 1.5  Splines:  27	Disc centre spigot:	69mm/ 67mm	
Bearing:	DACHY TUC1					
Bearing ID:	45mm					
Outer Diameter:	137.2mm					
Height:	72.5mm 92mm					
		Kia Optima 2.4 (12-14), Sportage (SL/JE) 2.0 (2004-) - Fr. Hub		<b>PQ583</b> PCD: 114mm		
<b>583CHUB</b>		Arriving Soon!	Bolt Holes: 2: M6 x 1  5 Studs: M12 x 1.5  Splines:  30	Disc centre spigot:	69mm/ 67mm	
Bearing:	DACHY TUC1					
Bearing ID:	45mm					
Outer Diameter:	139mm					
Height:	57mm					
		Kia Sportage (SL) 2.0 CRDi D4HA 4X4 (2010-) - Fr. Hub		<b>PQ583</b> PCD: 114.3mm		
<b>588HUB</b>		 	5 Bolt Holes: M12 x 1.5  Splines:  27	Disc centre spigot:	67mm	
Bearing:	309797					
Bearing ID:	45mm					
Outer Diameter:	150mm					
Height:	82mm					
		Mercedes-Benz Vito/Viano W638 113, 115, 116, 120, 122 (03-06) - Fr. & Rr. Hub		<b>PQ588</b> PCD: 114mm		
<b>597HUB</b>		 	Splines:  23	Disc centre spigot:	69mm	
Bearing:	68111/ 68149					
Bearing ID:	35mm					
Outer Diameter:	142mm					
Height:	68mm 79mm					
		Chevrolet Spark 0.8, 1.0 (03-10), Daewoo Matiz 0.8 (99-03) - Fr. Hub		<b>PQ597</b> PCD: 114mm		











# BUYERS GUIDE - HUBS

Part Number		Picture & Application		Holes/Studs	Spigot Diameter	
<b>598HUB</b>		 	<p><b>4 Studs:</b> M12 x 1.5</p> <p><b>Splines:</b> 26</p>	Disc centre spigot:	55mm	
Bearing:	40BWD12					
Bearing ID:	40mm			<b>Notes:</b>		
Outer Diameter:	125mm					
Height:	75.5mm 90mm			Toyota Corolla FWD 1.4i, 1.6i, 1.8i (02-08), Corolla Verso 1.6i, 1.8i (04-09), Runx 1.4i, 1.6i, 1.8i (03-08) - Fr. Hub	<b>PQ598</b> PCD: 100mm	
<b>598BHUB</b>		 	<p><b>5 Studs:</b></p> <p><b>Splines:</b> 30</p>	Disc centre spigot:		
Bearing:	40BWD12					
Bearing ID:	40mm			<b>Notes:</b>		
Outer Diameter:						
Height:				Toyota Avensis 2.0i, 2.4i (08-09) - Fr. Hub	<b>PQ598</b> PCD: mm	
<b>604HUB</b>		 	<p><b>Bolt Holes:</b> 4: M10 x 1.25mm 2: M5 x 1.25mm</p> <p><b>Splines:</b> 21</p>	Disc centre spigot:	65mm/ 66mm	
Bearing:	40547 XGBCITC3					
Bearing ID:	37mm			<b>Notes:</b>		
Outer Diameter:	129.5mm					
Height:	51mm 68mm			Citroen C2 (04-10), C3 I, II (02-10), DS3 1.2i, 1.6 (2010-), Peugeot 206 1.4, 1.6 (01-08), 207 1.4, 1.6 (06-13), 208 1.0, 1.2, 1.6 (2012-) - Fr. Hub	<b>PQ604</b> <b>PQ776</b> PCD: 108mm	
<b>622HUB</b>		 	<p><b>Bolt Holes:</b> 4: M12 x 1.5mm 2: M8 x 1.25mm</p> <p><b>Splines:</b> 23</p>	Disc centre spigot:	60mm/ 61mm	
Bearing:	DACFWBNM					
Bearing ID:	37mm			<b>Notes:</b>		
Outer Diameter:	121mm					
Height:	75mm			Nissan Micra (K12/13) (2004-), NP200 (2008-), Renault Captur 0.9 Tce (2016-), Clio I, II (99-10), Clio IV 1.9T, 1.2 (2013-), Kangoo (03-13), Logan (2009-), Modus (05-08), Sandero (09-15), Scenic I 1.6, 1.9, 2.0 (98-02) - Fr. Hub	<b>PQ622</b> PCD: 100mm	
<b>622AHUB</b>		 	<p><b>Bolt Holes:</b> 4: M12 x 1.5mm 2: M8 x 1.25mm</p> <p><b>Splines:</b> 21</p>	Disc centre spigot:	60mm/ 61mm	
Bearing:	DACFWBNM					
Bearing ID:	37mm			<b>Notes:</b>		
Outer Diameter:	121mm					
Height:	54mm 75mm			Renault Clio 1.4, 1.6 (06-10), Logan 1.6 (2009-), Megane II (02-10), Sandero (09-15), Scenic II (02-10), Twingo (08-13) - Fr. Hub	<b>PQ622</b> PCD: 100mm	

## BUYERS GUIDE - HUBS





















Part Number		Picture & Application		Holes/Studs	Spigot Diameter			
<b>622BHUB</b>		 	Opel Adam 1.0T B10XFT, 1.4 B14XER, A14XER (2014-), Corsa D 1.3CDTi, 1.6i Sport, OPC (08-15), Corsa E 1.0, 1.4 (2015-), 1.4 T B14NEH (2017-), Renault Clio III 1.4, 1.5, 1.6, 2.0 (06-10) - Fr. Hub	<b>Bolt Holes:</b> 4: M12 x 1.25 2 Hole M8	Disc centre spigot:	58mm/ 59mm		
Bearing:	DACFWBNM			<b>Splines:</b>	25	<b>Notes:</b>		
Bearing ID:	37mm					<b>PQ622</b> PCD: 98mm		
Outer Diameter:	120mm							
Height:	74mm							
<b>622CHUB</b>		 	Nissan Almera 1.5 (2013-), Micra (K12/13) 1.2 (2004-), (K14) 0.9T (2018-) - Fr. Hub	<b>4 Stud:</b> M12 x 1.5	Disc centre spigot:	60mm/ 61mm		
Bearing:	DACFWB-NM			<b>Splines:</b>	25	<b>Notes:</b>		
Bearing ID:	37mm					<b>PQ622</b> PCD: 100mm		
Outer Diameter:	122mm							
Height:	69.7mm 82.9mm							
<b>627HUB</b>		<b>Arriving Soon!</b>		Toyota Condor 2.4, 3.0 - 4X4 (00-05) - Fr. Hub	Disc centre spigot:	60mm/ 62mm		
Bearing:	46T090A				<b>Splines:</b>	25	<b>Notes:</b>	
Bearing ID:	45mm						<b>PQ627</b> PCD: 114mm	
Outer Diameter:	139mm							
Height:	62mm 76.5mm							
<b>633HUB</b>		 	Fiat Punto 1.2 Dynamic 188A5000, 1.4 Multiair 16V (04-14), Grande Punto I 1.2 199A4.000, 1.4, 1.9 Multijet 939A1.000 (06-10), Grande Punto II 1.2 199A4.000, 1.4 16V, 1.4 T-Jet (08-12), Opel Adam 1.0T B10XFT, 1.4 B14XER, A14XER (2014-), Corsa D 1.4 Essentia, Enjoy, Cosmo, Sport (08-15), Corsa E 1.0 T B10XFT, F10XFT, 1.4 T B14XEL (2015-) - Fr. Hub	<b>4 Bolt Holes:</b> M12 x 1.5	Disc centre spigot:	60mm		
Bearing:	DACFW-BOCD			<b>Splines:</b>	22	<b>Notes:</b>		
Bearing ID:	35mm					<b>PQ633</b> PCD: 100mm		
Outer Diameter:	120mm							
Height:	71mm							
<b>634HUB</b>		 	Citroen C1 1.0, i (06-15), Peugeot 107 1.0 (06-16), Toyota Aygo 1.0 (2011-) - Fr Hub	<b>4 Bolt Holes:</b> M12 x 1.5	Disc centre spigot:	54mm/ 55mm		
Bearing:	DACFW-B107ASB			<b>Splines:</b>	24	<b>Notes:</b>		
Bearing ID:	37mm					<b>PQ634</b> PCD: 100mm		
Outer Diameter:	125mm							
Height:	54mm 72mm							

## BUYERS GUIDE - HUBS











Part Number		Picture & Application		Holes/Studs	Spigot Diameter		
<b>641HUB</b>		 	<p style="text-align: center;"><b>4 Studs:</b> M12 x 1.25</p>	Disc centre spigot:	66mm/ 68mm		
Bearing:	40BWD15A				<b>Splines:</b>	<b>Notes:</b>	
Bearing ID:	40mm			25		<p style="text-align: center;"><b>PQ641</b> <i>PCD: 114mm</i></p>	
Outer Diameter:	136mm						
Height:	62.5mm				Nissan Almera 1.5, 1.6, 1.8 (01-06) - Fr. Hub		
	95mm						
<b>641BHUB</b>		Arriving Soon!		<p style="text-align: center;"><b>4 Studs:</b> M12 x 1.25</p>	Disc centre spigot:		
Bearing:	40BWD15A					<b>Splines:</b>	<b>Notes:</b>
Bearing ID:	40mm				27		<p style="text-align: center;"><b>PQ641</b> <i>PCD: 114mm</i></p>
Outer Diameter:							
Height:						Nissan Almera 1.5, 1.6, 1.8 (01-06) - Fr. Hub	
<b>649HUB</b>		 		Disc centre spigot:			
Bearing:	40BCV09				<b>Splines:</b>	<b>Notes:</b>	
Bearing ID:	40mm					<p style="text-align: center;"><b>PQ649</b> <i>PCD: 125mm</i></p>	
Outer Diameter:	104.9mm						
Height:					Toyota Hilux "Vigo" 2.5TDi, 2.7i, 3.0D-4D, 4.0i - 4X2 (05-11), 2.5TDi, 2.7TDi, 3.0D-4D, 4.0 - 4X4 (06-09), Hilux 2.7i, 3.0D, iD (98-05) - Rr. Hub		
	43.3mm						
<b>653HUB</b>		 	<p style="text-align: center;"><b>4 Bolt Holes:</b></p>	Disc centre spigot:	54mm/ 60mm		
Bearing:	DACF-WBSS				<b>Splines:</b>	<b>Notes:</b>	
Bearing ID:	40mm			25		<p style="text-align: center;"><b>PQ653</b> <i>PCD: 100mm</i></p>	
Outer Diameter:	120mm						
Height:	55.5mm				Suzuki Swift 1.2, 1.4, 1.5i, 1.6, i (2008-) - Fr. Hub		
	71mm						
<b>659HUB</b>		 	<p style="text-align: center;"><b>5 Bolt Holes:</b></p>	Disc centre spigot:	60mm/ 62mm		
Bearing:	DACF-WBSSX				<b>Splines:</b>	<b>Notes:</b>	
Bearing ID:	45mm			28		<p style="text-align: center;"><b>PQ659</b> <i>PCD: 114mm</i></p>	
Outer Diameter:	134mm						
Height:	62mm				Suzuki SX41.6, 2.0i (2008-) - Fr. Hub		
	79mm						























## BUYERS GUIDE - HUBS

Part Number		Picture & Application		Holes/Studs	Spigot Diameter	
<b>659AHUB</b>		 	 	<b>5 Studs:</b>	Disc centre spigot:	
Bearing:	DACF- WBSSX					
Bearing ID:	45mm			<b>Splines:</b>	<b>Notes:</b>	
Outer Diameter:						28mm
Height:		Suzuki Swift 1.2, 1.4, 1.5i, 1.6, i (2010-) - Fr. Hub				
<b>663HUB</b>		 	 	<b>6 Studs:</b> M12 x 1.5	Disc centre spigot:	106mm/ 108mm
Bearing:	HUB171					
Bearing ID:	54mm			<b>Splines:</b>	<b>Notes:</b>	
Outer Diameter:	167mm					30
Height:	85mm	Toyota Fortuner (06-11), 3.0D-4D, 4.0 V6 - 4X4 (2015-), Hilux "Vigo" - 4X2, 4X4 (2005-), Hilux "Revo" 2.4, 2.8, 4.0 4X4 (2016-), Land Cruiser Prado 120/ 150 - 4X4 (2002-) - Fr. Hub				
	98.5mm					
<b>663AHUB</b>		 	 	6 Studs: M12 x 1.5	Disc centre spigot:	106mm/ 108mm
Bearing:	HUB171					
Bearing ID:	54mm			<b>Splines:</b>	<b>Notes:</b>	
Outer Diameter:	167mm					
Height:	82.8mm	Toyota Fortuner 2.4TD, 2.7VVTi 4x2 (2015-), Hilux "Revo" 2.4, 2.7, 2.8, 4.0 4x2 (2016-) - Fr. Hub				
	112mm					
<b>674HUB</b>		 	 	<b>5 Studs:</b> M12 x 1.5	Disc centre spigot:	64mm
Bearing:	DACFW- BHA					
Bearing ID:	48mm			<b>Splines:</b>	<b>Notes:</b>	
Outer Diameter:	139.5mm					28
Height:	68mm	Honda Accord VII 2.0i V-Tec, 2.4i V-Tec (03-08), Civic VIII 2.0i V-Tec Type R (07-13) - Fr. Hub				
	85.8mm					
<b>676HUB</b>		 	 	<b>4 Studs:</b> M12 x 1.5	Disc centre spigot:	67mm/ 69mm
Bearing:	DACFW- BYELJ4					
Bearing ID:	39.1mm			<b>Splines:</b>	<b>Notes:</b>	
Outer Diameter:	137mm					25
Height:	55.5mm	Hyundai Elantra J3 2.0 (01-06), Elantra J4 1.6, 2.0 (2006-), Matrix 1.6, 1.8 (02-07), Kia Cerato 1.6 LX G4FC, 2.0 CRDi (04-08) - Fr. Hub				

## BUYERS GUIDE - HUBS











Part Number		Picture & Application		Holes/Studs	Spigot Diameter	
<b>679HUB</b>		 		<b>Studs:</b> 1: M6 x 1.0 4: M12 x 1.5	Disc centre spigot:	56mm/ 60mm
Bearing:	DAC346737					
Shaft OD:	34mm					
Outer Diameter:	122mm					
Height:	56mm 78mm			Chevrolet Utility 1.3D, 1.4, 1.8 (11-15), Opel Corsa C 1.04i, 1.6i, 1.7TDi, 1.8i (03-08), Meriva (03-09), Corsa LDV II 1.4i, 1.7TDi, 1.8i (03-10), Combo 1.4i (2006-) - Fr. Hub		
<b>680HUB</b>		 		<b>Bolt Holes:</b> 6: M10 x 1.25 6: 12.5mm	Disc centre spigot:	63mm/ 93mm
Bearing:	14276 + 14138A					
Bearing ID:	75mm					
Outer Diameter:	147.8mm					
Height:	74.5mm 91mm			Kia K2700i 2.7D (2004-) - Fr. Hub		
<b>682HUB</b>		 		<b>5 Studs:</b>	Disc centre spigot:	
Bearing:	DACFWB- HC1					
Bearing ID:	43mm					
Outer Diameter:						
Height:				Honda Civic VIII 1.8i V-Tec (07-13), Civic IX 1.8i V-Tec (2012-) - Fr. Hub		
<b>683HUB</b>		 		<b>5 Studs:</b> M12 x 1.5	Disc centre spigot:	
Bearing:	DACFWB- CRVASB					
Bearing ID:	45mm					
Outer Diameter:						
Height:				Honda Civic VIII 2.2CTDi Vxi (07-13), CR-V 2.0 K20A4 - 4X4 (2005-), FR-V 1.8i R18A1 (07-10) - Fr. Hub		
<b>690HUB</b>		 		<b>5 Holes:</b>	Disc centre spigot:	
Bearing:	DACFWB- MW245					
Bearing ID:	45mm					
Outer Diameter:	141mm					
Height:	82mm			Mercedes-Benz W169 A-Class, W245 B-Class (05-13) - Fr. Hub		

## BUYERS GUIDE - HUBS











Part Number		Picture & Application		Holes/Studs	Spigot Diameter		
<b>694HUB</b>		 	 	<b>5 Holes:</b>	Disc centre spigot:		
Bearing:	HUB223						
Bearing ID:	61mm			<b>Splines:</b>	42	<b>Notes:</b>	
Outer Diameter:	142mm						
Height:	72mm			Audi A4 3.2FSi Quattro (01-08), 1.8TFSi, 2.0T, TFSi, TDi, 3.0TDi (08-14), 3.2FSi, FSi Quattro (06-14), A5 2.0TFSi, TFSi Quattro, 3.0TDi Quattro, 3.2 FSi Quattro (08-14), A6 2.0TDi, TFSi, 3.0TDi, TFSi Quattro (11-15), Q5 2.0TFSi, TDi Quattro, 3.0TDi Quattro, 3.2FSi Quattro (09-14) - Fr & Rr. Hub			<b>PQ694</b> PCD : 112mm
<b>708HUB</b>		 	 	<b>5 Holes:</b>	Disc centre spigot:		
Bearing:	DAC51-VWASB						
Bearing ID:	51mm			<b>Splines:</b>	30mm	<b>Notes:</b>	
Outer Diameter:							
Height:				Audi Q7 3.0TDi, TFSi, 3.6FSi, 4.2FSi, 6.0 TDi Quattro (06-15), VW Touareg 3.0TDi, 3.6FSi, 4.2FSi, 5.0TDi - 4X4 (04-11) - Fr & Rr. Hub			<b>PQ708</b> PCD : mm
<b>714HUB</b>		 	 	<b>5 Studs:</b> M12 x 1.5	Disc centre spigot:	65mm/ 60mm	
Bearing:	DAC40FW-BAVEO						
Bearing ID:	40mm			<b>Splines:</b>	25	<b>Notes:</b>	
Outer Diameter:	136mm						
Height:	60mm 79.5mm			Chevrolet Aveo 1.5, 1.6 (03-15), Sonic 1.3D, 1.4, 1.6 (11-15), Mokka 1.4T A14NET, B14NET (2015-) - Fr. Hub			<b>PQ714</b> PCD: 105mm
<b>714BHUB</b>		 	 	<b>4 Studs:</b> M12 x 1.5	Disc centre spigot:		
Bearing:	DAC40FW-BAVEO						
Bearing ID:	40mm			<b>Splines:</b>	25	<b>Notes:</b>	
Outer Diameter:	122mm						
Height:				Chevrolet Sonic 1.3D, 1.4, 1.6 (2011-) - Fr. Hub			<b>PQ714</b> PCD: mm
<b>715HUB</b>		 	 	<b>4 Studs:</b> M12 x 1.5	Disc centre spigot:	55mm	
Bearing:	DAC4017A						
Bearing ID:	40mm			<b>Splines:</b>	26	<b>Notes:</b>	
Outer Diameter:	125mm						
Height:	72mm 89mm			Toyota Yaris 1.0, 1.3, 1.5, 1.8 (2005-) - Fr. Hub			<b>PQ715</b> PCD: mm













## BUYERS GUIDE - HUBS

Part Number		Picture & Application		Holes/Studs	Spigot Diameter	
<b>727HUB</b>		 		25	Disc centre spigot:	59mm/ 60.8mm
Bearing:	GB40880					
Bearing OD:	42mm				<b>Splines:</b>	<b>Notes:</b>
Outer Diameter:	121mm				<b>PQ727</b> <i>PCD: 100mm</i>	
Height:	56.5mm					
	77mm	Renault Captur 1.2 Tce, 1.5 Dci (2016-), Clio I, II (04-09), Clio III (06-10), Espace 2.0, 3.0 (99-08), Grand Scenic 1.9DCi, 2.0 (04-10), Megane II 1.5dci, 1.6, 1.9dci, 2.0T, Scenic II 1.6, 1.9dci (02-10), Twingo 1.6 (08-13)- Fr. Hub				
<b>729HUB</b>		 			Disc centre spigot:	
Bearing:	409026RS					
Bearing ID:	94mm				<b>PQ729</b> <i>PCD: 129mm</i>	
Outer Diameter:	109mm 152mm					
Height:	43.7mm				Toyota Quantum 2.5D-4D, 2.7 (2005-) - Rear Outer Wheel Hub Assy.	
<b>756HUB</b>		 		29	Disc centre spigot:	66mm/ 68mm
Bearing:	43BWD12					
Bearing ID:	43mm				<b>PQ756</b> <i>PCD: 114mm</i>	
Outer Diameter:	136mm					
Height:	57.7mm 75mm				Nissan X-Trail T30 2.0, 2.2D, 2.5 - 4X2, 4X4 (01-09) - Fr. Hub	
<b>757HUB</b>		 		29	Disc centre spigot:	
Bearing:	DAC9113X					
Bearing ID:					<b>PQ757</b> <i>PCD: 140mm</i>	
Outer Diameter:	148mm					
Height:					Nissan X-Trail T30 2.0, 2.2S, 2.5 (01-09) - Rr. Hub	
<b>758HUB</b>		 			Disc centre spigot:	98mm
Bearing:	47KWD02A					
Bearing ID:	47mm				<b>PQ758</b> <i>PCD: 140mm</i>	
Outer Diameter:	162mm					
Height:	114mm 132mm				Ford Everest 3.0 - 4X2 (09-15), Ranger 2.5TD, 3.0, 4.0 - 4X2 (04-12), Ranger T6 2.2 D HP, MP - 4X2 (2012-), Mazda BT-50 2.6i, 3.0 (07-12), Drifter 2.5TD, 2.6i - 4X2 (04-09) - Fr Hub	

## BUYERS GUIDE - HUBS









Part Number		Picture & Application		Holes/Studs	Spigot Diameter	
<b>758AHUB</b>		 	<b>6 Bolt Holes:</b> M12 x 1.5	Disc centre spigot:	93mm/	98mm
Bearing:	47KWD02A				<b>Splines:</b>	<b>Notes:</b>
Bearing ID:	47mm			28		<b>PQ758</b> PCD: 140mm
Outer Diameter:	162mm			Ford Everest 3.0 - 4X4 (09-15), Ranger 2.5, 3.0TDCi, 4.0 - 4X2, 4X4 (04-12), Ranger T6 3.2 D Wildtrack, TDCi - 4X4 (2012-), Mazda BT-50 2.5TDi, 2.6i, 3.0, 3.2 - 4X4 (2007-), Drifter 2.5TD, 2.6i - 4X4 (04-09) - Fr Hub		
Height:	74mm					
	93mm					
<b>758BHUB</b>		 	<b>6 Bolt Holes:</b> M12 x 1.5	Disc centre spigot:	98mm	
Bearing:	47KWD02A				<b>Splines:</b>	<b>Notes:</b>
Bearing ID:	47mm			26		<b>PQ758</b> PCD: 140mm
Outer Diameter:	162mm			Ford Ranger 2.5TD, 3.0TDCi, 4.0 - 4X4 (04-09), Mazda BT-50 2.5TDi, 2.6i, 3.0, 3.2 - 4X4 (2007-) - Fr Hub		
Height:						
	93mm					
<b>760HUB</b>		 	<b>5 Bolt Holes:</b> M12 x 1.5	Disc centre spigot:	60mm/	62mm
Bearing:	43KWD07				<b>Splines:</b>	<b>Notes:</b>
Bearing ID:	43mm					<b>PQ760</b> PCD: 114mm
Outer Diameter:	139mm			Toyota Hilux "Vigo" 2.0i - 4X2 (05-11), "Revo" 2.0, 2.4 Std. Body - 4X2 (2016-) - Fr. Hub		
Height:	98.5mm					
	113.5mm					
<b>761HUB</b>		 	<b>6 Studs:</b> M12 x 1.5	Disc centre spigot:	106mm/	108mm
Bearing:	HUB131				<b>Splines:</b>	<b>Notes:</b>
Bearing ID:	54mm			30		<b>PQ761</b> PCD: 140mm
Outer Diameter:	167mm			Toyota Fortuner 2.5D-4D, 3.0D-4D, 4.0 V6 - 4X4, Hilux 2.5D-4D, 3.0D-4D, 4.0 - 4X4 (11-16), "Vigo" 2.5TDi, 2.7i, 3.0D-4D, 4.0 - 4X2, 4X4 (2005-) - Fr Hub		
Height:	100mm					
	112mm					
<b>761AHUB</b>		 	<b>6 Studs:</b> M12 x 1.5	Disc centre spigot:	108mm	
Bearing:	43KWD07 HUB131				<b>Splines:</b>	<b>Notes:</b>
Bearing ID:	54mm			No Splines!		<b>PQ761</b> PCD: 140mm
Outer Diameter:	165mm			Toyota Fortuner 2.5D-4D, 3.0D-4D, 4.0 - 4X2, 4X4 (2006-), Hilux 2.0, 2.5D-4D, 2.7, 3.0D-4D, 4.0 - 4X2 (11-16), "Vigo" 2.5TDi, 2.7i Std Body, 3.0D-4D, 4.0i - 4X2 (05-16) - Fr Hub		
Height:	100mm					
	112mm					

## BUYERS GUIDE - HUBS









Part Number		Picture & Application		Holes/Studs	Spigot Diameter		
<b>762HUB</b>		 	<p><b>4 Studs:</b> M12 X 1.5</p> <p><b>Splines:</b> 24</p>	Disc centre spigot:			
Bearing:	DAC3564 37			<b>Notes:</b>			
Bearing ID:	35mm				<b>PQ762</b> <i>PCD: mm</i>		
Outer Diameter:	123mm						
Height:	56.8mm						
		Daihatsu Charade 1.0 1KRFE, Sirion 1.3 K3VE, 1.5 3SZVE (2007-)					
<b>767HUB</b>		 	<p><b>Splines:</b> 27</p>	Disc centre spigot:			
Bearing:	DACFWB- HYI30			<b>Notes:</b>			
Bearing ID:	42mm				<b>PQ767</b> <i>PCD: mm</i>		
Outer Diameter:							
Height:							
		Hyundai i30 FD/GD 1.6, 1.8, 2.0 (2012-), Kia Cerato 1.6, 2.0 (2008-) - Fr. Hub					
<b>767AHUB</b>		 	<p><b>5 Studs:</b> M12 X 1.5</p> <p><b>Splines:</b> 27</p>	Disc centre spigot:	67mm/ 69mm		
Bearing:	DACFWB- HYI30			<b>Notes:</b>			
Bearing ID:	42mm				<b>PQ767</b> <i>PCD: 114.3mm</i>		
Outer Diameter:	139mm						
Height:	57mm						
		Hyundai Elantra MD/UD 1.6 G4FG, 1.8 G4NB (11-16), Veloster 1.6 (2013-) - Fr. Hub					
<b>776HUB</b>		 	<p><b>Bolt Holes:</b> 4: M10 x 1.25mm 2: M5 x 1.25mm</p> <p><b>Splines:</b> 21</p>	Disc centre spigot:	65mm/ 66mm		
Bearing:	40547 XGBCITC3			<b>Notes:</b>			
Bearing ID:	37mm				<b>PQ776</b> <i>PCD: mm</i> <b>USE 604HUB</b>		
Outer Diameter:	129.5mm						
Height:	51mm 68mm						
		Citroen C2 (04-10), C3 I, II (02-10), DS3 1.2i, 1.6 (2010-), Peugeot 206 1.4, 1.6 (01-08), 207 1.4, 1.6 (06-13), 208 1.0, 1.2, 1.6 (2012-) - Fr. Hub					
<b>779HUB</b>		 	<p><b>Bolt Holes:</b> 2: M8 x 1.25 4: M12 x 1.28</p> <p><b>Splines:</b> 22</p>	Disc centre spigot:	59mm		
Bearing:	12132			<b>Notes:</b>			
Bearing ID:	35mm				<b>PQ779</b> <i>PCD: mm</i>		
Outer Diameter:	116mm						
Height:	78mm						
		Fiat Palio I, II 1.2, 1.6, 1.7TD, Siena I, II 1.2, 1.6, 1.7TD, 1.9 (00-10) - Fr. Hub					



















## BUYERS GUIDE - HUBS

Part Number		Picture & Application		Holes/Studs	Spigot Diameter	
<b>781HUB</b>		 			Disc centre spigot:	91mm
Bearing:	DAC30BW-DAVZ					
Bearing ID:	62mm					
Outer Diameter:						
Height:						
		Toyota Avanza 1.3i, 1.5i (06-12) - Fr. Hub		<b>Splines:</b>	<b>Notes:</b>	
					<b>PQ781</b> <i>PCD: mm</i>	
<b>784HUB</b>		 		<b>4 Studs:</b> M12 x 1.5  <b>Bolt Holes:</b> 4 M6  <b>Splines:</b>  26	Disc centre spigot:	56mm/ 61mm
Bearing:	DAC387340ASB					
Shaft OD:	38mm					
Outer Diameter:	121mm					
Height:	54mm 65.5mm					
		Honda Jazz 1.4, 1.5 (03-07) - Fr. Hub		<b>Splines:</b>	<b>Notes:</b>	
					<b>PQ784</b> <i>PCD: 100mm</i>	
<b>784AHUB</b>		Arriving Soon!			Disc centre spigot:	
Bearing:	DAC387340ASB					
Bearing ID:	38mm					
Outer Diameter:						
Height:						
		Honda CR-VII 2.0, 2.2, 2.4 - 4X2 (2002-) - Rr. Hub		<b>Splines:</b>	<b>Notes:</b>	
					<b>PQ784</b> <i>PCD: mm</i>	
<b>792HUB</b>		 		<b>5 Studs:</b> M12 x 1.5  <b>Splines:</b>  26	Disc centre spigot:	62mm
Bearing:	45BWD-VER					
Bearing ID:	45mm					
Outer Diameter:	139mm					
Height:	75mm 92mm					
		Toyota Camry II 2.4i, 3.0 (01-06), Corolla Verso 1.60i, 1.80i (04-09) - Fr. Hub		<b>Splines:</b>	<b>Notes:</b>	
					<b>PQ792</b> <i>PCD: 114mm</i> Same As <b>581HUB</b>	
<b>795HUB</b>		 		<b>5 Studs:</b>  <b>Splines:</b>  28	Disc centre spigot:	67mm / 72mm
Bearing:	DACMA5					
Bearing ID:	42mm					
Outer Diameter:	137.9mm					
Height:	79mm 93.9mm					
		Mazda 3 (BL, BK) 2.3, 2.5, (BN) 1.6, 2.0 (04-14) , 5 2.0 (07-14) - Fr. Hub		<b>Splines:</b>	<b>Notes:</b>	
					<b>PQ795</b> <i>PCD: 114mm</i>	

## BUYERS GUIDE - HUBS



Part Number		Picture & Application		Holes/Studs	Spigot Diameter		
<b>795AHUB</b>		 	Mazda 6 2.0, 2.3, MPS, 2.5 (03-14) - Fr. Hub	<b>5 Studs:</b>	Disc centre spigot:	67mm / 72mm	
Bearing:	DACMA5			<b>Splines:</b>	<b>Notes:</b>		
Bearing ID:	42mm				28	<b>PQ795</b> PCD: 114mm	
Outer Diameter:	139.3mm						
Height:	76mm 94mm						
<b>797HUB</b>		 	Mercedes-Benz W203 C-Class (94-08), W204 C-Class (07-14) - Fr. Hub	<b>5 Holes:</b>	Disc centre spigot:		
Bearing:	MBCF-WB2008			<b>Splines:</b>	<b>Notes:</b>		
Bearing ID:	62mm 50mm					<b>PQ797</b> PCD : 112mm	
Outer Diameter:	150mm						
Height:							
<b>798HUB</b>		Arriving Soon!	Mercedes-Benz W204 C-Class (2007-) - Rr. Hub	<b>5 Holes:</b>	Disc centre spigot:		
Bearing:	HUB140			<b>Splines:</b>	<b>Notes:</b>		
Bearing OD:	49mm					<b>PQ798</b> PCD : 112mm	
Outer Diameter:	148mm						
Height:	78mm						
<b>809HUB</b>		 	Honda Accord VIII 2.0i V-Tec, 2.2 i-D-Tec, 2.4i V-Tec (08-15) - Fr. Hub	<b>5 Studs:</b> M12 x 1.5	Disc centre spigot:	64mm	
Bearing:	DAC52FW-BHA			<b>Splines:</b>	<b>Notes:</b>		
Bearing ID:	52mm				30	<b>PQ809</b> PCD : 114mm	
Outer Diameter:	139mm						
Height:	70mm 90.5mm						
<b>811HUB</b>		 	Honda Ballade 1.5i (2011-), Brio 1.2 (2012-), Jazz 1.3i, 1.4i, 1.5i (08-14), Jazz IV 1.2 Trend L12B4, 1.5 Elegance L15Z2 (2015-) - Fr. Hub	<b>4 Holes:</b> M6 x 1.5	Disc centre spigot:	56 mm/ 64mm	
Bearing:	DAC38BRIO			<b>4 Studs:</b> M12 x 1.5			<b>Notes:</b>
Bearing ID:	38mm			<b>Splines:</b>	<b>PQ811</b> PCD: 100mm		
Outer Diameter:	139mm						
Height:	69.5mm 89mm						

## BUYERS GUIDE - HUBS



Part Number		Picture & Application		Holes/Studs	Spigot Diameter		
<b>815HUB</b>		 	 	<b>5 Studs:</b>	Disc centre spigot:		
Bearing:	DACFWB-FFS						
Bearing ID:	45mm			<b>Splines:</b>	<b>Notes:</b>		
Outer Diameter:				27	<b>PQ815</b> <i>PCD: mm</i>		
Height:		Ford Focus III 1.6i, 1.8, 2.0 (09-15), Kuga 1.5, 1.6, 2.0 - 4X2, 1.6, 2.0, 2.5 - 4X4 (2011-), Tourneo / Transit Connect/Grand Connect 1.0 EcoBoost Trend MPV SWB B3GA, 1.5 TDCi Ambiente Dsl P-Van LWB XWGA, 1.6 TDCi EcoBoost LWB T1GA (2013-) - Fr. Hub					
<b>834HUB</b>		 	 	<b>5 Holes:</b>	Disc centre spigot:	65mm/ 76mm	
Bearing:	DAC49VW AMASB						
Bearing ID:	49mm			<b>Splines:</b>	<b>Notes:</b>		
Outer Diameter:	160mm			28	<b>PQ834</b> <i>PCD: 120mm</i>		
Height:	94.5mm	VW Amarok 2.0 TSi, TDi, Bi-TDi - 4X2, 4X4 (10-16) - Fr. Hub					
<b>844HUB</b>		 	 	<b>4 Studs:</b> M12 x 1.5	Disc centre spigot:		
Bearing:	309639 ASB						
Bearing ID:	39mm			<b>Splines:</b>	<b>Notes:</b>		
Outer Diameter:	131.2mm			25	<b>PQ499</b> <i>PCD: mm</i>		
Height:	73.5mm 89.7mm	<b>USE 499AHUB</b>					
<b>847HUB</b>		Arriving Soon!		<b>4 Holes:</b>	Disc Centre spigot:		
Bearing:	HUB260						
Bearing ID:	43mm			<b>Splines:</b>	<b>Notes:</b>		
Outer Diameter:					<b>PQ847</b> <i>PCD : mm</i>		
Height:		Audi A6 2.4, 3.2FSi (04-11) - Fr. Hub					
<b>851HUB</b>		 	 		Disc centre spigot:		
Bearing:	DAC458441 ASB						
Bearing ID:	45mm			<b>Splines:</b>	<b>Notes:</b>		
Outer Diameter:				28	<b>PQ851</b> <i>PCD : mm</i>		
Height:		BMW F30 318i, 320i, 320d, 330i, 340i Sport, F34 Gran Turismo 320d (2015-), Gran Turismo 320i (2016-) - Rr. Hub					











# BUYERS GUIDE - HUBS

Part Number		Picture & Application		Holes/Studs	Spigot Diameter		
<b>855HUB</b>		<b>Arriving Soon!</b>		<b>5 Studs:</b> M12 x 1.5	Disc centre spigot:		
Bearing:	DAC-40MOND						
Bearing ID:	40mm			<b>Splines:</b>	<b>Notes:</b>		
Outer Diameter:	134mm			27	<b>PQ855</b> <i>PCD : 104mm</i>		
Height:	76mm			Ford Mondeo 2.0, 3.0 (02-07) - Fr. Hub			
<b>861HUB</b>				<b>5 Holes:</b>	Disc centre spigot:		
Bearing:	HUB266						
Bearing ID:	49mm			<b>Splines:</b>	<b>Notes:</b>		
Outer Diameter:	145mm			30	<b>PQ861</b> <i>PCD : mm</i>		
Height:				BMW F07, F10/11, F18 520d, GT, 523i, 528i, 530d, GT, 535i, GT, 535d (2011-) - Rr. Hub			
<b>876HUB</b>		<b>Arriving Soon!</b>		<b>5 Holes:</b> M14 x 1.5	Disc centre spigot:		
Bearing:	HUB180						
Bearing ID:	148.3mm			<b>Splines:</b>	<b>Notes:</b>		
Outer Diameter:					<b>PQ876</b> <i>PCD: 110mm</i>		
Height:	87.2mm			Mercedes-Benz W212 E-Class E200 CGi, E250 CDi, CGi, E350 CDi, E400, E500 (2009-) - Fr. Hub			
<b>889HUB</b>		<b>Arriving Soon!</b>		<b>4 Studs:</b> M12 x 1.5	Disc centre spigot:		
Bearing:	DAC42 8036						
Bearing ID:	42mm			<b>Splines:</b>	<b>Notes:</b>		
Outer Diameter:	139mm				<b>PQ889</b> <i>PCD: 114mm</i>		
Height:	72.5mm			Hyundai Sonata 2.0, 2.5, 3.0 (95-02) - Fr. Hub			
<b>895HUB</b>				<b>2 Holes:</b> M8 x 1.5	Disc centre spigot:	58mm/ 59mm	
Bearing:	DACFWB- STRA/ 12131						
Bearing ID:	37mm			<b>4 Holes:</b> M12 x 1.5	<b>Notes:</b>		
Outer Diameter:	116mm			<b>Splines:</b>	<b>PQ889/ PQ472</b> <i>PCD: 95mm</i>		
Height:	77.3mm			22			









## BUYERS GUIDE - HUBS

Part Number		Picture & Application		Holes/Studs	Spigot Diameter	
<b>896HUB</b>				<b>4 Holes:</b>	Disc centre spigot:	
Bearing:	TOY42K- WD			<b>Splines:</b>	<b>Notes:</b>	
Bearing ID:	42mm					
Outer Diameter:						
Height:	58.5mm	Toyota Fortuner 2.5D-4D, 3.0D-4D, 4.0 V6 - 4X2, 4X4 (09-16), Hilux 2.0, 2.5 D-4D, 2.7, 3.0D-4D, 4.0 - 4X2, 4X4 (11-16), "Vigo" 2.0i - 4X2 (09-11) - Rr. Hub		<b>PQ896</b> <i>PCD: 125mm</i>		
<b>912HUB</b>				<b>5 Holes:</b> M14 x 1.25	Disc centre spigot:	
Bearing:	309245			<b>Splines:</b>	<b>Notes:</b>	
Bearing ID:	42mm					
Outer Diameter:	147mm					
Height:	85mm	BMW 1 Series F20/1 116i, 118i, 120d, 125i (11-16), 3 Series F30/1 316i, 320i, 328i, 330d, 335i, F34 320i, d, 328i, 335i (2012-) - Rr. Hub		<b>PQ912</b> <i>PCD : mm</i>		
<b>912AHUB</b>				<b>5 Holes:</b> M12 x 1.5	Disc centre spigot:	
Bearing:	309245			<b>Splines:</b>	<b>Notes:</b>	
Bearing ID:	42mm					
Outer Diameter:	145mm					
Height:	87mm	BMW 3 Series E90 323i (05-13) - Rr. Hub		<b>PQ912</b> <i>PCD : mm</i>		
<b>919HUB</b>		Arriving Soon!		<b>5 Studs:</b> M12 x 1.5	Disc centre spigot:	
Bearing:	DAC51CRV			<b>Splines:</b>	<b>Notes:</b>	
Bearing ID:	51mm					
Outer Diameter:	152.2mm					
Height:		Honda CR-V III 2.0 i-VTEC R20A1, 2.2 i-CTDi N22A2, 2.2 i-DTEC N22B3, 2.4 i-Vtec K24Z1, K24Z4 - 4x4 (09-12), CR-V IV 2.2 i-DTEC N22B4 (2012-) - Fr. Hub		<b>PQ919</b> <i>PCD : 114.3mm</i>		
<b>922HUB</b>		Arriving Soon!		<b>5 Holes:</b> M14 x 1.25	Disc centre spigot:	
Bearing:	DAC45 8541ASB			<b>Splines:</b>	<b>Notes:</b>	
Bearing ID:	45mm					
Outer Diameter:	147mm					
Height:	85mm	BMW 1 Series F20/1 116i, 118i, 120d, 125i (11-16), 3 Series F30/1 316i, 320i, 328i, 330d, 335i, F34 320i, d, 328i, 335i (2012-) - Rr. Hub		<b>PQ922</b> <i>PCD : mm</i>		

## BUYERS GUIDE - HUBS









Part Number		Picture & Application		Holes/Studs	Spigot Diameter	
<b>922AHUB</b>		 	<b>5 Holes:</b> M12 x 1.5	Disc centre spigot:		<b>PQ922</b> <i>PCD : mm</i>
Bearing:	DAC45 8541ASB					
Bearing ID:	45mm					
Outer Diameter:						
Height:	67mm					
		BMW 3 Series E90 323i, 325i (05-13), 330Cd, d, 335i, d (05-11) - Rr. Hub		<b>Splines:</b>		<b>Notes:</b>
<b>922BHUB</b>		 	<b>5 Holes:</b> M12 x 1.5	Disc centre spigot:		<b>PQ922</b> <i>PCD : mm</i>
Bearing:	DAC4585 41ASB					
Bearing ID:	45mm					
Outer Diameter:	145mm					
Height:	93mm					
		BMW 3 Series E90 323i, 325i (05-13), 330Cd, d, 335i, d (05-11) - Rr. Hub		30	<b>Notes:</b>	
<b>923HUB</b>		 	<b>4 Studs:</b> M12 x 1.5	Disc centre spigot:	91mm	<b>PQ923</b> <i>PCD: 114mm</i> <i>solid discs</i>
Bearing:	DAC38BW- DAVZASB					
Bearing ID:	38mm					
Outer Diameter:	155mm					
Height:	97mm					
		Toyota Avanza 1.3, 1.5, i (11-16) - Fr. Hub		<b>Splines:</b>		<b>Notes:</b>
<b>923AHUB</b>		 	<b>4 Studs:</b> M12 x 1.5	Disc centre spigot:	87mm	<b>PQ923</b> <i>PCD: 114mm</i> <i>ventilated discs.</i>
Bearing:	DAC38BW- DAVZASB					
Bearing ID:	38mm					
Outer Diameter:	155mm					
Height:	97mm					
		Toyota Avanza 1.3, 1.5 (2015-) - Fr. Hub		<b>Splines:</b>		<b>Notes:</b>
<b>948HUB</b>		 	<b>4 Studs:</b> M12 x 1.5	Disc centre spigot:	54mm/ 62mm	<b>PQ948</b> <i>PCD: 100mm</i>
Bearing:	DAC36PIC					
Bearing ID:	36mm					
Outer Diameter:	121.5mm					
Height:	71mm					
		Kia Picanto 1.0, 1.2 (2011-) - Fr. Hub		24	<b>Notes:</b>	

## BUYERS GUIDE - HUBS





Part Number		Picture & Application		Holes/Studs	Spigot Diameter	
<b>971HUB</b>		<b>Arriving Soon!</b>		<b>5 Studs:</b>	Disc centre spigot:	
Bearing:	DAC-44FREE					
Bearing ID:	43mm					
Outer Diameter:	136mm					
Height:		Land Rover Freelander II 2.2D, TD4 (07-10) - Rr. Hub		28	<b>PQ971</b> <i>PCD: mm</i>	
<b>985HUB</b>		 		<b>5 Holes:</b>	Disc centre spigot:	
Bearing:	DAC458 441ASB					
Bearing ID:	45mm					
Outer Diameter:	141mm					
Height:	76mm	Mercedes-Benz W176 A-Class 180, CDi, 200, CDi, 250 (2013-), W246 B-Class 180, CDi, 200, Cdi, 250 (2012-) - Fr. Hub			<b>PQ985</b> <i>PCD: 112mm</i>	
<b>988HUB</b>		 		<b>5 Holes:</b>	Disc centre spigot:	
Bearing:	DAC54ML					
Bearing ID:	54mm					
Outer Diameter:	152mm					
Height:	89mm	Mercedes-Benz W164 ML Class 320Cdi, 350, 500, 63 AMG - 4X4 (2006-) - Fr. & Rr Hub			<b>PQ988</b> <i>PCD: 112mm</i>	
<b>1002HUB</b>		 			Disc centre spigot:	
Bearing:	DAC-42DUST					
Bearing ID:	42mm					
Outer Diameter:	136.5mm					
Height:		Renault Duster 1.5 Dci K9K, 1.6 K4M, 1.5 Dci - 4X4 (2013-), Fluence 1.6, 2.0 (2011-), Scenic III 1.6 (11-13) - Fr. & Rr Hub			<b>PQ1002</b> <i>PCD: mm</i>	
<b>1008HUB</b>		 		<b>4 Holes:</b>	Disc centre spigot:	
Bearing:	DAC-45MEG2					
Bearing ID:	45mm					
Outer Diameter:	128.5mm					
Height:	76.1mm	Renault Clio III 2.0, Megane III 2.0 (2010-) - Fr. Hub			<b>PQ1008</b> <i>PCD: mm</i>	



## BUYERS GUIDE - HUBS





Part Number		Picture & Application		Holes/Studs	Spigot Diameter	
<b>1015HUB</b>		 	<p><b>5 Studs:</b> M14 x 1.5</p> <p><b>Splines:</b> 36</p>	Disc centre spigot:	110mm/ 112mm	
Bearing:	HUB328			<b>Notes:</b>	<b>PQ1015</b> PCD: 149mm	
Bearing ID:	58mm					
Outer Diameter:	179mm					
Height:	96.5mm 115.5mm			Toyota Land Cruiser HDJ200 Series 4.5D-4D, 4.6, 4.7 (2007-) - Fr. Hub		
<b>1021HUB</b>		 	<p><b>6 Studs:</b> M12 x 1.25</p> <p><b>Splines:</b></p>	Disc centre spigot:	100.5mm	
Bearing:	HUB332			<b>Notes:</b>	<b>PQ1021</b> PCD: 114mm	
Bearing ID:	50mm					
Outer Diameter:	180mm					
Height:	132mm 147mm			Nissan NV350 2.5, D (2013-) - Fr. Hub		
<b>1022HUB</b>		 	<p><b>4 Holes:</b></p> <p><b>Splines:</b></p>	Disc centre spigot:		
Bearing:	DRT-42NV350			<b>Notes:</b>	<b>PQ1022</b> PCD: mm	
Bearing ID:	42mm					
Outer Diameter:	80mm/ 94.6mm					
Height:	65mm			Nissan NV350 2.5, D (2014-) - Rr. Housing/Hub		
<b>1028HUB</b>		 	<p><b>4 Studs:</b> M12 x 1.25</p> <p><b>Splines:</b> 23</p>	Disc centre spigot:	54mm/ 60mm	
Bearing:	DAC35 ALTO			<b>Notes:</b>	<b>PQ1028</b> PCD: 100mm	
Bearing ID:	35mm					
Outer Diameter:	120mm					
Height:	72.5mm			Suzuki Alto 1.0 (09-15) - Fr. Hub		
<b>1044HUB</b>		Arriving Soon!	<p><b>4 Holes:</b></p> <p><b>Splines:</b></p>	Disc centre spigot:		
Bearing:	DAC36UP			<b>Notes:</b>	<b>PQ1044</b> PCD: mm	
Bearing ID:	36mm					
Outer Diameter:						
Height:	71.4mm			VW UP 1.0 (2015-) - Fr. Hub		

## BUYERS GUIDE - HUBS



Part Number		Picture & Application		Holes/Studs	Spigot Diameter	
<b>1049HUB</b>				<b>4 Holes:</b>	Disc centre spigot:	
Bearing:	DRT45T6				<b>Splines:</b>	
Bearing ID:	79mm / 99mm					<b>PQ1049</b> <i>PCD: mm</i>
Outer Diameter:	64mm			Ford Ranger T6 2.2 D, 2.5, 3.2, D - 4X2, 4X4 (2012-) - Rr. Housing/Hub		
Height:						
<b>1056HUB</b>				<b>Splines:</b>	Disc centre spigot:	
Bearing:	12807S				<b>Notes:</b>	
Bearing ID:	37mm					<b>PQ467</b> <i>PCD: mm</i>
Outer Diameter:				<b>USE 622CHUB</b>		
Height:						
<b>1057HUB</b>				<b>6 Studs:</b> M12 x 1.5	Disc centre spigot:	106mm/ 108mm
Bearing:	DRT-54PRADO				<b>Splines:</b>	
Bearing ID:	54mm					<b>PQ1057</b> <i>PCD: 140mm</i>
Outer Diameter:	167mm			30		
Height:	104mm 117mm	Toyota Land Cruiser Prado 90/95 Series 3.0, 3.4 V6 4X4 (97-04) - Fr. Hub				
<b>1071HUB</b>		<b>Arriving Soon!</b>		<b>Splines:</b>	Disc centre spigot:	
Bearing:	DACFW-BTB				<b>Notes:</b>	
Bearing ID:						<b>PQ1071</b> <i>PCD: mm</i>
Outer Diameter:				Tata Bolt 1.2T XMS, XT (2015-) - Fr. Hub		
Height:						
<b>1081HUB</b>				<b>Splines:</b>	Disc centre spigot:	
Bearing:	HUB171				<b>Notes:</b>	
Bearing ID:	54mm					<b>PQ663</b> <i>PCD: mm</i>
Outer Diameter:				<b>USE 663HUB</b>		
Height:						





# BUYERS GUIDE - HUBS

Part Number		Picture & Application		Holes/Studs	Spigot Diameter		
<b>1081AHUB</b>			<b>6 Studs:</b> M12 x 1.25	Disc centre spigot:	106mm/ 108mm		
Bearing:	HUB171				<b>Splines:</b>	<b>Notes:</b>	
Bearing ID:	54mm			<b>USE 663AHUB</b> PQ663 PCD: 139mm			
Outer Diameter:	167mm						
Height:	82.8mm						
	112mm						
<b>1082LHUB</b>			<b>4 Holes:</b>	Disc centre spigot:			
Bearing:	DRT42RE-VO						<b>Splines:</b>
Bearing ID:	82mm			<b>PQ1082</b> PCD: 125mm			
Outer Diameter:	92.6mm/ 104.8mm						
Height:	65.6mm						
		Toyota Fortuner 2.4TD, 2.7 VVTi, 2.8TD, 3.0D-4D, 4.0 V6 - 4X2, 4X4 (2015-) - Rr. Hub					
<b>1082RHUB</b>			<b>4 Holes:</b>	Disc centre spigot:			
Bearing:	DRT42 REVO						<b>Splines:</b>
Bearing ID:	82mm			<b>PQ1082</b> PCD: 125mm			
Outer Diameter:	92.6mm 104.8mm						
Height:	65.6mm						
		Toyota Fortuner 2.4TD, 2.7 VVTi, 2.8TD, 3.0D-4D, 4.0 V6 - 4X2, 4X4 (2015-) - Rr. Hub					
<b>1082AHUB</b>			<b>4 Holes:</b>	Disc centre spigot:			
Bearing:	DRT42 REVO						<b>Splines:</b>
Bearing ID:				<b>PQ1082</b> PCD: mm			
Outer Diameter:							
Height:							
		Toyota Hilux "Revo" 2.0 VVTi, 2.4 GD, GD6, 2.7 VVTi, 2.8 GD6, 4.0 V6 - 4X2, 4X4 (2016-) - Rr. Hub					
<b>1091HUB</b>			<b>6 Studs:</b> M12 x 1.25	Disc centre spigot:	93mm/ 98mm		
Bearing:	DRT45 T6-50				<b>Splines:</b>	<b>Notes:</b>	
Bearing ID:	45mm			<b>PQ1091</b> PCD: 139mm			
Outer Diameter:	152mm						
Height:							
	158.5mm	Ford Ranger T6 2.2, 3.2 (2012-) - Fr. Hub					





## BUYERS GUIDE - HUBS

Part Number		Picture & Application		Holes/Studs	Spigot Diameter	
<b>1105HUB</b>					Disc centre spigot:	
Bearings:	94258820 94227044			<b>Splines:</b>	<b>Notes:</b>	
Bearing ID:						
Outer Diameter:						
Height						
		Chevrolet Trailblazer 2.5D - 4X2, 2.8D - 4X2, 4X4, 3.6 - 4X4 (12-14) - Fr. Hub		<b>PQ1105</b> <i>PCD: mm</i>		
<b>1118HUB</b>				<b>3 Holes:</b>		
Bearings:	PQ1118			<b>Notes:</b>		
Bearing ID:	35mm					
Outer Diameter:	102mm					
Height	56mm					
		Renault Kwid 0.8, 1.0 (2015-) - Fr. Hub		<b>PQ1118</b> <i>PCD: mm</i>		
<b>1120HUB</b>		Arriving Soon!			Disc centre spigot:	
Bearings:	DAC427 537ASB			<b>Splines:</b>	<b>Notes:</b>	
Bearing ID:	42mm					
Outer Diameter:						
Height						
		BMW 3 Series F30 318i, 320i, d, 330i, 340i Sport (2015-) - Rr. Hub		<b>PQ912</b> <i>PCD: mm</i>		
<b>1125HUB</b>		Arriving Soon!			Disc centre spigot:	
Bearings:				<b>Splines:</b>	<b>Notes:</b>	
Bearing ID:						
Outer Diameter:						
Height						
		Citroen C4 Picasso 1.6 (11-16) - Fr. Hub		<i>PCD: mm</i>		





## BUYERS GUIDE - HUBS

Part Number	Picture & Application	Bolt Holes
<b>SA106FL</b>	Arriving Soon!	Bearing I.D & Spigot Diameter
		Bearing ID:
		Ford "Boet" Bantam Rocam 1.3i XL, XLT, 1.4i TDCi, 1.6i XL, XLT, XLE, 1.8D XL (02-12)
<b>SA106FR</b>	Arriving Soon!	Bearing I.D & Spigot Diameter
		Bearing ID:
		Ford "Boet" Bantam Rocam 1.3i XL, XLT, 1.4i TDCi, 1.6i XL, XLT, XLE, 1.8D XL (02-12)
<b>SA107L</b>	 NO PICTURE AVAILABLE AT TIME OF PRINT	Bolt Holes:
		Bearing I.D & Spigot Diameter
		Bearing ID: 34mm
VW Citi Golf 1.3, 1.4, i, 1.6, i, 1.8 (83-08), Fox 1.3, 1.6, 1.8 (87-95), Golf I 1.1, 1.3, 1.5, 1.6, 1.8 (78-85), Jetta I 1.3, 1.5, 1.6, 1.8 (80-85), Caddy 1.6, 1.8 (81-96) - Fr. Axle		
<b>SA107R</b>	 NO PICTURE AVAILABLE AT TIME OF PRINT	Bolt Holes:
		Bearing I.D & Spigot Diameter
		Bearing ID: 34mm
VW Citi Golf 1.3, 1.4, i, 1.6, i, 1.8 (83-08), Fox 1.3, 1.6, 1.8 (87-95), Golf I 1.1, 1.3, 1.5, 1.6, 1.8 (78-85), Jetta I 1.3, 1.5, 1.6, 1.8 (80-85), Caddy 1.6, 1.8 (81-96) - Fr. Axle		
<b>SA108</b>		4 Bolt Holes: 10mm
		Bearing I.D & Spigot Diameter
		Bearing ID: 17.5mm & 29mm Oil Seal I.D: 40mm
VW Citi Golf - All (83-09), Golf/Jetta I (78-85), Golf/Jetta II (84-92) - Rr. Axle		





## BUYERS GUIDE - HUBS

Part Number	Picture & Application	Bolt Holes
SA108C		<b>4 Bolt Holes:</b> M10 x 1.25
		<b>Bearing I.D &amp; Spigot Diameter</b>
		<b>Bearing ID:</b> 17.5mm & 29mm <b>Oil Seal I.D:</b> 40mm
Opel Corsa B (96-03) - Rr. Axle		
SA151	 NO PICTURE AVAILABLE AT TIME OF PRINT	<b>Bearing I.D &amp; Spigot Diameter</b>
		<b>Bearing ID:</b>
		Audi A4 1.8, T (95-01) - Rr. Axle
SA178L		Non - ABS
		<b>Bearing I.D &amp; Spigot Diameter</b>
		<b>Bearing ID:</b> 21.4mm & 34.9mm
Nissan Hardbody (1998-), NP300 - 4X2 (2008-) - Fr. Axle		
SA178R		Non - ABS
		<b>Bearing I.D &amp; Spigot Diameter</b>
		<b>Bearing ID:</b> 21.4mm & 34.9mm
Nissan Hardbody (1998-), NP300 - 4X2 (2008-) - Fr. Axle		
SA184L		Non - ABS
		<b>Bearing I.D &amp; Spigot Diameter</b>
		<b>Bearing ID:</b> 38mm
Ford Laser 1.3, 1.4, 1.5, 1.6, 1.6i, 2.0i (86-02), Meteor 1.3, 1.4, 1.5, 1.6, 2.0 (86-95), Bantam 1.3, 1.6 (94-02), Mazda 323/ Sting/ Hatch/ Midge 1.3, 1.5, 1.6, 2.0, 2.0i (81-05), Rustler 1.3, 1.6 (94-02) - Fr. Axle		

## BUYERS GUIDE - HUBS





Part Number	Picture & Application	Bolt Holes
SA184R		Non - ABS
		<b>Bearing I.D &amp; Spigot Diameter</b>
		<b>Bearing ID:</b> 38mm
Ford Laser 1.3, 1.4, 1.5, 1.6, 1.6i, 2.0i (86-02), Meteor 1.3, 1.4, 1.5, 1.6, 2.0 (86-95), Bantam 1.3, 1.6 (94-02), Mazda 323/ Sting/ Hatch/ Midge 1.3, 1.5, 1.6, 2.0, 2.0i (81-05), Rustler 1.3, 1.6 (94-02) - Fr. Axle		
SA184NL		
		<b>Bearing I.D &amp; Spigot Diameter</b>
		<b>Bearing ID:</b> 38mm
Kia Pride 1.3i, Rio I 1.3, 1.5 (98-04) - Fr. Axle		
SA184NR		
		<b>Bearing I.D &amp; Spigot Diameter</b>
		<b>Bearing ID:</b> 38mm
Kia Pride 1.3i, Rio I 1.3, 1.5 (98-04) - Fr. Axle		
SA231L		<b>4 Bolt Holes:</b> M10 x 1.25mm
		<b>Bearing I.D &amp; Spigot Diameter</b>
		<b>Bearing ID:</b> 19mm & 29mm <b>Oil Seal I.D:</b> 40mm
Mazda 323 1.3, 1.5 Hatch, Sedan (81-95), 130, 160 Midge/Sting Hatch, Sedan (95-04) - Rr. Axle		
SA231R		<b>4 Bolt Holes:</b> M10 x 1.25mm
		<b>Bearing I.D &amp; Spigot Diameter</b>
		<b>Bearing ID:</b> 19mm & 29mm <b>Oil Seal I.D:</b> 40mm
Mazda 323 1.3, 1.5 Hatch, Sedan (81-95), 130, 160 Midge/Sting Hatch, Sedan (95-04) - Rr. Axle		

## BUYERS GUIDE - HUBS





Part Number	Picture & Application	Bolt Holes
<p style="text-align: center; font-size: 24pt; font-weight: bold;">SA418</p>		<p style="text-align: center;"><b>4 Bolt Holes:</b> M10 x 1.5mm</p>
		<p style="text-align: center;"><b>Bearing I.D &amp; Spigot Diameter</b></p>
		<p style="text-align: center;"><b>Bearing ID:</b> 29mm <b>Oil Seal I.D:</b> 41mm</p>
<p>Ford Bantam (03-12), Escort (95-00), Fiesta (97-04), Ikon (01-06), KA (05-09), Mazda 121 Soho 1.3, 1.4 (97-99) - Rr. Axle</p>		
<p style="text-align: center; font-size: 24pt; font-weight: bold;">SA437L</p>		<p style="text-align: center;"><b>4 Bolt Holes:</b> M10 x 1.25mm</p>
		<p style="text-align: center;"><b>Bearing I.D &amp; Spigot Diameter</b></p>
		<p style="text-align: center;"><b>Bearing ID:</b> 25mm</p>
<p>Chevrolet Spark 1.0 B110S1, 1.2 B12D1 (2010-) - Rr. Axle</p>		
<p style="text-align: center; font-size: 24pt; font-weight: bold;">SA437R</p>		<p style="text-align: center;"><b>4 Bolt Holes:</b> M10 x 1.25mm</p>
		<p style="text-align: center;"><b>Bearing I.D &amp; Spigot Diameter</b></p>
		<p style="text-align: center;"><b>Bearing ID:</b> 25mm</p>
<p>Chevrolet Spark 1.0 B110S1, 1.2 B12D1 (2010-) - Rr. Axle</p>		
<p style="text-align: center; font-size: 24pt; font-weight: bold;">SA450</p>		<p style="text-align: center;"><b>1 Bolt Hole:</b> 17.4mm <b>4 Bolt Holes:</b> 10mm <b>2 Bolt Holes:</b> M6 x 1.00mm</p>
		<p style="text-align: center;"><b>Bearing I.D &amp; Spigot Diameter</b></p>
		<p style="text-align: center;"><b>Bearing ID:</b> 30mm</p>
<p>Audi A3 1.8, 1.8T (98-03), A4 1.8, 1.8T (95-01), TT 1.8T (00-06), VW Beetle 1.8T, Coupe (2000-), Golf 4 1.6i Comfortline, 1.8, T, GTi, Highline, 1.9TDi, 2.0i Cabrio (99-04), Jetta 4 1.6i Comfortline, 1.8, T, 1.9TDi, 2.0 Highline, 2.3 V5 (99-05) - Rr. Axle</p>		
<p style="text-align: center; font-size: 24pt; font-weight: bold;">SA487</p>		<p style="text-align: center;"><b>Bearing I.D &amp; Spigot Diameter</b></p>
		<p style="text-align: center;"><b>Bearing ID:</b></p>
		<p>Nissan Micra (K12) 1.4 16v CR14DE, 1.5 Dci K9K (02-10), Renault Logan 1.6 (2009-) - Rr. Axle</p>







## BUYERS GUIDE - HUBS

Part Number	Picture & Application	Bolt Holes
<b>SA500</b> (ABS)		<b>4 Bolt Holes:</b> M10 x 1.5mm
		<b>Bearing I.D &amp; Spigot Diameter</b>
		<b>Bearing ID:</b> 29mm
Ford Fiesta II 1.4i Trend Zetec, 1.6i RSi, TDCi Rocam, 2.0 ST, ST150 (04-09), Focus I 1.6 16v (00-05) - Rr. Axle		
<b>SA500A</b> (Non ABS)		<b>4 Bolt Holes:</b> M10 x 1.5mm
		<b>Bearing I.D &amp; Spigot Diameter</b>
		<b>Bearing ID:</b> 29mm
Ford Fiesta II 04-09 1.4i, 1.6i, 2.0 (04-09), Focus I, II 1.6, i, 1.8, 2.0, i, 2.5 (00-09) - Rr. Axle		
<b>SA500BL</b>		<b>4 Bolt Holes:</b> M10 x 1.5mm <b>2 Bolt Holes:</b> 10mm
		<b>Bearing I.D &amp; Spigot Diameter</b>
		<b>Bearing ID:</b> 29mm
Ford Focus I (00-05), Focus II (05-10) - Rr. Axle		
<b>SA500BR</b>		<b>4 Bolt Holes:</b> M10 x 1.5mm <b>2 Bolt Holes:</b> 10mm
		<b>Bearing I.D &amp; Spigot Diameter</b>
		<b>Bearing ID:</b> 29mm
Ford Focus I (00-05), Focus II (05-10) - Rr. Axle		
<b>SA622L</b>		
		<b>Bearing I.D &amp; Spigot Diameter</b>
<b>Bearing ID:</b>		
Nissan NP200 1.5DCi S, SE P/up K9K, 1.6 S, SE P/up 8V K7M, 16V K4M (2008-) - Fr. Axle		





## BUYERS GUIDE - HUBS

Part Number	Picture & Application	Bolt Holes
SA622R		
		<b>Bearing I.D &amp; Spigot Diameter</b>
		<b>Bearing ID:</b>
Nissan NP200 1.5DCi S, SE P/up K9K, 1.6 S, SE P/up 8V K7M, 16V K4M (2008-) - Fr. Axle		
SA702		<b>4 Bolt Holes:</b> 10mm
		<b>Bearing I.D &amp; Spigot Diameter</b>
		<b>Bearing ID:</b> 28mm
Audi A1 1.0 TFSi, 1.2 TFSi, 1.4 TFSi, 1.6 TDi, 1.8 TFSi (11-18), Seat Ibiza (06-08), VW Polo 9N (02-10), Cross Polo (2007-), Vivo (2010-), Polo 6R (10-14), Polo 6C (2014-) - Rr. Axle		
SA711		<b>4 Bolt Holes:</b> M10 x 1.25mm
		<b>Bearing I.D &amp; Spigot Diameter</b>
		<b>Bearing ID:</b> 43mm
Opel Corsa LDV II 1.4i, 1.7DTi, 1.8i (03-10 - Rr. Axle		
SA713	 NO PICTURE AVAILABLE AT TIME OF PRINT	<b>4 Bolt Holes:</b> M10 x 1.25mm
		<b>Bearing I.D &amp; Spigot Diameter</b>
		<b>Bearing ID:</b> 43mm
Nissan Almera 1.5DCi (2013), Datsun Go/ Go+ 1.2 (2014-), Micra (K13) 1.2i HR12DE, 1.5 Dies. K9K, 1.5i Pet. HR15DE (2010-) - Rr. Axle		
SA720	 NO PICTURE AVAILABLE AT TIME OF PRINT	<b>Bearing I.D &amp; Spigot Diameter</b>
		<b>Bearing ID:</b>
		Renault Sandero 900T H4B400/JH3 (2014-) - Rr. Axle

## BUYERS GUIDE - HUBS

Part Number	Picture & Application	Bolt Holes
SA728L		
		<b>Bearing I.D &amp; Spigot Diameter</b>
		<b>Bearing ID:</b> 53mm
Toyota Quantum 2.5i MPV, Bus, P/Van, 2.7i MPV, Bus, P/Van (2005-) - Fr. Axle		
SA728R		
		<b>Bearing I.D &amp; Spigot Diameter</b>
		<b>Bearing ID:</b> 53mm
Toyota Quantum 2.5i MPV, Bus, P/Van, 2.7i MPV, Bus, P/Van (2005-) - Fr. Axle		
SA760L	 NO PICTURE AVAILABLE AT TIME OF PRINT	
		<b>Bearing I.D &amp; Spigot Diameter</b>
		<b>Bearing ID:</b>
Toyota Hilux 2.0 1TR-FE, 2.5 D-4D 2KD-FTV, 2.7 2TR-FE, 3.0 D-4D 1KD-FTV, 4.0 1GR-FE 4X2, 4X4 (05-15) - Fr. Axle		
SA760R	 NO PICTURE AVAILABLE AT TIME OF PRINT	
		<b>Bearing I.D &amp; Spigot Diameter</b>
Toyota Hilux 2.0 1TR-FE, 2.5 D-4D 2KD-FTV, 2.7 2TR-FE, 3.0 D-4D 1KD-FTV, 4.0 1GR-FE 4X2, 4X4 (05-15) - Fr. Axle		
SA823	 NO PICTURE AVAILABLE AT TIME OF PRINT	
		<b>Bearing I.D &amp; Spigot Diameter</b>
		<b>Bearing ID:</b>
Opel Corsa E 1.0, 1.4, 2017- 1.4 - Drums (2015-) - Rr. Axle		

## BUYERS GUIDE - HUBS

Part Number	Picture & Application	Bolt Holes
<b>SA824</b>	 QUALITY GUARANTEED AUTO PARTS  NO PICTURE AVAILABLE AT TIME OF PRINT	Bearing I.D & Spigot Diameter
		Bearing ID:
		Opel Corsa E 1.0, 1.4, 2017- 1.4 - Discs (2015-) - Rr. Axle
<b>SA826</b>	 QUALITY GUARANTEED AUTO PARTS  NO PICTURE AVAILABLE AT TIME OF PRINT	Bearing I.D & Spigot Diameter
		Bearing ID:
		Nissan NP200 1.5DCi S, SE P/up K9K, 1.6 S, SE P/up 8V K7M, 16V K4M (2008-) - Rr. Axle
<b>SA880</b>	 QUALITY GUARANTEED AUTO PARTS  NO PICTURE AVAILABLE AT TIME OF PRINT	Bearing I.D & Spigot Diameter
		Bearing ID:
		Tata Bolt 1.2T XMX, XT (2015-), Indica / Vista 1.4 LEi, LSi, LX, LXi, 1.4TDi DLX, DLS, Indigo, 1.4 GLS S/W 1.4TDi DLX S/W - Rr. Axle
<b>SA1004</b>	 QUALITY GUARANTEED AUTO PARTS  NO PICTURE AVAILABLE AT TIME OF PRINT	Bearing I.D & Spigot Diameter
		Bearing ID:
		Renault Captur 0.9 Tce, 1.2 Tce, 1.5 Dci (2016-), Duster 1.5 Dci, 1.6 - 4X2 (2013-) - Rr. Axle
<b>SA1119</b>	 QUALITY GUARANTEED AUTO PARTS  NO PICTURE AVAILABLE AT TIME OF PRINT	Bearing I.D & Spigot Diameter
		Bearing ID:
		Renault Kwid 1.0 B4D 404 (2015-) Rr. Axle

# BUYERS GUIDE - LOOSE BEARINGS

<b>02420+74</b>	Front Wheel Bearing Outer	Toyota Dyna 2.0, 2.2, 2.4, 3.0, 3.7, 4.0 (85-02)
<b>02420+75</b>	Diff. Pinion Bearing Rear	Isuzu KB230, KB250D, KB40, KB41, KB42, KB43, KB44, KBD40, KBD41, KBD42 - 4X4 (79-04)
<b>038KB</b>	Diff. Carrier Bearing	Toyota Conquest 1.3, 1.6 (85-93), Corolla 1.3, 1.6 (84-94)
<b>038KB0</b>	Diff. Carrier Bearing	Toyota Conquest 1.3 (88-93), Corolla 1.6 (91-93)
<b>038KC68</b>	Diff. Carrier Bearing	Toyota Conquest/ Tazz 1.3, 1.6, 1.8 (86-06), Corolla 1.3, 1.6, 1.8 (85-02)
<b>039KC68</b>	Diff. Carrier Bearing	Toyota Conquest 1.8 (93-94)
<b>09067+09195</b>	Front Wheel Bearing Outer	Toyota Hiace 1.5, 1.6 (69-77), Hilux 1.5, 1.6 (69-75)
<b>12131</b>	Front Wheel Bearing Inner	Alfa Romeo 146 2.0 Ti Twin Spark AR67204 (96-99), 155 2.0 TS AR32301 (96-99), GTV / Spider 2.0 (96-06), Fiat Doblo 1.9 Cargo P/van 223A6.000 (03-06), Multipla 1.6 Active, 1.6 SX, 1.9 JTD ELX MPV 182A4.000 (03-10), Punto 1.3D 2U 188 JTD Dynamic, JTD Multijet 188A9.000 (04-13)
<b>12132</b>	Front Wheel Bearing Inner	Fiat Palio I 1.2 ED, EL, Go!, Paint Ltd. M657BA.12T 178B5.000, 1.6 EL, ELX, HL, Weekend S/W, 178B3.000 (00-05), Palio II 1.2 Espresso 178B6.000, 1.2 Go!, 178B5.000, 1.6 178B3.000, 1.7TD, EL, (05-10), Siena I/II 1.2 EL, EL, Plus!, M657BA 12T, 1.6 EL, Plus!, ELX HL 178B3.000, 1.6 EL+, HL, ELX, 178B3000, 1.7TD EL 176A3.000 (00-10), Uno 1.4 Turbo 146A (90-98)
<b>28006</b>	Rear Wheel Bearing Inner	Toyota Conquest / Tazz EE80 1.3 GL, GS, L, S 2EL EE90R, 130 Sport, Tazz, Edition, Zipp, Tropique, Tazz EE90R 130 Edition, Ruby, Tropique, Sport, McTazz, XE 2E (85-06), AE82R 1.6 GL, RS, RSi 4A-L, A-GEL, AE92R 160i LS, RS, RSi, Sport, RSE, Tazz 4A-F, A-FE, A-GE, AE92R 160i Edition, Sport, Tazz, XE 4AFE (85-91), Corolla FWD AE82R 1.6 GL, GLE, GLi, GLS, GLX, Avante, GLE, GLi, S/W 4A-L, A-GEL (84-88), AE/EE80R 1.3 GL, L, 2A-L, E-L, EE90R 1.3 GL, GLE, L, Sprinter 2E-L, E EE110R, 130 GLE, Sprinter 2E (84-91), AE92R 1.6, 160 GL, GLE, GLi, Exec., GLS, Exec., GLX, Sport Sprinter 4A-F, A-FE, A-GE (88-91)
<b>30203</b>	Front, Rear & Carrier Bearing	Various Makes/Models
<b>30204</b>	Front & Rear Wheel Bearing Outer	Chevrolet Spark 0.8 L, LS, 1.0 LT, LS (03-10), Daewoo Matiz 800cc S, SE F8CV (99-03), Mazda B-Series B2000 2.0 SWB P/up MA Pet., B2200 2.2 SWB/LWB P/up S2 Dies. (82-86), Renault R5 1.3, GTL, LS, LSS, TS 810-25, 1.4 TS 847-C2J, 1.3 Panel Van 810-25 (75-76), Tata Indica / Vista 1.4 LEi, LSi, LX, Lxi, 1.4TDi DLX, DLS, Indigo 1.4 GLS S/W, 1.4TDi DLX S/W (2005-)
<b>30205</b>	Front /Rear / Diff. Pinion Bearing Outer	Audi A4 2.5 TDi 8D/E2 Quattro AFB, Quattro Tiptronic, 2.6 8D2 / 8D5 Exec. (95-00), 3.0 Quattro Tiptronic, ASN (02-08), A6 2.8 Quattro 4A, AAH, ACK, 3.0 Quattro Tiptronic BBJ (94-00), A6 2.4 Avant Multitronic., Tiptronic, AGA, ALF, AML, APS, ARJ, 2.5TDi Multitronic Avant SW., BCZ/BDG/BFC, 2.6 ABC (97-03), A6 2.7T Quattro AJK, ARE, BES, A6 4.2 Quattro Tiptronic ARS (00-08), A8 3.7 Tiptronic AQG, 4D2, 4.2 Quattro 4E2/8 BFM (95-02), S4 2.2T Quattro AAN (92-95), 4.2 Quattro, Avant 8E2/E5, S/W, BBK, AQF (03-08), Chevrolet Spark 0.8 L, LS, 1.0 LT, LS (03-10), Daewoo Matiz 800cc S, SE F8CV (99-03), Ford Courier 1.6 P/up F6, 1.8 Chassis cab, Explorer, Std., XLT P/up F8., 2.0 XLT FE., 2.2 D/cab, Explorer, Leisure, Std., XLT P (86-00), 3.0 V6 D/cab, Explorer, L, Leisure, Std., P/up Essex (86-97), 2.5 Turbo Diesel D/cab, Leisure P/up WL4 - 4X2, 2.5TD D/cab, Leisure P/up WL4 - 4X4 (96-00), 3.4 V6 Leisure D/cab, P/up Essex - 4X2 (97-01), Ranger 1.8 XL, P/up, 2.2 XL, P/up (00-05), 2.5 Diesel, Turbo Diesel D/Cab, High Trail, XL, DT XLT High Trail D/Cab, Super Cab - 4X2 (00-09), Spectron 2.2 Bus, P/van F2 (91-04), GWM Double Cab Lux 2.2 TDi, MPI, Standard (2007-), GWM Steed 3 2.2i S/Cab, D/Cab (10-13), Kia K2700i 2.7D Workhorse LWB Dies. "Bakkie" D/S (2004-), Mazda B-Series B2600 2.6 LWB D/cab, Magnum, Drifter P/up 4G54 Pet. (86-95), B2600i 2.6i LWB D/cab Drifter, SLX P/up 4G54 Pet. - 4X2 (00-01), B3000 3.0 V6 LWB D/cab, Magnum Drifter P/up Essex Pet. - 4X2 (86-97), B1600 1.6 SWB Magnum P/up F6 Pet., B1800 1.8 SWB/LWB Magnum, Drifter P/up F8 Pet., B2000 2.0 LWB Drifter, Magnum P/up FE Pet., B2200 2.2 LWB D/cab, Drifter, Magnum P/up R2 Dies., 2.2 LWB D/cab, Drifter, Magnum P/up F2 Pet. (86-00), B3400 3.4 V6 LWB Magnum D/cab P/up Essex Pet. - 4X2 (96-00), B2500 2.5 LWB Diesel, Turbo Diesel D/cab, Drifter, SLX P/up WL4 Dies., Turbo - 4X2 (97-00), Drifter 1.8 SWB/LWB XL P/up Pet., 2.2 SWB/LWB XL P/up Pet. (00-04), 2.5Td LWB Hi Ride, SL SLE, SLX D/cab, Hi Ride, Hi Trail D/cab P/up WL4 Dies./Turbo Dies., 2.6i LWB Hi Ride, SL Hi Ride S/cab, SLE, SLX D/cab SLX Hi Ride D/cab, SLX Hi Trail D/cab P/up Pet. - 4X2 (00-04), Marathon 2.2 LWB Bus, P/van F2 Pet. (91-04), Renault R5 1.3, GTL, LS, LSS, TS 810-25, 1.4 TS 847-C2J, 1.3 Panel Van 810-25 (75-76), Indica / Vista 1.4 LEi, LSi, LX, Lxi, 1.4TDi DLX, DLS, Indigo 1.4 GLS S/W, 1.4TDi DLX S/W (2005-), Tata Safari 2.2 CRDi GLS Dies. (2007-), Super Ace 1.4TD (2012-), Telcoline 2.0 Turbo Diesel S/Cab P/up (04-10), Xenon 2.0TDi, 3.0TDi (2008-)



## BUYERS GUIDE - LOOSE BEARINGS

<b>30206</b>	Front Wheel Bearing Inner / Diff. Carrier Bearing	Mazda B-Series B2000 2.0 SWB P/up MA Pet., B2200 2.2 SWB/LWB P/up S2 Dies. (82-86), Nissan Stanza 1.6 DL, Resort, S/W L16, 1.8 GL, Resort, S/W SSS L18 (80-84)
<b>30207</b>	Front Wheel Bearing Outer / Diff. Carrier Bearing	Mitsubishi Canter 2.5 SWB/LWB D/side, Chassis cab 4G55 Dies., 2.6 4G54 Pet., 3.3 4D30A Dies., 3.8 ADE236 Dies. (80-97), Nissan B140 1.4 A14SP/van, S/W, Deluxe, Std. Sport, Champ P/up (93-08), Skyline R30 1.8 L18 (82-87)
<b>30208</b>	Rear Wheel Bearing Inner / Diff. Carrier Bearing	C.A.M. Rhino 2.2i, 2.8i (2007-), Ford Courier 3.0 V6 Std., XLT, D/cab, Leisure, Explorer, Exec. P/up Essex - 4X4 (97-00), Spectron 2.2 Bus, P/van F2 (91-04), Hyundai Bakkie 2.5i D4BH Dies., 2.6i D4BB Dies., H100 P/van 2.5i D4BH Dies., 2.6i D4BB Dies. (Import) (97-07), Isuzu KB20 1.6 P/up G161Z Pet., KB21 1.6 P/up G161Z Pet., KB22 1.8 P/up G180Z Pet., KBD20 2.0 P/up C190, KBD21 2.0 P/up C190, KBD22 2.2 LE, P/up C223, KB23 2.0 P/up G200Z, KB24 2.3 LE 4ZD1, KB25 1.6 P/up G161Z, KB26 1.6 P/up G161Z, 1.8 P/up G180Z, KBD23 2.5 LE, P/up 4JA1, KBD25 2.0 P/up C190 (78-89), KBD26 2.0 P/up C190, KBD27 2.2 C223, KBD28 2.5 4JA1 (81-89), KB27 1.8 P/up G180Z, KB28 2.0 P/up G200Z, KB29 2.3 P/up 4ZD1 (83-89), KB40 1.6 G161Z, KB41 1.6 G161Z, 1.8 G180Z, KB42 1.8 G180Z, KB43 2.0 G200Z, KB44 2.3 4ZD1, KBD40 KBD41 2.0 P/up C190, KBD42 2.2 P/up C223 - 4X4 (79-89), KB250D 2.5 Fleetside, LE, D/Cab P/up 4JA1, KB280DT 2.8 D/cab LE, LX, Frontier P/up Turbo 4JB1 (89-04), Relay 2.0 P/van, Bus 4ZC1 (89-95), Mazda B-Series B2600 2.6 V6 LWB D/cab, Magnum, Drifter P/up 4G54 Pet., 3.0 V6 LWB D/cab, Magnum, Drifter, Magnum Drifter P/up Essex Pet. - 4X4 (86-95), Marathon 2.2 LWB Bus, P/van F2 Pet. (91-04), Mitsubishi Colt LDV 1.6 SWB/LWB Lo-Line P/up 4G32 Pet., 2.0 4G63 Pet., 2.5D 4D56 Dies., 2.6 WB Hi-Line P/up 4G54 Pet. (94-98), Colt LDV 2.5D LWB Hi-Line P/up 4D56 Dies., 2.6 LWB Lo-/Hi-Line, P/up 4G54 Pet., 3.0 V6 LWB Lo-/Hi-Line D/cab, Rodeo 6G72 Pet. - 4X4 (95-98), Pajero 2.8 Tdi, 3.0 V6 SWB GLS Wagon 6G72 Pet., 3.5 V6 SWB GLS Wagon 6G74 Pet. - 4X4 (90-01), Nissan 1-Tonner/Hardbody AW/D21 2.4 Z24S, 2.7 TD27, 3.0 VG30E - 4X4 (88-99), 720 D20 1.8 L18S Kingcab, Sport, 2.2D SD/Z22 Tracker, 2.3 SD23 - 4X2, 1.8 L18S, 2.0 NA20, 2.2 Z22 - 4X4 (80-88), E20 1.8 L18 Bus, P/van, Coach, Coach GL, GLE, Econolux, Ekonovan, Ekonowagon, 2.0 Bus, Van H20 (80-96), Hardbody NP300 D22 2.4i, S/C, D/C, Highrider KA24 DE, 2.5TDi, S, SE, Highrider YD25 - 4X4 (2008-), Langley 1.3 GL E13, 1.5 GL, L, SSS, Trebon, Exa Turbo E15 (83-88), Laurel C31 2.0 CA/L20, 2.8 SGL 5L28 (80-87), Maxima GV Series 300SE VG30E (91-97), Patrol Y60 3.0 VG30E - 4X4 (95-00), Pulsar 1.3 S E13, 1.4 DL, GX A14, 1.5 GL, Panache, SX E15 (80-87), Sabre 160 GX, GXi GA16DS (94-02), Sani AW/D21 2.2 Z22, 2.4 Z24, 2.7 TD27, 3.0 VG30E - 4X4 (86-98), Sentra 1.3 GL, SX E13S (87-92), 140, i, GX, GXi, Si GA14DNE / DS, 160 GSi, GX, GXi, SE, Si GA16DE/DNE/ DS (92-02), Skyline R30 2.0 GL L20, R31 2.0 GL, GLE CA20 (82-92), R30 2.8 GLX, GTX L28/2 (83-86), R31 2.0 SGi, SGLi RB20E (87-92), Toyota Camry I SXV10/11 R 200i Si 3S-FE, 220 SEi, Si, 5S-FE (92-01), Camry I MCV10/ VCV10 300SEi 1MZ-FE / 3VZ-FE, Quad Cam (94-01), Corolla FWD AE82R 1.6 GL, GLE, GLi, GLS, GLX, Avante, GLE, GLi, S/W 4A-L, A-GEL (84-88), AE92R 1.6, 160 GL, GLE, GLi, Exec., GLS, Exec., GLX, Sport Sprinter 4A-F, A-FE, A-GE (88-96)
<b>30209</b>	Diff. Carrier Bearing	Nissan Hardbody QW/D22 2.4i KA24E, 2.7 TD27, 3.0 VG30E, 3.0TD ZD30, 3.2, 3.2D QD32, 3.3i VG33 - 4X4 (98-10), NP300 D22 2.0i, S, SE KA20, 2.4i, S/C, D/C Highrider KA24 DE, 2.5TDi, S, SE Highrider YD25, 2.5TDi, S, SE YD25 (2008-), NP300 D22 2.4i, S/C, D/C, Highrider KA24 DE, 2.5TDi, S, SE, Highrider YD25 - 4X4 (2008-), NV350 2.5 QR25DE, 2.5D YD25DDTi (2013-), Patrol Y61 3.0Di, 4.2 TD42 - 4X4 (99-04), Terrano II 2.7 TD27 - 4X4 (00-02)
<b>30210</b>	Front Wheel Bearing Inner	Mitsubishi Canter 2.5 SWB/LWB D/side, Chassis cab 4G55 Dies., 2.6 4G54 Pet., 3.3 4D30A Dies., 3.8 ADE236 Dies. (80-97)
<b>30211</b>	Rear Wheel Bearing Outer	Mitsubishi Canter 2.5 SWB/LWB D/side, Chassis cab 4G55 Dies., 2.6 4G54 Pet., 3.3 4D30A Dies., 3.8 ADE236 Dies. (80-97)
<b>30212</b>	Rear Wheel Bearing Inner	Mitsubishi Canter 2.5, 2.6, 3.3, 3.8 (80-97)
<b>30302</b>	Front Wheel Bearing	Nissan 1200 (71-75), B120 (71-73)
<b>30304</b>	Front Wheel Bearing	Mazda Capella 573 (74-76), RX2 573 (72-74), Nissan 2000 (68-73), 2300 (69-73), 2400 (71-72), 240C (72-73), 260C (73-75), 300C (72-78), 521 1.5 (68-73), 620 1.5 (73-77), Toyota Stout 1.9, 2.0 (62-79), VW Beetle 1.2, 1.3, 1.5, 1.6 (61-79)
<b>30305</b>	Diff. Pinion Bearing	Isuzu KB40 1.6 G161Z, KB41 1.6 G161Z, 1.8 G180Z, KB42 1.8 G180Z, KB43 2.0 G200Z, KB44 2.3 4ZD1, KBD40 KBD41 2.0 P/up C190, KBD42 2.2 P/up C223 - 4X4 (79-89), KB220 2.2 LE P/up, KB230 2.3 P/up 4ZD1, KB260 2.6 D/cab, LE, LX, KB320 3.2 V6 Frontier LX, KB250D 2.5 LE, D/cab P/up 4JA1, KB280DT 2.8 LE, LX, D/cab P/up Turbo 4JB1 - 4X4 (89-04), Nissan Stanza 1.6 DL, Resort, S/W L16, 1.8 GL, Resort, S/W SSS L18 (80-84), Skyline R30 2.0 GL L20, R31 2.0 GL, GLE CA20 (82-92)



## BUYERS GUIDE - LOOSE BEARINGS

<b>30306</b>	Diff. Pinion Bearing	<p>C.A.M. Rhino 2.2i, 2.8i (2007-), Ford Courier 3.0 V6 Std., XLT, D/cab, Leisure, Explorer, Exec. P/up Essex - 4X4 (97-00), Ford Spectron 2.2 Bus, P/van F2 (91-04), Isuzu KB20 1.6 P/up G161Z Pet., KB21 1.6 P/up G161Z Pet., KB22 1.8 P/up G180Z Pet., KBD20 2.0 P/up C190, KBD21 2.0 P/up C190, KBD22 2.2 LE, P/up C223, KB23 2.0 P/up G200Z, KB24 2.3 LE 4ZD1, KB25 1.6 P/up G161Z, KB26 1.6 P/up G161Z, 1.8 P/up G180Z, KBD23 2.5 LE, P/up 4JA1, KBD25 2.0 P/up C190 (78-89), KBD26 2.0 P/up C190, KBD27 2.2 C223, KBD28 2.5 4JA1, KB27 1.8 P/up G180Z, KB28 2.0 P/up G200Z, KB29 2.3 P/up 4ZD1 (81-89), KB40 1.6 G161Z, KB41 1.6 G161Z, 1.8 G180Z, KB42 1.8 G180Z, KB43 2.0 G200Z, KB44 2.3 4ZD1, KBD40 KBD41 2.0 P/up C190, KBD42 2.2 P/up C223 - 4X4 (79-89), Relay 2.0 P/van, Bus 4ZC1 (89-95), Mazda B-Series B2600 2.6 V6 LWB D/cab, Magnum, Drifter P/up 4G54 Pet., B3000 3.0 V6 LWB D/cab, Magnum, Drifter, Magnum Drifter P/up Essex Pet. - 4X4 (86-97), Marathon 2.2 LWB Bus, P/van F2 Pet. (91-04), Nissan 720 D20 1.8 L18S Kingcab, Sport, 2.2D SD/Z22 Tracker, 2.3 SD23 (80-88), 1.8 L18S, 2.0 NA20, 2.2 Z22 - 4X4 (80-88), E20 1.8 L18 Bus, P/van Coach, Coach GL, GLE, Econolux, Ekonovan, Ekonowagon, 2.0 Bus, Van H20 (80-96), Toyota Condor 2.4i Estate, TX Estate 2RZ-E, 3.0 Estate, TX Estate 5L - 4X4 (00-05), Corolla TE71 1.6 P/van 2T (83-89), KE70 1.3 P/van 4K (84-88), Cressida GX60 2.0 GLi6 1G-E, GX7 2.0 GLi6 1G-E, 1G-FE (83-92), MX63 2.8i 5M-E, MX73 2.8i RSi, RSi Exec. 5M-GE (84-89), RX73 2.4 GLE, GLE S/W 22R With I.R.S. (Independent Rear Suspension) (87-92), Hiace YH51/61 2.0 SWB/LWB 16 Seater Commuter, Super 10 Seater Custom Wagon, P/van 3Y Pet. (83-85), Hilux LN30/40/50/51/55 2.2 SWB/LWB P/up L Dies., 2.4 SWB/LWB D/cab, Raider P/up 2L Dies., YN58 2.2 LWB D/cab, Raider, SRX P/up 4Y Pet. (79-98), YN67 2.2 LWB D/cab, Raider D/cab P/up 4Y Pet. - 4X4 (86-94), YN51/56 1.8 SWB/LWB D/cab, S, SR, Raider P/up 2Y Pet., YN140 1.8 SWB/LWB D/cab, Raider, S, SRX P/up 2Y Pet. (86-05), LN65 2.4 LWB D/cab, Raider D/cab P/up 2L Dies. - 4X4 (89-98), RN67 2.4 LWB D/cab, Raider D/cab P/up 22R Pet. - 4X4 (94-98), LN57 2.8D LWB D/cab, Raider P/up 3L Dies. - 4X2 (95-98), RZN169 2.7i LWB D/cab, DLX S/cab, Raider S/D/cab, SRX D/cab, Legend 35 LWB P/up 3RZFE Pet. - 4X4 (98-05), LN167 3.0D D/cab D-E, DLX, S/D/cab DE, Raider DE, Legend35 LWB P/up 5L Dies., 3.0iD LWB Raider S/cab &amp; KZ-TE D/cab P/up, Legend35 - 4X4 (98-05), Land Cruiser FJ80 4.0 DLX, GX, VX P/up 3F/F-E Pet. - 4X4 (90-92), FZJ80 4.5 Std., GX, VX, Turbo S/W, P/up 1FZ-FE Dies., Turbo Dies. - 4X4 (92-95), FZJ80 4.5 Std., GX, VX, Turbo S/W, P/up 1FZ-FE Dies., Turbo Dies. - 4X4 (95-06), HDJ/HZJ80 4.2 Std., GX, VX, Turbo S/W, P/up 1HD-FT, 1HZ Dies., Turbo Dies. - 4X4 (95-01), PHJ75 3.9 DLX, GX, GX Turbo P/up Perkins236 2H Dies., FJ75 4.0 DLX, GX, VX 3F/F-E Pet., HJ75 - 4X4 (85-92), Stallion KF50 1.5 SR5,Commuter, Bus, P/up, P/van 5K Pet., YF50 1.8 SR5, P/up, P/van, Van 2Y Pet., LF50 2.4D P/up 2L5F Dies. (87-04), Stout RK110 2.0 SWB P/up 5R Pet. (79-89), Tuv KF20 1.3 Chassis Cab, P/up, P/van, Bus 4K Pet., 1.5 P/up 5K Pet. (82-87)</p>
<b>30307</b>	Diff. Pinion Bearing	<p>C.A.M. Rhino 2.2i, 2.8i (2007-), Ford Courier 3.0 V6 Std., XLT, D/cab, Leisure, Explorer, Exec. P/up Essex, 3.4 V6 Leisure, P/up Essex. - 4X4 (97-00), Spectron 2.2 Bus, P/van F2 (91-04), Mazda B-Series B2600 2.6 V6 LWB D/cab, Magnum, Drifter P/up 4G54 Pet. - 4X4 (86-95), B3000 3.0 V6 LWB D/cab, Magnum, Drifter, Magnum Drifter P/up Essex Pet. - 4X4 (86-97), Marathon 2.2 LWB Bus, P/van F2 Pet. (91-04)</p>
<b>30308</b>	Diff. Pinion Bearing	<p>Toyota Land Cruiser PHJ75 3.9 DLX, GX, GX Turbo P/up Perkins236 2H Dies., FJ75 4.0 DLX, GX, VX 3F/F-E Pet., HJ75 - 4X4 (85-92), Stout RK110 2.0 SWB P/up 5R Pet. (79-89)</p>
<b>30309</b>	Rear Wheel Bearing Outer	<p>Mazda E2000, E3000 (76-81), Toyota Dyna 2.2, 2.4, 3.0, 3.7, 3.8, 4.0 (85-01)</p>
<b>32004</b>	Rear Wheel Bearing Outer	<p>Renault R5 1.3, GTL, LS, LSS, TS 810-25, 1.4 TS 847-C2J, 1.3 Panel Van 810-25 (77-85)</p>
<b>32005</b>	Front Wheel Bearing Inner	<p>Renault R5 1.3, GTL, LS, LSS, TS 810-25, 1.4 TS 847-C2J, 1.3 Panel Van 810-25 (77-85)</p>
<b>32006</b>	Diff. Carrier Bearing / Pinion Bearing	<p>Kia Carnival 2.5 K55, KRV6 (00-04), Land Rover Freelander 1.8i S/W Pet., 2.0 Di S/W, Td4 SUV Pet., 2.5 V6 SUV KV6 Pet. (98-04), Toyota Conquest / Tazz AE82R 1.6 GL, RS, RSi 4A-L, A-GEL (85-88), AE92R 160i LS, RS, RSi, Sport, RSE, Tazz 4A-F, A-FE, A-GE (88-01), AE92R 160i Edition, Sport, Tazz, XE 4AFE (01-06), Corolla FWD AE82R 1.6 GL, GLE, GLi, GLS, Avante, GLE, GLi, S/W 4A-L, A-GEL (84-88), EE110R 130 GLE, Sprinter 2E (96-02), AE92R 1.6, 160 GL, GLE, GLi, Exec., GLS, Exec., GLX, Sport Sprinter 4A-F, A-FE, A-GE (88-96), AE93R 180i GL, GLE, GSE, GSX, Sprinter 7A-FE (93-96), AE111R 160i GL, GLE, RSi, RXi 4A-FE, A-GE, AE112 180i GLE, GSE 7A-FE (96-02)</p>

# BUYERS GUIDE - LOOSE BEARINGS

<b>32007</b>	Front Wheel Bearing Outer / Diff. Carrier Bearing	<p>Daewoo Cielo 1.5 GL, GLX, GTX, 150i L, Espero 1.8 CD, C18LE, 2.0 CD, C20LE (96-99), Isuzu KB40 1.6 G161Z, KB41 1.6 G161Z, 1.8 G180Z, KB42 1.8 G180Z, KB43 2.0 G200Z, KB44 2.3 4ZD1, KBD40 KBD41 2.0 P/up C190, KBD42 2.2 P/up C223 - 4X4 (79-89), Opel Ascona 1.3 L 13NV/SC, 1.6 GL 16SH, 1.8 GLS 18L (82-87), Astra F 140i, iS 14NV, 160i, iE, iS, Estate 16NZ (93-99), Astra G 1.6 CS, Classic CD, CDE, Comfort C16SEL, 1.8 Classic CDE, Caravan CD S/W, Elegance, Irmischer X18XE1 (99-06), Corsa B 130, i, Lite, iE, iS, Chill Hatch / Sedan 13NE, 140i, Classic, Active, Lite, Lite+, Comfort, Chill, Sport, S 14NE, Hatch/ Sedan, 160, i, iE, Classic, GSi, i Sport, S Hatch/ Sedan, 16SE, 1.8i GSi Hatch (96-03), Corsa C 140i Classic, Comfort, Chill, Classic Essentia, Hatch Club, Sport, Lite Sport, S14NE, 160i Classic, Classic Elegance, Classic CD, CDE, Sport, 16SE, 1.7TDi Sport, Classic, CDTi Enjoy, Hatch CDTi Elegance, Classic DTi Elegance X17D, 1.8i GSi Hatch, Classic (03-08), Corsa LDV 130i Utility P/up 13NE, 1.4i Utility, S P/up 14NE, 1.6i Utility Sport P/up 16NZ, 1.7D Utility P/up X17D (97-04), Corsa LDV II 1.4i Utility, Club Sport, S P/up 14XE, 1.7DTi Utility Club, Sport P/up, 1.8i Utility Club, Sport P/up (03-10), Corsa P/ Van 1.3i Pronto 13NE, 1.4i Combo P/van (1999-), Kadett D, E 1.2 L 12NS, 1.3 Cub, GL, GLS, LS, Rebel 13NV, 140 CL, Cub 14NE/ NV, 1.6 GL, GLS, GSE, L, Rebel, Cub 16SH/ SE, 160i, GSi Aspen 16SE (80-93), 1.8 GTE 18E, L 18LV, GSi Hatch 18L, GLX 18SV, GSi 18E/ SE (84-93), Kadett E 2.0 GSi 20XE, SGi 20SEH, 200, iS 20SE, Boss 20SEH, CD 20SHE, GSi, Super Boss 20SEH (87-93), Kadett F 140, S 14NE, 160i, iS, GSi, Aspen 16SV/ NZ (9399-), Monza 160 GSi, i Aspen 16SE/ NZ, CLS 16SV, 1.8 CLX, GLE, GLX, Convertible, GLi 18SE/ SV, 2.0 CD, CLi 2.0XE, CLE, GLE 20SE/ V (86-93), Zafira I 1.8i CD, Enjoy, Elegance MPV Z18XE/-1 (01-05), Toyota Corolla FWD AE82R 1.6 GL, GLE, GLi, GLS, GLX, Avante, GLE, GLi, S/W 4A-L, A-GEL (84-88), AE92R 1.6, 160 GL, GLE, GLi, Exec., GLS, Exec., GLX, Sport Sprinter 4A-F, A-FE, A-GE (88-96)</p>
<b>32008</b>	Front Wheel Bearing Inner / Outer / Diff. Carrier Bearing	<p>Ford Courier 2.5TD D/cab, Leisure P/up WL4, 3.0 V6 Std., XLT, D/cab, Leisure, Explorer, Exec. P/up Essex, 3.4 V6 Leisure, P/up Essex. - 4X4 (96-00), Laser 2.0, i RS FE (86-95), Tracer 1.6 Sedan, H/back - Plus, Sport, Tonic B6/F6 (95-02), Meteor 2.0 8/16V GLE, GLi FE (86-95), Ranger 2.5 D/Cab, High Trail, XL, DT XLT High Super Cab, 2.5TD Montana D/Cab WL4, 3.0TDCi, 4.0 Super Cab XLT - 4X4 (00-12), Telstar 2.0 GL, GLE, GLi, Mystique FS/KF, 2.5 V6 Ghia, GLi KL, TX5 2.5 V6 RSi KL (94-99), Isuzu KB40 1.6 G161Z, KB41 1.6 G161Z, 1.8 G180Z, KB42 1.8 G180Z, KB43 2.0 G200Z, KB44 2.3 4ZD1, KBD41 2.0 P/up C190, KBD42 2.2 P/up C223 - 4X4 (79-89), KB220 2.2 LE P/up, KB230 2.3 P/up 4ZD1, KB260 2.6 D/cab, LE, LX, KB320 3.2 V6 Frontier LX - 4X4 (89-04), KB200i 2.0 LX, KB240i 2.4 LX, KB250i 2.5 LX - 4X2, 4X4 (04-09), KB250D 2.5 LE, D/cab P/up 4JA1, KB280DT 2.8 LE, LX, D/cab P/up Turbo 4JB1 - 4X4 (89-04), KB250Dc 2.5, KB300TDi 3.0 LX - 4X2, 4X4 (04-09), KB300TDi 3.0 D-TEQ - 4X2, 4X4 (07-11), Kia Carens 1.8 LS 5 Dr. MPV TBD In-Line (00-03), Pride 1.3i LX 5 Dr. H/back (98-04), Shuma I 1.5i LS 4 Dr. Sedan BFD, 1.8i GS 5 Dr. H/back TBD (98-01), Sportage JA 2.0 SUV 5 Spd. FE Pet. - 4X4 (98-03), Mazda 323 FWD 200e Hatch, Sedan, 200i Hatch 8/16V FE-2000 (89-95), 160, i, S Hatch, Midge, Sedan, Sting F6 (90-95), 200i, e Hatch 8/16V FE 2000 (95-05), 626 1.6 S Sedan, Hatch F6, 1.8 L Sedan, Hatch F8, 2.0 SL, SLE, SLX, 2.0i EG, SLi FE (Rear Drum brakes), 2.0i 16V SLi FE (Rear Disc brakes) (83-93), 626 2.0i 16V Medium High, V6 24V High KF/KS, 2.5i V6 Exec. KL, MX-6 2.5 V6 KL (93-98), Astina 180 Se Hatch Bpi (95-00), B-Series B2600 2.6 V6 LWB D/cab, Magnum, Drifter P/up 4G54 Pet., B3000 3.0 V6 LWB D/cab, Magnum, Drifter, Magnum Drifter P/up Essex Pet. - 4X4 (86-95), B2500 2.5, Td LWB D/Cab, Drifter, SLX P/up WL4 Dies./Turbo Dies., B3400 3.4 V6 LWB Magnum D/cab P/up Essex - 4X4 (96-01), B2600i 2.6i V6 LWB Drifter, D/cab Drifter SLX P/up 4G54 Pet. - 4X4 (00-09), Drifter 2.5Td LWB D/cab, DL, SL, SLE, SLX S/cab, D/cab P/up WL4 Dies./Turbo Dies., 2.6i V6 LWB SL S/cab, SLE, SLX D/cab P/up 4G54 Pet. - 4X4 (02-09), Mercedes-Benz W140 S-Class S320 M104.990, S420 M119.971, S500 M119.980 (93-99), W212 E-Class E200, Cgi, E250, CDi, Cgi, E350, Cdi, E400, E500 (2009-), Nissan Primera 160 Si, SE SR16DE, 200 GSi, Si, STi, Elegance, Luxury SR20DE (98-00), Sentra 1.8i Coupe, Sedan Exec. CA18DE (89-92), Ssangyong Korando 2.3 K230 EL, Open Top S/W, 2.9 K290 EL, TDi, Open Top S/W, 3.2 K320 EL S/W, Musso 2.3 E230 EL S/W, 2.9 602, EL, EX, TDi, Exec., E290 TDi, Exec., 3.2 E320 EL Exec. (95-04), VW Sharan 1.8T MPV AJH, 1.9TDi MPV ASZ, 2.8 MPV AAA (99-08)</p>
<b>32009</b>	Front / Rear Wheel Bearing Inner / Diff. Carrier Bearing	<p>Alfa Romeo 155 2.0 TS AR32301, 2.5 V6 AR67301 (96-99), Isuzu KB220 2.2 LE P/up, KB230 2.3 P/up 4ZD1, KB260 2.6 D/cab, LE, LX, KB320 3.2 V6 Frontier LX - 4X4 (89-04), KB200i 2.0 LX, KB240i 2.4 LX, KB250i 2.5 LX - 4X4 (04-09), KB250D 2.5 LE, D/cab P/up 4JA1, KB280DT 2.8 LE, LX, D/cab P/up Turbo 4JB1 - 4X4 (89-04), KB250Dc 2.5, KB300TDi 3.0 LX - 4X4 (04-09), KB300TDi 3.0 D-TEQ - 4X4 (07-11), Kia Carnival 2.9 CRDi J3 (00-04), K2500i 2.5i D4CB (2013-), K2700i 2.7D Workhorse LWB Dies. "Bakkie" D/S (2004-), Nissan Maxima CA33 &amp; QX Series 3.0 VQ30DE (96-04), Ssangyong Korando 2.3 K230 EL, Open Top S/W, 2.9 K290 EL, TDi, Open Top S/W, 3.2 K320 EL S/W, Musso 2.3 E230 EL S/W, 2.9 602, EL, EX, TDi, Exec., E290 TDi, Exec., 3.2 E320 EL Exec. (95-04)</p>

## BUYERS GUIDE - LOOSE BEARINGS

<b>32010</b>	Diff. Carrier Bearing / Pinion Bearing	Audi A4 2.4 Multitronic, BDV, 3.0 Cabriolet ASN, 8H7, 3.0 TDi 8EC Quattro BKN, 3.0 TDi Quattro Avant Tiptronic, BKN, ASB (02-08), Nissan Primera 160 Si, SE SR16DE, 200 GSi, Si, STi, Elegance, Luxury SR20DE (00-02), Sabre 200 GXi SR20DE (94-02), Toyota Land Cruiser FJ80 4.0 DLX, GX, VX P/up 3F/F-E Pet. - 4X4 (90-92), FZJ80 4.5 Std., GX, VX, Turbo S/W, P/up 1FZ-FE Dies., Turbo Dies. (92-95), FZJ105 4.5 V8 VX, Turbo P/up, S/W 2UZ-FE Pet. - 4X4 (98-06), HDJ/HZJ80 4.2 GX, Turbo S/W, P/up 1HD-FT, 1HZ Dies., T. Dies. - 4X4 (90-95), VW Kombi T5 1.9TDi Beach, Van, P/van, S/Cab P/up SWB, D/Cab P/up LWB, Crew Bus AXC Dies., 2.5TDi Beach, California, Caravelle, 96/128, S/Cab, D/cab, HO P/up SWB/ LWB P/up, Crew Bus P/van, Van, AXD Dies., 3.2 Caravelle, S/Cab, D/cab P/up BDL (04-10), Passat IV 2.8, 4 Motion, Quattro, Tiptronic ACK/ AMX, 3.2 V6 Sportline DSG AXZ (99-05), 1.9TDi Comfortline AVB, 2.0FSI Comfortline, Tipt., Highline BCR BLY, 2.0 T FSI Sportline Tiptronic AXX/BPY, 2.0TDi Highline, DSG BKP/BMP, 3.2 V6 Auto. DSG (05-11)
<b>32011</b>	Diff. Carrier Bearing, Rear Wheel Bearing Outer	Iveco Turbo Daily 35/10, 35/12 2.3i P/van, Bus (2006-), Mercedes-Benz E430, 00-06 Sprinter 2.2 (98-02), Mitsubishi Colt LDV 2.8D - 4X4 (99-09), Nissan Caball 2.0, 3.0 (66-84)
<b>32012</b>	Diff. Carrier Bearing / Pinion Bearing	Isuzu KB260 2.6 LE, D/cab, LX P/up 4ZE1, KB320 3.2 LE, D/cab, LX, Frontier, Reef, Blazer P/up 6VD1 (92-04), KB250D 2.5 Fleetside, LE, D/Cab P/up 4JA1, KB280DT 2.8 D/cab LE, LX, Frontier P/up Turbo 4JB1 (89-04), WFR 1.8 11FVX/ 12FVX Bus, P/van 4ZB1 (83-89)
<b>32013</b>	Diff. Carrier Bearing	Nissan Sentra 1.6 (87-92)
<b>32205</b>	Diff. Pinion Bearing Front	Kia K2500i 2.5i D4CB (2013-)
<b>32206</b>	Front / Rear Wheel Bearing Outer / Diff. Pinion Bearing	Ford Courier 2.5TD D/cab, Leisure P/up WL4 - 4X4 (96-00), 3.4 V6 Leisure, P/up Essex. - 4X4 (97-00), Ranger 2.5 D/Cab, High Trail, XL, DT XLT High Super Cab, 2.5TD Montana D/Cab WL4, 3.0TDCi, 4.0 Super Cab XLT - 4X4 (00-12), Isuzu KB20 1.6 P/up G161Z Pet., KB21 1.6 P/up G161Z Pet., KB22 1.8 P/up G180Z Pet., KBD20 2.0 P/up C190, KBD21 2.0 P/up C190, KBD22 2.2 LE, P/up C223, KB23 2.0 P/up G200Z, KB24 2.3 LE 4ZD1, KB25 1.6 P/up G161Z, KB26 1.6 P/up G161Z, 1.8 P/up G180Z, KBD23 2.5 LE, P/up 4JA1, KBD25 2.0 P/up C190 (79-89), KBD26 2.0 P/up C190, KBD27 2.2 C223, KBD28 2.5 4JA1 (81-89), KB27 1.8 P/up G180Z, KB28 2.0 P/up G200Z, KB29 2.3 P/up 4ZD1 (83-89), Kia Sportage JA 2.0 SUV 5 Spd. FE Pet. - 4X4 (98-03), Land Rover Freelander 1.8i S/W Pet., 2.0 Di S/W, Td4 SUV Pet., 2.5 V6 SUV KV6 Pet. (98-04), Mazda B-Series B2600 2.6 V6 LWB D/cab, Magnum, Drifter P/up 4G54 Pet., B3000 3.0 V6 LWB D/cab, Magnum, Drifter, Magnum Drifter P/up Essex Pet. - 4X4 (86-97), B2500 2.5, Td LWB D/Cab, Drifter, SLX P/up WL4 Dies./ Turbo Dies. - 4X4 (96-99), B3400 3.4 V6 LWB Magnum D/cab P/up Essex - 4X4 (96-01), B2600i 2.6i V6 LWB Drifter, D/cab Drifter SLX P/up 4G54 Pet. - 4X4 (00-09), Drifter 2.5Td LWB D/cab, DL, SL, SLE, SLX S/cab, D/cab P/up WL4 Dies./Turbo Dies., 2.6i V6 LWB SL S/cab, SLE, SLX D/cab P/up 4G54 Pet. - 4X4 (02-09), Nissan Stanza 1.6 DL, Resort, S/W L16, 1.8 GL, Resort, S/W SSS L18 (80-84), Peugeot Boxer 2.5TD 1.8 Ton Delivery Van DJ5TED (98-01)
<b>32207</b>	Diff. Pinion Bearing	Ford Courier 3.0 V6 Std., XLT, D/cab, Leisure, Explorer, Exec. P/up Essex - 4X4 (97-00), Kia Sportage JA 2.0 SUV 5 Spd. FE Pet. - 4X4 (98-03), Land Rover Freelander 1.8i S/W Pet., 2.0 Di S/W, Td4 SUV Pet., 2.5 V6 SUV KV6 Pet. (98-04), Mazda B-Series B2600 2.6 V6 LWB D/cab, Magnum, Drifter P/up 4G54 Pet., B3000 3.0 V6 LWB D/cab, Magnum, Drifter, Magnum Drifter P/up Essex Pet. - 4X4 (86-97)
<b>32208</b>	Front Wheel Bearing Outer	Ssangyong Korando 2.3 K230 EL, Open Top S/W, 2.9 K290 EL, TDi, Open Top S/W, 3.2 K320 EL S/W, Musso 2.3 E230 EL S/W, 2.9 602, EL, EX, TDi, Exec., E290 TDi, Exec., 3.2 E320 EL Exec. (95-04)
<b>32209</b>	Front Wheel Bearing Inner	Ssangyong Korando 2.3 K230 EL, Open Top S/W, 2.9 K290 EL, TDi, Open Top S/W, 3.2 K320 EL S/W, Musso 2.3 E230 EL S/W, 2.9 602, EL, EX, TDi, Exec., E290 TDi, Exec., 3.2 E320 EL Exec. (95-04)
<b>32210</b>	Rear Wheel Bearing Inner	Mercedes-Benz BM903/4 Sprinter 308D 2.2 OM 601 LA Dies., 312D 2.2 OM602 LA Dies., 313 2.2 LWB, SWB Bus, P/van OM611 LA Pet., 412D 2.8 OM612, 413CDi 2.2, 416CDi 2.2 (96-06)
<b>32211</b>	Diff. Carrier Bearing	Nissan Caball 2.0 (66-84), Safari 2.8 - 4X4 (84-90)
<b>32212</b>	Diff. Carrier Bearing	Nissan Caball 3.0 (78-84)
<b>32304</b>	Front Wheel Bearing Outer	Isuzu KB20 1.6 P/up G161Z Pet., KB21 1.6 P/up G161Z Pet., KB22 1.8 P/up G180Z Pet., KBD20 2.0 P/up C190, KBD21 2.0 P/up C190, KBD22 2.2 LE, P/up C223, KB23 2.0 P/up G200Z, KB24 2.3 LE 4ZD1, KB25 1.6 P/up G161Z, KB26 1.6 P/up G161Z, 1.8 P/up G180Z, KBD23 2.5 LE, P/up 4JA1, KBD25 2.0 P/up C190 (78-89), KBD26 2.0 P/up C190, KBD27 2.2 C223, KBD28 2.5 4JA (81-89), KB27 1.8 P/up G180Z, KB28 2.0 P/up G200Z, KB29 2.3 P/up 4ZD1 (83-89)



## BUYERS GUIDE - LOOSE BEARINGS

<b>32305</b>	Diff. Pinion Bearing	Nissan 1-Tonner/Hardbody AW/D21 2.7 TD27, 3.0 VG30E - 4X4 (90-99), 720 D20 1.8 L18S, 2.0 NA20, 2.2 Z22 - 4X4 (80-88), B140 1.4 A14SP/van, S/W, Deluxe, Std. Sport, Champ P/up (93-08), Hardbody QW/D22 2.4i KA24E, 2.7 TD27, 3.0 VG30E, 3.0TD ZD30, 3.2, 3.2D QD32, 3.3i VG33 - 4X4 (98-10), NP300 D22 2.4i, S/C, D/C, Highrider KA24 DE, 2.5TDi, S, SE, Highrider YD25 - 4X4 (2008-), Laurel C31 2.0 CA/L20, 2.8 SGL 5L28 (80-87), Patrol Y60 3.0 VG30E - 4X4 (95-00), Y61 3.0Di, 4.2 TD42 - 4X4 (99-04), Sani AW/D21 2.2 Z22, 2.4 Z24, 2.7 TD27, 3.0 VG30E - 4X4 (86-98), Skyline R30 1.8 L18 (82-87), R30 2.8 GLX, GTX L28/2 (83-86), R31 2.0 SGLi, SGLi RB20E, 3.0 SGLi RB30E With I.R.S. (87-92), Terrano II 2.7 TD27 - 4X4 (00-02)
<b>32306</b>	Diff. Pinion Bearing	Nissan 1-Tonner/Hardbody AW/D21 2.4 Z24S - 4X4 (88-98), B140 1.4 A14SP/van, S/W, Deluxe, Std. Sport, Champ P/up (93-08), E20 1.8 L18 Bus, P/van Coach, Coach GL, GLE, Econolux, Ekonovan, Ekonowagon, 2.0 Bus, Van H20 (80-96), Hardbody QW/D22 2.4i KA24E, 2.7 TD27, 3.0 VG30E, 3.0TD ZD30, 3.2, 3.2D QD32, 3.3i VG33 - 4X4 (98-10), NP300 D22 2.4i, S/C, D/C Highrider KA24 DE, 2.5TDi, S, SE Highrider YD25, 2.5TDi, S, SE YD25 (2008-), NP300 D22 2.4i, S/C, D/C, Highrider KA24 DE, 2.5TDi, S, SE, Highrider YD25 - 4X4 (2008-), NV350 2.5 QR25DE, 2.5D YD25DDTi (2013-), Patrol Y61 3.0Di, 4.2 TD42 - 4X4 (99-04), Sani AW/D21 2.2 Z22, 2.4 Z24, 2.7 TD27, 3.0 VG30E - 4X4 (86-98), Skyline R30 1.8 L18 (82-87), Terrano II 2.7 TD27 - 4X4 (00-02)
<b>32307</b>	Diff. Pinion Bearing	Ford Courier 2.5TD D/cab, Leisure P/up WL4, 3.4 V6 Leisure, P/up Essex. - 4X4 (96-00), Ranger 2.5 D/Cab, High Trail, XL, DT XLT High Super Cab, 2.5TD Montana D/Cab WL4, 3.0TDCi, 4.0 Super Cab XLT - 4X4 (00-12), Isuzu KB20 1.6 P/up G161Z Pet., KB21 1.6 P/up G161Z Pet., KB22 1.8 P/up G180Z Pet., KBD20 2.0 P/up C190, KBD21 2.0 P/up C190, KBD22 2.2 LE, P/up C223, KB23 2.0 P/up G200Z, KB24 2.3 LE 4ZD1, KB25 1.6 P/up G161Z, KB26 1.6 P/up G161Z, 1.8 P/up G180Z, KBD23 2.5 LE, P/up 4JA1, KBD25 2.0 P/up C190 (79-89), KBD26 2.0 P/up C190, KBD27 2.2 C223, KBD28 2.5 4JA1 (81-89), KB27 1.8 P/up G180Z, KB28 2.0 P/up G200Z, KB29 2.3 P/up 4ZD1 (83-89), KB40 1.6 G161Z, KB41 1.6 G161Z, 1.8 G180Z, KB42 1.8 G180Z, KB43 2.0 G200Z, KB44 2.3 4ZD1, KBD40 KBD41 2.0 P/up C190, KBD42 2.2 P/up C223 - 4X4 (79-89), KB220 2.2 LE P/up, KB230 2.3 P/up 4ZD1, KB260 2.6 D/cab, LE, LX, KB320 3.2 V6 Frontier LX, KB250D 2.5 LE, D/cab P/up 4JA1, KB280DT 2.8 LE, LX, D/cab P/up Turbo 4JB1 - 4X4 (89-04), Relay 2.0 P/van, Bus 4ZC1 (89-95), Mazda B-Series B2500 2.5, Td LWB D/Cab, Drifter, SLX P/up WL4 Dies./Turbo Dies., B3400 3.4 V6 LWB Magnum D/cab P/up Essex - 4X4 (96-01), B2600i 2.6i V6 LWB Drifter, D/cab Drifter SLX P/up 4G54 Pet. - 4X4 (00-09), Drifter 2.5Td LWB D/cab, DL, SL, SLE, SLX S/cab, D/cab P/up WL4 Dies./Turbo Dies., 2.6i V6 LWB SL S/cab, SLE, SLX D/cab P/up 4G54 Pet. - 4X4 (02-09), Nissan 1-Tonner/Hardbody AW/D21 2.7 TD27, 3.0 VG30E - 4X4 (90-99), 720 D20 1.8 L18S Kingcab, Sport, 2.2D SD/Z22 Tracker, 2.3 SD23 - 4X2, 1.8 L18S, 2.0 NA20, 2.2 Z22 - 4X4 (80-88), E20 1.8 L18 Bus, P/van Coach, Coach GL, GLE, Econolux, Ekonovan, Ekonowagon, 2.0 Bus, Van H20 (80-96), Hardbody QW/D22 2.4i KA24E, 2.7 TD27, 3.0 VG30E, 3.0TD ZD30, 3.2, 3.2D QD32, 3.3i VG33 - 4X4 (98-10), NP300 D22 2.4i, S/C, D/C Highrider KA24 DE, 2.5TDi, S, SE Highrider YD25, 2.5TDi, S, SE YD25 - 4X2, 2.4i, S/C, D/C, Highrider KA24 DE, 2.5TDi, S, SE, Highrider YD25 - 4X4 (2008-), Laurel C31 2.0 CA/L20, 2.8 SGL 5L28 (80-87), NV350 2.5 QR25DE, 2.5D YD25DDTi (2013-), Patrol Y60 3.0 VG30E - 4X4 (95-00), Y61 3.0Di, 4.2 TD42 - 4X4 (99-04), Sani AW/D21 2.2 Z22, 2.4 Z24, 2.7 TD27, 3.0 VG30E - 4X4 (86-98), Skyline R30 2.0 GL L20 (82-87), R31 2.0 GL, GLE CA20 (87-92), R30 2.8 GLX, GTX L28/2 (83-86), R31 3.0 SGLi RB30E With I.R.S. (87-92), Terrano II 2.7 TD27 - 4X4 (00-02), Toyota Condor 2.4i Estate, TX Estate 2RZ-E, 3.0 Estate, TX Estate 5L - 4X4 (00-05), Corolla TE71 1.6 P/van 2T (83-89), KE70 1.3 P/van 4K (84-88), Cressida GX60 2.0 GLi6 1G-E, GX7 2.0 GLi6 1G-E, 1G-FE (83-89), MX63 2.8i 5M-E, MX73 2.8i RSi, RSi Exec. 5M-GE (84-89), Hiace YH51/61 2.0 SWB/LWB 16 Seater Commuter, Super 10 Seater Custom Wagon, P/van 3Y Pet. (83-86), Hilux LN30/40/50/51/55 2.2 SWB/LWB P/up L Dies., 2.4 SWB/LWB D/cab, Raider P/up 2L Dies., YN58 2.2 LWB D/cab, Raider, SRX P/up 4Y Pet. (79-89), YN67 2.2 LWB D/cab, Raider D/cab P/up 4Y Pet. - 4X4 (86-94), YN51/56 1.8 SWB/LWB D/cab, S, SR, Raider P/up 2Y Pet., YN140 1.8 SWB/LWB D/cab, Raider, S, SRX P/up 2Y Pet. (86-05), LN65 2.4 LWB D/cab, Raider D/cab P/up 2L Dies. - 4X4 (89-98), LN67 2.8D LWB, D/cab, Raider D/cab P/up 3L Dies. (95-98), RZN169 2.7i LWB D/cab, DLX S/cab, Raider S/D/cab, SRX D/cab, Legend 35 LWB P/up 3RZFE Pet., LN167 3.0D D/cab D-E, DLX, S/D/cab DE, Raider DE, Legend35 LWB P/up 5L Dies., 3.0iD LWB Raider S/cab & KZ-TE D/cab P/up, Legend35 - 4X4 (98-05), Tuv KF20 1.3 Chassis Cab, P/up, P/van, Bus 4K Pet., 1.5 P/up 5K Pet. (82-87)
<b>32308</b>	Diff. Pinion Bearing Front	Nissan Hardbody 3.0, D, 99-04 Patrol 3.0 (1998-)

## BUYERS GUIDE - LOOSE BEARINGS

<b>32915</b>	Diff. Carrier Bearing	Toyota Condor 2.4i Estate, TX Estate 2RZ-E, 3.0 Estate, TX Estate 5L - 4X4 (00-05), Fortuner 3.0 D-4D SUV 1KD-FTV, 4.0 V6, Epic SUV 1GR-FE - 4X4 (06-11), 2.5D-4D 2KD-FTV, 3.0D-4D 1KD-FTV - 4X2, 4X4, 4.0 V6 1GR-FE, 4.0 V6 Raised Body 1GR-FE - 4X2 (11-16), Hilux RN67 2.4 LWB D/cab, Raider D/cab P/up 22R Pet. - 4X4 (94-98), RZN169 2.7i LWB D/cab, DLX S/cab, Raider S/D/cab, SRX D/cab, Legend 35 LWB P/up 3RZFE Pet., LN167 3.0D D/cab D-E, DLX, S/D/cab DE, Raider DE, Legend35 LWB P/up 5L Dies., 3.0iD LWB Raider S/cab & KZ-TE D/cab P/up, Legend35 - 4X4 (98-05), Hilux "VIGO" 3.0 D-4D TDi D/C Raider 1KD-FTV Dies., LWB P/up, 4.0 D/Cab Raider 1GR-FE Pet. LWB P/up - 4X4 (05-09), 2.5TDi D-4D S/Cab, D/Cab SRX, Legend40 2KD-FTV Dies. LWB P/up, 2.7i S/Cab SRX, Legend40 2TR-FE Pet. LWB P/up - 4X4 (05-15), 3.0D-4D TDi D/C xtra cab, Raider, Legend40 1KD-FTV Dies. LWB, 4.0 D/Cab Raider, 1GR-FE Pet. - 4X4 (2009-), Hilux 2.0 VVTi 1TR-FE 5 Spd Man. S/cab, 2.5D-4D Raised Body 2KD-FTV 5 Spd Man., 2.5D-4D Std. Body 2KD-FTV 5 Spd Man., 3.0D-4D 1KD-FTV, 4.0 1GR-FE - 4X2, 2.5D-4D Raised Body 2KD-FTV 5 Spd man., 3.0D-4D 1KD-FTV, 4.0 1GR-FE - 4X4 (11-16), Land Cruiser FJ80 4.0 DLX, GX, VX P/up 3F/F-E Pet. - 4X4 (90-92), FZJ80 4.5 Std., GX, VX, Turbo S/W, P/up 1FZ-FE Dies., Turbo Dies. - 4X4 (95-06), HDJ/HZJ80 4.2 GX, Turbo S/W, P/up 1HD-FT, 1HZ Dies., T. Dies. - 4X4 (90-95), HDJ/HZJ80 4.2 Std., GX, VX, Turbo S/W, P/up 1HD-FT, 1HZ Dies., Turbo Dies. - 4X4 (95-01), HDJ100 4.2 Std., GX, VX S/W, 1HZ Pet., 4.5, 4.7 V8 - 4X4 (97-04), HDJ200 4.5 D-4D, 4.6 V8, 4.7 V8 - 4X4 (2007-), UZJ100 4.5 V8 Std., GX, VX S/W, P/up 2UZ-FE Pet. - 4X4 (98-06)
<b>33205</b>	Front Wheel Bearing Outer	Mercedes-Benz S320, S420, S500 (93-99), Sprinter 2.2 (96-06)
<b>38003</b>	Front Wheel Bearing Inner	Nissan Sabre 160 GX, GXi GA16DS, 200 GXi SR20DE (94-02), Sentra 140, i, GX, GXi, Si GA14DNE / DS, 160 GSi, GX, GXi, SE, Si GA16DE/DNE/ DS, 200 GSi, STi SR20DE (92-02), Toyota Conquest / Tazz EE80 1.3 GL, GS, L, S 2EL (85-88), AE82R 1.6 GL, RS, RSi 4A-L, A-GEL (85-88), Corolla FWD AE82R 1.6 GL, GLE, GLi, GLS, GLX, Avante, GLE, GLi, S/W 4A-L, A-GEL (84-88), AE/EE80R 1.3 GL, L, 2A-L, E-L (85-88)
<b>40246</b>	Front & Rear Wheel Bearing Inner	Land Rover Freelander 1.8i, 2.0, 2.5 – Non ABS (98-04)
<b>40547</b>	Front Wheel Bearing Inner	Citroen C2 1.4, 1.6i (2003-), C3 1.4i, 1.6i (2002-), Peugeot 206 1.4, 1.6 (01-06)
<b>40574</b>	Front Wheel Bearing Inner	Citroen Xsara 2.0 (01-06), Xsara Picasso 1.6, 1.8, 2.0 (01-06), Berlingo 1.4i, 1.9D (03-06), Peugeot 206 2.0 (00-06), 306 1.6, 2.0 (95-03), 405 1.8, 2.0 (95-97), 406 2.0, 3.0 (96-04)
<b>102429</b>	Front Wheel Bearing Inner	Ford Mondeo 1.8Tdi, 1.8i, 2.0, 2.0i, 2.5i (97-01)
<b>305988</b>	Front Wheel Bearing Inner	VW Kombi 2.1 Fi - 4X4 (89-93)
<b>309245</b>	Front / Rear Wheel Bearing Inner	Audi 100/4 1.6 LS YV, 100/5 1.9 WH, 200 2.1 GLS, GLX, 400 1.8 JW, 500 2.1/2.2 WB, WC SE PR (77-92), BMW 1 Series E87 116i 1.6 N45, 120i 2.0 N46, 120d 2.0 N47, 130i 3.0 N52 (04-15), F20/1 116i 1.6 N13, 118i 2.0 N13, 120d 2.0 N47, 125i 2.0 N20 (11-16), 3 Series E30 316 1.8 M10, 316i 1.6 M40, 318i 1.8 M40, 320i M20/50, 323i M50, 325i M52, 333i M30 (83-92), E36 316i 1.8 Dolphin Shape M40, 318i 1.9 M44, 320i 2.0 M50, 323i 2.5 M52, 325i M50, 328i 2.8, 3.0 M52, Z3 2.8, 3.0 Roadster (92-00), E37 M3 M Coupe S50 (93-01), E46 316i 1.8 M40, 318i M43, 320i, d M54/47, 323i M52, 325i, it M50, 328i M52TU (98-05), E90 320d 2.0 Sedan & Touring, Start M47, 320i 2.0 Sedan & Touring, Start N46, 323i 2.5 Sedan & Touring, Start N52, 325i 2.5 Sedan & Touring, Start N52 (05-13)
<b>309396</b>	Front Wheel Bearing Inner	Chery QQ3 0.8 TE, TX, 1.1 TXE (2008-), Mazda 626 1.6 S Sedan, Hatch F6, 1.8 L Sedan, Hatch F8, 2.0 SL, SLE, SLX, 2.0i EG, SLi FE (Rear Drum brakes), 2.0i 16V SLi FE (Rear Disc brakes) (83-93), VW Passat I & II 1.3 L, LS H/back, Sedan, Variant ZF, 1.5 GL, LS Fastback, S/W CK, 1.6 GL, GLS, LS, LX Fastback, S/W, Sedan, Coupe, Variant, YN/YP/WN, 1.8 CL Sedan, S/W JV/KR (74-87), Passat I & II 1.9 GLS H/back, GLX Sedan, S/W WN, 2.2 CLi, CLX SG/MX (81-87)
<b>309609</b>	Rear Wheel Bearing Inner	BMW 520i, 525e, 525i, 528i, 530i, 535i, 540i, 80-89 635CSi (85-96), 728i, 730i, 733i, 735i, 740i, 745i, 750i (83-96), M5 (86-94)

## BUYERS GUIDE - LOOSE BEARINGS

<b>309639</b>	Front / Rear Wheel Bearing Inner	<p>BMW 3 Series E30 316 1.8 M10, 316i 1.6 M40, 318i 1.8 M40, 320i M20/50, 323i M50, 325i M52, 333i M30 (83-92), E36 316i 1.8 Dolphin Shape M40, 318i 1.9 M44, 320i 2.0 M50, 323i 2.5 M52, 325i M50, 328i 2.8, 3.0 M52, Z3 2.8, 3.0 Roadster (92-00), Chevrolet Aveo 1.5 L, LS, LT, 1.6 LS (03-15), Daewoo Espero 1.8 CD, C18LE, 2.0 CD, C20LE (96-99), Lanos I 1.35i S, 1.6 SX (97-03), Nubira I 1.6 SX, 2.0 CDX, Nubira II 1.6 SX, SX S/W, 2.0 CDX, Exec., S/W (97-03), Ford "Boet" Bantam Rocam 1.3i XL, XLT, 1.4i TDCi, 1.6i XL, XLT, XLE, 1.8D XL (02-12), Escort FWD MkVI 1.4i H/back, Sedan CVH-PTE, 1.6i GL, GLE H/back, Sedan Zetec, 1.8i GLi, TDi H/back, Sedan Zetec, 1.8TDi Endura (95-00), Fiesta I 1.3, i Flair, Flite, Play, Fun Endura-EM5, 1.4, i Flair, Trend, Fun Zetec CVH/PTE, 1.6, i Ambiente', Flair, Forte' Ghia, Rsi, Sport, Trend (97-04), Fiesta II 1.4i Trend Zetec, 1.6i RSi, TDCi Rocam, 2.0 ST, ST150 (04-09), Ikon 1.3, Low, LX CLTA, 1.6i, Low, High, LX, CLX CLTA (01-06), 1.4, Low, LX, 1.4 Tdci, 1.6i (07-11), Ka 1.3i Ambiente, Trend, Collection Rocam A9A, A9B (05-09), Mazda 121 Soho 1.3, i 3/5 Dr. H/back Endura-EM5, 1.4i 3/5 Dr. H/back Zetec CVH/PTE (97-99), Opel Ascona 1.6 GL 16SH, 1.8 GLS 18L (82-87), Astra F 180i, iE 18SE/ XE, XL, 200i, e, ts 20SE/ XE (93-99), Corsa B 130, i, Lite, iE, iS, Chill Hatch / Sedan 13NE, 140i, Classic, Active, Lite, Lite+, Comfort, Chill, Sport, S 14NE, Hatch/ Sedan, 160, i, iE, Classic, GSi, i Sport, S Hatch/ Sedan, 16SE, 1.8i GSi Hatch (96-03), Kadett D, E 1.2 L 12NS, 1.3 Cub, GL, GLS, LS, Rebel 13NV, 140 CL, Cub 14NE/ NV, 1.6 GL, GLS, GSE, L, Rebel, Cub 16SH/ SE, 160i, GSi Aspen 16SE (80-93), 1.8 GTE 18E, L 18LV, GSi Hatch 18L, GLX 18SV, GSi 18E/ SE (84-93), Kadett E 2.0 GSi 20XE, SGI 20SEH, 200, iS 20SE, Boss 20SEH, CD 20SHE, GSi, Super Boss 20SEH (87-93), Kadett F 180i, iE, GSi 18SE (93-99), Monza 1.8 CLX, GLE, GLX, Convertible, GLi 18SE/ SV, 2.0 CD, CLi 2.0XE, CLE, GLE 20SE/ V (86-93), Tata Indica / Vista 1.4 LEi, LSi, LX, Lxi, 1.4TDi DLX, DLS, Indigo 1.4 GLS S/W, 1.4TDi DLX S/W (2005-)</p>
<b>309726</b>	Front Wheel Bearing Inner	<p>Chevrolet Aveo 1.5 L, LS, LT, 1.6 LS (03-15), Spark 1.0 B110S1, 1.2 B12D1 (2010-), Daewoo Cielo 1.5 GL, GLX, GTX, 150i L (96-99), Lanos II 1.4 S, 1.6 SX (97-03), Opel Ascona 1.3 L 13NV/SC (82-87), Kadett D, E 1.2 L 12NS, 1.3 Cub, GL, GLS, LS, Rebel 13NV, 140 CL, Cub 14NE/ NV, 1.6 GL, GLS, GSE, L, Rebel, Cub 16SH/ SE, 160i, GSi Aspen 16SE (80-93), Monza 160 GSi, i Aspen 16SE/ NZ, CLS 16SV (86-93), VW Caddy 1.6 SWB, Caddy Club P/up JK Dies., HM Pet., 1.8 SWB L, Sport P/up HV Pet. (81-97), Citi Golf 1.3 L ET/GY, 1.6 Blues, Chico, Chico Lux, Deco, Designa, L, Ritz, Shuttle, Sonic, Sport HM, HV, FR, 1.6iL, Life, VeloCiti, TenaCiti, CitiStorm, - Sport, - Rox, Rhythm, MKI AFX, 1.8 CTi, Designa, L Sport BZF (83-09), Citi Golf 1.3 L Shuttle, Chico, Chico Lux ET/ GY/ AJD (87-03), 1.4, iL, Chico, Rhythm, Citi com, VeloCiti, TenaCiti, CitiStorm, - Sport, Rox, Rhythm, Wolf, - XCite, Billabong AGY/ BSV (99-09), Fox 1.3 L, L Trippa GY, 1.6 L HM, 1.8 L Sport HV (87-96), Golf I 1.1 GL, L, LS ET/EG, 1.3 GL, L, LS GF, 1.5 GL Diesel, GLS, LS CK/ EM/ JB, 1.6 GL Diesel, GT, GTS, GTX JK/ CR FR, 1.8 GTi EV (78-84), Jetta I 1.3 GL, GX ET/ GF, 1.5 GLS/ GLX JB, 1.6 GLS EM, 1.8 GLi DX (80-85)</p>
<b>309797</b>	Front / Rear Wheel Bearing Inner	<p>Mercedes-Benz W124 200E M102.922, 220E M111.960, 230E M102.982, 260E M103.940, 280E M104.942, 300D M103.985, M606.910, 320 Sportline M104.922 (86-96), W124 E Class E200 M102.922, E220 M111.960, E320 Sportline, M104.992 (93-96), R170 SLK200, SLK320 M112.947 (97-02), R170 SLK200K M111.958, SLK320, SLK32 AMG M112.960 (02-04), R171 SLK200K M271.954/958, SLK350 M272.963/ 969, SLK55 AMG M113.989 (04-11), R172 SLK250, SLK350 M276.956, SLK55 AMG M152.980 (2011-), W201 190E 1.8 M102.920, 2.0 M102.922, 2.3 Sportline M102.983 (93-94), W202/3 C-Class C180 Classic M111.920, C200 M111.941, C220 M111.961, C230 M111.974, C240 M111.944, C250 M605.910, C270CDi M612.962, C280 M104.941 (94-08), W208 CLK230, M111.973, CLK320, M112.940, CLK430, CLK500 (98-03), W210/211 E-Class E200, K M111.941/956, E230 M111.970, E240 M112.911, E280 M112.921, E320 M112.941, E320CDi OM646.961, E350 M272.964, E500 M113.967 (96-10), Vito / Viano W638 113CDi, 115CDi, 116CDi, 120CDi, 122CDi (03-06), Peugeot 605 3.0 V6 SRI ZPJ/LZ (96-98), Volvo 960 2.9 Sedan B6304 (94-97), C70 2.3 Cabrio, Coupe B5234 T3/ T9 (99-06), S70 2.3 T5 Cabrio, Coupe B5434T4, 2.4 Cabrio, Coupe B5254S, V70 2.3 T5 Estate B5434T4, 2.4, T Estate B5254S, 2.5T Estate (97-04), S90 2.9 X44 B6304S, V90 2.9 X44 B6304S (97-00), V70 2.4 XC Estate B5254S, XC70 2.5T Estate, XC90 2.9 T6 5/ 7 Seater Estate B6304 - 4X4 (00-06)</p>
<b>309946</b>	Rear Wheel Bearing Inner	<p>BMW 520i, 525e, 525i, 528i, 530i, 535i, 540i (85-96), 635CSi (80-89), M5 (86-89)</p>
<b>309971</b>	Front Wheel Bearing Inner	<p>BMW 3 Series E30 316 1.8 M10, 316i 1.6 M40, 318i 1.8 M40, 320i M20/50, 323i M50, 325i M52, 333i M30 (83-92)</p>
<b>309981</b>	Front Wheel Bearing Inner	<p>BMW 3 Series E30 316 1.8 M10, 316i 1.6 M40, 318i 1.8 M40, 320i M20/50, 323i M50, 325i M52, 333i M30 (83-92)</p>
<b>311309</b>	Front Wheel Bearing Inner	<p>VW Golf II 1.3 CL GY, 1.6 CSL HM, 1.8 8/16V CSX, GTS, GTi KR, EV, 2.0 8/16V GTi AAL (84-92), Jetta II 1.6 CSL HM, 1.8 8/16V CLi, CLi Exec., CLX, CSi, CSX EV/KR, 2.0 8/16V CLi, Exec. AAL (85-92)</p>



## BUYERS GUIDE - LOOSE BEARINGS

<b>311316</b>	Front Wheel Bearing Inner	VW Caddy 1.6i Club, Citi, P/up HM Pet. (97-03), Polo 6N 1.4 Classic, Playa Lux AEX, 1.6 Classic, Playa, Lux AEE (96-03)
<b>311443</b>	Front Wheel Bearing Inner	VW Golf II 1.3 CL GY, 1.6 CSL HM, 1.8 8/16V CSX, GTS, GTi KR, EV, 2.0 8/16V GTi AAL (89-92), Golf III 1.6 GS ACG, 1.8 GSX, GTS ACH, 2.0 GTi, Exec. 2E, 2.8 VR6, Exec. AAA (92-99), Jetta II 1.6 CSL HM, 1.8 8/16V CLi, CLi Exec., CLX, CSi, CSX EV/KR, 2.0 8/16V CLi, Exec. AAL (85-92), Jetta III 1.6 CSL ACG, 1.8 CLX/ CSX ACH, 2.0 CLi, Exec. 2E, 2.8 VR6 Exec. AAA (92-99), Polo 6N 1.8 Classic, Playa, Lux ADZ (96-03)
<b>328053</b>	Rear Wheel Bearing Inner / Outer	Ford Sapphire 1.6 L Kent, 2.0, i GL, GLE, GLEA, GLi, GLi Exec. Koln, 3.0 Ghia, GLX Essex, Sierra 2.0 LX Koln, 3.0, i GLS, GLX, LX, RS, XR6 Essex (83-93)
<b>329013</b>	Rear Wheel Bearing Inner / Outer	Ford "Boet" Bantam Rocam 1.3i XL, XLT, 1.4i TDCi, 1.6i XL, XLT, XLE, 1.8D XL (02-12), Escort FWD MkVI 1.4i H/back, Sedan CVH/PTE, 1.6i GL, GLE H/back, Sedan Zetec, 1.8i GLi, TDi H/back, Sedan Zetec, 1.8TDi Endura (95-00), Fiesta I 1.3, i Flair, Flite, Play, Fun Endura-EM5, 1.4, i Flair, Trend, Fun Zetec CVH/PTE, 1.6, i Ambiente', Flair, Forte' Ghia, Rsi, Sport, Trend (97-04), Ikon 1.3, Low, LX CLTA, 1.6i, Low, High, LX, CLX CLTA (01-06), Ka 1.3i Ambiente, Trend, Collection Rocam A9A, A9B (05-09), Mazda 121 Soho 1.3, i 3/5 Dr., H/back Endura-EM5, 1.4i 3/5 Dr. H/back Zetec CVH/PTE (97-99)
<b>329129</b>	Rear Wheel Bearing Inner	Mercedes-Benz Sprinter 2.2 (96-06)
<b>330757</b>	Rear Wheel Bearing Inner, Diff. Carrier/Pinion Bearing	VW 411 1.7 (69-74), 412 1.7 (72-74), Citi Golf 1.3, 1.4, i, 1.6, i, 1.8 (83-09), Fox 1.6, 1.8 (87-95), Golf I 1.1, 1.3, 1.5, 1.6, 1.8 (78-85), Golf II 1.3, 1.6, 1.8, 2.0 (84-92), Jetta I 1.3, 1.5, 1.6, 1.8 (80-85), Jetta II 1.6, 1.8 (85-93), Caddy 1.6, 1.8 (81-96)
<b>331274</b>	Front / Rear Wheel Bearing Inner / Diff Pinion Bearing	Audi 100/4 1.6 LS YV, 100/5 1.9 WH, 200 2.1 GLS, GLX, 400 1.8 JW, 500 2.1/2.2 WB, WC SE PR (77-92), 500 2.2 E PR, 2.3 E, SE, AAR, 2.8 SEL AAH (92-94), A3 1.8 8L1 AGN, 1.8T AGU, BPU (98-04), A4 1.8 8D2, B5 Exec ADR, 1.8T APU (95-01), 1.8T Avant, Multitronic, BFB, B6 AVJ 8E2, 1.9 TDi AVF, Avant B6, 8E5, 8E2 (00-08), A6 2.4 Avant Multitronic., Tiptronic, AGA, ALF, AML, APS, ARJ, 2.5TDi Multitronic Avant SW., BCZ/BDG/BFC, 2.6 ABC (97-03), S3 1.8T 8L1 Quattro AMK, BAM, APY (00-04), Daewoo Cielo 1.5 GL, GLX, GTX, 150i L, Espero 1.8 CD, C18LE, 2.0 CD, C20LE (96-99), Lanos I 1.35i S, 1.6 SX, Lanos II 1.4 S, 1.6 SX (97-03), Nubira I 1.6 SX, 2.0 CDX, Nubira II 1.6 SX, SX S/W, 2.0 CDX, Exec., S/W (97-03), Ford Cortina MkIII 2.5 XL, S/W Essex EV25, 3.0 GT, L, XL, XLE "Big Six" Essex EV30 (71-77), Cortina MkIV 3.0 V6 Ghia, GLS, S, S/W Essex EV30, 3.0 V6 Leisure, P/up Essex EV30 (77-80), Cortina MkV 3.0 V6 GLS, GLS XR6, Essex EV30, 3.0 V6 Leisure P/up Essex EV30 (80-86), Escort FWD MkIII 1.3 GL, L Kent, 1.6 GLE, L, Sport, XR3, i HL-16CVH (81-86), Laser 1.3 L, GL, 13, Dash E3 / B3, Tracer 1.3 Sedan, H/back -Tonic, Plus B3 (86-02), Laser 1.4 L CHV-FUA, 1.5 GL, GLS, Sport E5/B5 (86-92), Laser 1.6, i GL, 16, Sport, TX3 B6/ F6, 2.0, i RS FE, Tracer 1.6 Sedan, H/back - Plus, Sport, Tonic B6/F6 (95-02), Meteor 1.3 GL, L, 13 E3/B3, 1.4 LX CVH, 1.5 GL, GLS E5 (86-95), 1.6, i GL, GLE, GLi, 16, Sport B6/CVH/F6, 2.0 8/16V GLE, GLi FE (86-95), Honda Ballade SA4 1300 EN4 (82-85), Prelude 1.8 EX ES/ET (84-87), Mazda 323 FWD 1.3 L, H/back, Sedan E/B3, 1.5, L H/back, Sedan E5, 1.6 EG Hatch, L, Sedan, SL Hatch, SL Sedan, Sport Hatch B6i/F6 (84-91), 2.0 EG Hatch, SLE Hatch, SLi Sedan, 200e Hatch, Sedan, 200i Hatch 8/16V FE-2000 (89-95), 130 Hatch, Midge, Sedan, Sting B3, 160, i, S Hatch, Midge, Sedan, Sting F6 (90-95), 130 Hatch, Midge, Sedan, Sting B3, 160, i, S Hatch, Midge, Sedan, Sting F6, 200i, e Hatch 8/16V FE 2000 (95-05), Nissan Langley 1.3 GL E13, 1.5 GL, L, SSS, Trebon, Exa Turbo E15 (83-88), Pulsar 1.3 S E13, 1.4 DL, GX A14, 1.5 GL, Panache, SX E15 (80-87), Opel Ascona 1.3 L 13NV/SC, 1.6 GL 16SH, 1.8 GLS 18L (82-87), Astra F 140i, iS 14NV, 160i, iE, iS, Estate 16NZ, 180i, iE 18SE/ XE, XL, 200i, e, ts 20SE/ XE (93-99), Corsa B 130, i, Lite, iE, iS, Chill Hatch / Sedan 13NE, 140i, Classic, Active, Lite, Lite+, Comfort, Chill, Sport, S 14NE, Hatch/ Sedan, 160, i, iE, Classic, GSi, i Sport, S Hatch/ Sedan, 16SE, 1.8i GSi Hatch (96-03), Corsa LDV 130i Utility P/up 13NE, 1.4i Utility, S P/up 14NE, 1.6i Utility Sport P/up 16NZ, 1.7D Utility P/up X17D (97-04), Corsa P/ van 1.3i Pronto 13NE (99-00), Kadett D, E 1.2 L 12NS, 1.3 Cub, GL, GLS, LS, Rebel 13NV, 140 CL, Cub 14NE/ NV, 1.6 GL, GLS, GSE, L, Rebel, Cub 16SH/ SE, 160i, GSi Aspen 16SE (80-93), 1.8 GTE 18E, L 18LV, GSi Hatch 18L, GLX 18SV, GSi 18E/ SE (84-93), Kadett E 2.0 GSi 20XE, SGi 20SEH, 200, iS 20SE, Boss 20SEH, CD 20SHE, GSi, Super Boss 20SEH (87-93), Kadett F 140, S 14NE, 160i, iS, GSi, Aspen 16SV/ NZ (93-99), 180i, iE, GSi 18SE 200is 20XE (93-99), Monza 160 GSi, i Aspen 16SE/ NZ, CLS 16SV (86-93), 1.8 CLX, GLE, GLX, Convertible, GLi 18SE/ SV, 2.0 CD, CLi 2.0XE, CLE, GLE 20SE/ V (86-93), Toyota Corolla RWD TE31 1.6 Sprinter, SR4/5, Black Hawk, Silver Wolf 2T, AE/TE71 1.6 GL, S/W, GLS Sprinter, SE 2T, TB TE72, 1.8 GLS, SE 3T (80-88), Corolla KE70 1.3 P/van 4K (84-88)

## BUYERS GUIDE - LOOSE BEARINGS

<b>331274...</b> <b>Continued</b>	Front / Rear Wheel Bearing Inner / Diff Pinion Bearing	VW Beetle 1.8T Coupe APH, 2.0i Cabriolet, Highline AZJ (00-12), Caddy 1.6 SWB, Caddy Club P/up JK Dies., HM Pet., 1.8 SWB L, Sport P/up HV Pet. (81-97), 1.6i Club, Citi, P/up HM Pet. (97-03), Citi Golf 1.3 L ET/GY, 1.6 Blues, Chico, Chico Lux, Deco, Designa, L, Ritz, Shuttle, Sonic, Sport HM, HV, FR, 1.6iL, Life, VeloCiti, TenaCiti, CitiStorm, - Sport, - Rox, Rhythm, MKI AFX, 1.8 CTi, Designa, L Sport BZF (83-09), 1.3 L Shuttle, Chico, Chico Lux ET/ GY/ AJD, 1.4, iL, Chico, Rhythm, Citi com, VeloCiti, TenaCiti, CitiStorm, - Sport, Rox, Rhythm, Wolf, - XCite, Billabong AGY/ BSV (87-09), Fox 1.3 L, L Trippa GY, 1.6 L HM, 1.8 L Sport HV (87-96), Golf I 1.1 GL, L, LS ET/EG, 1.3 GL, L, LS GF, 1.5 GL Diesel, GLS, LS CK/ EM/ JB, 1.6 GL Diesel, GT, GTS, GTX JK/ CR FR, 1.8 GTi EV (78-84), Golf II 1.3 CL GY, 1.6 CSL HM, 1.8 8/16V CSX, GTS, GTi KR, EV, 2.0 8/16V GTi AAL (84-92), Golf III 1.6 GS ACG, 1.8 GSX, GTS ACH, 2.0 GTi, Exec. 2E, 2.8 VR6, Exec. AAA (92-99), Golf IV 1.6i Comfortline, Std., Estate AKL, 1.8, T GTi, Highline AGU/ AGN, 1.9 TDi Highline, Estate AHF, 2.0i Cabrio, Highline APK (99-04), Jetta I 1.3 GL, GX ET/ GF, 1.5 GLS/ GLX JB, 1.6 GLS EM, 1.8 GLi DX (80-85), Jetta II 1.6 CSL HM, 1.8 8/16V CLi, CLi Exec., CLX, CSi, CSX EV/KR, 2.0 8/16V CLi, Exec. AAL (85-92), Jetta III 1.6 CSL ACG, 1.8 CLX/ CSX ACH, 2.0 CLi, Exec. 2E, 2.8 VR6 Exec. AAA (92-99), Jetta IV 1.6i Comfortline, Std. AKL, 1.8T Highline, Exec AGU, 1.9 TDi Highline AHF, 2.0i Highline APK, 2.3 V5 AGZ (99-06), Passat I & II 1.3 L, LS H/back, Sedan, Variant ZF, 1.5 GL, LS Fastback, S/W CK, 1.6 GL, GLS, LS, LX Fastback, S/W, Sedan, Coupe, Variant, YN/YP/WN, 1.8 CL Sedan, S/W JV/KR (74-87), 1.9 GLS H/back, GLX Sedan, S/W WN, 2.2 CLi, CLX SG/MX (81-87), Polo 6N 1.4 Classic, Playa Lux AEX, 1.6 Classic, Playa, Lux AEE, 1.8 Classic, Playa, Lux ADZ (96-03)
<b>361895</b>	Diff. Pinion Bearing Front	VW Citi Golf 1.3 (83-87), Golf I 1.1, 1.3 (78-83), Jetta I 1.3 (80-85)
<b>362668</b>	Diff. Pinion Bearing Front	Ford Bantam 1.3, 1.4, 1.6 (83-94), Mazda Rustler 1.3, 1.4, 1.6 (85-94)
<b>412971</b>	Rear Wheel Bearing Inner	Ford Escort RWD Mki 1.1 Kent, 1.3 GT, L, Super, S/W Kent, 1.6 GT, L, XL Kent (68-75), Escort Mki/II 1.1 300 P/van Kent, 1.3 30, 35, 45 P/van Kent, 1.6 45 P/van Kent (68-81), Escort RWD MkII 1.3 L Kent, 1.6 GL, Sport Kent, RS2000 Koln (75-81), Nissan B140 1.4 A14SP/van, S/W, Deluxe, Std. Sport, CHAMP P/up (80-08), Stanza 1.6 DL, Resort, S/W L16, 1.8 GL, Resort, S/W SSS L18 (80-84), Toyota Corolla RWD TE31 1.6 Sprinter, SR4/5, Black Hawk, Silver Wolf 2T, AE/TE71 1.6 GL, S/W, GLS Sprinter, SE 2T, TB TE72, 1.8 GLS, SE 3T (80-88), Corolla TE71 1.6 P/van 2T (83-89), KE70 1.3 P/van 4K (84-88), Cressida TX30 1.8 DX 3T, TX62 1.8 L, LS 3T (80-89), Cressida RX60 2.0 GL, GLE, GLX, S/W 21R, RX70, YX72 2.0 GL, GL, GLE, GLX (81-92)
<b>446388</b>	Front Wheel Hub	BMW 520i, 525e, 525i, 528i, 530i, 535i, 540i (85-96), 735i, 745i (81-87), M5 (86-94)
<b>446389</b>	Front Wheel Hub	BMW 520i, 525e, 528i, 535i (85-89), 635CSi (80-89), 728i, 733i, 735i (85-87), M5 (86-89)
<b>492179</b>	Diff. Pinion Bearing Rear	VW Citi Golf 1.3 (83-87), Golf I 1.1, 1.3 (78-83), Jetta I 1.3 (80-85)
<b>572506</b>	Rear Wheel Bearing Inner	Mercedes-Benz S320, S420, S500 (93-99)
<b>6008</b>	Diff. Carrier Bearing	Daihatsu Charade 1.0 (83-85)
<b>6207</b>	Diff. Carrier Bearing	Honda Ballade 130, 150 (82-96)
<b>6208</b>	Diff. Carrier Bearing	Daihatsu Charade 1.0 (83-85), Honda Ballade 1.5, 1.6, 1.8 (85-00), Nissan Almera 1.6, 1.8 (01-06), Sentra 1.6 (92-02)
<b>572791</b>	Diff. Carrier Bearing	Ford Focus 1.6, 2.0 (00-05)
<b>616890</b>	Front Wheel Bearing Inner	Fiat Uno 1.0 Cento 156A2, 1.1 Espresso P/van 160A3, 1.1 Fire, Rio, Mia, Tempo 160A3, 1.4 Pacer, Beat, Mia, Tempo, SX 146C1 (90-05)
<b>633188</b>	Front Wheel Bearing Inner	Alfa Romeo 33 1.5 (83-85), Alfasud 1.2, 1.3, 1.5 (74-85), Export 1.5 (80-85)
<b>633295</b>	Front Wheel Bearing Inner	Fiat 128 1.1, 1.3 (71-84), Tata Indica 1.4, Indigo 1.4 - Some models (2005-), Vista 1.4 (2010-)
<b>633809</b>	Rear Wheel Bearing Inner	Volvo 960 2.9 (94-97)
<b>633816</b>	Front / Rear Wheel Bearing Inner	Audi A4 1.8 8D2, B5 Exec ADR, 1.8T APU (95-01), 2.5 TDi 8D/E2 Quattro AFB, Quattro Tiptronic, 2.6 8D2 / 8D5 Exec. (95-00), 3.0 Quattro Tiptronic, ASN (02-08), A6 2.8 Quattro 4A, AAH, ACK, 3.0 Quattro Tiptronic BBJ (94-00), 2.4 Avant Multitronic., Tiptronic, AGA, ALF, AML, APS, ARJ, 2.5TDi Multitronic Avant SW., BCZ/BDG/BFC, 2.6 ABC (97-03), VW Passat IV 1.8T AEB, 2.8, 4 Motion, Quattro, Tiptronic ACK/ AMX (99-05)
<b>633817</b>	Front / Rear Wheel Bearing Inner	Audi 500 2.2 E PR, 2.3 E, SE, AAR, 2.8 SEL AAH (92-94), A6 2.8 Quattro 4A, AAH, ACK, 3.0 Quattro Tiptronic BBJ (94-00), 2.4 Avant Multitronic., Tiptronic, AGA, ALF, AML, APS, ARJ, 2.5TDi Multitronic Avant SW., BCZ/BDG/BFC, 2.6 ABC (97-03), 2.7T Quattro AJK, ARE, BES (00-06), 2.4 BDV (02-05), A8 3.7 Tiptronic AQG, 4D2, 4.2 Quattro 4E2/8 BFM (95-02), S4 2.2T Quattro AAN (92-95), Passat IV 1.8T AEB, 3.2 V6 Sportline DSG AXZ (99-05)

# BUYERS GUIDE - LOOSE BEARINGS

<b>633818</b>	Front Wheel Bearing Inner	Audi A4 2.5 TDi 8D/E2 Quattro AFB, Quattro Tiptronic, 2.6 8D2 / 8D5 Exec. (95-00), 3.0 Quattro Tiptronic, ASN (02-08)
<b>636096</b>	Front / Rear Wheel Bearing Inner	Chevrolet Optra 1.6 Ls F16D3, 1.8 Lt T18SED (04-11), Daewoo Tacuma 1.6 SX, 2.0 CDX, CDX Plus (01-03), Opel Astra F 140i, iS 14NV, 160i, iE, iS, Estate 16NZ, 180i, iE 18SE/ XE, XL, 200i, e, ts 20SE/ XE (Some & 2.0ts) (93-99), Kadett F 200is 20XE (93-99), Omega 2.2i Y22XE, 2.6i Elegance Y26SE (01-04)
<b>636114</b>	Front Wheel Bearing Inner	Opel Astra F 140i, iS 14NV, 160i, iE, iS, Estate 16NZ (93-99), Corsa B 130, i, Lite, iE, iS, Chill Hatch / Sedan 13NE, 140i, Classic, Active, Lite, Lite+, Comfort, Chill, Sport, S 14NE, Hatch/ Sedan, 160, i, iE, Classic, GSi, i Sport, S Hatch/ Sedan, 16SE, 1.8i GSi Hatch (96-03), Corsa LDV 130i Utility P/up 13NE, 1.4i Utility, S P/up 14NE, 1.6i Utility Sport P/up 16NZ, 1.7D Utility P/up X17D (97-04), Corsa P/van 1.3i Pronto 13NE (99-00), Kadett F 140, S 14NE, 160i, iS, GSi, Aspen 16SV/ NZ (93-99)
<b>639062</b>	Diff. Carrier Bearing	Fiat Uno 1.0, 1.1, 1.4 (90-05)
<b>639068</b>	Diff. Carrier Bearing	Fiat Uno 1.0, 1.1, 1.4 (90-05)
<b>639297</b>	Front Wheel Bearing Inner	Fiat 131 1.6, 2.0 (77-80)
<b>895978</b>	Front Wheel Bearing Inner	BMW X5 3.0d, 3.0i, 4.4i, 4.6iS, 4.8iS (01-08)
<b>902314</b>	Rear Wheel Bearing Inner	BMW X3 2.0d, 2.5i, 2.5si, 3.0d, 3.0i, 3.0si - Alt. (04-09)
<b>2852184</b>	Diff. Carrier Bearing	Toyota Dyna 2.0, 2.2, 2.4, 3.0, 3.7, 4.0 (85-02)
<b>102910+49</b>	Front Wheel Bearing Inner / Outer / Diff. Carrier Bearing	C.A.M. Inyathi Jinbei Haise Minibus 2.2i Std., Rhino 2.2i, 2.8i (2007-), Ford Courier 2.5TD D/cab, Leisure P/up WL4, 3.0 V6 Std., XLT, D/cab, Leisure, Explorer, Exec. P/up Essex, 3.4 V6 Leisure, P/up Essex. - 4X4 (96-00), Falcon 4.0 GLi, Fairmont, Fairmont, Futura XR6 Mpi (96-03), Ranchero 4.0 GLi, Outback, XR6 P/up 250 (97-99), Ranger 1.8 XL, P/up, 2.2 XL, P/up (04-10), 2.5 D/Cab, High Trail, XL, DT XLT High Super Cab, 2.5TD Montana D/Cab WL4, 3.0TDCi, 4.0 Super Cab XLT - 4X4 (00-04), Hyundai Terracan 2.9 CRDi SUV, 3.5i V6 SUV - 4X4 (03-08), Isuzu WFR 1.8 11FVX/ 12FVX Bus, P/van 4ZB1 (83-89), Kia Sportage JA 2.0 SUV 5 Spd. FE Pet. - 4X4 (98-03), Mazda B-Series B2600 2.6 V6 LWB D/cab, Magnum, Drifter P/up 4G54 Pet., 3.0 V6 LWB D/cab, Magnum, Drifter, Magnum Drifter P/up Essex Pet. - 4X4 (86-97), B2500 2.5, Td LWB D/Cab, Drifter, SLX P/up WL4 Dies./Turbo Dies., B3400 3.4 V6 LWB Magnum D/cab P/up Esse. - 4X4 (96-01), B2600i 2.6i V6 LWB Drifter, D/cab Drifter SLX P/up 4G54 Pet. - 4X4 (00-09), Drifter 1.8 SWB/LWB XL P/up Pet., 2.2 SWB/LWB XL P/up Pet. (00-09), 2.5Td LWB D/cab, DL, SL, SLE, SLX S/cab, D/cab P/up WL4 Dies./Turbo Dies., 2.6i V6 LWB SL S/cab, SLE, SLX D/cab P/up 4G54 Pet. - 4X4 (02-04), Mitsubishi Colt LDV 1.6 SWB/LWB Lo-Line P/up 4G32 Pet., 2.0 4G63 Pet., 2.5D 4D56 Dies., 2.6 WB Hi-Line P/up 4G54 Pet. (94-98), 2.5D LWB Hi-Line P/up 4D56 Dies., 2.6 LWB Lo-/Hi-Line, P/up 4G54 Pet., 3.0 V6 LWB Lo-/Hi-Line D/cab, Rodeo 6G72 Pet. - 4X4 (95-98), 2.4i LWB Hi-Line D/cab, Trailbuster S/cab, P/up Pet. - 4X4 (98-09), 2.8TDi LWB Pioneer, Rodeo D/cab P/up Turbo Dies., 3.0i V6 LWB Rodeo D/cab P/up Pet. - 4X2, 2.8D, TDi LWB Club cab, Trailbuster S/cab, Rodeo /cab P/up Dies./ Turbo Dies., 3.0i V6 LWB Rodeo D/cab P/up Pet. - 4X4 (99-09), Pajero 2.8 Tdi, 3.0 V6 SWB GLS Wagon 6G72 Pet., 3.5 V6 SWB GLS Wagon 6G74 Pet. - 4X4 (90-01), Nissan Skyline R31 2.0 SGLi, SGLi RB20E, 3.0 SGLi RB30E With I.R.S. (87-92), Toyota Hiace YH50/60 1.8 SWB / LWB P/van, LS Wagon 2Y Pet. (87-91), YH53/63 2.2 SWB/LWB P/van, Van, LS, Super T/14/16, GLX, Exec. Wagon, Siyaya Bus, P/van 4Y Pet. (All Local Models) (88-09), Hilux YN67 2.2 LWB D/cab, Raider D/cab P/up 4Y Pet. - 4X4 (86-94), LN65 2.4 LWB D/cab, Raider D/cab P/up 2L Dies. - 4X4 (89-98), RN67 2.4 LWB D/cab, Raider D/cab P/up 22R Pet. - 4X4 (94-98), RZN194 2.7i LWB D/cab, Raider, Legend35 Raider, 3RZFE Pet. (98-05), LN57 2.8D LWB D/cab, Raider P/up 3L Dies. - 4X2, LN67 2.8D LWB, D/cab, Raider D/cab P/up 3L Dies. - 4X4 (95-98), LN192R 3.0D LWB Raider D-E, Raider DLX D/cab D-E, Legend35 Raider, P/up 5L Dies., 3.0iD LWB Raider, Raider D/cab, P/up KZ-TE Dies. - 4X2, RZN169 2.7i LWB D/cab, DLX S/cab, Raider S/D/cab, SRX D/cab, Legend 35 LWB P/up 3RZFE Pet. - 4X4, LN167 3.0D D/cab D-E, DLX, S/D/cab DE, Raider DE, Legend35 LWB P/up 5L Dies., 3.0iD LWB Raider S/cab & KZ-TE D/cab P/up, Legend35 - 4X4 (98-05), Land Cruiser FJ80 4.0 DLX, GX, VX P/up 3F/F-E Pet. - 4X4 (90-92), FZJ/HZJ75 4.2 GX S/W, P/up 1FZF/HZ Dies. - 4X4 (91-97), FZJ80 4.5 Std., GX, VX, Turbo S/W, P/up 1FZ-FE Dies., Turbo Dies. - 4X4 (92-95), FZJ80 4.5 Std., GX, VX, Turbo S/W, P/up 1FZ-FE Dies., Turbo Dies. - 4X4 (95-06), FZJ105 4.5 Std., GX, Turbo P/up, S/W 1FZ-FE Dies., Turbo Dies. - 4X4 (95-98), FZJ105 4.5 V8 VX, Turbo P/up, S/W 2UZ-FE Pet. - 4X4 (98-06), HDJ/HZJ80 4.2 GX, Turbo S/W, P/up 1HD-FT, 1HZ Dies., T. Dies. - 4X4 (90-95), HDJ/HZJ80 4.2 Std., GX, VX, Turbo S/W, P/up 1HD-FT, 1HZ Dies., Turbo Dies. - 4X4 (95-01), HDJ100 4.2 Std., GX, VX S/W, 1HZ Pet., 4.5, 4.7 V8 (97-04), HZJ76 4.2D - 4X4 (2009-), HZJ105 4.2 Std., GX DSL, Turbo P/up, S/W 1HZ Dies., Turbo Dies. - 4X4 (98-06), PHJ75 3.9 DLX, GX, GX Turbo P/up Perkins236 2H Dies., FJ75 4.0 DLX, GX, VX 3F/F-E Pet., HJ75 - 4X4 (85-92), UZJ100 4.5 V8 Std., GX, VX S/W, P/up 2UZ-FE Pet. - 4X4 (98-06)



## BUYERS GUIDE - LOOSE BEARINGS

<b>104910+48</b>	Front / Rear Wheel Bearing Inner / Outer / Diff. Carrier Bearing	<p>BMW 5 Series E34 520i 2.0 M50, 525i 2.5 M50, 530i 3.0 M60, 535i 3.5 M30, 540i 4.0 M60 (90-00), 7 Series E32 730i M30/60, 735i M106, 740i M60, 750iL M7 (87-95), E38 740i M60/62, 750iL M70 (95-03), 8 Series E31 850iL V12 M70 (91-94), M5 Coupe M30, M5 Coupe MS38 (86-94), Toyota Hilux YN67 2.2 LWB D/cab, Raider D/cab P/up 4Y Pet. - 4X4 (86-94), LN65 2.4 LWB D/cab, Raider D/cab P/up 2L Dies. - 4X4 (89-98), RN67 2.4 LWB D/cab, Raider D/cab P/up 22R Pet. - 4X4 (94-98), RZN194 2.7i LWB D/cab, Raider, SRX, Legend35 Raider, 3RZFE Pet. (98-05), LN67 2.8D LWB, D/cab, Raider D/cab P/up 3L Dies. - 4X4 (95-98), LN192R 3.0D LWB Raider D-E, Raider DLX D/cab D-E, Legend35 Raider, P/up 5L Dies., 3.0iD LWB Raider, Raider D/cab, P/up KZ-TE Dies. (98-05), RZN169 2.7i LWB D/cab, DLX S/cab, Raider S/D/cab, SRX D/cab, Legend 35 LWB P/up 3RZFE Pet., LN167 3.0D D/cab D-E, DLX, S/D/cab DE, Raider DE, Legend35 LWB P/up 5L Dies., 3.0iD LWB Raider S/cab &amp; KZ-TE D/cab P/up, Legend35 - 4X4 (98-05), Land Cruiser FJ80 4.0 DLX, GX, VX P/up 3F/F-E Pet. - 4X4 (90-92), FZJ/HZJ75 4.2 GX S/W, P/up 1FZF/HZ Dies. - 4X4 (91-97), FZJ80 4.5 Std., GX, VX, Turbo S/W, P/up 1FZ-FE Dies., Turbo Dies. - 4X4 (92-95), FZJ80 4.5 Std., GX, VX, Turbo S/W, P/up 1FZ-FE Dies., Turbo Dies. - 4X4 (95-06), FZJ105 4.5 Std., GX, Turbo P/up, S/W 1FZ-FE Dies., Turbo Dies. - 4X4 (95-98), FZJ105 4.5 V8 VX, Turbo P/up, S/W 2UZ-FE Pet. - 4X4 (98-06), HDJ/HZJ80 4.2 GX, Turbo S/W, P/up 1HD-FT, 1HZ Dies., T. Dies. - 4X4 (90-95), HDJ/HZJ80 4.2 Std., GX, VX, Turbo S/W, P/up 1HD-FT, 1HZ Dies., Turbo Dies. - 4X4 (95-01), HDJ100 4.2 Std., GX, VX S/W, 1HZ Pet., 4.5, 4.7 V8 - 4X4 (97-04), HZJ76 4.2D - 4X4 (2009-), HZJ105 4.2 Std., GX DSL, Turbo P/up, S/W 1HZ Dies., Turbo Dies. - 4X4 (98-06), PHJ75 3.9 DLX, GX, GX Turbo P/up Perkins236 2H Dies., FJ75 4.0 DLX, GX, VX 3F/F-E Pet., HJ75 - 4X4 (85-92), UZJ100 4.5 V8 Std., GX, VX S/W, P/up 2UZ-FE Pet. - 4X4 (98-06)</p>
<b>10R33A</b>	Rear Wheel Bearing Inner	Peugeot Boxer 2.5TD (02-06)
<b>11710+49</b>	Front / Rear Wheel Bearing Outer	<p>Daewoo Cielo 1.5 GL, GLX, GTX, 150i L, Espero 1.8 CD, C18LE, 2.0 CD, C20LE (96-99), Lanos I 1.35i S, 1.6 SX, Lanos II 1.4 S, 1.6 SX (97-03), Nubira I 1.6 SX, 2.0 CDX, Nubira II 1.6 SX, SX S/W, 2.0 CDX, Exec., S/W (97-03), Ford Cortina MkIII 1.6 L P/up Kent, 1.6 L, Std., XL Kent, 2.0 OHC GT, V4 L, XL, S/W Essex EV20, 2.0 V4 P/up Koln T20, 2.5 L P/up Essex EV25, 2.5 XL, S/W Essex EV25, 3.0 GT, L, XL, XLE "Big Six" Essex EV30 (71-77), MkIV 1.3 L Kent, 1.6 GL, L, S/W Kent, 1.6 P/up Kent, 2.0 GL, GLE, S/W Koln T20, 3.0 V6 Ghia, GLS, S, S/W Essex EV30, 3.0 V6 Leisure, P/up Essex EV30 (77-80), MkV 1.3 L Kent, 1.6 GL, L, Kent, 1.6 P/up Kent, 2.0 Ghia, GL Koln T20, 2.4 P/up York D24, 3.0 V6 GLS, GLS XR6, Essex EV30, 3.0 V6 Leisure P/up Essex EV30 (80-86), Escort RWD MkI 1.1 Kent, 1.3 GT, L, Super, S/W Kent, 1.6 GT, L, XL Kent (68-75), MkII 1.1 300 P/van Kent, 1.3 30, 35, 45 P/van Kent, 1.6 45 P/van Kent (68-81), Escort RWD MkII 1.3 L Kent, 1.6 GL, Sport Kent, RS2000 Koln (75-81), Escort FWD MkIII 1.3 GL, L Kent, 1.6 GLE, L, Sport, XR3, i HL16CVH (81-86), Hyundai Atos 1.0 Prime G4HC (00-05), 1.1 G4HG (2005-), Kia Pride 1.3i LX 5 Dr. H/back (98-04), Mazda 323 FWD 1.3 S, H/back, Sedan E3, 1.5 GLC, SL, SLX, Sport H/back, Sedan E5 (81-88), Mercedes-Benz W201 190E 1.8 M102.920, 2.0 M102.922, 2.3 Sportline M102.983 (93-94), Nissan B140 1.4 A14SP/van, S/W, Deluxe, Std. Sport, CHAMP P/up (80-08), Opel Ascona 1.3 L 13NV/SC, 1.6 GL 16SH, 1.8 GLS 18L (82-87), Astra F 140i, iS 14NV, 160i, iE, iS, Estate 16NZ, 180i, iE 18SE/XE, XL, 200i, e, ts 20SE/XE (93-99), Corsa B 130, i, Lite, iE, iS, Chill Hatch / Sedan 13NE, 140i, Classic, Active, Lite, Lite+, Comfort, Chill, Sport, S 14NE, Hatch/ Sedan, 160, i, iE, Classic, GSi, i Sport, S Hatch/ Sedan, 16SE, 1.8i GSi Hatch (96-03), Corsa LDV 130i Utility P/up 13NE, 1.4i Utility, S P/up 14NE, 1.6i Utility Sport P/up 16NZ, 1.7D Utility P/up X17D (97-04), Corsa P/van 1.3i Pronto 13NE (99-00), Kadett D, E 1.2 L 12NS, 1.3 Cub, GL, GLS, LS, Rebel 13NV, 140 CL, Cub 14NE/ NV, 1.6 GL, GLS, GSE, L, Rebel, Cub 16SH/ SE, 160i, GSi Aspen 16SE (80-93), 1.8 GTE 18E, L 18LV, GSi Hatch 18L, GLX 18SV, GSi 18E/ SE (84-93), Kadett E 2.0 GSi 20XE, SGi 20SEH, 200, iS 20SE, Boss 20SEH, CD 20SHE, GSi, Super Boss 20SEH (87-93), Kadett F 140, S 14NE, 160i, iS, GSi, Aspen 16SV/ NZ, 180i, iE, GSi 18SE, 200is 20XE (93-99), Monza 160 GSi, i Aspen 16SE/ NZ, CLS 16SV, 1.8 CLX, GLE, GLX, Convertible, GLi 18SE/ SV, 2.0 CD, CLi 2.0XE, CLE, GLE 20SE/ V (86-93), Toyota Corolla RWD TE31 1.6 Sprinter, SR4/5, Black Hawk, Silver Wolf 2T, AE/TE71 1.6 GL, S/W, GLS Sprinter, SE 2T, TB TE72, 1.8 GLS, SE 3T (80-88), TE71 1.6 P/van 2T (83-89), KE70 1.3 P/van 4K (84-88), Tuv KF20 1.3 Chassis Cab, P/up, P/van, Bus 4K Pet., 1.5 P/up 5K Pet. (82-87),</p>

## BUYERS GUIDE - LOOSE BEARINGS

<p><b>11710+49...</b> <b>Continued</b></p>	<p>Front / Rear Wheel Bearing Outer</p>	<p>VW Citi Golf 1.3 L ET/GY, 1.6 Blues, Chico, Chico Lux, Deco, Designa, L, Ritz, Shuttle, Sonic, Sport HM, HV, FR, 1.6iL, Life, VeloCiti, TenaCiti, CitiStorm, - Sport, - Rox, Rhythm, MKI AFX, 1.8 CTi, Designa, L Sport BZF (83-09), 1.3 L Shuttle, Chico, Chico Lux ET/ GY/ AJD (87-03), 1.4, iL, Chico, Rhythm, Citi com, VeloCiti, TenaCiti, CitiStorm, - Sport, Rox, Rhythm, Wolf, - XCite, Billabong AGY/ BSV (99-09), Fox 1.3 L, L Trippa GY, 1.6 L HM, 1.8 L Sport HV (87-96), Golf I 1.1 GL, L, LS ET/EG, 1.3 GL, L, LS GF, 1.5 GL Diesel, GLS, LS CK/ EM/ JB, 1.6 GL Diesel, GT, GTS, GTX JK/ CR FR, 1.8 GTi EV (78-84), Golf II 1.3 CL GY, 1.6 CSL HM, 1.8 8/16V CSX, GTS, GTi KR, EV, 2.0 8/16V GTi AAL (84-92), Golf III 1.6 GS ACG, 1.8 GSX, GTS ACH, 2.0 GTi, Exec. 2E, 2.8 VR6, Exec. AAA (92-99), Jetta I 1.3 GL, GX ET/ GF, 1.5 GLS/ GLX JB, 1.6 GLS EM, 1.8 GLi DX (80-85), Jetta II 1.6 CSL HM, 1.8 8/16V CLi, CLi Exec., CLX, CSi, CSX EV/KR, 2.0 8/16V CLi, Exec. AAL (85-92), Jetta III 1.6 CSL ACG, 1.8 CLX/ CSX ACH, 2.0 CLi, Exec. 2E, 2.8 VR6 Exec. AAA (92-99), Passat I &amp; II 1.3 L, LS H/back, Sedan, Variant ZF, 1.5 GL, LS Fastback, S/W CK, 1.6 GL, GLS, LS, LX Fastback, S/W, Sedan, Coupe, Variant, YN/YP/WN, 1.8 CL Sedan, S/W JV/KR (74-87), 1.9 GLS H/back, GLX Sedan, S/W WN, 2.2 CLi, CLX SG/MX (81-87), Polo 6N 1.4 Classic, Playa Lux AEX, 1.6 Classic, Playa, Lux AEE, 1.8 Classic, Playa, Lux ADZ (96-03)</p>
<p><b>11910+49</b></p>	<p>Front / Rear Wheel Bearing Outer</p>	<p>Audi 100/4 1.6 LS YV, 100/5 1.9 WH, 200 2.1 GLS, GLX, 400 1.8 JW, 500 2.1/2.2 WB, WC SE PR (77-92), 500 2.2 E PR, 2.3 E, SE, AAR, 2.8 SEL AAH (92-94), A4 1.8 8D2, B5 Exec ADR, 1.8T APU (95-01), A6 2.4 Avant Multitronic., Tiptronic, AGA, ALF, AML, APS, ARJ, 2.5TDi Multitronic Avant SW., BCZ/BDG/BFC, 2.6 ABC (97-03), Ford Bantam 1300 P/up Kent 2V, 1400 Leisure, Nite P/up CVH/FUA, 1600 Leisure Explorer, Nite P/up CVH (83-94), 130 Explorer P/up B3, 160, i Explorer, Leisure, Sport, P/up B6/ F6 (94-03), Laser 1.3 L, GL, 13, Dash E3 / B3 (86-95), Tracer 1.3 Sedan, H/back -Tonic, Plus B3 (95-02), Laser 1.4 L CHV-FUA, 1.5 GL, GLS, Sport E5/B5 (86-92), Laser 1.6, i GL, 16, Sport, TX3 B6/ F6, 2.0, i RS FE (86-95), Tracer 1.6 Sedan, H/back - Plus, Sport, Tonic B6/F6 (95-02), Meteor 1.3 GL, L, 13 E3/B3, 1.4 LX CVH, 1.5 GL, GLS E5, 1.6, i GL, GLE, GLi,16, Sport B6/CVH/F6, 2.0 8/16V GLE, GLi FE (86-95), Honda Ballade SA4 1300 EN4 (82-85), Prelude 1.8 EX ES/ET (84-87), Kia Rio I 1.3 5 Dr. H/back A3E, 1.5 5 Dr. H/back A5D (98-04), Mazda 323 FWD 1.3 L, H/back, Sedan E/B3, 1.5, L H/back, Sedan E5, 1.6 EGi Hatch, L, Sedan, SL Hatch, SL Sedan, Sport Hatch B6i/F6 (84-91), 2.0 EGi Hatch, SLE Hatch, SLi Sedan, 200e Hatch, Sedan, 200i Hatch 8/16V FE-2000 (89-95), 130 Hatch, Midge, Sedan, Sting B3, 160, i, S Hatch, Midge, Sedan, Sting F6 (90-95), 130 Hatch, Midge, Sedan, Sting B3, 160, i, S Hatch, Midge, Sedan, Sting F6, 200i, e Hatch 8/16V FE 2000 (95-05), 626 1.6 S Sedan, Hatch F6, 1.8 L Sedan, Hatch F8, 2.0 SL, SLE, SLX, 2.0i EGi, SLi FE (Rear Drum brakes) (83-93), Rustler 1.3 SWB P/up Kent 2V Pet., 1.4 SWB P/up CVH/FUA Pet., 1.6 SWB, LX P/up CVH/ LUC Pet. (86-94), 130 SWB Drifter, Explorer P/up B3 Pet., 160, i SWB Explorer, Drifter P/up F6/B6i Pet. (94-02), Mercedes-Benz W124 200E M102.922, 220E M111.960, 230E M102.982, 260E M103.940, 280E M104.942, 300D M103.985, M606.910, 320 Sportline M104.922 (86-96), W201 190E 1.8 M102.920, 2.0 M102.922, 2.3 Sportline M102.983 (93-94), Nissan Langley 1.3 GL E13, 1.5 GL, L, SSS, Trebon, Exa Turbo E15 (83-88), Laurel C31 2.0 CA/L20, 2.8 SGL 5L28, Pulsar 1.3 S E13, 1.4 DL, GX A14, 1.5 GL, Panache, SX E15 (80-87), Stanza 1.6 DL, Resort, S/W L16, 1.8 GL, Resort, S/W SSS L18 (80-84), Skyline R30 1.8 L18, 2.0 GL L20, R31 2.0 GL, GLE CA20 (82-92), R30 2.8 GLX, GTX L28/2 (83-86), R31 2.0 SGi, SGLi RB20E, 3.0 SGLi RB30E With I.R.S. (87-92), Opel Rekord 2.0 Berlina, GL, GLS, L, S/W CIH, 2.0i CLE, CLS, GL, GLE, Irmscher, 2.2E CIH, 380i, V6 CD, GSi 38GE (82-95), Toyota Condor 1.6 Estate, TE, 5L, 1.8 2Y, 2.0i Estate, TE, 1RZ Pet., 2.4i Estate, TE, TX 2RZ-E, 3.0D Estate, TE, 5L Dies. - 4X2 (00-05), Cressida TX30 1.8 DX 3T, TX62 1.8 L, LS 3T, YX70 1.8 LS, Exec. (80-89), RX60 2.0 GL, GLE, GLX, S/W 21R, RX70, YX72 2.0 GL, GL, GLE, GLX (81-92), GX60 2.0 GLi6 1G-E, GX7 2.0 GLi6 1G-E, 1G-FE (83-92), MX63 2.8i 5M-E, MX73 2.8i RSi, RSi Exec. 5M-GE (84-89), MX75 3.0i ECT, GLS 7MG-E (86-92), RX72 2.4 GL, GL S/W, GLE, GLE S/W 22R, RX73 2.4 GLE, GLE S/W 22R With I.R.S. (Independent Rear Suspension) (87-92), Stallion KF50 1.5 SR5,Commuter, Bus, P/up, P/van 5K Pet., YF50 1.8 SR5, P/up, P/van, Van 2Y Pet., LF50 2.4D P/up 2L5F Dies. (87-04), Venture YF50 1.8 8/10 Seater P/van 2Y Pet., 2.2 10 Seater, GLE, Getaway 9 Seater S/W 4Y Pet., LF50 2.4D 10 Seater S/W 2L5F Dies. (91-04), VW Caddy 1.6 SWB, Caddy Club P/up JK Dies., HM Pet., 1.8 SWB L, Sport P/up HV Pet. (81-87), Kombi T2 2.0, L Exec., Microbus, Kamper, P/up, P/van CU, CJ Pet., T3 1.9 Microbus, P/van DG Pet. (75-83)</p>
<p><b>12131ASB</b></p>	<p>Front Wheel Bearing Inner</p>	<p>Alfa Romeo 146 2.0 Ti Twin Spark AR67204 (96-99), 155 2.0 TS AR32301 (96-99), GTV / Spider 2.0 (96-06), Fiat Doblo 1.9 Cargo P/van 223A6.000 (03-06), Multipla 1.6 Active, 1.6 SX, 1.9 JTD ELX MPV 182A4.000 (03-10), Punto 1.3D 2U 188 JTD Dynamic, JTD Multijet 188A9.000 (04-13)</p>

## BUYERS GUIDE - LOOSE BEARINGS

<b>12132ASB</b>	Front Wheel Bearing Inner	Fiat Palio I 1.2 ED, EL, Go!, Paint Ltd. M657BA.12T 178B5.000, 1.6 EL, ELX, HL, Weekend S/W, 178B3.000 (00-05), Palio II 1.2 Espresso 178B6.000, 1.2 Go!, 178B5.000, 1.6 178B3.000, 1.7TD, EL. (05-10), Siena I/II 1.2 EL, EL, Plus!, M657BA 12T, 1.6 EL, Plus!, ELX HL 178B3.000, 1.6 EL+, HL, ELX, 178B3000, 1.7TD EL 176A3.000 (00-10)
<b>12271SP</b>	Rear Wheel Bearing Inner	Mercedes-Benz A160, A190 (00-04), Renault Laguna 1.6, 1.8, 1.9dCi, 2.0 (96-04), Kangoo 1.4, 1.5dCi (01-03)
<b>12306GB</b>	Front Wheel Bearing Inner	Fiat Panda 1.1 Active 187A1.000 (2006-), Seicento 1.1 (01-03)
<b>12306XGB</b>	Front Wheel Bearing Inner	Fiat 500 1.2 169A4.000 (08-15), Panda 1.2 Dynamic 169A4.000, 188A4.000 (2006-), 1.3, 1.4 (2006-), Seicento 1.1 (01-03)
<b>12610+49</b>	Front Wheel Bearing Outer	C.A.M. Inyathi Jinbei Haise Minibus 2.2i Std., Rhino 2.2i, 2.8i (2007-), Ford Husky 1.8 1 Ton P/up 4G62, 2.0 1 Ton P/up, Bus, P/van 4G63 (85-99), Hyundai Bakkie 2.5i D4BH Dies., 2.6i D4BB Dies., H100 P/Van 2.5i D4BH Dies., 2.6i D4BB Dies. (97-07), Isuzu KBD20 2.0 P/up C190, KBD21 2.0 P/up C190, KBD22 2.2 LE, P/up C223 (78-89), KB160 1.6 Fleetside P/up, KB200 2.0 LE, Fleetside, D/cab P/up, KB220 2.2 LE, P/up, KB230 2.3 D/cab P/up (89-04), KB260 2.6 LE, D/cab, LX P/up 4ZE1, KB320 3.2 LE, D/cab, LX, Frontier, Reef, Blazer P/up 6VD1 (92-04), KB200i 2.0 LX, KB240i 2.4 LX, KB250i 2.5 LX (04-12), KB250D 2.5 Fleetside, LE, D/Cab P/up 4JA1, KB280DT 2.8 D/cab LE, LX, Frontier P/up Turbo 4JB1 (89-04), KB250Dc 2.5, KB300TDi 3.0 LX (04-09), KB300TDi 3.0 D-TEQ (07-11), Relay 2.0 P/van, Bus 4ZC1 (89-95), WFR 1.8 11FVX/ 12FVX Bus, P/van 4ZB1 (83-89), Mercedes-Benz W123 200 M115.938/9, 230, E M115.954, 240D M616.912, 250 M123.920/1, 280E M110.983, 300D M617.912 (77-86), W126 280SE M110 987/9, 300SE M103.981, 380SE M116.963, 420SE M116.965, 500SE M117.965 (86-93), Mitsubishi Colt LDV 1.6 SWB/LWB Lo-Line P/up 4G32 Pet., 2.0 4G63 Pet., 2.5D 4D56 Dies., 2.6 WB Hi-Line P/up 4G54 Pet., 2.8D LWB Std., Hi line P/up Dies., 2.8TDi LWB Club CabS cab, Turbo, 3.0i V6 LWB Club S/cab P/up Pet. (94-98), 2.0 LWB Std. P/up, 2.0i LWB Hi-Line, 2.4i LWB Hi-Line Rodeo S-/D/cab, Hi-Line/Rider P/up Pet., 2.5D 4D56 Dies., 2.8TDi LWB Pioneer, Rodeo D/cab P/up Turbo Dies., 3.0i V6 LWB Rodeo D/cab P/up Pet. (98-09), L300 1.6 Mini Bus, Van 4G32 Pet., 1.8 4G62 Pet., 2.0 P/up 4G63 Pet., Starwagon 2.0 S, SL, SLE, P/up, P/van 4G63 Pet. (82-01), Nissan 1-Tonner/Hardbody AW/D21 1.6 L16S-J, 1.8 L18S-R, 2.0 NA20, 2.4 Z24/S, 2.5D TD25i, 2.7D TD27, 3.0 VG30E (88-98), 720 D20 1.8 L18S Kingcab, Sport, 2.2D SD/Z22 Tracker, 2.3 SD23 (80-88), E20 1.8 L18 Bus, P/van Coach, Coach GL, GLE, Econolux, Ekonovan, Ekonowagon, 2.0 Bus, Van H20 (80-86), Hardbody QW/D22 2.0 NA20S, 2.0i KA20, 2.4i Z24, KA24E/DE, 2.7D TD27i, 3.0 i VG30E, 3.0TD ZD30, 3.2 QD32, 3.3i VG33E (98-11), NP300 D22 2.0i, S, SE KA20, 2.5TDi, S, SE YD25 (2008-), Sani AW/D21 2.4, i Z24, 2.5 TD25, 2.7D, TD TD27, 3.0 VG30E (89-99), Hiace YH50/60 1.8 SWB / LWB P/van, LS Wagon 2Y Pet. (83-91), YH51/61 2.0 SWB/LWB 16 Seater Commuter, Super 10 Seater Custom Wagon, P/van 3Y Pet. (86-86), YH53/63 2.2 SWB/LWB P/van, Van, LS, GLX, Exec., Wagon 4Y Pet. (All Imp. Models) (86-88), YH53/63 2.2 SWB/LWB P/van, Van, LS, Super T/14/16, GLX, Exec. Wagon, Siyaya Bus, P/van 4Y Pet. (All Local Models) (88-09), Hilux LN30/40/50/51/55 2.2 SWB/LWB P/up L Dies., 2.4 SWB/LWB D/cab, Raider P/up 2L Dies., YN58 2.2 LWB D/cab, Raider, SRX P/up 4Y Pet. (79-98), YN51/56 1.8 SWB/LWB D/cab, S, SR, Raider P/up 2Y Pet., YN140 1.8 SWB/LWB D/cab, Raider, S, SRX P/up 2Y Pet. (86-05), RN58 2.4 22R Pet., LN140/145 2.4i DLX, P/up 2L Dies. (94-05), LN57 2.8D LWB D/cab, Raider P/up 3L Dies. - 4X2 (95-98), RZN147 2.0 SWB/LWB D/cab, DLX, Raider, S, SR, SRX P/up 1RZ Pet. (98-05)
<b>12710+49</b>	Front Wheel Bearing Outer	BMW 7 Series E23 728, i M30, 730 M30, 733i M30, 735i M90, 745i M88 (78-85), Ford Falcon 4.0 GLi, Fairmont, Fairmont, Futura XR6 Mpi (96-03), Ranchero 4.0 GLi, Outback, XR6 P/up 250 (97-99), Mercedes-Benz W124 280E M104.942 (86-96), W124 E Class E200 M102.922, E220 M111.960, E320 Sportline, M104.992 (93-96), R170 SLK200, SLK320 M112.947 (97-02), R170 SLK200K M111.958, SLK320, SLK32 AMG M112.960 (02-04), W202 C-Class C180 Classic M111.920, C200 M111.941, C220 M111.961, C230 M111.974, C240 M111.944, C250 M605.910, C270CDi M612.962, C280 M104.941 (94-08), W208 CLK230, M111.973, CLK320, M112.940, CLK430, CLK500 (98-03), W210/211 E-Class E200, K M111.941/956, E230 M111.970, E240 M112.911, E280 M112.921, E320 M112.941, E320CDi OM646.961, E350 M272.964, E500 M113.967 (96-10), W212 E-Class E200, Cgi, E250, CDi, Cgi, E350, Cdi, E400, E500 (2009-), Kombi T2 2.0, L Exec., Microbus, Kamper, P/up, P/van CU, CJ Pet., T3 1.9 Microbus, P/van DG Pet. (84-89), T3 1.8 P/van, GUS, Volksiebus AAX Pet. (89-99), T3 2.1 Fi Caravelle, Microbus DJ Pet., 2.3i Microbus, Volksiebus AFU Pet., 2.5i Microbus, Caravelle AAY Pet., 2.6i Microbus, Caravelle, Exclusive, ADV Pet. - 4X2 (85-04)
<b>12711+49</b>	Rear Wheel Bearing Outer	Chrysler Grand Voyager 3.3, Voyager 2.0, 2.4, 2.5, 3.3 (97-04)



## BUYERS GUIDE - LOOSE BEARINGS

<b>12807S</b>	Front Wheel Bearing Inner	Nissan Datsun Go/ Go+ 1.2 HR12DE (2014-), Renault Clio I, II 1.2 Authentique, Expression, Generation, Va Va Voom D4F706, 1.4 Alaise, Privilege, Expression, RT, Va Va Voom K4J7/EJ634, 1.5 DCi Expression., K9K700/-702, 1.6 Expression, Dynamique, Privilege, Sport K4M744/ -745/-748, 2.0 Sport F4R, 3.0 V6 Sport F7R (99-09), Kangoo 1.4 Express van E7J780, 1.5dCi Express van K9K700 (01-10), 1.4 Multix Authentique MPV E7J780, 1.5DCi (03-10), Laguna I 1.6 RT, RTE K4M720, 1.8 RN, RN Estate, Authentique, Expression F4P7 RT B568/-9F3P/-P6, 1.9dCi F9Q716, 2.0 RT, RT Estate, RXE, Expression K4M720/724, N7Q700, 3.0 Privilege, RXT L7X731 L7X700 (96-07), Megane I 1.6 Classic RXE, RT, RXT, RSi Coupe, RN Hatch, RT Coupe, Hatch, RXE, RXI Cabriolet K7M700/ 02/-03, 2.0 Coupe 8/16V F3R710/50, RXE, RSi Coupe, Cabriolet F3R796/ -7/-8 (96-02), Megane II 1.4 Authentique, Dynamique E7J626/-50 (02-10), Sandero 1.4 Authentique, 1.6 Cup, Dynamique, Expression, Pack (09-15), Scenic I 1.4 RTE, 1.6 RT, RXE, 1.9 dCi, 2.0 RXE, Rxi (98-02), Scenic II 1.4 Authentique K4J750 (01-04)
<b>14276+14138A</b>	Front Wheel Bearing Inner	Kia K2500i 2.5i D4CB (2013-), K2700i 2.7D Workhorse LWB Dies."Bakkie" D/S (2004-)
<b>14585+25</b>	Front Wheel Bearing Inner	Kia Carnival 2.5, 2.9 (00-04)
<b>15123+15245</b>	Front Wheel Bearing Inner	Toyota Hiace, Hilux 1.5, 1.6 (69-77 )
<b>15123+15245</b>	Front Wheel Bearing Inner	Toyota Hiace, Hilux 1.5, 1.6 (69-77)
<b>15578+20</b>	Front Wheel Bearing Outer	Kia Carnival 2.5, 2.9 (00-04)
<b>1700289</b>	Rear Wheel Bearing Inner	Ford Cortina MkIII 1.6 L P/up Kent, 1.6 L, Std., XL Kent, 2.0 OHC GT, V4 L, XL, S/W Essex EV20, 2.0 V4 P/up Koln T20, 2.5 L P/up Essex EV25, 2.5 XL, S/W Essex EV25, 3.0 GT, L, XL, XLE "Big Six" Essex EV30 (71-77), Cortina MkIV 1.3 L Kent, 1.6 GL, L, S/W Kent, 1.6 P/up Kent, 2.0 GL, GLE, S/W Koln T20, 3.0 V6 Ghia, GLS, S, S/W Essex EV30, 3.0 V6 Leisure, P/up Essex EV30 (77-80), Cortina MkV 1.3 L Kent, 1.6 GL, L, Kent, 1.6 P/up Kent, 2.0 Ghia, GL Koln T20, 2.4 P/up York D24, 3.0 V6 GLS, GLS XR6, Essex EV30, 3.0 V6 Leisure P/up Essex EV30 (80-86), Nissan Laurel C31 2.0 CA/L20, 2.8 SGL 5L28 (80-87), Skyline R30 1.8 L18, 2.0 GL L20, R31 2.0 GL, GLE CA20 (82-92), Opel Rekord 2.0 Berlina, GL, GLS, L, S/W CIH, 2.0i CLE, CLS, GL, GLE, Irmscher, 2.2E CIH, 380i, V6 CD, GSi 38GE (82-95), Toyota Corolla RWD TE31 1.6 Sprinter, SR4/5, Black Hawk, Silver Wolf 2T, AE/TE71 1.6 GL, S/W, GLS Sprinter, SE 2T, TB TE72, 1.8 GLS, SE 3T (80-88), Cressida TX30 1.8 DX 3T, TX62 1.8 L, LS 3T, YX70 1.8 LS, Exec. (80-89), TX30 1.8 DX 3T, TX62 1.8 L, LS 3T, YX70 1.8 LS, Exec. (80-89), RX72 2.4 GL, GL S/W, GLE, GLE S/W 22R (87-92)
<b>17831+887</b>	Diff. Carrier Bearing	Mitsubishi Colt LDV 1.6, 2.0, 2.5, d, 2.6, 2.8D, TD (94-09), L300 1.6 (82-86), Colt LDV 2.4i, 2.8D, 3.0i - 4X4 (98-07), Pajero 1.6, 1.8 (99-04), Nissan E20 1.5, 1.6, 2.0 (73-81), Hardbody 2.4, 2.4i, 2.7, 3.0, 3.0D, 3.2, 3.2D, 3.3 - 4X4 (1991-), Patrol 3.0, 4.2 (94-04), Safari 2.8 (80-84), Sani 2.4 (91-94), Terrano II 2.7 (00-02), Toyota Cressida 2.0, 2.6 (76-81), Condor 1.8, 2.0i, 2.4i, 3.0 (00-05), Hiace 1.6, 2.0, 2.2 (69-88), Hilux 1.6, 1.8, 2.0, 2.2, 2.4, 2.7, 3.0 (69-05), 2.0, 2.2, 2.4, 2.7i, 2.8, 3.0i (79-05), Stallion 1.5 (87-91), Stout 1.9, 2.0 (62-89), Tuv 1.3, 1.5 (82-87), Condor 2.4i, 3.0 - 4X4 (00-05), Land Cruiser 3.0, 3.4, 3.6, 3.9, 4.0, 4.2 (69-04), RAV4 1.8, 2.0 (03-06)
<b>25469C</b>	Rear Wheel Bearing Inner	Mercedes-Benz 200E, 220E, 230E, 260E, 280E, 300D, 320E (86-96), W202/3 C-Class 180, 200, 220, 230, 240, 250, 280 – Only S/W Models (94-08)
<b>25520+25590</b>	Front Wheel Bearing Outer	Mahindra Bolero 2.5 TD XD3, 2.5 TD NEF, Scorpio 2.0, 2.2, 2.2 CRDE, 2.5 NEF, 2.6 Turbo, 2.6 TD /CRDE - 4X2, 4X4 (2005-), Scorpio P/up 2.2 CRDE, 2.5, 2.5 TD, 2.5 NEF Tci (2006-)
<b>25577+23</b>	Diff. Carrier Bearing	SsangYong Korando 2.9 (97-04), Musso 2.9 (95-04)
<b>2792RS</b>	Alternator/Generator Bearing - Rear	Toyota Conquest/ Tazz 1.6, 1.8 (86-06), Corolla 1.6, 1.8 (85-96)
<b>28985+21A</b>	Diff. Carrier Bearing	Mitsubishi Canter 2.5, 2.6, 3.3, 3.8 (80-97), Toyot Dyna 2.4, 3.0, 3.8, 4.0 ( 85-96)
<b>28985+21SA</b>	Diff. Carrier Bearing	Toyota Dyna 2.2, 3.7 (95-02), Land Cruiser 3.0, 3.4, 4.2, 4.5, 4.7 - 4X4 (97-04)
<b>28KW02</b>	Rear Wheel Bearing Inner	Hyundai Sonata 2.0 (94-96)
<b>29710+48</b>	Front Wheel Bearing Inner / Outer	Nissan Langley 1.5 GL, L, SSS, Trebon, Exa Turbo E15 (83-88), Pulsar 1.4 DL, GX A14, 1.5 GL, Panache, SX E15 (80-87)

## BUYERS GUIDE - LOOSE BEARINGS

<b>29710+49</b>	Front / Rear Wheel Bearing Inner / Outer, Diff. Carrier Bearing	<p>Ford Escort RWD MkI 1.1 Kent, 1.3 GT, L, Super, S/W Kent, 1.6 GT, L, XL Kent (68-75), Escort MkII 1.1 300 P/van Kent, 1.3 30, 35, 45 P/van Kent, 1.6 45 P/van Kent (68-81), Escort RWD MkII 1.3 L Kent, 1.6 GL, Sport Kent, RS2000 Koln (75-81), Escort FWD MkIII 1.3 GL, L Kent, 1.6 GLE, L, Sport, XR3, i HL16CVH (81-86), Escort FWD MkVI 1.4i H/back, Sedan CVH/PTE, 1.6i GL, GLE H/back, Sedan Zetec, 1.8i GLi, TDi H/back, Sedan Zetec, 1.8TDi Endura (95-00), Fiesta I 1.3, i Flair, Flite, Play, Fun Endura-EM5, 1.4, i Flair, Trend, Fun Zetec CVH/PTE, 1.6, i Ambiente', Flair, Forte' Ghia, Rsi, Sport, Trend (97-04), Husky 1.8 1 Ton P/up 4G62, 2.0 1 Ton P/up, Bus, P/van 4G63 (85-99), Ikon 1.3, Low, LX CLTA, 1.6i, Low, High, LX, CLX CLTA (01-06), Mazda 121 Soho 1.3, i 3/5 Dr. H/back Endura-EM5, 1.4i 3/5 Dr. H/back Zetec CVH/PTE (97-99), Mitsubishi L300 1.6 Mini Bus, Van 4G32 Pet., 1.8 4G62 Pet., 2.0 P/up 4G63 Pet., Starwagon 2.0 S, SL, SLE, P/up, P/van 4G63 Pet. (82-01), Nissan Langley 1.5 GL, L, SSS, Trebon, Exa Turbo E15 (83-88), Pulsar 1.4 DL, GX A14, 1.5 GL, Panache, SX E15 (80-87), Stanza 1.6 DL, Resort, S/W L16, 1.8 GL, Resort, S/W SSS L18 (80-84), Toyota Corolla RWD TE31 1.6 Sprinter, SR4/5, Black Hawk, Silver Wolf 2T, AE/TE71 1.6 GL, S/W, GLS Sprinter, SE 2T, TB TE72, 1.8 GLS, SE 3T (80-88), Corolla TE71 1.6 P/van 2T (83-89), KE70 1.3 P/van 4K (84-88), Cressida TX30 1.8 DX 3T, TX62 1.8 L, LS 3T, YX70 1.8 LS, Exec. (80-89), RX60 2.0 GL, GLE, GLX, S/W 21R, RX70, YX72 2.0 GL, GL, GLE, GLX (81-92), VW Caddy 1.6 SWB, Caddy Club P/up JK Dies., HM Pet., 1.8 SWB L, Sport P/up HV Pet. (81-97), Citi Golf 1.6 Blues, Chico, Chico Lux, Deco, Designa, L, Ritz, Shuttle, Sonic, Sport HM, HV, FR, 1.6iL, Life, VeloCiti, TenaCiti, CitiStorm, - Sport, - Rox, Rhythm, MKI AFX, 1.8 CTi, Designa, L Sport BZF (83-09), 1.3 L Shuttle, Chico, Chico Lux ET/ GY/ AJD, 1.4, iL, Chico, Rhythm, Citi com, VeloCiti, TenaCiti, CitiStorm, - Sport, Rox, Rhythm, Wolf, - XCite, Billabong AGY/ BSV (87-09), Fox 1.3 L, L Trippa GY, 1.6 L HM, 1.8 L Sport HV (87-96), Golf I 1.1 GL, L, LS ET/EG, 1.3 GL, L, LS GF (78-84), Golf II 1.3 CL GY, 1.6 CSL HM, 1.8 8/16V CSX, GTS, GTi KR, EV (84-92), Golf III 1.6 GS ACG, 1.8 GSX, GTS ACH, 2.0 GTi, Exec. 2E (92-99), Jetta I 1.5 GLS/ GLX JB, 1.6 GLS EM, 1.8 GLi DX (80-85), Jetta II 1.6 CSL HM, 1.8 8/16V CLi, CLi Exec., CLX, CSi, CSX EV/KR (85-92), Jetta III 1.6 CSL ACG, 1.8 CLX/ CSX ACH, 2.0 CLi, Exec. 2E (92-99), Passat I &amp; II 1.3 L, LS H/back, Sedan, Variant ZF, 1.5 GL, LS Fastback, S/W CK, 1.6 GL, GLS, LS, LX Fastback, S/W, Sedan, Coupe, Variant, YN/YP/WN, 1.8 CL Sedan, S/W JV/KR (74-87), 1.9 GLS H/back, GLX Sedan, S/W WN, 2.2 CLi, CLX SG/MX (81-87)</p>
<b>29710+57410</b>	Front Wheel Bearing Inner / Outer	<p>Hyundai Accent X3 1.3 G4EH, 1.5 G4EK (94-00), Atos 1.0 Prime G4HC (00-05), 1.1 G4HG (2005-), Elantra J1 1.6 Exec. G4CR, 1.8 Exec. G4CN (93-95), S-Coupe 1.5 (94-95)</p>
<b>29711+49</b>	Diff. Carrier Bearing	<p>Ford Bantam 1300 P/up Kent 2V, 1400 Leisure, Nite P/up CVH/FUA, 1600 Leisure Explorer, Nite P/up CVH (83-94), Fiesta I 1.3, i Flair, Flite, Play, Fun Endura-EM5, 1.4, i Flair, Trend, Fun Zetec CVH/PTE, 1.6, i Ambiente', Flair, Forte' Ghia, Rsi, Sport, Trend (97-04), Ikon 1.3, Low, LX CLTA, 1.6i, Low, High, LX, CLX CLTA (01-06), Sierra 1.6 GL, GL S/W, L Kent, 2.0 GL, GL S/W Koln, 2.0 LX Koln, 2.3 GLE, Cologne, 3.0, i GLS, GLX, LX, RS, XR6 Essex (83-93), Mazda 121 Soho 1.3, i 3/5 Dr. H/back Endura-EM5, 1.4i 3/5 Dr. H/back Zetec CVH/PTE (97-99), Rustler 1.3 SWB P/up Kent 2V Pet., 1.4 SWB P/up CVH/FUA Pet., 1.6 SWB, LX P/up CVH/ LUC Pet. (86-94)</p>
<b>300811+49</b>	Front / Rear Wheel Bearing Inner / Outer, Diff. Carrier Bearing / Pinion Bearing	<p>Audi 100/4 1.6 LS YV, 100/5 1.9 WH, 200 2.1 GLS, GLX, 400 1.8 JW, 500 2.1/2.2 WB, WC SE PR (77-92), Audi 500 2.2 E PR, 2.3 E, SE, AAR, 2.8 SEL AAH (92-94), Audi A3 1.8 8L1 AGN, 1.8T AGU, BPU (98-04), A3 2.0 FSi BVZ, 2.0 FSi 8PA Sportback BLX, 2.0 TFSi CCZA, CBFA, 2.0 TDi BMM, CLJA, 3.2 Quattro, DSG, BUB (03-13), 1.4 TFSi CZCA, CZEA, 2.0TDi CRFC (13-17), A4 1.8T Avant, Multitronic, BFB, B6 AVJ 8E2, 1.9 TDi AVF, Avant B6, 8E5, 8E2, 2.0 Multitronic Avant 8EC, 8E2 ALT, 2.0 TDi 125, 8EC BLB, Avant Multitronic, 2.0TFSi DTM 147 BGB (00-08), 3.2 FSi Quattro, 8EC Multitronic Avant, Tiptronic Avant, AUK (01-08), 2.5 TDi 8D/E2 Quattro AFB, Quattro Tiptronic, 2.6 8D2 / 8D5 Exec. (95-00), 3.0 Quattro Tiptronic, ASN (02-08), A6 2.8 Quattro 4A, AAH, ACK, 3.0 Quattro Tiptronic BBJ (94-00), 2.4 Avant Multitronic., Tiptronic, AGA, ALF, AML, APS, ARJ, 2.5TDi Multitronic Avant SW., BCZ/BDG/BFC, 2.6 ABC (97-03), 2.7T Quattro AJK, ARE, BES (00-06), 4.2 Quattro Tiptronic ARS (00-08), A8 3.7 Tiptronic AQG, 4D2, 4.2 Quattro 4E2/8 BFM (95-02), S3 1.8T 8L1 Quattro AMK, BAM, APY (00-04), S4 2.2T Quattro AAN (92-95), 4.2 Quattro, Avant 8E2/E5, S/W, BBK, AQF (03-08), TT 1.8T Coupe, Sport, Roadster, Coupe 8N3/9 APX, 1.8T Quattro APX, BAM, BFV (00-07), TT 2.0 TFSi BWA, 2.0 TTS Quattro CDLA, CDMA, 3.2 Coupe, Roadster DSG, BHE, BUB (04-10), 1.8 TFSi CDAA, 2.0 TFSi Quattro CCSA, CETA, 2.5 RS Quattro CEPA (10-15), Ford Focus I 1.6i 4/5 Door, Ambiente' Zetec S, 1.8 TDCi F9DA, F9DB, 2.0i 4/5 Door, L Trend, RS, ST170 Zetec E (00-05), Mercedes-Benz W123 200 M115.938/9, 230, E M115.954, 240D M616.912, 250 M123.920/1, 280E M110.983, 300D M617.912 (77-86), W126 280SE M110 987/9, 300SE M103.981, 380SE M116.963, 420SE M116.965, 500SE M117.965 (86-93), W123 200 M115.938/9, 230, E M115.954, 240D M616.912, 250 M123.920/1, 280E M110.983, 300D M617.912 (77-86), W126 280SE M110 987/9, 300SE M103.981, 380SE M116.963, 420SE M116.965, 500SE M117.965 (86-93)</p>

# BUYERS GUIDE - LOOSE BEARINGS

<p><b>300811+49</b></p>	<p>Front / Rear Wheel Bearing Inner / Outer, Diff. Carrier Bearing / Pinion Bearing</p>	<p>Nissan 1-Tonner/Hardbody AW/D21 2.4 Z24S, 2.7 TD27, 3.0 VG30E - 4X4 (88-98), 720 D20 1.8 L18S, 2.0 NA20, 2.2 Z22 - 4X4 (80-88), Hardbody QW/D22 2.4i KA24E, 2.7 TD27, 3.0 VG30E, 3.0TD ZD30, 3.2, 3.2D QD32, 3.3i VG33 - 4X4 (98-10), NP300 D22 2.0i, S, SE KA20, 2.4i, S/C, D/C Highrider KA24 DE, 2.5TDi, S, SE YD25, 2.5TDi, S, SE Highrider YD25 - 4X2, 2.4i, S/C, D/C, Highrider KA24 DE, 2.5TDi, S, SE, Highrider YD25 - 4X4 (2008-), Patrol Y60 3.0 VG30E - 4X4 (95-00), Y61 3.0Di, 4.2 TD42 - 4X4 (99-04), Sani AW/D21 2.2 Z22, 2.4 Z24, 2.7 TD27, 3.0 VG30E - 4X4 (86-98), Terrano II 2.7 TD27 - 4X4 (00-02), Seat Altea 2.0FSi Tiptronic, 2.0TDi Man., DSG Auto. (06-09), VW Beetle 2.0i Cabriolet, Highline AZJ (00-12), Caddy 1.6i Club, Citi, P/up HM Pet (97-03), 1.9TDi Life, Maxi Van, MPV BJB, 2.0SDi Van, P/van BDJ (2004-), Golf II 2.0 8/16V GTi AAL (84-92), Golf III 2.8 VR6, Exec. AAA (92-99), Golf IV 1.6i Comfortline, Std., Estate AKL, 1.8, T GTi, Highline AGU/ AGN, 1.9 TDi Highline, Estate AHF, 2.0i Cabrio, Highline APK (99-04), VW Golf V 1.6i Comfortline, Tiptronic, Trendline BGU, 1.9TDi Comfortline, Highline, 2.0i Comfortline, GTi, GTi Trendline DSG/ AXX/BWA, 2.0FSi Sport, Sport Tiptronic AXW, 2.0TDi, Sport DSG/ BKD (04-09), Golf VI 1.4TSi Comfortline, Trendline, Highline, 1.6i Comfortline, Trendline, 1.6TDi, 2.0i GTi, Tiptronic, 2.0TSi 4Motion, 2.0TDi Highline, DSG (09-13), Jetta II 2.0 8/16V CLi, Exec. AAL (85-92), Jetta III 2.8 VR6 Exec. AAA (92-99), Jetta IV 1.6i Comfortline, Std. AKL, 1.8T Highline, Exec AGU, 1.9 TDi Highline AHF, 2.0i Highline APK, 2.3 V5 AGZ (99-06), Jetta V 1.9TDi Comfortline, Comfortline DSG, 2.0i Trendline, Comfortline, 2.0FSi Sportline, 2.0 T FSi Sportline DSG, 2.0TDi Sportline (2006-), Kombi T2 2.0, L Exec., Microbus, Kamper, P/up, P/van CU, CJ Pet., T3 1.9 Microbus, P/van DG Pet. (75-89), T3 1.8 P/van, GUS, Volksiebus AAX Pet. (89-99), T3 2.1 Fi Caravelle, Microbus DJ Pet., 2.3i Microbus, Volksiebus AFU Pet., 2.5i Microbus, Caravelle AAY Pet., 2.6i Microbus, Caravelle, Exclusive, ADV Pet. - 4X2 (85-04), 2.1 Fi Syncro Caravelle DJ Pet. - 4X4 (89-93), Passat I &amp; II 1.3 L, LS H/back, Sedan, Variant ZF, 1.5 GL, LS Fastback, S/W CK, 1.6 GL, GLS, LS, LX Fastback, S/W, Sedan, Coupe, Variant, YN/YP/WN, 1.8 CL Sedan, S/W JV/KR (74-87), Passat IV 2.3 V5 AZX (03-05), 2.8, 4 Motion, Quattro, Tiptronic ACK/ AMX (99-05), Passat V 1.9TDi Comfortline AVB, 2.0FSi Comfortline, Tipt., Highline BCR BLY, 2.0 T FSi Sportline Tiptronic AXX/BPY, 2.0TDi Highline, DSG BKP/BMP, 3.2 V6 Auto. DSG (05-11), Polo 6N 1.4 Classic, Playa Lux AEX, 1.6 Classic, Playa, Lux AEE, 1.8 Classic, Playa, Lux ADZ (96-03), Polo 9N 1.4TDi, Classic, Trendline AMF, 1.4TDi Classic, Trendline ARC, 1.4i Trendline, Comfortline, AUA/ BBy, BLM, 1.6i Comfortline, SE, Classic Comfortline, Tipt Trendline, Classic Lux BTS/ AFV, BAH, 1.8T GTi, Classic Trendline AKK, 1.9TDi Highline, Classic Highline, Sportline, ATD/ AXR, 2.0i Highline, Classic Highline BBX, Cross Polo 1.6TDi, 1.9TDi (02-10), Scirocco 1.4TSi, 2.0TSi, DSG, 2.0TSi R (2009-), Tiguan 2.0TSi Track&amp;Field, Sport&amp;Style Man., Tiptronic 5Dr. SUV, 2.0TDi Track&amp;Field, Sport&amp;Style Man., Tiptronic 5Dr. SUV - 4X4 (08-17), Tou-ran 1.9TDi TrendLine DSG MPV, 2.0FSi HighLine MPV AXW, 2.0TDi HighLine, DSG MPV (04-11)</p>
<p><b>300816+49</b></p>	<p>Diff. Carrier Bearing</p>	<p>Mercedes-Benz C180, C200, C220, C230, C240, C250, C270, C280, C320 (94-08), CLK230, CLK320 (1998-), E200, E220, E230, E240, E270, E280, E320, E500 (96-04), SLK200 (97-04)</p>
<p><b>30303D</b></p>	<p>Front Wheel Bearing Outer</p>	<p>Toyota Landcruiser - Free Wheel Hub Bearing X 4 - Broad Base To Cone &amp; Cup &amp; Acute Angle To The Rac</p>
<p><b>30303DP</b></p>	<p>Front Wheel Bearing Outer</p>	<p>Toyota Land Cruiser - Free Wheel Hub Bearing X 4 - Broad Base to Cone &amp; Cup &amp; Acute Angle to the race.</p>
<p><b>308+203</b></p>	<p>Rear Wheel Bearing Outer</p>	<p>VW Kombi T2 2.0, L Exec., Microbus, Kamper, P/up, P/van CU, CJ Pet., T3 1.9 Microbus, P/van DG Pet. (75-89)</p>
<p><b>309245ASB</b></p>	<p>Rear Wheel Bearing Inner</p>	<p>BMW 3 Series F30/1 316i N13B16A, 320i 2.0 N20, 328i 2.0 N20, 330d 3.0 N57D30A, 335i 3.0 N55B30A, F34 320i GT, 320d GT N47D20C, 328i GT N20B20A, N26B20A, 335i GT N55B30A (2012-)</p>
<p><b>309245TAP</b></p>	<p>Front Wheel Bearing Inner</p>	<p>Mercedes-Benz A160, A190 (00-04)</p>
<p><b>309609C</b></p>	<p>Rear Wheel Bearing Inner</p>	<p>BMW 520i, 525e, 525i, 528i, 535i, 540i (85-94), 735i, 745i (81-87), M5 (86-94)</p>
<p><b>309639ASB</b></p>	<p>Front Wheel Bearing Inner</p>	<p>Ford B-Max 1.0 EcoBoost M1JE, M1JH (2015-), Ecosport 1.0i EcoBoost Petrol, M1JC, 1.5 TDCi Diesel, UGJE, 1.5i Petrol, UEJB (2013-), Fiesta II 1.4i Trend Zetec, 1.6i RSi, TDCi Rocam, 2.0 ST, ST150 (04-09), Fiesta III 1.0 EcoBoost, 1.4 Sedan, 1.4i Ambiente', Trend, Titanium, 1.6 Limited, 1.6i Ambiente', Sport, Trend, Titanium, TDCi, 1.6 Gtdi (2008-), Figto 1.4 Ambiente', Trend, FXJA/B, 1.4 TDCi Ambiente', F6JB/D (2010-), Focus I 1.6i 4/5 Door, Ambiente' Zetec S, 1.8 TDCi F9DA, F9DB, 2.0i 4/5 Door, L Trend, RS, ST170 Zetec E (00-05), Ikon 1.3, Low, LX CLTA, 1.6i, Low, High, LX, CLX CLTA (01-06), 1.4, Low, LX, 1.4 Tdci, 1.6i (07-11), Ka 1.3i Ambiente, Trend, Collection Rocam A9A, A9B (05-09), Mazda 2 (DE) 1.3 Active, Dynamic, 1.5 Dynamic, Individual (07-15), VW Polo 1.2 Trendline DSG Petrol CBZB, 1.2 Man. CGPA/ CGPB (10-15), 1.2TSi Comfortline Man. CBZC (2013-), Polo 6C 1.0TSi CHZB, CHYA, CHYB, 1.2TSi CJZC/ CJZD, 1.4 CDDA/ CGGB/ CLPA, 1.4TDi CUTA/ CYZB, 1.5TDi CWXC, CWXB, 1.6TDi CLSA, 1.8TSi GTi DAJA (2014-)</p>



## BUYERS GUIDE - LOOSE BEARINGS

<b>30KWD01A</b>	Rear Wheel Bearing Inner	Mazda 626 2.0i 16V SLi FE (Rear Disc brakes) (89-93)
<b>319 2RS</b>	Alternator/Generator Bearing	Toyota Conquest 1.6, 1.8 (86-02), Corolla 1.6, 1.8 (85-96)
<b>32006JR</b>	Rear Wheel Bearing Inner	Toyota Cressida 2.0, 2.4, 2.8i, 3.0, 3.0i (82-92)
<b>32007X</b>	Front wheel brg. Inner	GWM Standard, Lux 2.2 (2007-)
<b>32007XP</b>	Front Wheel Bearing Outer	Daihatsu Feroza 1.6 (98-99)
<b>32008+57407</b>	Diff. Carrier Bearing	Nissan Sentra 1.8i (89-92)
<b>32008CP</b>	Front Wheel Bearing Inner	Daihatsu Feroza 1.6 (98-99)
<b>32009XJ</b>	Front Wheel Bearing Inner	Isuzu KB200i, KB240i, KB250, DC, KB300TDi - All With ABS - 4X4 (2004-)
<b>32010X</b>	Diff. Carrier Bearing	Nissan Sentra 1.6, 2.0 (92-02), VW Kombi 1.6, 1.7, 1.8, 1.9, 2.0, 2.0L, 2.1 Fi, 2.3i, 2.5i, 2.6i (72-04), 2.1 Fi - 4X4 (72-04)
<b>32012X</b>	Diff. Carrier Bearing	Nissan Sani 2.4, 2.5, 2.7, 3.0 (89-99), Hardbody 1.6, 1.8, 2.0, 2.4, 2.5, 2.7, 3.0 (88-98), 2.4 - 4X4 (88-98)
<b>32308CS</b>	Diff. Pinion Bearing Rear	Mitsubishi Colt LDV 2.8D (1999-)
<b>329149+0017</b>	Diff. Pinion Bearing Rear	Ford Fiesta 1.3, 1.3i, 1.4i, 1.6i (97-08), Ikon 1.3i, 1.6i (01-06), Ka 1.3i (2005-), Bantam 1.6i, 1.8di (2003-), Mazda 121 Soho 1.3, 1.4 (97-99)
<b>330757C+VQ051</b>	Diff. Pinion Bearing Front	VW Citi Golf 1.3, 1.4, i, 1.6, i, 1.8 (85-09), Fox 1.6, 1.8 (87-95), Golf I 1.5, 1.6, 1.8 (78-85), Golf II 1.3, 1.6, 1.8, 2.0 (84-92), Jetta I 1.5, 1.6, 1.8 (80-85), Jetta II 1.6, 1.8, 2.0 (85-93)
<b>331459P</b>	Rear Wheel Bearing Inner	Volvo 960 2.9 (94-97)
<b>3525+79R</b>	Front Wheel Bearing Inner	Toyota Dyna 2.0, 2.2, 2.4, 3.0, 3.7, 4.0 (85-02)
<b>3563-RS-2</b>	Front Wheel Bearing Outer	Toyota Dyna 3.0, 3.8, 4.0 (85-96)
<b>358021P+C4</b>	Rear Wheel Bearing Inner	Daihatsu Feroza 1.6 (98-99)
<b>35BW05</b>	Rear Wheel Bearing Outer	Nissan Skyline 2.0, 3.0 (87-92)
<b>35BW10</b>	Rear Wheel Bearing Inner	Toyota Condor 1.6 Estate, TE, 5L, 1.8 2Y, 2.0i Estate, TE, 1RZ Pet., 2.4i Estate, TE, TX 2RZ-E, .0D Estate, TE, 5L Dies. - 4X2, Condor 2.4i Estate, TX Estate 2RZ-E, 3.0 Estate, TX Estate 5L - 4X4 (00-05)
<b>362351B</b>	Diff. Pinion Bearing Rear	Ford Bantam 1.3, 1.4, 1.6 (83-94), Mazda Rustler 1.3, 1.4, 1.6 (85-94)
<b>3680+3580</b>	Diff. Pinion Bearing Rear	Toyota Fortuner 2.4, 2.7i, 2.8TD, 3.0D-4D, 4.0 - 4X4 (15-16), Hilux "Revo" 2.0, 2.4, 2.8, 4.0 - 4X2, 4X4 (2016-)
<b>38BWD15A</b>	Use - 38003	
<b>3920/94</b>	Rear Wheel Bearing Inner	Toyota Dyna 3.0, 3.8, 4.0 (85-02)
<b>40206GBP</b>	Front Wheel Bearing Inner	Fiat Ulysse 2.0 (99-01)
<b>40246ASB</b>	Front & Rear Wheel Bearing Inner	Fiat Ulysse 2.0 MPV (99-02), Land Rover Freelander 1.8i, 2.0, 2.5 - ASB (98-04)
<b>40574X</b>	Front Wheel Bearing Inner	Citroe C4 1.6, HDi, 2.0 (01-09), C5 2.0, 3.0 (01-05), Peugeot 207 1.4 Some, 1.6 (2006-), 307 1.6, 2.0 (01-08), 308 1.6i (2008-)
<b>40582P</b>	Front Wheel Bearing Inner	Peugeot 306 1.6, 2.0 (95-03)
<b>40652SP</b>	Rear Wheel Bearing Inner	Fiat Doblo 1.9 (03-06)
<b>40747P</b>	Front Wheel Bearing Inner	Alfa Romeo 147 1.6, 1.9, 2.0 (01-10)
<b>4076+5076</b>	Diff. Pinion Bearing Rear	Toyota Fortuner 2.4, 2.7i, 2.8TD, 3.0D-4D, 4.0 - 4X4 (15-16), Hilux "Revo" 2.0, 2.4, 2.8, 4.0 - 4X2, 4X4 (2016-)
<b>409026RS</b>	Rear Wheel Bearing Inner	Toyota Quantum 2.5 D-4D, "Family", S-long MPV, Van 2KD-FTV Dies., 2.7 "Family", S-long "Ses'fikile" MPV, Van 2TR-FE Pet. (2005-)
<b>40BCV09</b>	Rear Wheel Bearing Inner	Toyota Fortuner 3.0 D-4D SUV 1KD-FTV, 4.0 V6, Epic SUV 1GR-FE Pet. - 4X2, 4X4 (06-09), Hilux RZN169 2.7i LWB D/cab, DLX S/cab, Raider S/D/cab, SRX D/cab, Legend 35 LWB P/up 3RZFE Pet. - 4X4 (98-05), LN167 3.0D D/cab D-E, DLX, S/D/cab DE, Raider DE, Legend35 LWB P/up 5L Dies., 3.0iD LWB Raider S/cab & KZ - 4X4 (98-05), Hilux "VIGO" 2.0i U16/17 S/Cab, S, SRX LWB Pet. P/up 1TR-FE Pet., 2.5TDi D-4D S/Cab, S, SRX, S/Cab, S/Cab SRX HO, Raised Body Raider, D/Cab LWB 2KD-FTV, 3.0 D-4D TDi Raider, D/C Raider, Raised Body LWB P/up 1KD-FTV Dies., 4.0i D/Cab Raider Raised Body LWB P/up GR-FE Pet. - 4X2, 3.0 D-4D TDi D/C Raider 1KD-FTV Dies., LWB P/up, 4.0 D/Cab Raider 1GR-FE Pet. LWB P/up - 4X4 (05-09), 2.7i S/Cab Raider, D/Cab Raider, S/Cab HO Raised Body LWB P/up 2TR-FE Pet. - 4X2 (05-11), 2.5TDi D-4D S/Cab, D/Cab SRX, Legend40 2KD-FTV Dies. LWB P/up, 2.7i S/Cab SRX, Legend40 2TR-FE Pet. LWB P/up - 4X4 (05-15)

## BUYERS GUIDE - LOOSE BEARINGS

<b>40BWD06</b>	Front / Rear Wheel Bearing Inner	Audi A3 1.8 8L1 AGN, 1.8T AGU, BPU (98-04), A4 1.8T Avant, Multitronic, BFB, B6 AVJ 8E2, 1.9 TDi AVF, Avant B6, 8E5, 8E2 (00-08), S3 1.8T 8L1 Quattro AMK, BAM, APY (00-04), TT 1.8T Coupe, Sport, Roadster, Coupe 8N3/9 APX, 1.8T Quattro APX, BAM, BFV (00-07), Kia Clarus 2.0 GLX 4 Dr. Sedan FE (98-01), Sephia 1.5i LS, RS 4 Dr. Sedan BFD (04-05), Shuma I 1.5i LS 4 Dr. Sedan BFD, 1.8i GS 5 Dr. H/ back TBD (98-01), Spectra 1.6 Exec. A6 (01-03), Mazda 323 FWD 2.0 EGi Hatch, SLE Hatch, SLi Sedan, 200e Hatch, Sedan, 200i Hatch 8/16V FE-2000 (89-95), 130 Hatch, Midge, Sedan, Sting B3, 160, i, S Hatch, Midge, Sedan, Sting F6, 200i, e Hatch 8/16V FE 2000 (95-05), VW Beetle 1.8T Coupe APH, 2.0i Cabriolet, Highline AZJ (00-12), Golf IV 1.6i Comfortline, Std., Estate AKL, 1.8, T GTi, Highline AGU/ AGN, 1.9 TDi Highline, Estate AHF, 2.0i Cabrio, Highline APK (99-04), Jetta IV 1.6i Comfortline, Std. AKL, 1.8T Highline, Exec AGU, 1.9 TDi Highline AHF, 2.0i Highline APK, 2.3 V5 AGZ (99-06)
<b>40BWD12</b>	Front Wheel Bearing Inner	Toyota Avensis 2.0i Advanced, 2.2 D4D Exclusive, 2.4i Exclusive (06-09), Corolla FWD F11 140i GLE, GLS, Sprinter 4ZZ-FE, KS1 160i GLE, GLS, GSX, Sprinter VVT-i 3ZZ-FE DOHC, GF2 180i GLE, GLS, GSX, Sprinter VVT-I 1ZZ-FE DOHC (02-08), 2.0, 2.0D D-4D Advanced, Exclusive (07-14), Corolla Verso ZZE122 160i S, SX MPV, 180i SX, SX MMT, TX, TX MMT MPV 1ZZ-FE (04-09), Runx 140i RT, RS, Sport 4ZZ-FE, 160i RS, RT, RX, Sport 3ZZ-FE, 180i RSi, RX 1ZZ-FE (03-08)
<b>40BWD15A</b>	Front Wheel Bearing Inner	Nissan Almera 1.6 Comfort, Elegance, Luxury 16DE/GA16DE, 1.8 Elegance, Luxury 18DE (01-06)
<b>416359+147197</b>	Diff. Pinion Bearing Rear	VW Sharan 1.8T, 1.9, 2.8 (99-09)
<b>42BWD06</b>	Front Wheel Bearing Inner	Nissan Maxima GV Series 300SE VG30E (91-97), CA33 & QX Series 2.0 VQ20E, 3.0 VQ30DE (96-04), Primera 160 Si, SE SR16DE, 200 GSi, Si, STi, Elegance, Luxury SR20DE (98-02)
<b>42KWD01</b>	Diff. Carrier Bearing	Nissan Maxima 2.0 (97-04)
<b>43BWD06</b>	Front Wheel Bearing Inner	Toyota Camry I SXV10/11 R 200i Si 3S-FE, 220 SEi, Si, 5S-FE (92-01), MCV10/ VCV10 300SEi 1MZF-FE / 3VZ-FE, Quad Cam (94-01), Rav4 II ZCA20 1.8 SUV 1ZZFE, ACA20 2.0 SUV 1AZ-FE - 4X2, 4X4 (02-06)
<b>43BWD12</b>	Front Wheel Bearing Inner	Nissan X-Trail T30 2.0 QR20DE MPV, 2.0 MPV 20DE, 2.2D SE, SEL MPV, 2.5 25DE MPV - 4X2, 4X4 (01-09)
<b>43BWD12</b>	Front Wheel Bearing Inner	Nissan X-Trail 2.0, 2.2D, 2.5 (01-08)
<b>43KWD07</b>	Front Wheel Bearing Inner	Toyota Hilux "VIGO" 2.0i U16/17 S/Cab, S, SRX LWB Pet. P/up 1TR-FE Pet., 2.5TDi D-4D S/Cab, S, SRX, S/Cab, S/Cab SRX HO, Raised Body Raider, D/Cab LWB 2KD-FTV - 4X2 (05-09), 2.7i S/Cab Raider, D/Cab Raider, S/Cab HO Raised Body LWB P/up 2TR-FE Pet. - 4X2 (05-11), 2.0i S/Cab, S, SRX LWB Pet. P/up 1TR-FE Pet., 2.5TDi D-4D S/Cab, S, SRX, S/Cab, S/Cab SRX HO, Raised Body Raider, D/Cab LWB P/up 2KD-FTV, 2.7i Raised Body Raider, D/Cab LWB P/up 2TR-FE Pet. (09-11), Hilux 2.0 VVTi 1TR-FE 5 Spd Man. S/cab, 2.5D-4D Raised Body 2KD-FTV 5 Spd Man., 2.5D-4D Std. Body 2KD-FTV 5 Spd Man. - 4X2 (11-16), Hilux "REVO" 2.0 VVTi 1TR-FE, 2.4 GD-6 2GD-FTV - 4X2 (2016-)
<b>44610+43</b>	Various Trailer Applications	Various Trailer Model Applications
<b>44610+43L</b>	Various Trailer Applications	Various Trailer Model Applications (Seal is attached to the side of the bearing)
<b>44610+49</b>	Front, Rear Wheel Bearing Inner	Ford Cortina MkIII 1.6 L P/up Kent, 1.6 L, Std., XL Kent, 2.0 OHC GT, V4 L, XL, S/W Essex EV20, 2.0 V4 P/up Koln T20, 2.5 L P/up Essex EV25 (71-77), MkIV 1.3 L Kent, 1.6 GL, L, S/W Kent, 1.6 P/up Kent, 2.0 GL, GLE, S/W Koln T20 (77-80), MkV 1.3 L Kent, 1.6 GL, L, Kent, 1.6 P/up Kent, 2.0 Ghia, GL Koln T20, 2.4 P/up York D24 (80-86), Escort RWD MkI 1.1 Kent, 1.3 GT, L, Super, S/W Kent, 1.6 GT, L, XL Kent (68-75), MkI/II 1.1 300 P/van Kent, 1.3 30, 35, 45 P/van Kent, 1.6 45 P/van Kent (68-81), Escort RWD MkII 1.3 L Kent, 1.6 GL, Sport Kent RS2000 Koln (75-81), Hyundai Atos 1.0 Prime G4HC (00-05), 1.1 G4HG (2005-), Kia Pride 1.3i LX 5 Dr. H/back, Rio I 1.3 5 Dr. H/back A3E, 1.5 5 Dr. H/back A5D (98-04), Mazda 323 FWD 1.3 S, H/back, Sedan E3, 1.5 GLC, SL, SLX, Sport H/back, Sedan E5 (81-88), 1.3 L, H/back, Sedan E/B3, 1.5, L H/back, Sedan E5, 1.6 EGi Hatch, L, Sedan, SL Hatch, SL Sedan, Sport Hatch B6i/F6 (84-91), 130 Hatch, Midge, Sedan, Sting B3, 160, i, S Hatch, Midge, Sedan, Sting F6, 200i, e Hatch 8/16V FE 2000 (95-05), 626 1.6 S Sedan, Hatch F6, 1.8 L Sedan, Hatch F8, 2.0 SL, SLE, SLX, 2.0i EGi, SLi FE (Rear Drum brakes) (83-93), Nissan B140 1.4 A14SP/van, S/W, Deluxe, Std. Sport, CHAMP P/up (80-08), Toyota Corolla TE71 1.6 P/van 2T (83-89), Tuv KF20 1.3 Chassis Cab, P/up, P/van, Bus 4K Pet., 1.5 P/up 5K Pet. (82-87)

## BUYERS GUIDE - LOOSE BEARINGS

<b>447318B</b>	Front Wheel Bearing Hub	BMW 3 Series E36 316i 1.8 Dolphin Shape M40, 318i 1.9 M44, 320i 2.0 M50, 323i 2.5 M52, 325i M50, 328i 2.8, 3.0 M52, Z3 2.8, 3.0 Roadster (92-00), E37 M3 M Coupe S50 (93-01), E46 316i 1.8 M40, 318i M43, 320i, d M54/47, 323i M52, 325i, it M50, 328i M52TU, 330d 3.0 M57, 330i, Ci, 3.0 M54 (98-05), 5 Series E34 520i 2.0 M50, 525i 2.5 M50, 530i 3.0 M60, 535i 3.5 M30, 540i 4.0 M60 (90-00), 7 Series E32 730i M30/60, 735i M106, 740i M60, 750iL M70 (92-95), 8 Series E31 850iL V12 M70 (91-94), M5 Coupe M30, M5 Coupe MS38 (86-94)
<b>44KB721</b>	Diff. Carrier Bearing	Toyota Camry 2.0, 2.2 (92-01)
<b>44KB721</b>	Carrier Brg.	Toyota Camry 2.0, 2.2 (92-01)
<b>45220+90</b>	Rear Wheel Bearing Outer	Toyota Dyna 3.0, 3.8, 4.0 (85-02)
<b>45220+90</b>	Rear Wheel Bearing Outer	Toyota Dyna 3.0, 3.8, 4.0 (85-99)
<b>453+469</b>	Rear Wheel Bearing Inner	Toyota Dyna 2.2, 3.7, 4.0 (95-02)
<b>45BWDVER</b>	Front Wheel Bearing Inner	Lexus RX 300, 350, 400, 450 (2003-), Mazda 6 2.0 Active, Original, Elegant, 2.3 Dynamic, Dynamic Individual, Sporty, Sporty Lux, 2.3 MPS AWD, 2.5 Dynamic Activematic, Individual (03-14), CX-7 2.3 L3-VDT AWD, 2.5 L5-VE (07-12), CX-7 2.3 L3-VDT - 4X4 (07-12), Toyota Avensis 2.2 D4D Exclusive (06-09), Camry II 2.0, 2.4i Xli, 3.0 GLX 1MZ-FE (01-06), Corolla Verso ZZE122 160i S, SX MPV, 180i SX, SX MMT, TX, TX MMT MPV 1ZZ-FE (04-09)
<b>462 2RS</b>	Alternator/Generator Bearing	Toyota Land Cruiser 4.2, 4.5, 4.7 (98-04)
<b>469+453X</b>	Rear Wheel Bearing Inner	Toyota Dyna 2.0, 2.2, 2.4, 3.0 (85-95), Stout 1.9, 2.0 (62-79)
<b>46T0808</b>	Rear Wheel Bearing Inner	Mitsubishi Colt LDV 2.8TD - 4X4, 2.4i, 2.8D, 3.0i (98-09), Triton - 4X2, 4X4 2.4MPI, 2.5DiD, 3.2DiD, 3.5 V6 P/up (2007-)
<b>46T090A</b>	Front Wheel Bearing Inner	Toyota Condor 2.4i Estate, TX Estate 2RZ-E, 3.0 Estate, TX Estate 5L - 4X4 (00-05)
<b>47KWD02A</b>	Front Wheel Bearing Inner	Ford Everest 3.0 Tdci - 4X2, 4X4 (09-15), Ranger 2.5 Diesel, Turbo Diesel D/ Cab, High Trail, XL, DT XLT High Trail D/Cab, Super Cab, 3.0TDCi Super Cab XLT Hi-Trail., 4.0 SubCab XLT Hi Trail, Super Cab XLT Hi-Trail. - 4X2 (04-12), 2.5 D/ Cab, High Trail, XL, DT XLT High Super Cab, 2.5TD Montana D/Cab WL4, 3.0TDCi, 4.0 Super Cab XLT - 4X4 (04-09), Mazda BT-50 2500 Tdi, 2.6i SLE D/cab., S/cab., 3000 CRDi SLE D/cab., Freestyle SLX S/cab., D/cab - 4X2, 4X4 (07-12), 3.2 MZ-CD P5-AT - 4X4 (2012-), Drifter 2.5Td LWB Hi Ride, SL SLE, SLX D/cab, Hi Ride, Hi Trail D/cab P/up WL4 Dies./Turbo Dies. - 4X2, 4X4, 2.6i LWB Hi Ride, SL Hi Ride S/cab, SLE, SLX D/cab SLX Hi Ride D/cab, SLX Hi Trail D/cab P/up Pet. - 4X2, 2.6i V6 LWB SL S/cab, SLE, SLX D/cab P/up 4G54 Pet. - 4X4 (04-09)
<b>47KWD02A</b>	Front Wheel Bearing Inner	Ford Ranger 2.5TD, 3.0TDCi, 4.0 (2004-), Mazda Drifter 2.5TD, 2.6, 3.0TDCi, 4.0 (04-07)
<b>47KWD03ASB</b>	Front Wheel Bearing Inner	Ford Ranger T6 2.2 D HP, MP, 2.5, 3.2 D Wildtrack, 3.2 TDCi - 4X2, 2.2 D HP, MP, 2.2 D MP, 3.2 D Wildtrack, 3.2 TDCi - 4X4 (2012-), Mazda BT-50 3.2 MZ-CD P5-AT - 4X4 (2012-)
<b>48510+48</b>	Front Wheel Bearing Inner / Diff. Carrier Bearing	C.A.M. Inyathi Jinbei Haise Minibus 2.2i Std., Rhino 2.2i, 2.8i (2007-), Ford Courier 1.6 P/up F6, 1.8 Chassis cab, Explorer, Std., XLT P/up F8., 2.0 XLT FE., 2.2 D/ cab, Explorer, Leisure, Std., XLT P, 3.0 V6 D/cab, Explorer, L, Leisure, Std., P/up Essex (86-00), 2.5 Turbo Diesel D/cab, Leisure P/up WL4, 3.4 V6 Leisure D/cab, P/ up Essex - 4X2 (96-01), Husky 1.8 1 Ton P/up 4G62, 2.0 1 Ton P/up, Bus, P/van 4G63 (85-99), Ranger 1.8 XL, P/up, 2.2 XL, P/up (00-05), 2.5 Diesel, Turbo Diesel D/ Cab, High Trail, XL, DT XLT High Trail D/Cab, Super Cab - 4X2 (00-04), Spectron 2.2 Bus, P/van F2 (91-04), GWM Steed 3 2.2i S/Cab, D/Cab (10-13), Hyundai Bakkie 2.5i D4BH Dies., 2.6i D4BB Dies., H100 P/van 2.5i D4BH Dies., 2.6i D4BB Dies. (97-07), Isuzu KBD20 2.0 P/up C190, KBD21 2.0 P/up C190, KBD22 2.2 LE, P/up C223 (87-89), KB40 1.6 G161Z, KB41 1.6 G161Z, 1.8 G180Z, KB42 1.8 G180Z, KB43 2.0 G200Z, KB44 2.3 4ZD1, KBD40 KBD41 2.0 P/up C190, KBD42 2.2 P/up C223 - 4X4 (79-89), KB160 1.6 Fleetside P/up, KB200 2.0 LE, Fleetside, D/cab P/ up, KB220 2.2 LE, P/up, KB230 2.3 D/cab P/up (89-04), KB260 2.6 LE, D/cab, LX P/ up 4ZE1, KB320 3.2 LE, D/cab, LX, Frontier, Reef, Blazer P/up 6VD1 (92-04), KB220 2.2 LE P/up, KB230 2.3 P/up 4ZD1, KB260 2.6 D/cab, LE, LX, KB320 3.2 V6 Frontier LX - 4X4 (89-04), KB200i 2.0 LX, KB240i 2.4 LX, KB250i 2.5 LX (04-12), KB250D 2.5 Fleetside, LE, D/Cab P/up 4JA1, KB280DT 2.8 D/cab LE, LX, Frontier P/up Turbo 4JB1 - 4X2, KB250D 2.5 LE, D/cab P/up 4JA1, KB280DT 2.8 LE, LX, D/cab P/up Turbo 4JB1 - 4X4 (89-04), KB250Dc 2.5, KB300TDi 3.0 LX (04-09), KB300TDi 3.0 D-TEQ (07-11), Relay 2.0 P/van, Bus 4ZC1 (89-95), WFR 1.8 11FVX/ 12FVX Bus, P/ van 4ZB1 (83-89)



# BUYERS GUIDE - LOOSE BEARINGS

<b>48510+48...</b> <b>Continued</b>	Front Wheel Bearing Inner / Diff. Carrier Bearing	Mazda B-Series B2600 2.6 LWB D/cab, Magnum, Drifter P/up 4G54 Pet., B2600i 2.6i LWB D/cab Drifter, SLX P/up 4G54 Pet., B3000 3.0 V6 LWB D/cab, Magnum Drifter P/up Essex Pet. - 4X2 (86-01), B1600 1.6 SWB Magnum P/up F6 Pet., B1800 1.8 SWB/LWB Magnum, Drifter P/up F8 Pet., B2000 2.0 LWB Drifter, Magnum P/up FE Pet., B2200 2.2 LWB D/cab, Drifter, Magnum P/up R2 Dies., 2.2 LWB D/cab, Drifter, Magnum P/up F2 Pet. (86-00), B3400 3.4 V6 LWB Magnum D/cab P/up Essex Pet. - 4X2 (96-00), B2500 2.5 LWB Diesel, Turbo Diesel D/cab, Drifter, SLX P/up WL4 Dies., Turbo - 4X2 (97-00), Drifter 1.8 SWB/LWB XL P/up Pet., 2.2 SWB/LWB XL P/up Pet., 2.5Td LWB Hi Ride, SL SLE, SLX D/cab, Hi Ride, Hi Trail D/cab P/up WL4 Dies./Turbo Dies., 2.6i LWB Hi Ride, SL Hi Ride S/cab, SLE, SLX D/cab SLX Hi Ride D/cab, SLX Hi Trail D/cab P/up Pet. (00-04), Marathon 2.2 LWB Bus, P/van F2 Pet. (91-04), Mercedes-Benz W123 200 M115.938/9, 230, E M115.954, 240D M616.912, 250 M123.920/1, 280E M110.983, 300D M617.912 (77-86), W126 280SE M110 987/9, 300SE M103.981, 380SE M116.963, 420SE M116.965, 500SE M117.965 (86-93), Mitsubishi Colt LDV 1.6 SWB/LWB Lo-Line P/up 4G32 Pet., 2.0 4G63 Pet., 2.5D 4D56 Dies., 2.6 WB Hi-Line P/up 4G54 Pet., 2.8D LWB Std., Hi line P/up Dies., 2.8TDi LWB Club CabS cab, Turbo, 3.0i V6 LWB Club S/cab P/up Pet. (94-98), 2.0 LWB Std. P/up, 2.0i LWB Hi-Line, 2.4i LWB Hi-Line Rodeo S-/D/cab, Hi-Line/Rider P/up Pet., 2.5D 4D56 Dies. (98-09), 2.4i LWB Hi-Line D/cab, Trailbuster S/cab, P/up Pet. - 4X4 (98-09), 2.8TDi LWB Pioneer, Rodeo D/cab P/up Turbo Dies., 3.0i V6 LWB Rodeo D/cab P/up Pet. (99-09), L300 1.6 Mini Bus, Van 4G32 Pet., 1.8 4G62 Pet., 2.0 P/up 4G63 Pet., Starwagon 2.0 S, SL, SLE, P/up, P/van 4G63 Pet. (82-01), Nissan 1-Tonner/Hardbody AW/D21 1.6 L16S-J, 1.8 L18S-R, 2.0 NA20, 2.4 Z24/S, 2.5D TD25i, 2.7D TD27, 3.0 VG30E (88-98), 720 D20 1.8 L18S Kingcab, Sport, 2.2D SD/Z22 Tracker, 2.3 SD23 (80-88), E20 1.8 L18 Bus, P/van Coach, Coach GL, GLE, Econolux, Ekonovan, Ekonowagon, 2.0 Bus, Van H20 (80-96), Hardbody QW/D22 2.0 NA20S, 2.0i KA20, 2.4i Z24, KA24E/DE, 2.7D TD27i, 3.0 i VG30E, 3.0TD ZD30, 3.2 QD32, 3.3i VG33E (98-11), NP300 D22 2.0i, S, SE KA20, 2.5TDi, S, SE YD25 (2008-), Sani AW/D21 2.4, i Z24, 2.5 TD25, 2.7D, TD TD27, 3.0 VG30E (89-99), Tata Safari 2.2 CRDi GLS Dies. (2007-), Super Ace 1.4TD (2012-), Telcoline 2.0 Turbo Diesel S/Cab P/up (04-10), Xenon 2.0TDi, 3.0TD (2008-), Toyota Corolla KE70 1.3 P/van 4K (84-88), Hiace YH50/60 1.8 SWB / LWB P/van, LS Wagon 2Y Pet. (83-91), YH51/61 2.0 SWB/LWB 16 Seater Commuter, Super 10 Seater Custom Wagon, P/van 3Y Pet. (83-86), YH53/63 2.2 SWB/LWB P/van, Van, LS, GLX, Exec. Wagon 4Y Pet. (All Imp. Models) (86-88), YH53/63 2.2 SWB/LWB P/van, Van, LS, Super T/14/16, GLX, Exec. Wagon, Siyaya Bus, P/van 4Y Pet. (All Local Models) (88-09), Hilux LN30/40/50/51/55 2.2 SWB/LWB P/up L Dies., 2.4 SWB/LWB D/cab, Raider P/up 2L Dies., YN58 2.2 LWB D/cab, Raider, SRX P/up 4Y Pet. (79-98), YN51/56 1.8 SWB/LWB D/cab, S, SR, Raider P/up 2Y Pet., YN140 1.8 SWB/LWB D/cab, Raider, S, SRX P/up 2Y Pet. (86-05), RN58 2.4 22R Pet. (94-98), LN57 2.8D LWB D/cab, Raider P/up 3L Dies. - 4X2 (95-98), RZN147 2.0 SWB/LWB D/cab, DLX, Raider, S, SR, SRX P/up 1RZ Pet. (98-05)
<b>48510+48L</b>	Front Wheel Bearing Inner / Diff. Carrier Bearing	C.A.M. Inyathi Jinbei Haise Minibus 2.2i Std., Rhino 2.2i, 2.8i (2007-), Ford Courier 1.6 P/up F6, 1.8 Chassis cab, Explorer, Std., XLT P/up F8., 2.0 XLT FE., 2.2 D/cab, Explorer, Leisure, Std., XLT P, 3.0 V6 D/cab, Explorer, L, Leisure, Std., P/up Essex (86-00), 2.5 Turbo Diesel D/cab, Leisure P/up WL4, 3.4 V6 Leisure D/cab, P/up Essex - 4X2 (96-01), Husky 1.8 1 Ton P/up 4G62, 2.0 1 Ton P/up, Bus, P/van 4G63 (85-99), Ranger 1.8 XL, P/up, 2.2 XL, P/up (00-05), 2.5 Diesel, Turbo Diesel D/Cab, High Trail, XL, DT XLT High Trail D/Cab, Super Cab - 4X2 (00-04), Ranger T6 2.2 D HP, MP, 2.5, 3.2 D Wildtrack, 3.2 TDCi - 4X2, 4X4 (2012-), Spectron 2.2 Bus, P/van F2 (91-04), Hyundai Bakkie 2.5i D4BH Dies., 2.6i D4BB Dies., H100 P/van 2.5i D4BH Dies., 2.6i D4BB Dies. (97-07), Isuzu KBD20 2.0 P/up C190, KBD21 2.0 P/up C190, KBD22 2.2 LE, P/up C223 (87-89), KB40 1.6 G161Z, KB41 1.6 G161Z, 1.8 G180Z, KB42 1.8 G180Z, KB43 2.0 G200Z, KB44 2.3 4ZD1, KBD40 KBD41 2.0 P/up C190, KBD42 2.2 P/up C223 - 4X4 (79-89), KB160 1.6 Fleetside P/up, KB200 2.0 LE, Fleet-side, D/cab P/up, KB220 2.2 LE, P/up, KB230 2.3 D/cab P/up (89-04), KB260 2.6 LE, D/cab, LX P/up 4ZE1, KB320 3.2 LE, D/cab, LX, Frontier, Reef, Blazer P/up 6VD1 (92-04), KB220 2.2 LE P/up, KB230 2.3 P/up 4ZD1, KB260 2.6 D/cab, LE, LX, KB320 3.2 V6 Frontier LX - 4X4 (89-04), KB200i 2.0 LX, KB240i 2.4 LX, KB250i 2.5 LX (04-12), KB250D 2.5 Fleetside, LE, D/Cab P/up 4JA1, KB280DT 2.8 D/cab LE, LX, Frontier P/up Turbo 4JB1 - 4X2, KB250D 2.5 LE, D/cab P/up 4JA1, KB280DT 2.8 LE, LX, D/cab P/up Turbo 4JB1 - 4X4 (89-04), KB250Dc 2.5, KB300TDi 3.0 LX (04-09), KB300TDi 3.0 D-TEQ (07-11), Relay 2.0 P/van, Bus 4ZC1 (89-95), WFR 1.8 11FVX/12FVX Bus, P/van 4ZB1 (83-89), Mazda B-Series B2600 2.6 LWB D/cab, Magnum, Drifter P/up 4G54 Pet., B2600i 2.6i LWB D/cab Drifter, SLX P/up 4G54 Pet., B3000 3.0 V6 LWB D/cab, Magnum Drifter P/up Essex Pet. - 4X2 (86-01), B1600 1.6 SWB Magnum P/up F6 Pet., B1800 1.8 SWB/LWB Magnum, Drifter P/up F8 Pet., B2000 2.0 LWB Drifter, Magnum P/up FE Pet., B2200 2.2 LWB D/cab, Drifter, Magnum P/up R2 Dies., 2.2 LWB D/cab, Drifter, Magnum P/up F2 Pet. (86-00)

# BUYERS GUIDE - LOOSE BEARINGS

<p><b>48510+48L...</b> <b>Continued</b></p>	<p>Front Wheel Bearing Inner / Diff. Carrier Bearing</p>	<p>B3400 3.4 V6 LWB Magnum D/cab P/up Essex Pet. - 4X2 (96-00), B2500 2.5 LWB Diesel, Turbo Diesel D/cab, Drifter, SLX P/up WL4 Dies., Turbo - 4X2 (97-00), Drifter 1.8 SWB/LWB XL P/up Pet., 2.2 SWB/LWB XL P/up Pet., 2.5TD LWB Hi Ride, SL SLE, SLX D/cab, Hi Ride, Hi Trail D/cab P/up WL4 Dies./Turbo Dies., 2.6i LWB Hi Ride, SL Hi Ride S/cab, SLE, SLX D/cab SLX Hi Ride D/cab, SLX Hi Trail D/cab P/up Pet. (00-04), Marathon 2.2 LWB Bus, P/van F2 Pet. (91-04), Mercedes-Benz W123 200 M115.938/9, 230, E M115.954, 240D M616.912, 250 M123.920/1, 280E M110.983, 300D M617.912 (77-86), W126 280SE M110 987/9, 300SE M103.981, 380SE M116.963, 420SE M116.965, 500SE M117.965 (86-93), Mitsubishi Colt LDV 1.6 SWB/LWB Lo-Line P/up 4G32 Pet., 2.0 4G63 Pet., 2.5D 4D56 Dies., 2.6 WB Hi-Line P/up 4G54 Pet., 2.8D LWB Std., Hi line P/up Dies., 2.8TDi LWB Club CabS cab, Turbo, 3.0i V6 LWB Club S/cab P/up Pet. (94-98), 2.0 LWB Std. P/up, 2.0i LWB Hi-Line, 2.4i LWB Hi-Line Rodeo S-/D/cab, Hi-Line/Rider P/up Pet., 2.5D 4D56 Dies. (98-09), 2.4i LWB Hi-Line D/cab, Trailbuster S/cab, P/up Pet. - 4X4 (98-09), 2.8TDi LWB Pioneer, Rodeo D/cab P/up Turbo Dies., 3.0i V6 LWB Rodeo D/cab P/up Pet. (99-09), L300 1.6 Mini Bus, Van 4G32 Pet., 1.8 4G62 Pet., 2.0 P/up 4G63 Pet., Starwagon 2.0 S, SL, SLE, P/up, P/van 4G63 Pet. 82-01, Nissan 1-Tonner/Hardbody AW/D21 1.6 L16S-J, 1.8 L18S-R, 2.0 NA20, 2.4 Z24/S, 2.5D TD25i, 2.7D TD27, 3.0 VG30E (88-98), 720 D20 1.8 L18S Kingcab, Sport, 2.2D SD/Z22 Tracker, 2.3 SD23 (80-88), E20 1.8 L18 Bus, P/van Coach, Coach GL, GLE, Econolux, Ekonovan, Ekonowagon, 2.0 Bus, Van H20 (80-96), Hardbody QW/D22 2.0 NA20S, 2.0i KA20, 2.4i Z24, KA24E/DE, 2.7D TD27i, 3.0 i VG30E, 3.0TD ZD30, 3.2 QD32, 3.3i VG33E (98-11), NP300 D22 2.0i, S, SE KA20, 2.5TDi, S, SE YD25 (2008-), Sani AW/D21 2.4, i Z24, 2.5 TD25, 2.7D, TD TD27, 3.0 VG30E (89-99), Tata Safari 2.2 CRDi GLS Dies. (2007-), Super Ace 1.4TD (2012-), Telcoline 2.0 Turbo Diesel S/Cab P/up (04-10), Xenon 2.0TDi, 3.0TD (2008-), Toyota Corolla KE70 1.3 P/van 4K (84-88), Hiace YH50/60 1.8 SWB / LWB P/van, LS Wagon 2Y Pet. (83-91), YH51/61 2.0 SWB/LWB 16 Seater Commuter, Super 10 Seater Custom Wagon, P/van 3Y Pet. (83-86), YH53/63 2.2 SWB/LWB P/van, Van, LS, GLX, Exec. Wagon 4Y Pet. (All Imp. Models) (86-88), YH53/63 2.2 SWB/LWB P/van, Van, LS, Super T/14/16, GLX, Exec. Wagon, Siyaya Bus, P/van 4Y Pet. (All Local Models) (88-09), Hilux LN30/40/50/51/55 2.2 SWB/LWB P/up L Dies., 2.4 SWB/LWB D/cab, Raider P/up 2L Dies., YN58 2.2 LWB D/cab, Raider, SRX P/up 4Y Pet. (79-98), YN51/56 1.8 SWB/LWB D/cab, S, SR, Raider P/up 2Y Pet., YN140 1.8 SWB/LWB D/cab, Raider, S, SRX P/up 2Y Pet. (86-05), RN58 2.4 22R Pet. (94-98), LN57 2.8D LWB D/cab, Raider P/up 3L Dies. - 4X2 (95-98), RZN147 2.0 SWB/LWB D/cab, DLX, Raider, S, SR, SRX P/up 1RZ Pet. (98-05) (Seal is attached to the side of the bearing)</p>
<p><b>48510+49</b></p>	<p>Diff. Carrier Bearing</p>	<p>Ford Anglia 1.0, 1.2 (65-69), Cortina MkI 1.2, 1.5 (62-66), Escort 1.1, 1.3, 1.6, 2.0 (68-81), Isuzu KB230, KB250D (89-04)</p>
<p><b>501310+349</b></p>	<p>Front Bearing, Diff Bearing</p>	<p>Audi 100/4 1.6 LS YV, 100/5 1.9 WH, 200 2.1 GLS, GLX, 400 1.8 JW, 500 2.1/2.2 WB, WC SE PR (77-92), 500 2.2 E PR, 2.3 E, SE, AAR, 2.8 SEL AAH (92-94), A3 1.8 8L1 AGN, 1.8T AGU, BPU (98-04), A4 1.8 8D2, B5 Exec ADR, 1.8T APU (95-01), 1.8T Avant, Multitronic, BFB, B6 AVJ 8E2, 1.9 TDi AVF, Avant B6, 8E5, 8E2 (00-08), 2.5 TDi 8D/E2 Quattro AFB, Quattro Tiptronic, 2.6 8D2 / 8D5 Exec. (95-00), 3.0 Quattro Tiptronic, ASN (02-08), A6 2.8 Quattro 4A, AAH, ACK, 3.0 Quattro Tiptronic BBJ (94-00), 2.4 Avant Multitronic., Tiptronic, AGA, ALF, AML, APS, ARJ, 2.5TDi Multitronic Avant SW., BCZ/BDG/BFC, 2.6 ABC (97-03), 4.2 Quattro Tiptronic ARS (00-08), A8 3.7 Tiptronic AQG, 4D2, 4.2 Quattro 4E2/8 BFM (95-02), S3 1.8T 8L1 Quattro AMK, BAM, APY (00-04), S4 2.2T Quattro AAN (92-95), BMW 3 Series E30 316 1.8 M10, 316i 1.6 M40, 318i 1.8 M40, 320i M20/50, 323i M50, 325i M52, 333i M30 (83-92), Cortina MkIII 1.6 L P/up Kent, 1.6 L, Std., XL Kent, 2.0 OHC GT, V4 L, XL, S/W Essex EV20, 2.0 V4 P/up Koln T20, 2.5 L P/up Essex EV25, 2.5 XL, S/W Essex EV25, 3.0 GT, L, XL, XLE "Big Six" Essex EV30 (71-77), Cortina MkIV 1.3 L Kent, 1.6 GL, L, S/W Kent, 1.6 P/up Kent, 2.0 GL, GLE, S/W Koln T20, 3.0 V6 Ghia, GLS, S, S/W Essex EV30, 3.0 V6 Leisure, P/up Essex EV30 (77-80), Cortina MkV 1.3 L Kent, 1.6 GL, L, Kent, 1.6 P/up Kent, 2.0 Ghia, GL Koln T20, 2.4 P/up York D24, 3.0 V6 GLS, GLS XR6, Essex EV30, 3.0 V6 Leisure P/up Essex EV30 (80-86), Courier 1.6 P/up F6, 1.8 Chassis cab, Explorer, Std., XLT P/up F8., 2.0 XLT FE., 2.2 D/cab, Explorer, Leisure, Std., XLT P, 3.0 V6 D/cab, Explorer, L, Leisure, Std., P/up Essex (86-00), 2.5 Turbo Diesel D/cab, Leisure P/up WL4, 3.4 V6 Leisure D/cab, P/up Essex - 4X2, 3.0 V6 Std., XLT, D/cab, Leisure, Explorer, Exec. P/up Essex - 4X4 (96-01), Husky 1.8 1 Ton P/up 4G62, 2.0 1 Ton P/up, Bus, P/van 4G63 (85-99), Ranger 1.8 XL, P/up, 2.2 XL, P/up (00-05), 1.8 XL, P/up, 2.2 XL, P/up (04-10), 2.5 Diesel, Turbo Diesel D/Cab, High Trail, XL, DT XLT High Trail D/Cab, Super Cab - 4X2 (00-09), Sapphire 1.6 L Kent, 2.0, i GL, GLE, GLEA, GLi, GLi Exec. Koln, 3.0 Ghia, GLX Essex (89-93), Sierra 1.6 GL, GL S/W, L Kent, 2.0 GL, GL S/W Koln, 2.0 LX Koln, 3.0, i GLS, GLX, LX, RS, XR6 Essex (83-93), Spectron 2.2 Bus, P/van F2 (91-04), Hyundai Sonata Y3 2.0 G4CP, 2.5 V6 G6BV, 3.0 V6 G6AT (94-04)</p>

# BUYERS GUIDE - LOOSE BEARINGS

<p><b>501310+349... Continued</b></p>	<p>Front Bearing, Diff Bearing</p>	<p>Isuzu KB20 1.6 P/up G161Z Pet., KB21 1.6 P/up G161Z Pet., KB22 1.8 P/up G180Z Pet., KB23 2.0 P/up G200Z, KB24 2.3 LE 4ZD1, KB25 1.6 P/up G161Z, KB26 1.6 P/up G161Z, 1.8 P/up G180Z, KBD23 2.5 LE, P/up 4JA1, KBD25 2.0 P/up C190 (78-89), KBD26 2.0 P/up C190, KBD27 2.2 C223, KBD28 2.5 4JA1 (81-89), KB27 1.8 P/up G180Z, KB28 2.0 P/up G200Z, KB29 2.3 P/up 4ZD1 (83-89), KB40 1.6 G161Z, KB41 1.6 G161Z, 1.8 G180Z, KB42 1.8 G180Z, KB43 2.0 G200Z, KB44 2.3 4ZD1, KBD40 KBD41 2.0 P/up C190, KBD42 2.2 P/up C223 - 4X4 (79-89), KB160 1.6 Fleetside P/up, KB200 2.0 LE, Fleetside, D/cab P/up, KB220 2.2 LE, P/up, KB230 2.3 D/cab P/up (89-04), KB260 2.6 LE, D/cab, LX P/up 4ZE1, KB320 3.2 LE, D/cab, LX, Frontier, Reef, Blazer P/up 6VD1 (92-04), KB220 2.2 LE P/up, KB230 2.3 P/up 4ZD1, KB260 2.6 D/cab, LE, LX, KB320 3.2 V6 Frontier LX - 4X4 (89-04), KB250D 2.5 Fleetside, LE, D/Cab P/up 4JA1, KB280DT 2.8 D/cab LE, LX, Frontier P/up Turbo 4JB1 - 4X2, 4X4 (89-04), Relay 2.0 P/van, Bus 4ZC1 (89-95), Kia Carnival 2.5 K55, KRV6 (00-04), Land Rover 110 SERIES II, IIA, III 2.6 LWB P/up 6 Cyl. OHI SE Pet., 3.5 LWB "PUP" P/up V8 ADE236 Pet. (84-96), Freelander 1.8i S/W Pet., 2.0 Di S/W, Td4 SUV Pet., 2.5 V6 SUV KV6 Pet. (98-04), Range Rover 3.5 V8, Vogue S/W Pet., 4.6 V8 HSE S/W Pet. (79-04), Mazda B-Series B3000 3.0 V6 LWB D/cab, Magnum Drifter P/up Essex Pet. - 4X2, 4X4 (86-97), B1600 1.6 SWB Magnum P/up F6 Pet., B1800 1.8 SWB/LWB Magnum, Drifter P/up F8 Pet., B2000 2.0 LWB Drifter, Magnum P/up FE Pet., B2200 2.2 LWB D/cab, Drifter, Magnum P/up R2 Dies., 2.2 LWB D/cab, Drifter, Magnum P/up F2 Pet. (86-00), B3400 3.4 V6 LWB Magnum D/cab P/up Essex Pet. - 4X2 (96-00), B2500 2.5 LWB Diesel, Turbo Diesel D/cab, Drifter, SLX P/up WL4 Dies., Turbo - 4X2 (97-00), Drifter 1.8 SWB/LWB XL P/up Pet., 2.2 SWB/LWB XL P/up Pet., 2.5Td LWB Hi Ride, SL SLE, SLX D/cab, Hi Ride, Hi Trail D/cab P/up WL4 Dies./Turbo Dies., 2.6i LWB Hi Ride, SL Hi Ride S/cab, SLE, SLX D/cab SLX Hi Ride D/cab, SLX Hi Trail D/cab P/up Pet. - 4X2 (00-09), Marathon 2.2 LWB Bus, P/van F2 Pet. (91-04), Mercedes-Benz BM903/4 Sprinter 308D 2.2 OM 601 LA Dies., 312D 2.2 OM602 LA Dies., 313 2.2 LWB, SWB Bus, P/van OM611 LA Pet., 412D 2.8 OM612, 413CDi 2.2, 416CDi 2.2 (96-06), Mitsubishi Colt LDV 1.6 SWB/LWB Lo-Line P/up 4G32 Pet., 2.0 4G63 Pet., 2.5D 4D56 Dies., 2.6 WB Hi-Line P/up 4G54 Pet., 2.8D LWB Std., Hi line P/up Dies., 2.8TDi LWB Club CabS cab, Turbo, 3.0i V6 LWB Club S/cab P/up Pet. (94-98), 2.0 LWB Std. P/up, 2.0i LWB Hi-Line, 2.4i LWB Hi-Line Rodeo S-/D/cab, Hi-Line/Rider P/up Pet., 2.5D 4D56 Dies. (98-09), L300 1.6 Mini Bus, Van 4G32 Pet., 1.8 4G62 Pet., 2.0 P/up 4G63 Pet., Starwagon 2.0 S, SL, SLE, P/up, P/van 4G63 Pet. (82-01)</p>
<p><b>501310+349... Continued</b></p>	<p>Front Bearing, Diff Bearing</p>	<p>Nissan 1-Tonner/Hardbody AW/D21 1.6 L16S-J, 1.8 L18S-R, 2.0 NA20, 2.4 Z24/S, 2.5D TD25i, 2.7D TD27, 3.0 VG30E - 4X2, 2.4 Z24S, 2.7 TD27, 3.0 VG30E - 4X4 (88-90), 2.7 TD27, 3.0 VG30E - 4X4 (90-99), 720 D20 1.8 L18S Kingcab, Sport, 2.2D SD/Z22 Tracker, 2.3 SD23 (80-88), B140 1.4 A14SP/van, S/W, Deluxe, Std. Sport, CHAMP P/up (80-08), E20 1.8 L18 Bus, P/van Coach, Coach GL, GLE, Econolux, Ekonovan, Ekonowagon, 2.0 Bus, Van H20 (80-96), Hardbody QW/D22 2.0 NA20S, 2.0i KA20, 2.4i Z24, KA24E/DE, 2.7D TD27i, 3.0 i VG30E, 3.0TD ZD30, 3.2 QD32, 3.3i VG33E (98-11), NP300 D22 2.0i, S, SE KA20 (2008-), Laurel C31 2.0 CA/L20, 2.8 SGL 5L28 (80-87), Patrol Y60 3.0 VG30E - 4X4 (95-00), Sani AW/D21 2.4, i Z24, 2.5 TD25, 2.7D, TD TD27, 3.0 VG30E (89-99), 2.2 Z22, 2.4 Z24, 2.7 TD27, 3.0 VG30E - 4X4 (86-98), Skyline R30 1.8 L18, 2.0 GL L20, R31 2.0 GL, GLE CA20 (82-92), Opel Astra G 2.0 Coupe', CSX X20XEV, 2.2i Classic Exec. (99-05), Rekord 2.0 Berlina, GL, GLS, L, S/W CIH, 2.0i CLE, CLS, GL, GLE, Irmischer, 2.2E CIH, 380i, V6 CD, GSi 38GE (82-95), Ssangyong Korando 2.3 K230 EL, Open Top S/W, 2.9 K290 EL, TDi, Open Top S/W, 3.2 K320 EL S/W, Musso 2.3 E230 EL S/W, 2.9 602, EL, EX, TDi, Exec., E290 TDi, Exec., 3.2 E320 EL Exec. (95-04), Tata Safari 2.2 CRDi GLX Dies. - 4X4 (2007-), Telcoline 2.0 Turbo Diesel S/Cab, D/cab P/up - 4X4 (04-10),</p>
<p><b>501310+349... Continued</b></p>	<p>Front Bearing, Diff Bearing</p>	<p>Toyota Cressida RX60 2.0 GL, GLE, GLX, S/W 21R, RX70, YX72 2.0 GL, GL, GLE, GLX (81-92), RX72 2.4 GL, GL S/W, GLE, GLE S/W 22R (87-92), Hiace YH50/60 1.8 SWB / LWB P/van, LS Wagon 2Y Pet. (83-91), YH51/61 2.0 SWB/LWB 16 Seater Commuter, Super 10 Seater Custom Wagon, P/van 3Y Pet. (83-86), Hilux LN30/40/50/51/55 2.2 SWB/LWB P/up L Dies., 2.4 SWB/LWB D/cab, Raider P/up 2L Dies., YN58 2.2 LWB D/cab, Raider, SRX P/up 4Y Pet. (79-98), YN67 2.2 LWB D/cab, Raider D/cab P/up 4Y Pet. - 4X4 (86-94), YN51/56 1.8 SWB/LWB D/cab, S, SR, Raider P/up 2Y Pet., YN140 1.8 SWB/LWB D/cab, Raider, S, SRX P/up 2Y Pet. (86-05), Stallion KF50 1.5 SR5, Commuter, Bus, P/up, P/van 5K Pet., YF50 1.8 SR5, P/up, P/van, Van 2Y Pet., LF50 2.4D P/up 2L5F Dies. (87-04), Tuv KF20 1.3 Chassis Cab, P/up, P/van, Bus 4K Pet., 1.5 P/up 5K Pet. (82-87), Venture YF50 1.8 8/10 Seater P/van 2Y Pet., 2.2 10 Seater, GLE, Getaway 9 Seater S/W 4Y Pet., LF50 2.4D 10 Seater S/W 2L5F Dies. (91-04)</p>



# BUYERS GUIDE - LOOSE BEARINGS

<p><b>501310+349...</b> <b>Continued</b></p>	<p>Front Bearing, Diff Bearing</p>	<p>VW Beetle 1.8T Coupe APH (00-12), Golf IV 1.6i Comfortline, Std., Estate AKL, 1.8, T GTi, Highline AGU/ AGN, 1.9 TDi Highline, Estate AHF, 2.0i Cabrio, Highline APK (99-04), Jetta IV 1.6i Comfortline, Std. AKL, 1.8T Highline, Exec AGU, 1.9 TDi Highline AHF, 2.0i Highline APK, 2.3 V5 AGZ (99-06), Passat I &amp; II 1.9 GLS H/back, GLX Sedan, S/W WN, 2.2 CLi, CLX SG/MX (81-87), Passat IV 3.2 V6 Sportline DSG AXZ (99-05), Passat V 1.9TDi Comfortline AVB, 2.0FSI Comfortline, Tipt., Highline BCR BLY, 2.0 T FSI Sportline Tiptronic AXX/BPY, 2.0TDi Highline, DSG BKP/BMP, 3.2 V6 Auto. DSG (05-11)</p>
<p><b>501310+49</b></p>	<p>Front Bearing, Diff Bearing</p>	<p>Audi 100/4 1.6 LS YV, 100/5 1.9 WH, 200 2.1 GLS, GLX, 400 1.8 JW, 500 2.1/2.2 WB, WC SE PR (77-92), 500 2.2 E PR, 2.3 E, SE, AAR, 2.8 SEL AAH (92-94), A3 1.8 8L1 AGN, 1.8T AGU, BPU (98-04), A4 1.8 8D2, B5 Exec ADR, 1.8T APU (95-01), 1.8T Avant, Multitronic, BFB, B6 AVJ 8E2, 1.9 TDi AVF, Avant B6, 8E5, 8E2 (00-08), 2.5 TDi 8D/E2 Quattro AFB, Quattro Tiptronic, 2.6 8D2 / 8D5 Exec. (95-00), 3.0 Quattro Tiptronic, ASN (02-08), A6 2.8 Quattro 4A, AAH, ACK, 3.0 Quattro Tiptronic BBJ (94-00), 2.4 Avant Multitronic., Tiptronic, AGA, ALF, AML, APS, ARJ, 2.5TDi Multitronic Avant SW., BCZ/BDG/BFC, 2.6 ABC (97-03), 4.2 Quattro Tiptronic ARS (00-08), A8 3.7 Tiptronic AQG, 4D2, 4.2 Quattro 4E2/8 BFM (95-02), S3 1.8T 8L1 Quattro AMK, BAM, APY (00-04), S4 2.2T Quattro AAN (92-95), BMW 3 Series E30 316 1.8 M10, 316i 1.6 M40, 318i 1.8 M40, 320i M20/50, 323i M50, 325i M52, 333i M30 (83-92), Cortina MkIII 1.6 L P/up Kent, 1.6 L, Std., XL Kent, 2.0 OHC GT, V4 L, XL, S/W Essex EV20, 2.0 V4 P/up Koln T20, 2.5 L P/up Essex EV25, 2.5 XL, S/W Essex EV25, 3.0 GT, L, XL, XLE "Big Six" Essex EV30 (71-77), Cortina MkIV 1.3 L Kent, 1.6 GL, L, S/W Kent, 1.6 P/up Kent, 2.0 GL, GLE, S/W Koln T20, 3.0 V6 Ghia, GLS, S, S/W Essex EV30, 3.0 V6 Leisure, P/up Essex EV30 (77-80), Cortina MkV 1.3 L Kent, 1.6 GL, L, Kent, 1.6 P/up Kent, 2.0 Ghia, GL Koln T20, 2.4 P/up York D24, 3.0 V6 GLS, GLS XR6, Essex EV30, 3.0 V6 Leisure P/up Essex EV30 (80-86), Courier 1.6 P/up F6, 1.8 Chassis cab, Explorer, Std., XLT P/up F8., 2.0 XLT FE., 2.2 D/cab, Explorer, Leisure, Std., XLT P, 3.0 V6 D/cab, Explorer, L, Leisure, Std., P/up Essex (86-00), 2.5 Turbo Diesel D/cab, Leisure P/up WL4, 3.4 V6 Leisure D/cab, P/up Essex - 4X2, 3.0 V6 Std., XLT, D/cab, Leisure, Explorer, Exec. P/up Essex - 4X4 (96-01), Husky 1.8 1 Ton P/up 4G62, 2.0 1 Ton P/up, Bus, P/van 4G63 (85-99), Ranger 1.8 XL, P/up, 2.2 XL, P/up (00-05), 1.8 XL, P/up, 2.2 XL, P/up (04-10), 2.5 Diesel, Turbo Diesel D/Cab, High Trail, XL, DT XLT High Trail D/Cab, Super Cab - 4X2 (00-09), Sapphire 1.6 L Kent, 2.0, i GL, GLE, GLEA, GLi, GLi Exec. Koln, 3.0 Ghia, GLX Essex (89-93), Sierra 1.6 GL, GL S/W, L Kent, 2.0 GL, GL S/W Koln, 2.0 LX Koln, 3.0, i GLS, GLX, LX, RS, XR6 Essex (83-93), Spectron 2.2 Bus, P/van F2 (91-04), Hyundai Sonata Y3 2.0 G4CP, 2.5 V6 G6BV, 3.0 V6 G6AT (94-04)</p>
<p><b>501310+49...</b> <b>Continued</b></p>	<p>Front Bearing, Diff Bearing</p>	<p>Isuzu KB20 1.6 P/up G161Z Pet., KB21 1.6 P/up G161Z Pet., KB22 1.8 P/up G180Z Pet., KB23 2.0 P/up G200Z, KB24 2.3 LE 4ZD1, KB25 1.6 P/up G161Z, KB26 1.6 P/up G161Z, 1.8 P/up G180Z, KBD23 2.5 LE, P/up 4JA1, KBD25 2.0 P/up C190 (78-89), KBD26 2.0 P/up C190, KBD27 2.2 C223, KBD28 2.5 4JA1 (81-89), KB27 1.8 P/up G180Z, KB28 2.0 P/up G200Z, KB29 2.3 P/up 4ZD1 (83-89), KB40 1.6 G161Z, KB41 1.6 G161Z, 1.8 G180Z, KB42 1.8 G180Z, KB43 2.0 G200Z, KB44 2.3 4ZD1, KBD40 KBD41 2.0 P/up C190, KBD42 2.2 P/up C223 - 4X4 (79-89), KB160 1.6 Fleetside P/up, KB200 2.0 LE, Fleetside, D/cab P/up, KB220 2.2 LE, P/up, KB230 2.3 D/cab P/up (89-04), KB260 2.6 LE, D/cab, LX P/up 4ZE1, KB320 3.2 LE, D/cab, LX, Frontier, Reef, Blazer P/up 6VD1 (92-04), KB220 2.2 LE P/up, KB230 2.3 P/up 4ZD1, KB260 2.6 D/cab, LE, LX, KB320 3.2 V6 Frontier LX - 4X4 (89-04), KB250D 2.5 Fleetside, LE, D/Cab P/up 4JA1, KB280DT 2.8 D/cab LE, LX, Frontier P/up Turbo 4JB1 - 4X2, 4X4 (89-04), Relay 2.0 P/van, Bus 4ZC1 (89-95), Kia Carnival 2.5 K55, KRV6 (00-04), Land Rover 110 SERIES II, IIA, III 2.6 LWB P/up 6 Cyl. OHI SE Pet., 3.5 LWB "PUP" P/up V8 ADE236 Pet. (84-96), Freelander 1.8i S/W Pet., 2.0 Di S/W, Td4 SUV Pet., 2.5 V6 SUV KV6 Pet. (98-04), Range Rover 3.5 V8, Vogue S/W Pet., 4.6 V8 HSE S/W Pet. (79-04), Mazda B-Series B3000 3.0 V6 LWB D/cab, Magnum Drifter P/up Essex Pet. - 4X2, 4X4 (86-97), B1600 1.6 SWB Magnum P/up F6 Pet., B1800 1.8 SWB/LWB Magnum, Drifter P/up F8 Pet., B2000 2.0 LWB Drifter, Magnum P/up FE Pet., B2200 2.2 LWB D/cab, Drifter, Magnum P/up R2 Dies., 2.2 LWB D/cab, Drifter, Magnum P/up F2 Pet. (86-00), B3400 3.4 V6 LWB Magnum D/cab P/up Essex Pet. - 4X2 (96-00), B2500 2.5 LWB Diesel, Turbo Diesel D/cab, Drifter, SLX P/up WL4 Dies., Turbo - 4X2 (97-00), Drifter 1.8 SWB/LWB XL P/up Pet., 2.2 SWB/LWB XL P/up Pet., 2.5Td LWB Hi Ride, SL SLE,SLX D/cab, Hi Ride, Hi Trail D/cab P/up WL4 Dies./Turbo Dies., 2.6i LWB Hi Ride, SL Hi Ride S/cab, SLE, SLX D/cab SLX Hi Ride D/cab, SLX Hi Trail D/cab P/up Pet. - 4X2 (00-09), Marathon 2.2 LWB Bus, P/van F2 Pet. (91-04), Mercedes-Benz BM903/4 Sprinter 308D 2.2 OM 601 LA Dies., 312D 2.2 OM602 LA Dies., 313 2.2 LWB,SWB Bus, P/van OM611 LA Pet., 412D 2.8 OM612, 413CDi 2.2, 416CDi 2.2 (96-06)</p>

# BUYERS GUIDE - LOOSE BEARINGS

<p><b>501310+49...</b> <b>Continued</b></p>	<p>Front Bearing, Diff Bearing</p>	<p>Mitsubishi Colt LDV 1.6 SWB/LWB Lo-Line P/up 4G32 Pet., 2.0 4G63 Pet., 2.5D 4D56 Dies., 2.6 WB Hi-Line P/up 4G54 Pet., 2.8D LWB Std., Hi line P/up Dies., 2.8TDi LWB Club CabS cab,Turbo, 3.0i V6 LWB Club S/cab P/up Pet. (94-98), 2.0 LWB Std. P/up, 2.0i LWB Hi-Line, 2.4i LWB Hi-Line Rodeo S-/D/cab, Hi-Line/Rider P/up Pet., 2.5D 4D56 Dies. (98-09), L300 1.6 Mini Bus, Van 4G32 Pet., 1.8 4G62 Pet., 2.0 P/up 4G63 Pet., Starwagon 2.0 S, SL, SLE, P/up, P/van 4G63 Pet. (82-01), Nissan 1-Tonner/Hardbody AW/D21 1.6 L16S-J, 1.8 L18S-R, 2.0 NA20, 2.4 Z24/S, 2.5D TD25i, 2.7D TD27, 3.0 VG30E - 4X2, 2.4 Z24S, 2.7 TD27, 3.0 VG30E - 4X4 (88-90), 2.7 TD27, 3.0 VG30E - 4X4 (90-99), 720 D20 1.8 L18S Kingcab, Sport, 2.2D SD/Z22 Tracker, 2.3 SD23 (80-88), B140 1.4 A14SP/van, S/W, Deluxe, Std. Sport, CHAMP P/up (80-08), E20 1.8 L18 Bus, P/van Coach, Coach GL, GLE, Econolux, Ekonovan, Ekonowagon, 2.0 Bus, Van H20 (80-96), Hardbody QW/D22 2.0 NA20S, 2.0i KA20, 2.4i Z24, KA24E/DE, 2.7D TD27i, 3.0 i VG30E, 3.0TD ZD30, 3.2 QD32, 3.3i VG33E (98-11), NP300 D22 2.0i, S, SE KA20 (2008-), Laurel C31 2.0 CA/L20, 2.8 SGL 5L28 (80-87), Patrol Y60 3.0 VG30E - 4X4 (95-00), Sani AW/D21 2.4, i Z24, 2.5 TD25, 2.7D, TD TD27, 3.0 VG30E (89-99), 2.2 Z22, 2.4 Z24, 2.7 TD27, 3.0 VG30E - 4X4 (86-98), Skyline R30 1.8 L18, 2.0 GL L20, R31 2.0 GL, GLE CA20 (82-92), Opel Astra G 2.0 Coupe', CSX X20XEV, 2.2i Classic Exec. (99-05), Rekord 2.0 Berlina, GL, GLS, L, S/W CIH, 2.0i CLE, CLS, GL, GLE, Irmischer, 2.2E CIH, 380i, V6 CD, GSi 38GE (82-95), Ssangyong Korando 2.3 K230 EL, Open Top S/W, 2.9 K290 EL, TDi, Open Top S/W, 3.2 K320 EL S/W, Musso 2.3 E230 EL S/W, 2.9 602, EL, EX, TDi, Exec., E290 TDi, Exec., 3.2 E320 EL Exec. (95-04), Tata Safari 2.2 CRDi GLX Dies. - 4X4 (2007-), Telcoline 2.0 Turbo Diesel S/Cab, D/cab P/up - 4X4 (04-10), Toyota Cressida RX60 2.0 GL, GLE, GLX, S/W 21R, RX70, YX72 2.0 GL, GL, GLE, GLX (81-92), RX72 2.4 GL, GL S/W, GLE, GLE S/W 22R (87-92), Hiace YH50/60 1.8 SWB / LWB P/van, LS Wagon 2Y Pet. (83-91), YH51/61 2.0 SWB/LWB 16 Seater Commuter, Super 10 Seater Custom Wagon, P/van 3Y Pet. (83-86), Hilux LN30/40/50/51/55 2.2 SWB/LWB P/up L Dies., 2.4 SWB/LWB D/cab, Raider P/up 2L Dies., YN58 2.2 LWB D/cab, Raider, SRX P/up 4Y Pet. (79-98), YN67 2.2 LWB D/cab, Raider D/cab P/up 4Y Pet. - 4X4 (86-94), YN51/56 1.8 SWB/LWB D/cab, S, SR, Raider P/up 2Y Pet., YN140 1.8 SWB/LWB D/cab, Raider, S, SRX P/up 2Y Pet. (86-05), Stallion KF50 1.5 SR5,Commuter, Bus, P/up, P/van 5K Pet., YF50 1.8 SR5, P/up, P/van, Van 2Y Pet., LF50 2.4D P/up 2L5F Dies. (87-04), Tuv KF20 1.3 Chassis Cab, P/up, P/van, Bus 4K Pet., 1.5 P/up 5K Pet. (82-87), Venture YF50 1.8 8/10 Seater P/van 2Y Pet., 2.2 10 Seater, GLE, Getaway 9 Seater S/W 4Y Pet., LF50 2.4D 10 Seater S/W 2L5F Dies. (91-04), VW Beetle 1.8T Coupe APH (00-12), Golf IV 1.6i Comfortline, Std., Estate AKL, 1.8, T GTi, Highline AGU/ AGN, 1.9 TDi Highline, Estate AHF, 2.0i Cabrio, Highline APK (99-04), Jetta IV 1.6i Comfortline, Std. AKL, 1.8T Highline, Exec AGU, 1.9 TDi Highline AHF, 2.0i Highline APK, 2.3 V5 AGZ (99-06), Passat I &amp; II 1.9 GLS H/back, GLX Sedan, S/W WN, 2.2 CLi, CLX SG/MX (81-87), Passat IV 3.2 V6 Sportline DSG AXZ (99-05), Passat V 1.9TDi Comfortline AVB, 2.0FSi Comfortline, Tipt., Highline BCR BLY, 2.0 T FSi Sportline Tiptronic AXX/BPY, 2.0TDi Highline, DSG BKP/BMP, 3.2 V6 Auto. DSG (05-11)</p>
<p><b>503310+49</b></p>	<p>Front Wheel Bearing Inner, Outer / Diff. Carrier Bearing</p>	<p>Audi A3 2.0 FSi BVZ, 2.0 FSi 8PA Sportback BLX, 2.0 TFSi CCZA, CBFA, 2.0 TDi BMM, CLJA, 3.2 Quattro, DSG, BUB (03-13), A4 2.0 Multitronic Avant 8EC, 8E2 ALT, 2.0 TDi 125, 8EC BLB, Avant Multitronic, 2.0TFSi DTM 147 BGB, 3.2 FSi Quattro, 8EC Multitronic Avant, Tiptronic Avant, AUK (00-08), 2.4 Multitronic, BDV, 3.0 Cabriolet ASN, 8H7, 3.0 TDi 8EC Quattro BKN, 3.0 TDi Quattro Avant Tiptronic, BKN, ASB (02-08), S3 2.0TFSi CDLC (07-13), S4 4.2 Quattro, Avant 8E2/E5, S/W, BBK, AQF (00-07), TT 2.0 TFSi BWA, 2.0 TTS, 3.2 Coupe, Roadster DSG, BHE, BUB (06-10), 1.8 TFSi CDAA, 2.0 TFSi Quattro CCSA, CETA, 2.5 RS Quattro CEPA (10-15), BMW 3 Series E36 316i 1.8 Dolphin Shape M40, 318i 1.9 M44, 320i 2.0 M50, 323i 2.5 M52, 325i M50, 328i 2.8, 3.0 M52, Z3 2.8, 3.0 Roadster (92-00), E37 M3 M Coupe S50 (93-01), 5 Series E28 520i 2.0 M20, 525e 2.5 M30, 528i 2.8 M30, 535i 3.0 M30 (85-89), 7 Series E23 728, i M30, 730 M30, 733i M30, 735i M90, 745i M88 (78-81), Mercedes-Benz W123 200 M115.938/9, 230, E M115.954, 240D M616.912, 250 M123.920/1, 280E M110.983, 300D M617.912 (77-86), W124 200E M102.922, 220E M111.960, 230E M102.982, 260E M103.940, 280E M104.942, 300D M103.985, M606.910, 320 Sportline M104.922 (86-96), W124 E Class E200 M102.922, E220 M111.960, E320 Sportline, M104.992 (93-96), W126 280SE M110 987/9, 300SE M103.981, 380SE M116.963, 420SE M116.965, 500SE M117.965 (86-93), R170 SLK320 M112.947 (97-02), W202/3 C-Class C180 Classic M111.920, C200 M111.941, C220 M111.961, C230 M111.974, C240 M111.944, C250 M605.910, C270CDi M612.962, C280 M104.941 (94-08), W208 CLK230, M111.973, CLK320, M112.940, CLK430, CLK500 (98-03), W210/211 E-Class E200, K M111.941/956, E230 M111.970, E240 M112.911, E280 M112.921, E320 M112.941, E320CDi OM646.961, E350 M272.964, E500 M113.967 (96-10)</p>

## BUYERS GUIDE - LOOSE BEARINGS

<b>503310+49...Continued</b>	Front Wheel Bearing Inner, Outer / Diff. Carrier Bearing	Seat Altea 2.0TDi Man., DSG Auto., Ibiza 1.4 Sport, BXW, 1.6 Sport, BAH, 1.8T Cupra, BBU, 1.9TDi 96, 118 Cupra, 2.0 AZL, BBX, BPX, BLK, ASZ, BLT (06-09), Leon 2.0 Fsi, 2.0T, FSi Cupra, 2.0T Fsi, 2.0TD (06-09), VW Golf V 1.6i Comfortline, Tiptronic, Trendline BGU, 1.9TDi Comfortline, Highline, 2.0i Comfortline, GTi, GTi Trendline DSG/ AXX/BWA, 2.0FSi Sport, Sport Tiptronic AXW, 2.0TDi, Sport DSG/ BKD (04-09), Golf VI 1.4TSi Comfortline, Trendline, Highline, 1.6i Comfortline, Trendline, 1.6TDi, 2.0i GTi, Tiptronic, 2.0TSi 4Motion, 2.0TDi Highline, DSG (09-13), Jetta V 2.0i Trendline, Comfortline, 2.0FSi Sportline, 2.0 T FSi Sportline DSG, 2.0TDi Sportline (2006-), Kombi T4 2.5Tdi Microbus, Caravelle, Trend, High ACV, AAB Dies., Turbo Dies. (99-06), Passat IV 1.8T AEB (99-05), Scirocco 1.4TSi, 2.0TSi, DSG, 2.0TSi R (2009-), Sharan 1.8T MPV AJH, 1.9TDi MPV ASZ, 2.8 MPV AAA (99-08), Tiguan 1.4TSi Trend&Fun 5Dr. SUV, 2.0TSi, 2.0TDi - 4X2, 1.4TSi Track&Field, Trend&Fun 5Dr. SUV, 2.0TSi Track&Field, Sport&Style Man., Tiptronic 5Dr. SUV, 2.0TDi Track&Field, Sport&Style Man., Tiptronic 5Dr. SUV - 4X4 (08-17), Touran 1.9TDi TrendLine DSG MPV, 2.0FSi HighLine MPV AXW, 2.0TDi HighLine, DSG MPV (04-11)
<b>50KB8301</b>	Diff. Carrier Bearing	Toyota Cressida 3.0, 3.0i (89-92)
<b>5383+5083</b>	Diff. Carrier Bearing Rear	Toyota Fortuner 2.4, 2.7i, 2.8TD, 3.0D-4D, 4.0 - 4X4 (15-16), Hilux "Revo" 2.0, 2.4, 2.8, 4.0 - 4X2, 4X4 (2016-)
<b>57307P</b>	Rear Wheel Bearing Outer	Daihatsu Rocky 2.8 - 4X4 (97-00)
<b>574298P</b>	Front Wheel Bearing Inner	Chrysler Grand Voyager 3.3 (97-04), Voyager 2.0, 2.4, 2.5, 3.3 (97-04), Jeep Wrangler 4.0 (91-96)
<b>60002RS</b>	Alternator / Generator Bearing	Daewoo Cielo 1.5 GL, GLX, GTX, 150i L, Espero 1.8 CD, C18LE, 2.0 CD, C20LE (96-99), Lanos I 1.35i S, 1.6 SX, Lanos II 1.4 S, 1.6 SX (97-03), Ford Courier 2.5 Turbo Diesel D/cab, Leisure P/up WL4 - 4X2, 4X4 (96-00), Ranger 2.5 Diesel, Turbo Diesel D/Cab, High Trail, XL, DT XLT High Trail D/Cab, Super Cab - 4X2 (00-09), Ranger 2.5 D/Cab, High Trail, XL, DT XLT High Super Cab, 2.5TD Montana D/Cab WL4, 3.0TDCi, 4.0 Super Cab XLT - 4X4 (00-12), Mazda B-Series B2500 2.5, Td LWB D/Cab, Drifter, SLX P/up WL4 Dies./Turbo Dies. - 4X4 (96-99), B2500 2.5 LWB Diesel, Turbo Diesel D/cab, Drifter, SLX P/up WL4 Dies., Turbo - 4X2 (97-00), Drifter 2.5Td LWB Hi Ride, SL SLE, SLX D/cab, Hi Ride, Hi Trail D/cab P/up WL4 Dies./Turbo Dies. - 4X2 (00-09), 2.5Td LWB D/cab, DL, SL, SLE, SLX S/cab, D/cab P/up WL4 Dies./Turbo Dies. - 4X4 (02-09)
<b>6000ZZ</b>	Alternator / Generator Bearing	Various Makes & Models
<b>60012RS</b>	Spigot Shaft Bearing	Toyota Cressida GX60 2.0 GLi6 1G-E, GX7 2.0 GLi6 1G-E, 1G-FE (83-92), MX75 3.0i ECT, GLS 7MG-E (86-92), TUV KF20 1.3 Chassis Cab, P/up, P/van, Bus 4K Pet., 1.5 P/up 5K Pet. (82-87), Venture YF50 1.8 8/10 Seater P/van 2Y Pet., 2.2 10 Seater, GLE, Getaway 9 Seater S/W 4Y Pet., LF50 2.4D 10 Seater S/W 2L5F Dies. (91-04)
<b>6001ZZ</b>	Spigot Shaft Bearing	Toyota Corolla TE71 1.6 P/van 2T (83-89), KE70 1.3 P/van 4K (84-88), Cressida TX30 1.8 DX 3T (80-89), RX60 2.0 GL, GLE, GLX, S/W 21R, RX70, YX72 2.0 GL, GL, GLE, GLX (81-92)
<b>60022RS</b>	Spigot Shaft Bearing	Ford Husky 1.8 1 Ton P/up 4G62, 2.0 1 Ton P/up, Bus, P/van 4G63 (85-99), Honda Ballade SA4 1300 EN4 (82-85), 150 Encore, Luxline, Spreeline D15B3, 160E, i D16A7, 180E, i B18B3 (92-98), Mitsubishi L300 1.6 Mini Bus, Van 4G32 Pet., 1.8 4G62 Pet., 2.0 P/up 4G63 Pet., Starwagon 2.0 S, SL, SLE, P/up, P/van 4G63 Pet. (82-01), Suzuki Swift 1.5i GL, GLS M15A, 1.5 RS415 (08-11), SX4 1.6 GL, GLX, MA16A (2014-), 2.0i Hatch J2OA, J2OB - 4X2 (2008-)
<b>6002ZZ</b>	Alternator / Generator Bearing	Various Makes & Models
<b>60032RS</b>	Alternator / Generator Bearing	Opel Astra G 1.6 CS, Classic CD, CDE, Comfort C16SEL, 1.8 Classic CDE, Caravan CD S/W, Elegance, Irmscher X18XE1, 2.0 Coupe', CSX X20XEV, 2.2i Classic Exec. (99-06), Zafira I 1.8i CD, Enjoy, Elegance MPV Z18XE/-1 (01-05)
<b>6003ZZ</b>	Alternator / Generator Bearing	Various Makes & Models
<b>60042RS</b>	Alternator / Generator Bearing	Various Makes & Models
<b>6004ZZ</b>	Alternator / Generator Bearing	Various Makes & Models
<b>60052RS</b>	Alternator / Generator Bearing	Various Makes & Models
<b>6005ZZ</b>	Alternator / Generator Bearing	Various Makes & Models
<b>6006 2RS/C4</b>	Prop shaft support brg.	Mercedes-Benz 200, 220, D, 230, 230/4, 230/6, 240D, 250SE, 280, E, S, SE (68-77)



## BUYERS GUIDE - LOOSE BEARINGS

<b>60062RS</b>	Propshaft Support Bearing	BMW 3 Series E30 316 1.8 M10, 316i 1.6 M40, 318i 1.8 M40, 320i M20/50, 323i M50, 325i M52, 333i M30 (83-92), E36 316i 1.8 Dolphin Shape M40, 318i 1.9 M44, 320i 2.0 M50, 323i 2.5 M52, 325i M50, 328i 2.8, 3.0 M52, Z3 2.8, 3.0 Roadster (92-00), E37 M3 M Coupe S50 (93-01), 5 Series E28 520i 2.0 M20, 525e 2.5 M30, 528i 2.8 M30, 535i 3.0 M30 (83-89), E34 520i 2.0 M50, 525i 2.5 M50, 530i 3.0 M60, 535i 3.5 M30, 540i 4.0 M60 (90-00), 7 Series E23 728, i M30, 730 M30, 733i M30, 735i M90, 745i M88 (78-89), E32 730i M30/60, 735i M106, 740i M60, 750iL M70 (87-95), M5 Coupe M30, M5 Coupe MS38 (86-94), Mercedes-Benz W123 200 M115.938/9, 240D M616.912, 250 M123.920/1, 280E M110.983, 300D M617.912 (77-86), W124 200E M102.922, 220E M111.960, 230E M102.982, 260E M103.940, 280E M104.942, 300D M103.985, M606.910, 320 Sportline M104.922 (86-96), W124 E Class E200 M102.922, E220 M111.960, E320 Sportline, M104.992 (93-96), W124 280SE M110 987/9, 300SE M103.981, 380SE M116.963, 420SE M116.965, 500SE M117.965 (86-93), W201 190E 1.8 M102.920, 2.0 M102.922, 2.3 Sportline M102.983 (93-94)
<b>6006ZZ</b>	Alternator / Generator Bearing	Various Makes & Models
<b>60072RS</b>	Propshaft Support Bearing	Mazda E2000, E3000 (67-80), T2000, T3000 (81-86)
<b>6007ZZ</b>	Alternator/Generator Bearing, Spigot shaft brg.	Various Makes & Models
<b>603011+49</b>	Front / Rear Wheel Bearing Inner / Outer	Land Rover 110 SERIES II, IIA, III 2.6 LWB P/up 6 Cyl. OHI SE Pet., 3.5 LWB "PUP" P/up V8 ADE236 Pet. (84-96), Defender 90 2.5 TDi Country, 2.8i CSW S/W, 3.5 CSW S/W, Defender 110 2.5 TD, i TD5 Storm, 2.8, i CSW S/W, 3.5 CSW S/W (89-04), Defender 130 2.2 TD, 2.4 TD, 2.5 TD5, Defender 110 2.2 TD, 2.5 TD, I (2002-), Defender 130 2.5TD, i TD5 Storm, 3.5 CSW S/W, Discovery 2.5TD, i TD5 ES, GS, XS, S S/W, 3.5 P/up, S/W, 3.9i ES, S P/up, S/W (89-04), Defender 130 2.2 TD, 2.4 TD, 2.5 TD5 (2002-), Range Rover 3.5 V8, Vogue S/W Pet., 4.6 V8 HSE S/W Pet. (79-04), Nissan 1-Tonner/Hardbody AW/D21 2.4 Z24S - 4X4 (88-98), 2.7 TD27, 3.0 VG30E (90-99), 720 D20 1.8 L18S, 2.0 NA20, 2.2 Z22 - 4X4 (80-88), Hardbody QW/D22 2.4i KA24E, 2.7 TD27, 3.0 VG30E, 3.0TD ZD30, 3.2, 3.2D QD32, 3.3i VG33 - 4X4 (98-10), NP300 D22 2.4i, S/C, D/C Highrider KA24 DE, 2.5TDi, S, SE Highrider YD25 - 4X2, 4X4 (2008-), Patrol Y60 3.0 VG30E - 4X4 (95-00), Y61 3.0Di, 4.2 TD42 - 4X4 (99-04), Sani AW/D21 2.2 Z22, 2.4 Z24, 2.7 TD27, 3.0 VG30E - 4X4 (86-98), Terrano II 2.7 TD27 - 4X4 (00-02), Tata Safari 2.2 CRDi GLX Dies. - 4X4 (2007-), Telcoline 2.0 Turbo Diesel S/Cab, D/cab P/up - 4X4 (04-10)
<b>6072RS</b>	Sliding Door Bearing	Various Makes & Models
<b>607ZZ</b>	Sliding Door Bearing	Various Makes & Models
<b>6082RS</b>	Sliding Door Bearing	Various Makes & Models
<b>608ZZ</b>	Sliding Door Bearing	Various Makes & Models
<b>6092RS</b>	Sliding Door Bearing	Various Makes & Models
<b>609ZZ</b>	Sliding Door Bearing	Various Makes & Models
<b>62002RS</b>	Alternator / Generator Bearing	Daihatsu Charade 0.8 CX, CXL G11 CB22, Turbo G21 CB60 (83-85), Nissan Langley 1.3 GL E13, 1.5 GL, L, SSS, Trebon, Exa Turbo E15 (83-88), Laurel C31 2.0 CA/L20, 2.8 SGL 5L28 (80-87), Pulsar 1.3 S E13, 1.4 DL, GX A14, 1.5 GL, Panache, SX E15 (80-87), Stanza 1.6 DL, Resort, S/W L16, 1.8 GL, Resort, S/W SSS L18 (80-84), Skyline R30 1.8 L18, 2.0 GL L20 (82-87), 2.8 GLX, GTX L28/2 (83-86)
<b>6200ZZ</b>	Alternator / Generator Bearing	Chevrolet 1300, 1900 (75-78), Firenza (71-75), Hatch (76-78), Fiat 128 (71-84), 131 (77-80)
<b>6201 V-RS</b>	Alternator/Generator Bearing	Ford Courier 2.2 (86-96), Mazda B2200 (86-96)
<b>62012RS</b>	Alternator / Generator Bearing / Spigot Shaft Bearing	Audi 100/4 1.6 LS YV, 100/5 1.9 WH, 200 2.1 GLS, GLX, 400 1.8 JW, 500 2.1/2.2 WB, WC SE PR (77-92), BMW 3 Series E30 316 1.8 M10, 316i 1.6 M40, 318i 1.8 M40, 320i M20/50, 323i M50, 325i M52, 333i M30 (83-92), E36 316i 1.8 Dolphin Shape M40, 318i 1.9 M44, 320i 2.0 M50, 323i 2.5 M52, 325i M50, 328i 2.8, 3.0 M52, Z3 2.8, 3.0 Roadster (92-00), E37 M3 M Coupe S50 (93-01), 5 Series E28 520i 2.0 M20, 525e 2.5 M30, 528i 2.8 M30, 535i 3.0 M30 (85-89), E34 520i 2.0 M50, 525i 2.5 M50, 530i 3.0 M60, 535i 3.5 M30, 540i 4.0 M60 (90-00), 7 Series E23 728, i M30, 730 M30, 733i M30, 735i M90, 745i M88 (78-89), E32 730i M30/60, 735i M106, 740i M60, 750iL M70 (87-95), E38 740i M60/62, 750iL M70 (95-03), 8 Series E31 850iL V12 M70 (91-94), M5 Coupe M30, M5 Coupe MS38 (86-94), C.A.M. Inyathi Jinbei Haise Minibus 2.2i Std. (2007-), Daihatsu Charade 0.8 CX, CXL G11 CB22, Turbo G21 CB60 (83-85), Ford Bantam 1300 P/up Kent 2V, 1400 Leisure, Nite P/up CVH/FUA, 1600 Leisure Explorer, Nite P/up CVH (83-94), 130 Explorer P/up B3, 160, i Explorer, Leisure, Sport, P/up B6/ F6 (94-03),

# BUYERS GUIDE - LOOSE BEARINGS

<p><b>62012RS... Continued</b></p>	<p>Alternator / Generator Bearing / Spigot Shaft Bearing</p>	<p>Cortina MkIII 1.6 L P/up Kent, 1.6 L, Std., XL Kent, 2.0 OHC GT, V4 L, XL, S/W Essex EV20, 2.0 V4 P/up Koln T20, 2.5 L P/up Essex EV25, 2.5 XL, S/W Essex EV25, 3.0 GT, L, XL, XLE "Big Six" Essex EV30 (71-77), Cortina MkIV 1.3 L Kent, 1.6 GL, L, S/W Kent, 1.6 P/up Kent, 2.0 GL, GLE, S/W Koln T20, 3.0 V6 Ghia, GLS, S, S/W Essex EV30, 3.0 V6 Leisure, P/up Essex EV30 (77-80), Cortina MkV 1.3 L Kent, 1.6 GL, L, Kent, 1.6 P/up Kent, 2.0 Ghia, GL Koln T20, 2.4 P/up York D24, 3.0 V6 GLS, GLS XR6, Essex EV30, 3.0 V6 Leisure P/up Essex EV30 (80-86), Courier 1.6 P/up F6, 1.8 Chassis cab, Explorer, Std., XLT P/up F8., 2.0 XLT FE., 2.2 D/cab, Explorer, Leisure, Std., XLT P (86-00), 3.0 V6 Std., XLT, D/cab, Leisure, Explorer, Exec. P/ up Essex - 4X4 (97-00), Escort MkI/II 1.1 300 P/van Kent, 1.3 30, 35, 45 P/van Kent, 1.6 45 P/van Kent (68-81), Escort RWD MkII 1.3 L Kent, 1.6 GL, Sport Kent, RS2000 Koln (75-81), Escort FWD MkIII 1.3 GL, L Kent, 1.6 GLE, L, Sport, XR3, i HL16CVH (81-86), Husky 1.8 1 Ton P/up 4G62, 2.0 1 Ton P/up, Bus, P/van 4G63 (85-99), Laser 1.3 L, GL, 13, Dash E3 / B3, Tracer 1.3 Sedan, H/back -Tonic, Plus B3 (91-02), Laser 1.6, i GL, 16, Sport, TX3 B6/ F6, 2.0, i RS FE, Tracer 1.6 Sedan, H/back - Plus, Sport, Tonic B6/F6 (86-02), Meteor 1.3 GL, L, 13 E3/B3, 1.4 LX CVH, 1.5 GL, GLS E5, 1.6, i GL, GLE, GLi, 16, Sport B6/CVH/F6, 2.0 8/16V GLE, GLi FE (91-95), Ranger 1.8 XL, P/up, 2.2 XL, P/up - 4X2 (00-05), 1.8 XL, P/up, 2.2 XL, P/up - 4X4 (04-10), Sapphire 1.6 L Kent (89-93), Sierra 1.6 GL, GL S/W, L Kent, 2.3 GLE, Cologne (83-93), Spectron 2.2 Bus, P/van F2 (94-99), Isuzu KB20 1.6 P/up G161Z Pet., KB21 1.6 P/up G161Z Pet., KB22 1.8 P/up G180Z Pet. (78-83), KB23 2.0 P/up G200Z, KB24 2.3 LE 4ZD1, KB25 1.6 P/up G161Z, KB26 1.6 P/up G161Z, 1.8 P/up G180Z (79-83), KB40 1.6 G161Z, KB41 1.6 G161Z, 1.8 G180Z, KB42 1.8 G180Z, KB43 2.0 G200Z, KB44 2.3 4ZD1 - 4X4 (79-89), Relay 1.3 Sedan, Bus 4ZC1 (89-95), Mazda 323 FWD 1.3 S, H/back, Sedan E3, 1.5 GLC, SL, SLX, Sport H/back, Sedan E5 (81-88), 1.3 L, H/back, Sedan E/B3, 1.5, L H/back, Sedan E5, 1.6 EG i Hatch, L, Sedan, SL Hatch, SL Sedan, Sport Hatch B6i/F6 (84-91), 2.0 EG i Hatch, SLE Hatch, SLi Sedan, 200e Hatch, Sedan, 200i Hatch 8/16V FE-2000 (89-95), 130 Hatch, Midge, Sedan, Sting B3, 160, i, S Hatch, Midge, Sedan, Sting F6 (90-95), 130 Hatch, Midge, Sedan, Sting B3, 160, i, S Hatch, Midge, Sedan, Sting F6, 200i, e Hatch 8/16V FE 2000 (95-05), 626 1.6 S Sedan, Hatch F6, 1.8 L Sedan, Hatch F8, 2.0 SL, SLE, SLX, 2.0i EG i, SLi FE (Rear Drum brakes) (83-93), 2.0i 16V SLi FE (Rear Disc brakes) (89-93), B-Series B2000 2.0 SWB P/up MA Pet., B2200 2.2 SWB/LWB P/up S2 Dies. (82-86), B2600 2.6 LWB D/cab, Magnum, Drifter P/up 4G54 Pet., B2600i 2.6i LWB D/cab Drifter, SLX P/up 4G54 Pet. - 4X2 (86-01), B2600 2.6 V6 LWB D/cab, Magnum, Drifter P/up 4G54 Pet. - 4X4 (86-95), B2600i 2.6i V6 LWB Drifter, D/cab Drifter SLX P/up 4G54 Pet. - 4X4 (00-09), B3000 3.0 V6 LWB D/cab, Magnum, Drifter, Magnum Drifter P/ up Essex Pet. 4X4 (86-97), B1600 1.6 SWB Magnum P/up F6 Pet., B1800 1.8 SWB/ LWB Magnum, Drifter P/up F8 Pet. (86-00), B2000 2.0 LWB Drifter, Magnum P/up FE Pet., B2200 2.2 LWB D/cab, Drifter, Magnum P/up R2 Dies., 2.2 LWB D/cab, Drifter, Magnum P/up F2 Pet. (86-00), Drifter 1.8 SWB/LWB XL P/up Pet., 2.2 SWB/LWB XL P/up Pet. (00-09), 2.6i LWB Hi Ride, SL Hi Ride S/cab, SLE, SLX D/cab SLX Hi Ride D/cab, SLX Hi Trail D/cab P/up Pet. - 4X2 (00-09), 2.6i V6 LWB SL S/cab, SLE, SLX D/cab P/up 4G54 Pet. - 4X4 (02-09), Marathon 2.2 LWB Bus, P/van F2 Pet. (91-04), Rustler 1.3 SWB P/up Kent 2V Pet., 1.4 SWB P/up CVH/FUA Pet., 1.6 SWB, LX P/up CVH/ LUC Pet. (86-94), 130 SWB Drifter, Explorer P/up B3 Pet., 160, i SWB Explor- er, Drifter P/up F6/B6i Pet. (94-02)</p>
<p><b>62012RS... Continued</b></p>	<p>Alternator / Generator Bearing / Spigot Shaft Bearing</p>	<p>Mercedes-Benz W123 200 M115.938/9, 230, E M115.954, 240D M616.912, 250 M123.920/1, 280E M110.983, 300D M617.912 (77-86), W124 200E M102.922, 220E M111.960, 230E M102.982, 260E M103.940, 280E M104.942, 300D M103.985, M606.910, 320 Sportline M104.922 (86-96), W124 E Class E200 M102.922, E220 M111.960, E320 Sportline, M104.992 (93-96), W126 280SE M110 987/9, 300SE M103.981, 380SE M116.963, 420SE M116.965, 500SE M117.965 (86-93), W140 S-Class S320 M104.990, S420 M119.971, S500 M119.980 (93-99), W201 190E 1.8 M102.920, 2.0 M102.922, 2.3 Sportline M102.983 (93-94), W202/3 C-Class C180 Classic M111.920, C200 M111.941, C220 M111.961, C230 M111.974, C240 M111.944, C250 M605.910, C270CDi M612.962, C280 M104.941 (94-08), Mitsubishi Canter 2.5 SWB/LWB D/side, Chassis cab 4G55 Dies., 2.6 4G54 Pet., 3.3 4D30A Dies., 3.8 ADE236 Dies. (80-97), Colt LDV 1.6 SWB/LWB Lo-Line P/up 4G32 Pet., 2.0 4G63 Pet., 2.5D 4D56 Dies., 2.6 WB Hi-Line P/up 4G54 Pet. (94-98), 2.5D LWB Hi-Line P/up 4D56 Dies., 2.6 LWB Lo-/Hi-Line, P/up 4G54 Pet., 3.0 V6 LWB Lo-/ Hi- Line D/cab, Rodeo 6G72 Pet. - 4X4 (95-98), L300 1.6 Mini Bus, Van 4G32 Pet., 1.8 4G62 Pet., 2.0 P/up 4G63 Pet., Starwagon 2.0 S, SL, SLE, P/up, P/van 4G63 Pet. (82-01), Pajero 2.8 Tdi, 3.0 V6 SWB GLS Wagon 6G72 Pet., 3.5 V6 SWB GLS Wagon 6G74 Pet. - 4X4 (90-01), Nissan 1-Tonner/Hardbody AW/D21 1.6 L16S-J, 1.8 L18S-R, 2.0 NA20, 2.4 Z24/S, 2.5D TD25i, 2.7D TD27, 3.0 VG30E (88-98), 2.4 Z24S, 2.7 TD27, 3.0 VG30E - 4X4 (90-99), B140 1.4 A14SP/van, S/W, Deluxe, Std. Sport, CHAMP P/up (80-08), E20 1.8 L18 Bus, P/van Coach, Coach GL, GLE, Econolux, Ekonovan, Ekonowagon, 2.0 Bus, Van H20 (80-96), Patrol Y60 3.0 VG30E - 4X4 (95-00),</p>

# BUYERS GUIDE - LOOSE BEARINGS

<p><b>62012RS... Continued</b></p>	<p>Alternator / Generator Bearing / Spigot Shaft Bearing</p>	<p>Primera 160 Si, SE SR16DE, 200 GSi, Si , STi, Elegance, Luxury SR20DE (98-02), Sabre 160 GX, GXi GA16DS, 200 GXi SR20DE (94-02), Sani AW/D21 2.4, i Z24, 2.5 TD25, 2.7D, TD TD27, 3.0 VG30E (89-99), 2.2 Z22, 2.4 Z24, 2.7 TD27, 3.0 VG30E - 4X4 (86-98), Sentra 1.3 GL, SX E13S, 1.6 GL, GX, GXE GXEi Coupe, SGLi E16E/S (87-92), 140, i, GX, GXi, Si GA14DNE / DS, 160 GSi, GX, GXi, SE, Si GA16DE/DNE/ DS (92-02), Stanza 1.6 DL, Resort, S/W L16, 1.8 GL, Resort, S/W SSS L18 (80-84), Skyline R31 2.0 GL, GLE CA20, 2.0 SGi, SGLi RB20E, 3.0 SGLi RB30E With I.R.S. (87-92), Opel Ascona 1.3 L 13NV/SC, 1.6 GL 16SH, 1.8 GLS 18L (82-87), Kadett D, E 1.2 L 12NS, 1.3 Cub, GL, GLS, LS, Rebel 13NV, 140 CL, Cub 14NE/ NV, 1.6 GL, GLS, GSE, L, Rebel, Cub 16SH/ SE, 160i, GSi Aspen 16SE (80-93), Rekord 2.0 Berlina, GL, GLS, L, S/W CIH, 2.0i CLE, CLS, GL, GLE, Irmischer, 2.2E CIH, 380i, V6 CD, GSi 38GE (82-95), Renault R5 1.3, GTL, LS, LSS, TS 810-25, 1.4 TS 847-C2J, 1.3 Panel Van 810-25 (75-85), R9 1.4 GTL, TL, TSE C1/2/3J, 1.7 TXE F2/3N, R11 1.4 TS, TX, TXE C1/2/3J, 1.7 TX, TXE F2/3N (83-86), Toyota Camry I SXV10/11 R 200i Si 3S-FE, 220 SEi, Si, 5S-FE (92-01), MCV10/ VCV10 300SEi 1MZ-FE / 3VZ-FE, Quad Cam (94-01), Condor 1.6 Estate, TE, 5L, 1.8 2Y, 2.0i Estate, TE, 1RZ Pet., 2.4i Estate, TE, TX 2RZ-E, 3.0D Estate, TE, 5L Dies. - 4X2, 2.4i Estate, TX Estate 2RZ-E, 3.0 Estate, TX Estate 5L - 4X4 (00-05), Conquest / Tazz EE80 1.3 GL, GS, L, S 2EL, EE90R 130 Sport, Tazz, Edition, Zipp, Tropique, Tazz EE90R 130 Edition, Ruby, Tropique, Sport, McTazz, XE 2E (85-06), AE82R 1.6 GL, RS, RSi 4A-L, A-GEL, AE92R 160i LS, RS, RSi, Sport, RSE, Tazz 4A-F, A-FE, A-GE, AE92R 160i Edition, Sport, Tazz, XE 4AFE (85-06),</p>
<p><b>62012RS... Continued</b></p>	<p>Alternator / Generator Bearing / Spigot Shaft Bearing</p>	<p>Conquest EE90 130 Carri P/van, 2E (98-06), Corolla RWD TE31 1.6 Sprinter, SR4/5, Black Hawk, Silver Wolf 2T, AE/TE71 1.6 GL, S/W, GLS Sprinter, SE 2T, TB TE72, 1.8 GLS, SE 3T (80-88), TE71 1.6 P/van 2T (83-89), KE70 1.3 P/van 4K (84-88), AE82R 1.6 GL, GLE, GLi, GLS, GLX, Avante, GLE, GLi, S/W 4A-L, A-GEL (84-88), AE/EE80R 1.3 GL, L, 2A-L, E-L, EE90R 1.3 GL, GLE, L, Sprinter 2E-L, E (84-96), AE92R 1.6, 160 GL, GLE, GLi, Exec., GLS, Exec., GLX, Sport Sprinter 4A-F, A-FE, A-GE (88-96), Cressida TX30 1.8 DX 3T, TX62 1.8 L, LS 3T, YX70 1.8 LS, Exec. (80-89), RX60 2.0 GL, GLE, GLX, S/W 21R, RX70, YX72 2.0 GL, GL, GLE, GLX (81-92), GX60 2.0 GLi6 1G-E, GX7 2.0 GLi6 1G-E, 1G-FE (83-92), MX63 2.8i 5M-E, MX73 2.8i RSi, RSi Exec. 5M-GE (84-89), MX75 3.0i ECT, GLS 7MG-E (86-92), RX72 2.4 GL, GL S/W, GLE, GLE S/W 22R (87-92), RX73 2.4 GLE, GLE S/W 22R With I.R.S. (Independent Rear Suspension) (87-92), Hiace YH50/60 1.8 SWB / LWB P/van, LS Wagon 2Y Pet. (83-91), YH51/61 2.0 SWB/LWB 16 Seater Commuter, Super 10 Seater Custom Wagon, P/van 3Y Pet. (83-86), YH53/63 2.2 SWB/LWB P/van, Van, LS, GLX, Exec. Wagon 4Y Pet. (All Imp. Models) (86-88), YH53/63 2.2 SWB/LWB P/van, Van, LS, Super T/14/16, GLX, Exec. Wagon, Siyaya Bus, P/van 4Y Pet. (All Local Models) (88-09), Hilux LN30/40/50/51/55 2.2 SWB/LWB P/up L Dies., 2.4 SWB/ LWB D/cab, Raider P/up 2L Dies., YN58 2.2 LWB D/cab, Raider, SRX P/up 4Y Pet. (79-98), YN67 2.2 LWB D/cab, Raider D/cab P/up 4Y Pet. - 4X4 (86-94), YN51/56 1.8 SWB/LWB D/cab, S, SR, Raider P/up 2Y Pet., YN140 1.8 SWB/LWB D/cab, Raider, S, SRX P/up 2Y Pet. (86-05), LN65 2.4 LWB D/cab, Raider D/cab P/up 2L Dies. - 4X4 (89-98), RN67 2.4 LWB D/cab, Raider D/cab P/up 22R Pet. - 4X4 (94-98), RN58 2.4 22R Pet., LN140/145 2.4i DLX, P/up 2L Dies., RZN194 2.7i LWB D/cab, Raider, SRX, Legend35 Raider, 3RZFE Pet. (94-05), LN57 2.8D LWB D/cab, Raider P/up 3L Dies. - 4X2, LN67 2.8D LWB, D/cab, Raider D/cab P/up 3L Dies. - 4X4 (95-98), RZN147 2.0 SWB/LWB D/cab, DLX, Raider, S, SR, SRX P/up 1RZ Pet., LN192R 3.0D LWB Raider D-E, Raider DLX D/cab D-E, Legend35 Raider, P/up 5L Dies., 3.0iD LWB Raider, Raider D/cab, P/up KZ-TE Dies. (98-05), RZN169 2.7i LWB D/cab, DLX S/cab, Raider S/D/cab, SRX D/cab, Legend 35 LWB P/up 3RZFE Pet., LN167 3.0D D/cab D-E, DLX, S/D/cab DE, Raider DE, Legend35 LWB P/up 5L Dies., 3.0iD LWB Raider S/cab &amp; KZ-TE D/cab P/up, Legend35 - 4X4 (98-05), Land Cruiser FJ80 4.0 DLX, GX, VX P/up 3F/F-E Pet. - 4X4 (90-92), PHJ75 3.9 DLX, GX, GX Turbo P/up Perkins236 2H Dies., FJ75 4.0 DLX, GX, VX 3F/F-E Pet., HJ75 - 4X4 (85-92), Quantum 2.5 D-4D, "Family", S-long MPV, Van 2KD-FTV Dies., 2.7 "Family", S-long "Ses'fikile" MPV, Van 2TR-FE Pet. (2005-), Stallion YF50 1.8 SR5, P/up, P/van, Van 2Y Pet., LF50 2.4D P/ up 2L5F Dies. (87-04), Stout RK110 2.0 SWB P/up 5R Pet. (79-89), Tuv KF20 1.3 Chassis Cab, P/up, P/van, Bus 4K Pet., 1.5 P/up 5K Pet. (82-87), Venture YF50 1.8 8/10 Seater P/van 2Y Pet., 2.2 10 Seater, GLE, Getaway 9 Seater S/W 4Y Pet., LF50 2.4D 10 Seater S/W 2L5F Dies. (91-04), VW Caddy 1.6 SWB, Caddy Club P/up JK Dies., HM Pet., 1.8 SWB L, Sport P/up HV Pet. (81-87), 1.6i Club, Citi, P/up HM Pet. (97-03), Citi Golf 1.3 L ET/GY, 1.6 Blues, Chico, Chico Lux, Deco, Designa, L, Ritz, Shuttle, Sonic, Sport HM, HV, FR, 1.6iL, Life, VeloCiti, TenaCiti, CitiStorm, - Sport, - Rox, Rhythm, MKI AFX, 1.8 CTi, Designa, L Sport BZF (83-09), Fox 1.3 L, L Trippa GY, 1.6 L HM, 1.8 L Sport HV (87-96), Golf I 1.1 GL, L, LS ET/EG, 1.3 GL, L, LS GF, 1.5 GL Diesel, GLS, LS CK/ EM/ JB, 1.6 GL Diesel, GT, GTS, GTX JK/ CR FR, 1.8 GTi EV (78-84), Golf II 1.3 CL GY, 1.6 CSL HM, 1.8 8/16V CSX, GTS, GTi KR, EV, 2.0 8/16V GTi AAL (84-92), Golf III 1.8 GSX, GTS ACH, 2.0 GTi, Exec. 2E, 2.8 VR6, Exec. AAA (92-99)</p>



## BUYERS GUIDE - LOOSE BEARINGS

<p><b>62012RS... Continued</b></p>	<p>Alternator / Generator Bearing / Spigot Shaft Bearing</p>	<p>Jetta I 1.3 GL, GX ET/ GF, 1.5 GLS/ GLX JB, 1.6 GLS EM, 1.8 GLi DX (80-85), Jetta II 1.6 CSL HM, 1.8 8/16V CLi, CLi Exec., CLX, CSI, CSX EV/KR, 2.0 8/16V CLi, Exec. AAL (85-92), Jetta III 1.6 CSL ACG, 2.0 CLi, Exec. 2E, 2.8 VR6 Exec. AAA (92-99), Kombi T2 2.0, L Exec., Microbus, Kamper, P/up, P/van CU, CJ Pet., T3 1.9 Microbus, P/van DG Pet. (75-89), T3 2.1 Fi Caravelle, Microbus DJ Pet., 2.3i Microbus, Volksiebus AFU Pet., 2.5i Microbus, Caravelle AAY Pet., 2.6i Microbus, Caravelle, Exclusive, ADV Pet. - 4X2 (85-04), T3 2.1 Fi Syncro Caravelle DJ Pet. - 4X4 (89-93), Passat I &amp; II 1.3 L, LS H/back, Sedan, Variant ZF, 1.5 GL, LS Fastback, S/W CK, 1.6 GL, GLS, LS, LX Fastback, S/W, Sedan, Coupe, Variant, YN/YP/WN, 1.8 CL Sedan, S/W JV/KR (74-87), 1.9 GLS H/back, GLX Sedan, S/W WN, 2.2 CLi, CLX SG/MX (81-87), Polo 6N 1.4 Classic, Playa Lux AEX, 1.6 Classic, Playa, Lux AEE (96-03)</p>
<p><b>62012RSC3</b></p>	<p>Alternator/Generator Bearing</p>	<p>Toyota Camry 2.0, 2.2 (92-01), Dyna 2.0, 2.2, 2.4 (85-95)</p>
<p><b>6201ZZ</b></p>	<p>Alternator / Generator Bearing / Spigot Shaft Bearing</p>	<p>BMW 3 Series E30 316 1.8 M10, 316i 1.6 M40, 318i 1.8 M40, 320i M20/50, 323i M50, 325i M52, 333i M30 (83-92), , E36 316i 1.8 Dolphin Shape M40, 318i 1.9 M44, 320i 2.0 M50, 323i 2.5 M52, 325i M50, 328i 2.8, 3.0 M52, Z3 2.8, 3.0 Roadster (92-00), E37 M3 M Coupe S50 (93-01), 5 Series E28 520i 2.0 M20, 525e 2.5 M30, 528i 2.8 M30, 535i 3.0 M30 (85-89), E34 520i 2.0 M50, 525i 2.5 M50, 530i 3.0 M60, 535i 3.5 M30, 540i 4.0 M60 (90-00), 7 Series E23 728, i M30, 730 M30, 733i M30, 735i M90, 745i M88 (78-89), E32 730i M30/60, 735i M106, 740i M60, 750iL M70 (87-95), M5 Coupe M30, M5 Coupe MS38 (86-94), Fiat Uno 1.4 Turbo 146A (90-98), 1.0 Cento 156A2, 1.1 Espresso P/van 160A3, 1.1 Fire, Rio, Mia, Tempo 160A3, 1.4 Pacer, Beat, Mia, Tempo, SX 146C1 (90-05), Ford Laser 1.6, i GL, 16, Sport, TX3 B6/ F6, 2.0, i RS FE (86-95), Tracer 1.6 Sedan, H/back – Plus, Sport, Tonic B6/F6 (95-02), Meteor 1.6, i GL, GLE, GLi, 16, Sport B6/CVH/F6, 2.0 8/16V GLE, GLi FE (86-95), Sapphire 2.0, i GL, GLE, GLEA, GLi, GLi Exec. Koln (89-93), Sierra 2.0 GL, GL S/W Koln, 2.0 LX Koln (83-93), Honda Ballade SA4 1300 EN4 (82-85), Nissan 720 D20 1.8 L18S Kingcab, Sport, 2.2D SD/Z22 Tracker, 2.3 SD23 - 4X2, 1.8 L18S, 2.0 NA20, 2.2 Z22 - 4X4 (80-88), Stallion KF50 1.5 SR5,Commuter, Bus, P/up, P/van 5K Pet. (87-04), Golf III 1.8 GSX, GTS ACH, Jetta III 1.8 CLX/ CSX ACH (92-99), Polo 6N 1.8 Classic, Playa, Lux ADZ (96-03)</p>
<p><b>6202 2RS C3</b></p>	<p>Alternator/Generator Bearing, Spigot shaft brg.</p>	<p>Daewoo Cielo 1.5, Espero 1.8, 2.0 (96-98), Lanos 1.35i, 1.6 (97-00), Lanos II 1.4, 1.6 (00-02), Nubira 1.6, 2.0 (97-00), Nubira II 1.6, 2.0 (00-02), Ford Capri 3.0 (70-73), Mercedes-Benz 200, 220, D, 230, 240D, 250SE, 280S, SE (68-73), Toyota Dyna 4.0 (85-88)</p>
<p><b>62022RS</b></p>	<p>Alternator / Generator Bearing / Diff. Carrier Bearing / Spigot Shaft Bearing</p>	<p>Daewoo Cielo 1.5 GL, GLX, GTX, 150i L, Espero 1.8 CD, C18LE, 2.0 CD, C20LE (96-99), Lanos I 1.35i S, 1.6 SX, Lanos II 1.4 S, 1.6 SX (97-03), Ford Cortina MkIII 2.0 OHC GT, V4 L, XL, S/W Essex EV20, 2.0 V4 P/up Koln T20 (71-77), Courier 3.0 V6 D/cab, Explorer, L, Leisure, Std., P/up Essex (86-97), 3.0 V6 Std., XLT, D/cab, Leisure, Explorer, Exec. P/up Essex - 4X4 (97-00), Laser 1.6, i GL, 16, Sport, TX3 B6/ F6, 2.0, i RS FE, Tracer 1.6 Sedan, H/back – Plus, Sport, Tonic B6/F6 (86-02), Sapphire 3.0 Ghia, GLX Essex, Sierra 2.0 LX Koln (89-93), Honda Ballade SH4 150 16V SOHC D15B3, 160i 16V SOHC, DOHC D16A9 (89-92), Isuzu KB20 1.6 P/up G161Z Pet., KB21 1.6 P/up G161Z Pet., KB22 1.8 P/up G180Z Pet., KBD20 2.0 P/up C190, KBD21 2.0 P/up C190, KBD22 2.2 LE, P/up C223, KB23 2.0 P/up G200Z, KB24 2.3 LE 4ZD1, KB25 1.6 P/up G161Z, KB26 1.6 P/up G161Z, 1.8 P/up G180Z, KBD23 2.5 LE, P/up 4JA1, KBD25 2.0 P/up C190 (78-89), KB27 1.8 P/up G180Z, KB28 2.0 P/up G200Z, KB29 2.3 P/up 4ZD1 (83-89), KB40 1.6 G161Z, KB41 1.6 G161Z, 1.8 G180Z, KB42 1.8 G180Z, KB43 2.0 G200Z, KB44 2.3 4ZD1, KBD40 KBD41 2.0 P/up C190, KBD42 2.2 P/up C223 - 4X4 (79-89), KB160 1.6 Fleetside P/up (89-04), KB260 2.6 LE, D/cab, LX P/up 4ZE1 (92-04), KB220 2.2 LE P/up, KB230 2.3 P/up 4ZD1, KB260 2.6 D/cab, LE, LX, KB320 3.2 V6 Frontier LX - 4X4 (89-04), KB280DT 2.8 D/cab LE, LX, Frontier P/up Turbo 4JB1 - 4X2, 4X4 (89-04), WFR 1.8 11FVX/ 12FVX Bus, P/van 4ZB1 (83-89), Mazda B-Series B2600 2.6 V6 LWB D/cab, Magnum, Drifter P/up 4G54 Pet. - 4X4 (86-95), B3000 3.0 V6 LWB D/cab, Magnum Drifter P/up Essex Pet. - 4X2 (86-97), Nissan 1-Tonner/Hardbody AW/D21 1.6 L16S-J, 1.8 L18S-R, 2.0 NA20, 2.4 Z24/S, 2.5D TD25i, 2.7D TD27, 3.0 VG30E - 4X2, 2.4 Z24S, 2.7 TD27, 3.0 VG30E - 4X4 (88-90), Patrol Y60 3.0 VG30E - 4X4 (95-00), Sani AW/ D21 2.4, i Z24, 2.5 TD25, 2.7D, TD TD27, 3.0 VG30E (89-99), 2.2 Z22, 2.4 Z24, 2.7 TD27, 3.0 VG30E - 4X4 (86-98), Opel Kadett F 160i, iS, G (93-99), Monza 160 GSi, i Aspen 16SE/ NZ, CLS 16SV (86-93), Toyota Camry I SXV10/11 R 200i Si 3S-FE, 220 SEi, Si, 5S-FE, MCV10/ VCV10 300SEi 1MZ-FE / 3VZ-FE, Quad Cam (97-01), Corolla FWD AE/EE80R 1.3 GL, L, 2A-L, E-L, EE90R 1.3 GL, GLE, L, Sprinter 2E-L, E EE110R , 130 GLE, Sprinter 2E (96-02), AE111R 160i GL, GLE, RSi, RXi 4A-FE, A-GE, AE112 180i GLE, GSE 7A-FE (96-02),</p>

# BUYERS GUIDE - LOOSE BEARINGS

<p><b>62022RS... Continued</b></p>	<p>Alternator / Generator Bearing / Diff. Carrier Bearing / Spigot Shaft Bearing</p>	<p>Hilux RN58 2.4 22R Pet., LN140/145 2.4i DLX, P/up 2L Dies., RZN194 2.7i LWB D/cab, Raider, SRX, Legend35 Raider, 3RZFE Pet. (94-05), RZN147 2.0 SWB/LWB D/cab, DLX, Raider, S, SR, SRX P/up 1RZ Pet., LN192R 3.0D LWB Raider D-E, Raider DLX D/cab D-E, Legend35 Raider, P/up 5L Dies., 3.0iD LWB Raider, Raider D/cab, P/up KZ-TE Dies. (98-05), RZN169 2.7i LWB D/cab, DLX S/cab, Raider S/D/cab, SRX D/cab, Legend 35 LWB P/up 3RZFE Pet., LN167 3.0D D/cab D-E, DLX, S/D/cab DE, Raider DE, Legend35 LWB P/up 5L Dies., 3.0iD LWB Raider S/cab &amp; KZ-TE D/cab P/up, Legend35 - 4X4 (98-05), Land Cruiser FJ80 4.0 DLX, GX, VX P/up 3F/F-E Pet. - 4X4 (90-92), FZJ/HZJ75 4.2 GX S/W, P/up 1FZF/HZ Dies. - 4X4 (91-97), FZJ80 4.5 Std., GX, VX, Turbo S/W, P/up 1FZ-FE Dies., Turbo Dies. - 4X4 (92-95), FZJ80 4.5 Std., GX, VX, Turbo S/W, P/up 1FZ-FE Dies., Turbo Dies. - 4X4 (95-06), FZJ105 4.5 Std., GX, Turbo P/up, S/W 1FZ-FE Dies., Turbo Dies. - 4X4 (95-98), FZJ105 4.5 V8 VX, Turbo P/up, S/W 2UZ-FE Pet. - 4X4 (98-06), HDJ/HZJ80 4.2 GX, Turbo S/W, P/up 1HD-FT, 1HZ Dies., T. Dies. - 4X4 (90-95), HDJ/HZJ80 4.2 Std., GX, VX, Turbo S/W, P/up 1HD-FT, 1HZ Dies., Turbo Dies. - 4X4 (95-01), HDJ100 4.2 Std., GX, VX S/W, 1HZ Pet., 4.5, 4.7 V8 - 4X4 (97-04), HZJ105 4.2 Std., GX DSL, Turbo P/up, S/W 1HZ Dies., Turbo Dies. - 4X4 (98-06), PHJ75 3.9 DLX, GX, GX Turbo P/up Perkins236 2H Dies., FJ75 4.0 DLX, GX, VX 3F/F-E Pet., HJ75 - 4X4 (85-92), UZJ100 4.5 V8 Std., GX, VX S/W, P/up 2UZ-FE Pet. - 4X4 (98-06), Prado 90/95 3.0 1KZ-TE GX, GX TDi S/W Dies., VX S/W Pet., 3.4 V6 GX, VX S/W Pet. 5VZ-FE - 4X4 (97-04), Rav4 I SXA10/11 Series 2.0 3/5 Dr. SWB SUV 3S-FE Pet. - 4X4 (94-01), Rav4 II ZCA20 1.8 SUV 1ZZFE, ACA20 2.0 SUV 1AZ-FE - 4X2, 4X4 (02-06), VW Caddy 1.6 SWB, Caddy Club P/up JK Dies., HM Pet., 1.8 SWB L, Sport P/up HV Pet. (81-97), 1.6i Club, Citi, P/up HM Pet. (97-03), Kombi T2 2.0, L Exec., Microbus, Kamper, P/up, P/van CU, CJ Pet., T3 1.9 Microbus, P/van DG Pet. (75-89), T3 2.1 Fi Caravelle, Microbus DJ Pet., 2.3i Microbus, Volksiebus AFU Pet., 2.5i Microbus, Caravelle AAY Pet., 2.6i Microbus, Caravelle, Exclusive, ADV Pet. - 4X2 (85-04), T3 2.1 Fi Syncro Caravelle DJ Pet. - 4X4 (89-93), Ford Courier 1.6 P/up F6, 1.8 Chassis cab, Explorer, Std., XLT P/up F8., 2.0 XLT FE., 2.2 D/cab, Explorer, Leisure, Std., XLT P (86-00), Escort RWD Mkl 1.1 Kent, 1.3 GT, L, Super, S/W Kent, 1.6 GT, L, XL Kent (68-75), Laser 1.3 L, GL, 13, Dash E3 / B3, 1.6, i GL, 16, Sport, TX3 B6/ F6, 2.0, i RS FE (86-95), Tracer 1.3 Sedan, H/back -Tonic, Plus B3, 1.6 Sedan, H/back - Plus, Sport, Tonic B6/F6 (95-02)</p>
<p><b>6202ZZ</b></p>	<p>Alternator / Generator Bearing / Spigot Shaft Bearing</p>	<p>Meteor 1.3 GL, L, 13 E3/B3, 1.4 LX CVH, 1.5 GL, GLS E5, 1.6, i GL, GLE, GLi, 16, Sport B6/CVH/F6, 2.0 8/16V GLE, GLi FE (86-95), Spectron 2.2 Bus, P/van F2 (91-04), Honda Ballade SA4 1300 EN4 (82-85), Land Rover 110 SERIES II, IIA, III 2.6 LWB P/up 6 Cyl. OHI SE Pet., 3.5 LWB "PUP" P/up V8 ADE236 Pet. (84-96), Mazda 323 FWD 1.3 S, H/back, Sedan E3, 1.5 GLC, SL, SLX, Sport H/back, Sedan E5, 1.3 L, H/back, Sedan E/B3, 1.5, L H/back, Sedan E5, 1.6 EG i Hatch, L, Sedan, SL Hatch, SL Sedan, Sport Hatch B6i/F6, 2.0 EG i Hatch, SLE Hatch, SLi Sedan, 200e Hatch, Sedan, 200i Hatch 8/16V FE-2000 (81-95), 130 Hatch, Midge, Sedan, Sting B3, 160, i, S Hatch, Midge, Sedan, Sting F6 (90-95), 130 Hatch, Midge, Sedan, Sting B3, 160, i, S Hatch, Midge, Sedan, Sting F6, 200i, e Hatch 8/16V FE 2000 (95-05), 626 1.6 S Sedan, Hatch F6, 1.8 L Sedan, Hatch F8, 2.0 SL, SLE, SLX, 2.0i EG i, SLi FE (Rear Drum brakes) (83-93), 2.0i 16V SLi FE (Rear Disc brakes) (89-93), B-Series B2000 2.0 SWB P/up MA Pet., B2200 2.2 SWB/LWB P/up S2 Dies. (82-86), B2600 2.6 LWB D/cab, Magnum, Drifter P/up 4G54 Pet. - 4X2 (86-95), B2600i 2.6i LWB D/cab Drifter, SLX P/up 4G54 Pet. (00-01), B1600 1.6 SWB Magnum P/up F6 Pet., B1800 1.8 SWB/LWB Magnum, Drifter P/up F8 Pet., B2000 2.0 LWB Drifter, Magnum P/up FE Pet., B2200 2.2 LWB D/cab, Drifter, Magnum P/up R2 Dies., 2.2 LWB D/cab, Drifter, Magnum P/up F2 Pet. (86-00), Marathon 2.2 LWB Bus, P/van F2 Pet. (91-04), Mercedes-Benz W123 200 M115.938/9, 230, E M115.954, 240D M616.912, 250 M123.920/1, 280E M110.983, 300D M617.912 (77-86), W124 200E M102.922, 220E M111.960, 230E M102.982, 260E M103.940, 280E M104.942, 300D M103.985, M606.910, 320 Sportline M104.922 (86-96), W124 E Class E200 M102.922, E220 M111.960, E320 Sportline, M104.992 (93-96), W126 280SE M110 987/9, 300SE M103.981, 380SE M116.963, 420SE M116.965, 500SE M117.965 (86-93), W201 190E 1.8 M102.920, 2.0 M102.922, 2.3 Sportline M102.983 (93-94), Toyota Stallion KF50 1.5 SR5, Commuter, Bus, P/up, P/van 5K Pet. (87-04)</p>
<p><b>62032RS</b></p>	<p>Alternator / Generator Bearing</p>	<p>Audi 100/4 1.6 LS YV, 100/5 1.9 WH, 200 2.1 GLS, GLX, 400 1.8 JW, 500 2.1/2.2 WB, WC SE PR (77-92), BMW 3 Series E30 316 1.8 M10, 316i 1.6 M40, 318i 1.8 M40, 320i M20/50, 323i M50, 325i M52, 333i M30 (83-92), E36 316i 1.8 Dolphin Shape M40, 318i 1.9 M44, 320i 2.0 M50, 323i 2.5 M52, 325i M50, 328i 2.8, 3.0 M52, Z3 2.8, 3.0 Roadster (92-00), E37 M3 M Coupe S50 (93-01), 5 Series E28 520i 2.0 M20, 525e 2.5 M30, 528i 2.8 M30, 535i 3.0 M30 (85-89), E34 520i 2.0 M50, 525i 2.5 M50, 530i 3.0 M60, 535i 3.5 M30, 540i 4.0 M60 (90-00), 7 Series E23 728, i M30, 730 M30, 733i M30, 735i M90, 745i M88 (78-89), E32 730i M30/60, 735i M106, 740i M60, 750iL M70 (87-95), E38 740i M60/62, 750iL M70 (95-03)</p>

# BUYERS GUIDE - LOOSE BEARINGS

<p><b>62032RS... Continued</b></p>	<p>Alternator / Generator Bearing</p>	<p>8 Series E31 850iL V12 M70 (91-94), M5 Coupe M30, M5 Coupe MS38 (86-94), Ford Bantam 1300 P/up Kent 2V, 1400 Leisure, Nite P/up CVH/FUA, 1600 Leisure Explorer, Nite P/up CVH (83-94), 130 Explorer P/up B3, 160, i Explorer, Leisure, Sport, P/up B6/ F6 (94-03), Cortina MkIII 1.6 L P/up Kent, 1.6 L, Std., XL Kent, 2.0 OHC GT, V4 L, XL, S/W Essex EV20, 2.0 V4 P/up Koln T20, 2.5 L P/up Essex EV25, 2.5 XL, S/W Essex EV25, 3.0 GT, L, XL, XLE "Big Six" Essex EV30 (71-77), Cortina MkIV 1.3 L Kent, 1.6 GL, L, S/W Kent, 1.6 P/up Kent, 2.0 GL, GLE, S/W Koln T20, 3.0 V6 Ghia, GLS, S, S/W Essex EV30, 3.0 V6 Leisure, P/up Essex EV30 (77-80), Cortina MkV 1.3 L Kent, 1.6 GL, L, Kent, 1.6 P/up Kent, 2.0 Ghia, GL Koln T20, 2.4 P/up York D24, 3.0 V6 GLS, GLS XR6, Essex EV30, 3.0 V6 Leisure P/up Essex EV30 (80-86), Escort Mki/II 1.1 300 P/van Kent, 1.3 30, 35, 45 P/van Kent, 1.6 45 P/van Kent (68-81), Escort RWD MkII 1.3 L Kent, 1.6 GL, Sport Kent, RS2000 Koln (75-81), Escort FWD MkIII 1.3 GL, L Kent, 1.6 GLE, L, Sport, XR3, i HL16CVH (81-86), Husky 1.8 1 Ton P/up 4G62, 2.0 1 Ton P/up, Bus, P/van 4G63 (85-99), Laser 1.4 L CHV-FUA (86-92), Meteor 1.4 LX CVH (86-95), Sapphire 1.6 L Kent (89-93), Sierra 1.6 GL, GL S/W, L Kent, 2.3 GLE, Cologne, 3.0, i GLS, GLX, LX, RS, XR6 Essex (83-93), Isuzu KB20 1.6 P/up G161Z Pet., KB21 1.6 P/up G161Z Pet., KB22 1.8 P/up G180Z Pet., KB23 2.0 P/up G200Z, KB24 2.3 LE 4ZD1, KB25 1.6 P/up G161Z, KB26 1.6 P/up G161Z, 1.8 P/up G180Z, KBD23 2.5 LE, P/up 4JA1, KBD25 2.0 P/up C190 (78-89), KBD26 2.0 P/up C190, KBD27 2.2 C223, KBD28 2.5 4JA1 (81-89), KB27 1.8 P/up G180Z, KB28 2.0 P/up G200Z, KB29 2.3 P/up 4ZD1 (83-89), KB40 1.6 G161Z, KB41 1.6 G161Z, 1.8 G180Z, KB42 1.8 G180Z, KB43 2.0 G200Z, KB44 2.3 4ZD1, KBD40 KBD41 2.0 P/up C190, KBD42 2.2 P/up C223 - 4X4 (79-89), KB160 1.6 Fleetside P/up, KB200 2.0 LE, Fleetside, D/cab P/up, KB220 2.2 LE, P/up, KB230 2.3 D/cab P/up (89-04), KB260 2.6 LE, D/cab, LX P/up 4ZE1, KB320 3.2 LE, D/cab, LX, Frontier, Reef, Blazer P/up 6VD1 (92-04), KB220 2.2 LE P/up, KB230 2.3 P/up 4ZD1, KB260 2.6 D/cab, LE, LX, KB320 3.2 V6 Frontier LX - 4X4 (89-04), KB250D 2.5 Fleetside, LE, D/Cab P/up 4JA1, KB280DT 2.8 D/cab LE, LX, Frontier P/up Turbo 4JB1 - 4X2, 4X4 (89-04), Relay 2.0 P/van, Bus 4ZC1 (89-95), WFR 1.8 11FVX/ 12FVX Bus, P/van 4ZB1 (83-89),</p>
<p><b>62032RS... Continued</b></p>	<p>Alternator / Generator Bearing</p>	<p>Mazda 323 FWD 1.3 S, H/back, Sedan E3, 1.5 GLC, SL, SLX, Sport H/back, Sedan E5 (81-88), 1.3 L, H/back, Sedan E/B3, 1.5, L H/back, Sedan E5, 1.6 EG i Hatch, L, Sedan, SL Hatch, SL Sedan, Sport Hatch B6i/F6 (84-91), 2.0 EG i Hatch, SLE Hatch, SLi Sedan, 200e Hatch, Sedan, 200i Hatch 8/16V FE-2000 (89-95), 130 Hatch, Midge, Sedan, Sting B3, 160, i, S Hatch, Midge, Sedan, Sting F6 (90-95), 130 Hatch, Midge, Sedan, Sting B3, 160, i, S Hatch, Midge, Sedan, Sting F6, 200i, e Hatch 8/16V FE 2000 (95-05), 626 1.6 S Sedan, Hatch F6, 1.8 L Sedan, Hatch F8, 2.0 SL, SLE, SLX, 2.0i EG i, SLi FE (Rear Drum brakes) (83-93), 2.0i 16V SLi FE (Rear Disc brakes) (89-93), B-Series B2000 2.0 SWB P/up MA Pet., B2200 2.2 SWB/LWB P/up S2 Dies. (82-86), B3000 3.0 V6 LWB D/cab, Magnum, Drifter, Magnum Drifter P/up Essex Pet. - 4X4 (86-97), Rustler 1.3 SWB P/up Kent 2V Pet., 1.4 SWB P/up CVH/FUA Pet., 1.6 SWB, LX P/up CVH/ LUC Pet. (86-94), 130 SWB Drifter, Explorer P/up B3 Pet., 160, i SWB Explorer, Drifter P/up F6/B6i Pet. (94-02), Mitsubishi Canter 2.5 SWB/LWB D/side, Chassis cab 4G55 Dies., 2.6 4G54 Pet., 3.3 4D30A Dies., 3.8 ADE236 Dies. (80-97), L300 1.6 Mini Bus, Van 4G32 Pet., 1.8 4G62 Pet., 2.0 P/up 4G63 Pet., Starwagon 2.0 S, SL, SLE, P/up, P/van 4G63 Pet. (82-01), Nissan 720 D20 1.8 L18S Kingcab, Sport, 2.2D SD/Z22 Tracker, 2.3 SD23 - 4X2, 1.8 L18S, 2.0 NA20, 2.2 Z22 - 4X4 (80-88), B140 1.4 A14SP/van, S/W, Deluxe, Std. Sport, CHAMP P/up (80-08), E20 1.8 L18 Bus, P/van Coach, Coach GL, GLE, Econolux, Ekonovan, Ekonowagon, 2.0 Bus, Van H20 (80-96), Langley 1.3 GL E13, 1.5 GL, L, SSS, Trebon, Exa Turbo E15 (83-88), Laurel C31 2.0 CA/L20, 2.8 SGL 5L28 (80-87), Pulsar 1.3 S E13, 1.4 DL, GX A14, 1.5 GL, Panache, SX E15 (80-87), Sentra 140, i, GX, GXi, Si GA14DNE / DS, 160 GSi, GX, GXi, SE, Si GA16DE/DNE/ DS (92-02), Skyline R30 1.8 L18, 2.0 GL L20 (82-87), R30 2.8 GLX, GTX L28/2 (83-86), Opel Ascona 1.3 L 13NV/SC, 1.6 GL 16SH, 1.8 GLS 18L (82-87), Astra F 140i, iS 14NV, 160i, iE, iS, Estate 16NZ, 180i, iE 18SE/ XE, XL, 200i, e, ts 20SE/ XE (93-99), Corsa B 130, i, Lite, iE, iS, Chill Hatch / Sedan 13NE, 140i, Classic, Active, Lite, Lite+, Comfort, Chill, Sport, S 14NE, Hatch/ Sedan, 160, i, iE, Classic, GSi, i Sport, S Hatch/ Sedan, 16SE, 1.8i GSi Hatch (96-03), Corsa C 140i Classic, Comfort, Chill, Classic Essential, Hatch Club, Sport, Lite Sport, S14NE, 160i Classic, Classic Elegance, Classic CD, CDE, Sport, 16SE, 1.7TDi Sport, Classic, CDTi Enjoy, Hatch CDTi Elegance, Classic DTi Elegance X17D, 1.8i GSi Hatch, Classic (03-08), Corsa LDV 130i Utility P/up 13NE, 1.4i Utility, S P/up 14NE, 1.6i Utility Sport P/up 16NZ, 1.7D Utility P/up X17D (97-04), Corsa LDV II 1.4i Utility, Club Sport, S P/up 14XE, 1.7DTi Utility Club, Sport P/up, 1.8i Utility Club, Sport P/up (03-10)</p>



# BUYERS GUIDE - LOOSE BEARINGS

<p><b>62032RS... Continued</b></p>	<p>Alternator / Generator Bearing</p>	<p>Corsa P/van 1.3i Pronto 13NE (99-00), 1.4i Combo P/van (2006-), Kadett D, E 1.2 L 12NS, 1.3 Cub, GL, GLS, LS, Rebel 13NV, 140 CL, Cub 14NE/ NV, 1.6 GL, GLS, GSE, L, Rebel, Cub 16SH/ SE, 160i, GSi Aspen 16SE (80-93), 1.8 GTE 18E, L 18LV, GSi Hatch 18L, GLX 18SV, GSi 18E/ SE (84-89), Kadett E 2.0 GSi 20XE, SGi 20SEH, 200, iS 20SE, Boss 20SEH, CD 20SHE, GSi, Super Boss 20SEH (87-93), Kadett F 140, S 14NE, 180i, iE, GSi 18SE, 200is 20XE (93-99), Monza 1.8 CLX, GLE, GLX, Convertible, GLi 18SE/ SV, 2.0 CD, CLi 2.0XE, CLE, GLE 20SE/ V (86-89), Rekord 2.0 Berlina, GL, GLS, L, S/W CIH, 2.0i CLE, CLS, GL, GLE, Irmscher, 2.2E CIH, 380i, V6 CD, GSi 38GE (82-95), Renault R5 1.3, GTL, LS, LSS, TS 810-25, 1.4 TS 847-C2J, 1.3 Panel Van 810-25 (75-85), R9 1.4 GTL, TL, TSE C1/2/3J, 1.7 TXE F2/3N, R11 1.4 TS, TX, TXE C1/2/3J, 1.7 TX, TXE F2/3N (83-86), Toyota Corolla RWD TE31 1.6 Sprinter, SR4/5, Black Hawk, Silver Wolf 2T, AE/TE71 1.6 GL, S/W, GLS Sprinter, SE 2T, TB TE72, 1.8 GLS, SE 3T (80-88), Corolla TE71 1.6 P/van 2T (83-89), KE70 1.3 P/van 4K (84-88), Cressida TX30 1.8 DX 3T, TX62 1.8 L, LS 3T, YX70 1.8 LS, Exec. (80-89), RX60 2.0 GL, GLE, GLX, S/W 21R, RX70, YX72 2.0 GL, GL, GLE, GLX (81-92), GX60 2.0 GLi6 1G-E, GX7 2.0 GLi6 1G-E, 1G-FE (83-92), MX63 2.8i 5M-E, MX73 2.8i RSi, RSi Exec. 5M-GE (84-89), MX75 3.0i ECT, GLS 7MG-E (86-92), Hiace YH50/60 1.8 SWB / LWB P/van, LS Wagon 2Y Pet. (83-91), YH51/61 2.0 SWB/LWB 16 Seater Commuter, Super 10 Seater Custom Wagon, P/van 3Y Pet. (83-86), YH53/63 2.2 SWB/LWB P/van, Van, LS, GLX, Exec. Wagon 4Y Pet. (All Imp. Models) (86-88),</p>
<p><b>62032RS... Continued</b></p>	<p>Alternator / Generator Bearing</p>	<p>Hilux LN30/40/50/51/55 2.2 SWB/LWB P/up L Dies., 2.4 SWB/LWB D/cab, Raider P/up 2L Dies., YN58 2.2 LWB D/cab, Raider, SRX P/up 4Y Pet. (79-98), YN51/56 1.8 SWB/LWB D/cab, S, SR, Raider P/up 2Y Pet., YN140 1.8 SWB/LWB D/cab, Raider, S, SRX P/up 2Y Pet. (86-05), RN58 2.4 22R Pet., LN140/145 2.4i DLX, P/up 2L Dies., RZN194 2.7i LWB D/cab, Raider, SRX, Legend35 Raider, 3RZFE Pet. (94-05), RZN147 2.0 SWB/LWB D/cab, DLX, Raider, S, SR, SRX P/up 1RZ Pet., LN192R 3.0D LWB Raider D-E, Raider DLX D/cab D-E, Legend35 Raider, P/up 5L Dies., 3.0iD LWB Raider, Raider D/cab, P/up KZ-TE Dies. (98-05), RZN169 2.7i LWB D/cab, DLX S/cab, Raider S/D/cab, SRX D/cab, Legend 35 LWB P/up 3RZFE Pet., LN167 3.0D D/cab D-E, DLX, S/D/cab DE, Raider DE, Legend35 LWB P/up 5L Dies., 3.0iD LWB Raider S/cab &amp; KZ-TE D/cab P/up, Legend35 - 4X4 (98-05), Land Cruiser FJ80 4.0 DLX, GX, VX P/up 3F/F-E Pet. - 4X4 (90-92), FZJ80 4.5 Std., GX, VX, Turbo S/W, P/up 1FZ-FE Dies., Turbo Dies. - 4X4 (92-95), FZJ80 4.5 Std., GX, VX, Turbo S/W, P/up 1FZ-FE Dies., Turbo Dies. - 4X4 (95-06), HDJ/HZJ80 4.2 GX, Turbo S/W, P/up 1HD-FT, 1HZ Dies., T. Dies. - 4X4 (90-95), HDJ/HZJ80 4.2 Std., GX, VX, Turbo S/W, P/up 1HD-FT, 1HZ Dies., Turbo Dies. - 4X4 (95-01), PHJ75 3.9 DLX, GX, GX Turbo P/up Perkins236 2H Dies., FJ75 4.0 DLX, GX, VX 3F/F-E Pet., HJ75 (85-92), Stout RK110 2.0 SWB P/up 5R Pet. (79-89), Tuv KF20 1.3 Chassis Cab, P/up, P/van, Bus 4K Pet., 1.5 P/up 5K Pet. (82-87), VW Citi Golf 1.3 L ET/GY, 1.6 Blues, Chico, Chico Lux, Deco, Designa, L, Ritz, Shuttle, Sonic, Sport HM, HV, FR, 1.6iL, Life, VeloCiti, TenaCiti, CitiStorm, - Sport, - Rox, Rhythm, MKI AFX, 1.8 CTi, Designa, L Sport BZF (83-09), Fox 1.3 L, L Trippa GY, 1.6 L HM, 1.8 L Sport HV (87-96), Golf I 1.1 GL, L, LS ET/EG, 1.3 GL, L, LS GF, 1.5 GL Diesel, GLS, LS CK/ EM/ JB, 1.6 GL Diesel, GT, GTS, GTX JK/ CR FR, 1.8 GTi EV (78-84), Golf II 1.3 CL GY, 1.6 CSL HM, 1.8 8/16V CSX, GTS, GTi KR, EV, 2.0 8/16V GTi AAL (84-92), Golf III 1.6 GS ACG, 2.0 GTi, Exec. 2E, 2.8 VR6, Exec. AAA (92-99), Jetta I 1.3 GL, GX ET/ GF, 1.5 GLS/ GLX JB, 1.6 GLS EM, 1.8 GLi DX (80-85), Jetta II 1.6 CSL HM, 1.8 8/16V CLi, CLi Exec., CLX, CSi, CSX EV/KR, 2.0 8/16V CLi, Exec. AAL (85-92), Jetta III 1.6 CSL ACG, 1.8 CLX/ CSX ACH, 2.0 CLi, Exec. 2E, 2.8 VR6 Exec. AAA (92-99), Passat I &amp; II 1.3 L, LS H/back, Sedan, Variant ZF, 1.5 GL, LS Fastback, S/W CK, 1.6 GL, GLS, LS, LX Fastback, S/W, Sedan, Coupe, Variant, YN/YP/WN, 1.8 CL Sedan, S/W JV/KR (74-87), 1.9 GLS H/back, GLX Sedan, S/W WN, 2.2 CLi, CLX SG/MX (81-87), Polo 6N 1.4 Classic, Playa Lux AEX, 1.6 Classic, Playa, Lux AEE (96-03)</p>
<p><b>6203C3</b></p>	<p>Rear Wheel Bearing Outer</p>	<p>Daihatsu Cuore 847 (97-99), Charade 1.0 (2003-)</p>
<p><b>6203ZZ</b></p>	<p>Alternator / Generator Bearing</p>	<p>Ford Laser 2.0, i RS FE (86-02), Meteor 2.0 8/16V GLE, GLi FE (86-95), Sapphire 2.0, i GL, GLE, GLEA, GLi, GLi Exec. Koln (89-93), Sierra 2.0 GL, GL S/W Koln (83-93), Opel Kadett E 2.0 GSi 20XE, SGi 20SEH, 200, iS 20SE, Boss 20SEH, CD 20SHE, GSi, Super Boss 20SEH (87-93), Monza 2.0 CD, CLi 2.0XE, CLE, GLE 20SE/ V (86-93), VW Citi Golf 1.3 L Shuttle, Chico, Chico Lux ET/ GY/ AJD (87-03), 1.4, iL, Chico, Rhythm, Citi com, VeloCiti, TenaCiti, CitiStorm, - Sport, Rox, Rhythm, Wolf, - XCite, Billabong AGY/ BSV (99-09), Golf III 1.8 GSX, GTS ACH (92-99), Kombi T3 1.8 P/van, GUS, Volksiebus AAX Pet. (89-99), Polo 6N 1.8 Classic, Playa, Lux ADZ (96-03)</p>
<p><b>62042RS</b></p>	<p>Alternator / Generator Bearing</p>	<p>Various Makes &amp; Models</p>

## BUYERS GUIDE - LOOSE BEARINGS

<b>6204ZZ</b>	Alternator / Generator Bearing	Various Makes & Models
<b>62052RS</b>	Rear Wheel Bearing Inner	Daihatsu Charade 0.8 CX, CXL G11 CB22, Turbo G21 CB60 (83-85)
<b>6205ZNR</b>	Alternator/Generator Bearing, Spigot shaft brg.	Various Makes & Models
<b>6205ZZ</b>	Alternator / Generator Bearing	Various Makes & Models
<b>62062RS</b>	Front / Rear Wheel Bearing Inner / Outer	BMW 7 Series E23 728, i M30, 730 M30, 733i M30, 735i M90, 745i M88 (78-89), Nissan Skyline R30 2.8 GLX, GTX L28/2 (83-86), R31 2.0 SGi, SGLi RB20E, 3.0 SGLi RB30E With I.R.S. (87-92), Renault R5 1.3, GTL, LS, LSS, TS 810-25, 1.4 TS 847-C2J, 1.3 Panel Van 810-25 (75-85)
<b>62062RSC3</b>	Prop shaft support brg.	Toyota Dyna 2.0, 2.2, 2.4, 3.0, 3.7, 3.8, 4.0 (85-02), Isuzu Gearbox Bearing
<b>6206ZNR</b>	Alternator/Generator Bearing, Spigot shaft brg.	Various Makes & Models
<b>6206ZZ</b>	Alternator / Generator Bearing	Various Makes & Models
<b>62072RS</b>	Propshaft Support Bearing	Mitsubishi ASX 2.0 4B11 (2011-)
<b>6207C3</b>	Rear Wheel Bearing Inner	VW Kombi T2 2.0, L Exec., Microbus, Kamper, P/up, P/van CU, CJ Pet., T3 1.9 Microbus, P/van DG Pet. (75-89), T3 1.8 P/van, GUS, Volksiebus AAX Pet. (89-99), T3 2.1 Fi Caravelle, Microbus DJ Pet., 2.3i Microbus, Volksiebus AFU Pet., 2.5i Microbus, Caravelle AAY Pet., 2.6i Microbus, Caravelle, Exclusive, ADV Pet. - 4X2 (85-04), T3 2.1 Fi Syncro Caravelle DJ Pet. (89-93)
<b>6207RSC3</b>	Rear Wheel Bearing Inner	Chana Star 1.0 (06-12)
<b>6207ZNR</b>	Gearbox Bearing	Various Makes & Models
<b>6207ZZ</b>	Rear Wheel Bearing, Prop Shaft	Honda Ballade 130, 150 (82-96)
<b>6208+361612</b>	Rear Wheel Bearing Inner	Mercedes-Benz 200, 230, 240D, 250SE, 280S, SE (65-73)
<b>62082RS</b>	Rear Wheel Bearing Outer	BMW 7 Series E23 728, i M30, 730 M30, 733i M30, 735i M90, 745i M88 (78-89)
<b>6208ZNR</b>	Gearbox Bearing	Various Makes & Models
<b>6208ZZ</b>	Alternator / Generator Bearing	Various Makes & Models
<b>6209C3</b>	Diff. Pinion Bearing Front	Nissan Langley 1.3, 1.5 (83-88), Pulsar 1.3, 1.4, 1.5 (80-87)
<b>6262RS</b>	Sliding Door Bearing	Various Makes & Models
<b>626ZZ</b>	Sliding Door Bearing	Various Makes & Models
<b>6272RS</b>	Sliding Door Bearing	Various Makes & Models
<b>627ZZ</b>	Sliding Door Bearing	Various Makes & Models
<b>628ZZ</b>	Sliding Door Bearing	Various Makes & Models
<b>6292RS</b>	Sliding Door Bearing	Various Makes & Models
<b>629ZZ</b>	Sliding Door Bearing	Various Makes & Models
<b>630022RS</b>	Alternator/Generator Bearing	Toyota Dyna 3.0 (86-94)
<b>63012RS</b>	Alternator / Generator Bearing	Various Makes & Models
<b>6301ZZ</b>	Alternator / Generator Bearing	Fiat 128 1.1, 1.3 (71-84), 131 1.6, 2.0 (77-80)
<b>63022RS</b>	Alternator / Generator Bearing	Ford Courier 1.6 P/up F6, 1.8 Chassis cab, Explorer, Std., XLT P/up F8., 2.0 XLT FE., 2.2 D/cab, Explorer, Leisure, Std., XLT P, 3.0 V6 D/cab, Explorer, L, Leisure, Std., P/up Essex (86-00), Laser 1.3 L, GL, 13, Dash E3 / B3 (86-90), 1.5 GL, GLS, Sport E5/B5 (86-92), Meteor 1.3 GL, L, 13 E3/B3, 1.5 GL, GLS E5 (86-95), Ranger 1.8 XL, P/up, 2.2 XL, P/up (00-05), 1.8 XL, P/up, 2.2 XL, P/up (04-10), Sapphire 3.0 Ghia, GLX Essex (89-93), Sierra 2.0 LX Koln (83-93), Isuzu KB20 1.6 P/up G161Z Pet., KB21 1.6 P/up G161Z Pet., KB22 1.8 P/up G180Z Pet. (84-89), KBD20 2.0 P/up C190 KBD21 2.0 P/up C190, KBD22 2.2 LE, P/up C223 (78-89), KB23 2.0 P/up G200Z, KB24 2.3 LE 4ZD1, KB25 1.6 P/up G161Z, KB26 1.6 P/up G161Z, 1.8 P/up G180Z (84-89), KBD25 2.0 P/up C190 (79-89), KBD26 2.0 P/up C190, KBD27 2.2 C223, KBD28 2.5 4JA1 (81-89), KB27 1.8 P/up G180Z, KB28 2.0 P/up G200Z, KB29 2.3 P/up 4ZD1 (83-89), KBD40 KBD41 2.0 P/up C190, KBD42 2.2 P/up C223 - 4X4 (79-89), KB160 1.6 Fleetside P/up, KB200 2.0 LE, Fleetside, D/cab P/up, KB220 2.2 LE, P/up, KB230 2.3 D/cab P/up (89-04)

## BUYERS GUIDE - LOOSE BEARINGS

<p><b>63022RS... Continued</b></p>	<p>Alternator / Generator Bearing</p>	<p>KB220 2.2 LE P/up, KB230 2.3 P/up 4ZD1 KB260 2.6 D/cab, LE, LX, KB320 3.2 V6 Frontier LX - 4X4 (89-04), WFR 1.8 11FVX/ 12FVX Bus, P/van 4ZB1 (83-89), Mazda 626 2.0 SL, SLE, SLX, 2.0i EG, SLi FE (Rear Drum brakes) (83-93), B-Series B2600 2.6 LWB D/cab, Magnum, Drifter P/up 4G54 Pet., B2600i 2.6i LWB D/cab Drifter, SLX P/up 4G54 Pet. - 4X2 (86-01), B2600 2.6 V6 LWB D/cab, Magnum, Drifter P/up 4G54 Pet. - 4X4 (86-95), B3000 3.0 V6 LWB D/cab, Magnum Drifter P/up Essex Pet. - 4X2 (86-97), B2000 2.0 LWB Drifter, Magnum P/up FE Pet., B2200 2.2 LWB D/cab, Drifter, Magnum P/up R2 Dies., 2.2 LWB D/cab, Drifter, Magnum P/up F2 Pet. (86-00), B2600i 2.6i V6 LWB Drifter, D/cab Drifter SLX P/up 4G54 Pet. - 4X4 (00-09), Drifter 1.8 SWB/LWB XL P/up Pet., 2.2 SWB/LWB XL P/up Pet., 2.6i LWB Hi Ride, SL Hi Ride S/cab, SLE, SLX D/cab SLX Hi Ride D/cab, SLX Hi Trail D/cab P/up Pet. - 4X2 (00-09), 2.6i V6 LWB SL S/cab, SLE, SLX D/cab P/up 4G54 Pet. - 4X4 (02-09), Mitsubishi Colt LDV 1.6 SWB/LWB Lo-Line P/up 4G32 Pet., 2.0 4G63 Pet., 2.5D 4D56 Dies., 2.6 WB Hi-Line P/up 4G54 Pet., 2.8D LWB Std., Hi line P/up Dies., 2.8TDi LWB Club CabS cab,Turbo, 3.0i V6 LWB Club S/cab P/up Pet. (94-98), 2.5D LWB Hi-Line P/up 4D56 Dies., 2.6 LWB Lo-/Hi-Line, P/up 4G54 Pet., 3.0 V6 LWB Lo-/Hi- Line D/cab, Rodeo 6G72 Pet. - 4X4 (95-98), 2.0 LWB Std. P/up, 2.0i LWB Hi-Line, 2.4i LWB Hi-Line Rodeo S-/D/cab, Hi-Line/Rider P/up Pet., 2.5D 4D56 Dies. (98-09), 2.4i LWB Hi-Line D/cab, Trailbuster S/cab, P/up Pet. - 4X4 (98-06), 2.8TDi LWB Pioneer, Rodeo D/cab P/up Turbo Dies. 3.0i V6 LWB Rodeo D/cab P/up Pet. (99-09), 2.8D, TDi LWB Club cab,Trailbuster S/cab, Rodeo /cab P/up Dies./ Turbo Dies., 3.0i V6 LWB Rodeo D/cab P/up Pet. - 4X4 (99-09), Pajero 2.8 Tdi, 3.0 V6 SWB GLS Wagon 6G72 Pet., 3.5 V6 SWB GLS Wagon 6G74 Pet. - 4X4 (90-01), Nissan Maxima GV Series 300SE VG30E (91-97), Opel Kadett D, E 1.8 GTE 18E, L 18LV, GSi Hatch 18L, GLX 18SV, GSi 18E/ SE (84-93), Kadett F 160i, iS, GSi, Aspen 16SV/ NZ (93-99), Monza 160 GSi, i Aspen 16SE/ NZ, CLS 16SV (86-93), 1.8 CLX, GLE, GLX, Convertible, GLI 18SE/ SV, 2.0 CD, CLi 2.0XE, CLE, GLE 20SE/ V (89-93), Toyota Hilux YN51/56 1.8 SWB/LWB D/cab, S, SR, Raider P/up 2Y Pet., YN140 1.8 SWB/LWB D/cab, Raider, S, SRX P/up 2Y Pet. (86-05), Stallion YF50 1.8 SR5, P/up, P/van, Van 2Y Pet., LF50 2.4D P/up 2L5F Dies. (87-04), Venture YF50 1.8 8/10 Seater P/van 2Y Pet., 2.2 10 Seater, GLE, Getaway 9 Seater S/W 4Y Pet., LF50 2.4D 10 Seater S/W 2L5F Dies. (91-04)</p>
<p><b>6302RMX</b></p>	<p>Bearing For Vbt011</p>	<p>Toyota Quantum 2.5 D-4D, "Family", S-long MPV, Van 2KD-FTV Dies., 2.7 "Family", S-long "Ses'fikile" MPV, Van 2TR-FE Pet. (Bearing For VBT011) (2005-)</p>
<p><b>6302ZZ</b></p>	<p>Alternator / Generator Bearing</p>	<p>Fiat Uno 1.4 Turbo 146A (90-98), 1.0 Cento 156A2, 1.1 Espresso P/van 160A3, 1.1 Fire, Rio, Mia, Tempo 160A3, 1.4 Pacer, Beat,Mia, Tempo, SX 146C1 (90-05)</p>
<p><b>63032RS</b></p>	<p>Alternator, Generator Bearing</p>	<p>C.A.M. Inyathi Jinbei Haise Minibus 2.2i Std (2007-), Daihatsu Charade 0.8 CX, CXL G11 CB22, Turbo G21 CB60 (83-85), Ford Courier 1.6 P/up F6, 1.8 Chassis cab, Explorer, Std., XLT P/up F8., 2.0 XLT FE., 2.2 D/cab, Explorer, Leisure, Std., XLT P (86-00), 2.5 Turbo Diesel D/cab, Leisure P/up WL4 - 4X2, 2.5TD D/cab, Leisure P/up WL4, 3.0 V6 Std., XLT, D/cab, Leisure, Explorer, Exec. P/up Essex - 4X4 (96-00), Falcon 4.0 GLi, Fairmont, Fairmont, Futura XR6 Mpi (96-03), Laser 1.3 L, GL, 13, Dash E3 / B3, Tracer 1.3 Sedan, H/back -Tonic, Plus B3 (91-02), Laser 1.6, i GL, 16, Sport, TX3 B6/ F6, 2.0, i RS FE, Tracer 1.6 Sedan, H/back - Plus, Sport, Tonic B6/ F6 (86-02), Meteor 1.3 GL, L, 13 E3/B3, 1.4 LX CVH, 1.5 GL, GLS E5 (91-95), 1.6, i GL, GLE, GLi,16, Sport B6/CVH/F6, 2.0 8/16V GLE, GLi FE (86-95), Ranchero 4.0 GLi, Outback, XR6 P/up 250 (97-99), Ranger 2.5 Diesel, Turbo Diesel D/Cab, High Trail, XL, DT XLT High Trail D/Cab, Super Cab - 4X2 (00-09), 2.5 D/Cab,High Trail, XL, DT XLT High Super Cab, 2.5TD Montana D/Cab WL4, 3.0TDCi, 4.0 Super Cab XLT - 4X4 (00-12), Spectron 2.2 Bus, P/van F2 (91-04), Honda Ballade SC9 "Flip up Lights" 130 EV2, 150, i EW, 160i DOHC ZC1 (84-89), SH4 150 16V SOHC D15B3 (89-92), KB320 3.2 LE, D/cab, LX, Frontier, Reef, Blazer P/up 6VD1 (92-04), KB250D 2.5 Fleetside, LE, D/Cab P/up 4JA1, KB280DT 2.8 D/cab LE, LX, Frontier P/up Turbo 4JB1 - 4X2, 4X4 (89-04), Mazda B-Series B1600 1.6 SWB Magnum P/up F6 Pet., B1800 1.8 SWB/LWB Magnum, Drifter P/up F8 Pet., B2000 2.0 LWB Drifter, Magnum P/up FE Pet., B2200 2.2 LWB D/cab, Drifter, Magnum P/up R2 Dies., 2.2 LWB D/cab, Drifter, Magnum P/up F2 Pet. (86-00), B2500 2.5, Td LWB D/Cab, Drifter, SLX P/up WL4 Dies./Turbo Dies - 4X4 (96-99), B2500 2.5 LWB Diesel, Turbo Diesel D/cab, Drifter, SLX P/up WL4 Dies., Turbo - 4X2 (97-00), Drifter 2.5Td LWB Hi Ride, SL SLE,SLX D/cab, Hi Ride, Hi Trail D/cab P/up WL4 Dies./Turbo Dies. - 4X2 (00-09), 2.5Td LWB D/cab, DL, SL, SLE, SLX S/cab, D/cab P/up WL4 Dies./Turbo Dies. - 4X4 (02-09), Marathon 2.2 LWB Bus, P/van F2 Pet. (91-04), Mercedes-Benz W123 200 M115.938/9, 230, E M115.954, 240D M616.912, 250 M123.920/1, 280E M110.983, 300D M617.912 (77-86), W124 200E M102.922, 220E M111.960, 230E M102.982, 260E M103.940, 280E M104.942, 300D M103.985, M606.910, 320 Sportline M104.922 (86-96), W124 E Class E200 M102.922, E220 M111.960, E320 Sportline, M104.992 (93-96), W126 280SE M110 987/9, 300SE M103.981, 380SE M116.963, 420SE M116.965, 500SE M117.965 (86-93)</p>



## BUYERS GUIDE - LOOSE BEARINGS

<p><b>63032RS... Continued</b></p>	<p>Alternator, Generator Bearing</p>	<p>W140 S-Class S320 M104.990, S420 M119.971, S500 M119.980 (93-99), W201 190E 1.8 M102.920, 2.0 M102.922, 2.3 Sportline M102.983 (93-94), W202/3 C-Class C180 Classic M111.920, C200 M111.941, C220 M111.961, C230 M111.974, C240 M111.944, C250 M605.910, C270CDi M612.962, C280 M104.941 (94-08), Mitsubishi Colt LDV 2.8D LWB Std., Hi line P/up Dies., 2.8TDi LWB Club CabS cab,Turbo, 3.0i V6 LWB Club S/cab P/up Pet. (94-98), 2.0 LWB Std. P/up, 2.0i LWB Hi-Line, 2.4i LWB Hi-Line Rodeo S-/D/cab, Hi-Line/Rider P/up Pet., 2.5D 4D56 Dies. (98-09), 2.4i LWB Hi-Line D/cab, Trailbuster S/cab, P/up Pet. - 4X4 (98-09), 2.8TDi LWB Pioneer, Rodeo D/cab P/up Turbo Dies., 3.0i V6 LWB Rodeo D/cab P/up Pet. (99-09), 2.8D, TDi LWB Club cab,Trailbuster S/cab, Rodeo /cab P/up Dies./ Turbo Dies., 3.0i V6 LWB Rodeo D/cab P/up Pet. - 4X4 (99-09), Nissan 1-Tonner/Hardbody AW/D21 1.6 L16S-J, 1.8 L18S-R, 2.0 NA20, 2.4 Z24/S, 2.5D TD25i, 2.7D TD27, 3.0 VG30E - 4X2, 2.4 Z24S, 2.7 TD27, 3.0 VG30E - 4X4 (88-98), Hardbody QW/D22 2.0 NA20S, 2.0i KA20, 2.4i Z24, KA24E/DE, 2.7D TD27i, 3.0 i VG30E, 3.0TD ZD30, 3.2 QD32, 3.3i VG33E - 4X2, 2.4i KA24E, 2.7 TD27, 3.0 VG30E, 3.0TD ZD30, 3.2, 3.2D QD32, 3.3i VG33 - 4X4 (98-11), NP300 D22 2.0i, S, SE KA20, 2.4i, S/C, D/C Highrider KA24 DE, 2.5TDi, S, SE YD25, 2.5TDi, S, SE Highrider YD25 - 4X2, 2.4i, S/C, D/C, Highrider KA24 DE, 2.5TDi, S, SE, Highrider YD25 - 4X4 (2008-), Patrol Y60 3.0 VG30E, Y61 3.0Di, 4.2 TD42 - 4X4 (99-04), Sabre 160 GX, GXi GA16DS, 200 GXi SR20DE (94-02), Sani AW/D21 2.4, i Z24, 2.5 TD25, 2.7D, TD TD27, 3.0 VG30E - 4X2 (89-99), 2.2 Z22, 2.4 Z24, 2.7 TD27, 3.0 VG30E - 4X4 (86-98), Sentra 1.3 GL, SX E13S, 1.6 GL, GX, GXE GXEi Coupe, SGLi E16E/S, 1.8i Coupe, Sedan Exec. CA18DE (89-92), 200 GSi, STi SR20DE (92-02), Skyline R31 2.0 GL, GLE CA20, 2.0 SGi, SGLi RB20E, 3.0 SGLi RB30E With I.R.S. (87-92), Terrano II 2.7 TD27 - 4X4 (00-02), Opel Astra F 140i, iS 14NV, 160i, iE, iS, Estate 16NZ, 180i, iE 18SE/ XE, XL, 200i, e, ts 20SE/ XE (93-99), Astra G 1.6 CS, Classic CD, CDE, Comfort C16SEL, 1.8 Classic CDE, Caravan CD S/W, Elegance, Irmscher X18XE1, 2.0 Coupe', CSX X20XE, 2.2i Classic Exec. (99-06), Corsa B 130, i, Lite, iE, iS, Chill Hatch / Sedan 13NE, 140i, Classic, Active, Lite, Lite+, Comfort, Chill, Sport, S 14NE, Hatch/ Sedan, 160, i, iE, Classic, GSi, i Sport, S Hatch/ Sedan, 16SE, 1.8i GSi Hatch (96-03), Corsa C 140i Classic, Comfort, Chill, Classic Essentia, Hatch Club, Sport, Lite Sport, S14NE, 160i Classic, Classic Elegance, Classic CD, CDE, Sport, 16SE, 1.7TDi Sport, Classic, CDTi Enjoy, Hatch CDTi Elegance, Classic DTi Elegance X17D, 1.8i GSi Hatch, Classic (03-08), Corsa LDV 130i Utility P/up 13NE, 1.4i Utility, S P/up 14NE, 1.6i Utility Sport P/up 16NZ, 1.7D Utility P/up X17D (97-04), Corsa LDV II 1.4i Utility, Club Sport, S P/up 14XE, 1.7DTi Utility Club, Sport P/up, 1.8i Utility Club, Sport P/up (03-10), Corsa P/van 1.3i Pronto 13NE, 1.4i Combo P/van (1999-)</p>
<p><b>63032RS... Continued</b></p>	<p>Alternator, Generator Bearing</p>	<p>Opel Kadett F 140, S 14NE, 180i, iE, GSi 18SE, 200is 20XE (93-99), Zafira I 1.8i CD, Enjoy, Elegance MPV Z18XE/-1 (01-05), Toyota Conquest/Tazz EE80 1.3 GL, GS, L, S 2EL, EE90R 130 Sport, Tazz, Edition, Zipp, Tropique, Tazz EE90R 130 Edition, Ruby, Tropique, Sport, McTazz, XE 2E (85-06), AE82R 1.6 GL, RS, RSi 4A-L, A-GEL, AE92R 160i LS, RS, RSi, Sport, RSE, Tazz 4A-F, A-FE, A-GE, AE92R 160i Edition, Sport, Tazz, XE 4AFE (85-06), Conquest EE90 130 Carri P/van, 2E (98-06), Corolla FWD AE82R 1.6 GL,GLE, GLi, GLS, GLX, Avante, GLE, GLi, S/W 4A-L, A-GEL (84-88), AE/EE80R 1.3 GL, L, 2A-L, E-L, EE90R 1.3 GL, GLE, L, Sprinter 2E-L, E EE110R 130 GLE, Sprinter 2E (84-02), AE92R 1.6, 160 GL,GLE, GLi, Exec., GLS, Exec., GLX, Sport Sprinter 4A-F, A-FE, A-GE (88-96), Hiace YH53/63 2.2 SWB/LWB P/van, Van, LS, GLX, Exec. Wagon 4Y Pet. (All Imp. Models) (86-88), 2.2 SWB/LWB P/van, Van, LS, Super T/14/16, GLX, Exec. Wagon, Siyaya Bus, P/van 4Y Pet. (All Local Models) (88-09), Hilux LN30/40/50/51/55 2.2 SWB/LWB P/up L Dies., 2.4 SWB/LWB D/cab, Raider P/up 2L Dies., YN58 2.2 LWB D/cab, Raider, SRX P/up 4Y Pet. (79-98), YN67 2.2 LWB D/cab, Raider D/cab P/up 4Y Pet. - 4X4 (86-94), Quantum 2.5 D-4D, "Family", S-long MPV, Van 2KD-FTV Dies., 2.7 "Family", S-long "Ses'fikile" MPV, Van 2TR-FE Pet. (2005-), VW Citi Golf 1.3 L Shuttle, Chico, Chico Lux ET/ GY/ AJD, 1.4, iL, Chico, Rhythm, Citi com, VeloCiti, TenaCiti, CitiStorm, - Sport, Rox, Rhythm, Wolf, - XCite, Billabong AGY/ BSV (87-09)</p>
<p><b>63032RSC3</b></p>	<p>Rear Wheel Bearing Outer</p>	<p>Daihatsu Charade 1.0 (83-85), Ford Courier 1.6, 1.8 (86-00)</p>
<p><b>6303ZZ</b></p>	<p>Alternator, Generator Bearing</p>	<p>Various Makes &amp; Models</p>
<p><b>63042RS</b></p>	<p>Alternator / Generator Bearing</p>	<p>Isuzu KBD23 2.5 LE, P/up 4JA1 (79-89), KBD26 2.0 P/up C190, KBD27 2.2 C223, KBD28 2.5 4JA1 (81-89), KB250D 2.5 Fleetside, LE, D/Cab P/up 4JA1 - 4X2, 4X4 (89-04), Toyota Hilux LN65 2.4 LWB D/cab, Raider D/cab P/up 2L Dies. - 4X4 (89-98), LN67 2.8D LWB, D/cab, Raider D/cab P/up 3L Dies. - 4X4 (95-98), Land Cruiser FZJ/HZJ75 4.2 GX S/W, P/up 1FZF/HZ Dies. - 4X4 (91-97)</p>
<p><b>6304RSC3</b></p>	<p>Rear Wheel Bearing Inner</p>	<p>Daihatsu Cuore 847 (97-99), Charade 1.0 (2003-)</p>
<p><b>6304ZNR</b></p>	<p>Alternator/Generator Bearing</p>	<p>Various Makes &amp; Models</p>

## BUYERS GUIDE - LOOSE BEARINGS

<b>6304ZZ</b>	Alternator / Generator Bearing	Various Makes & Models
<b>63052RS</b>	Alternator / Generator Bearing	Various Makes & Models
<b>6305C3</b>	Front Wheel Bearing Inner	Daihatsu Charade 1.0 (83-85 Cuore 847 (, 97-99)
<b>6305ZNR</b>	Gearbox Bearing	Various Makes & Models
<b>6305ZZ</b>	Alternator / Generator Bearing	Various Makes & Models
<b>63062RS</b>	Rear Wheel Bearing Outer	Nissan Skyline R30 2.8 GLX, GTX L28/2 (83-86), R31 2.0 SGi, SGLi RB20E, 3.0 SGLi RB30E With I.R.S. (87-92)
<b>6306ZNR</b>	Alternator / Generator Bearing	Various Makes & Models
<b>6306ZZ</b>	Alternator / Generator Bearing	Various Makes & Models
<b>63072RS</b>	Alternator / Generator Bearing	Various Makes & Models
<b>6307ZNR</b>	Alternator/Generator Bearing	Various Makes & Models
<b>63082RS</b>	Rear Wheel Bearing Inner	C.A.M. Inyathi Jinbei Haise Minibus 2.2i Std (2007-), Rhino 2.2i, 2.8i (2007-), GWM Double Cab Lux 2.2 TDi, MPI, Standard (2007-), Toyota Hiace YH51/61 2.0 SWB/LWB 16 Seater Commuter, Super 10 Seater Custom Wagon, P/van 3Y Pet. (83-86), YH53/63 2.2 SWB/LWB P/van, Van, LS, GLX, Exec. Wagon 4Y Pet. (All Imp. Models) (86-88), LN30/40/50/51/55 2.2 SWB/LWB P/up L Dies., 2.4 SWB/LWB D/cab, Raider P/up 2L Dies., YN58 2.2 LWB D/cab, Raider, SRX P/up 4Y Pet. (79-98), YN67 2.2 LWB D/cab, Raider D/cab P/up 4Y Pet. - 4X4 (86-94), YN51/56 1.8 SWB/LWB D/cab, S, SR, Raider P/up 2Y Pet. (87-98), YN140 1.8 SWB/LWB D/cab, Raider, S, SRX P/up 2Y Pet. (86-05), LN65 2.4 LWB D/cab, Raider D/cab P/up 2L Dies. - 4X4 (89-98), RN67 2.4 LWB D/cab, Raider D/cab P/up 22R Pet. - 4X4 (94-98)
<b>6308ZNR</b>	Gearbox Bearing	Various Makes & Models
<b>6308ZZ</b>	Alternator / Generator Bearing	Various Makes & Models
<b>63112RS</b>	Alternator/Generator Bearing	Toyota Corolla 1.3, 1.6, 1.8 (96-02),RAV4 2.0 - 4X4 (94-02)
<b>633809P</b>	Rear Wheel Bearing Inner	Volvo C/S70 2.3, 2.4 (97-04), S90 2.9 (97-00), V70 2.3, 2.4, 2.4T, 2.5T (00-04), V90 2.9 (97-00), V70 2.4, XC70 2.5T, XC90 2.9 - 4X4 (00-08)
<b>633966P</b>	Front Wheel Bearing Inner	Volvo S40 1.9, 2.0T (97-04), V40 1.9, 2.0T (97-04)
<b>63982RS</b>	Alternator / Generator Bearing	Honda Ballde SO4 150i Encore, Luxline, Spreeline D15Z4, 160i Luxline, Spreeline, V-Tec D16Y9, D16Z, 180i Luxline B18B4 (96-00), Civic SO3 150i Luxline, Spreeline D15Z4, 160i Luxline, V-Tec D16Z (96-00), Toyota Land Cruiser FZJ105 4.5 V8 VX, Turbo P/up, S/W 2UZ-FE Pet. - 4X4 (98-06)
<b>64032RS</b>	Alternator / Generator Bearing	Various Makes & Models
<b>6403ZZ</b>	Alternator/Generator Bearing	Various Makes & Models
<b>65012RS</b>	Alternator/Generator Bearing	Honda Ballade 1.5, 1.6, 1.8, Civic 1.5, 1.6 (96-00), Toyota Land Cruiser 4.2 - 4X4 (90-98)
<b>67010+48</b>	Front, Rear Wheel Bearing / Diff, Pinion Bearing	Ford Bantam 1300 P/up Kent 2V, 1400 Leisure, Nite P/up CVH/FUA (83-94), 130 Explorer P/up B3, 160, i Explorer, Leisure, Sport, P/up B6/ F6 (94-03), Mazda Rustler 1.3 SWB P/up Kent 2V Pet., 1.4 SWB P/up CVH/FUA Pet. (86-94), 130 SWB Drifter, Explorer P/up B3 Pet., 160, i SWB Explorer, Drifter P/up F6/B6i Pet. (94-02), Mercedes-Benz W124 200E M102.922, 220E M111.960, 230E M102.982, 260E M103.940, 280E M104.942, 300D M103.985, M606.910, 320 Sportline M104.922 (86-96), W201 190E 1.8 M102.920, 2.0 M102.922, 2.3 Sportline M102.983 (93-94), Nissan Laurel C31 2.0 CA/L20, 2.8 SGL 5L28 (80-87), Stanza 1.6 DL, Resort, S/W L16, 1.8 GL, Resort, S/W SSS L18 (80-84), Skyline R30 1.8 L18, 2.0 GL L20, R31 2.0 GL, GLE CA20 (82-92), R30 2.8 GLX, GTX L28/2 (83-86), R31 2.0 SGi, SGLi RB20E, 3.0 SGLi RB30E With I.R.S (87-92), Opel Rekord 2.0 Berlina, GL, GLS, L, S/W CIH, 2.0i CLE, CLS, GL, GLE, Irmischer, 2.2E CIH, 380i, V6 CD, GSi 38GE (82-95),

## BUYERS GUIDE - LOOSE BEARINGS

<p><b>67010+48... Continued</b></p>	<p>Front, Rear Wheel Bearing / Diff, Pinion Bearing</p>	<p>Toyota Condor 1.6 Estate, TE, 5L, 1.8 2Y, 2.0i Estate, TE, 1RZ Pet., 2.4i Estate, TE, TX 2RZ-E, 3.0D Estate, TE, 5L Dies. - 4X2 (00-05), Cressida TX30 1.8 DX 3T, TX62 1.8 L, LS 3T, YX70 1.8 LS, Exec. (80-89), RX60 2.0 GL, GLE, GLX, S/W 21R, RX70, YX72 2.0 GL, GL, GLE, GLX (81-92), GX60 2.0 GLi6 1G-E, GX7 2.0 GLi6 1G-E, 1G-FE (83-92), MX63 2.8i 5M-E, MX73 2.8i RSi, RSi Exec. 5M-GE (84-89), MX75 3.0i ECT, GLS 7MG-E (86-92), RX72 2.4 GL, GL S/W, GLE, GLE S/W 22R, RX73 2.4 GLE, GLE S/W 22R With I.R.S. (Independent Rear Suspension) (87-92), Stallion KF50 1.5 SR5,Commuter, Bus, P/up, P/van 5K Pet., YF50 1.8 SR5, P/up, P/van, Van 2Y Pet., LF50 2.4D P/up 2L5F Dies. (87-04), Venture YF50 1.8 8/10 Seater P/van 2Y Pet., 2.2 10 Seater, GLE, Getaway 9 Seater S/W 4Y Pet., LF50 2.4D 10 Seater S/W 2L5F Dies. (91-04), VW Fox 1.3 L, L Trippa GY, 1.6 L HM, 1.8 L Sport HV (87-96), Golf I 1.1 GL, L, LS ET/EG, 1.3 GL, L, LS GF, 1.5 GL Diesel, GLS, LS CK/ EM/ JB, 1.6 GL Diesel, GT, GTS, GTX JK/ CR FR, 1.8 GTi EV (78-84), Golf II 1.8 8/16V CSX, GTS, GTi KR, EV, 2.0 8/16V GTi AAL (84-92), Golf III 1.6 GS ACG, 1.8 GSX, GTS ACH (92-99), Jetta I 1.3 GL, GX ET/ GF, 1.5 GLS/ GLX JB, 1.6 GLS EM, 1.8 GLi DX (80-85), Jetta II 1.6 CSL HM, 1.8 8/16V CLi, CLi Exec., CLX, CSi, CSX EV/KR, 2.0 8/16V CLi, Exec. AAL (85-92), Jetta III 1.6 CSL ACG, 1.8 CLX/ CSX ACH (92-99)</p>
<p><b>67010+48L</b></p>	<p>Front, Rear Wheel Bearing / Diff, Pinion Bearing</p>	<p>Ford Bantam 1300 P/up Kent 2V, 1400 Leisure, Nite P/up CVH/FUA (83-94), 130 Explorer P/up B3, 160, i Explorer, Leisure, Sport, P/up B6/ F6 (94-03), Mazda Rustler 1.3 SWB P/up Kent 2V Pet., 1.4 SWB P/up CVH/FUA Pet. (86-94), 130 SWB Drifter, Explorer P/up B3 Pet., 160, i SWB Explorer, Drifter P/up F6/B6i Pet. (94-02), Mercedes-Benz W124 200E M102.922, 220E M111.960, 230E M102.982, 260E M103.940, 280E M104.942, 300D M103.985, M606.910, 320 Sportline M104.922 (86-96), W201 190E 1.8 M102.920, 2.0 M102.922, 2.3 Sportline M102.983 (93-94), Nissan Laurel C31 2.0 CA/L20, 2.8 SGL 5L28 (80-87), Stanza 1.6 DL, Resort, S/W L16, 1.8 GL, Resort, S/W SSS L18 (80-84), Skyline R30 1.8 L18, 2.0 GL L20, R31 2.0 GL, GLE CA20 (82-92), R30 2.8 GLX, GTX L28/2 (83-86), R31 2.0 SGi, SGLi RB20E, 3.0 SGLi RB30E With I.R.S (87-92), Opel Rekord 2.0 Berlina, GL, GLS, L, S/W CIH, 2.0i CLE, CLS, GL, GLE, Irmscher, 2.2E CIH, 380i, V6 CD, GSi 38GE (82-95), Toyota Condor 1.6 Estate, TE, 5L, 1.8 2Y, 2.0i Estate, TE, 1RZ Pet., 2.4i Estate, TE, TX 2RZ-E, 3.0D Estate, TE, 5L Dies. - 4X2 (00-05), Cressida TX30 1.8 DX 3T, TX62 1.8 L, LS 3T, YX70 1.8 LS, Exec. (80-89), RX60 2.0 GL, GLE, GLX, S/W 21R, RX70, YX72 2.0 GL, GL, GLE, GLX (81-92), GX60 2.0 GLi6 1G-E, GX7 2.0 GLi6 1G-E, 1G-FE (83-92), MX63 2.8i 5M-E, MX73 2.8i RSi, RSi Exec. 5M-GE (84-89), MX75 3.0i ECT, GLS 7MG-E (86-92), RX72 2.4 GL, GL S/W, GLE, GLE S/W 22R, RX73 2.4 GLE, GLE S/W 22R With I.R.S. (Independent Rear Suspension) (87-92), Stallion KF50 1.5 SR5,Commuter, Bus, P/up, P/van 5K Pet., YF50 1.8 SR5, P/up, P/van, Van 2Y Pet., LF50 2.4D P/up 2L5F Dies. (87-04), Venture YF50 1.8 8/10 Seater P/van 2Y Pet., 2.2 10 Seater, GLE, Getaway 9 Seater S/W 4Y Pet., LF50 2.4D 10 Seater S/W 2L5F Dies. (91-04), VW Fox 1.3 L, L Trippa GY, 1.6 L HM, 1.8 L Sport HV (87-96), Golf I 1.1 GL, L, LS ET/EG, 1.3 GL, L, LS GF, 1.5 GL Diesel, GLS, LS CK/ EM/ JB, 1.6 GL Diesel, GT, GTS, GTX JK/ CR FR, 1.8 GTi EV (78-84), Golf II 1.8 8/16V CSX, GTS, GTi KR, EV, 2.0 8/16V GTi AAL (84-92), Golf III 1.6 GS ACG, 1.8 GSX, GTS ACH (92-99), Jetta I 1.3 GL, GX ET/ GF, 1.5 GLS/ GLX JB, 1.6 GLS EM, 1.8 GLi DX (80-85), Jetta II 1.6 CSL HM, 1.8 8/16V CLi, CLi Exec., CLX, CSi, CSX EV/KR, 2.0 8/16V CLi, Exec. AAL (85-92), Jetta III 1.6 CSL ACG, 1.8 CLX/ CSX ACH (92-99)</p>
<p><b>68110+49</b></p>	<p>Front Wheel Bearing Inner / Outer</p>	<p>BMW 7 Series E23 728, i M30, 730 M30, 733i M30, 735i M90, 745i M88 (78-85), Ford Falcon 4.0 GLi, Fairmont, Fairmont, Futura XR6 Mpi (96-03), Ranchero 4.0 GLi, Outback, XR6 P/up 250 (97-99), Nissan Langley 1.3 GL E13 (83-88), Pulsar 1.3 S E13 (80-87)</p>
<p><b>68111+49</b></p>	<p>Front Wheel Bearing Inner / Outer</p>	<p>Chevrolet Spark 0.8 L, LS, 1.0 LT, LS (03-10), Daewoo Matiz 800cc S, SE F8CV (99-03)</p>
<p><b>68111+573315</b></p>	<p>Front / Rear Wheel Bearing Inner / Outer</p>	<p>Ford Bantam 1300 P/up Kent 2V, 1400 Leisure, Nite P/up CVH/FUA, 1600 Leisure Explorer, Nite P/up CVH (83-94), Escort FWD MkIII 1.3 GL, L Kent, 1.6 GLE, L, Sport, XR3, i HL16CVH (81-86), Sapphire 1.6 L Kent, 2.0, i GL, GLE, GLEA, GLi, GLi Exec. Koln, 3.0 Ghia, GLX Essex (89-93), Sierra 1.6 GL, GL S/W, L Kent, 2.0 GL, GL S/W Koln, 2.0 LX Koln, 3.0, i GLS, GLX, LX, RS, XR6 Essex (83-93), Mazda Rustler 1.3 SWB P/up Kent 2V Pet., 1.4 SWB P/up CVH/FUA Pet., 1.6 SWB, LX P/up CVH/ LUC Pet. (86-94)</p>
<p><b>68111+68149</b></p>	<p>Front Wheel Bearing Inner / Outer</p>	<p>Chevrolet Spark 0.8 L, LS, 1.0 LT, LS (03-10), Daewoo Matiz 800cc S, SE F8CV (99-03)</p>
<p><b>68334+95660</b></p>	<p>Sliding Door Bush</p>	<p>Sliding Door Bush 10/Pk</p>
<p><b>68334+95700</b></p>	<p>Sliding Door Bush</p>	<p>Bearing 10/Pk</p>
<p><b>688ZZ</b></p>	<p>Sliding Door Bearing</p>	<p>Various Makes &amp; Models</p>



## BUYERS GUIDE - LOOSE BEARINGS

<p><b>69310+45</b></p>	<p>Front Wheel Bearing Inner / Outer</p>	<p>Ford Bantam 130 Explorer P/up B3, 160, i Explorer, Leisure, Sport, P/up B6/ F6 (94-03), Laser 1.3 L, GL, 13, Dash E3 / B3 (86-95), Tracer 1.3 Sedan, H/back –Tonic, Plus B3 (86-02), Laser 1.4 L CHV-FUA, 1.5 GL, GLS, Sport E5/B5 (86-92), Laser 1.6, i GL, 16, Sport, TX3 B6/ F6, 2.0, i RS FE (86-95), Tracer 1.6 Sedan, H/back – Plus, Sport, Tonic B6/F6 (95-02), Meteor 1.3 GL, L, 13 E3/B3, 1.4 LX CVH, 1.5 GL, GLS E5 (86-95), 1.6, i GL, GLE, GLi,16, Sport B6/CVH/F6, 2.0 8/16V GLE, GLi FE (86-95), Mazda 323 FWD 1.3 S, H/back, Sedan E3, 1.5 GLC, SL, SLX, Sport H/back, Sedan E5 (81-88), 1.3 L, H/back, Sedan E/B3, 1.5, L H/back, Sedan E5, 1.6 EGi Hatch, L, Sedan, SL Hatch, SL Sedan, Sport Hatch B6i/F6 (84-91), 2.0 EGi Hatch, SLE Hatch, SLi Sedan, 200e Hatch, Sedan, 200i Hatch 8/16V FE-2000 (89-95), 130 Hatch, Midge, Sedan, Sting B3, 160, i, S Hatch, Midge, Sedan, Sting F6 (90-95), 130 Hatch, Midge, Sedan, Sting B3, 160, i, S Hatch, Midge, Sedan, Sting F6, 200i, e Hatch 8/16V FE 2000 (95-05), Rustler 130 SWB Drifter, Explorer P/up B3 Pet., 160, i SWB Explorer, Drifter P/up F6/B6i Pet. (94-02)</p>
<p><b>69310+49</b></p>	<p>Front Wheel Bearing Inner / Outer / Diff. Carrier Bearing</p>	<p>Daewoo Lanos I 1.35i S, 1.6 SX, Lanos II 1.4 S, 1.6 SX (97-03), Nubira I 1.6 SX, 2.0 CDX, Nubira II 1.6 SX, SX S/W, 2.0 CDX, Exec., S/W (97-03), Ford Courier 2.5TD D/cab, Leisure P/up WL4, 3.0 V6 Std., XLT, D/cab, Leisure, Explorer, Exec. P/up Essex, 3.4 V6 Leisure, P/up Essex. - 4X4 (96-00), Ranger 1.8 XL, P/up, 2.2 XL, P/up (04-10), 2.5 D/Cab,High Trail, XL, DT XLT High Super Cab, 2.5TD Montana D/ Cab WL4, 3.0TDCi, 4.0 Super Cab XLT (00-04), Kia Pride 1.3i LX 5 Dr. H/back, Rio I 1.3 5 Dr. H/back A3E, 1.5 5 Dr. H/back A5D (98-04), Sephia 1.5i LS, RS 4 Dr. Sedan BFD (04-05), Spectra 1.6 Exec. A6 (01-03), Sportage JA 2.0 SUV 5 Spd. FE Pet. 4X4 (98-03), Mazda B-Series B2600 2.6 V6 LWB D/cab, Magnum, Drifter P/up 4G54 Pet., B3000 3.0 V6 LWB D/cab, Magnum, Drifter, Magnum Drifter P/up Essex Pet. - 4X4 (86-97), B2500 2.5, Td LWB D/Cab, Drifter, SLX P/up WL4 Dies./Turbo Dies., B3400 3.4 V6 LWB Magnum D/cab P/up Essex - 4X4 (96-01), B2600i 2.6i V6 LWB Drifter, D/ cab Drifter SLX P/up 4G54 Pet. - 4X4 (00-09), Drifter 1.8 SWB/LWB XL P/up Pet., 2.2 SWB/LWB XL P/up Pet., 2.5Td LWB Hi Ride, SL SLE,SLX D/cab, Hi Ride, Hi Trail D/ cab P/up WL4 Dies./Turbo Dies., 2.6i LWB Hi Ride, SL Hi Ride S/cab, SLE, SLX D/ cab SLX Hi Ride D/cab, SLX Hi Trail D/cab P/up Pet. - 4X2 (04-09), 2.5Td LWB D/ cab, DL, SL, SLE, SLX S/cab, D/cab P/up WL4 Dies./Turbo Dies., 2.6i V6 LWB SL S/ cab, SLE, SLX D/cab P/up 4G54 Pet. - 4X4 (02-04), Opel Astra F 180i, iE 18SE/ XE, XL, 200i, e, ts 20SE/ XE, Kadett F 180i, iE, GSi 18SE, 200is 20XE (93-99)</p>
<p><b>801310+46</b></p>	<p>Diff. Pinion Bearing Front</p>	<p>Mitsubishi Canter 2.5, 2.6, 3.3, 3.8 (80-97)</p>
<p><b>802011+48</b></p>	<p>Diff. Pinion Bearing</p>	<p>C.A.M. Inyathi Jinbei Haise Minibus 2.2i Std. (2007-), Ford Courier 2.5 Turbo Diesel D/cab, Leisure P/up WL4 - 4X2, 4X4 (96-00), 3.4 V6 Leisure, P/up Essex. - 4X4 (97-00), Ranger 1.8 XL, P/up, 2.2 XL, P/up (00-10), 2.5 Diesel, Turbo Diesel D/Cab, High Trail, XL, DT XLT High Trail D/Cab, Super Cab - 4X2 (00-09), 2.5 D/Cab,High Trail, XL, DT XLT High Super Cab, 2.5TD Montana D/Cab WL4, 3.0TDCi, 4.0 Super Cab XLT - 4X4 (00-12), Kia Sportage JA 2.0 SUV 5 Spd. FE Pet. - 4X4 (98-03), Land Rover Freelander 1.8i S/W Pet., 2.0 Di S/W, Td4 SUV Pet., 2.5 V6 SUV KV6 Pet. (98-04), Mazda B-Series B2600 2.6 LWB D/cab, Magnum, Drifter P/up 4G54 Pet., B2600i 2.6i LWB D/cab Drifter, SLX P/up 4G54 Pet. - 4X2 (2000-), B2500 2.5, Td LWB D/Cab, Drifter, SLX P/up WL4 Dies./Turbo Dies., B3400 3.4 V6 LWB Magnum D/cab P/up Essex - 4X4 (96-01), B2500 2.5 LWB Diesel, Turbo Diesel D/cab, Drifter, SLX P/up WL4 Dies., Turbo - 4X2 (97-00), B2600i 2.6i V6 LWB Drifter, D/cab Drifter SLX P/up 4G54 Pet. - 4X4 (00-09), Drifter 1.8 SWB/LWB XL P/up Pet., 2.2 SWB/ LWB XL P/up Pet. (00-09), 2.5Td LWB Hi Ride, SL SLE,SLX D/cab, Hi Ride, Hi Trail D/cab P/up WL4 Dies./Turbo Dies., 2.6i LWB Hi Ride, SL Hi Ride S/cab, SLE, SLX D/ cab SLX Hi Ride D/cab, SLX Hi Trail D/cab P/up Pet. - 4X2 (00-09), 2.5Td LWB D/ cab, DL, SL, SLE, SLX S/cab, D/cab P/up WL4 Dies./Turbo Dies., 2.6i V6 LWB SL S/cab, SLE, SLX D/cab P/up 4G54 Pet. - 4X4 (02-09), Mercedes-Benz W124 200E M102.922, 220E M111.960, 230E M102.982, 260E M103.940, 280E M104.942, 300D M103.985, M606.910, 320 Sportline M104.922 (86-96), W124 E Class E200 M102.922, E220 M111.960, E320 Sportline, M104.992 (93-96), W126 280SE M110 987/9, 300SE M103.981, 380SE M116.963, 420SE M116.965, 500SE M117.965 (86-93), R170 SLK320 M112.947 (97-02), W201 2.0 M102.922, 2.3 Sportlin (93-94), W202/3 C-Class C180 Classic M111.920, C200 M111.941, C220 M111.961, C230 M111.974, C240 M111.944, C250 M605.910, C270CDi M612.962, C280 M104.941 (94-08), W210/211 E-Class E230 M111.970, E240 M112.911 (96-10),</p>
<p><b>802011+48... Continued</b></p>	<p>Diff. Pinion Bearing</p>	<p>Mitsubishi Colt LDV 1.6 SWB/LWB Lo-Line P/up 4G32 Pet., 2.0 4G63 Pet., 2.5D 4D56 Dies., 2.6 WB Hi-Line P/up 4G54 Pet., 2.8D LWB Std., Hi line P/up Dies., 2.8TDi LWB Club CabS cab,Turbo, 3.0i V6 LWB Club S/cab P/up Pet. (94-98), 2.5D LWB Hi-Line P/up 4D56 Dies., 2.6 LWB Lo-/Hi-Line, P/up 4G54 Pet., 3.0 V6 LWB Lo-/ Hi- Line D/cab, Rodeo 6G72 Pet. - 4X4 (95-98), 2.0 LWB Std. P/up, 2.0i LWB Hi-Line, 2.4i LWB Hi-Line Rodeo S-/D/cab, Hi-Line/Rider P/up Pet., 2.5D 4D56 Dies. (98-09), Pajero 2.8 Tdi, 3.0 V6 SWB GLS Wagon 6G72 Pet., 3.5 V6 SWB GLS Wagon 6G74 Pet. - 4X4 (90-01), Toyota Hiace YH53/63 2.2 SWB/LWB P/van, Van, LS, Super T/14/16, GLX, Exec. Wagon, Siyaya Bus, P/van 4Y Pet. (All Local Models) (88-09)</p>

## BUYERS GUIDE - LOOSE BEARINGS

<b>803110+46</b>	Diff. Pinion Bearing Front	Land Rover 109 2.25, 2.6 (71-84 ), 110 3.5, 2.6, 3.9 (81-96), 88 2.25 (72-78)
<b>803110+49</b>	Diff. Pinion Bearing Rear	BMW 728, 728i, 730, 733i (78-85), Mercedes-Benz E240, E270, E280, E320, E430, E500 (96-04), Mitsubishi Canter - All (80-97)
<b>806610+49</b>	Diff. Carrier Bearing	Mercedes-Benz 250SE, 280E, S, SE, 300SE, 380SE, 420SE, 500SE (66-93)
<b>84510+48</b>	Diff. Carrier Bearing	Mercedes-Benz 190E 1.8, 2.0 (93-94), C180, C200, C220, C230, C240, C250, C270, C280, C320 (94-08), CLK230, CLK320 (98-04), E200, E220, E230, E240, E270, E280, E320, E430, E500 (96-04), SLK200, SLK230 (97-04), S320, S420, S500 ( 93-99), SLK200 (97-04)
<b>86610+49</b>	Diff. Pinion Bearing Front	Various Makes & Models
<b>88010+43</b>	Diff. Pinion Bearing Front, Rear	Jaguar XJ6 2.8, 4.2 (69-80), Mitsubishi Colt LDV 2.8D, 2.8TD - 4X4, 2.4i, 2.8D, 3.0i (98-09)
<b>88510+42</b>	Diff. Pinion Bearing Front	BMW E30 Series (83-92), E36 Dolphin Shape (92-00), E28 Series (85-89), E34 Series (90-96), E23 Series (81-89), E32 Series (87-95), E31, E38 Series (91-03), M3 M Coupe (93-01), M3 Coupe 6 Cyl. (01-04), M5 Coupe (86-94)
<b>88610+49</b>	Diff. Pinion Bearing Rear	Various Makes & Models
<b>89410+49</b>	Diff. Pinion Bearing Rear	BMW 316, 316i, 318i, 320i, 323i, 325i, 328i, 333i (83-00), 518, 518i, 520, 520i, 525, 525e, 525i, 528, 528i, 530, 530i, 535i, 540i (74-96), 635CSi (80-89), 728, 728i, 730, 730i, 733i, 735i, 740i, 745i, 750i (78-96), M Coupe (99-01), M3 (93-98), M5 (86-94), M535i (81-85), Ford Capri 1.6, 2.0, 3.0 (69-73), Mercedes-Benz 200, 220, 220D, 230, 230/4, 230/6, 230E, 240D, 250SE, 280, E, S, SE, 300D (68-86), Peugeot 404 1.8, 1618, 2.0 (63-80)
<b>894410+46</b>	Diff. Pinion Bearing Rear	Ford Falcon 4.0 (96-01)
<b>94912RS</b>	Alternator/Generator Bearing	Honda Ballade 1.5, 1.6, 1.8 (89-00)
<b>AVZ44KB721</b>	Diff. Carrier Bearing Left & Right	Toyota Avanza 1.3i (06-12), 1.3, 1.5 (12-16 )
<b>AVZPF0506</b>	Diff. Pinion Bearing Front	Toyota Avanza 1.3i, 15-16 1.3, 1.5 (06-12)
<b>AVZPF3072</b>	Diff. Pinion Bearing Rear	Toyota Avanza 1.3i only, 12-16 1.3, 1.5 (06-12)
<b>AVZPR3072</b>	Diff. Pinion Bearing Rear	Toyota Avanza 1.3i (06-16), 1.3, 1.5 (2015-)
<b>B011D</b>	Front Wheel Bearing Inner	Audi A6 2.7T (00-05)
<b>B10-50D</b>	Alternator/Generator Bearing	Nissan Sani 2.4, 2.7 (98-99), Sentra 1.8i, 2.0 (89-02), Hardbody 2.0, 2.4i, 2.7, 3.0, 3.0i, 3.2, 3.3 - 4X2, 2.4i, 2.7, 3.0, 3.2, 3.2D, 3.3 - 4X4 (98-04), Patrol 3.0, 4.2 (94-04), Terrano II 2.7 (00-02)
<b>B15-86</b>	Alternator/Generator Bearing	Mitsubishi Colt LDV 3.0 (94-98), Pajero 3.0 (90-98)
<b>B17-102</b>	Alternator/Generator Bearing	Ford Telstar 2.0, 2.5 (93-98), Mazda 626 2.0, 2.0i, 2.5i (93-03), Astina 1.8 (95-00), Etude 1.6, 1.8 (95-00), MX6 2.5, 2.5i (93-98)
<b>B32+10</b>	Rear Wheel Bearing Inner, Diff. Carrier Bearing	Nissan 1200 (71-75), 120Y (75-80), 1400 (78-80), 140Y (75-80), 200 (78-80), 280 (78-80), Laurel 2.0, 2.8 (80-87), Skyline 1.8, 2.0 (82-87), 1200 (71-75), 120Y (75-80), B120 (71-73), Hardbody 2.4 - 4X4 (91-98), Sani 2.4 (91-94), Toyota Corolla 1.2 (72-80)
<b>B3553AP</b>	Rear Wheel Bearing Inner	Toyota 66-80 Corona 1.5, 1.6, 1.7, 1.8, 2.0, 76-81 Cressida 2.0, 2.6, 87-91 Stallion 1.5, 82-87 TUV 1.3, 1.5
<b>B36Z10</b>	Front Wheel Bearing	Toyota Hilux 3.0D D-E - 4X4
<b>B8-79D</b>	Alternator/Generator Bearing	Mitsubishi Colt LDV 1.6, 2.0, 2.5, 2.5d, 2.6 (94-98), Colt LDV 2.5, 2.6, 3.0 - 4X4 (94-98), Pajero 3.0 (90-98 )
<b>B8-85D</b>	Alternator/Generator Bearing	Ford Laser 1.3, 1.5 (86-89), Meteor 1.3, 1.5 (86-89), Honda Ballade 1.5 (89-92), Mazd 626 2.0 (83-92)
<b>B8-85DW</b>	Alternator/Generator Bearing	Ford Falcon 4.0 (96-01), Telstar 2.0, 2.5 (93-98), Mazda 626 2.0, 2.0i, 2.5i (93-03), Astina/Etude 1.6, 1.8 (95-04), MX6 2.5, 2.5i (93-98)
<b>B8-86DW</b>	Front Wheel Bearing Alt.	Mitsubishi Colt Bakkie 2.8TD - 4X2, 4X4 (1998-)
<b>BAK940325</b>	Rear Wheel Bearing Inner	Mitsubishi Colt LDV 2.0, 2.0i, 2.4i, 2.5, 2.8D - 4X2, 2.4i - 4X4 (98-09)
<b>BKT007</b>	Quantum Roller Door Bearings	Toyota Quantum
<b>BKT007B</b>	Roller Door Bearing With Brack	Toyota Quantum
<b>BKT008</b>	Quantum Roller Door Bearings	Toyota Quantum

## BUYERS GUIDE - LOOSE BEARINGS

<b>BKT009</b>	Quantum Roller Door Bearings	Toyota Quantum
<b>BKT013</b>	Upper Roller Door Bearing	Nissan Nv350
<b>BKT014</b>	Middle Roller Door Bearing	Nissan Nv350
<b>BKT015</b>	Lower Roller Door Bearing	Nissan Nv350
<b>BKT016</b>	Lower Roller Door Bearing	Nissan Nv350
<b>BNIB493353</b>	Spigot shaft brg.	Opel Ascona 1.3, 1.6, 1.8 (82-87), Kadett 1.2, 1.3, 1.4, 1.6, 1.8 (80-93)
<b>D/S35</b>	Rear Wheel Bearing	Dodge Nitro (07-10), KK Jeep Cherokee 2.8 CRD (08-11)
<b>D/S44</b>	Rear Wheel Bearing	Jeep Wrangler TJ 2.8 CRD (04-11)
<b>DAC01WD10</b>	Rear Wheel Bearing Inner	Nissan Sentra 1.3 GL, SX E13S, 1.6 GL, GX, GXE GXEi Coupe, SGLi E16E/S (87-92)
<b>DAC01WD7</b>	Rear Wheel Bearing Inner	Nissan Sentra 1.6 GL, GX, GXE GXEi Coupe, SGLi E16E/S (87-92), 1.8i Coupe, Sedan Exec. CA18DE (89-92)
<b>DAC0871</b>	Front Wheel Bearing Inner	Honda Ballade SC9 "Flip up Lights" 130 EV2, 150, i EW, 160i DOHC ZC1 (84-89), SH4 150 16V SOHC D15B3, 160i 16V SOHC, DOHC D16A9 (89-92)
<b>DAC255543</b>	Rear Wheel Bearing Inner	Renault Clio IV 0.9T, 1.2 (2013-), Kangoo 1.4, 1.5dCi (03-10), Kangoo Express Van 1.4, 1.5 (01-10), Logan 1.6 (2009-), Sandero 1.4, 1.6 (09-15)
<b>DAC255545</b>	Rear Wheel Bearing Inner	Renault Clio I/ II 1.2, 1.4, 1.5DCi, 1.6, 2.0 (04-06), Clio III 1.4, 1.5DCi, 1.6, 2.0 (2006-), Grand Scenic 1.9dCi Privilege, 2.0 Expression (2005-), Megane II 1.4, 1.5dCi, 1.6, 1.9dCi, 2.0, T (2002-), Modus 1.4, 1.6 (05-08), Scenic II 1.6, 1.9dCi, 2.0 (2002-)
<b>DAC255548</b>	Rear Wheel Bearing Inner	Nissan Almera 1.5 (2013-), Datsun Go/ Go+ 1.2 (2014-), Micra (K12/13) 1.2, 1.4, 1.5DCi (2011-), Renault Grand Scenic 1.9dCi, 2.0 (04-10), 1.6 (07-08), Megane II 1.5dCi, 1.6, 1.9dCi, 2.0, T (02-10), Megane III 1.2, 1.4, 1.6, 2.0 (2010-), Scenic II 1.6, 1.9dCi, 2.0 (02-10)
<b>DAC25ALTO</b>	Rear Wheel Bearing	Suzuki Alto (2009-), Celerio 1.0 K10B (2015-)
<b>DAC303008</b>	Front Wheel Bearing	Peugeot 3008 1.6 (2010-)
<b>DAC30BWDVAVZ</b>	Front Wheel Bearing Inner	Toyota Avanza 1.3i P/Van, S, SX MPV K3VE, 1.5i SX, TX MPV 3SZVE (06-12)
<b>DAC30BWDVAV-ZASB</b>	Front Wheel Bearing	Toyota Avanza - All (2006-)
<b>DAC30CLIO</b>	Rear Wheel Bearing	Renault Clio IV 1.2 (2013-)
<b>DAC30DUST</b>	Rear Wheel Bearing	Renault (Dacia) Captur 0.9 Tce H4B400, 1.2 Tce H5F408, 1.5 Dci K9K (2016-), Duster 1.6 (2013-)
<b>DAC32LEX</b>	Front Wheel Bearing	Lexus IS200, 300 (02-04)
<b>DAC346737</b>	Front Wheel Bearing Inner	Chevrolet Utility 1.3D, 1.4 Pet., 1.8 Pet. (11-15), Opel Corsa C 140i Classic, Comfort, Chill, Classic Essentia, Hatch Club, Sport, Lite Sport, S14NE, 160i Classic, Classic Elegance, Classic CD, CDE, Sport, 16SE, 1.7TDi Sport, Classic, CDTi Enjoy, Hatch CDTi Elegance, Classic DTi Elegance X17D, 1.8i GSi Hatch, Classic (03-08), Corsa LDV II 1.4i Utility, Club Sport, S P/up 14XE, 1.7DTi Utility Club, Sport P/up, 1.8i Utility Club, Sport P/up (03-10), Corsa P/van 1.3i Pronto 13NE, 1.4i Combo P/van (1999-), Meriva 1.3 CDTi Enjoy, 1.4 Essentia, Enjoy, 1.6 Club, Comfort, Enjoy MPV Z16SE/-XE, 1.7 CDTi Enjoy, Elegance, 1.8 Elegance MPV Easytronic (03-09)
<b>DAC346737</b>	Front Wheel Bearing Inner	Opel Corsa 140i, 1.6i, 1.7TDi, CDTi, 1.8i (02-08), Meriva 1.4, 1.6, 1.7CDTi, 1.8 (03-09), Corsa LDV 1.4i, 1.6i, 1.7DTi, 1.8i (2003-), Corsa Combo 1.4i P/van (2006-)
<b>DAC356437</b>	Front Wheel Bearing Inner	Daihatsu Charade 1.0 (2003-), Sirion 1.0, 1.3 (00-07)
<b>DAC357234</b>	Front Wheel Bearing Inner	Honda Ballade SA4 1300 EN4 (82-85)
<b>DAC35ALTO</b>	Front Wheel Bearing	Suzuki Alto (2009-), Celerio 1.0 K10B (2015-)
<b>DAC35LEX</b>	Front Wheel Bearing	Lexus GS300 (02-05)
<b>DAC35MAT</b>	Front Wheel Bearing	Daihatsu Materia 1.5 (07-11)
<b>DAC36PIC</b>	Front Wheel Bearing	Kia Picanto (2011-)
<b>DAC36UP</b>	Front Wheel Bearing	VW Up 1.0 (2015-)
<b>DAC375225</b>	USE - FC12784P	
<b>DAC37STILO</b>	Front Wheel Bearing	Fiat Stilo 1.6 (03-06)

## BUYERS GUIDE - LOOSE BEARINGS

<b>DAC387037</b>	Front Wheel Bearing Inner	Hyundai Accent LC 1.3 G4EH, 1.5 G4EK, 1.6 G4ED (00-06), Accent MC 1.6 G4ED (06-11), Accent RB 1.6 G4FC (2011-), Atos 1.0 Prime G4HC (00-05), 1.1 G4HG (2005-), Elantra J2 1.6 RD G4GR, 1.8 G4FG, 2.0 G4GC (95-01), Getz 1.3 G4EA, 1.4i G4EE, 1.5 D3EA, D4FA, 1.6 G4ED-G (03-12), i10 PA 1.1 G4HG, 1.2 G4LA (08-15), Grand i10 1.1 G3LA (2017-), 1.2 G4LA (2014-), i20 PB/PBT 1.2 G4LA, 1.4 G4FA, 1.6 G4FC (2009-), Tiburon 2.0 G4DF (96-10), Kia Picanto 1.1 LX, EX 5 Dr. H/back G4HG (04-11), Rio II 1.4 High, A5D, 1.6 Sport G4ED (2004-), Rio III 1.2 CVVT G4LA, 1.4 G4FA (2011-)
<b>DAC387139</b>	Front Wheel Bearing	GWM MK 1.5, 1.6 (2010-), Toyota Yaris 1.0, 1.3 (99-05)
<b>DAC3871W</b>	Front Wheel Bearing	Toyota Conquest, Corolla 1.3, 1.6, 1.8 (88-05)
<b>DAC3871W1CS74</b>	Front Wheel Bearing	Toyota Conquest, Corolla 1.3, 1.6, 1.8 (88-05)
<b>DAC387437ABS</b>	Front Wheel Bearing	Hyundai Accent 1.6 G4FG Pet., Kia Rio IV 1.2 G4LA Pet., 1.4 G4LC Pet. ( 2017-)
<b>DAC387233</b>	Front Wheel Bearing Inner	Toyota Conquest / Tazz EE80 1.3 GL, GS, L, S 2EL (85-93), EE90R 130 Sport, Tazz, Edition, Zipp, Tropicque (93-01), Tazz EE90R 130 Edition, Ruby, Tropicque, Sport, McTazz, XE 2E (01-06), AE82R 1.6 GL, RS, RSi 4A-L, A-GEL (85-88), AE92R 160i LS, RS, RSi, Sport, RSE, Tazz 4A-F, A-FE, A-GE (88-01), AE92R 160i Edition, Sport, Tazz, XE 4AFE (01-06), Conquest AE93 180i RS, RSi, Sport 7A-FE (93-96), EE90 130 Carri P/van, 2E (98-06), Corolla FWD AE/EE80R 1.3 GL, L, 2A-L, E-L (84-88), EE90R 1.3 GL, GLE, L, Sprinter 2E-L, E (88-96), EE110R 130 GLE, Sprinter 2E (96-02), AE92R 1.6, 160 GL, GLE, GLi, Exec., GLS, Exec., GLX, Sport Sprinter 4A-F, A-FE, A-GE (88-96), AE93R 180i GL, GLE, GSE, GSX, Sprinter 7A-FE (93-96), AE111R 160i GL, GLE, RSi, Rxi 4A-FE, A-GE, AE112 180i GLE, GSE 7A-FE (96-02)
<b>DAC387234</b>	Front Wheel Bearing Inner	Honda Prelude 1.8 (84-87)
<b>DAC387236</b>	Front Wheel Bearing	Toyota Conquest, Corolla 1.3, 1.6, 1.8 (88-05)
<b>DAC3872W</b>	Front Wheel Bearing	Toyota Conquest, Corolla 1.3, 1.6, 1.8 (88-05)
<b>DAC387340</b>	Front Wheel Bearing Inner	Honda Ballade SR4 150 Encore, Luxline, Spreeline D15B3, 160E, i D16A7, 180E, i B18B3 (92-98), CR-V II 2.0 K2OA4 - 4X4 (05-09), Odyssey 2.2 5 Dr. S/W, 2.3 V-Tec 5 Dr. S/W (96-02)
<b>DAC387340ASB</b>	Front Wheel Bearing Inner	Honda CR-V II 2.0 K2OA4 - 4X4 (05-09), Jazz 1.4i, 1.5i (04-08)
<b>DAC387436</b>	Front Wheel Bearing	Nissan Sabre 160, 200 (94-02)
<b>DAC38BRIO</b>	Front Wheel Bearing	Honda Ballade (2011-), Jazz 1.3 hybrid (2011-)
<b>DAC38BWDVAV-ZASB</b>	Front Wheel Bearing Inner	Daihatsu Gran Max 1.5 I 3SZ-VE (2009-), Terios 1.3 SUV K3-VE, 1.5i Off-Road, 5/7 Seater SUV 3SZ-VE, 1.5 - 4X2, 4X4 (02-15), Toyota Avanza 1.3i P/Van, S, SX MPV K3VE, 1.5i SX, TX MPV 3SZVE (06-12), 1.3 S, SX MPV 3K3VE, 1.3 S P/Van 3K3VE, 1.5 SX, TX MPV 3SZVE (12-16), 1.3 S, SX MPV 1NRVE, 1.3 S P/Van 1NRVE, 1.5 SX, TX MPV 2NRVE (2015-)
<b>DAC38RIO</b>	Front Wheel Bearing	Hyundai Grand i10 III 1.0 Mpi G3LA, G3LD Pet. (2019-), Kia Picanto III (JA) 1.0 G3LA, G3LD Pet., 1.2 G4LA Pet. (2017-), Rio III 1.2, 1.4 (2011-)
<b>DAC4017A</b>	Front Wheel Bearing Inner	Toyota Yaris 1.0, 1.3, 1.8i (2005-)
<b>DAC4017A</b>	Front Wheel Bearing Inner	Toyota Yaris 1.0 T1, 1.3 T3, +, Spirit , T3 Spirit - Saloon & Hatch 2NZ-FE, 1.8 TS Hatch (05-10), 1.0, 1.3 ZEN3, 1.5 Hybrid (10-18)
<b>DAC408036</b>	Front Wheel Bearing Inner	Hyundai Sonata Y3 2.0 G4CP, 2.5 V6 G6BV, 3.0 V6 G6AT (94-04)
<b>DAC4080P</b>	Front Wheel Bearing Inner	Volvo S40 1.9, V40 1.9 (97-98)
<b>DAC40FWBAVEO</b>	Front Wheel Bearing Inner	Chevrolet Aveo 1.5 L, LS, LT, 1.6 LS (03-15), Sonic 1.3D, 1.4 Pet. Hatch / Sedan, 1.6 Pet. Hatch / Sedan (11-15), Opel Meriva 1.4T (12-15), Mokka 1.4T A14NET, B14NET (15-16)
<b>DAC40MOND</b>	Front Wheel Bearing	Ford Mondeo 2.0 (2002-)
<b>DAC40SOR</b>	Rear Wheel Bearing	Kia Sorento 2.5 CRDI (2003-)
<b>DAC427537ASB</b>	Rear Wheel Bearing Inner	BMW F30 318i, 320i, 320d, 330i, 340i Sport, F34 Gran Turismo 320d (2015-), Gran Turismo 320i (2016-)
<b>DAC427639</b>	Rear Wheel Bearing Inner	Hyundai Santa Fe 2.4, 2.7 - 4X4 (01-06)
<b>DAC427737</b>	Front Wheel Bearing	Nissan Micra - All Models (2004-), Renault Clio - Some (2006-), Megane II, Scenic II (2004-), Modus - All except 1.9DCi (2005-)
<b>DAC428036</b>	Front Wheel Bearing	Hyundai Sonata - All (95-02), Tiburon 2.7 V6 Only (02-09)
<b>DAC428045</b>	Front / Rear Wheel Bearing Inner	Ford Telstar 2.0 GL, GLE, GLi, Mystique FS/KF, 2.5 V6 Ghia, GLi KL, TX5 2.5 V6 RSi KL (94-99), Kia Carens 1.8 LS 5 Dr. MPV TBD In-Line (00-03), Spectra 1.6 Exec. A6 (01-03), Mazda 6 2.0 Active, Original, Elegant, 2.3 Dynamic, Dynamic Individual, Sporty, Sporty Lux, 2.3 MPS AWD, 2.5 Dynamic Activematic, Individual (03-14), 626 2.0i 16V Medium High, V6 24V High KF/KS, 2.5i V6 Exec. KL, MX-6 2.5 V6 KL (93-98), MX-5 1.6 (90-93), 1.8 16V (01-09), 2.0 (05-14)



## BUYERS GUIDE - LOOSE BEARINGS

<b>DAC428045ASB</b>	Front Wheel Bearing Inner	Mazda 3 2.0, 2007- 5 2.0 Mpv (2004-)
<b>DAC428245</b>	Front Wheel Bearing	Citroen Xsara, Picasso 1.6, 1.8 (01-06), Berlingo 1.4, 1.9D (2003-), Peugeot 206 2.0 (01-06), 306 1.6, 2.0 (95-03), 405 1.6, 1.8, 406 1.6, 1.8, 2.0, 3.0 (95-06)
<b>DAC42DUST</b>	Front Wheel Bearing	Renault (Dacia) Duster 1.5 DCI - 4X4 (2013-)
<b>DAC42DUST2</b>	Rear Wheel Bearing	Renault (Dacia) Duster 1.5 DCI - 4X4 (2013-)
<b>DAC42NEO</b>	Front Wheel Bearing	Chrysler Neon 1.6, 2.0 (02-06)
<b>DAC43FWBDC</b>	Front Wheel Bearing (with integrated sensor ring)	Dodge Caliber 1.8 SE, 1.8SXT, 2.0 TD, 2.0SXT, CVT, 2.4 RT (06-12)
<b>DAC4484</b>	Front Wheel Bearing	Honda Prelude 2.2 (91-97)
<b>DAC44FREE</b>	Rear Wheel Bearing	Land Rover Freelander II 2.2D, TD4 (07-10)
<b>DAC458045</b>	Front, Rear Wheel Bearing Inner	VW Kombi 2.5 Tdi, 2.8i (99-04)
<b>DAC458441ASB</b>	Rear Wheel Bearing	BMW 328i GT (2013-), F30 318i, 320i, 320d, 330i, 340i Sport, F34 Gran Turismo 320d (2015-), Gran Turismo 320i (2016-)
<b>DAC458541</b>	Rear Wheel Bearing Inner	BMW 330Ci, 330d (00-05), 740i, 750i (95-03), 850i (91-94)
<b>DAC458541ASB</b>	Rear Wheel Bearing Inner (with integrated sensor ring)	BMW 116i, 118i, 120d, 125i (11-16), 330Ci, 330d (00-05), 740i, 750i (95-03), 850i (91-94)
<b>DAC45HYH1ABS</b>	Rear Wheel Bearing	Hyundai H1 2.4, 2.5 (2009-)
<b>DAC45MEG</b>	Front Wheel Bearing	Renault Megane III 2.0 RS (2012-)
<b>DAC45MEG2</b>	Front Wheel Bearing	Renault Megane III 2.0 RS (2012-)
<b>DAC45VIV2</b>	Front Wheel Bearing	Opel Vivaro 1.9 CDTI - To Chassis: 3V613233 (2006-)
<b>DAC46RWVWAM</b>	Rear Wheel Bearing	VW Amarok 2.0TDi (2010-)
<b>DAC488944</b>	Rear Wheel Bearing Inner	Toyota Land Cruiser 4.2, 4.5, 4.7 - (98-04)
<b>DAC48EVOQ</b>	Rear Wheel Bearing	Land Rover Evoque 2.0, 2.2 (2011-)
<b>DAC498846</b>	Front, Rear Wheel Bearing Inner	Mercedes-Benz S320, S420, S500 (93-99), ML230, ML320, ML430 (98-07)
<b>DAC49LEX</b>	Rear Wheel Bearing	Lexus IS200, 300 (02-04)
<b>DAC49VWAMASB</b>	Front Wheel Bearing	VW Amarok 2.0TDi (2010-)
<b>DAC4TCR1</b>	Rear Wheel Bearing Inner	Ford Ranger 2.5 Diesel, Turbo Diesel D/Cab, High Trail, XL, DT XLT High Trail D/ Cab, Super Cab, 3.0TDCi Super Cab XLT Hi-Trail., 4.0 SubCab XLT Hi Trail, Super Cab XLT Hi-Trail. - 4X2 (05-12), 2.5 D/Cab, High Trail, XL, DT XLT High Super Cab, 2.5TD Montana D/Cab WL4, 3.0TDCi, 4.0 Super Cab XLT - 4X4 (05-09), Mazda BT-50 2500 Tdi, 2.6i SLE D/cab., S/cab., 3000 CRDi SLE D/cab., Freestyle SLX S/cab., D/cab - 4X2, 2500 Tdi 2.6i SLE D/cab., S/cab., 3000 CRDi SLE D/cab., Freestyle SLX S/cab., D/cab - 4X4 (07-12), Drifter 2.5Td LWB Hi Ride, SL SLE, SLX D/cab, Hi Ride, Hi Trail D/cab P/up WL4 Dies./Turbo Dies., 2.6i LWB Hi Ride, SL Hi Ride S/ cab, SLE, SLX D/cab SLX Hi Ride D/cab, SLX Hi Trail D/cab P/up Pet. - 4X2 (00-09), 2.5Td LWB D/cab, DL, SL, SLE, SLX S/cab, D/cab P/up WL4 Dies./Turbo Dies., 2.6i V6 LWB SL S/cab, SLE, SLX D/cab P/up 4G54 Pet. - 4X4 (02-09), Nissan Hardbody QW/D22 2.7D TD27i, 3.0 i VG30E, 3.0TD ZD30, 3.2 QD32 (98-10), 2.4i KA24E, 2.7 TD27, 3.0 VG30E, 3.0TD ZD30, 3.2, 3.2D QD32, 3.3i VG33 - 4X4 (04-10), NP300 D22 2.0i, S, SE KA20, 2.4i, S/C, D/C Highrider KA24 DE, 2.5TDi, S, SE Highrider YD25, 2.5TDi, S, SE YD25 (2008-), 2.4i, S/C, D/C, Highrider KA24 DE, 2.5TDi, S, SE, Highrider YD25 - 4X4 (2008-)
<b>DAC50DISC</b>	Rear Wheel Bearing	Land Rover Discovery III 2.7 TD V6 (05-09)
<b>DAC50VITO</b>	Rear Wheel Bearing	Mercedes- Benz Viano, Vito (2006-)
<b>DAC51CRV (WAS DAC519144CRV)</b>	Front Wheel Bearing	Honda CR-V II 2.0 K20A4 - 4X4 (05-09), CR-V III 2.0 i-VTEC R20A1, 2.2 i-CTDi N22A2, 2.2 i-DTEC N22B3, 2.4 i-Vtec K24Z1, K24Z4 - 4X4 (09-12), CR-V IV 2.0 R20A6, 9, 2.0 i-VTEC R20A5, 6, 9, 2.2 i-DTEC N22B4, 2.4i K24Z9 - 4X2, 4X4 (2012-)
<b>DAC51RANGE</b>	Front & Rear Wheel Bearing	Land Rover Range Rover 3.0TD (2002-)
<b>DAC51VWASB</b>	Front & Rear Wheel Bearing	VW Touareg 2.5TDi, 3.0TDi, 3.6 FSi, 4.2 FSi, 5.0TDi (2004-)
<b>DAC52FWBHA</b>	Front Wheel Bearing	Honda Accord - VIII - 2.0, 2.0i V-Tec, 2.4i V-Tec, 2.2i CTDi (08-15)
<b>DAC52ML</b>	Rear Wheel Bearing	Mercedes Benz ML250, 350, 500 (2012-)

## BUYERS GUIDE - LOOSE BEARINGS

<b>DAC54ML</b>	Front & Rear Wheel Bearing	Mercedes Benz W164 M-Class ML350 (2006-)
<b>DAC55BOX</b>	Front Wheel Bearing	Peugeot Boxer 2.2Hdi, 3.0Hdi (06-17)
<b>DAC80WD8</b>	Front Wheel Bearing Inner	Nissan Sentra 1.3 GL, SX E13S, 1.6 GL, GX, GXE GXEi Coupe, SGLi E16E/S (87-92), 1.8i Coupe, Sedan Exec. CA18DE (89-92)
<b>DAC82625D</b>	Rear Wheel Bearing Inner	VW Passat – Models with BDN, BDP, Quattro Models only (03-07)
<b>DAC9113X</b>	Rear Wheel Bearing Inner	Nissan X-Trail 2.0, 2.2D, 2.5 - 4X4 (01-08)
<b>DACF1015</b>	Rear Wheel Bearing Outer	Honda Ballade SH4 150 16V SOHC D15B3, 160i 16V SOHC, DOHC D16A9 (89-92), SR4 150 Encore, Luxline, Spreeline D15B3, 160E, i D16A7, 180E, i B18B3 (92-98), SO4 150i Encore, Luxline, Spreeline D15Z4, 160i Luxline, Spreeline, V-Tec D16Y9, D16Z, 180i Luxline B18B4 (96-00), Civic SO3 150i Luxline, Spreeline D15Z4, 160i Luxline, V-Tec D16Z (96-00)
<b>DACF1097C</b>	Rear Wheel Bearing Inner	Toyota Camry I SXV10/11 R 200i Si 3S-FE, 220 SEi, Si, 5S-FE (92-01)
<b>DACFWB107ASB</b>	Front Wheel Bearing Inner	Citroen C1 1.0, I (06-15), Peugeot 107 1.0i, 1.4Hdi (2006-), Toyota Aygo 1.0 (2011-)
<b>DACFWB35PTO</b>	Front Wheel Bearing	Fiat Punto 1.2 16V (04-13)
<b>DACFWB40NEON</b>	Front Wheel Bearing	Chrysler Neon 1.8/2.0 (94-99)
<b>DACFWB42CPTC</b>	Front Wheel Bearing	Chrysler PT Cruiser 1.6, 2.0, 2.4, 2.4GT, 2.2CRD (08-10)
<b>DACFWBBOX1</b>	Rear Wheel Bearing Inner	Peugeot Boxer - All Models With 1 Ton - 1.8 Ton Mass (06-09)
<b>DACFWBBOX2</b>	Rear Wheel Bearing Inner	Peugeot Boxer - All Models With 1.8 Ton - 2.0 Ton Mass (06-09)
<b>DACFWBDTE</b>	Front Wheel Bearing Inner	Daihatsu Terios 1.3 SUV (01-06)
<b>DACFWBFF3</b>	Front Wheel Bearing	Ford Focus III 1.6i PNDA, 1.8 Si, Ambiente, Trend., 2.0 Gdi MGDA, 2.0 TDCi G6DA, BYD, 2.0 Gtdi ST1 & ST2 R9DA (09-15), Kuga 1.5 EcoBoost, 1.6 EcoBoost JQMA, JQMB, 1.6 EcoBoost Turbo JTMA, 2.0 EcoBoost, 2.0 TDCi, 2.0 TDCi TXDA, TXMA, 2.5 Turbo - 4X2, 4X4 (2011-), Tourneo / Transit Connect/Grand Connect 1.0 Eco-Boost Trend MPV SWB B3GA, 1.5 TDCi Ambiente Dsl P-Van LWB XWGA, 1.6 TDCi EcoBoost LWB T1GA (2013-)
<b>DACFWBHA</b>	Front Wheel Bearing Inner	Honda Accord VII Series 2.0i V-Tec, 2.4i V-Tec (03-08), Civic VIII Series 2.0i V-Tec Type R (07-13)
<b>DACFWBHC1</b>	Front Wheel Bearing Inner	Honda Civic 1.8i (2006-)
<b>DACFWBHC2</b>	Front Wheel Bearing Inner	Honda Civic 2.2CDTi (2006-)
<b>DACFWBHCRV</b>	Front Wheel Bearing Inner	Honda CR-V 2.0, 2.2CDTi, 2.4i (02-10)
<b>DACFWBHCR-VASB</b>	Front Wheel Bearing Inner (with integrated sensor ring)	Honda Civic VIII 2.2CTDi Vxi (07-13), CR-V 2.0 K2OA4 - 4X4 (09-12), FR-V 1.8i R18A1 (07-10)
<b>DACFWBHYELJ4</b>	Front Wheel Bearing Inner	Hyundai Elantra J3 2.0 (01-06 ), Elantra J4 1.6, 2.0 (2006-), Matrix 1.6, 1.8 (02-07), Kia Cerato 1.6, 2.0 (03-08)
<b>DACFWBHYi30</b>	Front Wheel Bearing	Hyundai i30 1.6, 1.8, 2.0 (10-12)
<b>DACFWBHYTUC1</b>	USE - DACHYTUC1	
<b>DACFWBKBC</b>	Front Wheel Bearing Inner	Kia Carens 2.0i (2008-)
<b>DACFWBMITLAN</b>	Front Wheel Bearing Inner	Mitsubishi Lancer 1.5 GLX, 1.6 GLX, 2.0 GLS, Outlander 2.4 GLS (03-08)
<b>DACFWBMW245</b>	Front Wheel Bearing Inner	Mercedes-Benz W169 A-Class A180, CDi, CVT, A200, CDi, CVT, W245 B-Class B170, B180, B200CDi, Turbo (2005-)
<b>DACFWBNI</b>	Front Wheel Bearing Inner	Nissan Interstar 2.5DCi (2006-)
<b>DACFWBNM</b>	Front Wheel Bearing Inner	Mahindra Kuv 100 1.2 CRD D75 Dies, 1.2 G80 Pet. (2016-), Nissan Almera 1.5 (2013-), Micra (K12/13) 1.2 1.4, 1.5DCi (2004-), Micra (K14) 0.9T (2018-), NP200 1.5DCi, 1.6 (2008-), Opel Adam 1.0T, 1.4, T (2014-), Corsa D 1.3CDTi, 1.6 (08-15), Renault Captur 0.9 Tce H4B400 (2016-), Clio I, II 1.2, 1.4, 1.5, 1.6, 2.0, 3.0 (2004-), Clio III 1.4, 1.6 (06-10), Clio IV 0.9T, 1.2 (2013-), Kangoo 1.4, 1.5DCi, 1.6 (03-10), Logan 1.6 - With ABS (2009-), Megane II 1.4, 1.5dci, 1.6, 2.0 (2006-), Modus 1.2, 1.4, 1.6 (05-08), Sandero 1.4, 1.6 (09-15), Scenic II 1.6, 1.9dCi, 2.0 (2006-), Twingo 1.2 – With ABS (08-13)
<b>DACFWBNP</b>	Front Wheel Bearing Inner	Nissan Primastar 1.9DCi Minibus (2007-), Opel Vivaro 1.9CDTi, 2.0i P/van (06-09), Renault Trafic 1.9DCi 100 P/van (05-08)
<b>DACFWBOCD</b>	Front Wheel Bearing Inner	Fiat Punto 1.2 Dynamic 188A5000, 1.4 Multiair 16V (04-14), Grande Punto I 1.2 199A4.000, 1.4, 1.9 Multijet 939A1.000 (06-10), Grande Punto II 1.2 199A4.000, 1.4 16V, 1.4 T-Jet (08-12), Opel Adam 1.0T B10XFT, 1.4 B14XER, A14XER (2014-), Corsa D 1.4 Essentia, Enjoy, Cosmo, Sport (08-15), Corsa E 1.0 T B10XFT, F10XFT, 1.4 T B14XEL (2015-)



## BUYERS GUIDE - LOOSE BEARINGS

<b>DACFWBRL</b>	USE - 12807SP	
<b>DACFWBSJ</b>	Front Wheel Bearing Inner	Suzuki Jimny 1.3 SUV (2009-)
<b>DACFWBSS</b>	Front Wheel Bearing Inner	Suzuki Swift 1.2, 1.4, 1.5i, 1.6, I (2008-)
<b>DACFWBSSX</b>	Front Wheel Bearing Inner	Suzuki Ertiga 1.4 VVT Pet. K14B, 1.5 VVT Pet. K15B (2012-), SX4 2.0i Hatch (08-14)
<b>DACFWBSTIL1</b>	Front Wheel Bearing	Fiat Stilo 1.9, 2.4 (03-09)
<b>DACFWBSTIL2</b>	Front Wheel Bearing	Fiat Stilo 1.9, 2.4 - Alt. (03-09)
<b>DACFWBSTR</b>	Front Wheel Bearing Inner	Fiat Strada 1.2, 1.6, 1.7D P/up – Non ABS (05-10)
<b>DACHYTUC1</b>	Front Wheel Bearing Inner	Hyundai iX35 - 4X2, 4X4 (2010-), Sonata 2.7 V6 SUV (2001-), Tucson 2.0i, 2.0CRDi SUV (04-11), Kia Optima 2.4 G4KJ, Gdi (12-14), Sportage 2.0i, 2.0CRDi, 2.7 V6 SUV (2004-)
<b>DACKWID1</b>	Front Wheel Bearing Inner	Renault Kwid 1.0 B4D 404 (2015-)
<b>DACKWID2</b>	Rear Wheel Bearing Inner	Renault Kwid 1.0 B4D 404 (2015-)
<b>DACKWID3</b>	Front Wheel Bearing Inner	Renault Kwid 1.0 B4D 404 (2015-)
<b>DACKWID4</b>	Rear Wheel Bearing Inner	Renault Kwid 1.0 B4D 404 (2015-)
<b>DACMA5</b>	Front Wheel Bearing Inner	Mazda 3 2.0 (2004-), 5 2.0 MPV (2007-)
<b>DACRWB207</b>	Rear Wheel Bearing Inner	Nissan NP200 1.5DCi, 1.6i (2008-), Citroen C4 1.6, 2.0 - All With Rr. Drums (06-09), Peugeot 207 1.4 - With Rr. Drums (2006-), 307 1.6, 2.0 (06-08)
<b>DACRWB25C3</b>	Rear Wheel Bearing Inner	Citroen C3 II 1.2i VTi EB2F, 1.4i Vti, 1.6i Vti, 1.6 HDi, e-Hdi (2010-), Peugeot 208 1.0 Vti, 1.2 Vti, 1.6 VTi, Hdi, 1.6 Gti (2012-)
<b>DACRWB307</b>	Rear Wheel Bearing Inner	Citroen C4 1.6, HDi, 2.0, Peugeot 307 1.6, 2.0 (04-06)
<b>DACRWB308</b>	Rear Wheel Bearing Inner	Peugeot 308 1.6i (2008-)
<b>DACRWBISKB</b>	Rear Wheel Bearing Inner	Isuzu KB200i 2.0 LX (04-09), KB240i 2.4 LX (04-12), KB250i 2.5 LX (04-09), KB200i 2.0 LX, KB240i 2.4 LX, KB250i 2.5 LX - 4X4 (04-09), KB250Dc 2.5, KB300TDi 3.0 LX - 4X2, 4X4 (04-09), KB300TDi 3.0 D-TEQ - 4X2, 4X4 (07-11)
<b>DACRWBMITOUT</b>	Rear Wheel Bearing Inner	Mitsubishi Outlander 2.4 GLS (03-08)
<b>DACRWBNI</b>	Rear Wheel Bearing Inner	Nissan Interstar 2.5DCi (2006-), Renault Trafic 1.9DCi 100 P/van (05-08)
<b>DACRWBNP</b>	Rear Wheel Bearing Inner	Nissan Primastar 1.9DCi Minibus (2007-), Opel Vivaro 1.9CDTi, 2.0i P/van (06-09), Renault Trafic 1.9DCi 100 P/van (05-08)
<b>DACRWBPAT</b>	Rear Wheel Bearing Inner	Nissan Patrol 3.0, 4.2 (95-04)
<b>DACRWBSS</b>	Rear Wheel Bearing Inner	Suzuki Swift 1.5 (2008-)
<b>DACRWBTI</b>	Rear Wheel Bearing Inner	Tata Bolt 1.2T XMS, XT (2015-), Indica / Vista 1.4 LEi, LSi, LX, Lxi, 1.4TDi DLX, DLS, Indigo 1.4 GLS S/W, 1.4TDi DLX S/W (2005-)
<b>DACRWBXT</b>	Rear Wheel Bearing Inner	Nissan X-Trail 2.0, 2.2D, 2.5 - 4X2 (01-08)
<b>DE08A55</b>	Front Wheel Bearing Inner	Honda Ballade SO4 150i Encore, Luxline, Spreeline D15Z4, 160i Luxline, Spreeline, V-Tec D16Y9, D16Z, 180i Luxline B18B4 (96-00), Civic SO3 150i Luxline, Spreeline D15Z4, 160i Luxline, V-Tec D16Z (96-00), Civic VII 150i, 170i V-Tec (03-06), Odyssey 2.2 5 Dr. S/W, 2.3 V-Tec 5 Dr. S/W (96-02)
<b>DG409026</b>	Rear Wheel Bearing Inner	Toyota Fortuner 3.0 D-4D SUV 1KD-FTV, 4.0 V6, Epic SUV 1GR-FE Pet. - 4X2, 4X4 (06-11), Hilux "VIGO" 2.0i U16/17 S/Cab, S, SRX LWB Pet. P/up 1TR-FE Pet., 2.5TDi D-4D S/Cab, S, SRX, S/Cab, S/Cab SRX HO, Raised Body Raider, D/Cab LWB 2KD-FTV, 3.0 D-4D TDi Raider, D/C Raider, Raised Body LWB P/up 1KD-FTV Dies., 4.0i D/Cab Raider Raised Body LWB P/up GR-FE Pet. - 4X2 (05-09), 3.0 D-4D TDi D/C Raider 1KD-FTV Dies., LWB P/up, 4.0 D/Cab Raider 1GR-FE Pet. LWB P/up - 4X4 (05-09), 2.7i S/Cab Raider, D/Cab Raider, S/Cab HO Raised Body LWB P/up 2TR-FE Pet. - 4X2 (05-11), 2.5TDi D-4D S/Cab, D/Cab SRX, Legend40 2KD-FTV Dies. LWB P/up, 2.7i S/Cab SRX, Legend40 2TR-FE Pet. LWB P/up - 4X4 (05-15)
<b>DRT38FOR</b>	Rear Wheel Bearing	Subaru Forester 2.5 (2002-)
<b>DRT42FOR</b>	Front Wheel Bearing	Subaru Forester 2.5 (2002-)
<b>DRT42NV350</b>	Rear Wheel Bearing	Nissan NV350 Impendulo (2014-)
<b>DRT42REVO</b>	Rear Wheel Bearing Inner	Toyota Fortuner 2.4GD Raised Body 2GD-FTV, 2.7 VVTi Raised Body 2TR-FE, 2.8GD Raised Body 1GD-FTV - 4X2, 2.8GD DSi Raised Body 1GD-FTV, 3.0D-4D 1KD-FTV, 4.0 V6 1GR-FE - 4X4 (2015-), Hilux "REVO" 2.0 VVTi 1TR-FE, 2.4 GD-6 Raised Body 2GD-FTV, 2.7 VVTi Raised Body 2TR-FE - 4X2, 2.4 GD-6 2GD-FTV - 4X4 (2016-), 2.8 GD-6 Raised Body 1GD-FTV, 4.0 V6 Raised Body 1GR-FE - 4X2, 4X4 (2016-)

## BUYERS GUIDE - LOOSE BEARINGS

<b>DRT45T6</b>	Front / Rear Wheel Bearing Inner	Ford Ranger T6 2.2 D HP, MP - 4X2, 2.2 D HP, MP, 2.2 D MP, 3.2 D Wildtrack, 3.2 TDCi - 4X4 (2012-), KB250Dc 2.5, KB300TDi 3.0 LX (04-09), KB300TDi 3.0 D-TEQ (07-11), Mazda BT-50 2.2 MZ-CD P4-AT, 2.5 MZI L5-Y3, 3.2 MZ-CD P5-AT - 4X2 (2012-)
<b>DRT45T6-50</b>	Front Wheel Bearing	Ford Ranger T6 2.2, 3.2 (2012-)
<b>DRT51CRAFT</b>	Front Wheel Bearing	VW Crafter - 4X4 (2007-)
<b>DRT54PRADO</b>	Front Wheel Bearing	Toyota Land Cruiser Prado 90 Series - 4X4 (96-02)
<b>EE32RS</b>	Bearing (Roller Or Ball) Fg	DNO
<b>ETHM89210SAP</b>	Diff. Pinion Bearing Rear	Mitsubishi Colt LDV 2.8D, 2.8TD - 4X2, 2.4i, 2.5, 2.6, 2.8D, 3.0, 3.0i - 4X4 (94-09), Pajero 1.6, 1.8, 3.0 (90-02)
<b>FC12025</b>	Rear Wheel Bearing Inner	Chevrolet Aveo 1.5 L, LS, LT, 1.6 LS (03-13), Spark 1.0 B110S1, 1.2 B12D1 (2010-), Citroen C2 1.4 HDi, DV4TD, 1.4i VTR TU3JP, 1.6i VTS TU5JP4S (04-10), C3 1.4i HDi, DV4TED4, 1.6i Pluriel, Sensodrive, TU5JP4 (02-10), Peugeot 1007 1.6 MPV TU5JP4 (05-08), 206 1.4 X-Line, XS-Line, XS-Line HDi, Popart, Popart+ TU3JP, 1.6 XS-Line, CC, SW XS, XT, XT Premium TU5JP4, 2.0 CC, GTi, 180 EW10J4, XT HDi DW10TD (01-03), 2.0 Hdi (04-06), 306 1.6 XT S/W TU5JP 2.0 Cabrio, XSi XU10J4R/RS/, XU10J2/K (95-03), Renault Clio I, II 1.2 Authentique, Expression, Generation, Va Va Voom D4F706, 1.4 Alaise, Privilege, Expression, RT, Va Va Voom K4J7/EJ634, 1.5 DCi Expression., K9K700/-702, 1.6 Expression, Dynamique, Privilege, Sport K4M744/-745/-748 (99-04), Clio III 1.4 Expression, Extreme, 1.5 DCi Expression., K9K770, 1.6 Expression, Dynamique, Extreme K4M 748, 2.0 (06-10), Modus 1.2 Authentique D4F706, 1.4 Dynamique, Expressio K4J770, 1.6 Expression K4M761-11 (05-08), R9 1.4 GTL, TL, TSE C1/2/3J, 1.7 TXE F2/3N, R11 1.4 TS, TX, TXE C1/2/3J, 1.7 TX, TXE F2/3N (83-86)
<b>FC12025P</b>		Chevrolet Aveo 1.5 L, LS, LT, 1.6 LS (03-13), Spark 1.0 B110S1, 1.2 B12D1 (2010-), Citroen C2 1.4 HDi, DV4TD, 1.4i VTR TU3JP, 1.6i VTS TU5JP4S (04-10), C3 1.4i HDi, DV4TED4, 1.6i Pluriel, Sensodrive, TU5JP4 (02-10), Peugeot 1007 1.6 MPV TU5JP4 (05-08), 206 1.4 X-Line, XS-Line, XS-Line HDi, Popart, Popart+ TU3JP, 1.6 XS-Line, CC, SW XS, XT, XT Premium TU5JP4, 2.0 CC, GTi, 180 EW10J4, XT HDi DW10TD (01-03), 2.0 Hdi (04-06), 306 1.6 XT S/W TU5JP 2.0 Cabrio, XSi XU10J4R/RS/, XU10J2/K (95-03), Renault Clio I, II 1.2 Authentique, Expression, Generation, Va Va Voom D4F706, 1.4 Alaise, Privilege, Expression, RT, Va Va Voom K4J7/EJ634, 1.5 DCi Expression., K9K700/-702, 1.6 Expression, Dynamique, Privilege, Sport K4M744/-745/-748 (99-04), Clio III 1.4 Expression, Extreme, 1.5 DCi Expression., K9K770, 1.6 Expression, Dynamique, Extreme K4M 748, 2.0 (06-10), Modus 1.2 Authentique D4F706, 1.4 Dynamique, Expressio K4J770, 1.6 Expression K4M761-11 (05-08), R9 1.4 GTL, TL, TSE C1/2/3J, 1.7 TXE F2/3N, R11 1.4 TS, TX, TXE C1/2/3J, 1.7 TX, TXE F2/3N (83-86)
<b>FC12784P</b>	Rear Wheel Bearing Inner	Nissan Micra 1.4, 1.5dCi (04-09), NP200 1.5DCi, 1.6 (2008-), Renault Clio I/ II 1.4, 1.6, 2.0 (99-04), Megane I 1.6 (96-02), Logan 1.6 (2009-), Megane II 1.4 (2002-), Sandero 1.4, 1.6, Twingo 1.2, 1.6 (2009-)
<b>FC40725</b>	Rear Wheel Bearing	Renault Megane I 1.6 (96-02)
<b>FFSB2001</b>	Rear Wheel Bearing Inner	Ford Fiesta II 1.4i Trend Zetec, 1.6i RSi, TDCi Rocam, 2.0 ST, ST150 (04-09), Figo 1.4 Ambiente', Trend, FXJA/B, 1.4 TDCi Ambiente', F6JB/D (2010-), Ikon 1.4, Low, LX, 1.4 Tdci, 1.6i (07-11)
<b>FH438017</b>	Front Diff. Carrier Bearing Right	Toyota Fortuner 4.0 V6 - 4X4 (11-16), Hilux "Revo" 3.0D-4D, 4.0 - 4X4 (2016-)
<b>GB12004</b>	Front Wheel Bearing Inner	Renault Clio I, II 1.2 Authentique, Expression, Generation, Va Va Voom D4F706, 1.4 Alaise, Privilege, Expression, RT, Va Va Voom K4J7/EJ634, 1.5 DCi Expression., K9K700/-702, 1.6 Expression, Dynamique, Privilege, Sport K4M744/-745/-748, 2.0 Sport F4R, 3.0 V6 Sport F7R (99-04), R9 1.4 GTL, TL, TSE C1/2/3J, 1.7 TXE F2/3N, R11 1.4 TS, TX, TXE C1/2/3J, 1.7 TX, TXE F2/3N (83-86)
<b>GB12955P</b>	Front Wheel Bearing Inner	Alfa Romeo 145 2.0 (96-01), 155 2.5, 164 3.0 (96-99), GTV/ Spider 3.0 (99-04)
<b>GB40250P</b>	Front Wheel Bearing Inner	Renault Laguna 1.6, 1.8, 1.9dCi, 2.0, 3.0 (96-07), Megane 1.6, 2.0 (96-02), Megane II 1.4 (2002-), Scenic I/II 1.4, 1.6, 2.0 (1998-)
<b>GB40880</b>	Front Wheel Bearing Inner	Renault Captur 1.2 Tce H4B400, 1.5 Dci K9K (2016-), Clio III 1.5DCi, 2.0 (2006-), Grand Scenic 1.9dCi (05-09), Megane II 1.9dCi, 2.0T, Scenic II 1.9dCi (2002-), Twingo 1.6 (2009-)
<b>HM89410NP</b>	Diff. Pinion Bearing Rear	Mitsubishi Colt LDV 1.6, 2.0, 2.5, 2.5d, 2.6 - 4X2, 2.4i, 2.8D, 3.0i - 4X4 (94-09)

## BUYERS GUIDE - LOOSE BEARINGS

<b>HUB002</b>	Rear Wheel Hub Bearing	Honda Ballade SC9 "Flip up Lights" 130 EV2, 150, i EW, 160i DOHC ZC1 (84-89)
<b>HUB005-39</b>	Rear Wheel Hub Bearing	Honda Ballade SH4 150 16V SOHC D15B3, 160i 16V SOHC, DOHC D16A9 (89-92), SR4 150 Encore, Luxline, Spreeline D15B3, 160E, i D16A7, 180E, i B18B3 (92-98), SO4 150i Encore, Luxline, Spreeline D15Z4, 160i Luxline, Spreeline, V-Tec D16Y9, D16Z, 180i Luxline B18B4 (96-00), Civic SO3 150i Luxline, Spreeline D15Z4, 160i Luxline, V-Tec D16Z (96-00)
<b>HUB006</b>	Rear Wheel Hub	Honda Ballade 130, 150, 160 (84-89)
<b>HUB010</b>	Rear Wheel Hub	Toyota Rav4 2.0 - 4X4 (94-02)
<b>HUB012</b>	Rear Wheel Hub Bearing	Toyota Conquest / Tazz EE80 1.3 GL, GS, L, S 2EL (85-93), EE90R 130 Sport, Tazz, Edition, Zipp, Tropique (93-01), Tazz EE90R 130 Edition, Ruby, Tropique, Sport, McTazz, XE 2E (01-06), AE82R 1.6 GL, RS, RSi 4A-L, A-GEL (85-88), AE92R 160i LS, RS, RSi, Sport, RSE, Tazz 4A-F, A-FE, A-GE (88-01), AE92R 160i Edition, Sport, Tazz, XE 4AFE (01-06), Conquest EE90 130 Carri P/van, 2E (98-06), Corolla FWD AE/EE80R 1.3 GL, L, 2A-L, E-L (84-88), EE90R 1.3 GL, GLE, L, Sprinter 2E-L, E EE110R, 130 GLE, Sprinter 2E (91-02), AE92R 1.6, 160 GL, GLE, GLI, Exec., GLS, Exec., GLX, Sport Sprinter 4A-F, A-FE, A-GE (91-96), AE93R 180i GL, GLE, GSE, GSX, Sprinter 7A-FE (93-96), AE111R 160i GL, GLE, RSi, RXi 4A-FE, A-GE, AE112 180i GLE, GSE 7A-FE (96-02)
<b>HUB013</b>	Use - HUB014	
<b>HUB014</b>	Rear Wheel Hub	Toyota Conquest 1.8i (93-96), Corolla 1.6i, 1.8i (96-02), Corolla 1.8i (93-96)
<b>HUB014</b>	Rear Wheel Hub Bearing	Toyota Conquest AE93 180i RS, RSi, Sport 7A-FE (93-96), Corolla FWD AE93R 180i GL, GLE, GSE, GSX, Sprinter 7A-FE (93-96), AE111R 160i GL, GLE, RSi, RXi 4A-FE, A-GE, AE112 180i GLE, GSE 7A-FE (96-02)
<b>HUB015</b>	Rear Wheel Hub	Ford Mondeo 1.8i Lx, Tdi, 2.0i, 2.5i – Non ABS (97-01)
<b>HUB016</b>	Rear Wheel Hub	Ford Mondeo 1.8i Lx, Tdi, 2.0i, 2.5i – ABS (97-01)
<b>HUB017</b>	Rear Wheel Hub	Toyota Camry 3.0 (92-01)
<b>HUB018</b>	Rear Wheel Hub	Hyundai Sonata 2.0, 2.5, 3.0 (94-02)
<b>HUB019</b>	Rear Wheel Hub Bearing	Alfa Romeo R145 2.0 Quadrofoglio AR32301 (96-01), R146 2.0 Ti Twin Spark AR67204 (96-99), Mito 1.4 TB (2009-), Fiat 500 1.2 169A4.000, 1.4 16V 169A3.000 (08-15), Multipla 1.6 Active, 1.6 SX, 1.9 JTD ELX MPV 182A4.000 (03-10), Palio I 1.2 ED, EL, Go!, Paint Ltd. M657BA.12T 178B5.000, 1.6 EL, ELX, HL, Weekend S/W, 178B3.000 (00-05), Palio II 1.2 Espresso 178B6.000, 1.2 Go!, 178B5.000, 1.6 178B3.000, 1.7TD, EL. (05-10), Panda 1.1 Active, 187A1.000, 1.2 Dynamic 169A4.000, 188A4.000, 1.4 100HP 169A3.000 (2006-), Punto 1.2 Dynamic 188A5000, 1.3D 2U 188 JTD Dynamic, JTD Multijet 188A9.000, 1.4 Multiair, 1.8 HGT 188A1.000, 188A6.000 (04-13), Stilo 1.6 Active, MultiWagon, 182B6, 1.9 JTD Dynamic, MultiWagon JTD Dynamic 192A1.000, 937A7.000 (03-06)
<b>HUB020</b>	Rear Wheel Hub	Fiat Multipla 1.6 Active, 1.6 SX, 1.9 JTD ELX MPV 182A4.000 (03-10), Palio 1.2, 1.6 (00-05), Panda 1.1, 1.2, 1.3, 1.4 ( 2006-), Punto 1.2, 1.3, 1.4, 1.8 (04-13), Siena I/II 1.2, 1.6, 1.7TD (00-10), Strada 1.2, 1.4, 1.6, 1.7D – Non ABS (05-10)
<b>HUB021</b>	Rear Wheel Hub	Alfa Romeo 146, 155 (96-99), Fiat Palio II - All (05-10), Siena I/II 1.2, 1.6, 1.7TD – With ABS (00-10)
<b>HUB022</b>	Rear Wheel Hub	Alfa Romeo 155 2.0, 2.5 (96-99)
<b>HUB025</b>	Front Wheel Hub	Opel Astra 1.6, 1.8 (99-06), Zafira 1.8i – Non ABS (01-05)
<b>HUB026</b>	Rear Wheel Hub Bearing Non ABS	Chevrolet Utility 1.3D, 1.4 Pet., 1.8 Pet. (11-15), Opel Astra G 1.6 CS, Classic CD, CDE, Comfort C16SEL, 1.8 Classic CDE, Caravan CD S/W, Elegance, Irmscher X18XE1 (99-06), Corsa C 140i Classic, Comfort, Chill, Classic Essentia, Hatch Club, Sport, Lite Sport, S14NE, 160i Classic, Classic Elegance, Classic CD, CDE, Sport, 16SE, 1.7TDi Sport, Classic, CDTi Enjoy, Hatch CDTi Elegance, Classic DTi Elegance X17D, 1.8i GSi Hatch, Classic (03-08), Corsa LDV II 1.4i Utility, Club Sport, S P/up 14XE, 1.7TDi Utility Club, Sport P/up, 1.8i Utility Club, Sport P/up (03-10), Corsa P/van 1.4i Combo P/van (2006-), Opel Meriva 1.4 Essentia, Enjoy, 1.6 Club, Comfort, Enjoy MPV Z16SE/-XE (03-09), Zafira I 1.8i CD, Enjoy, Elegance MPV Z18XE/-1 (01-05)
<b>HUB027</b>	Front Wheel Hub Bearing	Opel Astra G 1.6 CS, Classic CD, CDE, Comfort C16SEL, 1.8 Classic CDE, Caravan CD S/W, Elegance, Irmscher X18XE1, 2.0 Coupe', CSX X20XEV, 2.2i Classic Exec. (99-06), Zafira I 1.8i CD, Enjoy, Elegance MPV Z18XE/-1 (01-05)
<b>HUB028</b>	Rear Wheel Hub	Opel Astra 2.0, 2.2i (99-05), Meriva 1.7CDTi, 1.8 – ABS (03-09)
<b>HUB029</b>	Front Wheel Hub Bearing	Volvo 850 2.3 T-5S, R Sedan B5234 T2/ T4, 2.4 GLT Sedan B5254S (94-97)
<b>HUB030</b>	Rear Wheel Hub	Volvo 850 2.3, 2.4 - ABS (94-97)
<b>HUB031</b>	Front Wheel Hub	Volvo 960 2.9 (94-97), S90 2.9, V90 2.9 – ABS (97-00)

## BUYERS GUIDE - LOOSE BEARINGS

<b>HUB032</b>	Front Wheel Hub	Volvo 960 2.9 - ABS (94-97)
<b>HUB033</b>	Rear Wheel Hub	Volvo S40 1.9, 2.0T, V40 1.9, 2.0T (97-04)
<b>HUB034</b>	Front Wheel Hub	Volvo S70 2.3, 2.4 (97-98)
<b>HUB035</b>	Front Wheel Hub	Volvo C70 2.3 (02-04), S70 2.3, 2.4, V70 2.3, 2.4, T, 2.5T (97-04), V70 2.4 - 4X4, XC70 2.5T, XC90 2.9 (00-06)
<b>HUB036</b>	Front Wheel Hub	Volvo 960 2.9 (94-97)
<b>HUB037</b>	Rear Wheel Hub	Alfa Romeo GTV 2.0, 3.0 V6 Spider, 3.0 V6 (96-06)
<b>HUB038</b>	Rear Wheel Hub	Alfa Romeo 147 2.0 – Non ABS (96-06)
<b>HUB039</b>	Rear Wheel Hub	Alfa Romeo 147 2.0 (96-06), 164 3.0 – ABS (96-99)
<b>HUB040</b>	Rear Wheel Hub	BMW523i, 525i, 528i, 530i,d, 540i ( 98-04), 520d, 523i, 525i, 530i, d (04-10), M5 (99-03)
<b>HUB041</b>	Rear Wheel Hub	Renault Espace 2.0 (99-04), Grand Espace 2.0, 3.0 (99-06), Megane I 2.0 (96-02), Scenic I/II 1.4, 1.6, 2.0 (98-04)
<b>HUB042</b>	Rear Wheel Hub	Fiat Ulysse 2.0 – Non ABS (99-02)
<b>HUB043</b>	Rear Wheel Hub	Fiat Ulysse 2.0 – ABS (99-02)
<b>HUB044</b>	Rear Wheel Hub	Alfa Romeo 147 1.6, 1.9, 2.0, 156 2.0, 2.5 (99-06)
<b>HUB045</b>	Front Wheel Hub	Opel Astra G 2.0, 2.2i (99-05)
<b>HUB046</b>	Rear Wheel Hub	Opel Astra G 2.0, 2.2i (99-05)
<b>HUB047</b>	Rear Wheel Hub	Daewoo Tacuma 1.6, 2.0 – ABS (01-03)
<b>HUB048</b>	Rear Wheel Hub	Alfa Romeo 166 3.0 (99-03)
<b>HUB049</b>	Rear Wheel Hub	Renault Megane I 1.6, 2.0 (96-02), Scenic I, II 1.4, 1.6, 2.0 – ABS (98-04)
<b>HUB050</b>	Rear Wheel Hub	Renault Espace 2.0 (99-04), Grand Espace 2.0, 3.0 – ABS (00-06)
<b>HUB051</b>	Rear Wheel Hub	Renault Laguna I 1.6, 1.8, 1.9dCi, 2.0, 3.0 – ABS (96-07)
<b>HUB053-41</b>	Rear Wheel Hub	Kia Clarus 2.0 (98-01), Mazda 626 2.0 (99-03), Astina 1.8 (95-00), Etude 1.6, 1.8 – ABS (95-04)
<b>HUB054</b>	Rear Wheel Hub	Citroen Berlingo 1.4 (03-15), Peugeot 1.9D – Non ABS (2003-)
<b>HUB055</b>	Rear Wheel Hub	Citroen Berlingo 1.9D (03-15), Picasso 1.6 (03-06), Xsara 1.8 – ABS (03-08)
<b>HUB056</b>	Front Wheel Hub	Renault Espace 2.0 (99-04), Grand Espace 2.0, 3.0 – Non ABS (00-06)
<b>HUB057</b>	Front Wheel Hub	Renault Espace 2.0 (99-02)
<b>HUB058</b>	Rear Wheel Hub	Peugeot 206 2.0 – ABS (01-03)
<b>HUB059</b>	Rear Wheel Hub	Citroen Xsara 1.6 (03-08), Peugeot 306 1.6, 2.0 – ABS (95-03)
<b>HUB060</b>	Rear Wheel Hub	Citroen C4 1.6, HDi, 2.0 (01-04), Peugeot 207 1.4, 1.6 - With Rr. Discs (2006-), 307 1.6, 2.0 (01-04)
<b>HUB061</b>	Front, Rear Wheel Hub	Alfa Romeo 147 2.0 (01-10), 156 2.5 V6 – ABS (98-07)
<b>HUB066-39</b>	Rear Wheel Hub	Ford Telstar 2.0, Mazda 626 2.0i, 2.5i – Non ABS (93-98)
<b>HUB066-40</b>	Rear Wheel Hub	Ford Telstar 2.5i (93-98), Mazda 626 2.0i, 2.5i – ABS (93-03)
<b>HUB068</b>	Front Wheel Hub	BMW 523i, 525i, 528i, 530i, d, 530i, 540i (98-04), M5 V8 – ABS (99-03)
<b>HUB069</b>	Front Wheel Hub	Opel Omega 2.2i, 2.6i (02-04)
<b>HUB070</b>	Rear Wheel Hub	Fiat Seicento 1.1 – Non ABS (01-03)
<b>HUB071</b>	Front Wheel Hub	BMW 330Ci, 330d (98-04), M3 coupe – ABS (01-04)
<b>HUB072</b>	Rear Wheel Hub	Citroen C5 2.0, 3.0 (01-05)
<b>HUB073</b>	Rear Wheel Hub	Volvo C70 2.5T (04-08), S60 2.0T, 2.3, 2.4, T, 2.5T (01-08), S80 2.4T, 2.5T, 2.9 (02-06), V70 2.0T, 2.5T (04-08), S60 2.5R - 4x4 (03-06)
<b>HUB074</b>	Front Wheel Hub	Audi A8 4.2 Quattro (95-02), S4 4.2 Quattro (03-05)
<b>HUB075</b>	Front Wheel Hub	Volvo C70 2.5T (04-08), S60 2.0T, 2.3, 2.4, T, 2.5T (01-08), S80 2.4T, 2.5T, 2.9 (02-06), V70 2.0T, 2.5T (04-08), S60 2.5R - 4X4 (03-06), V70 2.5T - 4X4 (04-08), XC70 2.5T - 4X4, XC90 2.4, 2.5T 4X4 (04-08)
<b>HUB076</b>	Rear Wheel Hub	Kia Sephia 1.5 (04-05), Shuma 1.5i, 1.8i (98-01), Spectra 1.6 (01-03)



## BUYERS GUIDE - LOOSE BEARINGS

<b>HUB077</b>	Rear Wheel Hub	Kia Sephia 1.5 (04-05), Shuma 1.5i, 1.8i (98-01), Spectra 1.6 (01-03)
<b>HUB078</b>	Rear Wheel Hub	Audi A6 2.7T (00-05)
<b>HUB079</b>	Rear Wheel Hub Bearing	Hyundai Accent LC 1.3 G4EH, 1.5 G4EK, 1.6 G4ED (00-06), Atos 1.0 Prime G4HC (00-05), 1.1 G4HG (2005-)
<b>HUB080</b>	Rear Wheel Hub Bearing	Nissan Sabre 160 GX, GXi GA16DS (94-02), Sentra 140, i, GX, GXi, Si GA14DNE / DS, 160 GSi, GX, GXi, SE, Si GA16DE/DNE/ DS, 200 GSi, STi SR20DE (92-02)
<b>HUB081</b>	Rear Wheel Hub	Nissan Sabre 2.0 (94-02), Sentra 2.0 – ABS (92-02)
<b>HUB082</b>	Rear Wheel Hub Bearing	Honda Prelude 2.2 V-Tec, Si F22, A22 (91-98)
<b>HUB083</b>	Rear Wheel Hub	Nissan Primera 2.0 – ABS (98-02)
<b>HUB084</b>	Front Wheel Hub	Chrysler Voyager 2.0, 2.4, 2.5 (97-04), Grand Voyager 2.5, 3.3 – Non ABS - 15" Rims Only (97-04)
<b>HUB085</b>	Rear Wheel Hub Bearing	Nissan Maxima GV Series 300SE VG30E (91-97)
<b>HUB086</b>	Rear Wheel Hub Bearing	Nissan Maxima CA33 & QX Series 2.0 VQ20E, 3.0 VQ30DE (96-04)
<b>HUB087</b>	Rear Wheel Hub	Nissan Primera 1.6 (98-02)
<b>HUB088</b>	USE - HUB089	
<b>HUB089</b>	Rear Wheel Hub	Toyota Rav4 II 2.0 - ABS - 4X4 (02-06)
<b>HUB090</b>	Rear Wheel Hub Bearing	Toyota Corolla FWD F11 140i GLE, GLS, Sprinter 4ZZ-FE, KS1 160i GLE, GLS, GSX, Sprinter VVT-i 3ZZ-FE DOHC, GF2 180i GLE, GLS, GSX, Sprinter VVT-I 1ZZ-FE DOHC (02-08), Runx 140i RT, RS, Sport 4ZZ-FE, 160i RS, RT, RX, Sport 3ZZ-FE, 180i RSi, RX 1ZZ-FE (03-08)
<b>HUB091</b>	Rear Wheel Hub Bearing	Kia Shuma I 1.5i LS 4 Dr. Sedan BFD, 1.8i GS 5 Dr. H/back TBD (98-01), Spectra 1.6 Exec. A6 (01-03)
<b>HUB092</b>	Rear Wheel Hub Bearing	Kia Carens 1.8 LS 5 Dr. MPV TBD In-Line (00-03)
<b>HUB093</b>	Rear Wheel Hub	Kia Carnival 2.5, 2.9 (00-04)
<b>HUB094</b>	Rear Wheel Hub	Toyota Camry 2.0i (01-06)
<b>HUB095</b>	Rear Wheel Hub Bearing	Audi A3 1.8 8L1 AGN, 1.8T AGU, BPU (98-04), A4 1.8T Avant, Multitronic, BFB, B6 AVJ 8E2, 1.9 TDi AVF, Avant B6, 8E5, 8E2 (00-08), TT 1.8T Coupe, Sport, Roadster, Coupe 8N3/9 APX, 1.8T Quattro APX, BAM, BFV (00-07), VW Beetle 1.8T Coupe APH, 2.0i Cabriolet, Highline AZJ (00-12), Golf IV 1.6i Comfortline, Std., Estate AKL, 1.8, T GTi, Highline AGU/ AGN, 1.9 TDi Highline, Estate AHF, 2.0i Cabrio, Highline APK (99-04), Jetta IV 1.6i Comfortline, Std. AKL, 1.8T Highline, Exec AGU, 1.9 TDi Highline AHF, 2.0i Highline APK, 2.3 V5 AGZ (99-06), Polo 1.2 Trendline DSG Petrol CBZB, 1.2 Man. CGPA/ CGPB (10-15), 1.2TSi Comfortline Man. CBZC (2013-), Polo GP 1.0TSi Comfortline CHZC TSi R Line DSG CHZC (2016-)
<b>HUB096</b>	Rear Wheel Hub	Opel Astra G 1.6, 1.8 (99-06), Meriva 1.4, 1.6 (03-09), Zafira I 1.8i (01-05)
<b>HUB097</b>	Rear Wheel Hub Bearing Non ABS	Nissan Almera 1.5 HR15DE (2013-), 1.6 Comfort, Elegance, Luxury 16DE/GA16DE, 1.8 Elegance, Luxury 18DE (01-06)
<b>HUB098</b>	Rear Wheel Hub Bearing ABS	Nissan Almera 1.5 HR15DE (2013-), 1.6 Comfort, Elegance, Luxury 16DE/GA16DE, 1.8 Elegance, Luxury 18DE (01-06)
<b>HUB099</b>	Front Wheel Hub Bearing	Toyota Quantum 2.5 D-4D, "Family", S-long MPV, Van 2KD-FTV Dies., 2.7 "Family", S-long "Ses'fikile" MPV, Van 2TR-FE Pet. (2005-)
<b>HUB100</b>	Rear Wheel Hub Bearing	Audi A3 2.0 FSi BVZ, 2.0 FSi 8PA Sportback BLX, 2.0 TFSi CCZA, CBFA, 2.0 TDi BMM, CLJA (03-13), 1.4 TFSi CMSA, 1.6 TDi CAYC, 1.8 TFSi CDAA, 1.9 TDi BXE (08-13), 1.2 TFSi CJZJ, CJZA, 1.4 TFSi CXSA, 1.6 TDi CLHA, 1.8 TFSi Quattro CJSa, CJSB, 2.0 TDi DBGA (12-17), A4 2.0 Multitronic Avant 8EC, 8E2 ALT, 2.0 TDi 125, 8EC BLB, Avant Multitronic, 2.0TFSi DTM 147 BGB (00-08), TT 2.0 TFSi BWA, 2.0 TTS Quattro CDLA, CDMA (06-10), Seat Altea 2.0FSi Tiptronic, 2.0TDi Man., DSG Auto. (06-09), VW Beetle 1.2 Tsi, 1.4 Tsi (2012-), Caddy 1.6i Life Van, MPV BGU, 1.9TDi Life, Maxi Van, MPV BJB, 2.0SDi Van, P/van BDJ, 2.0TDi (2004-), Golf V 1.6i Comfortline, Tiptronic, Trendline BGU, 1.9TDi Comfortline, Highline, 2.0i Comfortline, GTi, GTi Trendline DSG/ AXX/BWA, 2.0FSi Sport, Sport Tiptronic AXW, 2.0TDi, Sport DSG/ BKD (04-09), Golf VI 1.4TSi Comfortline, Trendline, Highline, 1.6i Comfortline, Trendline, 1.6TDi, 2.0i GTi, Tiptronic, 2.0TSi 4Motion, 2.0TDi Highline, DSG (09-13), Golf VII 1.2TSi, 1.4TSi, 2.0 GTi, 2.0TDi (2013-), Jetta V 1.4TSi, 1.6TDi (09-11), 1.6i Comfortline, Tiptronic, Trendline, 1.9TDi Comfortline, Comfortline DSG, 2.0i Trendline, Comfortline, 2.0FSi Sportline, 2.0 T FSi Sportline DSG, 2.0TDi Sportline (2006-), Jetta VI 1.2TSi, 1.4TSi, 1.6TDi, 2.0TDi (2011-), Scirocco 1.4TSi, 2.0TSi, DSG, 2.0TSi R (2009-), Tiguan 1.4TSi Trend&Fun 5Dr. SUV, 2.0TSi, 2.0TDi - 4X2 (08-17)

## BUYERS GUIDE - LOOSE BEARINGS

<b>HUB101</b>	Rear Wheel Hub Bearing Non ABS	Toyota Corolla FWD F11 140i GLE, GLS, Sprinter 4ZZ-FE, KS1 160i GLE, GLS, GSX, Sprinter VVT-i 3ZZ-FE DOHC (02-08), Runx 140i RT, RS, Sport 4ZZ-FE, 160i RS, RT, RX, Sport 3ZZ-FE, 180i RSi, RX 1ZZ-FE (03-08)
<b>HUB102</b>	Rear Wheel Hub Bearing Non ABS	Audi A3 1.8 8L1 AGN, 1.8T AGU, BPU (98-04), A4 1.8T Avant, Multitronic, BFB, B6 AVJ 8E2, 1.9 TDi AVF, Avant B6, 8E5, 8E2 (00-08), VW Beetle 1.8T Coupe APH, 2.0i Cabriolet, Highline AZJ (00-12), Golf IV 1.6i Comfortline, Std., Estate AKL, 1.8, T GTI, Highline AGU/ AGN, 1.9 TDi Highline, Estate AHF, 2.0i Cabrio, Highline APK (99-04), Jetta IV 1.6i Comfortline, Std. AKL, 1.8T Highline, Exec AGU, 1.9 TDi Highline AHF, 2.0i Highline APK, 2.3 V5 AGZ (99-06), Polo 9N 1.9TDi Highline, Classic Highline, Sportline, ATD/ AXR, 2.0i Highline, Classic Highline BBX (02-10), Cross Polo 1.6TDi, 1.9TDi (07-10)
<b>HUB103</b>	Front Wheel Hub	Audi A1 1.0 TFSi, 1.2 TFSi, 1.4 TFSi, 1.6 TDi, 1.8 TFSi (11-18), Seat Ibiza 1.4, 1.6, 1.8T, 1.9TDi, 2.0, Leon 2.0FSi, T, T FSI, TDi (06-08), VW Polo 1.4TDi, 1.4i, 1.5TDi, 1.6i, 1.8T, 1.8i, 1.9TDi, 2.0i (2002-)
<b>HUB104</b>	Rear Wheel Hub Bearing	Hyundai Accent MC 1.6 G4ED (06-11), Getz 1.3 G4EA, 1.4i G4EE, 1.5 D3EA, D4FA, 1.6 G4ED-G (03-12), i10 PA 1.1 G4HG, 1.2 G4LA (08-15), Grand i10 1.1 G3LA (2017-), 1.2 G4LA (2014-), Kia Picanto 1.1 LX, EX 5 Dr. H/back G4HG (04-11)
<b>HUB105</b>	Rear Wheel Hub Bearing	Daihatsu Sirion 1.3, 1.5 (00-14)
<b>HUB106</b>	Rear Wheel Hub	Audi A1 1.0 TFSi, 1.2 TFSi, 1.4 TFSi, 1.6 TDi, 1.8 TFSi (11-18), Seat Ibiza 1.4, 1.6, 1.8T, 1.9TDi, 2.0, Leon 2.0FSi, T, T FSI, TDi (06-08), VW Polo 1.4TDi, 1.4i, 1.6i, 1.8T, 1.8i, 1.9TDi, 2.0i (02-10)
<b>HUB107</b>	Rear Wheel Hub	Toyota Yaris 1.0, 1.3, 1.8 (2006-)
<b>HUB108</b>	Front, Rear Wheel Hub	Audi A1 1.0 TFSi, 1.2 TFSi, 1.4 TFSi, 1.6 TDi, 1.8 TFSi (11-18), A3 2.0 FSi, TDi, T FSi, 3.2 (2003-), A4 2.0, TDi, T FSi, 3.2, FSi (2005-), S3 2.0TFSi (07-13), TT 2.0T FSi, 3.2 (2006-), Seat Altea 2.0FSi, TDi (06-08), VW Caddy 1.6i, 1.9TDi (2005-), Golf V 1.6i, 1.9TDi, 2.0, FSi, TDi (04-09), Golf VI 1.4TSI, 1.6i, 2.0GTi, 2.0TDi – Some Models (2009-), Jetta V 1.6i, 1.9TDi, 2.0, FSi, T FSi, TDi (2006-), Touran 1.9TDi, 2.0FSi, TDi (2004-), Caddy 1.6i, 1.9TDi, 2.0SDi Van (2005-), Tiguan 1.4TSI, 2.0TSI, 2.0TDi - 4X4 (2008-)
<b>HUB109</b>	Rear Wheel Hub	Audi A3 (03-13), A3 1.4 T FSi, 2.0TDi (13-17), A4 3.2, FSi (2001-), TT 3.2 (04-06), VW Caddy 1.6i, 1.9TDi, 2.0SDi Van (2005-), Golf VI 1.4TSI, 1.6i, 2.0GTi, 2.0TDi – Some Models, Scirocco 1.4TSI, 2.0TSI - Some Models (2009-), Tiguan 1.4TSI, 2.0TSI, 2.0TDi - Some Models - 4X2 (2008-), Touran 1.9TDi, 2.0FSi, TDi (2004-)
<b>HUB110</b>	Front Wheel Hub	Audi A4 2.0T FSi Quattro, 2.4, 3.0, Tdi (2005-), 8 3.2FSi (01-0), VW Passat 1.9TDi, 2.0FSi, T FSI, TDi, 2.3 (03-07)
<b>HUB111</b>	Rear Wheel Hub	Audi A4 2.4, 3.0 (01-05), VW Passat 1.9TDi , 2.0FSi, T FSI, TDi, 2.3 (03-07)
<b>HUB112</b>	Rear Wheel Hub	Audi A4 2.0T FSi Quattro, 3.0TDi (2005-), VW Passat 3.2 V6 (05-07)
<b>HUB113</b>	Rear Wheel Hub	VW Caddy 1.6i (96-03)
<b>HUB114</b>	Front, Rear Wheel Hub	VW Kombi 1.9TDi, 2.5TDi, 3.2 Caravelle, P/up, Touareg 2.5TDi, 5.0TDi (2004-)
<b>HUB115</b>	Use - HUB114	
<b>HUB116</b>	Rear Wheel Hub	VW Kombi 1.9TDi, 2.5TDi, 3.2 Caravelle, P/up (2004-)
<b>HUB117</b>	Front, Rear Wheel Hub	VW Touareg 2.5TDi, 3.0TDi, 3.6 FSi, 4.2 FSi, 5.0TDi (2004-)
<b>HUB118</b>	Front Wheel Hub	Ford Focus 1.6, 1.8, 2.0, TDCi, 2.5 – Some Models (2005-), Volvo C30 1.6, 1.8, 2.0, 2.5 T5 (2008-), S40 1.8, 2.0, 2.0D, 2.4i, 2.5i, V50 2.0D, 2.0i, 2.4i, 2.5i (04-09)
<b>HUB119</b>	USE - HUB118	
<b>HUB120</b>	Rear Wheel Hub	Ford Focus II 1.6, 1.8, 2.0, TDCi, 2.5 ST (05-09), Volvo C30 1.6, 1.8, 2.0, 2.5 i, T5 (2008-), C70 2.5T (04-13), S40 1.8, 2.0, D, 2.4i, 2.5i (2004-), V50 2.0D, i, 2.4i, 2.5i (04-09)
<b>HUB121</b>	Rear Wheel Hub	Volvo V70 2.5T R (2005-), XC70 2.5T (2003-), XC90 2.4, 2.5T (2004-), CX90 2.4, 2.5, 2.9 T6, 3.2, 4.4 V8 - 4X4 (03-14)
<b>HUB122</b>	Rear Wheel Hub	Citroen C2 1.4, 1.6i, C3 1.4i, 1.6i (2003-), Peugeot 1007 1.6 (05-08), 206 1.4, 1.6, 2.0 (03-06)
<b>HUB123</b>	Front Wheel Hub	Opel Astra 1.4,1.6, 1.8, 1.9CDTi, 2.0 (2004-), Zafira 1.6, 1.8i, 1.9CDTi, 2.0, 2.2i – 4 Hole Hub (2005-)
<b>HUB124</b>	Front Wheel Hub	Opel Astra 1.4, 1.6, 1.8, 1.9 CDTi, 2.0 (04-10), Zafira II 1.6, 1.8i, 1.9CDTi, 2.0i, 2.2i – 5 Hole Hub (05-09)
<b>HUB125</b>	Rear Wheel Hub	Chevrolet Utility 1.3D, 1.4, 1.8 (11-15), Opel Astra 1.4,1.6, 1.8, 1.9CDTi, 2.0 (04-10), Zafira II 1.6, 1.8i, 1.9CDTi, 2.0i, 2.2i – 4 Hole Hub (05-09)
<b>HUB126</b>	Rear Wheel Hub	Opel Astra H 1.4,1.6, 1.8, 1.9CDTi, 2.0 (04-10), Meriva 1.4T (2012-), Zafira II 1.6, 1.8i 1.9CDTi, 2.0i, 2.2i – 5 Hole Hub (05-09)



## BUYERS GUIDE - LOOSE BEARINGS

<b>HUB127</b>	Front Wheel Hub	BMW 116i, 118i, 120d,i, 130i, 320d, i, 323i, 325i, 330Ci, d, 335i, d (04-15), X1 1.8, 2.0i, d, 2.3d, 2.5d, 2.8i (09-15)
<b>HUB128</b>	Front Wheel Hub	BMW Mini R50, R52, R56 1.6 (-2006), R53 1.6 (02-09)
<b>HUB129</b>	Rear Wheel Hub	BMW Mini R50, R52, R53, R56 1.6 (02-09)
<b>HUB130</b>	Front Wheel Hub Bearing	Chana Star 1.0 P/up, 1.3 P/up (06-12), Gran Max 1.5 I 3SZ-VE (2009-)
<b>HUB131</b>	Front Wheel Hub Bearing	Toyota Fortuner 3.0 D-4D SUV 1KD-FTV, 4.0 V6, Epic SUV 1GR-FE Pet. - 4X2, 4X4 (06-11), 2.5D-4D 2KD-FTV, 3.0D-4D 1KD-FTV, 4.0 V6 1GR-FE, 4.0 V6 Raised Body 1GR-FE - 4X2, 4X4 (11-16), Hilux "VIGO" 2.5TDi D-4D S/Cab, S, SRX, S/Cab, S/ Cab SRX HO, Raised Body Raider, D/Cab LWB 2KD-FTV, 3.0 D-4D TDi Raider, D/C Raider, Raised Body LWB P/up 1KD-FTV Dies., 4.0i D/Cab Raider Raised Body LWB P/up GR-FE Pet. - 4X2, 3.0 D-4D TDi D/C Raider 1KD-FTV Dies., LWB P/up, 4.0 D/ Cab Raider 1GR-FE Pet. LWB P/up - 4X4 (05-09), 2.7i S/Cab Raider, D/Cab Raider, S/Cab HO Raised Body LWB P/up 2TR-FE Pet. - 4X4 (05-11), 2.5TDi D-4D S/Cab, D/ Cab SRX, Legend40 2KD-FTV Dies. LWB P/up, 2.7i S/Cab SRX, Legend40 2TR-FE Pet. LWB P/up - 4X4 (05-15), 3.0D-4D TDi D/C xtra cab, Raider, Legend40 1KD-FTV Dies. LWB, 4.0 D/Cab Raider, 1GR-FE Pet. - 4X4 (2009-), 2.5TDi D-4D S/Cab, S, SRX, S/Cab, S/Cab SRX HO, Raised Body Raider, D/Cab LWB P/up 2KD-FTV, 2.7i Raised Body Raider, D/Cab LWB P/up 2TR-FE Pet. (09-11), 3.0D-4D TDi D/C Raised Body Raider, Xtra cab, Legend40 LWB P/up KD-FTV Dies., 4.0i D/C Raised Body Raider, Legend40 LWB P/up 1GR-FE Pet. (09-16), 2.7 VVTi 2TR-FE, 3.0D-4D 1KD-FTV, 4.0 1GR-FE - 4X2 (11-16), 2.5D-4D Raised Body 2KD-FTV 5 Spd man., 3.0D-4D 1KD-FTV, 4.0 1GR-FE - 4X4 (11-16)
<b>HUB132</b>	Use - HUB118	
<b>HUB133</b>	Rear Wheel Hub	Audi A4 1.8T, 1.9TDi, 2.0, TDi, T FSi, 2.4, 2.5TDi, 2.6, 2.8, 1.7T, i, 3.0, TDi, 3.2, FSi, - Some Models (00-12), A4 (08-14)
<b>HUB134</b>	Rear Wheel Hub	Hyundai Tucson 2.0, 2.7 - Without ABS (2004-)
<b>HUB135</b>	Rear Wheel Hub	Hyundai Tucson 2.0 (04-11), Kia Sportage JE 2.0 - ABS (04-10)
<b>HUB136</b>	Rear Wheel Hub	Hyundai Elantra XD 1.6 - Non ABS, Rr. Drums (02-04)
<b>HUB137</b>	Rear Wheel Hub	Hyundai Matrix 1.6, 1.8 - Non ABS, Rr. Discs (02-08)
<b>HUB138</b>	Rear Wheel Hub Bearing	Hyundai Elantra HD 1.6 GLS, 2.0 GLS, G4GC (07-11), Tiburon 2.0 G4D (96-02)
<b>HUB139</b>	Rear Wheel Hub	Toyota Corolla Verso 1.6i, 1.8i (05-10)
<b>HUB140</b>	Rear Wheel Hub	Mercedes-Benz W204 C-Class C180, K, C200K, CDi, C220, CDi, C280, C300, C320, C350, CDi, C63 AMG (07-14)
<b>HUB141</b>	Rear Wheel Hub	Ford Fiesta III 1.0, 1.4, i, 1.6, I (2008-), Mazda 2 (DE) (07-15)
<b>HUB142</b>	Rear Wheel Hub	Mazda 6 2.0, 2.3, 2.3MPS, 2.5 (03-14)
<b>HUB143</b>	Rear Wheel Hub Bearing	Chevrolet Aveo 1.5 L, LS, LT, 1.6 LS (03-15), Sonic 1.3D, 1.4 Pet. Hatch / Sedan, 1.6 Pet. Hatch / Sedan (11-15)
<b>HUB144</b>	Rear Wheel Hub	Honda Ballade 1.5i (2011-), Brio 1.2 (2012-), Jazz 1.4, 1.5 (03-07)
<b>HUB145</b>	Rear Wheel Hub	Citroen C1 1.0, 1.0i (06-15), Peugeot 107 1.0i, 1.4HDi (2006-), Toyota Aygo 1.0 (2011-)
<b>HUB146</b>	Front Wheel Hub	Nissan Grand Livina 1.6 (08-13), Livina 1.6 (2008-), Tiida 1.6, 1.8 (06-13), NV200 1.5, 1.6 (2013-)
<b>HUB147</b>	Rear Wheel Hub Bearing	Nissan Grand Livina 1.6 Acenta, + HR16DE (08-14), Tiida 1.6 Acenta, Visia, +, 1.8 Acenta (06-13)
<b>HUB148</b>	Front Wheel Hub	Nissan Murano 3.5 SUV (2005-)
<b>HUB149</b>	Rear Wheel Hub	Nissan Murano 3.5 SUV (2005-), Murano 3.5 - 4X4 (05-07)
<b>HUB150</b>	Front Wheel Hub	Nissan Juke 1.2 DIG-T HRA20DDT, 1.5 dCi K9K, 1.6 HR16DE, 1.6 DIG-T MR16DDT - 4X2, 4X4 (2010-), Qashqai 1.6, 2.0, Dci - 4X2, 4X4 (2007-), X-Trail 2.0 - 4X2, 4X4 (2008-)
<b>HUB151</b>	Rear Wheel Hub Bearing	Nissan Juke 1.2 DIG-T HRA20DDT, 1.5 dCi K9K, 1.6 HR16DE, 1.6 DIG-T MR16DDT - 4X2, 4X4 (2010-), Livina 1.6 Acenta, +, Visia, X-Gear (07-15), Qashqai 1.5DCi, 1.6 Visia, Acenta, 2.0 DCi Acenta SUV, Petrol (2007-), 1.5DCi K9K282, K9K292, 1.5DCi K9K636, K9K646, 1.6 HR16DE, 2.0 DCi M1D, M9R, MR20DE (2007-), 1.6 dCi Accent Dies. R9M (2013-), X-Trail T31 2.0 D, Dci - 4X2 (08-14), Renault Koleos 2.5 Dynamique SUV (2009-)
<b>HUB152</b>	Rear Wheel Hub Bearing	Nissan Juke 1.6 DIG-T MR16DDT - 4X4 (2010-), Qashqai 2.0 Acenta, n-tec, 2.0 DCi Tekna SUV - 4X4 (2007-), X-Trail T31 2.0 D, DCi - 4X4 (08-14), Renault Koleos 2.0dCi Dynamique Premium SUV, 2.5 Dynamique, Premium CVT SUV - 4X4 (2009-)
<b>HUB153</b>	Front Wheel Hub Bearing	Nissan Navara & Pathfinder D40/ R51 2.5DCi D/Cab P/up, 3.0DCi V6, 4.0i V6, LE D/ Cab P/up - 4X4 (05-17)

## BUYERS GUIDE - LOOSE BEARINGS

<b>HUB154</b>	Rear Wheel Hub	Opel Corsa C 1.4i, 1.6i, 1.7TDi, CDTi, 1.8i (03-08)
<b>HUB155</b>	Rear Wheel Hub	Opel Adam 1.0T, 1.4, Adam S 1.4T (2014-), Corsa D 1.3CDTi, 1.4, 1.6i (08-15), Corsa E 1.0, 1.4 (2015-), 1.4 (2017-), Meriva 1.3CDTi – With Rr. Drums (03-09)
<b>HUB156</b>	Rear Wheel Hub	Opel Adam 1.0T, 1.4, Admas 1.4T (2014-), Corsa D 1.3CDTi, 1.4i, 1.6i, OPC (08-15), Corsa E 1.0, 1.4 (2015-), 1.4 – With Rr. Discs (2017-)
<b>HUB157</b>	Rear Wheel Hub	Peugeot Boxer - All with 1.2 Ton to 1.6 Ton Mass - For Vehicles Without Heavy Duty Suspension
<b>HUB158</b>	Rear Wheel Hub	Peugeot Boxer - All with 1.6 Ton to 2 Ton Mass - For Vehicles Without Heavy Duty Suspension (2006-)
<b>HUB159</b>	Front Wheel Hub	Renault Laguna II 2.0T (07-08)
<b>HUB160</b>	Front Wheel Hub	Renault Koleos 2.0DCi, 2.5 - All 4X2, 4X4 (2009-)
<b>HUB161</b>	USE - HUB152	
<b>HUB164</b>	Rear Wheel Hub Bearing	Suzuki Swift 1.2 GA, GL K12M, 1.2 AZG12, 1.4 GL, GLS, SE K14B, 1.4 AZG/AZH, 1.6, i M16A (11-18), SX4 1.6 GL, GLX, MA16A (2014-), 2.0i Hatch J2OA, J2OB - 4X2 (2008-)
<b>HUB165</b>	Front Wheel Hub Bearing	Toyota Auris 1.3, 1.4i RS, RT, 1.6i RS, RT, 1.8i RS, RX (2007-), Corolla FWD 1.3i Impact, Professional, Advanced, 1.4i, 1.6i Professional, Advanced, 1.8i (2007-), Corolla Verso 1.6, 1.8 (09-14), Corolla Quest FWD 1.6 Auto, Plus (2014-), Rav4 III 2.0i 1AZ-FE GX, VX, Fierce SUV, 2.2i D-4D 2AD-FTV GX, VX SUV - 4X4 (06-13), Rav4 IV 2.0, 2.2D 2AD-FTV, 2.5 2AR-FE - 4X2, 4X4 (2013-)
<b>HUB166</b>	Front Wheel Hub	Toyota Auris 2.0Di, Corolla FWD 2.0D (2007-), Rav4 III 2.0, 2.2D - Only Man. Models (2006-), Verso 2.0D4-D (2009-)
<b>HUB167</b>	Rear Wheel Hub	Toyota Auris 1.4i, 1.6i, 1.8i, 2.0Di - Japanese Made Models, Corolla 1.3i, 1.6i, 1.8i, 2.0D (2007-), Quest FWD 1.6 (2014-)
<b>HUB168</b>	Rear Wheel Hub	Toyota Auris 1.4i, 1.6i, 1.8i, 2.0Di - U.K. Made Models, Corolla FWD 1.3i, 1.6i, 1.8i - SA Made Models 2.0, 2.0D (2007-)
<b>HUB169</b>	Rear Wheel Hub	Toyota Avensis 2.0i, 2.4i (06-08)
<b>HUB170</b>	Front Wheel Hub	Toyota Land Cruiser 120 3.0iD, 4.0i V6 - Non ABS (02-09)
<b>HUB171</b>	Front Wheel Hub	Toyota Fortuner 2.5, 3.0 D4-D, 4.0 V6 - 4X2, 4X4 (2006-), Hilux "Vigo" 2.5TDi, D4-D, 2.7, 3.0, 4.0 - 4X2, 4X4 (2005-), FJ Cruiser 4.0 - 4X4 (2011-), Land Cruiser Prado120 3.0D, 4.0i V6 (02-09), Rav4 I 2.0 - 4X4 (95-02)
<b>HUB172R</b>	Rear Wheel Hub	Toyota Land Cruiser 120 3.0iD, 4.0i V6 - Non ABS (02-09)
<b>HUB173L</b>	Rear Wheel Hub	Toyota 02-09 Land Cruiser 120 3.0iD, 4.0i V6 - Non ABS
<b>HUB174R</b>	Rear Wheel Hub Bearing RHS	Toyota Land Cruiser Prado 120 3.0D 1KZ-TE VX S/W, 4.0 1GR-FE GX, VX S/W - 4X4 (02-10), Prado 150 3.0TDi 1KD-FTV, 4.0 V6 VVTi 1GR-FE (2009-)
<b>HUB175L</b>	Rear Wheel Hub Bearing LHS	Toyota Land Cruiser Prado 120 3.0D 1KZ-TE VX S/W, 4.0 1GR-FE GX, VX S/W - 4X4 (02-10), Prado 150 3.0TDi 1KD-FTV, 4.0 V6 VVTi 1GR-FE (2009-)
<b>HUB176</b>	Rear Wheel Hub Bearing	Toyota Rav4 III 2.0i 1AZ-FE GX, VX, Fierce SUV, 2.2i D-4D 2AD-FTV GX, VX SUV - 4X4 (06-13), Rav4 IV 2.0, 2.2D 2AD-FTV, 2.5 2AR-FE - 4X2, 4X4 (2013-)
<b>HUB177</b>	Front Wheel Hub	Audi A3 1.2 TFSi (12-17), 1.4 TFSi (08-13), 1.6 TDi (2010-), 1.8 TFSi, 1.9 TDi (08-13), 1.8 TFSi Quattro (12-17), 2.0 FSi BVZ (04-08), 2.0 FSi 8PA, 3.2 Quattro (03-13), 2.0 TFSi (05-10), 2.0 TDi - Somel Models (03-17), S3 2.0TFSi CJXB (13-17), VW Caddy 1.6i, 1.9TDi, 2.0TDi (2005-), Golf V 2.0i, FSi, TDi (04-09), Golf VI 1.4TSi, 1.6i, TDi, 2.0i, TSi, TDi (2009-), Golf VII 1.2TSi, 1.4TSi, 2.0TDi (2013-), Scirocco 1.4TSi, 2.0TSi, TSi R (2009-), Tiguan 1.4TSi, 2.0TSi, TDi - Some Models (2008-)
<b>HUB178</b>	Rear Wheel Hub Bearing	Hyundai Accent LC 1.3 G4EH, 1.5 G4EK, 1.6 G4ED (00-06)
<b>HUB179</b>	Rear Wheel Hub	Mercedes-Benz W169 A170, A180, A180 CDi, A200 (05-13), W245 B170, B180, B200 CDI, Turbo (05-12)
<b>HUB180</b>	Rear Wheel Hub Bearing	Mercedes-Benz W211 E-Class E200, K M111.941/956, E230 M111.970, E240 M112.911, E280 M112.921, E320 M112.941, E320CDi OM646.961, E350 M272.964, E500 M113.967 (96-10), W212 E-Class E200, Cgi, E250, CDi, Cgi, E350, Cdi, E400, E500 (2009-)
<b>HUB181</b>	Front Wheel Hub	Opel Astra G 1.6, 1.8 (99-06), Zafira I 1.8i - All With ABS - Alt. to HUB027 (01-05)
<b>HUB182</b>	Front Wheel Hub Bearing	Mitsubishi Triton 2.4 MPI D/cab P/up 2.5 Di-D C/cab P/up, 2.5 Di-D D/cab P/up, 3.2 Di-D D/cab P/up, 3.5 Club cab P/up, 3.5 MPI Double cab P/up - 4X2, 4X4 (2007-)
<b>HUB183</b>	Rear Wheel Hub	Honda Accord 2.0i, 2.2i, 2.4i (03-09)
<b>HUB184</b>	USE - HUB361	
<b>HUB185</b>	Rear Wheel Hub	Honda Civic VIII 1.8i, 2.0i, 2.2CTDi (07-13), Civic IX 1.8i (2012-)

## BUYERS GUIDE - LOOSE BEARINGS

<b>HUB186</b>	Rear Wheel Hub	Hyundai Accent MC 1.6 (06-11), Accent RB 1.6 (2011-), Getz 1.3, 1.4i, 1.5, 1.6 (03-12), i10 PA 1.1 G3LA, 1.2 G4LA (08-15), Grand i10 1.1 G3LA, 1.2 G4LA (2017-), i20 (PB/BT) 1.2, 1.4, 1.6 (2009-), Kia Picanto 1.1 (04-11), Rio 1.4, 1.6 - ABS (2004-)
<b>HUB187</b>	Rear Wheel Hub	Hyundai Tucson 2.0i, 2.0CRDi, 2.7 V6 SUV (2005-), Kia Sportage 2.0i, 2.0CRDi, 2.7 V6 SUV (2004-)
<b>HUB188</b>	Rear Wheel Hub	Kia Carens 2.0 CVVT, CRDi (2008-)
<b>HUB189</b>	Rear Wheel Hub	Kia Rio II 1.4, 1.6 (2004-)
<b>HUB190</b>	Rear Wheel Hub	Hyundai Atos 1.0 (00-05), 1.1 - ABS (2005-)
<b>HUB191</b>	Use - HUB138	
<b>HUB192</b>	Rear Wheel Hub	Chevrolet Cruze 1.6, 1.8, 2.0D Models With 15/16" Wheels (09-15), Opel Astra J 1.4T, 1.6i – ABS (2010-)
<b>HUB193</b>	Rear Wheel Hub	Chevrolet Cruze 1.6, 1.8, 2.0D Models With 17" Wheels (09-15), Orlando 1.8 (2011-), Opel Astra J 1.4T, 1.6i– ASB (2010-)
<b>HUB194</b>	Rear Wheel Hub Bearing	BMW X5 E53 3.0d SUV M57N - 4X4 (01-06), E53 3.0i SUV M54, 4.4i SUV N62, 4.8iS SUV N62, 4.6iS SUV M62 - 4X4 (2001-)
<b>HUB195</b>	Front Wheel Hub	BMW X5 E70 3.0i, D, 4.4, 4.6iS, 4.8iS (2001-)
<b>HUB196</b>	Rear Wheel Hub	BMW X5 E70 3.0i, D, 4.4i, 4.6iS, 4.8iS (2001-)
<b>HUB197</b>	Rear Wheel Hub	Hyundai Tiburon 2.0 (2002-)
<b>HUB198</b>	Rear Wheel Hub Bearing	Mazda 3 (BL, BK) 1.6 Original, Active, Dynamic B6ZE, Z6, 2.0 Individual LF17, 2.0 BN Series, 2.3, 2.3 MPS L6KG, 2.5 L5-VE (04-14), 5 2.0 Original, Active, Individual (07-14)
<b>HUB199</b>	Front Wheel Hub	Chevrolet Captiva 2.0D LTZ, 2.4LT, 3.2LTZ (07-11), 2.2D, 2.4 LT, 3.0 LTZ (11-17)
<b>HUB200</b>	Rear Wheel Hub	Chevrolet Captiva 2.0D LTZ, 2.2D, 2.4LT, 3.0, 3.2LTZ, 3.2 LTZ - 4X2, 4X4 (07-17)
<b>HUB201</b>	Front Wheel Hub	Chevrolet Cruze 1.6, 1.8, 2.0 Models With 15" Wheels (09-15), Opel Astra J 1.4T, 1.6i (2010-)
<b>HUB202</b>	Front Wheel Hub	Chevrolet Cruze 1.6, 1.8, 2.0D Models With 17" Wheels (09-15), Orlando 1.8 (2011-), Opel Astra J 1.4T, 1.6 (2010-)
<b>HUB203</b>	Rear Wheel Hub Bearing	Ford Fiesta III 1.0 Ecoboost, 1.4 Sedan, 1.4i Ambiente', Trend, Titanium, 1.6 Limited, 1.6i Ambiente', Sport, Trend, Titanium, TDCi, 1.6 Gtdi (2008-), 2 (DE) 1.3 Active, Dynamic, 1.5 Dynamic, Individual (07-15)
<b>HUB204</b>	Front Wheel Hub Bearing	Mazda 3 (BL, BK) 1.6 Original, Active, Dynamic B6ZE, Z6, 2.0 Individual LF17, 2.0 BN Series, 2.3, 2.5 L5-VE (04-14)
<b>HUB205</b>	Rear Wheel Hub	Nissan Almera 1.8 – ABS Alt. to HUB098 (01-06)
<b>HUB206</b>	Rear Wheel Hub	Mitsubishi Lancer 1.6 GLX, 2.0 GLS (03-08)
<b>HUB207</b>	Rear Wheel Hub	Mitsubishi Lancer 1.6 GLX, 2.0 GLS - Alt. (03-08)
<b>HUB208</b>	Front Wheel Hub Bearing ABS	Nissan Navara & Pathfinder D40/ R51 2.5DCi D/Cab P/up, 3.0DCi V6, 4.0i V6, LE D/ Cab P/up - 4X4 (05-17)
<b>HUB209</b>	Rear Wheel Hub	Nissan Navara D40 2.5DCi, 4.0i V6 - 4X2, Pathfinder D40/R51 2.5DCi, 3.0DCi V6, 4.0i V6 - 4X4 (05-17)
<b>HUB210L</b>	Rear Wheel Hub	Honda CR-V 2.0 5 Dr. SUV (97-02)
<b>HUB210R</b>	Rear Wheel Hub	Honda CR-V 2.0 5 Dr. SUV (97-02)
<b>HUB211</b>	Rear Wheel Hub	Toyota RAV4 II 1.8 4X2 - ABS (02-06)
<b>HUB213</b>	Rear Wheel Hub Bearing	Toyota Etios 1.5 xi/xs 5-door (12-13), 1.5 2NRFE (2013-)
<b>HUB214L</b>	Front Wheel Hub	Toyota Etios 1.5 xi, xs 5-Door - ABS (2012-)
<b>HUB214R</b>	Front Wheel Hub	Toyota Etios 1.5 xi, xs 5-Door - ABS (2012-)
<b>HUB215</b>	Front Wheel Hub Bearing	Alfa Romeo 156 2.0 Twin Spark Selespeed Sportswagon AR32301, 2.5 V6 AR32401, AR3240 Sportswagon (98-07)
<b>HUB216</b>	Rear Wheel Hub	Alfa Romeo Giulietta 1.4TB, 1.8TBi - ABS (2011-)
<b>HUB217</b>	Rear Wheel Hub	Alfa Romeo Giulietta 1.4TB, 1.8TBi - ABS (2011-)
<b>HUB218</b>	Front & Rear Wheel Hub	Alfa Romeo 159 1.8 TBi, 1.9 JTS, 2.0 JTS, 2.2 JTS, 2.4 JTDM Q-tronic (05-13), 3.2 Distinctive, V6 Q4, V6 Ti (11-13)
<b>HUB219</b>	Rear Wheel Hub	Alfa Romeo 159 1.8 TBi, 1.9 JTS, 2.0 JTS, 2.2 JTS, 2.4 JTDM Q-tronic (05-13)
<b>HUB220</b>	Rear Wheel Hub Bearing ABS	Dodge Caliber 1.8 SE, SXT, EBE, 2.0 TD, SXT, CVT, ECN, 2.4 RT, SXT, EDA (06-12), Jeep Compass 2.0CRD ECD, ECE (2007-)
<b>HUB221</b>	Rear Wheel Hub	Dodge Journey 2.0CRD, 2.4 SXT, 2.7 V6 R/T SXT, 3.6 V6 R/T SXT (2008-)
<b>HUB222L</b>	Rear Wheel Hub	Dodge Journey 2.0CRD, 2.4 SXT, 2.7 V6 R/T, SXT, 3.6 V6 R/T, SXT (2008-)

## BUYERS GUIDE - LOOSE BEARINGS

<b>HUB222R</b>	Rear Wheel Hub	Dodge Journey 2.0CRD, 2.4 SXT, 2.7 V6 R/T, SXT, 3.6 V6 R/T, SXT (2008-)
<b>HUB223</b>	Front & Rear Wheel Hub	Audi A4 3.2FSi Quattro (01-08), 1.8TFSi, 2.0T, TFSi, TDi, 3.0TDi (08-14), 3.2FSi, FSi Quattro (06-12), A5 2.0TFSi, TFSi Quattro, 3.0TDi Quattro, 3.2 FSi Quattro (08-14), A6 2.0TDi, TFSi, 3.0TDi, TFSi Quattro (08-14), Q5 2.0TFSi, TDi Quattro, 3.0TDi Quattro, 3.2FSi Quattro (09-14)
<b>HUB224</b>	Rear Wheel Hub	Audi A4 1.8 TFSi, 2.0 T, TFSi, Tdi, A5 2.0 TFSi, TDi, Quattro, 3.0 TDi Quattro, 3.2 FSi Quattro (08-14), A6 2.0 TDi, TFSi, 3.0 TDi, Quattro, TFSi Quattro (11-15)
<b>HUB225</b>	Rear Wheel Hub	Chevrolet Optra 1.6, 1.8 - Non ABS (04-11)
<b>HUB226</b>	Rear Wheel Hub Bearing	Chevrolet Optra 1.6 Ls F16D3, 1.8 Lt T18SED (04-11)
<b>HUB227</b>	Rear Wheel Hub	Fiat Punto 1.4 (04-13), Grande Punto 1 1.2, 1.3D, 1.4, 1.9 (06-10), Grande Punto 2 1.2, 1.4, 1.4 16V, 1.4 T-Jet (08-12)
<b>HUB228</b>	Rear Wheel Hub Bearing ABS	Chrysler Neon 1.8 PL, 2.0 PL, 2.0i R/T (02-06), PT-Cruiser 2.0 ECC Pet., 2.2 CRD, EDJ Dies., 2.4 ED2 Pet. (02-09)
<b>HUB229</b>	Rear Wheel Hub Bearing ABS	BMW Mini Cooper R50/R52/56 1.6 Cooper, Convertible, W10B16A, Cooper S, CVT, W11B16A, R53 1.6 Cooper S W11B16A (02-09)
<b>HUB230</b>	Front Wheel Hub	BMW Mini Cooper R50, R52, R53, R56 1.6 (02-09), R55, R57, R58, R59 1.6L (2007-)
<b>HUB231</b>	Rear Wheel Hub	BMW Mini Cooper R55, R57, R58, R59 1.6L (2007-)
<b>HUB232</b>	Front & Rear Wheel Hub	BMW Mini Cooper R60, R61 1.6L, 2.0L - 4X2 - ABS - 14mm Short Bolts (10-13)
<b>HUB233</b>	Rear Wheel Hub	BMW Mini Cooper R60, R61 1.6L, 2.0L - 4X2 - ABS (10-13)
<b>HUB234</b>	Rear Wheel Hub	Hyundai Elantra HD 2.0 (07-11), i30 FD/GD 1.6, 1.8, 2.0 (2010-)
<b>HUB235</b>	Rear Wheel Hub	Hyundai iX35 2.0, CRDi - 4X2 (2010-), Sonata 2.0, 2.7 V6 (2003-), 2.4 NF (05-10), 2.4 YF (2010-), Tucson JM 2.0 (04-10), Kia Optima 2.4 (12-14), Sportage SL 2.0 - ABS (2010-)
<b>HUB236</b>	Front / Rear Wheel Hub Bearing	Hyundai Santa Fe' 2.4 SUV G4JS, 2.7 V6 SUV G6BA-G - 4X4 (01-05), 2.2 CRDi D4EB "CM", 2.2 CRDi D4EB, D4HB - 4X4 (06-10), Kia Sorento 2.2 D4HB - 4X4 (2006-)
<b>HUB237</b>	Rear Wheel Hub	Hyundai Santa Fe' 2.2 CRDi "CM" (06-10), Kia 2.2, 2.4, 2.5, 3.5 V6, 3.8 V6 (2006-)
<b>HUB239</b>	Front Wheel Hub	Hyundai H1 2.4, 2.5 - ABS (2009-)
<b>HUB240</b>	Rear Wheel Hub Bearing	Hyundai 94-00 Accent X3 1.3, 1.5
<b>HUB241</b>	Rear Wheel Hub	Hyundai Accent (MC/RB )1.6 (2011-), i20 (PB/PBT) 1.2, 1.4, 1.6 (2009-), Kia Picanto 1.2, Rio III 1.2, 1.4 - ABS (2011-)
<b>HUB242</b>	Rear Wheel Hub	Hyundai Sonata Y3 2.0, 2.5 V6, 3.0 V6 - ABS (94-04)
<b>HUB243</b>	Rear Wheel Hub	Hyundai Sonata 2.0, 2.7 V6 (2003-), 2.4 NF (05-10), 2.4 YF - ABS (2010-)
<b>HUB244</b>	Rear Wheel Hub	Hyundai Elantra XD 1.6, 2.0 (02-07), i10 (PA) 1.1, 1.2 (08-15), Matrix 1.6, 1.8 (02-08), Kia Cerato 1.6, 2.0 - ABS (04-08)
<b>HUB245</b>	Rear Wheel Hub	Honda Accord VIII 2.0i V-Tec, 2.2i-D Tec, 2.4i V-Tec - ABS (08-15)
<b>HUB246</b>	Rear Wheel Hub	Ford B-Max 1.0 EcoBoost M1JE, M1JH (2015-), Ecosport 1.0i Ecoboost M1JC, 1.5TDCi UGJE, 1.5i UEJB (2013-)
<b>HUB247</b>	Rear Wheel Hub	Honda Civic VII 150i, 170i V-Tec - ABS - Discs (03-06)
<b>HUB248</b>	Rear Wheel Hub	Honda Civic VII 150i, 170i V-Tec - ABS - Drums (03-06)
<b>HUB249</b>	Rear Wheel Hub	Honda CR-V III 2.0 i-VTEC R20A1, 2.2 i-CTDi N22A2, 2.2 i-DTEC N22B3, 2.4 i-Vtec K24Z1, K24Z4 - 4X4 (09-12), CR-V IV 2.0 R20A6, 9, 2.0 i-VTEC R20A5, 6, 9, 2.2 i-DTEC N22B4, 2.4i K24Z9 - 4X2, 4X4 (2012-)
<b>HUB250</b>	Rear Wheel Hub	Mitsubishi Pajero 3.2DI-D 3.5, 3.8i (02-07), 2.5DI-D (2013-), 3.2DI-D, DI-DC, 3.8i V6 (2007-), 3.2DI-D - 4X4 (10-13)
<b>HUB251</b>	Front Wheel Hub	Mitsubishi Pajero 3.2 4X4 - Not for SA Models (2005-)
<b>HUB251A</b>	Front Wheel Hub	Mitsubishi Pajero 3.2Di-D, 3.5, 3.8i (02-07), 2.5DI-D, 3.2DI-D, DI-DC, 3.8i - 4X4 (2007-)
<b>HUB253</b>	Rear Wheel Hub	Honda FR-V 1.8i - ABS (07-10)
<b>HUB254</b>	Rear Wheel Hub	Toyota Corolla Verso 1.6, 1.8, 2.0D4-D (09-14), Yaris 1.5 Hybrid- ABS (2010-)
<b>HUB255</b>	Rear Wheel Hub	Toyota Avensis 2.2D4D (06-09)
<b>HUB256</b>	Rear Wheel Hub	Chevrolet Aveo 1.5, 1.6 (05-13), Spark 1.2 (2010-)
<b>HUB257</b>	Rear Wheel Hub	Ford Focus III 1.6i, 1.8, 2.0, TDCi, Gtdi (09-15)
<b>HUB258</b>	Front and Rear Wheel Hub	Audi 1.2 TFSi, 1.4 TFSi, 1.6 TDi, 1.8 TFSi Quattro, 2.0 TDi (12-17), A3 1.4 T FSi, 2.0TDi, S3 2.0TFSi, S3 2.0TFSi (13-17), VW 2013- Golf VII 1.2TSi, 1.4TSi, 2.0TDi



## BUYERS GUIDE - LOOSE BEARINGS

<b>HUB259</b>	Front Wheel Hub	Audi 12-17 1.2 TFSi, 1.4 TFSi, 1.6 TDi, 1.8 TFSi Quattro, 2.0 TDi, 13-17 A3 1.4 TFSi, 2.0TDi, S3 2.0TFSi, VW Golf VII 2.0GTi (2013-)
<b>HUB260</b>	Front Wheel Hub	Audi A6 2.0T (09-11), 2.4 (04-09), 3.2FSi - ABS (05-09)
<b>HUB261</b>	Rear Wheel Hub	Audi A6 2.0TFSi (09-11), A6 2.4 (04-09), A6 2.7TDi, 2.8FSi (06-11), A6 3.2FSi (05-09)
<b>HUB262</b>	Front & Rear Wheel Hub	Audi A6 2.7TDi, 2.8FSi, 3.0TDi Quattro, TFSi Quattro (06-11)
<b>HUB263</b>	Front Wheel Hub	BMW 1 Series 116i, 118i, 120D, 125i (11-15), F30/1 3 Series 316i, 320i, 328i, 330d, 335i, F34 320i, 320d, 328i, 335i (2012-), F30 318i, 320i, 320d, 330i, 340i Sport, F34 Gran Turismo 320d (2015-), Gran Turismo 320i (2016-)
<b>HUB264</b>	Front Wheel Hub	BMW E39 Series 523i, 525i, 528i, 530i, d, 540i (98-04), E60/1 5 Series 520d, 523i, 525i, 530i, 530d (04-10)
<b>HUB265</b>	Front Wheel Hub	BMW F07, F10/1, F18 Series 520d, GT, 523i, 528i, 530d, GT, 535i, GT, 535d - Non ABS (2011-)
<b>HUB266</b>	Rear Wheel Hub	BMW F07, F10/1, F18 Series 520d, GT, 523i, 528i, 530d, GT, 535i, GT, 535d (2011-)
<b>HUB267</b>	Rear Wheel Hub	BMW X1 E84 Series 1.8i, 2.0i, d, 2.3d, 2.5d, 2.8i 4X4 (09-15)
<b>HUB268</b>	Front Wheel Hub	BMW X1 E84 Series 1.8i, 2.0i, d, 2.3d, 2.5d, 2.8i 4X4 (09-15)
<b>HUB269</b>	Rear Wheel Hub	BMW X3 F25 Series 2.0i, 2.0d, 2.8i, 3.0d, 3.5i (2010-)
<b>HUB270</b>	Front Wheel Hub	BMW X3 F25 Series 2.0i, d, 2.8i, 3.0d, 3.5i (2010-)
<b>HUB271</b>	Front Wheel Hub	BMW X5 F15 Series 3.0d, 3.5i, 4.0d, 5.0i (2013-)
<b>HUB272</b>	Use - HUB196	
<b>HUB273</b>	Rear Wheel Hub	Nissan NV200 1.5 DCi, 1.6 (2013-)
<b>HUB274</b>	Front Wheel Hub	Chrysler Voyager 2.4, 3.3 (02-07), Grand Voyager 2.8CRD, 3.3, 3.8 (2002-)
<b>HUB275</b>	Rear Wheel Hub	Chrysler Voyager 2.4, 3.3 (02-07), Grand Voyager 2.8CRD, 3.3, 3.8 (2002-)
<b>HUB276</b>	Front Wheel Hub	Chrysler Grand Voyager 2.8CRD, 3.8 (2002-)
<b>HUB277</b>	Front Wheel Hub	Chrysler Grand Voyager 2.8CRD, 3.8 - Alt. (2002-)
<b>HUB278</b>	Rear Wheel Hub	Chrysler Grand Voyager 2.8CRD, 3.8 (2002-)
<b>HUB279</b>	Rear Wheel Hub	Chrysler Grand Voyager 2.8CRD, 3.8 - Alt. (2002-)
<b>HUB280</b>	Front Wheel Hub	Dodge Nitro 2.8, 3.7 (07-10), Jeep Cherokee 2.8 CRD, 3.7 - ABS (08-15)
<b>HUB281</b>	Rear Wheel Hub	Ford Focus II 1.6, 2.0 TDCi, 2.5 ST (05-09), Focus III 1.6i, 1.8, 2.0 Gdi, TDci, Gtdi ST1, ST2 (With Park Assist Sensors) (09-15)
<b>HUB282</b>	Rear Wheel Hub	Ford Focus II 2.0 TDCi (05-09), Volvo S40 1.8 Sedan, 2.0 Sedan, 2.0D, 2.4, i, 2.5i (2004-)
<b>HUB283</b>	Rear Wheel Hub	Ford Mondeo 2.0, 3.0 (02-06)
<b>HUB284</b>	Rear Wheel Hub	Hyundai Elantra (MD/UD) 1.6, 1.8 (11-16), i30 (FD/GD) 1.6, 1.8, 2.0 (2010-), Veloster 1.6 Gdi (2013-)
<b>HUB285</b>	Front Wheel Hub	Jeep Cherokee 2.4 KJ, 2.5CRD, 2.8CRD, 3.7 - RHS Only (02-08)
<b>HUB286</b>	Front Wheel Hub	Jeep Cherokee 2.4 KJ, 2.5CRD, 2.8CRD, 3.7 - LHS Only (02-08)
<b>HUB287</b>	Rear Wheel Hub	Jeep Compass 2.0, 2.4, Patriot 2.0CRD, 2.4 - 4X4 (2007-), Mitsubishi Outlander 2.4 - 4X4 (07-14)
<b>HUB288</b>	Front Wheel Hub	Jeep Grand Cherokee 2.7CRD, 3.0CRD, 3.6, 3.7 V6, 4.7 V8, 5.7 - 4X4 - Non ABS (2002-)
<b>HUB289</b>	Front Wheel Hub	Jeep Grand Cherokee 2.7CRD, 3.0CRD, 3.6, 3.7 V6, 4.7 V8, 5.7 - 4X4 - ABS (2002-)
<b>HUB290</b>	Rear Wheel Hub	Jeep Grand Cherokee 2.7CRD, 3.0CRD, 3.6, 3.7 V6, 4.7 V8, 5.7 - 4X4 - ABS (2002-)
<b>HUB293</b>	Front Wheel Hub	Jeep Wrangler 2.8CRD, 3.6, 3.8, 4.0 - 4X4 - Non ABS (2002-)
<b>HUB294</b>	Front Wheel Hub	Jeep Wrangler 2.8CRD, 3.6, 3.8, 4.0 - 4X4 - ABS (2011-)
<b>HUB295</b>	Rear Wheel Hub	Kia Cerato 1.6, 2.0 - ABS (2008-)
<b>HUB296</b>	Rear Wheel Hub	Kia Sedona 2.2CRDI, 2.5, 2.9 CRDI, 3.8 (04-13)
<b>HUB297</b>	Rear Wheel Hub	Kia Picanto 1.0 (2011-)
<b>HUB298</b>	Front Wheel Hub	Kia Sedona 2.2CRDI, 2.5, 2.9 CRDI, 3.8 (04-13)
<b>HUB299</b>	Front Wheel Hub	Kia Sorento 2.2, 2.4, 2.5CRDi, 3.5 V6, 3.8 V6 (2006-), Land Rover Discovery II 2.5 TD5, 4.0 V8 (04-05)
<b>HUB300</b>	Rear Wheel Hub	Land Rover Discovery II 2.5 TD5, 4.0 V8 (04-05)
<b>HUB301</b>	Rear Wheel Hub	Kia Soul 1.6 CRDi, 2.0 (2009-)

## BUYERS GUIDE - LOOSE BEARINGS

<b>HUB302</b>	Front Wheel Hub	Land Rover Discovery III 2.5TD V6, 2.7 TD V6, 4.0 V6, V8, Discovery IV 3.0D V6, SD V6, TD, 5.0 V8, 5.0P V8 (05-09), Range Rover Sport 3.0D V6, TD, 3.6 V8, TD V8, 4.2, 4.4 V8, 5.0 V8 (2005-)
<b>HUB303</b>	Front Wheel Hub	Land Rover Freelander II 2.0, 2.2D, TD4, 3.2 V6 (2007-)
<b>HUB304</b>	Front Wheel Hub	Lexus IS200, IS250, IS300, IS350 (06-13), GS300 (06-12)
<b>HUB305</b>	Rear Wheel Hub	Lexus IS200, IS250, IS300, IS350 (06-13), GS300 (06-12)
<b>HUB306</b>	Rear Wheel Hub	Lexus RX300, 350, 400, 450 - 4X4 (2003-)
<b>HUB307</b>	Front Wheel Hub	Mazda 6 GJ 2.0, 2.2D, 2.5 (14-17), CX-5 2.0 (12-15)
<b>HUB308</b>	Rear Wheel Hub	Mazda 3 1.6, 2.0 BM,BN (2014-), 6 GJ 2.0, 2.2D, 2.5 (14-17), CX-5 2.0 (12-15)
<b>HUB310</b>	Rear Wheel Hub	Mercedes-Benz W176 A-Class 180, CDi, 200, 220CDi, 250 (2013-), W245 B-Class 180, CDi, 200, CDi, 250 (2012-)
<b>HUB311</b>	Front Wheel Hub	Mercedes-Benz Sprinter BM906 Series (2006-), VW Crafter 2.0TDi, Bi-TDi "35" Std. Suspension (2012-)
<b>HUB312</b>	Rear Wheel Hub	Mercedes-Benz Sprinter BM906 Series (2006-), VW Crafter 2.5TDi - 4X4 (07-14)
<b>HUB313</b>	Front Wheel Hub	Mercedes-Benz Viano, Vito 2.2, 3.0, 3.5 V6 (2006-)
<b>HUB314</b>	Rear Wheel Hub	Mitsubishi ASX 2.0 (2011-), Lancer 1.5, 1.6, 2.0 (2007-)
<b>HUB315</b>	Front Wheel Hub	Mitsubishi Lancer 2.0 Evo X AWD (2007-)
<b>HUB316</b>	Rear Wheel Hub	Mitsubishi Lancer 2.0 Evo X AWD (2007-), Outlander 2.4 - 4X4 (07-14)
<b>HUB317</b>	Front Wheel Hub	Nissan Navara 2.5 DCI - 4X2 (05-17)
<b>HUB318</b>	Front Wheel Hub	Opel Astra H 1.9 CDTI, 2.0 - From Chassis No. 62083450 & 65076710 & 68027073 (04-10)
<b>HUB319</b>	Rear Wheel Hub	Citroen Berlingo 1.4, 1.6, HDi, 1.9D (03-15), Picasso 1.6, HDi, 1.8, 2.0, HDi (05-06), Peugeot Partner 2.0 Hdi (03-10)
<b>HUB320</b>	Rear Wheel Hub	Renault Kangoo 1.4, 1.5DCi (03-10)
<b>HUB322</b>	Front Wheel Hub	Subaru Forester 2.0, 2.5 AWD (2002-), Outback 2.0D, 2.5, 3.0R, 3.6R AWD (2004-), Toyota 86 2.0 (2012-)
<b>HUB323</b>	Rear Wheel Hub	Subaru Forester 2.0, 2.5 AWD (2002-), Outback 2.0D, 2.5, 3.0R, 3.6R AWD (2004-), Toyota 86 2.0 (2012-)
<b>HUB324</b>	Rear Wheel Hub	Toyota Camry II 2.4i, 3.0 - RHS (01-06)
<b>HUB325</b>	Rear Wheel Hub	Toyota Camry II 2.4i, 3.0 - LHS (01-06)
<b>HUB326</b>	Rear Wheel Hub	Toyota Land Cruiser HDJ200 Series 4.5 D-4D, 4.6 V8, 4.7 V8 - 4X4 - LHS (2007-)
<b>HUB327</b>	Rear Wheel Hub	Toyota Land Cruiser HDJ200 Series 4.5 D-4D, 4.6 V8, 4.7 V8 - 4X4 - RHS (2007-)
<b>HUB328</b>	Front Wheel Hub	Toyota HDJ200 Series Land Cruiser 4.5 D-4D, 4.6 V8, 4.7 V8 - 4X4 (2007-)
<b>HUB329</b>	Rear Wheel Hub	Toyota Rav4 III 2.0i, 2.2i D-4D (06-13), Rav4 IV 2.2D - 4X4 (2013-)
<b>HUB329</b>	Rear Wheel Hub Bearing	Toyota Rav4 III 2.0i 1AZ-FE GX, VX, Fierce SUV, 2.2i D-4D 2AD-FTV GX, VX SUV - 4X4 (06-13), Rav4 IV 2.0, 2.2D 2AD-FTV, 2.5 2AR-FE - 4X2, 4X4 (2013-)
<b>HUB330</b>	Rear Wheel Hub	Toyota Rav4 IV 2.0 - 4X2 (2013-)
<b>HUB331</b>	Front Wheel Hub	VW Crafter 2.0 TDI "35" (2012-)
<b>HUB332</b>	Front Wheel Hub	Nissan NV350 Impendulo 2.5, 2.5D (2013-)
<b>HUB333</b>	Rear Wheel Hub	Subaru Outback 2.0D, 2.5, 3.0R, 3.6R AWD (04-09)
<b>HUB334</b>	Front Wheel Hub	Subaru Impreza 2.0 WRX STI, 2.5 WRX STI AWD (2004-)
<b>HUB335</b>	Front & Rear Wheel Hub	Suzuki Grand Vitara 2.0, 2.4, 2.5 V6, 3.2 V6 - 4X4 (2002-)
<b>HUB336</b>	Front Wheel Hub	Volvo C30 1.6, 1.8, 2.0, 2.5i (08-13), S40 1.8, 2.0, D, 2.4, i, 2.5i - (Not PQ723) (2004-), C70 2.5T (04-13)
<b>HUB337</b>	Front Wheel Hub	Volvo V40 1.6 D2 (2012-)
<b>HUB338</b>	Rear Wheel Hub	Volvo V40 1.6 D2 (2012-)
<b>HUB339</b>	Front Wheel Hub	Volvo S60 1.6, 2.0, 2.4, 3.0, V60 1.6, 2.0, 2.4, 3.0 (2010-), CX60 2.0, T, 2.4, 3.0, T - 4X2, 4X4 (2009-)
<b>HUB340</b>	Rear Wheel Hub	Volvo S60 1.6, 2.0, 2.4, V60 1.6, 2.0, 2.4, 3.0 (2010-)
<b>HUB341</b>	Rear Wheel Hub	Volvo S60 2.0T6, 3.0T6 AWD, V60 2.0T, 3.0 T6 AWD (2010-)
<b>HUB342</b>	Rear Wheel Hub	Volvo XC60 2.0T (10-11), XC60 2.4D (09-10), XC60 T5 (11-14), CX60 2.0, T, .2.4 - 4X2 (2009-)
<b>HUB343</b>	Rear Wheel Hub	Volvo XC60 3.0T - 4X4, XC60 D5 - 4X4 (09-10), CX60 2.0, 2.4, 3.0, T - 4X4 (2009-)
<b>HUB344</b>	Front Wheel Hub	Volvo XC90 2.4 D5 (04-06), XC90 2.4 D5, 2.5 T, T5, 2.9, 3.2, 4.4 V8 - 4X4 (03-14)



## BUYERS GUIDE - LOOSE BEARINGS

<b>HUB345</b>	Front Wheel Hub	Volvo XC90 3.2 - 4X4 (07-11), XC90 2.4, 2.5 T, T5, 2.9 T6, 3.2, 4.4 V8 - 4X4 (03-14)
<b>HUB346</b>	Rear Wheel Hub	Citroen Berlingo 1.4, 1.6, HDi, 1.9D (03-15), Picasso 1.6, HDi, 1.8, 2.0, HDi (03-05), Xsara 1.6, 1.8, 2.0 (03-08)
<b>HUB347</b>	Rear Wheel Hub	Citroen Xsara 1.6, 1.8, 2.0 - No ESP, STD Suspension (03-08)
<b>HUB348</b>	Rear Wheel Hub	Citroen Xsara 1.6, 1.8, 2.0 - With ESP, STD Suspension (03-08)
<b>HUB349</b>	Rear Wheel Hub	VW Up 1.0 (2015-)
<b>HUB350</b>	Rear Wheel Hub	Mazda 6 2.0, 2.3, 2.3 MPS AWD, 2.5 (2008-)
<b>HUB351</b>	Front Wheel Hub	Mercedes-Benz W166 ML250, 350, 500 (2012-)
<b>HUB352</b>	Rear Wheel Hub	Honda Jazz 1.3i, 1.4i, 1.5i - With Brake Drum (07-15)
<b>HUB353</b>	Rear Wheel Hub	Honda Ballade 1.5i (2011-), Jazz 1.3i, 1.4i, 1.5i - With Disc Brakes (07-15)
<b>HUB354</b>	Rear Wheel Hub	Ford Kuga 2.5 Turbo - 4X4 (11-13)
<b>HUB355</b>	Rear Wheel Hub	Ford Focus III 1.6i PNDA, 1.8 Si, Ambiente, Trend., 2.0 Gdi MGDA, 2.0 TDCi G6DA, BYD, 2.0 Gtdi ST1 & ST2 R9DA (09-15), Kuga 1.5 Ecoboost, 1.6 Ecoboost JQMA, JQMB, 1.6 Ecoboost Turbo JTMA, 2.0 Ecoboost, 2.0 TDCi, 2.0 TDCi TXDA, TXMA, 2.5 Turbo - 4X2, 4X4 (2011-), Tourneo / Transit Connect/Grand Connect 1.0 Eco-Boost Trend MPV SWB B3GA, 1.5 TDCi Ambiente Dsl P-Van LWB XWGA, 1.6 TDCi EcoBoost LWB T1GA (2013-)
<b>HUB356</b>	Rear Wheel Hub	Ford Kuga 1.6, 2.0 TDCI - 4X4 (2013-)
<b>HUB357</b>	Front Wheel Hub	Nissan Murano 3.5 - 4X4 (2007-)
<b>HUB358</b>	Same as HUB149	Nissan Murano 3.5 - 4X4 (2007-)
<b>HUB361</b>	Rear Wheel Hub	Honda Civic VIII 1.8i, 2.0i, 2.2CTDi Sedan (07-13)
<b>HUB362</b>	Rear Wheel Hub	Nissan Maxima QX 2.0 (97-04)
<b>HUB363</b>	Rear Wheel Hub	VW Polo 9N 1.9TDi, 2.0i (02-10), CrossPolo 1.6TDi, 1.9TDi (2007-), Polo Vivo 1.4, 1.6 (2010-), Polo 6R 1.2, 1.4, TSi, GTi, 1.6 (10-14), Polo 6C 1.0TSi, 1.2TDi, TSi, 1.4, TDi, 1.5TDi, 1.6TDi, 1.8TSi, Gti (2014-)
<b>HUB364</b>	Rear Wheel Hub	Proton Arena 1.5 (2006-)
<b>HUB365</b>	Rear Wheel Hub	Suzuki SX4 2.0i (08-14)
<b>HUB366</b>	Front Wheel Hub	Mazda 3 2.3MPS (2004-)
<b>HUB367</b>	Rear Wheel Hub	Mitsubishi Pajero 2.5 DI-D, 3.2 DI-DC, 3.2 DI-D, 3.5 DI-D, 3.8i V6 - 4X4 (07-13)
<b>HUB368</b>	Front Wheel Hub	Mitsubishi Pajero 3.2 DI-D - 4X4 (10-13)
<b>HUB369</b>	Rear Wheel Hub	Suzuki SX4 2.0i (08-14)
<b>HUB370</b>	USE - HUB171	Toyota Fortuner 2.4, 2.7, 2.8TD, 3.0D-4D, 4.0 - 4X2, 4X4 (15-16), Hilux "Revo" 2.4, 2.7 Raised Body, 2.4, 2.8, 4.0 - 4X2, 4X4 (2016-)
<b>HUB371</b>	Rear Wheel Hub	Chevrolet Sonic 1.3D, 1.4, 1.6 (11-15)
<b>HUB372</b>	Front Wheel Hub	Mazda 2 (DL) 1.5 (2015-)
<b>HUB373</b>	Rear Wheel Hub	Mazda 2 (DL) 1.5 (2015-)
<b>HUB374</b>	Rear Wheel Hub	Honda Accord 2.0i, 2.2, 2.4i - ABS (08-15)
<b>HUB375</b>	Rear Wheel Hub	Suzuki Swift 1.2, 1.4, 1.5i, 1.6, i (2010-)
<b>HUB380-12</b>	Rear Wheel Hub	Toyota Verso 1.6, 1.8, 2.0 D-4D (09-14)
<b>HUB381</b>	Front Wheel Hub	Mazda 3 (BM,BN) 1.6, 2.0 (2014-), CX-3 2.0 (2015-)
<b>HUB382</b>	Rear Wheel Hub	Mazda CX-7 2.3, 2.5 (07-12)
<b>HUB383</b>	Front Wheel Hub	Nissan Navara D40 2.5DCi, 4.0i V6 - 4X2 (05-17), Pathfinder - 4X4 (2015-)
<b>HUB384</b>	Front / Rear Wheel Hub	Volvo CX90 D4/5, T5/6 2.0 - 4X2, 4X4 (2015-)
<b>HUB385</b>	Rear Wheel Hub	Volvo CX90 D4 2.0 D4204T14 - 4X2 (2015-)
<b>HUB386</b>	Rear Wheel Hub	Volvo CX90 2.5 T - 4X4 (03-11)
<b>HUB387</b>	Rear Wheel Hub	Mazda CX-3 2.0 (2015-)
<b>HUB388</b>	Rear Wheel Hub	Kia Soul 1.6 G4FC, CRDi D4FB (2014-)
<b>HUB391</b>	Rear Wheel Hub	Mitsubishi ASX 2.0 (2011-)
<b>HUB392</b>	Front Wheel Hub	Nissan Qashqai 1.2 DIG-T HRA2DDT, 1.5 dCi Accent, Tekna K9K, 1.6 dCi Accent Dies. R9M, 1.6 DIG-T Accent Pet. MR16DDT, 2.0 I Pet. MR20DD - 4X2, 4X4 (2013-), Renault Kadjar 1.2 TCe H5F408, 1.5dCi K9K, 1.6dCi R9M (2015-)
<b>HUB393</b>	Rear Wheel Hub	Nissan Qashqai 1.2 DIG-T HRA2DDT, 1.5 dCi Accent, Tekna K9K, 1.6 DIG-T Accent Pet. MR16DDT, 2.0 I Pet. MR20DD - 4X2 (2013-), Renault Kadjar 1.2 TCe H5F408, 1.5dCi K9K, 1.6dCi R9M (2015-)

## BUYERS GUIDE - LOOSE BEARINGS

<b>HUB396</b>	Front Wheel Hub	Chevrolet Captiva 2.2D, 2.4 LT, 3.0 LTZ (11-17)
<b>HUB402</b>	Front Wheel Hub	Toyota C-HR 1.2T VVTi 8NR-FTS (2017-)
<b>HUB403</b>	Rear Wheel Hub	Toyota C-HR 1.2T VVTi 8NR-FTS (2017-)
<b>HUB404L</b>	Front Wheel Hub	Toyota Yaris1.5 2NR-FE Pet. (2018-)
<b>HUB404R</b>	Front Wheel Hub	Toyota Yaris1.5 2NR-FE Pet. (2018-
<b>HUB405</b>	Rear Wheel Hub	Toyota Yaris1.5 2NR-FE Pet. (2018-
<b>HUB406</b>	Front Wheel Hub	Subaru XV 2.0 (2012-), Forester 2.0, 2.5 (2013-)
<b>HUB407</b>	Rear Wheel Hub	Subaru XV 2.0 (2012-), Forester 2.0, 2.5 (2013-)
<b>HUB408</b>	Front Wheel Hub	Nissan NV200 1.5 Dci, 1.6 HR16DE (2013-)
<b>HUB409</b>	Rear Wheel Hub	Hyundai Accent 1.6 G4FG Pet., Kia Rio IV 1.2 G4LA Pet., 1.4 G4LC Pet. ( 2017-)
<b>HUB410</b>	Rear Wheel Hub	Nissan Micra (K14) 0.9 H4B 408, 1.0 HR10DDT (2017-)
<b>HUB411</b>	Front Wheel Hub	Honda CR-V IV 2.0 i-VTEC R20A5 (2012-)
<b>HUB412</b>	Front Wheel Hub	Audi A1 1.0 25 TFSi DKLA, DLAC, 1.0 30 TFSi DKJA, DKRF, 1.5 35 TFSi DADA, DPCA, 2.0 40 TFSi CZPC, DKZC (2018-), VW Polo VI (AW1, BZ1) 1.0 TSi CHZL, DKLA, 1.6 TDi DGTC, DGTD, 2.0 GTi CZPC, DKZC (2016-), T-Cross (C11) 1.0 TSi CHZL, DKLA, DLAC, DKJA, DKRF (2018-)
<b>HUB413</b>	Rear Wheel Hub	Honda Jazz IV 1.2 Trend L12B4, 1.5 Elegance L15Z2 (2015-)
<b>HUB414</b>	Rear Wheel Hub	Nissan Tiida 1.6 HR16DE (06-13), 1.8 MR18DE (07-11)
<b>HUB415</b>	Front Wheel Hub	Ford Tourneo Custom Bus 2.2 TDCi, Transit Custom Bus/Van 2.2 TDCi (12-18)
<b>HUB416</b>	Rear Wheel Hub	Ford Tourneo Custom Bus 2.2 TDCi, Transit Custom Bus/Van 2.2 TDCi (12-18)
<b>HUB417</b>	Rear Wheel Hub	Hyundai Tucson 1.6 Gdi G4FD, 1.6 T-Gdi G4FJ, 2.0 CRDi D4HA (15-20), Kia Sportage IV (QL, QLE) 1.6 Gdi G4FD, 1.6 TGDI AWD G4FJ, 2.0 G4NA (2015-)
<b>HUB418</b>	Rear Wheel Hub	Hyundai Tucson 1.6 T-Gdi AWD G4FJ (15-20), Kia Sportage IV (QL, QLE) 1.6 TGDI G4FJ, 2.0 G4NA, 2.0 CRDi G4HA, 2.4 Gdi G4KJ (2015-)
<b>HUB419</b>	Rear Wheel Hub	Honda CR-V IV 2.0 R20A6, R20A9 Pet., 2.0 i-DTEC N22B4 Dies., 2.4 K24Z9 Pet. AWD (2012-)
<b>HUB420</b>	Rear Wheel Hub	Suzuki Ertiga 1.4 VVT Pet. K14B, 1.5 VVT Pet. K15B (2012-)
<b>HUB421</b>	Rear Wheel Hub	Hyundai Grand i10 III 1.0 Mpi G3LA, G3LD Pet. (2019-), Kia Picanto III (JA) 1.0 G3LA, G3LD Pet., 1.2 G4LA Pet. (2017-)
<b>HUB500</b>	Front Wheel Hub Bearing	Ford Fiesta 1.4i, 1.6i (03-08)
<b>HUB760</b>	Rear Wheel Hub Bearing	Fiat Uno 1.0 Cento 156A2, 1.1 Espresso P/van 160A3, 1.1 Fire, Rio, Mia, Tempo 160A3, 1.4 Pacer, Beat, Mia, Tempo, SX 146C1 (90-05)
<b>HUB761</b>	Rear Wheel Hub	Fiat Uno 1.4 Turbo (90-98)
<b>HUB940</b>	Rear Wheel Hub	Hyundai Accent X3 1.3, 1.5 (94-00), Elantra J2 1.6, 1.8 (95-01), S Coupe 1.5 (94-95)
<b>HUB947</b>	Rear Wheel Hub	Hyundai Elantra 1.6, 1.8 (95-98), Tiburon 2.0 (96-01)
<b>JXCA25678</b>	Front Wheel Bearing Inner	Peugeot Boxer 2.5TD (02-06)
<b>M88010NP</b>	Diff. Pinion Bearing Rear	Mitsubishi Colt LDV 2.4i, 2.8D, 3.0i - 4X4 (98-09), Pajero 1.6, 1.8 (99-03)
<b>M88010SAP</b>	Diff. Pinion Bearing Front	Mitsubishi Colt LDV 1.6, 2.0, 2.5, 2.5d, 2.6 - 4X2, 2.5, 2.6, 3.0 - 4X4 (94-98), Pajero 1.6, 1.8, 3.0 (99-03)
<b>MBCFWB2008</b>	Front Wheel Bearing Inner	Mercedes-Benz W202/3/4 C-Class C180, K, C200, K, C220CDi, C230, C240, C250, C280, C350, C63 AMG (1994-)
<b>MBCFWB2008B</b>	Front Wheel Bearing Outer	Mercedes-Benz W202/3/4 C-Class C180, K, C200, K, C220CDi, C230, C240, C250, C280, C350, C63 AMG (1994-)
<b>MZ60127</b>	Diff. Carrier Bearing Left	Mazda 6 GJ 2.2D (14-17)
<b>MZ62127</b>	Diff. Carrier Bearing	Mazda 3 (BM) 2.0 (2014-), 6 GJ 2.0, 2.5 (14-16)
<b>MZ63127</b>	Diff. Carrier Bearing Right	Mazda 6 GJ 2.2D (14-17)
<b>N207EC3</b>	Rear Wheel Bearing	VW Kombi 1.2, 1.5, 1.6 (57-71)
<b>NIMURCB</b>	Diff. Carrier Bearing	Nissan Murano 3.5 SUV (2005-), Qashqai 2.0 - 4X4 (2007-)
<b>NIMURFPB</b>	Diff. Pinion Bearing Front	Nissan Murano 3.5 SUV (2005-)
<b>NIMURRPB</b>	Diff. Pinion Bearing Rear	Nissan Murano 3.5 SUV (2005-), Qashqai 2.0 - 4X4 (2007-)
<b>NINAA000</b>	Diff. Carrier Bearing	Nissan Navara 2.5DCi, 4.0i V6 P/up - All, Pathfinder 2.5DCi, 4.0i V6 P/up - All - 4X4 (2005-)

## BUYERS GUIDE - LOOSE BEARINGS

<b>NINAA001</b>	Diff. Pinion Bearing Front	Nissan Navara 2.5DCi, 4.0i V6 P/up - All, Pathfinder 2.5DCi, 4.0i V6 P/up - All - 4X4 (2005-)
<b>NINAA002</b>	Diff. Pinion Bearing Rear	Nissan Navara 2.5DCi, 4.0i V6 P/up - All, Pathfinder 2.5DCi, 4.0i V6 P/up - All - 4X4 (2005-)
<b>NINAS000</b>	Diff. Pinion Bearing Front	Nissan Navara 2.5DCi, 4.0i V6 P/up - All, Pathfinder 2.5DCi, 4.0i V6 P/up - All - 4X2, 4X4 (2005-)
<b>NINAS001</b>	Diff. Pinion Bearing Rear	Nissan Navara 2.5DCi, 4.0i V6 P/up - All, Pathfinder 2.5DCi, 4.0i V6 P/up - All 4X2, 4X4 (2005-)
<b>NINAS002</b>	Diff. Carrier Bearing	Nissan Navara 2.5DCi, 4.0i V6 P/up - All, Pathfinder 2.5DCi, 4.0i V6 P/up - All - 4X2, 4X4 (2005-)
<b>NIQA500</b>	Diff. Carrier Bearing	Nissan Qashqai 2.0 - 4X4 (2005-)
<b>NIQAN500</b>	Diff. Pinion Bearing Front	Nissan Qashqai 2.0 - 4X4 (2005-)
<b>NITI386319</b>	Diff. Carrier Bearing	Nissan Almera 1.5 (2013-), Grand Livina 1.6 (08-14), Livina 1.6 (07-15), Qashqai 1.5DCi, 1.6, 2.0 - 4X2 (07-13), 1.2 DIG-T HRA2DDT, 1.5 dCi Accent, Tekna K9K, 1.6 dCi Accent Dies. R9M, 1.6 DIG-T Accent Pet. MR16DDT, 2.0 I Pet. MR20DD - 4X2, 4X4 (2013-), Tiida 1.6, 1.8 (06-13), NV200 1.5DCi, 1.6 (2013-)
<b>OC40650</b>	Rear Wheel Bearing Inner	Opel Corsa C 140i Classic, Comfort, Chill, Classic Essentia, Hatch Club, Sport, Lite Sport, S14NE, 160i Classic, Classic Elegance, Classic CD, CDE, Sport, 16SE, 1.7TDi Sport, Classic, CDTi Enjoy, Hatch CDTi Elegance, Classic DTi Elegance X17D, 1.8i GSi Hatch, Classic (03-08), Corsa LDV II 1.4i Utility, Club Sport, S P/up 14XE, 1.7DTi Utility Club, Sport P/up, 1.8i Utility Club, Sport P/up (03-10)
<b>OC40650</b>	Rear Wheel Bearing Inner	Opel Corsa 140i, 1.6i, 1.7TDi, CDTi, 1.8i (02-08), Corsa LDV 1.4i, 1.6i, 1.7DTi, 1.8i – Some Models (2003-)
<b>PQ10192</b>	Alternator/Generator Bearing	Toyota Dyna 3.7, 4.0 (95-02), Land Cruiser 3.0, 3.4, 4.0, 4.2, 4.5, 4.7 - 4X4 (90-04)
<b>PQ1B332466</b>	Carrier Bearing	Mercedes-Benz W201 (93-94)
<b>R30-9</b>	Diff. Pinion Bearing Front	Toyota Conquest 1.6 (94-94), Corolla 1.3, 1.6, 1.8 (88-02)
<b>R41Z-170A</b>	Diff. Carrier Bearing	Toyota Rav4 2.0 - 4X4 (94-02)
<b>R45-Z2</b>	Diff. Carrier Bearing	Toyota Cressida 2.0, 2.4, 2.8i (82-92)
<b>R45-Z5</b>	Diff. Carrier Bearing	Ford Spectron 2.2 (91-04), Courier 3.0 - 4X4 (90-96), Mazda Marathon 2.2 (91-04), B2600, B3000 - 4X4 (86-96)
<b>RNU0727</b>	Rear Wheel Bearing Inner	Toyota Stout 2.0 (79-89), Land Cruiser 3.6, 3.9, 4.0, 4.2, 4.5 - 4X4 (73-98)
<b>RR21</b>	Lock ring/ Retainer	Mahindra Scorpio 2.0, 2.2, CRDE, 2.5NEF, 2.6 Turbo, 2.6 TD, CRDE (2005-), Scorpio Pick-Up 2.2CRDE, 2.5, TD, 2.5NEF Tci (2006-), Nissan Navara D40 2.5DCi, LE, SE, XE, D/Cab P/up, 4.0i V6, LE D/Cab P/up - 4X2, Navara & Pathfinder D40 2.5DCi D/ Cab P/up, 3.0DCi V6, 4.0i V6, LE D/Cab P/up - 4X4 (2005-), Tata Telcoline 2.0 Turbo Diesel S/Cab P/up (2004-)
<b>RR30</b>	Lock ring/ Retainer	Ford Escort RWD MkI, MkII (Local) (68-81), Nissan Stanza 1.6, 1.8 (Local) (80-84), B14 (80-08), Toyota Corolla RWD 1.6, 1.8 (Sedan) (80-88), Cressida 3T (80-89), 2.0 GL, GLE, GLX (81-86), Corolla 1.3, 1.6 (Local) (84-89)
<b>RR35</b>	Lock ring/ Retainer	Ford Cortina MkIII, MkIV, MkV (71-84), Nissan Laurel C31 2.0, 2.8 (Local) (80-87), Skyline R30 1.8, 2.0 (82-87), R31 Series 2.0 (Local) (87-92), Opel Rekord 2.0, i, 2.2E (82-95), Toyota Corolla RWD 1.6, 1.8 S/W (80-88), Cressida 2Y, RX60 (80-92)
<b>RR42</b>	Lock ring/ Retainer	C.A.M Inyathi, Jinbei Haise Minibus 2.2i, Rhino 2.2i (Imp. Diff), 2.8i (2007-), Toyota Fortuner 3.0, 4.0 (Imp. & Local) - 4X2, 4X4 (06-09), Hiace YH51/61 2.0 (Imp.), YH53/63 (83-88), Quantum 2.5D-4D, 2.7 (2005-), Hilux 1.8, 2.2, 2.4, 3.0D, iD (Imp.) (79-98), Hilux "Vigo" 2.0i, 2.5TDi, 2.7i, 3.0, 4.0i (Imp. & Local) - 4X2, 4X4 (05-09)
<b>RR43</b>	Lock ring/ Retainer	Nissan Laurel C31 2.0, 2.8 (Imp.) (80-87), Stanza 1.6, 1.8 [Imp.] (80-84), Skyline R30 1.8, 2.0 (82-87), R31 2.0 (Imp.) (87-92), Toyota Corolla 1.3 (Imp.) (84-88)
<b>RR44</b>	Lock ring/ Retainer	C.A.M Rhino 2.2i, 2.8i (2007-), Hyundai Bakkie (Imp.)(97-01), H100 P/van 2.6i (00-07), Mitsubishi Colt LDV 2.8TDi, 3.0i - 4X2, 2.8D, TDi - 4X4 (99-09)
<b>RR45</b>	Lock ring/ Retainer	Mitsubishi Colt LDV 2.0, i, 2.4i, 2.5D, 2.8D, TDi, 3.0i - 4X2, 4X4 (94-09)
<b>RR46</b>	Lock ring/ Retainer	Mitsubishi Colt LDV 2.8TD Pioneer Only - 4X2, 2.8TD Rodeo D/Cab Only - 4X4 (98 -02)
<b>RR47</b>	Lock ring/ Retainer	Mitsubishi Colt LDV 2.8D - 4X2, 2.4i Trailbuster (94-98), Colt LDV 3.0i - 4X4 (99-09), Triton 2.4 MPI, 2.5 Di-D, 3.5 - 4X2, 4X4 (2007-)
<b>RR50</b>	Lock ring/ Retainer	Daihatsu Terios 1.5 - 4X2 (06-15), 1.3, 1.5i - 4X4 (02-15), Toyota Avanza 1.3, 1.5, i (2006-)
<b>RR51/57</b>	Lock ring/ Retainer	Toyota Fortuner 2.5D-4D, 3.0D-4D 3.0, 4.0 - 4X2, 4X4 (06-16), HiLux "Vigo" 2.0i, 2.5TDi, 2.7i, 3.0, 4.0i - 4X2, 4X4 (09-16)

## BUYERS GUIDE - LOOSE BEARINGS

<b>RR52</b>	Use - RR21	
<b>RR53</b>	Lock ring/ Retainer	Suzuki Jimny 1.3i - 4X4 - Non ABS (2008-)
<b>RR54</b>	Lock ring/ Retainer	Suzuki Jimny 1.3i - 4X4 - ABS (2008-)
<b>RR55</b>	Lock ring/ Retainer	Daihatsu Terios 1.5 - 4X2 (06-15), 1.3, 1.5i - 4X4 (02-15), Toyota Avanza 1.3i, P/van (06-12)
<b>RR60</b>	Lock ring/ Retainer	Isuzu KB200i, KB250i, KB250Dc, KB300TDi (04-09), KB240i (04-12), KB300TDi - 4X2, 4X4 (07-11 )
<b>RW34R</b>	Rear Wheel Bearing Inner	Chrysler Valiant 3.7 (65-72), Hillman Arrow 1618 (68-71), Hunter 1618 (67-75), Vogue 1618, 1971 (67-77)
<b>RWBSJ13</b>	Rear Wheel Bearing Inner	Suzuki Samurai SJ410/13 - All (83-91), Jimny 1.3 - Non ABS (2009-)
<b>RWBSJ13ABS</b>	Rear Wheel Bearing Inner	Suzuki Jimny 1.3 - ABS (2009-)
<b>ST3668YR1-N</b>	Diff. Pinion Bearing Front	Toyota Camry 3.0 (92-01)
<b>ST5791-N</b>	Diff. Carrier Bearing	Toyota Camry 3.0 (92-97)
<b>ST5793-N</b>	Diff. Carrier Bearing	Toyota Camry 3.0 (92-97)
<b>STA3072... Continued</b>	Diff. Pinion Bearing Front, Rear	Toyota Fortuner 2.4TD, 2.5D-4D, 2.7, 2.8TD, 3.0iD, D-4D, 4.0i V6 SUV 4X2, 4X4 (2006-), Hilux 2.0, 2.5 D-4D, 2.7, 3.0iD, 4.0i - 4X2, 4X4 (2005-), "Revo" 2.4 - 4X2, 4X4 (2016-), Land Cruiser 4.2, 4.5, 4.7 (96-04), Quantum 2.5i MPV, Bus, P/van, 2.7i MPV, Bus, P/van (2005-), Fortuner 3.0 D-4D SUV 1KD-FTV, 4.0 V6, Epic SUV 1GR-FE Pet - 4X2, 4X4 (06-11), 2.5D-4D 2KD-FTV, 3.0D-4D 1KD-FTV, 4.0 V6 1GR-FE, 4.0 V6 Raised Body 1GR-FE - 4X2, 4X4 (11-16), 2.8GD DSi Raised Body 1GD-FTV, 3.0D-4D 1KD-FTV, 4.0 V6 1GR-FE - 4X4 (2015-), Hilux "Vigo" 2.0i U16/17 S/Cab, S, SRX LWB Pet. P/up 1TR-FE Pet., 2.5TDi D-4D S/Cab, S, SRX, S/Cab, S/Cab SRX HO, Raised Body Raider, D/Cab LWB 2KD-FTV, 3.0 D-4D TDi Raider, D/C Raider, Raised Body LWB P/up 1KD-FTV Dies., 4.0i D/Cab Raider Raised Body LWB P/up GR-FE Pet. - 4X2 (05-09), 3.0 D-4D TDi D/C Raider 1KD-FTV Dies., LWB P/up, 4.0 D/Cab Raider 1GR-FE Pet. LWB P/up - 4X4 (05-09), 2.7i S/Cab Raider, D/Cab Raider, S/Cab HO Raised Body LWB P/up 2TR-FE Pet. - 4X2 (05-11), 2.5TDi D-4D S/Cab, D/Cab SRX, Legend40 2KD-FTV Dies. LWB P/up, 2.7i S/Cab SRX, Legend40 2TR-FE Pet. LWB P/up - 4X4 (05-15), 3.0D-4D TDi D/C xtra cab, Raider, Legend40 1KD-FTV Dies. LWB, 4.0 D/Cab Raider, 1GR-FE Pet. - 4X4 (2009-), 2.0i S/Cab, S, SRX LWB Pet. P/up 1TR-FE Pet., 2.5TDi D-4D S/Cab, S, SRX, S/Cab, S/Cab SRX HO, Raised Body Raider, D/Cab LWB P/up 2KD-FTV, 2.7i Raised Body Raider, D/Cab LWB P/up 2TR-FE Pet. (09-11), 3.0D-4D TDi D/C Raised Body Raider, Xtra cab, Legend40 LWB P/up KD-FTV Dies., 4.0i D/C Raised Body Raider, Legend40 LWB P/up 1GR-FE Pet. (09-16), 2.0 VVTi 1TR-FE 5 Spd Man. S/cab, 2.5D-4D Raised Body 2KD-FTV 5 Spd Man., 2.5D-4D Std. Body 2KD-FTV 5 Spd Man., 3.0D-4D 1KD-FTV, 4.0 1GR-FE - 4X2 (11-16), 2.5D-4D Raised Body 2KD-FTV 5 Spd man., 3.0D-4D 1KD-FTV, 4.0 1GR-FE - 4X4 (11-16)
<b>STA3072</b>	Diff. Pinion Bearing Front, Rear	Toyota Hilux "REVO" 2.4 GD-6 Raised Body 2GD-FTV - 4X2, 2.4 GD-6 2GD-FTV, 2.8 GD-6 Raised Body 1GD-FTV, 4.0 V6 Raised Body 1GR-FE - 4X4 (2016-), Land Cruiser FZJ80 4.5 Std., GX, VX, Turbo S/W, P/up 1FZ-FE Dies., Turbo Dies. - 4X4 (95-06), FZJ105 4.5 Std., GX, Turbo P/up, S/W 1FZ-FE Dies., Turbo Dies. - 4X4 (95-98), FZJ105 4.5 V8 VX, Turbo P/up, S/W 2UZ-FE Pet. - 4X4 (98-06), HDJ/HZJ80 4.2 Std., GX, VX, Turbo S/W, P/up 1HD-FT, 1HZ Dies., Turbo Dies. 4X4 (95-01), HDJ100 4.2 Std., GX, VX S/W, 1HZ Pet., 4.5, 4.7 V8 (97-04), HDJ200 4.5 D-4D, 4.6 V8, 4.7 V8 - 4X4 (2007-), HZJ105 4.2 Std., GX DSL, Turbo P/up, S/W 1HZ Dies., Turbo Dies. - 4X4 (98-06), UZJ100 4.5 V8 Std., GX, VX S/W, P/up 2UZ-FE Pet. - 4X4 (98-06), Quantum 2.5 D-4D, "Family", S-long MPV, Van 2KD-FTV Dies., 2.7 "Family", S-long "Ses'fikile" MPV, Van 2TR-FE Pet. (2005-)
<b>STA5383</b>	Diff. Pinion Bearing Front / Rear	Toyota Fortuner 2.4TD, 2.7, 2.8TD, 3.0iD, D-4D, 4.0, i V6 SUV - 4X4 (2006-), Hilux 2.5TDi, 2.7i, 3.0TDi, 4.0i - 4X4 (2005-), "Revo" 2.4 - 4X2, 4X4 (2016-)
<b>STF4090</b>	Diff. Pinion Bearing Rear	Toyota Land Cruiser 4.2, 4.5, 4.7 (96-04)
<b>T3563-RS-2</b>	Front Wheel Bearing Outer	Toyota Dyna 4.0 (95-02)
<b>TOY32BCVAVZ</b>	Rear Wheel Bearing Inner	Daihatsu Terios 1.3 SUV K3-VE, 1.5i Off-Road, 5/7 Seater SUV 3SZ-VE, 1.5 - 4X2, 4X4 (02-15), Toyota Avanza 1.3i P/Van, S, SX MPV K3VE, 1.5i SX, TX MPV 3SZVE (06-12), 1.3 S, SX MPV 3K3VE, 1.3 S P/Van 3K3VE, 1.5 SX, TX MPV 3SZVE (12-16), 1.3 S, SX MPV 1NRVE, 1.3 S P/Van 1NRVE, 1.5 SX, TX MPV 2NRVE (2015-)



## BUYERS GUIDE - LOOSE BEARINGS

<b>TOY42KWD</b>	Rear Wheel Bearing Inner	Toyota Fortuner 3.0 D-4D SUV 1KD-FTV, 4.0 V6, Epic SUV 1GR-FE Pet. - 4X2, 4X4 (09-11), 2.5D-4D 2KD-FTV, 3.0D-4D 1KD-FTV - 4X2, 4X4 (11-16), 4.0 V6 1GR-FE, 4.0 V6 Raised Body 1GR-FE - 4X2, 4X4 (11-16), Hilux "VIGO" 2.5TDi D-4D S/Cab, D/Cab SRX, Legend40 2KD-FTV Dies. LWB P/up, 2.7i S/Cab SRX, Legend40 2TR-FE Pet. LWB P/up - 4X4 (05-15), 3.0D-4D TDi D/C xtra cab, Raider, Legend40 1KD-FTV Dies. LWB, 4.0 D/Cab Raider, 1GR-FE Pet. - 4X4 (2009-), 2.0i S/Cab, S, SRX LWB Pet. P/up 1TR-FE Pet., 2.5TDi D-4D S/Cab, S, SRX, S/Cab, S/Cab SRX HO, Raised Body Raider, D/Cab LWB P/up 2KD-FTV, 2.7i Raised Body Raider, D/Cab LWB P/up 2TR-FE Pet. (09-11), 3.0D-4D TDi D/C Raised Body Raider, Xtra cab, Legend40 LWB P/up KD-FTV Dies., 4.0i D/C Raised Body Raider, Legend40 LWB P/up 1GR-FE Pet. (09-16), Hilux 2.0 VVTi 1TR-FE 5 Spd Man. S/cab, 2.5D-4D Raised Body 2KD-FTV 5 Spd Man., 2.5D-4D Std. Body 2KD-FTV 5 Spd Man - 4X2 (11-16), 2.5D-4D Raised Body 2KD-FTV 5 Spd Man. - 4X4 (11-16), 2.7 VVTi 2TR-FE, 3.0D-4D 1KD-FTV, 4.0 1GR-FE - 4X2 (11-16), 3.0D-4D 1KD-FTV, 4.0 1GR-FE - 4X4 (11-16)
<b>TR0607J-1LFT</b>	Diff. Pinion Bearing Front	Toyota Cressida 3.0, 3.0i (89-92), Land Cruiser 3.0, 3.4, 4.0, 4.2, 4.5, 4.7 - 4X4 (90-04)
<b>TR070602S-N</b>	Diff. Pinion Bearing Front	Toyota Camry 2.0, 2.2 (92-01)
<b>TR0708-1N</b>	Rear Pinion Bearing	Nissan Hardbody 2.4 - 4X4 (91-98), Sani 2.4 (91-94)
<b>TR0708-1RN</b>	Rear Pinion Bearing	Nissan Sani, Hardbody 2.4 (91-98)
<b>TR07081YR-N</b>	Diff. Pinion Bearing Rear	Toyota Cressida 2.0, 2.4 (89-92), Dyna 2.0, 2.2, 3.0 (85-95), Hilux 2.4, 2.7i, 3.0i - 4X4 (94-05)
<b>TR070904-1... Continued</b>	Diff. Pinion Bearing Front, Rear	Toyota Condor 2.4i Estate, TX Estate 2RZ-E, 3.0 Estate, TX Estate 5L - 4X4 (00-05), Cressida MX75 3.0i ECT, GLS 7MG-E (86-92), Fortuner 3.0 D-4D SUV 1KD-FTV, 4.0 V6, Epic SUV 1GR-FE Pet. - 4X2, 4X4 (06-11), 2.5D-4D 2KD-FTV, 3.0D-4D 1KD-FTV - 4X4, 4.0 V6 1GR-FE, 4.0 V6 Raised Body 1GR-FE - 4X2, 4X4 (11-16), 2.8GD DSi Raised Body 1GD-FTV, 3.0D-4D 1KD-FTV, 4.0 V6 1GR-FE - 4X4 (2015-), Hilux RN67 2.4 LWB D/cab, Raider D/cab P/up 22R Pet. - 4X4 (94-98), RZN169 2.7i LWB D/cab, DLX S/cab, Raider S/D/cab, SRX D/cab, Legend 35 LWB P/up 3RZFE Pet., LN167 3.0D D/cab D-E, DLX, S/D/cab DE, Raider DE, Legend35 LWB P/up 5L Dies., 3.0iD LWB Raider S/cab & KZ-TE D/cab P/up, Legend35 - 4X4 (98-05), Hilux "VIGO" 2.0i U16/17 S/Cab, S, SRX LWB Pet. P/up 1TR-FE Pet., 2.5TDi D-4D S/Cab, S, SRX, S/Cab, S/Cab SRX HO, Raised Body Raider, D/Cab LWB 2KD-FTV, 3.0 D-4D TDi Raider, D/C Raider, Raised Body LWB P/up 1KD-FTV Dies., 4.0i D/Cab Raider Raised Body LWB P/up GR-FE Pet. - 4X2, 3.0 D-4D TDi D/C Raider 1KD-FTV Dies., LWB P/up, 4.0 D/Cab Raider 1GR-FE Pet. LWB P/up - 4X4 (05-09), 2.7i S/Cab Raider, D/Cab Raider, S/Cab HO Raised Body LWB P/up 2TR-FE Pet. - 4X2 (05-11), 2.5TDi D-4D S/Cab, D/Cab SRX, Legend40 2KD-FTV Dies. LWB P/up, 2.7i S/Cab SRX, Legend40 2TR-FE Pet. LWB P/up - 4X4 (05-15), 3.0D-4D TDi D/C xtra cab, Raider, Legend40 1KD-FTV Dies. LWB, 4.0 D/Cab Raider, 1GR-FE Pet. - 4X4 (2009-), 2.0i S/Cab, S, SRX LWB Pet. P/up 1TR-FE Pet., 2.5TDi D-4D S/Cab, S, SRX, S/Cab, S/Cab SRX HO, Raised Body Raider, D/Cab LWB P/up 2KD-FTV, 2.7i Raised Body Raider, D/Cab LWB P/up 2TR-FE Pet. (09-11), 3.0D-4D TDi D/C Raised Body Raider, Xtra cab, Legend40 LWB P/up KD-FTV Dies., 4.0i D/C Raised Body Raider, Legend40 LWB P/up 1GR-FE Pet. (09-16)
<b>TR070904-1</b>	Diff. Pinion Bearing Front, Rear	Toyota Hilux 2.0 VVTi 1TR-FE 5 Spd Man. S/cab, 2.5D-4D Raised Body 2KD-FTV 5 Spd Man., 2.5D-4D Std. Body 2KD-FTV 5 Spd Man., 2.7 VVTi 2TR-FE, 3.0D-4D 1KD-FTV, 4.0 1GR-FE - 4X2, 2.5D-4D Raised Body 2KD-FTV 5 Spd man., 3.0D-4D 1KD-FTV, 4.0 1GR-FE - 4X4 (11-16), Hilux "REVO" 2.4 GD-6 Raised Body 2GD-FTV - 4X2, 2.4 GD-6 2GD-FTV, 2.8 GD-6 Raised Body 1GD-FTV, 4.0 V6 Raised Body 1GR-FE - 4X4 (2016-), Land Cruiser FJ80 4.0 DLX, GX, VX P/up 3F/F-E Pet. - 4X4 (90-92), FZJ/HZJ75 4.2 GX S/W, P/up 1FZF/HZ Dies. - 4X4 (91-97), FZJ80 4.5 Std., GX, VX, Turbo S/W, P/up 1FZ-FE Dies., Turbo Dies. - 4X4 (92-95), FZJ80 4.5 Std., GX, VX, Turbo S/W, P/up 1FZ-FE Dies., Turbo Dies. - 4X4 (95-06), FZJ105 4.5 Std., GX, Turbo P/up, S/W 1FZ-FE Dies., Turbo Dies. - 4X4 (95-98), HDJ/HZJ80 4.2 Std., GX, VX, Turbo S/W, P/up 1HD-FT, 1HZ Dies., Turbo Dies. - 4X4 (95-01), HDJ100 4.2 Std., GX, VX S/W, 1HZ Pet., 4.5, 4.7 V8 - 4X4 (97-04), HDJ200 4.5 D-4D, 4.6 V8, 4.7 V8 - 4X4 (2007-), HZJ105 4.2 Std., GX DSL, Turbo P/up, S/W 1HZ Dies., Turbo Dies. - 4X4 (98-06), PHJ75 3.9 DLX, GX, GX Turbo P/up Perkins236 2H Dies., FJ75 4.0 DLX, GX, VX 3F/F-E Pet., HJ75 (85-92), UZJ100 4.5 V8 Std., GX, VX S/W, P/up 2UZ-FE Pet. - 4X4 (98-06), Prado 90/95 3.0 1KZ-TE GX, GX TDi S/W Dies., VX S/W Pet., 3.4 V6 GX, VX S/W Pet. 5VZ-FE - 4X4 (97-04), Quantum 2.5 D-4D, "Family", S-long MPV, Van 2KD-FTV Dies., 2.7 "Family", S-long "Ses'fikile" MPV, Van 2TR-FE Pet. (2005-)
<b>TR080702JN</b>	Diff. Carrier Bearing	Toyota Conquest/Tazz 1.3, 1.6, 1.8 (88-06), Corolla 1.3, 1.6, 1.8 (88-02)
<b>TR081105AR</b>	Diff. Pinion Bearing Rear	Toyota Dyna 2.0, 2.2, 3.0, 4.0 (85-02)
<b>TR091004</b>	Diff. Pinion Bearing Rear	Toyota Fortuner 2.4, 2.7i, 2.8TD, 3.0D-4D, 4.0 - 4X4 (15-16)

## BUYERS GUIDE - LOOSE BEARINGS

<b>TR100802</b>	Diff. Carrier Bearing	Toyota Fortuner 3.0 D-4D SUV 1KD-FTV, 4.0 V6, Epic SUV 1GR-FE Pet. - 4X2, 4X4 (06-11), 2.5D-4D 2KD-FTV, 3.0D-4D 1KD-FTV - 4X2, 4X4, 4.0 V6 1GR-FE, 4.0 V6 Raised Body 1GR-FE - 4X2 (11-16), Hilux "VIGO" 2.0i U16/17 S/Cab, S, SRX LWB Pet. P/up 1TR-FE Pet., 2.5TDi D-4D S/Cab, S, SRX, S/Cab, S/Cab SRX HO, Raised Body Raider, D/Cab LWB 2KD-FTV, 3.0 D-4D TDi Raider, D/C Raider, Raised Body LWB P/up 1KD-FTV Dies., 4.0i D/Cab Raider Raised Body LWB P/up GR-FE Pet. - 4X2, 3.0 D-4D TDi D/C Raider 1KD-FTV Dies., LWB P/up, 4.0 D/Cab Raider 1GR-FE Pet. LWB P/up - 4X4 (05-09), 2.7i S/Cab Raider, D/Cab Raider, S/Cab HO Raised Body LWB P/up 2TR-FE Pet. - 4X2 (05-11), 2.5TDi D-4D S/Cab, D/Cab SRX, Legend40 2KD-FTV Dies. LWB P/up, 2.7i S/Cab SRX, Legend40 2TR-FE Pet. LWB P/up - 4X4 (05-15), 3.0D-4D TDi D/C xtra cab, Raider, Legend40 1KD-FTV Dies. LWB, 4.0 D/Cab Raider, 1GR-FE Pet. - 4X4 (2009-), 2.0i S/Cab, S, SRX LWB Pet. P/up 1TR-FE Pet., 2.5TDi D-4D S/Cab, S, SRX, S/Cab, S/Cab SRX HO, Raised Body Raider, D/Cab LWB P/up 2KD-FTV, 2.7i Raised Body Raider, D/Cab LWB P/up 2TR-FE Pet. (09-11), 3.0D-4D TDi D/C Raised Body Raider, Xtra cab, Legend40 LWB P/up KD-FTV Dies., 4.0i D/C Raised Body Raider, Legend40 LWB P/up 1GR-FE Pet. (09-16), 2.0 VVTi 1TR-FE 5 Spd Man. S/cab, 2.5D-4D Raised Body 2KD-FTV 5 Spd Man., 2.5D-4D Std. Body 2KD-FTV 5 Spd Man., 3.0D-4D 1KD-FTV, 4.0 1GR-FE - 4X2, 2.5D-4D Raised Body 2KD-FTV 5 Spd man., 3.0D-4D 1KD-FTV, 4.0 1GR-FE - 4X4 (11-16), Land Cruiser FJ80 4.0 DLX, GX, VX P/up 3F/F-E Pet. - 4X4 (90-92), FZJ80 4.5 Std., GX, VX, Turbo S/W, P/up 1FZ-FE Dies., Turbo Dies. - 4X4 (92-95), FZJ80 4.5 Std., GX, VX, Turbo S/W, P/up 1FZ-FE Dies., Turbo Dies. - 4X4 (95-06), HDJ/HZJ80 4.2 GX, Turbo S/W, P/up 1HD-FT, 1HZ Dies., T. Dies. - 4X4 (90-95), HDJ/HZJ80 4.2 Std., GX, VX, Turbo S/W, P/up 1HD-FT, 1HZ Dies., Turbo Dies. - 4X4 (95-01), HDJ100 4.2 Std., GX, VX S/W, 1HZ Pet., 4.5, 4.7 V8 - 4X4 (97-04), HDJ200 4.5 D-4D, 4.6 V8, 4.7 V8 - 4X4 (2007-), UZJ100 4.5 V8 Std., GX, VX S/W, P/up 2UZ-FE Pet. - 4X4 (98-06), Quantum 2.5 D-4D, "Family", S-long MPV, Van 2KD-FTV Dies., 2.7 "Family", S-long "Ses'fikile" MPV, Van 2TR-FE Pet. (2005-)
<b>TR100902D-2-N</b>	Diff. Carrier Bearing	Toyota Camry 3.0 (92-97)
<b>TR101204</b>	Diff. Pinion Bearing Rear	Toyota Dyna 2.2, 2.4, 3.0, 3.7, 3.8, 4.0 (85-02)
<b>TR2852169</b>	Rear Wheel Bearing Inner	Hyundai Elantra 1.6, 1.8 (93-95)
<b>TRA0607NP</b>	Diff. Pinion Bearing Front	Toyota Hiace 2.0, 2.2 (85-88)
<b>TRA07083C-N</b>	Diff. Pinion Bearing Rear	Toyota Hiace 2.0, 2.2 (85-88)
<b>TRA080702N</b>	Diff. Carrier Bearing	Toyota Camry 2.0, 2.2 (92-01), Conquest/Tazz 1.3, 1.6, 1.8 (85-06), Corolla 1.3, 1.6, 1.8 (84-02)
<b>TRB55CRAFT</b>	Rear Wheel Bearing	VW Crafter (2012-)
<b>TRB60CRAFT</b>	Rear Wheel Bearing	VW Crafter (2012-)
<b>TRBFWBIV1</b>	Front Wheel Bearing Inner	Iveco Turbo Daily 35/10, 35/12 2.3i P/van, Bus (2006-)
<b>TRBFWBIV2</b>	Use - DACFWBBOX2	
<b>TRBRWBIV1</b>	Rear Wheel Bearing Outer	Iveco Turbo Daily 35/10, 35/12 2.3i P/van, Bus (2006-)
<b>U261+298</b>	Rear Wheel Bearing Inner	Ford Falcon 4.0 (96-01), Ranchero 3.6, 4.0, 4.1, 5.0 (71-01), Leyland Rover 2.6, 3.5 (78-84), Mazda 323 1.3, 1.4, 1.6 (77-81), Mitsubishi Colt 1.6, 2.0, 2.6 (72-84), Nissan 200, 280 (78-80)



# BUYERS GUIDE - LOOSE BEARINGS

<p><b>U399+360</b></p>	<p>Rear Wheel Bearing Inner</p>	<p>C.A.M. Inyathi Jinbei Haise Minibus 2.2i Std., Rhino 2.2i, 2.8i (2007-), Ford Cortina MkIV 3.0 V6 Ghia, GLS, S, S/W Essex EV30, 3.0 V6 Leisure, P/up Essex EV30 (77-80), Cortina MkV 1.6 GL, L, Kent, 1.6 P/up Kent, 2.4 P/up York D24, 3.0 V6 GLS, GLS XR6, Essex EV30, 3.0 V6 Leisure P/up Essex EV30 (80-86), Ford Courier 1.6 P/up F6, 1.8 Chassis cab, Explorer, Std., XLT P/up F8., 2.0 XLT FE., 2.2 D/cab, Explorer, Leisure, Std., XLT P (86-00), 3.0 V6 D/cab, Explorer, L, Leisure, Std., P/up Essex (86-97), 2.5 Turbo Diesel D/cab, Leisure P/up WL4 - 4X2, 4X4 (96-00), 3.4 V6 Leisure D/cab, P/up Essex - 4X2, 3.0 V6 Std., XLT, D/cab, Leisure, Explorer, Exec. P/up Essex, 3.4 V6 Leisure, P/up Essex. - 4X4 (97-01), Husky 1.8 1 Ton P/up 4G62, 2.0 1 Ton P/up, Bus, P/van 4G63 (85-99), Ranger 1.8 XL, P/up, 2.2 XL, P/up (00-05), 1.8 XL, P/up, 2.2 XL, P/up (04-10), 2.5 Diesel, Turbo Diesel D/Cab, High Trail, XL, DT XLT High Trail D/Cab, Super Cab - 4X2 (00-05), 2.5 D/Cab, High Trail, XL, DT XLT High Super Cab, 2.5TD Montana D/Cab WL4, 3.0TDCi, 4.0 Super Cab XLT - 4X4 (00-12), Spectron 2.2 Bus, P/van F2 (91-04), Hyundai Bakkie 2.5i D4BH Dies., 2.6i D4BB Dies., H100 P/Van 2.5i D4BH Dies., 2.6i D4BB Dies. (97-07), Isuzu KB20 1.6 P/up G161Z Pet., KB21 1.6 P/up G161Z Pet., KB22 1.8 P/up G180Z Pet., KBD20 2.0 P/up C190, KBD21 2.0 P/up C190, KBD22 2.2 LE, P/up C223, KB23 2.0 P/up G200Z, KB24 2.3 LE 4ZD1, KB25 1.6 P/up G161Z, KB26 1.6 P/up G161Z, 1.8 P/up G180Z, KBD23 2.5 LE, P/up 4JA1, KBD25 2.0 P/up C190 (78-89), KBD26 2.0 P/up C190, KBD27 2.2 C223, KBD28 2.5 4JA1 (81-89), KB27 1.8 P/up G180Z, KB28 2.0 P/up G200Z, KB29 2.3 P/up 4ZD1 (83-89), KB40 1.6 G161Z, KB41 1.6 G161Z, 1.8 G180Z, KB42 1.8 G180Z, KB43 2.0 G200Z, KB44 2.3 4ZD1, KBD40 KBD41 2.0 P/up C190, KBD42 2.2 P/up C223 - 4X4 (79-89), Isuzu KB160 1.6 Fleetside P/up, KB200 2.0 LE, Fleetside, D/cab P/up, KB220 2.2 LE, P/up, KB230 2.3 D/cab P/up (89-04), KB260 2.6 LE, D/cab, LX P/up 4ZE1, KB320 3.2 LE, D/cab, LX, Frontier, Reef, Blazer P/up 6VD1 (92-04), KB220 2.2 LE P/up, KB230 2.3 P/up 4ZD1, KB260 2.6 D/cab, LE, LX, KB320 3.2 V6 Frontier LX - 4X4 (89-04), KB200i 2.0 LX, KB240i 2.4 LX, KB250i 2.5 LX - 4X2, 4X4 (04-12), KB250D 2.5 Fleetside, LE, D/Cab P/up 4JA1, KB280DT 2.8 D/cab LE, LX, Frontier P/up Turbo 4JB1 - 4X2, KB250D 2.5 LE, D/cab P/up 4JA1, KB280DT 2.8 LE, LX, D/cab P/up Turbo 4JB1 - 4X4 (89-04), KB250Dc 2.5, KB300T-Di 3.0 LX - 4X2, 4X4 (04-09), Relay 2.0 P/van, Bus 4ZC1 (89-95), WFR 1.8 11FVX/12FVX Bus, P/van 4ZB1 (83-89), Kia Sportage JA 2.0 SUV 5 Spd. FE Pet. - 4X4 (98-03), Mazda B-Series B2000 2.0 SWB P/up MA Pet., B2200 2.2 SWB/LWB P/up S2 Dies. (82-86), B2600 2.6 LWB D/cab, Magnum, Drifter P/up 4G54 Pet., B2600i 2.6i LWB D/cab Drifter, SLX P/up 4G54 Pet. - 4X2 (86-01), B2600 2.6 V6 LWB D/cab, Magnum, Drifter P/up 4G54 Pet. - 4X4 (86-95)</p>
<p><b>U399+360... Continued</b></p>	<p>Rear Wheel Bearing Inner</p>	<p>B3000 3.0 V6 LWB D/cab, Magnum Drifter P/up Essex Pet. - 4X2, 4X4 (86-97), B1600 1.6 SWB Magnum P/up F6 Pet., B1800 1.8 SWB/LWB Magnum, Drifter P/up F8 Pet., B2000 2.0 LWB Drifter, Magnum P/up FE Pet., B2200 2.2 LWB D/cab, Drifter, Magnum P/up R2 Dies., 2.2 LWB D/cab, Drifter, Magnum P/up F2 Pet. (86-00), B2500 2.5, Td LWB D/Cab, Drifter, SLX P/up WL4 Dies./Turbo Dies. - 4X4 (96-99), B3400 3.4 V6 LWB Magnum D/cab P/up Essex Pet. - 4X2, 4X4 (96-01), B2500 2.5 LWB Diesel, Turbo Diesel D/cab, Drifter, SLX P/up WL4 Dies., Turbo - 4X2 (97-00), B2600i 2.6i V6 LWB Drifter, D/cab Drifter SLX P/up 4G54 Pet. - 4X4 (00-09), Drifter 1.8 SWB/LWB XL P/up Pet., 2.2 SWB/LWB XL P/up Pet., 2.5Td LWB Hi Ride, SL SLE, SLX D/cab, Hi Ride, Hi Trail D/cab P/up WL4 Dies./Turbo Dies. - 4X2 (00-09), 2.5Td LWB D/cab, DL, SL, SLE, SLX S/cab, D/cab P/up WL4 Dies./Turbo Dies. - 4X4 (02-09), 2.6i LWB Hi Ride, SL Hi Ride S/cab, SLE, SLX D/cab SLX Hi Ride D/cab, SLX Hi Trail D/cab P/up Pet. - 4X2 (00-09), 2.6i V6 LWB SL S/cab, SLE, SLX D/cab P/up 4G54 Pet. - 4X4 (02-09), Marathon 2.2 LWB Bus, P/van F2 Pet. (91-04), Mitsubishi Colt LDV 1.6 SWB/LWB Lo-Line P/up 4G32 Pet., 2.0 4G63 Pet., 2.5D 4D56 Dies., 2.6 WB Hi-Line P/up 4G54 Pet. (94-98), 2.5D LWB Hi-Line P/up 4D56 Dies., 2.6 LWB Lo-/Hi-Line, P/up 4G54 Pet., 3.0 V6 LWB Lo-/Hi-Line D/cab, Rodeo 6G72 Pet. - 4X4 (95-98), L300 1.6 Mini Bus, Van 4G32 Pet., 1.8 4G62 Pet., 2.0 P/up 4G63 Pet, Starwagon 2.0 S, SL, SLE, P/up, P/van 4G63 Pet. (82-01), Pajero 2.8 Tdi, 3.0 V6 SWB GLS Wagon 6G72 Pet., 3.5 V6 SWB GLS Wagon 6G74 Pet. - 4X4 (90-01), Nissan 1-Tonner/Hardbody AW/D21 1.6 L16S-J, 1.8 L18S-R, 2.0 NA20, 2.4 Z24/S, 2.5D TD25i, 2.7D TD27, 3.0 VG30E - 4X2, 2.4 Z24S, 2.7 TD27, 3.0 VG30E - 4X4 (88-99), 720 D20 1.8 L18S Kingcab, Sport, 2.2D SD/Z22 Tracker, 2.3 SD23 - 4X2, 1.8 L18S, 2.0 NA20, 2.2 Z22 - 4X4 (80-88), E20 1.8 L18 Bus, P/van Coach, Coach GL, GLE, Econolux, Ekonovan, Ekonowagon, 2.0 Bus, Van H20 (80-96), Hardbody QW/D22 2.0 NA20S, 2.0i KA20, 2.4i Z24, KA24E/DE, 2.7D TD27i, 3.0 i VG30E, 3.0TD ZD30, 3.2 QD32, 3.3i VG33E - 4X2, 2.4i KA24E, 2.7 TD27, 3.0 VG30E, 3.0TD ZD30, 3.2, 3.2D QD32, 3.3i VG33 - 4X4 (98-04)</p>

## BUYERS GUIDE - LOOSE BEARINGS

<p><b>U399+360... Continued</b></p>	<p>Rear Wheel Bearing Inner</p>	<p>Nissan Sani AW/D21 2.4, i Z24, 2.5 TD25, 2.7D, TD TD27, 3.0 VG30E - 4X2, 2.2 Z22, 2.4 Z24, 2.7 TD27, 3.0 VG30E - 4X4 (89-99), Terrano II 2.7 TD27 - 4X4 (00-02), Ssangyong Korando 2.3 K230 EL, Open Top S/W, 2.9 K290 EL, TDi, Open Top S/W, 3.2 K320 EL S/W, Musso 2.3 E230 EL S/W, 2.9 602, EL, EX, TDi, Exec., E290 TDi, Exec., 3.2 E320 EL Exec. (95-04), Toyota Hiace YH50/60 1.8 SWB / LWB P/van, LS Wagon 2Y Pet. (83-91), YH51/61 2.0 SWB/LWB 16 Seater Commuter, Super 10 Seater Custom Wagon, P/van 3Y Pet. (83-86), YH53/63 2.2 SWB/LWB P/van, Van, LS, Super T/14/16, GLX, Exec. Wagon, Siyaya Bus, P/van 4Y Pet. (All Local Models) (88-09), Hilux LN30/40/50/51/55 2.2 SWB/LWB P/up L Dies., 2.4 SWB/LWB D/cab, Raider P/up 2L Dies., YN58 2.2 LWB D/cab, Raider, SRX P/up 4Y Pet. (79-89), YN67 2.2 LWB D/cab, Raider D/cab P/up 4Y Pet. - 4X4 (86-94), YN51/56 1.8 SWB/LWB D/cab, S, SR, Raider P/up 2Y Pet., YN140 1.8 SWB/LWB D/cab, Raider, S, SRX P/up 2Y Pet. (86-05), LN65 2.4 LWB D/cab, Raider D/cab P/up 2L Dies. - 4X4 (89-98), RN67 2.4 LWB D/cab, Raider D/cab P/up 22R Pet. - 4X4 (94-98), RN58 2.4 22R Pet., LN140/145 2.4i DLX, P/up 2L Dies., RZN194 2.7i LWB D/cab, Raider, SRX, Legend35 Raider, 3RZFE Pet. (94-05), LN57 2.8D LWB D/cab, Raider P/up 3L Dies. - 4X2, LN67 2.8D LWB, D/cab, Raider D/cab P/up 3L Dies. - 4X4 (95-98), RZN147 2.0 SWB/LWB D/cab, DLX, Raider, S, SR, SRX P/up 1RZ Pet. - (98-05), LN192R 3.0D LWB Raider D-E, Raider DLX D/cab D-E, Legend35 Raider, P/up 5L Dies., 3.0iD LWB Raider, Raider D/cab, P/up KZ-TE Dies. (98-05), RZN169 2.7i LWB D/cab, DLX S/cab, Raider S/D/cab, SRX D/cab, Legend 35 LWB P/up 3RZFE Pet., LN167 3.0D D/cab D-E, DLX, S/D/cab DE, Raider DE, Legend35 LWB P/up 5L Dies., 3.0iD LWB Raider S/cab &amp; KZ-TE D/cab P/up, Legend35 - 4X4 (98-05), Stallion KF50 1.5 SR5,Commuter, Bus, P/up, P/van 5K Pet., YF50 1.8 SR5, P/up, P/van, Van 2Y Pet., LF50 2.4D P/up 2L5F Dies. (87-04), Tuv KF20 1.3 Chassis Cab, P/up, P/van, Bus 4K Pet., 1.5 P/up 5K Pet. (82-87), Venture YF50 1.8 8/10 Seater P/van 2Y Pet., 2.2 10 Seater, GLE, Getaway 9 Seater S/W 4Y Pet., LF50 2.4D 10 Seater S/W 2L5F Dies. (91-04)</p>
<p><b>U497+460</b></p>	<p>Rear Wheel Bearing Inner</p>	<p>Mahindra Scorpio 2.0, 2.2, 2.2 CRDE, 2.5 NEF, 2.6 Turbo, 2.6 TD /CRDE - 4X2, 4X4 (2005-), Scorpio Pick-Up 2.2 CRDE, 2.5, 2.5 TD, 2.5 NEF Tci (2006-), Nissan Navara D40 Series 2.5DCi, LE, SE, XE D/Cab P/up, 4.0i V6, LE D/Cab P/up (05-17), Navara &amp; Pathfinder D40/ R51 2.5DCi D/Cab P/up, 3.0DCi V6, 4.0i V6, LE D/Cab P/up - 4X4 (05-17), Tata Telcoline 2.0 Turbo Diesel S/Cab P/up - 4X2, 4X4 (04-10)</p>
<p><b>VWDC386518</b></p>	<p>Diff. Carrier Bearing Left, Right</p>	<p>Seat Ibiza 1.4, 1.6, 1.8T, 1.9TDi, 2.0, Leon 2.0FSi, T, T FSi, TDi (06-08), VW Beetle 2.0i (2003-), Caddy 1.6i (1996-), Golf V 1.6i (04-09), Jetta V 1.6i (2006-), Polo 1.4TDi, i, 1.6i, 1.8T, 1.9TDi, 2.0i (2002-), Caddy 1.6i (1996-)</p>
<p><b>VWDC487618</b></p>	<p>Diff. Carrier Bearing Right</p>	<p>Audi A3 2.0 FSi, TDi, T FSi, 3.2 (2003-), A4 2.0, TDi, T FSi, 3.2, FSi (2005-), S3 2.0TFSi (07-13), TT 2.0T FSi, 3.2 (2006-), Seat Altea 2.0TDi (06-08), VW Golf V 2.0, FSi, TDi (04-09), Jetta V 2.0, FSi, T FSi, Tdi (2006-), Touran 1.9TDi, 2.0TDi (2004-)</p>
<p><b>VWFP087A</b></p>	<p>Diff. Pinion Bearing Front</p>	<p>VW Passat 2.8 Quattro, 3.2 V6 (02-08)</p>
<p><b>VWRP1831</b></p>	<p>Diff. Pinion Bearing Rear</p>	<p>VW Passat 2.8 Quattro, 3.2 V6 (02-08)</p>
<p><b>VWS1999</b></p>	<p>Front Wheel Bearing Inner</p>	<p>VW Sharan 1.8T, 1.9, 2.8 (99-09)</p>
<p><b>XC2195</b></p>	<p>Front Wheel Bearing Inner</p>	<p>Toyota Camry 2.2, 2.4i, 3.0 (01-06)</p>
<p><b>XGBCITC3P</b></p>	<p>Front Wheel Bearing Inner</p>	<p>Citroen C2 1.4i, 1.6i, C3 1.4i, 1.6i (02-07), Peugeot 1007 1.6 (05-08), 207 1.4 Some, 1.6 (2006-)</p>

Notes:

# PTFE OIL SEALS

## FITTING INSTRUCTIONS

1. Keep the oil seal free from dirt and other contaminants.
2. **Don't remove the inner fitment sleeve prior to assembly.** This sleeve is essential for fitting the seal correctly and avoiding damage to the edge of the seal. Should the sleeve be removed, and the sealing lip is bent or kinked, the seal will be rendered useless.
3. The PTFE sealing lip and the shaft onto which it's fitted, must be totally dry and free of oil and grease contamination. Do **NOT use grease or oil** to lubricate the seal or shaft!! Failure to adhere to this will result in a leaking oil seal!

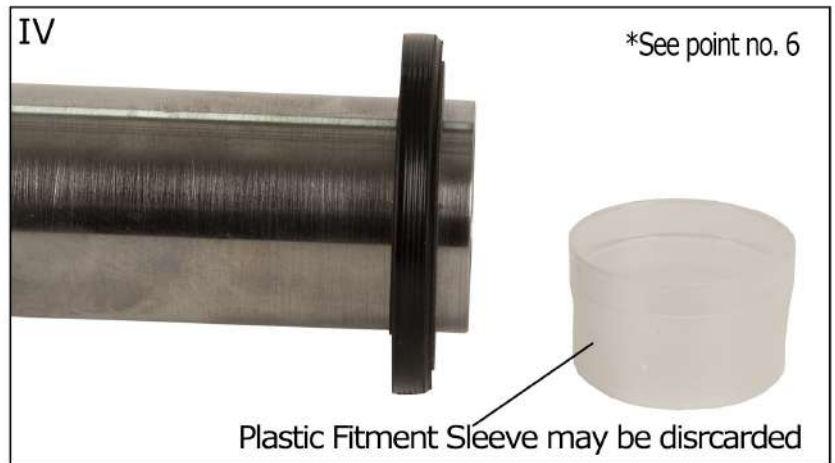
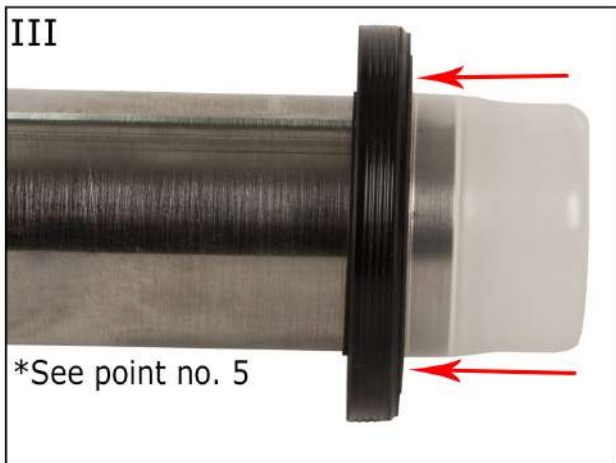
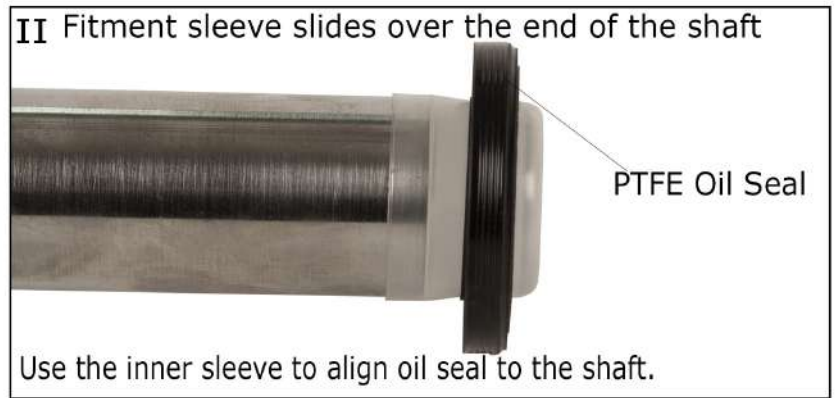

4. The shaft surface must be totally free of any kind of imperfection such as nicks, scrapes or wear marks. If necessary, these should be corrected by an engineering professional prior to fitting the seal.
5. Use the inner sleeve to align the oil seal to the shaft. Once aligned, push the seal onto the shaft in one smooth movement. The inner sleeve may be discarded once the seal is in position.
6. Allow the seal to remain in position for at least **4 hours** before rotating the shaft (starting the vehicle)! The seal requires this time to assume the correct dimension of the shaft.



# BUYERS GUIDE - OIL SEALS

<b>1235</b>	Timing Cover / Cam Oil Seal	Chevrolet 1900, 2500 (72-78), Chevair (76-82), Commodore (78-82), Constantia, Kammando (68-78), Firenza (71-75), Rekord (78-81), Senator (79-82), El Camino (72-78)
<b>1372</b>	Front / Rear Wheel Oil Seal	Land Rover Series IIA 88", 109" (65-80), 110" (84-96), Layland Rover 3500 (78-84)
<b>2034</b>	Timing Cover / Cam Oil Seal	Honda Prelude 1.8 (84-87)
<b>2641</b>	Rear Wheel Oil Seal Outer	Ford Cortina MkIII 1.6 L P/up Kent, 1.6 L, Std., XL Kent, 2.0 OHC GT, V4 L, XL, S/W Essex EV20, 2.0 V4 P/up Kohn T20, 2.5 L P/up Essex EV25, 2.5 XL, S/W Essex EV25, 3.0 GT, L, XL, XLE "Big Six" Essex EV30 (71-77), Cortina MkIV 1.3 L Kent, 1.6 GL, L, S/W Kent, 1.6 P/up Kent, 2.0 GL, GLE, S/W Kohn T20 (77-80), Cortina MkV 1.3 L Kent, 1.6 GL, L, Kent, 2.0 Ghia, GL Kohn T20, 3.0 V6 GLS, GLS XR6, Essex EV30 (80-86), Nissan Laurel C31 2.0 CA/L20, 2.8 SGL 5L28 (80-87), Skyline R30 1.8 L18, 2.0 GL L20, R31 S2.0 GL, GLE CA20 (82-92), Opel Rekord 2.0 Berlina, GL, GLS, L, S/W CIH, 2.0i CLE, CLS, GL, GLE, Irmischer, 2.2E CIH, 380i, V6 CD, GSi 38GE (82-95), Toyota Corolla RWD TE31 1.6 Sprinter, SR4/5, Black Hawk, Silver Wolf 2T, AE/TE71 1.6 GL, S/W, GLS Sprinter, SE 2T, TB TE72, 1.8 GLS, SE 3T (80-88), Cressida TX30 1.8 DX 3T, TX62 1.8 L, LS 3T, YX70 1.8 LS, Exec. (80-89), RX60 2.0 GL, GLE, GLX, S/W 21R, RX70, YX72 2.0 GL, GL, GLE, GLX (81-92), RX72 2.4 GL, GL S/W, GLE, GLE S/W 22R (87-92)
<b>2708</b>	Timing Cover Oil Seal	Ford Cortina MkIII 2.0 V4 L, XL, S/W Essex EV20, 2.5 L P/up Essex EV25, 2.5 XL, S/W Essex EV25, 3.0 GT, L, XL, XLE "Big Six" Essex EV30 (71-77), Cortina MkIV 3.0 V6 Ghia, GLS, S, S/W Essex EV30, 3.0 V6 Leisure, P/up Essex EV30 (77-80), Cortina MkV 2.4 P/up York D24, 3.0 V6 GLS, GLS XR6, Essex EV30, 3.0 V6 Leisure P/up Essex EV30 (80-86), Courier 3.0 V6 D/cab, Explorer, L, Leisure, Std., P/up Essex (86-97), Courier 3.4 V6 Leisure D/cab, P/up Essex - 4X2 (97-01), 3.0 V6 Std., XLT, D/cab, Leisure, Explorer, Exec. P/up Essex, 3.4 V6 Leisure, P/up Essex - 4X4 (97-00), Sapphire 3.0 Ghia, GLX Essex (89-93), Sierra 3.0, i GLS, GLX, LX, RS, XR6 Essex (83-93), Mazda B-Series B3000 3.0 V6 LWB D/cab, Magnum Drifter P/up Essex Pet - 4X2, 4X4 (86-97), B3400 3.4 V6 LWB Magnum D/cab P/up Essex Pet. - 4X2, 4X4 (96-01)
<b>2715</b>	Front Gearbox Oil Seal	Mercedes-Benz Sprinter 2.2 (96-06)
<b>2738</b>	Pinion Oil Seal	C.A.M. Inyathi, Jinbei Haise Minibus 2.2i Std. (2007-), Ford Cortina MkIII 1.6 L P/up Kent, 1.6 L, Std., XL Kent, 2.0 OHC GT, V4 L, XL, S/W Essex EV20, 2.0 V4 P/up Kohn T20, 2.5 L P/up Essex EV25, 2.5 XL, S/W Essex EV25, 3.0 GT, L, XL, XLE "Big Six" Essex EV30 (71-77), Cortina MkIV 1.3 L Kent, 1.6 GL, L, S/W Kent, 1.6 P/up Kent, 2.0 GL, GLE, S/W Kohn T20, 3.0 V6 Ghia, GLS, S, S/W Essex EV30, 3.0 V6 Leisure, P/up Essex EV30 (77-80), Cortina MkV 1.3 L Kent, 1.6 GL, L, Kent, 1.6 P/up Kent, 2.0 Ghia, GL Kohn T20, 2.4 P/up York D24, 3.0 V6 GLS, GLS XR6, Essex EV30, 3.0 V6 Leisure P/up Essex EV30 (80-86), Courier 1.6 P/up F6, 1.8 Chassis cab, Explorer, Std., XLT P/up F8., 2.0 XLT FE., 2.2 D/cab, Explorer, Leisure, Std., XLT P (86-00), 3.0 V6 D/cab, Explorer, L, Leisure, Std., P/up Essex (86-97), 2.5 Turbo Diesel D/cab, Leisure P/up WL4 - 4X2, 4X4 (96-00), 3.4 V6 Leisure D/cab, P/up Essex - 4X2 (97-01), 3.0 V6 Std., XLT, D/cab, Leisure, Explorer, Exec. P/up Essex, 3.4 V6 Leisure, P/up Essex. - 4X4 (97-00), Escort RWD MkI 1.1 Kent, 1.3 GT, L, Super, S/W Kent, 1.6 GT, L, XL Kent (68-75), Escort MkI/II 1.1 300 P/van Kent, 1.3 30, 35, 45 P/van Kent, 1.6 45 P/van Kent (68-81), Escort RWD MkII 1.3 L Kent, 1.6 GL, Sport Kent, RS2000 Kohn (75-81), Husky 1.8 1 Ton P/up 4G62, 2.0 1 Ton P/up, Bus, P/van 4G63 (85-99), Ranger 1.8 XL, P/up, 2.2 XL, P/up - 4X2 (00-05), 1.8 XL, P/up, 2.2 XL, P/up - 4X4 (04-10), 2.5 Diesel, Turbo Diesel D/Cab, High Trail, XL, DT XLT High Trail D/Cab, Super Cab - 4X2 (00-09), 2.5 D/Cab, High Trail, XL, DT XLT High Super Cab, 2.5TD Montana D/Cab WL4, 3.0TDCi, 4.0 Super Cab XLT - 4X4 (00-12), Spectron 2.2 Bus, P/van F2 (91-04), Isuzu KB20 1.6 P/up G161Z Pet., KB21 1.6 P/up G161Z Pet., KB22 1.8 P/up G180Z Pet., KBD20 2.0 P/up C190, KBD21 2.0 P/up C190, KBD22 2.2 LE, P/up C223, KB23 2.0 P/up G200Z, KB24 2.3 LE 4ZD1, KB25 1.6 P/up G161Z, KB26 1.6 P/up G161Z, 1.8 P/up G180Z, KBD23 2.5 LE, P/up 4JA1, KBD25 2.0 P/up C190 (78-89), KBD26 2.0 P/up C190, KBD27 2.2 C223, KBD28 2.5 4JA1 (81-89), KB27 1.8 P/up G180Z, KB28 2.0 P/up G200Z, KB29 2.3 P/up 4ZD1 (83-89), KB40 1.6 G161Z, KB41 1.6 G161Z, 1.8 G180Z, KB42 1.8 G180Z, KB43 2.0 G200Z, KB44 2.3 4ZD1, KBD41 2.0 P/up C190, KBD42 2.2 P/up C223 - 4X4 (79-89), KB160 1.6 Fleetside P/up, KB200 2.0 LE, Fleetside, D/cab P/up, KB220 2.2 LE, P/up, KB230 2.3 D/cab P/up (89-04), KB260 2.6 LE, D/cab, LX P/up 4ZE1, KB320 3.2 LE, D/cab, LX, Frontier, Reef, Blazer P/up 6VD1 (92-04), KB220 2.2 LE P/up, KB230 2.3 P/up 4ZD1, KB260 2.6 D/cab, LE, LX, KB320 3.2 V6 Frontier LX - 4X4 (89-04), KB250D 2.5 Fleetside, LE, D/Cab P/up 4JA1, KB280DT 2.8 D/cab LE, LX, Frontier P/up Turbo 4JB1 - 4X2, KB250D 2.5 LE, D/cab P/up 4JA1, KB280DT 2.8 LE, LX, D/cab P/up Turbo 4JB1 - 4X4 (89-04), Relay 2.0 P/van, Bus 4ZC1 (89-95), Kia Sportage JA 2.0 SUV 5 Spd. FE Pet. - 4X4 (98-03), Mazda B-Series B2000 2.0 SWB P/up MA Pet., B2200 2.2 SWB/LWB P/up S2 Dies. (82-86), B1600 1.6 SWB Magnum P/up F6 Pet., B1800 1.8 SWB/LWB Magnum, Drifter P/up F8 Pet., B2000 2.0 LWB Drifter, Magnum P/up FE Pet., B2200 2.2 LWB D/cab, Drifter, Magnum P/up R2 Dies., 2.2 LWB D/cab, Drifter, Magnum P/up F2 Pet. (86-00), B2500 2.5, Td LWB D/Cab, Drifter, SLX P/up WL4 Dies./Turbo Dies. - 4X2, 4X4 (96-99), B2600 2.6 LWB D/cab, Magnum, Drifter P/up 4G54 Pet. - 4X2, 4X4 (86-95), B2600i 2.6i LWB D/cab Drifter, SLX P/up 4G54 Pet. - 4X2, 4X4 (00-01)

# BUYERS GUIDE - OIL SEALS

<p><b>2738...</b> <b>Continued</b></p>	<p>Pinion Oil Seal</p>	<p>B3000 3.0 V6 LWB D/cab, Magnum Drifter P/up Essex Pet. - 4X2, 4X4 (86-97), B3400 3.4 V6 LWB Magnum D/cab P/up Essex Pet. - 4X2, 4X4 (96-01), Drifter 1.8 SWB/LWB XL P/up Pet., 2.2 SWB/LWB XL P/up Pet., 2.5Td LWB Hi Ride, SL SLE, SLX D/cab, Hi Ride, Hi Trail D/cab P/up WL4 Dies./ Turbo Dies., 2.6i LWB Hi Ride, SL Hi Ride S/cab, SLE, SLX D/cab SLX Hi Ride D/cab, SLX Hi Trail D/cab P/up Pet. - 4X2 (00-09), 2.5Td LWB D/cab, DL, SL, SLE, SLX S/cab, D/cab P/up WL4 Dies./ Turbo Dies., 2.6i V6 LWB SL S/cab, SLE, SLX D/cab P/up 4G54 Pet. - 4X4 (00-09), Marathon 2.2 LWB Bus, P/van F2 Pet. (91-04) Mitsubishi Colt LDV 1.6 SWB/LWB Lo-Line P/up 4G32 Pet., 2.0 4G63 Pet., 2.5D 4D56 Dies., 2.6 WB Hi-Line P/up 4G54 Pet., 2.8D LWB LWB Std., Hi line P/up Dies., 2.8TDi LWB Club CabS cab, Turbo, 3.0i V6 LWB Club S/cab P/up Pet. (94-98), 2.0 LWB Std. P/ up, 2.0i LWB Hi-Line, 2.4i LWB Hi-Line Rodeo S-/D/cab, Hi-Line/Rider P/up Pet., 2.5D 4D56 Dies. (98-09), 2.4i LWB Hi-Line D/cab, Trailbuster S/cab, P/up Pet. - 4X4 (98-09), L300 1.6 Mini Bus, Van 4G32 Pet., 1.8 4G62 Pet., 2.0 P/up 4G63 Pet., Starwagon 2.0 S, SL, SLE, P/up, P/van 4G63 Pet. (82-01), Nissan 720 D20 1.8 L18S Kingcab, Sport, 2.2D SD/Z22 Tracker, 2.3 SD23 (80-88), B140 1.4 A14SP/van, S/W, Deluxe, Std. Sport, CHAMP P/up (80-93), E20 1.8 L18 Bus, P/van Coach, Coach GL, GLE, Econolux, Ekonovan, Ekonowagon, 2.0 Bus, Van H20 (80-96), Laurel C31 2.0 CA/L20, 2.8 SGL 5L28 (80-87), Stanza 1.6 DL, Resort, S/W L16, 1.8 GL, Resort, S/W SSS L18 (80-84), Opel Rekord 2.0 Berlina, GL, GLS, L, S/W CIH, 2.0i CLE, CLS, GL, GLE, Irmscher, 2.2E CIH, 380i, V6 CD, GSi 38GE (82-95), Toyota Condor 1.6 Estate, TE, 5L, 1.8 2Y, 2.0i Estate, TE, 1RZ Pet., 2.4i Estate, TE, TX 2RZ-E, 3.0D Estate, TE, 5L Dies. - 4X2, 2.4i Estate, TX Estate 2RZ-E, 3.0 Estate, TX Estate 5L - 4X4 (00-05), Corolla RWD TE31 1.6 Sprinter, SR4/5, Black Hawk, Silver Wolf 2T, AE/TE71 1.6 GL, S/W, GLS Sprinter, SE 2T, TB TE72, 1.8 GLS, SE 3T (80-88), TE71 1.6 P/van 2T (83-89), KE70 1.3 P/van 4K (84-88), Cressida TX30 1.8 DX 3T, TX62 1.8 L, LS 3T, YX70 1.8 LS, Exec. (80-89), RX60 2.0 GL, GLE, GLX, S/W 21R, RX70, YX72 2.0 GL, GL, GLE, GLX (81-92), RX72 2.4 GL, GL S/W, GLE, GLE S/W 22R (87-92), Hiace YH50/60 1.8 SWB / LWB P/van, LS Wagon 2Y Pet. (83-91), YH51/61 2.0 SWB/LWB 16 Seater Commuter, Super 10 Seater Custom Wagon, P/van 3Y Pet. (83-86), YH53/63 2.2 SWB/LWB P/van, Van, LS, Super T/14/16, GLX, Exec. Wagon, Siyaya Bus, P/van 4Y Pet. (All Local Models) (88-09), Hilux LN30/40/50/51/55 2.2 SWB/LWB P/up L Dies., 2.4 SWB/LWB D/cab, Raider P/up 2L Dies., YN58 2.2 LWB D/cab, Raider, SRX P/up 4Y Pet. (79-98), YN67 2.2 LWB D/cab, Raider D/cab P/up 4Y Pet. - 4X4 (86-94), YN51/56 1.8 SWB/LWB D/cab, S, SR, Raider P/up 2Y Pet., YN140 1.8 SWB/LWB D/cab, Raider, S, SRX P/up 2Y Pet. (86-05), LN65 2.4 LWB D/cab, Raider D/cab P/up 2L Dies. - 4X4 (89-98), RN67 2.4 LWB D/cab, Raider D/cab P/up 22R Pet. - 4X4 (94-98), RN58 2.4 22R Pet., LN140/145 2.4iDLX, P/up 2L Dies., RZN194 2.7i LWB D/cab, Raider, SRX, Legend35 Raider, 3RZFE Pet. (94-05), LN57 2.8D LWB D/cab, Raider P/up 3L Dies. - 4X2, LN67 2.8D LWB, D/cab, Raider D/ cab P/up 3L Dies. - 4X4 (95-98), RZN147 2.0 SWB/LWB D/cab, DLX, Raider, S, SR, SRX P/up 1RZ Pet., LN192R 3.0D LWB Raider D-E, Raider DLX D/cab D-E, Legend35 Raider, P/up 5L Dies., 3.0iD LWB Raider, Raider D/cab, P/up KZ-TE Dies. (98-05), RZN169 2.7i LWB D/cab, DLX S/cab, Raider S/D/cab, SRX D/cab, Legend 35 LWB P/up 3RZFE Pet. - 4X4 (98-05), Stallion KF50 1.5 SR5, Commuter, Bus, P/up, P/van 5K Pet., YF50 1.8 SR5, P/up, P/van, Van 2Y Pet., LF50 2.4D P/ up 2L5F Dies. (87-04), Tuv KF20 1.3 Chassis Cab, P/up, P/van, Bus 4K Pet., 1.5 P/up 5K Pet. (82-87), Venture YF50 1.8 8/10 Seater P/van 2Y Pet., 2.2 10 Seater, GLE, Getaway 9 Seater S/W 4Y Pet., LF50 2.4D 10 Seater S/W 2L5F Dies. (91-04)</p>
<p><b>2825</b></p>	<p>Rear Main Bearing Oil Seal</p>	<p>Ford Bantam 1300 P/up Kent 2V (83-94), Cortina MkIII 1.6 L P/up Kent, 1.6 L, Std., XL Kent, 2.0 OHC GT, V4 L, XL, S/W Essex EV20, 2.0 V4 P/up Koln T20, 2.5 L P/up Essex EV25, 2.5 XL, S/W Essex EV25, 3.0 GT, L, XL, XLE "Big Six" Essex EV30 (71-77), Cortina MkIV 1.3 L Kent, 1.6 GL, L, S/W Kent, 1.6 P/up Kent, 2.0 GL, GLE, S/W Koln T20, 3.0 V6 Ghia, GLS, S, S/W Essex EV30, 3.0 V6 Leisure, P/up Essex EV30 (77-80), Cortina MkV 1.3 L Kent, 1.6 GL, L, Kent, 1.6 P/up Kent, 2.0 Ghia, GL Koln T20, 2.4 P/up York D24, 3.0 V6 GLS, GLS XR6, Essex EV30, 3.0 V6 Leisure P/up Essex EV30 (80-86), Courier 3.0 V6 D/cab, Explorer, L, Leisure, Std., P/up Essex (86-97), 3.4 V6 Leisure D/cab, P/up Essex. - 4X2, 3.0 V6 Std., XLT, D/cab, Leisure, Explorer, Exec. P/up Essex., 3.4 V6 Leisure, P/up Essex. - 4X4 (97-01), Escort RWD Mkl 1.1 Kent, 1.3 GT, L, Super, S/W Kent, 1.6 GT, L, XL Kent (68-75), Mkl/III 1.1 300 P/van Kent, 1.3 30, 35, 45 P/van Kent, 1.6 45 P/van Kent (68-81), Escort RWD MkII 1.3 L Kent, 1.6 GL, Sport Kent RS2000 Koln (75-81), Fiesta I 1.3, i Flair, Flite, Play, Fun Endura-EM5 (97-04), Ikon 1.3, Low, LX CLTA, 1.6i, Low, High, LX, CLX CLTA (01-06), Sapphire 1.6 L Kent, 2.0, i GL, GLE, GLEA, GLi, GLi Exec. Koln, 3.0 Ghia, GLX Essex (89-93), Sierra 1.6 GL, GL S/W, L Kent, 2.0 GL, GL S/W Koln, 2.0 LX Koln, 3.0, i GLS, GLX, LX, RS, XR6 Essex (83-93), Mazda 121 Soho 1.3, i 3/5 Dr. H/back Endura-EM5 (97-99), B-Series B3000 3.0 V6 LWB D/cab, Magnum Drifter P/up Essex Pet. - 4X2, 4X4 (86-97), B3400 3.4 V6 LWB Magnum D/cab P/up Essex Pet. - 4X2, 4X4 (96-01), Rustler 1.3 SWB P/up Kent 2V Pet. (86-94)</p>
<p><b>2838</b></p>	<p>Gearbox Oil Seal, Timing Cover / Cam Oil Seal</p>	<p>BMW M5 Coupe M30, M5 Coupe MS38 (86-94), Ford Cortina MkIII 1.6 L P/up Kent, 1.6 L, Std., XL Kent, 2.0 OHC GT, V4 L, XL, S/W Essex EV20, 2.0 V4 P/up Koln T20, 2.5 L P/up Essex EV25, 2.5 XL, S/W Essex EV25, 3.0 GT, L, XL, XLE "Big Six" Essex EV30 (71-77), Cortina MkIV 1.3 L Kent, 1.6 GL, L, S/W Kent, 1.6 P/up Kent, 2.0 GL, GLE, S/W Koln T20, 3.0 V6 Ghia, GLS, S, S/W Essex EV30, 3.0 V6 Leisure, P/up Essex EV30 (77-80), Cortina MkV 1.3 L Kent, 1.6 GL, L, Kent, 1.6 P/up Kent, 2.0 Ghia, GL Koln T20, 2.4 P/up York D24, 3.0 V6 GLS, GLS XR6, Essex EV30, 3.0 V6 Leisure P/up Essex EV30 (80-86), Escort RWD Mkl 1.1 Kent, 1.3 GT, L, Super, S/W Kent, 1.6 GT, L, XL Kent (68-75), Mkl/II 1.1 300 P/van Kent, 1.3 30, 35, 45 P/van Kent, 1.6 45 P/van Kent (68-81), Escort RWD MkII 1.3 L Kent, 1.6 GL, Sport Kent RS2000 Koln (75-81), Sapphire 1.6 L Kent, 2.0, i GL, GLE, GLEA, GLi, GLi Exec. Koln, 2.3 GLE, Cologne, 3.0 Ghia, GLX Essex (89-93), Sierra 1.6 GL, GL S/W, L Kent, 2.0 GL, GL S/W Koln, 2.0 LX Koln, 3.0, i GLS, GLX, LX, RS, XR6 Essex (83-93), Honda Civic SO3 150i Luxline, Spreline D15Z4, 160i Luxline, V-Tec D16Z (96-00), Civic VII 150i, 170i V-Tec (03-06), CR-V 2.0 5 Dr. SUV B20Z1, CR-V CTDi 4X4 ((1997-))</p>
<p><b>3051</b></p>	<p>Oil Seal</p>	<p>Vauxhall Seal</p>



## BUYERS GUIDE - OIL SEALS

<b>4250</b>	Gearbox Oil Seal Rear	Ford Cortina MkIII 2.0 OHC GT, V4 L, XL, S/W Essex EV20, 2.0 V4 P/up Koln T20, 2.5 L P/up Essex EV25, 2.5 XL, S/W Essex EV25, 3.0 GT, L, XL, XLE "Big Six" Essex EV30 (71-77), Cortina MkIV 3.0 V6 Ghia, GLS, S, S/W Essex EV30 (77-80), Cortina MkV 3.0 V6 GLS, GLS XR6, Essex EV30 (80-86), Courier 3.0 V6 D/cab, Explorer, L, Leisure, Std., P/up Essex (86-97), Sierra 2.3 GLE, Cologne (83-93), Mazda B-Series B3000 3.0 V6 LWB D/cab, Magnum Drifter P/up Essex Pet. - 4X2, 4X4 (86-90)
<b>4465</b>	Front Wheel Oil Seal Inner, Outer	Chevrolet 2500 (73-78), 3800 (72-78), 4100 (72-78), Commodore 2.8, 3.8, 4.1 (78-88), Senator 4.1 (79-82)
<b>4500</b>	Gearbox Oil Seal Rear	Ford Cortina MkIII 1.6 L P/up Kent, 1.6 L, Std., XL Kent, 2.0 OHC GT (71-77), Cortina MkIV 1.6 GL, L, S/W Kent, 1.6 P/up Kent, 2.0 GL, GLE, S/W Koln T20 (77-80), Cortina MkV 1.6 GL, L, Kent, 2.0 Ghia, GL Koln T20 (80-86), Escort RWD Mkl 1.1 Kent, 1.3 GT, L, Super, S/W Kent, 1.6 GT, L, XL Kent (68-75), Escort Mkl/II 1.1 300 P/van Kent, 1.3 30, 35, 45 P/van Kent, 1.6 45 P/van Kent (68-81), Escort RWD MkII 1.3 L Kent, 1.6 GL, Sport Kent, RS2000 Koln (Local) (75-81)
<b>5043</b>	Timing Cover, Cam Oil Seal	Ford Cortina MkIII 1.6 L P/up Kent, 1.6 L, Std., XL Kent (71-77), Cortina MkIV 1.3 L Kent 1.6 GL, L, S/W Kent, 1.6 P/up Kent (77-80), Cortina MkV 1.3 L Kent, 1.6 GL, L, Kent, 1.6 P/up Kent (80-06), Escort RWD Mkl 1.1 Kent, 1.3 GT, L, Super, S/W Kent, 1.6 GT, L, XL Kent (68-75), Escort Mkl/II 1.1 300 P/van Kent, 1.3 30, 35, 45 P/van Kent, 1.6 45 P/van Kent (68-81), Escort RWD MkII 1.3 L Kent, 1.6 GL, Sport Kent (75-81)
<b>5046</b>	Drive Shaft Oil Seal	Leyland 11/55 1.1 (65-72), 1100 (65-68), Apache 1.3 (71-78), Mini 1.1, 1275, 1.0 (65-84)
<b>5048</b>	Timing Cover, Cam Oil Seal	Leyland 11/55 1.1, 1100, Apache 1.3, Marina 1.3, 1.8, 1750, 2.6, Mini 1.0, 1.1, 1275, 850
<b>5056</b>	Gearbox Oil Seal / Pinion Oil Seal	Chevrolet 2500 (73-78), 3800 (72-78), 4100 (72-78), Commodore 2.8, 3.8, 4.1 (78-82), Constantia 4.1, 5.0 (69-78), De Ville 5.0 (72-75), Firenza 2.5 73-75), Hatch 1.9 (76-78), Kommando 4.1 (69-78), Rekord 2.0, 2.3 (78-82), Senator 4.1 (79-82), C10 (74-80), El Camino 4.1, 5.0 (72-78), Ford Granada 2.0, 2.5, 3.0 (72-86), Hillman Arrow 1618 (68-71), Hunter 1618 (67-75), Vogue 1618, 1971 (67-77)
<b>9035FS</b>	Rear Main Bearing Oil Seal	BMW 530d (2004-), X3 3.0d (06-10)
<b>9036</b>	Timing Cover Oil Seal	Chevrolet Spark 1.2 (03-10)
<b>9037</b>	Timing Cover Oil Seal	Chevrolet Cruze 1.6, 1.8 (09-15), Optra 1.8 (04-11), Orlando (2011-), Sonic 1.6 (11-15), Opel Astra G 1.6 (99-06), Astra H 1.4, 1.6, 1.8 (04-10), Astra J 1.6 (2010-)
<b>9038</b>	Timing Cover Oil Seal	Chevrolet Cruze 2.0D (09-15), Captiva 2.2D - 4X2, 4X4 (11-17)
<b>9039</b>	Rear Main Bearing Oil Seal	Hyundai Accent 1.6 G4FG Pet. (2017-), i10 (PA) 1.2 G4LA (08-15), Grand i10 1.1 G3LA, 1.2 G4LA (14-19), Grand i10 III 1.0 Mpi G3LA, G3LD Pet. (2019-), Jeep Cherokee (KJ) 2.4 KJ EDI (02-08), Kia Picanto III (JA) 1.0 G3LA, G3LD Pet., 1.2 G4LA Pet. (2017-), Rio IV 1.2 G4LA Pet., 1.4 G4LC Pet. (2017-)
<b>9040</b>	Timing Cover / Rear Main Bearing Oil Seal	Chrysler Neon 2.0 (02-06), Jeep Cherokee 2.8 (02-08)
<b>9041</b>	Rear Main Bearing Oil Seal	Chrysler PT-Cruiser 2.2 CRD, EDJ Dies. (02-09), Hyundai Accent RB 1.6 G4FC (2011-), i20 PB/PBT 1.2 G4LA, 1.4 G4FA, 1.6 G4FC (2009-), i30 FD/GD 1.6 G4FG, G4GG (2010-), Kia Cerato 1.6 LX G4FC (04-08), 1.6 LX G4FC (2008-)
<b>9042</b>	Timing Cover Oil Seal	Chrysler PT-Cruiser 2.2 CRD (02-09), Jeep Grand Cherokee 2.7, 3.0 (2002-), Mercedes-Benz SLK320, 32 AMG (02-04), SLK200K, SLK350, SLK55 AMG (04-11), SLK250, SLK350, SLK55 AMG (2011-), W204 Series C180, 200, W212 Series E200, CGI, 350, CDI, 500 (07-14), Sprinter BM906 Series, Vito/Viano (2006-)
<b>9043</b>	Drive Shaft Oil Seal	Fiat 500L 1.2, 1.4 (08-15), Grande Punto 1 1.2, 1.4 (06-10), Grande Punto 2 1.2, 1.4 (08-11)
<b>9044</b>	Timing Cover Oil Seal	Fiat 500L 1.2, 1.4 (08-15), Grande Punto 1 1.2, 1.4 (06-10), Grande Punto 2 1.2, 1.4 (08-11)
<b>9045</b>	Cam Oil Seal	Fiat 500L 1.2, 1.4 (08-15), Grande Punto 1 1.4 (06-10), Grande Punto 2 1.4 (08-11)
<b>9046</b>	Rear Main Bearing Oil Seal	Fiat 500L 1.4 (08-15), Grande Punto 1 1.4 6 Spd. (06-10), Grande Punto 2 1.4 6 Spd. (08-11)
<b>9047</b>	Cam Oil Seal	Fiat Grande Punto 1 1.2 (06-10), Grande Punto 2 1.2 (08-11)
<b>9048</b>	Drive Shaft Oil Seal	Fiat Grande Punto 1 1.3D (06-10)
<b>9049</b>	Drive Shaft Oil Seal	Fiat Grande Punto 1 1.3D (06-10)
<b>9050</b>	Drive Shaft Oil Seal	Fiat Grande Punto 1 1.4 (06-10), Grande Punto 2 1.4 (08-11)
<b>9051</b>	Drive Shaft Oil Seal	Fiat Grande Punto 1 1.9D (06-10), Opel Adam 1.4 (2014-), Mokka (2015 -)
<b>9052</b>	Cam Oil Seal	Fiat Punto 1.8 (04-13)
<b>9053</b>	Timing Cover / Cam Oil Seal	Fiat Punto 1.8 (04-13), Opel Astra H 1.9 (04-10)
<b>9054</b>	Timing Cover Oil Seal	Ford Focus III 2.0 (09-14), Kia Sportage 2.7 - 4X4 (04-10)
<b>9055</b>	Cam Oil Seal	Citroen Picasso 2.0Hdi (03-06), Xsara 2.0Hdi (03-08), Ford Focus II 2.0 TDCi (05-09), Focus III 2.0 TDCi (09-14), Land Rover Freelander II 2.2 (2007-), Peugeot 206 2.0Hdi (04-06), 308 2.0Hdi (2008- ), Partner 2.0Hdi (2003-), Volvo S40 2.0D (2004-)
<b>9056</b>	Timing Cover Oil Seal	Citroen Picasso 2.0Hdi (03-06), Xsara 2.0VTi, HDi (03-08), Berlingo 1.9D (03-15), Ford Focus II 2.0 TDCi (05-09), Focus III 2.0 TDCi (09-14), Land Rover Freelander II 2.2 (2007-), Peugeot 308 2.0Hdi (2008-), 3008 2.0 HDi (2010-), Partner 1.9 D, 2.0 HDi (2003-), Volvo S40 2.0D (2004-)

## BUYERS GUIDE - OIL SEALS

<b>9057</b>	Rear Main Bearing Oil Seal	Ford Focus II 2.0 TDCi (05-09), Focus III (09-14), Land Rover Freelander II 2.2 (2007-), Peugeot 308 2.0 Hdi (2008-), 2.0 HDi (2010-), Partner 1.9D, 2.0 HDi (2003-), Volvo S40 2.0D (2004-)
<b>9058</b>	Rear Main Bearing Oil Seal	Ford Mondeo 3.0 (02-07)
<b>9059</b>	Timing Cover Oil Seal	Ford Mondeo 3.0 (02-06)
<b>9060</b>	Timing Cover / Cam Oil Seal	Chevrolet Captiva 3.0 - 4X2, 4X4 (11-17), Land Rover Defender 90 2.2, 2.4 (2002-), Peugeot Boxer 3.0 Hdi (2006-)
<b>9061</b>	Use - 9061FS	
<b>9062</b>	Rear Main Bearing Oil Seal	Fiat Strada 1.6 (05-10)
<b>9063</b>	Timing Cover Oil Seal	Jeep Cherokee 3.7 (02-15), Grand Cherokee 3.7, 4.7 (2002-)
<b>9064</b>	Rear Main Bearing Oil Seal	Jeep Cherokee 3.7 (02-08), Grand Cherokee 3.7, 4.7 (2002-)
<b>9065</b>	Rear Main Bearing Oil Seal	Dodge Nitro - 4X4 (07-10), Jeep Cherokee 3.7 (08-15), Grand Cherokee 3.0 (2002-)
<b>9066</b>	Timing Cover Oil Seal	Hyundai Accent RB (2002-), i20 PB/ PBT (09-12), i30 FD/ GD 1.6 (2010-), Kia Cerato 1.6 (04-08), Cerato 1.6 (2008-), Rio III 1.4 (2011-), Soul 1.6 (2009-)
<b>9067</b>	Rear Main Bearing Oil Seal	Hyundai H1 2.5 (2009-), Kia Sorento (03-06)
<b>9068</b>	Timing Cover Oil Seal	Hyundai H1 2.5 (2009-), Kia Sorento (03-06)
<b>9069</b>	Timing Cover Oil Seal	Kia Sorento 2.2 (2006-)
<b>9070</b>	Rear Main Bearing Oil Seal	Kia Sorento 2.2 (2006-)
<b>9072</b>	Timing Cover Oil Seal	Land Rover Defender 2.5 Td (2002-), Discovery II 2.5 (04-05)
<b>9074</b>	Rear Main Bearing Oil Seal	Land Rover Discovery II 4.0 (04-05)
<b>9075</b>	Timing Cover Oil Seal	Land Rover Discovery II 4.0 (04-05)
<b>9076</b>	Cam Oil Seal	Land Rover Discovery III, IV (05-09)
<b>9078</b>	Front Wheel Oil Seal Inner	Mahindra Bolero - 4X2, 4X4, Scorpio (2005-), Scorpio P/up (2006-)
<b>9079</b>	Timing Cover / Rear Main Bearing Oil Seal	Mazda BT-50 2.5, 3.0 - 4X2, 2.6, 3000 - 4X4 (07-12)
<b>9080</b>	Timing Cover Oil Seal	Mazda CX-3 2.0 PEX3 (2015-), CX-5 2.0 PEY4 (12-15)
<b>9081</b>	Rear Main Bearing Oil Seal	Mercedes-Benz W176 A-Class 180 CDi, 220CDi (2013-), W246 B-Class 180 CDi, 200 CDi (2012-), W204 C-Class 220 CDi, 250 CDi, 350 Cdi (07-14), W212 E-Class 250 CDi (2009-)
<b>9084</b>	Timing Cover Oil Seal	Mitsubishi Lancer 1.5 (2007-)
<b>9085</b>	Rear Main Bearing Oil Seal	Mitsubishi Lancer 1.5 (2007-)
<b>9086</b>	Rear Main Bearing Oil Seal	Mitsubishi Lancer Evo-X (2007-)
<b>9087</b>	Rear Main Bearing Oil Seal	Mitsubishi Pajero 3500 - 4X4 (02-07)
<b>9088</b>	Rear Main Bearing Oil Seal	Mitsubishi Pajero 3.8 - 4X4 (02-06), Pajero 3.8 - 4X4 (2007-)
<b>9090</b>	Rear Main Bearing Oil Seal	Peugeot Boxer 3.0 Hdi (2006-)
<b>9091</b>	Cam Oil Seal	Renault Clio III (06-10), Fluence 1.6 (2011-), Megane III 1.6 (2010-), Scenic III 1.6 (11-13)
<b>9093</b>	Rear Main Bearing Oil Seal	Toyota Avensis (06-08), Camry II 2.4 (01-06)
<b>9094</b>	Timing Cover Oil Seal	Toyota Avanza 1.3, 1.5 (12-16), C-HR 1.2 T (2017- ), Etios (2012-)
<b>9095</b>	Rear Main Bearing Oil Seal	Toyota Avanza 1.3 S, SX MPV 1NRVE, 1.3 S P/Van 1NRVE, 1.5 SX, TX MPV 2NRVE (2015-), Etios (2012-)
<b>9096</b>	Rear Main Bearing Oil Seal	GWM CB150 (10-13), Florid (09-13), Toyota Yaris 1.3 ZEN 3, 1.5 (2012-)
<b>9097</b>	Rear Main Bearing Oil Seal	VW Crafter - 4X4 (2007-)
<b>9098</b>	Rear Main Bearing Oil Seal	Suzuki Alto 1.0 (2009-), Celerio 1.0 K10B (2015-), Swift 1.2 (2010-)
<b>9099</b>	Side Shaft Rear Inner Oil Seal	Nissan NV350 2.5, 2.5D (2013-)
<b>9100</b>	Cam Oil Seal	Volvo S40 D4, D5 (2004-), S60 2.4 D5 (01-08), S60, V60 2.0 D3, D4, 2.4 D5 (2010-), V40 1.8 D3, 2.0 T5 (2012-)
<b>9101</b>	Rear Main Bearing Oil Seal	Volvo S60, V60 2.4 D5, V40 2.0 D3, T5 (2011-)
<b>9102</b>	Timing Cover Oil Seal	Volvo XC60 3.0T (09-10), XC60 T6 (10-14), XC90 3.2 (07-11)
<b>9103</b>	Rear Main Bearing Oil Seal	Volvo XC60 3.0T (09-10), XC60 (10-14), XC90 T6 3.2 (07-11)
<b>9104</b>	Drive Shaft Oil Seal	Chevrolet Aveo 1.5 L, LS, LT, 1.6 LS (03-15), Daewoo Matiz 800cc S, SE F8CV (99-03), Ford Focus 2.5 ST. HYDA (05-09), Opel Adam 1.0T Jam, Glam, Rocks B10XFT (2014-), Toyota Etios 1.5 xi/xs 5-door (12-13)

## BUYERS GUIDE - OIL SEALS

<b>9105</b>	Rear Main Bearing Oil Seal	Toyota Hardbody QW/D22 2.7D TD27i, 3.0 i VG30E, 3.0TD ZD30, 3.2 QD32, 3.3i VG33E - 4X2 (98-10), 2.4i KA24E, 2.7 TD27, 3.0 VG30E, 3.0TD ZD30, 3.2D QD32, 3.3i VG33 - 4X4 (98-10), NP300 D22 2.0i, S, SE KA20, 2.5TDi, S, SE YD25, 2.4i, S/C, D/C Highrider KA24 DE, 2.5TDi, S, SE Highrider YD25 - 4X2, 2.4i, S/C, D/C, Highrider KA24 DE, 2.5TDi, S, SE, Highrider YD25 - 4X4 (2008-),
<b>9107</b>	Front Wheel Oil Seal	Nissan Hardbody NP300 - 4X4 (2008-)
<b>9108</b>	Drive Shaft Oil Seal	Toyota Fortuner 3.0 D-4D, 4.0 V6 (2006-), Hilux "Vigo" 2.5TDi, 2.7i, 3.0, 4.0 - 4X2, 4X4 (2005-)
<b>9109</b>	Drive Shaft Oil Seal	Toyota Fortuner 3.0 D-4D, 4.0 V6 (2006-), Hilux "Vigo" 2.5TDi, 2.7i, 3.0, 4.0 - 4X4 (2005-)
<b>9110</b>	Drive Shaft Oil Seal	Nissan NP200 1.5DCi (2008-)
<b>9112</b>	Rear Main Bearing Oil Seal	Mitsubishi Triton 2.5 Di-D (2007-)
<b>9113</b>	Front Wheel Oil Seal	Toyota Hilux RZN169 2.7i LWB D/cab, DLX S/cab, Raider S/D/cab, SRX D/cab, Legend 35 LWB P/up 3RZFE Pet., LN167 3.0D D/cab D-E, DLX, S/D/cab DE, Raider DE, Legend35 LWB P/up 5L Dies., 3.0iD LWB Raider S/cab & KZ-TE D/cab P/up, Legend35 - 4X4 (98-05)
<b>9114</b>	Use - 9403	
<b>9115</b>	Drive Shaft Oil Seal	Toyota C-HR 1.2 T (2017-)
<b>9116</b>	Rear Gearbox Oil Seal / Extension Housing Oil Seal	Toyota Hilux "Revo" 2.4, 2.8, 4.0 - 4X4 (2016-)
<b>9117</b>	Drive Shaft Oil Seal	Toyota Fortuner 2.4, 2.5D-4D, 2.7i, 2.8TD, 3.0D, D-4D, 4.0 - 4X4 (11-16), Hilux "Revo" 2.4, 2.8, 4.0 - 4X4 (2016-)
<b>9118</b>	Front Gearbox Oil Seal (Transfer case)	Toyota Fortuner 2.4, 2.7i, 2.8TD, 3.0D-4D, 4.0, V6 - 4X2, 4X4 (11-16)
<b>9119</b>	Rear Gearbox Oil Seal (Extension housing)	Toyota Fortuner 2.4, 2.5D-4D Auto., 2.7i, 2.8TD, 3.0D-4D, 4.0, V6 - 4X2, 4X4 (11-16), Hilux "Revo" 2.8, 4.0 - 4X2, 4X4 (2016-)
<b>9120</b>	Pinion Oil Seal	Toyota Fortuner 2.4, 2.7i, 2.8TD, 3.0D-4D, 4.0 - 4X4 (11-16), 2016- "Revo" 2.0, 2.4, 2.7, 2.8, 4.0 - 4X2, 4X4 (2016-)
<b>9121</b>	Front Gearbox Oil Seal	Toyota Avanza 1.3, i, 1.5, i (06-16)
<b>9122</b>	Rear Gearbox Oil Seal	Toyota Avanza 1.3, i, 1.5, i (06-16)
<b>9123</b>	Rear Gearbox Oil Seal (Extension housing)	Toyota Avanza 1.3i, 1.5i (06-12), 1.3, 1.5 Man. (15-16)
<b>9124</b>	Pinion Oil Seal	Toyota Avanza 1.3, i, 1.5, i (06-16)
<b>9125</b>	Rear Gearbox Oil Seal (Extension housing)	Toyota Avanza 1.3, 1.5 Auto. (15-16)
<b>9126</b>	Timing Cover Oil Seal	Nissan Hardbody QW/ D22 3.0TD ZD30, ZD30D, ZD30DDT - 4X2, 4X4 (98-10), Terrano II 2.7 TD27 (00-02)
<b>9127</b>	Front Wheel Oil Seal Inner	Chevrolet Trailblazer 2.5D 4X2, 2.8D 4X2/4X4, 3.6 4X4 (12-14)
<b>9128</b>	Front Wheel Oil Seal Outer	Chevrolet Trailblazer 2.5D - 4X2, 2.8D - 4X2, 4X4, 3.6 - 4X4 (12-14)
<b>9129</b>	Rear Wheel Oil Seal Inner	Chevrolet Trailblazer 2.5D - 4X2, 2.8D - 4X2, 4X4, 3.6 - 4X4 (12-14)
<b>9130</b>	Rear Wheel Oil Seal Outer	Chevrolet Trailblazer 2.5D - 4X2, 2.8D - 4X2, 4X4, 3.6 - 4X4 (12-14)
<b>9131</b>	Drive Shaft Oil Seal	Mazda 3 (BM) 2.0 (2014-), 6 GJ 2.0, 2.2D, 2.5 (14-17), CX-3 2.0 (2015-)
<b>9132</b>	Drive Shaft Oil Seal	Mazda 3 (BM) 2.0 (2014-), 6 GJ 2.0, 2.2D, 2.5 (14-17), CX-3 2.0 (2015-)
<b>9133</b>	Front Gearbox Oil Seal	Toyota Hilux "Revo" 2.4, 2.8 - 4X2, 4X4 (2016-)
<b>9134</b>	Pinion Oil Seal	Toyota Hilux "Revo" 2.0, 2.4, 2.8, 4.0 - 4X2, 4X4 (2016-)
<b>9135</b>	Drive Shaft Oil Seal	Toyota Hilux "Revo" 2.0, 2.4, 2.7, 2.8, 4.0 - 4X2, 4X4 (2016-)
<b>9136</b>	Drive Shaft Oil Seal	Toyota Hilux "Revo" 2.0, 2.4, 2.7, 2.8, 4.0 - 4X2, 4X4 (2016-)
<b>9140</b>	Front Wheel Oil Seal Outer	Mitsubishi Pajero 3.2DI-D 4X4 (10-13)
<b>9141</b>	Pinion Oil Seal	Nissan NV350 2.5 QR25DE, 2.5D YD25DDTi (2013-)
<b>9142</b>	Rear Main Bearing Oil Seal	BMW F30 318i, 320i, 330i, 340i Sport (2015-)
<b>9146</b>	Front Gearbox Oil Seal	BMW F30 340i Sport Man., F34 Gran Turismo 320d 2.0 (2015-)
<b>9147</b>	Rear Gearbox Oil Seal	BMW F30 340i Sport Man., F34 Gran Turismo 320d (2015-)
<b>9148</b>	Front Gearbox Oil Seal	BMW F30 340i Sport (2015-)
<b>9156</b>	Rear Main Bearing Oil Seal	Chevrolet Captiva 3.0 LTZ - 4X2, 4X4 (11-17)
<b>9157</b>	Rear Main Bearing Oil Seal	Toyota C-HR 1.2 T (2017-)
<b>9158</b>	Drive Shaft Oil Seal	Nissan Datsun Go/Go+ 1.2 HR12D (2014-)
<b>9159</b>	Timing Cover Seal / Front Crank	Renault Kwid 1.0 B4D 404 (2015-)

# BUYERS GUIDE - OIL SEALS

<b>9160</b>	Rear Main Bearing Oil Seal	Renault Kwid 1.0 B4D 404 (2015-)
<b>9161</b>	Rear Drive Shaft Seal	Renault Kwid 1.0 B4D 404 (2015-)
<b>9162</b>	Drive Shaft Oil Seal	Suzuki Swift 'RS' 1.5 RS415, 1.6 RS416 Man. (08-11), 'AZG' 1.2 AZG12 (11-18)
<b>9163</b>	Spigot Shaft Seal	Suzuki Swift 'AZG' 1.2 AZG412 (11-18)
<b>9164</b>	Spigot Shaft Seal	Suzuki Swift AZG/AZH 1.4, 1.6 (11-18)
<b>9165</b>	Drive Shaft Oil Seal	Suzuki Swift 1.4 AZG/AZH, 1.6 M16A (11-18)
<b>9166</b>	Drive Shaft Oil Seal	Suzuki Swift 1.6 M16A (11-18)
<b>9167</b>	Timing Cover Seal / Front Crank	Suzuki SX4 'RW' 2.0 J20A (08-14)
<b>9168</b>	Rear Main Bearing Oil Seal	Suzuki SX4 'RW' 2.0 J20A (08-14)
<b>9169</b>	Drive Shaft Oil Seal	Suzuki SX4 'RW' 2.0 J20A, J20B (5 speed) (08-14)
<b>9170</b>	Timing Cover Seal / Front Crank	Suzuki SX4 'RW' 2.0 J20B (08-14)
<b>9171</b>	Rear Main Bearing Oil Seal	Suzuki SX4 'RW' 2.0 J20B (08-14)
<b>9172</b>	Spigot Shaft Seal	Suzuki SX4 1.6 M16A (6 speed) (14-16)
<b>9173</b>	Drive Shaft Oil Seal	Suzuki SX4 1.6 M16A (6 speed) (14-16)
<b>9174</b>	Use - 9356	
<b>9175</b>	Use - 9646	
<b>9176</b>	Use - 9699	
<b>9178</b>	Pinion oil seal	Nissan X-Trail T32 1.6 Dci R9M, 2.5 QR25DE CVT - 4X4 (2014-)
<b>9179</b>	Drive Shaft Oil Seal	Nissan X-Trail T32 1.6 Dci R9M, 2.5 QR25DE CVT - 4X4 (2014-)
<b>9180</b>	Timing Cover Oil Seal	Nissan X-Trail 2.5 Qr25DE - 4X4 (2014-)
<b>9200</b>	Drive Shaft Oil Seal	Hyundai Sonata 2.0, 2.5, 3.0 (94-02)
<b>9201</b>	Pinion Oil Seal	Toyota Hardbody QW/D22 2.4i KA24E, 2.7 TD27, 3.0 VG30E, 3.0TD ZD30, 3.2D QD32, 3.3i VG33 - 4X4 (98-10), NP300 D22 2.0i, S, SE KA20, 2.4i, S/C, D/C Highrider KA24 DE, 2.5TDi, S, SE Highrider YD25 - 4X2, 2.4i, S/C, D/C, Highrider KA24 DE, 2.5TDi, S, SE, Highrider YD25 - 4X4 (2008-), Patrol Y60 3.0 VG30E - 4X4 (95-00), Y61 3.0Di, 4.2 TD42 - 4X4 (99-04), Terrano II 2.7 TD27 - 4X4 (00-02)
<b>9203</b>	Gearbox Oil Seal Rear	Nissan Hardbody QW/D22 3.0i - 4X2, 3.0 VG30E, 3.0TD ZD30, 3.2, 3.2D QD32, 3.3i VG33 - 4X4 (98-10), NP300 2.4i, S/C, D/C Highrider KA24 DE, 2.5TDi, S, SE YD25 - 4X2, 2.4i, S/C, D/C Highrider KA24 DE, 2.5TDi, S, SE Highrider YD25 - 4X4 (2008-), Patrol Y61 3.0Di, 4.2 TD42 - 4X4 (99-04)
<b>9204</b>	Front Gearbox Oil Seal (Transfer Case Oil Seal)	Nissan Maxima 2.0, 3.0 (97-04), Murano 3.5 SUV (2005-), Qashqai 1.6 dCi Accent Dies. R9M, 1.6 DIG-T Accent Pet. MR16DDT - 4X2, 4X4 (2013-), X-Trail 1.6 Dci R9M - 4X2, 4X4 (2014-)
<b>9205</b>	Rear Wheel Oil Seal Outer	Toyota Land Cruiser 4.5 (98-04)
<b>9207</b>	Rear Main Bearing Oil Seal	Hyundai Atos 1.0 Prime G4HC (00-05), 1.1 G4HG (2005-), i10 PA 1.1 G4HG (08-15), Kia Picanto 1.1 LX, EX 5 Dr. H/back G4HG (04-11), Mercedes-Benz W176 A-Class A180, A180 Cdi, A200, A220 Cdi, A250 (2013-), W204 C-Class C220 Cdi, C250, Cdi, C350, Cdi (07-11), W212 E-Class E250, CDi (2009-), W246 B-Class B180 Cdi, B200 Cdi (2012-)
<b>9208</b>	Drive Shaft Oil Seal	Hyundai Santa Fe 2.4, 2.7 (01-05)
<b>9209</b>	Timing Cover / Cam Oil Seal	Hyundai Elantra J1 1.6 Exec., G4CR, 1.8 Exec., G4CN (93-95), J2 1.6 RD G4GR, 1.8 G4FG, 2.0 G4GC (95-01), XD 1.6 G4ED, 2.0 G4GC, CRDi D4EA (02-07), Getz 1.3 G4EA, 1.4i G4EE, 1.5 D3EA, D4FA, 1.6 G4ED-G (03-12), Tiburon 2.0 G4DF (96-10), Tucson JM 2.0 G4GC, 2.0 CRDi D4EA, 2.7i V6 G6BA-G - 4X2, 4X4 (04-10), Kia Picanto 1.1 LX, EX 5 Dr. H/back G4HG (04-11)
<b>9210</b>	Use - 9868	
<b>9211</b>	Drive Shaft Oil Seal	Nissan Maxima 2.0, 3.0 (97-04), Qashqai 2.0 (07-13), 2.0 I Pet. MR20DD - 4X2 (2013-), X-Trail T32 1.6 Dci R9M - 4X2, 4X4 (2014-)
<b>9212</b>	Pinion Oil Seal	Nissan Hardbody 2.4i, 2.7, 3.2, 3.2D, 3.3 (98-08), Patrol 4.2 (94-04), Terrano II 2.7 (00-02)
<b>9213</b>	Pinion Oil Seal	Nissan Hardbody 3.0 (98-08), NP300 Hardbody 2.4i, 2.5TDi P/up (2008-), Patrol 3.0 (99-04)
<b>9214</b>	Drive Shaft Oil Seal	Toyota Auris 1.8i RS, RX, 2.0Di D-4D RS, RX (2007-), Avensis 2.0i Advanced, 2.2 D4D Exclusive, 2.4i Exclusive (06-09), Camry II 2.0, 2.4i Xli, 3.0 GLX 1MZ-FE (01-06), Corolla FWD 2.0, 2.0D D-4D Advanced, Exclusive (07-14)
<b>9215</b>	Drive Shaft Oil Seal	Toyota Camry 2.2, 2.4i, 3.0 (01-06)
<b>9216</b>	Front, Rear Wheel Oil Seal	Kia K2500i 2.5i D4CB (2013-), K2700i 2.7D Workhorse LWB Dies."Bakkie" D/S (2004-)
<b>9217</b>	Gearbox Oil Seal Rear	Mitsubishi Colt LDV 2.8TDi LWB Pioneer, Rodeo D/cab P/up Turbo Dies., 3.0i V6 LWB Rodeo D/cab P/up Pet. - 4X2, 2.8D, TDi LWB Club cab, Trailbuster S/cab, Rodeo D/cab P/up Dies./ Turbo Dies., 3.0i V6 LWB Rodeo D/cab P/up Pet. - 4X4 (99-09), Triton 3.2 Di-D D/cab P/up, 3.5 Club cab P/up, 3.5 MPi Double cab P/up - 4X2, 4X4 (2007-)



## BUYERS GUIDE - OIL SEALS

<b>9218</b>	Gearbox Oil Seal Rear	Mitsubishi Colt LDV 2.8D LWB Std., Hi line P/up Dies., 2.8TDi LWB Club CabS cab,Turbo, 3.0i V6 LWB Club S/cab P/up Pet. - 4X2 (94-98), 2.4i LWB Hi-Line D/cab, Trailbuster S/cab, P/up Pet. - 4X4 (98-09)
<b>9219</b>	Pinion Oil Seal	Mercedes-Benz E240, E280, E320, E430, E500 (93-04)
<b>9220</b>	Rear Main Bearing Oil Seal	Toyota Corolla FWD F11 140i GLE, GLS, Sprinter 4ZZ-FE, KS1 160i GLE, GLS, GSX, Sprinter VVT-i 3ZZ-FE DOHC, GF2 180i GLE, GLS, GSX, Sprinter VVT-I 1ZZ-FE DOHC (02-08), Corolla Verso ZZE122 160i S, SX MPV, 180i SX, SX MMT, TX, TX MMT MPV 1ZZ-FE (04-09), Corolla FWD 1.4i (2007-), Runx 140i RT, RS, Sport 4ZZ-FE, 160i RS, RT, RX, Sport 3ZZ-FE, 180i RSi, RX 1ZZ-FE (03-08)
<b>9221</b>	Rear Main Bearing Oil Seal	Kia Carens 1.8 (00-02)
<b>9223</b>	Rear Main Bearing Oil Seal	Toyota Hilux RZN194 2.7i LWB D/cab, Raider, SRX, Legend35 Raider, 3RZFE Pet., RZN147 2.0 SWB/LWB D/cab, DLX, Raider, S, SR, SRX P/up 1RZ Pet. (98-05), RZN169 2.7i LWB D/cab, DLX S/cab, Raider S/D/cab, SRX D/cab, Legend 35 LWB P/up 3RZFE Pet. - 4X4 (98-05), Hilux "Vigo" 2.0i U16/17 S/Cab, S, SRX LWB Pet. P/up 1TR-FE Pet., 2.7i S/Cab Raider, D/Cab Raider, S/Cab HO Raised Body LWB P/up 2TR-FE Pet. - 4X2 (05-11), 2.5TDi D-4D S/Cab, D/Cab SRX, Legend40 2KD-FTV Dies. LWB P/up, 2.7i S/Cab SRX, Legend40 2TR-FE Pet. LWB P/up - 4X4 (05-15), 2.7i Raised Body Raider, D/Cab LWB P/up 2TR-FE Pet. (09-11), Hilux 2.0 VVTi 1TR-FE 5 Spd Man. S/cab, 2.7 VVTi 2TR-FE - 4X2 (11-16), Hilux "Revo" 2.0 VVTi 1TR-FE - 4X2 (2016-), Quantum 2.7 "Family", S-long "Ses'fikile" MPV, Van 2TR-FE Pet. (2005-)
<b>9224</b>	Cam Oil Seal For Intake Cam	Toyota Corolla FWD AE93R 180i GL,GLE, GSE, GSX, Sprinter 7A-FE (93-96), AE111R 160i GL,-GLE, RSi, RXi 4A-FE, A-GE, AE112 180i GLE, GSE 7A-FE (96-02), F11 140i GLE, GLS, Sprinter 4ZZ-FE, KS1 160i GLE, GLS, GSX, Sprinter VVT-i 3ZZ-FE DOHC, GF2 180i GLE, GLS, GSX, Sprinter VVT-I 1ZZ-FE DOHC (02-08)
<b>9225</b>	Rear Wheel Oil Seal	Kia K2500i 2.5i D4CB (2013-), K2700i 2.7D Workhorse LWB Dies."Bakkie" D/S (2004-)
<b>9227</b>	Timing Cover Oil Seal	Audi A4 3.2, FSi, S4 3.2 (2005-)
<b>9230</b>	Drive Shaft Oil Seal	Audi A3 1.6 (08-14), Seat Leon 2.0TDi (06-08), VW Caddy 1.6i, 1.9TDi, 2.0SDi (2005-)
<b>9233</b>	Front Gearbox Oil Seal	Audi A4 2.0T FSi, 2.4, 3.0, TDi (2001-), VW Passat 1.9TDi, 2.0 FSi, TFSi, TDi, 2.3 V5, 2.8 Quattro, 3.2 V6 (03-08)
<b>9234</b>	Drive Shaft Oil Seal	VW Passat 2.0 FSi, TFSi, 2.3 V5, 2.8 Quattro (03-08)
<b>9235</b>	Drive Shaft Oil Seal	VW Passat 2.0 FSi, T FSi, 2.3 V5, 2.8 Quattro (03-08)
<b>9236</b>	Timing Cover Oil Seal	Seat Ibiza 1.4 Sport, BXW (06-09), VW Polo 9N 1.6i Comfortline, SE, Classic Comfortline, Tipt Trendline, Classic Lux BTS/ AFV, BAH (02-10), 6R 1.4 CLSA, CLPB, 1.4TSi GTi CTHE (10-15)
<b>9238</b>	Cam oil seal	Seat Ibiza 1.4 Sport, BXW (06-09), VW Polo 9N 1.6i Comfortline, SE, Classic Comfortline, Tipt Trendline, Classic Lux BTS/ AFV, BAH (02-10), 6R 1.4 CLSA, CLPB, 1.4TSi GTi CTHE (10-15)
<b>9239</b>	Drive Shaft Oil Seal	Audi A3 3.2 (2003-), A4 3.2 FSi (2007-), S3 2.0TFSi (07-13), VW Kombi 2.5TDi, 3.2 Caravelle, P/van, P/up (2005-)
<b>9240</b>	Drive Shaft Oil Seal	VW 2005- Kombi 2.5TDi, 3.2 Caravelle, P/van, P/up (2005-)
<b>9241</b>	Timing Cover Oil Seal	Audi A4 2.7, 3.0, TDi (01-05), A4 3.2FSi, Quattro (06-12), A6 2.4 (04-09), A6 2.7T Quattro, TDi, 2.8FSi, 3.0TDi, TFSi, Quattro (00-14), Q5 3.0TDi, 3.2FSi (09-13), Citroen 1.4Hdi, 1.6Hdi (02-10), 1.6 e-HDi (10-15), Picasso 1.6Hdi (03-06), 1.6Hdi (03-08), Berlingo 1.6 (03-15), Ford B-Max 1.0 EcoBoost M1JE, M1JH (2015-), Ecosport 1.5TDCi (2013-), 1.6TDCi (04-09), Fiesta III 1.6TDCi (2008-), Figo 1.4 Dies. (2010-), Ikon 1.4TDCi (07-11), Tourneo / Transit Connect/Grand Connect 1.0 EcoBoost Trend MPV SWB B3GA, 1.5 TDCi Ambiente Dsl P-Van LWB XWGA, 1.6 TDCi Eco-Boost LWB T1GA (2013-), Peugeot 207 1.4, 1.6 HDi, 1.6 Pet. (06-13), 208 1.6Hdi (2012-), 308 1.6i (2008-), 1.6VTi (10-13), 1.6GTi, 308 1.6THP (10-14), 3008 1.6 (2010-), Partner 1.6, HDi (03-10), VW Touareg 2.5TDi, 3.0TDi (04-11), Volvo C30 D2 (08-13), S40 D2 (2004-), V40 1.6 D2 (2012-)
<b>9242</b>	Rear Main Bearing Oil Seal	Audi A4 2.4, 3.0, TDi, Quattro (02-12), Ford Tourneo / Transit Connect/Grand Connect 1.0 Eco-Boost Trend MPV SWB B3GA, 1.5 TDCi Ambiente Dsl P-Van LWB XWGA, 1.6 TDCi EcoBoost LWB T1GA (2013-), VW Touareg 2.5TDi, 3.0TDi (2004-)
<b>9243</b>	Drive Shaft Oil Seal	VW Touareg 2.5TDi, 3.0TDi, 3.6 FSi, 4.2, FSi, 5.0TDi (2004-)
<b>9244</b>	Pinion Oil Seal	VW Touareg 2.5TDi, 3.0TDi, 3.6 FSi, 4.2, FSi, 5.0TDi (2004-)
<b>9245</b>	Drive Shaft Oil Seal	VW Touareg 2.5TDi, 3.0TDi, 3.6 FSi, 4.2, FSi, 5.0TDi – Rear Diff, Without Difflock (2004-)
<b>9246</b>	Drive Shaft Oil Seal	VW Touareg 2.5TDi, 3.0TDi, 3.6 FSi, 4.2, FSi, 5.0TDi – Rear Diff (2004-)
<b>9247</b>	Drive Shaft Oil Seal	VW Touareg 2.5TDi, 3.0TDi, 3.6 FSi, 4.2, FSi, 5.0TDi – Rear Diff, With Difflock (2004-)
<b>9248</b>	Cam Oil Seal	VW Touareg 2.5TDi, 3.0TDi, 3.6 FSi, 4.2, FSi, 5.0TDi – Rear Diff, With Difflock (2004-)
<b>9249</b>	Front Gearbox Oil Seal	BMW X5 E53 3.0i, X3 E83 - All Models, 3 Series E90, 1 Series E87 120d (2006-)
<b>9250</b>	Front Gearbox Oil Seal	BMW X5 3.0d, 3 Series E90 330d (2006-)
<b>9251</b>	Rear Gearbox Oil Seal	BMW X5 3.0d, 3 Series E90 330d (2006-)
<b>9252</b>	Rear Gearbox Oil Seal	BMW 116i, 118i, 120d, 120i, 2005- 323i, 325Ci, 325i, 330d (2004-)
<b>9253</b>	Front Gearbox Oil Seal	BMW 118i, 120d, 130i (2004-), 320d, 320i, 323i, 325Ci, 325i, 330Ci, 330d, 330i, 335i (2005-), X5 3.0d, 4.4i, 4.8iS (2002-)
<b>9254</b>	Rear Gearbox Oil Seal	BMW X5 3.0d, 4.4i, 4.8iS (2002-)



# BUYERS GUIDE - OIL SEALS

<b>9255</b>	Pinion Oil Seal	BMW X3 2.0d, 2.5i, 2.5si, 3.0d, 3.0i, 3.0si (2004-), X5 3.0d, 3.0i, 4.4i, 4.6iS, 4.8iS (2001-)
<b>9256</b>	Drive Shaft Oil Seal	BMW X3 2.0d, 2.5i, 2.5si, 3.0d, 3.0i, 3.0si (2004-), X5 3.0d, 3.0i, 4.4i, 4.6iS, 4.8iS (2001-)
<b>9257</b>	Pinion Oil Seal	BMW 330d, 335i (2005-), X5 3.0d, 3.0i, 4.4i, 4.6iS, 4.8iS (2001-)
<b>9258</b>	Rear Gearbox Oil Seal	BMW 320d (2005-), X3 2.0d, 2.5i, 2.5si (2004-), X5 3.0i (2001-)
<b>9259</b>	Drive Shaft Oil Seal	BMW 330d, 335i (2005-), X5 3.0d, 3.0i, 4.4i, 4.8iS (01-06)
<b>9260</b>	Drive Shaft Oil Seal	BMW 320d, 325Ci, 325i, 330Ci, 330i (2005-), X3 2.0d, 3.0d, 3.0i, 3.0si (2004-), X5 3.0d, 3.0i, 4.4i, 4.6iS (2002-)
<b>9261</b>	Timing Cover Oil Seal	BMW X5 4.4i, 4.8iS (01-06)
<b>9262</b>	Timing Cover Oil Seal	BMW 116i, 118i, 120i, 130i, 135i (2004-), 320i, 323i, 325Ci, 325i, 330Ci, 330i, 335i (2005-)
<b>9263</b>	Front Gearbox Oil Seal	BMW 116i, 118i, 120i (2004-), 320i, 323i, 325Ci, 325i (2005-), Gran Turismo 320i 2.0 Man. (2016-)
<b>9264</b>	Rear Gearbox Oil Seal	BMW 118i, 120i, 130i, 135i (2004-), 325Ci, 325i, 330Ci, 330i, 335i (2005-)
<b>9265</b>	Extension Housing Oil Seal	BMW 118i, 120i, 130i, 135i (2004-), 320i, 323i, 325Ci, 325i, 330Ci, 330i, 335i (2005-)
<b>9266</b>	Gearbox Oil Seal Rear	BMW 3 Series E90 320d 2.0 Sedan & Touring, Start M47, 320i 2.0 Sedan & Touring, Start N46, 323i 2.5 Sedan & Touring, Start N52, 325i 2.5 Sedan & Touring, Start N52, 330Ci, d 3.0 Convertible N52 / M57, 335i, d 3.0 N54 / N55 (05-13), F34 Gran Turismo 320i 2.0 N20, 320d 2.0 B47 (2013-)
<b>9267</b>	Drive Shaft Oil Seal	BMW 118i, 120i, 130i, 135i (2004-), 320i, 323i (2005-), X3 2.5i, 2.5si (2004-)
<b>9268</b>	Rear Main Bearing Oil Seal	BMW Mini 1.6 Cooper, S, CVT - R50/52/53 (2002-)
<b>9269</b>	Timing Cover Oil Seal	BMW Mini 1.6 Cooper, S, CVT - R50/52/53 (2002-), Chevrolet Captiva 2.0D LTZ (07-11), Cruze 2.0D (2009- )
<b>9270</b>	Front Gearbox Oil Seal	BMW Mini 1.6 Cooper, S, CVT - Manual - R50/52 (2002-)
<b>9271</b>	Front Gearbox Oil Seal	BMW Mini 1.6 Cooper, S, CVT - Auto. - R50/52 (2002-)
<b>9272</b>	Rear Gearbox Oil Seal	BMW Mini 1.6 Cooper, S, CVT- Manual - R50/52 (2002-)
<b>9273</b>	Drive Shaft Oil Seal	BMW Mini 1.6 Cooper, S, CVT - R50/52 (2002-)
<b>9274</b>	Rear Gearbox Oil Seal	BMW Mini 1.6 Cooper, S, CVT- Manual - R53 (2002-)
<b>9275</b>	Front Gearbox Oil Seal	BMW Mini 1.6 Cooper, S, CVT- Manual - R50 (2002-)
<b>9276</b>	Front Gearbox Oil Seal	BMW Mini 1.6 Cooper, S, CVT- Manual - R53 (2002-)
<b>9277</b>	Rear Gearbox Oil Seal	BMW Mini 1.6 Cooper, S, CVT- Manual - R52/53 (2002-)
<b>9278</b>	Front Gearbox Oil Seal	BMW Mini 1.6 Cooper, S, CVT - Auto. - R53 (2002-)
<b>9279</b>	Front Gearbox Oil Seal	BMW Mini 1.6 Cooper, S, CVT - Auto. - R53 (2002-)
<b>9280</b>	Rear Main Bearing Oil Seal	BMW Mini 1.6 Cooper, S, CVT - R56 (2002-)
<b>9281</b>	Timing Cover Oil Seal	BMW 1 Series F20/21 (11-16), Mini 1.6 Cooper, S, CVT - R56 (2002-)
<b>9282</b>	Timing Cover Oil Seal	Audi S4 4.2 (2005-)
<b>9283</b>	Rear Main Bearing Oil Seal	Audi A4 3.0, S4 3.0, 4.2 (2005-)
<b>9285</b>	Drive Shaft Oil Seal	Audi A4 2.0T FSi Quattro, 3.0, TDi (2005-)
<b>9286</b>	Timing Cover Oil Seal	Toyota Fortuner 3.0 D-4D SUV 1KD-FTV - 4X2, 4X4 (06-11), 2.5D-4D 2KD-FTV, 3.0D-4D 1KD-FTV - 4X2, 4X4 (11-16), 2.4GD Raised Body 2GD-FTV, 2.7 VVTi Raised Body 2TR-FE, 2.8GD Raised Body 1GD-FTV - 4X2, 2.8GD DSi Raised Body 1GD-FTV, 3.0D-4D 1KD-FTV, 4.0 V6 1GR-FE - 4X4 (2016-), Hilux "VIGO" 2.5TDi D-4D S/Cab, S, SRX, S/Cab, S/Cab SRX HO, Raised Body Raider, D/Cab LWB 2KD-FTV, 3.0 D-4D TDi Raider, D/C Raider, Raised Body LWB P/up 1KD-FTV Dies., 4.0i D/Cab Raider Raised Body LWB P/up GR-FE Pet. - 4X2, 3.0 D-4D TDi D/C Raider 1KD-FTV Dies., LWB P/up, 4.0 D/Cab Raider 1GR-FE Pet. LWB P/up - 4X4 (05-09), 2.5TDi D-4D S/Cab, D/Cab SRX, Legend40 2KD-FTV Dies. LWB P/up, 2.7i S/Cab SRX, Legend40 2TR-FE Pet. LWB P/up - 4X4 (05-15), 3.0D-4D TDi D/C xtra cab, Raider, Legend40 1KD-FTV Dies. LWB, 4.0 D/Cab Raider, 1GR-FE Pet. - 4X4 (2009-), 2.5TDi D-4D S/Cab, S, SRX, S/Cab, S/Cab SRX HO, Raised Body Raider, D/Cab LWB P/up 2KD-FTV, 2.7i Raised Body Raider, D/Cab LWB P/up 2TR-FE Pet., 3.0D-4D TDi D/C Raised Body Raider, Xtra cab, Legend40 LWB P/up KD-FTV Dies., 4.0i D/C Raised Body Raider, Legend40 LWB P/up 1GR-FE Pet. (09-16), Hilux 2.5D-4D Raised Body 5 Spd Man., 2.5D-4D Std. Body 2KD-FTV 5 Spd Man. - 4X2, 4X4 (11-16), 3.0D-4D 1KD-FTV - 4X2, 4X4 (11-16), Hilux "Revo" 2.0 VVTi 1TR-FE, 2.4 GD-6 Raised Body 2GD-FTV - 4X2, 2.4 GD-6 2GD-FTV, 2.8 GD-6 Raised Body 1GD-FTV, 4.0 V6 Raised Body 1GR-FE - 4X4 (2016-), Quantum 2.5 D-4D, "Family", S-long MPV, Van 2KD-FTV Dies. (2005-)

## BUYERS GUIDE - OIL SEALS

<b>9287</b>	Front Wheel Oil Seal	Toyota Fortuner 3.0 D-4D SUV 1KD-FTV, 4.0 V6, Epic SUV 1GR-FE Pet. - 4X2, 4X4 (06-11), 2.5D-4D 2KD-FTV, 3.0D-4D 1KD-FTV, 4.0 V6 1GR-FE, 4.0 V6 Raised Body 1GR-FE - 4X2, 4X4 (11-16), Hilux "VIGO" 2.5TDi D-4D S/Cab, S, SRX, S/Cab, S/Cab SRX HO, Raised Body Raider, D/Cab LWB 2KD-FTV, 3.0 D-4D TDi Raider, D/C Raider, Raised Body LWB P/up 1KD-FTV Dies., 4.0i D/Cab Raider Raised Body LWB P/up GR-FE Pet. - 4X2, 3.0 D-4D TDi D/C Raider 1KD-FTV Dies., LWB P/up, 4.0 D/Cab Raider 1GR-FE Pet. LWB P/up - 4X4 (05-09), 2.7i S/Cab Raider, D/Cab Raider, S/Cab HO Raised Body LWB P/up 2TR-FE Pet. - 4X2 (05-11), 2.5TDi D-4D S/Cab, D/Cab SRX, Legend40 2KD-FTV Dies. LWB P/up, 2.7i S/Cab SRX, Legend40 2TR-FE Pet. LWB P/up - 4X4 (05-15), 3.0D-4D TDi D/C xtra cab, Raider, Legend40 1KD-FTV Dies. LWB 4.0 D/Cab Raider, 1GR-FE Pet. - 4X4 (2009-), 2.5TDi D-4D S/Cab, S, SRX, S/Cab, S/Cab SRX HO, Raised Body Raider, D/Cab LWB P/up 2KD-FTV, 2.7i Raised Body Raider, D/Cab LWB P/up 2TR-FE Pet. (09-11), 3.0D-4D TDi D/C Raised Body Raider, Xtra cab, Legend40 LWB P/up KD-FTV Dies., 4.0i D/C Raised Body Raider, Legend40 LWB P/up 1GR-FE Pet. (09-16), Hilux 2.0 VVTi 1TR-FE 5 Spd Man. S/cab, 2.5D-4D Raised Body, Std. Body 2KD-FTV 5 Spd Man., 2.7 VVTi 2TR-FE, 3.0D-4D 1KD-FTV, 4.0 1GR-FE - 4X2, 2.5D-4D Raised Body 2KD-FTV 5 Spd man., 3.0D-4D 1KD-FTV, 4.0 1GR-FE - 4X4 (11-16), Hilux "Revo" 2.4 GD-6 Raised Body 2GD-FTV, 2.7 VVTi Raised Body 2TR-FE, 2.8 GD-6 Raised Body 1GD-FTV, 4.0 V6 Raised Body 1GR-FE - 4X2, 2.4 GD-6 2GD-FTV, 2.8 GD-6 Raised Body 1GD-FTV, 4.0 V6 Raised Body 1GR-FE - 4X4 (2016-)
<b>9288</b>	Timing Cover Oil Seal	BMW X3 3.0i, 3.0si (2004-)
<b>9289</b>	Front Gearbox Oil Seal	BMW X5 4.6iS SUV (02-06)
<b>9290</b>	Rear Gearbox Oil Seal	BMW X5 4.6iS SUV (02-06)
<b>9291</b>	Use - 9825	
<b>9292</b>	Drive Shaft Oil Seal	Volvo C30 1.6, 1.8, 2.0, 2.5 (2008-), S40 1.8, 2.0, 2.0D, 2.4i, 2.5i, V50 2.0D, 2.0i, 2.4i, 2.5i (04-09)
<b>9293</b>	Drive Shaft Oil Seal	Volvo C30 1.6, 1.8, 2.0, 2.5 (2008-), S40 1.8, 2.0, 2.0D, 2.4i, 2.5i, V50 2.0D, 2.0i, 2.4i, 2.5i - Alt. (04-09)
<b>9294</b>	Front Gearbox Oil Seal	Volvo C30 1.6, 1.8, 2.0, 2.5 (2008-), S40 1.8, 2.0, 2.0D, 2.4i, 2.5i, V50 2.0D, 2.0i, 2.4i, 2.5i (04-09)
<b>9295</b>	Rear Wheel Oil Seal	Ford Ranger 2.5 Diesel, Turbo Diesel D/Cab, High Trail, XL, DT XLT High Trail D/Cab, Super Cab, 3.0TDCi Super Cab XLT Hi-Trail., 4.0 SubCab XLT Hi Trail, Super Cab XLT Hi-Trail. - 4X2, 2.5 D/Cab, High Trail, XL, DT XLT High Super Cab, 2.5TD Montana D/Cab WL4, 3.0TDCi, 4.0 Super Cab XLT - 4X4 (00-12), Nissan Hardbody QW/D22 2.7D TD27i, 3.0 i VG30E, 3.0TD ZD30, 3.2 QD32, 3.3i VG33E - 4X2, 2.4i KA24E, 2.7 TD27, 3.0 VG30E, 3.0TD ZD30, 3.2, 3.2D QD32, 3.3i VG33 - 4X4 (98-10), NP300 2.0i, S, SE KA20, 2.5TDi, S, SE YD25, 2.4i, S/C, D/C Highrider KA24 DE, 2.5TDi, S, SE Highrider YD25 - 4X2, 2.4i, S/C, D/C, Highrider KA24 DE, 2.5TDi, S, SE, Highrider YD25 - 4X4 (2008-), NV350 2.5 QR25DE, 2.5D YD25DDTi (2013-)
<b>9296</b>	Use - 9931	
<b>9297</b>	Use - 9946	
<b>9298</b>	Front Wheel Oil Seal	Ford Everest 3.0 Tdci - 4X2, 4X4 (09-15), Ranger 2.5 Diesel, Turbo Diesel D/Cab, High Trail, XL, DT XLT High Trail D/Cab, Super Cab, 3.0TDCi Super Cab XLT Hi-Trail., 4.0 SubCab XLT Hi Trail, Super Cab XLT Hi-Trail. - 4X2, 2.5 D/Cab, High Trail, XL, DT XLT High Super Cab, 2.5TD Montana D/Cab WL4, 3.0TDCi, 4.0 Super Cab XLT - 4X4 (00-12), Mazda BT-50 2500 Tdi, 2.6i SLE D/cab., S/cab., 3000 CRDi SLE D/cab., Freestyle SLX S/cab., D/cab - 4X2, 4X4 (07-12), Drifter 2.5Td LWB Hi Ride, SL SLE, SLX D/cab, Hi Ride, Hi Trail D/cab P/up WL4 Dies./Turbo Dies. - 4X2, 2.5Td LWB D/cab, DL, SL, SLE, SLX S/cab, D/cab P/up WL4 Dies./Turbo Dies. - 4X4, 2.6i LWB Hi Ride, SL Hi Ride S/cab, SLE, SLX D/cab SLX Hi Ride D/cab, SLX Hi Trail D/cab P/up Pet. - 4X2, 2.6i V6 LWB SL S/cab, SLE, SLX D/cab P/up 4G54 Pet. - 4X4 (05-09)
<b>9299</b>	Rear Wheel Oil Seal	Daihatsu Terios 1.3 SUV K3-VE, 1.5i Off-Road, 5/7 Seater SUV 3SZ-VE, 1.5 - 4X2, 4X4 (02-15), Toyota Avanza 1.3i P/Van, S, SX MPV K3VE, 1.5i SX, TX MPV 3SZVE (06-12), 1.3 S, SX MPV 3K3VE, 1.3 S P/Van 3K3VE, 1.5 SX, TX MPV 3SZVE (12-16), 1.3 S, SX MPV 1NRVE, 1.3 S P/Van 1NRVE, 1.5 SX, TX MPV 2NRVE (2016-)
<b>9300</b>	Front Wheel Oil Seal	Toyota Hilux "Vigo" 2.0i U16/17 S/Cab, S, SRX LWB Pet. P/up 1TR-FE Pet., 2.5TDi D-4D S/Cab, S, SRX, S/Cab, S/Cab SRX HO, Raised Body Raider, D/Cab LWB 2KD-FTV, 2.7i S/Cab Raider, D/Cab Raider, S/Cab HO Raised Body LWB P/up 2TR-FE Pet. - 4X2 (05-11), 2.0i S/Cab, S, SRX LWB Pet. P/up 1TR-FE Pet., 2.5TDi D-4D S/Cab, S, SRX, S/Cab, S/Cab SRX HO, Raised Body Raider, D/Cab LWB P/up 2KD-FTV, 2.7i Raised Body Raider, D/Cab LWB P/up 2TR-FE Pet. (09-11), 2.0 VVTi 1TR-FE 5 Spd Man. S/cab, 2.5D-4D Raised Body 2KD-FTV 5 Spd Man., 2.5D-4D Std. Body 2KD-FTV 5 Spd Man. - 4X2 (11-16), Hilux "REVO" 2.0 VVTi 1TR-FE, 2.4 GD-6 Raised Body 2GD-FTV, 2.7 VVTi Raised Body 2TR-FE - 4X2 (2016-)
<b>9301</b>	Rear Main Bearing Oil Seal	Dodge Journey 2.0 CRD, R/T, ECE, 2.4 SXT, ED3, 2.7 V6 R/T, SXT, EER, 3.6 V6 R/T, SXT, ERB (2008-), Mitsubishi Colt LDV 3.0i V6 LWB Club S/cab P/up Pet. - 4X2, 3.0 V6 LWB Lo-/Hi- Line D/cab, Rodeo 6G72 Pet. - 4X4 (94-98), 3.0i V6 LWB Rodeo D/cab P/up Pet. - 4X2, 4X4 (99-09)
<b>9302</b>	Drive Shaft Oil Seal	Audi A3 1.8 8L1 AGN, 1.8T AGU, BPU (98-04), A4 1.8T Avant, Multitronic, BFB, B6 AVJ 8E2, 1.9 TDi AVF, Avant B6, 8E5, 8E2 (00-08), Seat Ibiza 1.4 Sport, BXW, 1.6 Sport, BAH, 1.8T Cupra, BBU, 1.9TDi 96, 118 Cupra, 2.0 AZL, BBX, BPX, BLK, ASZ, BLT (06-09), Leon 2.0 Fsi, 2.0T, FSi Cupra, 2.0T Fsi, 2.0TDi (06-09), VW Beetle 1.8T Coupe APH (00-12), Caddy 1.6i Club, Citi, P/up HM Pet. (97-03), Golf IV 1.8T GTi, Highline AGU/AGN, 1.9 TDi Highline, Estate AHF, 2.0i Cabrio, Highline APK (99-04), Jetta IV 1.8T Highline, Exec AGU, 1.9 TDi Highline AHF, 2.0i Highline APK, 2.3 V5 AGZ (99-06)

## BUYERS GUIDE - OIL SEALS

<b>9303</b>	Cam oil seal	Toyota Fortuner 3.0 D-4D SUV 1KD-FTV - 4X2, 4X4 (06-11), 2.5D-4D 2KD-FTV, 3.0D-4D 1KD-FTV - 4X2, 4X4 (11-16), Land Cruiser Prado 120 3.0D 1KZ-TE VX S/W, 4.0 1GR-FE GX, VX S/W - 4X4 (02-10), Quantum 2.5 D-4D, "Family", S-long MPV, Van 2KD-FTV Dies. (2005-)
<b>9304</b>	Front Wheel Oil Seal Inner	Mercedes-Benz W203/4 C-Class C180, K, C200, K, C220CDi, C230, C240, C250, C280, C350, C63 AMG (2002-)
<b>9305</b>	Rear Main Bearing Oil Seal	Citroen C1 1.0 1KR, 1.0i Furio, Play 1KR (06-15), Daihatsu Sirion 1.3, 1.5, Terios 1.3 SUV K3-VE, 1.5i Off-Road, 5/7 Seater SUV 3SZ-VE, 1.5 (02-15), Peugeot 107 1.0 XR, XR+, X-Line (06-16), Toyota Avanza 1.3i P/Van, S, SX MPV K3VE, 1.5i SX, TX MPV 3SZVE (06-12), 1.3 S, SX MPV 3K3VE, 1.3 S P/Van 3K3VE, 1.5 SX, TX MPV 3SZVE (12-16), Aygo 1.0 Fresh, Inferno, Wild 3/5-door, X-Cite, X-Play 1KR (2011-), Yaris 1.0 T1, 1.3 T3, +, Spirit, T3 Spirit - Saloon & Hatch 2NZ-FE (05-10), 1.0 (10-18)
<b>9306</b>	Drive Shaft Oil Seal	Nissan Almera 1.6 Comfort, Elegance, Luxury 16DE/GA16DE, 1.8 Elegance, Luxury 18DE (01-06), Livina 1.6 Acenta, +, Visia, X-Gear (07-15), Grand Livina 1.6 Acenta, + HR16DE (08-14), Micra (K12/13) 1.2 HR12DE, 1.5 dCi Tekna, Acenta HR15DE (2004-), (K14) 0.9 K9K (2018-), NP200 1.6 16V (2008-), Qashqai 1.6 Visia, Acenta, 1.6 HR16DE (2007-), 1.2 DIG-T HRA2DDT, 1.5 dCi Accent, Tekna K9K, 1.6 dCi Accent Dies. R9M, 1.6 DIG-T Accent Pet. MR16DDT, 2.0 I Pet. MR20DD - 4X2, 4X4 (2013-), Tiida 1.6 Acenta, Visia, + (06-13), X-Trail 2.0 CVT 6 Speed MR20DD - 4X2 (2014-), Renault Captur 0.9 Tce H4B400, 1.2 Tce H5F408, 1.5 Dci K9K (2016-), Clio I, II 1.2 Authentique, Expression, Generation, Va Va Voom D4F706, 1.4 Alaise, Privilege, Expression, RT, Va Va Voom K4J7/EJ634, 1.5 DCi Expression., K9K700/-702, 1.6 Expression, Dynamique, Privilege, Sport K4M744/ -745/-748 (99-10), Laguna I 1.6 RT, RTE K4M720, 1.8 RN, RN Estate, Authentique, Expression F4P7 RT B568/-9F3P/P6, 1.9dCi F9Q716, 2.0 RT, RT Estate, RXE, Expression K4M720/724, N7Q700 (96-07), Megane I 1.6 Classic RXE, RT, RXT, RSi Coupe, RN Hatch, RT Coupe, Hatch, RXE, RXI Cabriolet K7M700/ 02/-03 (96-02), Megane II 1.4 Authentique, Dynamique E7J626/-50, 1.5dCi Authentique, Shake it! K9K722, 1.6 Classic Privilege, Expression, Dynamique, Authentique, Shake it! CC Dynamique K4M701, K4M760/ -1 (02-10), Modus 1.2 Authentique D4F706, 1.4 Dynamique, Expressio K4J770, 1.6 Expression K4M761-11 (05-08)
<b>9307</b>	Drive Shaft Oil Seal	Nissan Interstar 2.5DCi (2006-), Primastar 1.9DCi Minibus (2007-), Opel Vivaro 1.9CDTi, 2.0i P/van (06-09), Renault Traffic 1.9DCi 100 P/van (05-08)
<b>9308</b>	Rear Main Bearing Oil Seal	Nissan Interstar 2.5DCi (2006-), Primastar 1.9DCi Minibus (2007-), Opel Vivaro 1.9CDTi, 2.0i P/van (06-09), Renault Laguna 2.0T (07-08), Traffic 1.9DCi 100 P/van (05-08)
<b>9309</b>	Timing Cover Oil Seal	Nissan NP300 D22 2.5TDi, S, SE YD25, 2.5TDi, S, SE Highrider YD25 - 4X2, 4X4 (2008-), Navara D40 2.5DCi, LE, SE, XE D/Cab P/up - 4X2, 2.5DCi D/Cab P/up - 4X4 (05-17), X-Trail T30 2.2D SE, SEL MPV - 4X2, 4X4 (01-09)
<b>9310</b>	Drive Shaft Oil Seal	Nissan NP200 1.5DCi S, SE P/up, 1.6 16V (2008-), Tiida 1.8 Acenta (06-13), X-Trail T32 2.0 MR20DD - 4X2 (2014-), Renault Clio III 2.0 Sport, R27, Ltd. Edition F4R832/830 (07-14)
<b>9311</b>	Rear Main Bearing Oil Seal	Nissan Almera 1.5 HR15DE (2013-), Datsun Go/Go+ 1.2 HR12DE (2014-), Juke 1.2 DIG-T HRA2DDT, 1.6 HR16DE, 1.6 DIG-T MR16DDT - 4X2, 4X4 (2010-), 1.6 Tekna, Acenta (2013-), Livina 1.6 Acenta, +, Visia, X-Gear (07-15), Grand Livina 1.6 Acenta, + HR16DE (08-14), Micra (K12/13) 1.2 HR12DE (2004-), Qashqai 1.6 Visia, Acenta, 2.0 DCi Acenta SUV, Petrol, 1.6 HR16DE, 2.0 DCi M1D, M9R, MR20DE (2007-), Tiida 1.6 Acenta, Visia, +, 1.8 Acenta (06-13), X-Trail T31 2.0DCi - 4X2 (08-14), T32 2.0 MR20DD - 4X2 (2014-), Renault Captur 0.9 Tce H4B400, 1.2 Tce H5F408 (2016-), Fluence 2.0 (11-16), Megane III 1.4Tce (2010-)
<b>9312</b>	Rear Main Bearing Oil Seal	Nissan Tiida 1.8 (2006-)
<b>9313</b>	Drive Shaft Oil Seal	Nissan Murano 3.5 SUV (2005-)
<b>9314</b>	Pinion Oil Seal	Nissan Murano 3.5 SUV (2005-)
<b>9315</b>	Pinion Oil Seal	Nissan Murano 3.5 SUV (2005-)
<b>9316</b>	Pinion Oil Seal	Nissan Murano 3.5 SUV (2005-)
<b>9317</b>	Front Gearbox Oil Seal	Nissan Qashqai 2.0 (2007-), X-Trail T32 1.6DCi R9M - 4X2, 4X4 (2014-)
<b>9318</b>	Pinion Oil Seal	Nissan Qashqai 2.0 - 4X4 (2007-), X-Trail T30 Series 2.0, 2.2D, 2.5 - 4X4 (01-09)
<b>9319</b>	Front Gearbox Oil Seal	Nissan Navara 2.5DCi P/up, 4.0i V6 P/up - All Models - 4X4, Pathfinder 2.5DCi P/up, 4.0i V6 P/up - All Models - 4X4 (2005-)
<b>9320</b>	Transfer case Oil Seal	Nissan Navara 2.5DCi P/up, 4.0i V6 P/up - All Models - 4X4, Pathfinder 2.5DCi P/up, 4.0i V6 P/up - All Models - 4X4 (2005-)
<b>9321</b>	Rear Extension Housing Oil Seal	Nissan Navara 2.5DCi P/up, 4.0i V6 P/up - All Models - 4X4, Pathfinder 2.5DCi P/up, 4.0i V6 P/up - All Models - 4X4 (2005-)
<b>9322</b>	Transfer Covers Rear Oil Seal	Nissan Navara 2.5DCi P/up, 4.0i V6 P/up - All Models - 4X4, Pathfinder 2.5DCi P/up, 4.0i V6 P/up - All Models - 4X4 (2005-)
<b>9323</b>	Transfer Covers Front Oil Seal	Nissan Navara 2.5DCi P/up, 4.0i V6 P/up - All Models - 4X4, Pathfinder 2.5DCi P/up, 4.0i V6 P/up - All Models - 4X4 (2005-)
<b>9324</b>	Pinion Oil Seal	Nissan Navara 2.5DCi P/up, 4.0i V6 P/up - All Models - 4X4, Pathfinder 2.5DCi P/up, 4.0i V6 P/up - All Models - 4X4 (2005-)
<b>9325</b>	Pinion Oil Seal	Nissan Navara 2.5DCi P/up, 4.0i V6 P/up - All Models - 4X2, 4X4, Pathfinder 2.5DCi P/up, 4.0i V6 P/up - All Models - 4X2, 4X4 (2005-)



## BUYERS GUIDE - OIL SEALS

<b>9326</b>	Rear Main Bearing Oil Seal	Mercedes-Benz A180 CDi, A220 CDi Man. (2013-), Nissan Qashqai 1.5DCi (2007-), NP200 1.5DCi (2008-), NV200 1.5DCi (2013-), Renault Captur 1.5 Dci K9K (2016-), Clio III 1.5DCi (06-10), Megane II 1.5DCi (02-10), Kadjar 1.5dCi K9K (2015-), Kangoo 1.5DCi (01-10)
<b>9327</b>	Timing Cover Oil Seal - Same as 9037	Hyundai Accent 1.6 (06-11), Opel Corsa D 1.6 (08-15)
<b>9328</b>	Timing Cover Oil Seal	Chevrolet Captiva 2.4 LT - 4X2, 4X4 (11-17), Opel Adam 1.4 (2014-), Corsa D 1.4 (08-15)
<b>9329</b>	Rear Main Bearing Oil Seal	Fiat Panda 1.3 (2006-), Opel Corsa D 1.3CDTi (08-15), Meriva 1.3CDTi (2008-)
<b>9330</b>	Rear Main Bearing Oil Seal	BMW 1 Series F20/21 (11-16), Ford Fiesta 1.6TDCi (2008-), Peugeot 1007 1.6 (05-08), 207 1.4, 1.6 (2006-), 308 1.6HDi (2008-)
<b>9331</b>	Drive Shaft / Front Gearbox Oil Seal	Citroen C4 1.6, HDi, 2.0 (01-09), Peugeot 1007 1.6 (05-08), 207 1.4, 1.6 (2006-)
<b>9332</b>	Cam Oil Seal	Peugeot 207 1.4 Pet. (2006-)
<b>9333</b>	Cam Oil Seal	Peugeot 207 1.4HDi Dies. (2006-)
<b>9334</b>	Timing Cover Oil Seal	Ford Tourneo / Transit Connect/Grand Connect 1.0 EcoBoost Trend MPV SWB B3GA, 1.5 TDCi Ambiente Dsl P-Van LWB XWGA, 1.6 TDCi EcoBoost LWB T1GA (2013-), Peugeot 308 1.6HDi (2008-)
<b>9335</b>	Rear Main Bearing Oil Seal	Peugeot 308 2.0HDi (2008-)
<b>9336</b>	Front Wheel Oil Seal	Ford Everest 3.0 Tdci - 4X2, 4X4 (09-15), Ranger 2.5 Diesel, Turbo Diesel D/Cab, High Trail, XL, DT XLT High Trail D/Cab, Super Cab, 3.0TDCi Super Cab XLT Hi-Trail., 4.0 SubCab XLT Hi Trail, Super Cab XLT Hi-Trail. - 4X2, 2.5 D/Cab,High Trail, XL, DT XLT High Super Cab, 2.5TD Montana D/Cab WL4, 3.0TDCi, 4.0 Super Cab XLT - 4X4 (00-12), Mazda BT-50 2500 Tdi, 2.6i SLE D/cab., S/cab., 3000 CRDi SLE D/cab., Freestyle SLX S/cab., D/cab - 4X2, 4X4 (07-12), Drifter 2.5Td LWB Hi Ride, SL SLE,SLX D/cab, Hi Ride, Hi Trail D/cab P/up WL4 Dies./Turbo Dies. - 4X2, 2.5Td LWB D/cab, DL, SL, SLE, SLX S/cab, D/cab P/up WL4 Dies./Turbo Dies. - 4X4, 2.6i LWB Hi Ride, SL Hi Ride S/cab, SLE, SLX D/cab SLX Hi Ride D/cab, SLX Hi Trail D/cab P/up Pet. - 4X2, 2.6i V6 LWB SL S/cab, SLE, SLX D/cab P/up 4G54 Pet. - 4X4 (05-09)
<b>9337</b>	Cam Oil Seal	Renault Clio II/III 1.2 (2006-), Twingo 1.2 (2009-)
<b>9338</b>	Rear Main Bearing Oil Seal	Renault Clio II/III 1.2 (2006-), Twingo 1.2 (2009-)
<b>9339</b>	Rear Wheel Oil Seal	Ford Ranger 2.5 Diesel, Turbo Diesel D/Cab, High Trail, XL, DT XLT High Trail D/Cab, Super Cab, 3.0TDCi Super Cab XLT Hi-Trail., 4.0 SubCab XLT Hi Trail, Super Cab XLT Hi-Trail. - 4X2, 2.5 D/Cab,High Trail, XL, DT XLT High Super Cab, 2.5TD Montana D/Cab WL4, 3.0TDCi, 4.0 Super Cab XLT - 4X4 (00-12), Mazda BT-50 2500 Tdi, 2.6i SLE D/cab., S/cab., 3000 CRDi SLE D/cab., Freestyle SLX S/cab., D/cab - 4X2, 4X4 (07-12), Drifter 2.5Td LWB Hi Ride, SL SLE,SLX D/cab, Hi Ride, Hi Trail D/cab P/up WL4 Dies./Turbo Dies. - 4X2, 2.5Td LWB D/cab, DL, SL, SLE, SLX S/cab, D/cab P/up WL4 Dies./Turbo Dies. - 4X4, 2.6i LWB Hi Ride, SL Hi Ride S/cab, SLE, SLX D/cab SLX Hi Ride D/cab, SLX Hi Trail D/cab P/up Pet. - 4X2, 2.6i V6 LWB SL S/cab, SLE, SLX D/cab P/up 4G54 Pet. - 4X4 (05-09)
<b>9340</b>	Rear Wheel Oil Seal	Ford Ranger 2.5 Diesel, Turbo Diesel D/Cab, High Trail, XL, DT XLT High Trail D/Cab, Super Cab, 3.0TDCi Super Cab XLT Hi-Trail., 4.0 SubCab XLT Hi Trail, Super Cab XLT Hi-Trail. - 4X2, 2.5 D/Cab,High Trail, XL, DT XLT High Super Cab, 2.5TD Montana D/Cab WL4, 3.0TDCi, 4.0 Super Cab XLT - 4X4 (00-12), Mazda BT-50 2500 Tdi, 2.6i SLE D/cab., S/cab., 3000 CRDi SLE D/cab., Freestyle SLX S/cab., D/cab - 4X2, 4X4 (07-12), Drifter 2.5Td LWB Hi Ride, SL SLE,SLX D/cab, Hi Ride, Hi Trail D/cab P/up WL4 Dies./Turbo Dies. - 4X2, 2.5Td LWB D/cab, DL, SL, SLE, SLX S/cab, D/cab P/up WL4 Dies./Turbo Dies. - 4X4, 2.6i LWB Hi Ride, SL Hi Ride S/cab, SLE, SLX D/cab SLX Hi Ride D/cab, SLX Hi Trail D/cab P/up Pet. - 4X2, 2.6i V6 LWB SL S/cab, SLE, SLX D/cab P/up 4G54 Pet. - 4X4 (05-09)
<b>9341</b>	Cam Oil Seal	Renault Laguna 2.0T (07-08), Megane II 2.0, 2.0T. (2006-)
<b>9342</b>	Rear Main Bearing Oil Seal	Renault Koleos 2.0DCi. (2009-)
<b>9343</b>	Front Crank / Timing Cover Oil Seal	Renault Kadjar 1.6dCi R9M (2015-), Koleos 2.0DCi. (2009-), Nissan X-Trail T32 1.6 Dci R9M (2014-)
<b>9344</b>	Cam Oil Seal	Renault Twingo 1.6 - Some Models (2009-)
<b>9345</b>	Rear Main Bearing Oil Seal	Suzuki Jimny 1.3 SUV - Some Models (2009-)
<b>9346</b>	Rear Main Bearing Oil Seal	Suzuki Jimny 1.3 SUV - Some Models - Alt. (2009-), Swift 1.5. (2008-)
<b>9347</b>	Front Wheel Oil Seal Outer	Suzuki Jimny 1.3 SUV – Non ABS (2009-)
<b>9348</b>	Front Wheel Oil Seal Outer	Suzuki Jimny 1.3 SUV – ABS (2009-)
<b>9349</b>	Timing Cover Oil Seal	Suzuki Celerio 1.0 K10B (2015-), Swift 1.5. (2008-)
<b>9350</b>	Timing Cover Oil Seal	Toyota Auris 2.0D. (2007-), Avensis 2.2D. (06-08), Corolla 2.0D. (2007-)
<b>9351</b>	Rear Main Bearing Oil Seal	Toyota Auris 1.8i RS, RX, Corolla FWD 1.6i Professional, Advanced, 1.8i (2007-), 2.0, 2.0D D-4D Advanced, Exclusive (07-14), Corolla Verso 1.6, 1.8, 2.0D-4D (09-14), Corolla Quest FWD 1.6 Auto, Plus (2014-), Rav4 IV 2.0, 2.5 2AR-FE - 4X2, 4X4 (2013-)
<b>9352</b>	Rear Main Bearing Oil Seal	Citroen Picasso 1.8, 2.0 (03-06), Xsara 2.0 Picasso HDi, VTS, Exclusive, HDi Exclusive DW10/TD (03-08), Tata Telcoline 2.0 Turbo Diesel S/Cab P/up - 4X2, 2.0 Turbo Diesel S/Cab, D/cab P/up - 4X4 (04-05)

# BUYERS GUIDE - OIL SEALS

<b>9353</b>	Drive Shaft Oil Seal	Toyota Avensis 2.0, 2.2D - Some Models. (06-08)
<b>9354</b>	Rear Main Bearing Oil Seal	Toyota Avensis 2.2D (06-08)
<b>9355</b>	Drive Shaft Oil Seal	Toyota C-HR 1.2 T 8NR-FTS (2017-), Corolla FWD 1.8i (2007-), Yaris 1.8 TS Hatch (05-10)
<b>9356</b>	Front Gearbox Oil Seal	Toyota Etios 1.5 2NRFE (2013-), Yaris 1.0 T1, 1.3 T3, +, Spirit, T3 Spirit - Saloon & Hatch 2NZ-FE, 1.8 TS Hatch (05-10)
<b>9357</b>	Timing Cover Oil Seal	Toyota Land Cruiser 120 3.0iD. (02-09)
<b>9358</b>	Rear Main Bearing Oil Seal	Toyota Fortuner 4.0 V6. (15-)16, Hilux 4.0 - 4X2 (2009-), 4.0 - 4X4 (05-09), Land Cruiser 120 4.0i V6. (02-09), Hilux "Revo" 4.0 - 4X2, 4X4 (2016-)
<b>9359</b>	Drive Shaft / Pinion Oil Seal	Toyota Fortuner 3.0 D-4D SUV 1KD-FTV, 4.0 V6, Epic SUV 1GR-FE Pet. - 4X2, 4X4 (06-11), 2.5D-4D 2KD-FTV, 3.0D-4D 1KD-FTV, 4.0 V6 1GR-FE, 4.0 V6 Raised Body 1GR-FE - 4X2, 4X4 (11-16), Hilux "Vigo" 2.0i U16/17 S/Cab, S, SRX LWB Pet. P/up 1TR-FE Pet., 2.5TDi D-4D S/Cab, S, SRX, S/Cab, S/Cab SRX HO, Raised Body Raider, D/Cab LWB 2KD-FTV, 3.0 D-4D TDi Raider, D/C Raider, Raised Body LWB P/up 1KD-FTV Dies., 4.0i D/Cab Raider Raised Body LWB P/up GR-FE Pet. - 4X2, 3.0 D-4D TDi D/C Raider 1KD-FTV Dies., LWB P/up, 4.0 D/Cab Raider 1GR-FE Pet. LWB P/up - 4X4 (05-09), 2.7i S/Cab Raider, D/Cab Raider, S/Cab HO Raised Body LWB P/up 2TR-FE Pet. - 4X2 (05-11), 2.5TDi D-4D S/Cab, D/Cab SRX, Legend40 2KD-FTV Dies. LWB P/up, 2.7i S/Cab SRX, Legend40 2TR-FE Pet. LWB P/up - 4X4 (05-15), 3.0D-4D TDi D/C xtra cab, Raider, Legend40 1KD-FTV Dies. LWB 4.0 D/Cab Raider, 1GR-FE Pet. - 4X4 (2009-), 2.0i S/Cab, S, SRX LWB Pet. P/up 1TR-FE Pet., 2.5TDi D-4D S/Cab, S, SRX, S/Cab, S/Cab SRX HO, Raised Body Raider, D/Cab LWB P/up 2KD-FTV, 2.7i Raised Body Raider, D/Cab LWB P/up 2TR-FE Pet. (09-11), 3.0D-4D TDi D/C Raised Body Raider, Xtra cab, Legend40 LWB P/up KD-FTV Dies., 4.0i D/C Raised Body Raider, Legend40 LWB P/up 1GR-FE Pet. (09-16),
<b>9359... Continued</b>	Drive Shaft / Pinion Oil Seal	Hilux 2.5D-4D Raised Body, Std. Body 2KD-FTV 5 Spd Man., 2.7 VVTi 2TR-FE, 3.0D-4D 1KD-FTV, 4.0 1GR-FE - 4X2, 2.5D-4D Raised Body 2KD-FTV 5 Spd man., 3.0D-4D 1KD-FTV, 4.0 1GR-FE - 4X4 (11-16), Land Cruiser HDJ200 4.5 D-4D, 4.6 V8, 4.7 V8 - 4X4 (2007-), Land Cruiser Prado 120 3.0D 1KZ-TE VX S/W, 4.0 1GR-FE GX, VX S/W - 4X4 (02-10), Quantum 2.5 D-4D, "Family", S-long MPV, Van 2KD-FTV Dies., 2.7 "Family", S-long "Ses'fikile" MPV, Van 2TR-FE Pet. (2005-)
<b>9360</b>	Drive Shaft Oil Seal	Toyota Land Cruiser Prado 120 3.0D 1KZ-TE VX S/W, 4.0 1GR-FE GX, VX S/W - 4X4 (02-10)
<b>9363</b>	Front wheel Oil Seal Inner	Toyota Land Cruiser 120 3.0iD, 4.0i V6. (02-09), HDJ200 4.5 D-4D, 4.6 V8, 4.7 V8 - 4X4 - (2006-)
<b>9364</b>	Front Wheel Oil Seal Outer	Toyota Land Cruiser 120 3.0iD, 4.0i V6 (02-09), Land Cruiser HDJ200 4.5 D-4D, 4.6 V8, 4.7 V8 - 4X4 (2007-)
<b>9369</b>	Rear Wheel Oil Seal Inner	Toyota Land Cruiser 120 3.0iD, 4.0i V6 (02-09), Land Cruiser HDJ200 4.5 D-4D, 4.6 V8, 4.7 V8 - 4X4 (2007-)
<b>9370</b>	Rear Wheel Oil Seal Outer	Toyota Land Cruiser 120 3.0iD, 4.0i V6 (02-09), Land Cruiser HDJ200 4.5 D-4D, 4.6 V8, 4.7 V8 - 4X4 (2007-)
<b>9371</b>	Rear Wheel Oil Seal Inner	Toyota Land Cruiser 120 3.0iD, 4.0i V6 (02-09), Land Cruiser HDJ200 4.5 D-4D, 4.6 V8, 4.7 V8 - 4X4 (2007- )
<b>9372</b>	Rear Wheel Oil Seal Outer	Toyota Land Cruiser 120 3.0iD, 4.0i V6 (02-09), Land Cruiser HDJ200 4.5 D-4D, 4.6 V8, 4.7 V8 - 4X4 (2007-)
<b>9373</b>	Drive Shaft Oil Seal	Toyota Rav4 III 2.0, 2.2D (2006-)
<b>9374</b>	Drive Shaft Oil Seal	Toyota Rav4 III 2.0, 2.2D (2006-)
<b>9375</b>	Use - 9375FS	
<b>9376</b>	Cam Oil Seal	Ford Fiesta 1.4 (2008-), Focus II 1.6 (2005-), Mazda2 1.3 (2007-), Volvo C30 1.6 (2007-)
<b>9378</b>	Timing Cover Oil Seal	Ford Fiesta II 2.0 ST150 (04-09), Focus II 2.0 Si, Trend., TDCi Ghia, TDCi Si. (05-09), Focus III 2.0 Gtdi ST1 & ST2 R9DA (09-15), Mondeo 2.0 CJBA, CJBB (02-07), Mazda 3 (BL, BK) 2.0 Individual LF17, 2.0 BN Series (04-14), 5 2.0 Original, Active, Individual (07-14), 6 2.0 Active, Original, Elegant, 2.3 Dynamic, Dynamic Individual, Sporty, Sporty Lux, 2.3 MPS AWD, 2.5 Dynamic Active-matic, Individual (2008-), Pajero 3500 - 4X4 (02-07), Renault Clio III 2.0 Sport, R27, Ltd. Edition F4R832/830 (10-14), Volvo C30 1.8 Man., 2.0, R-Design, Powershift Man., Geartronic (08-13), S40 1.8 Sedan, 2.0 Sedan (2004-), S60, V60 2.0 D3, D4, T5 (2010-), V50 2.0i (06-12)
<b>9379</b>	Timing Cover Oil Seal	Honda Accord VII Series 2.0i, 2.4i, 2.2CDTi (2004-), Civic VII Series 1.8, 2.2i-CTDi (2006-), CR-V II 2.0 K20A4 - 4X4 (05-09), CR-V III 2.0 i-VTEC R20A1, 2.2 i-CTDi N22A2, 2.2 i-DTEC N22B3, 2.4 i-Vtec K24Z1, K24Z4 - 4X4 (09-12)
<b>9380</b>	Drive Shaft Oil Seal	Honda Accord VII Series 2.0i, 2.4i, 2.2CDTi (2004-)
<b>9381</b>	Rear Main Bearing Oil Seal	Honda Accord VII Series 2.2CDTi (2004-), Civic VII Series 2.2i-CTDi (2006-), CR-V III 2.2 i-CTDi N22A2, 2.2 i-DTEC N22B3 - 4X4 (09-12), CR-V IV 2.2 i-DTEC N22B4 - 4X4 (2012-)
<b>9382</b>	Timing Cover Oil Seal	Honda Jazz 1.4 (2004-)
<b>9383</b>	Use - 354807	
<b>9384</b>	Timing Cover Oil Seal	Hyundai i10 1.1 (2009-)
<b>9385</b>	Timing Cover Oil Seal	Hyundai Terrecan 3.5i V6 (03-08)



## BUYERS GUIDE - OIL SEALS

<b>9386</b>	Timing Cover Oil Seal	Hyundai Tucson 2.0CRDi (2005-), Kia Cerato 2.0CRDi (04-08), Sportage 2.0CRDi - 4X2, 4X4 (2004-)
<b>9387</b>	Rear Main Bearing Oil Seal	Hyundai Tucson 2.0CRDi (2005-), Kia Cerato 2.0CRDi (04-08), Sportage 2.0CRDi - 4X2, 4X4 (2004-)
<b>9388</b>	Use - 9667	
<b>9389</b>	Timing Cover Oil Seal	Kia Sportage 2.0i - 4X2, 4X4 (2004-)
<b>9390</b>	Timing Cover Oil Seal	Mazda 6 2.0, 2.3 (03-08), CX-7 2.3 L3-VDT - AWD, 2.5 L5-VE (07-12)
<b>9391</b>	Cam oil seal	Ford Ranger 2.5 Diesel, Turbo Diesel D/Cab, High Trail, XL, DT XLT High Trail D/Cab, Super Cab - 4X2 (07-12), Mazda BT-50 3000 CRDi SLE D/cab., Freestyle SLX S/cab., D/cab - 4X2, 4X4 (07-12)
<b>9392</b>	Rear Main Bearing Oil Seal	Mercedes-Benz W169 A-Class A180, CDi, CVT, A200, CDi, CVT, W245 B-Class B170, B180, B200CDi, Turbo (2005- )
<b>9393</b>	Front Gearbox Oil Seal	Mercedes-Benz W169 A-Class A200, CVT, W245 B-Class B170, B200 - All Manual (2005-)
<b>9394</b>	Front Gearbox Oil Seal	Mercedes-Benz W169 A-Class A180, CDi, CVT, A200, CDi, CVT - All Auto., W245/ B-Class B170, B180, B200CDi, Turbo - All Auto. (2005-), W211 E-Class E200K, E240, E280, E300, E320, E350, E500 - All Auto. (2005-)
<b>9395</b>	Use - 406208	
<b>9396</b>	Front Gearbox Oil Seal	Mercedes-Benz W169 A-Class A180 CDi, A200 CDi, CVT, W245 B-Class B200CDi, Turbo - All Manual (2005-)
<b>9397</b>	Rear Main Bearing Oil Seal	Mercedes-Benz W204 C-Class C180K, C200K, C220CDi, C350, C63 AMG (2008-), W211 E-Class - E240, E280, E320, E350, 2006- W164 ML Class ML350 (2002-)
<b>9400</b>	Front Gearbox Oil Seal	Mercedes-Benz W211 E-Class E200K, E240, E280, E320, E350 (2002-)
<b>9401</b>	Front Wheel Oil Seal Inner	Mercedes-Benz W211 E-Class E200K, E240, E280, E320, E350 (2002-)
<b>9403</b>	Rear Wheel Oil Seal	Toyota Fortuner 3.0 D-4D SUV 1KD-FTV, 4.0 V6, Epic SUV 1GR-FE Pet - 4X2, 4X4 (09-11), 2.5D-4D 2KD-FTV, 3.0D-4D 1KD-FTV, 4.0 V6 1GR-FE, 4.0 V6 Raised Body 1GR-FE - 4X2, 4X4 (11-16), 2.4GD Raised Body 2GD-FTV, 2.7 VVTi Raised Body 2TR-FE, 2.8GD Raised Body 1GD-FTV - 4X2 (2015-), 2.8GD DSi Raised Body 1GD-FTV, 3.0D-4D 1KD-FTV, 4.0 V6 1GR-FE - 4X4 (2015-), Hilux LN57 2.8D LWB D/cab, Raider P/up 3L Dies. - 4X2 (95-98), Hilux "Vigo" 2.5TDi D-4D S/Cab, D/Cab SRX, Legend40 2KD-FTV Dies. LWB P/up, 2.7i S/Cab SRX, Legend40 2TR-FE Pet. LWB P/up - 4X4 (05-15), 3.0D-4D TDi D/C xtra cab,Raider, Legend40 1KD-FTV Dies. LWB 4.0 D/Cab Raider, 1GR-FE Pet. - 4X4 (2009-), 2.0i S/Cab, S, SRX LWB Pet. P/up 1TR-FE Pet., 2.5TDi D-4D S/Cab, S, SRX, S/Cab, S/Cab SRX HO, Raised Body Raider, D/Cab LWB P/up 2KD-FTV, 2.7i Raised Body Raider, D/Cab LWB P/up 2TR-FE Pet. (09-11), 3.0D-4D TDi D/C Raised Body Raider, Xtra cab, Legend40 LWB P/up KD-FTV Dies., 4.0i D/C Raised Body Raider, Legend40 LWB P/up 1GR-FE Pet. (09-16), Hilux 2.0 VVTi 1TR-FE 5 Spd Man. S/cab, 2.5D-4D Raised Body, Std. Body 2KD-FTV 5 Spd Man., 2.7 VVTi 2TR-FE, 3.0D-4D 1KD-FTV, 4.0 1GR-FE - 4X2, 2.5D-4D Raised Body 2KD-FTV 5 Spd man., 3.0D-4D 1KD-FTV, 4.0 1GR-FE - 4X4 (11-16), Hilux "Revo" 2.0 VVTi 1TR-FE, 2.4 GD-6 Raised Body 2GD-FTV, 2.7 VVTi Raised Body 2TR-FE, 2.8 GD-6 Raised Body 1GD-FTV, 4.0 V6 Raised Body 1GR-FE - 4X2, 2.4 GD-6 2GD-FTV, 2.8 GD-6 Raised Body 1GD-FTV, 4.0 V6 Raised Body 1GR-FE - 4X4 (2016-)
<b>9404</b>	Rear Wheel Oil Seal Outer	Chevrolet Constantia 4.1, 5.0 (69-78), De Ville 5.0 (72-75), Kommando 4.1 (69-78), C10 4.1 (74-80), El Camino 4.1, 5.0, El Toro 4.1 (72-78), Chrysler 3.7 (75-80), Valiant 3.7 (72-78), Dodge 3.7 (72-75), Ford Falcon 4.0 (96-01), Ranchero 3.6, 4.1, 5.0 (71-76), Leyland Rover 2.6, 3.5 (78-84), Mazda 323 1.3, 1.4, 1.6 (77-81), Mitsubishi Colt 1.6, 2.0, 2.6 (72-84), Nissan 200, 280 (78-80)
<b>9405</b>	Gearbox Oil Seal Rear	Nissan 1200, 120Y, 140Y, 140Z (71-80)
<b>9406</b>	Rear Wheel Oil Seal	Toyota Fortuner 3.0 D-4D SUV 1KD-FTV, 4.0 V6, Epic SUV 1GR-FE Pet - 4X2, 4X4 (09-11), 2.5D-4D 2KD-FTV, 3.0D-4D 1KD-FTV, 4.0 V6 1GR-FE, 4.0 V6 Raised Body 1GR-FE - 4X2, 4X4 (11-16), 2.4GD Raised Body 2GD-FTV, 2.7 VVTi Raised Body 2TR-FE, 2.8GD Raised Body 1GD-FTV - 4X2, 2.8GD DSi Raised Body 1GD-FTV, 3.0D-4D 1KD-FTV, 4.0 V6 1GR-FE - 4X4 (2016-), Hilux "Vigo" 2.5TDi D-4D S/Cab, D/Cab SRX, Legend40 2KD-FTV Dies. LWB P/up, 2.7i S/Cab SRX, Legend40 2TR-FE Pet. LWB P/up - 4X4 (05-15), 3.0D-4D TDi D/C xtra cab, Raider, Legend40 1KD-FTV Dies. LWB, 4.0 D/Cab Raider, 1GR-FE Pet. - 4X4 (2009-), 2.0i S/Cab, S, SRX LWB Pet. P/up 1TR-FE Pet., 2.5TDi D-4D S/Cab, S, SRX, S/Cab, S/Cab SRX HO, Raised Body Raider, D/Cab LWB P/up 2KD-FTV, 2.7i Raised Body Raider, D/Cab LWB P/up 2TR-FE Pet., 3.0D-4D TDi D/C Raised Body Raider, Xtra cab, Legend40 LWB P/up KD-FTV Dies., 4.0i D/C Raised Body Raider, Legend40 LWB P/up 1GR-FE Pet. (09-16), Hilux 2.0 VVTi 1TR-FE 5 Spd Man. S/cab, 2.5D-4D Raised Body, Std. Body 2KD-FTV 5 Spd Man., 2.7 VVTi 2TR-FE, 3.0D-4D 1KD-FTV, 4.0 1GR-FE - 4X2, 2.5D-4D Raised Body 2KD-FTV 5 Spd man., 3.0D-4D 1KD-FTV, 4.0 1GR-FE - 4X4 (11-16), Hilux "Revo" 2.0 VVTi 1TR-FE, 2.4 GD-6 Raised Body 2GD-FTV, 2.7 VVTi Raised Body 2TR-FE, 2.8 GD-6 Raised Body 1GD-FTV, 4.0 V6 Raised Body 1GR-FE - 4X2, 2.4 GD-6 2GD-FTV, 2.8 GD-6 Raised Body 1GD-FTV, 4.0 V6 Raised Body 1GR-FE - 4X4 (2016-)
<b>9407</b>	Front Wheel Oil Seal Inner	Toyota Hilux 4X2 Standard Body 2.0i, 2.5 D-4D - 4X2 (2009-), 2.0, 2.5D-4D, 2.7, 3.0D-4D, 4.0 (11-16), "Revo" 2.0, 2.4, 2.7, 2.8, 3.0D-4D, 4.0 (2016-)
<b>9408</b>	Rear Main Bearing Oil Seal	Chevrolet Captiva 2.0D, 2.2D - 4X2, 4X4 (07-17), Cruze 2.0D (2009-)

## BUYERS GUIDE - OIL SEALS

<b>9410</b>	Front Gearbox Oil Seal	Chevrolet 2500 (73-78), 3800 (72-78), 4100 (72-78), Commodore 2.8, 3.8, 4.1 (78-82), Constantia 4.1, 5.0 (69-78), De Ville 5.0 (72-75), Firenze 2.5 (73-75), Hatch 1.9 (76-78), Kommando 4.1 (69-78), Rekord 2.0, 2.3 (78-82), Senator 4.1 (79-82), El Camino 4.1, 5.0 (72-78)
<b>9415</b>	Rear Wheel Oil Seal	C.A.M. Inyathi, Jinbei Haise Minibus 2.2i Std., Rhino 2.2i, 2.8i (Local Diff.) (2007-), Ford Cortina MkIV 3.0 V6 Leisure, P/up Essex EV30 (77-80), Cortina MkV 1.6 P/up Kent, 2.4 P/up York D24, 3.0 V6 Leisure P/up Essex EV30 (80-86), Courier 1.6 P/up F6, 1.8 Chassis cab, Explorer, Std., XLT P/up F8, 2.0 XLT FE., 2.2 D/cab, Explorer, Leisure, Std., XLT P (86-00), Courier 3.0 V6 D/cab, Explorer, L, Leisure, Std., P/up Essex (86-97), Courier 2.5 Turbo Diesel D/cab, Leisure P/up WL4 - 4X2, 4X4 (96-00), Courier 3.0 V6 Std., XLT, D/cab, Leisure, Explorer, Exec. P/up Essex, 3.4 V6 Leisure, D/Cab, P/up Essex. - 4X2, 4X4 (97-01), Husky 1.8 1 Ton P/up 4G62, 2.0 1 Ton P/up, Bus, P/van 4G63 (Local) (85-99), Ranger 1.8 XL, P/up, 2.2 XL, P/up (00-10), 2.5 Diesel, Turbo Diesel D/Cab, High Trail, XL, DT XLT High Trail D/Cab, Super Cab - 4X2 (00-05), 2.5 D/Cab, High Trail, XL, DT XLT High Super Cab, 2.5TD Montana D/Cab WL4, 3.0TDCi, 4.0 Super Cab XLT - 4X4 (00-05), Spectron 2.2 Bus, P/van F2 (91-04), Hyundai Bakkie 2.5i D4BH Dies., 2.6i D4BB Dies., H100 P/Van 2.5i D4BH Dies., 2.6i D4BB Dies., (Local) (97-07), Isuzu KB20 1.6 P/up G161Z Pet., KB21 1.6 P/up G161Z Pet., KB22 1.8 P/up G180Z Pet., KBD20 2.0 P/up C190, KBD21 2.0 P/up C190, KBD22 2.2 LE, P/up C223, KB23 2.0 P/up G200Z, KB24 2.3 LE 4ZD1, KB25 1.6 P/up G161Z, KB26 1.6 P/up G161Z, 1.8 P/up G180Z, KBD23 2.5 LE, P/up 4JA1, KBD25 2.0 P/up C190 (78-89), KBD26 2.0 P/up C190, KBD27 2.2 C223, KBD28 2.5 4JA1 (81-89), KB27 1.8 P/up G180Z, KB28 2.0 P/up G200Z, KB29 2.3 P/up 4ZD1 (83-89), KB40 1.6 G161Z, KB41 1.6 G161Z, 1.8 G180Z, KB42 1.8 G180Z, KB43 2.0 G200Z, KB44 2.3 4ZD1, KBD40 KBD41 2.0 P/up C190, KBD42 2.2 P/up C223 - 4X4 (Local) (79-89), KB160 1.6 Fleetside P/up, KB200 2.0 LE, Fleetside, D/cab P/up, KB220 2.2 LE, P/up, KB230 2.3 D/cab P/up (89-04), KB260 2.6 LE, D/cab, LX, P/up 4ZE1, KB320 3.2 LE, D/cab, LX, Frontier, Reef, Blazer P/up 6VD1 (92-04), KB220 2.2 LE P/up, KB230 2.3 P/up 4ZD1, KB260 2.6 D/cab, LE, LX, KB320 3.2 V6 Frontier LX - 4X4 (89-04), KB250D 2.5 Fleetside, LE, D/Cab P/up 4JA1, KB280DT 2.8 D/cab LE, LX, Frontier P/up Turbo 4JB1 (89-04), KB250D 2.5 LE, D/cab P/up 4JA1, KB280DT 2.8 LE, LX, D/cab P/up Turbo 4JB1 - 4X4 (04-09), Relay 2.0 P/van, Bus 4ZC1 (89-95), WFR 1.8 11FVX/ 12FVX Bus, P/van 4ZB1 (83-89), Kia Sportage JA 2.0 SUV 5 Spd. FE Pet. - 4X4 (98-03), Mazda B-Series B2000 2.0 SWB P/up MA Pet., B2200 2.2 SWB/LWB P/up S2 Dies. (82-86), B2600 2.6 LWB D/cab, Magnum, Drifter P/up 4G54 Pet., B2600i 2.6i LWB D/cab Drifter, SLX P/up 4G54 Pet. - 4X2 (86-01), B2600 2.6 V6 LWB D/cab, Magnum, Drifter P/up 4G54 Pet. - 4X4 (86-95), B3000 3.0 V6 LWB D/cab, Magnum Drifter P/up Essex Pet. - 4X2, B3000 3.0 V6 LWB D/cab, Magnum, Drifter, Magnum Drifter P/up Essex Pet. - 4X4 (86-97), B1600 1.6 SWB Magnum P/up F6 Pet., B1800 1.8 SWB/LWB Magnum, Drifter P/up F8 Pet. (86-00), B2000 2.0 LWB Drifter, Magnum P/up FE Pet., B2200 2.2 LWB D/cab, Drifter, Magnum P/up R2 Dies., 2.2 LWB D/cab, Drifter Magnum P/up F2 Pet. (86-00), B2500 2.5, Td LWB D/Cab, Drifter, SLX P/up WL4 Dies./Turbo Dies. - 4X4 (96-99), B3400 3.4 V6 LWB Magnum D/cab P/up Essex Pet. - 4X2, 4X4 (96-01), B2500 2.5 LWB Diesel, Turbo Diesel D/cab, Drifter, SLX P/up WL4 Dies., Turbo - 4X2 (97-00), B2600i 2.6i V6 LWB Drifter, D/cab Drifter SLX P/up 4G54 Pet. - 4X4 (00-09), Drifter 1.8 SWB/LWB XL P/up Pet., 2.2 SWB/LWB XL P/up Pet., 2.5Td LWB Hi Ride, SL SLE, SLX D/cab, Hi Ride, Hi Trail D/cab P/up WL4 Dies./Turbo Dies. - 4X2, 2.5Td LWB D/cab, DL, SL, SLE, SLX S/cab, D/cab P/up WL4 Dies./Turbo Dies. - 4X4, 2.6i LWB Hi Ride, SL Hi Ride S/cab, SLE, SLX D/cab SLX Hi Ride D/cab, SLX Hi Trail D/cab P/up Pet. - 4X2, 2.6i V6 LWB SL S/cab, SLE, SLX D/cab P/up 4G54 Pet. - 4X4 (00-05), Marathon 2.2 LWB Bus, P/van F2 Pet. (91-04), Mitsubishi Colt LDV 1.6 SWB/LWB Lo-Line P/up 4G32 Pet., 2.0 4G63 Pet., 2.5D 4D56 Dies., 2.6 WB Hi-Line P/up 4G54 Pet. (94-98), Colt LDV 2.5D LWB Hi-Line P/up 4D56 Dies., 2.6 LWB Lo-/Hi-Line, P/up 4G54 Pet., 3.0 V6 LWB Lo-/Hi-Line D/cab, Rodeo 6G72 Pet. - 4X4 (95-98), L300 1.6 Mini Bus, Van 4G32 Pet., 1.8 4G62 Pet., 2.0 P/up 4G63 Pet, Starwagon 2.0 S, SL, SLE, P/up, P/van 4G63 Pet. (82-01), Pajero 2.8 Tdi, 3.0 V6 SWB GLS Wagon 6G72 Pet., 3.5 V6 SWB GLS Wagon 6G74 Pet. - 4X4 (90-01), Nissan 1-Tonner/Hardbody AW/D21 1.6 L16S-J, 1.8 L18S-R, 2.0 NA20, 2.4 Z24/S, 2.5D TD25i, 2.7D TD27, 3.0 VG30E (88-98), AW/D21 2.4 Z24S, 2.7 TD27, 3.0 VG30E - 4X4 (88-99), 720 D20 1.8 L18S Kingcab, Sport, 2.2D SD/Z22 Tracker, 2.3 SD23 - 4X2, 1.8 L18S, 2.0 NA20, 2.2 Z22 - 4X4 (80-88),

## BUYERS GUIDE - OIL SEALS

<b>9415... Continued</b>	Rear Wheel Oil Seal	E20 1.8 L18 Bus, P/van Coach, Coach GL, GLE, Econolux, Ekonovan, Ekonowagon, 2.0 Bus, Van H20 (80-96), Hardbody QW/D22 2.0 NA20S, 2.0i KA20, 2.4i Z24, KA24E/DE, 2.7D TD27i, 3.0 i VG30E, 3.0TD ZD30, 3.2 QD32, 3.3i VG33E - 4X2, 2.4i KA24E, 2.7 TD27, 3.0 VG30E, 3.0TD ZD30, 3.2, 3.2D QD32, 3.3i VG33 - 4X4 (98-04), Sani AW/D21 2.4, i Z24, 2.5 TD25, 2.7D, TD TD27, 3.0 VG30E - 4X2 (86-99), 2.2 Z22, 2.4 Z24, 2.7 TD27, 3.0 VG30E - 4X4 (86-98), Terrano II 2.7 TD2 - 4X4 (00-02), Ssangyong Korando 2.3 K230 EL, Open Top S/W, 2.9 K290 EL, TDi, Open Top S/W, 3.2 K320 EL S/W, MUSSO 2.3 E230 EL S/W, 2.9 602, EL, EX, TDi, Exec., E290 TDi, Exec., 3.2 E320 EL Exec. (95-04), Toyota Hiace YH50/60 1.8 SWB / LWB P/van, LS Wagon 2Y Pet. (83-91), YH51/61 2.0 SWB/LWB 16 Seater Commuter, Super 10 Seater Custom Wagon, P/van 3Y Pet. (83-86), YH53/63 2.2 SWB/LWB P/van, Van, LS, Super T/14/16, GLX, Exec. Wagon, Siyaya Bus, P/van 4Y Pet. (All Local Models) (88-09), Hilux LN30/40/50/51/55 2.2 SWB/LWB P/up L Dies., 2.4 SWB/LWB D/cab, Raider P/up 2L Dies., YN58 2.2 LWB D/cab, Raider, SRX P/up 4Y Pet. (79-98), YN67 2.2 LWB D/cab, Raider D/cab P/up 4Y Pet. - 4X4 (86-94), YN51/56 1.8 SWB/LWB D/cab, S, SR, Raider P/up 2Y Pet., YN140 1.8 SWB/LWB D/cab, Raider, S, SRX P/up 2Y Pet. (86-05), LN65 2.4 LWB D/cab, Raider D/cab P/up 2L Dies., RN67 2.4 LWB D/cab, Raider D/cab P/up 22R Pet. - 4X4 (89-98), RN58 2.4 22R Pet., LN140/145 2.4i DLX, P/up 2L Dies., RZN194 2.7i LWB D/cab, Raider, SRX, Legend35 Raider, 3RZFE Pet. (94-05), LN57 2.8D LWB D/cab, Raider P/up 3L Dies. - 4X2, LN67 2.8D LWB, D/cab, Raider D/cab P/up 3L Dies. - 4X4 (95-98), RZN147 2.0 SWB/LWB D/cab, DLX, Raider, S, SR, SRX P/up 1RZ Pet., LN192R 3.0D LWB Raider D-E, Raider DLX D/cab D-E, Legend35 Raider, P/up 5L Dies., 3.0iD LWB Raider, Raider D/cab, P/up KZ-TE Dies. (98-05), RZN169 2.7i LWB D/cab, DLX S/cab, Raider S/D/cab, SRX D/cab, Legend 35 LWB P/up 3RZFE Pet., LN167 3.0D D/cab D-E, DLX, S/D/cab DE, Raider DE, Legend35 LWB P/up 5L Dies., 3.0iD LWB Raider S/cab & KZ-TE D/cab P/up, Legend35 - 4X4 (98-05), Stallion KF50 1.5 SR5, Commuter, Bus, P/up, P/van 5K Pet., YF50 1.8 SR5, P/up, P/van, Van 2Y Pet., LF50 2.4D P/up 2L5F Dies. (87-04),
<b>9415... Continued</b>	Rear Wheel Oil Seal	TUV KF20 1.3 Chassis Cab, P/up, P/van, Bus 4K Pet., 1.5 P/up 5K Pet. (82-87), Venture YF50 1.8 8/10 Seater P/van 2Y Pet., 2.2 10 Seater, GLE, Getaway 9 Seater S/W 4Y Pet., LF50 2.4D 10 Seater S/W 2L5F Dies. (91-04)
<b>9416</b>	Rear Wheel Oil Seal	Toyota Fortuner 3.0 D-4D SUV 1KD-FTV, 4.0 V6, Epic SUV 1GR-FE - 4X2, 4X4 (06-09), Hilux RZN169 2.7i LWB D/cab, DLX S/cab, Raider S/D/cab, SRX D/cab, Legend 35 LWB P/up 3RZFE Pet, LN167 3.0D D/cab D-E, DLX, S/D/cab DE, Raider DE, Legend35 LWB P/up 5L Dies., 3.0iD LWB Raider S/cab & KZ-TE D/cab P/up, Legend35 - 4X4 (98-05), Hilux "VIGO" 2.0i U16/17 S/Cab, S, SRX LWB Pet. P/up 1TR-FE Pet., 2.5TDi D-4D S/Cab, S, SRX, S/Cab, S/Cab SRX HO, Raised Body Raider, D/Cab LWB 2KD-FTV, 3.0 D-4D TDi Raider, D/C Raider, Raised Body LWB P/up 1KD-FTV Dies., 4.0i D/Cab Raider Raised Body LWB P/up GR-FE Pet. - 4X2, 4X4 (05-09), 2.7i S/Cab Raider, D/Cab Raider, S/Cab HO Raised Body LWB P/up 2TR-FE Pet. - 4X2 (05-11), 2.5TDi D-4D S/Cab, D/Cab SRX, Legend40 2KD-FTV Dies. LWB P/up, 2.7i S/Cab SRX, Legend40 2TR-FE Pet. LWB P/up - 4X4 (05-15), Quantum 2.5 D-4D, "Family", S-long MPV, Van 2KD-FTV Dies., 2.7 "Family", S-long "Ses'fikile" MPV, Van 2TR-FE Pet. (2005-)
<b>9417</b>	Timing Cover, Cam Oil Seal	Alfa Romeo 145 2.0 Quadrofoglio AR32301 (96-01), 146 2.0 Ti Twin Spark AR67204 (96-99), 147 1.6 Progression, TS AR32104, 1.9 JTD, 2.0 Destinctive, Selespeed TS AR3231 (01-10), 155 2.0 TS AR32301 (96-99), 156 2.5 V6 AR32401, AR3240 Sportswagon (98-07), GTV / Spider 2.0 (96-06), VW Kombi T2 2.0, L Exec., Microbus, Kamper, P/up, P/van CU, CJ Pet., T3 1.9 Microbus, P/van DG Pet. (75-89), T3 1.8 P/van, GUS, Volksiebus AAX Pet. (89-99), T3 2.1 Fi Caravelle, Microbus DJ Pet., 2.3i Microbus, Volksiebus AFU Pet., 2.5i Microbus, Caravelle AAY Pet., 2.6i Microbus, Caravelle, Exclusive, ADV Pet. - 4X2 (85-04)
<b>9419</b>	Front Wheel Oil Seal Inner	Nissan Langley 1.5 (83-88), Pulsar 1.4, 1.5 (80-87)
<b>9419</b>	Front Wheel Oil Seal	Nissan Langley 1.5 GL, L, SSS, Trebon, Exa Turbo E15 (83-88), Pulsar 1.4 DL, GX A14, 1.5 GL, Panache, SX E15 (80-87)
<b>9420</b>	Rear Wheel Oil Seal	Nissan Langley 1.3 GL E13, 1.5 GL, L, SSS, Trebon, Exa Turbo E15 (83-88), Pulsar 1.3 S E13, 1.4 DL, GX A14, 1.5 GL, Panache, SX E15 (80-87)
<b>9426</b>	Rear Main Bearing Oil Seal	Hyundai Accent X3 1.3 G4EH, 1.5 G4EK (94-00), LC 1.3 G4EH, 1.5 G4EK, 1.6 G4ED (00-06), Elantra HD 1.6 GLS (07-11), S-Coupe 1.5 (94-95), Kia Rio II 1.4 High, A5D, 1.6 Sport G4ED (2004-), Mitsubishi Colt LDV 1.6 SWB/LWB Lo-Line P/up 4G32 Pet. (94-98), L300 1.6 Mini Bus, Van 4G32 Pet. (82-01), Lancer 1.6 GLX 4G18, 2.0 GLS 4G63 (03-08)
<b>9430</b>	Rear Main Bearing Oil Seal	BMW 3 Series E30 316 1.8 M10, 316i 1.6 M40, 318i 1.8 M40, 320i M20/50, 323i M50, 325i M52, 333i M30 (83-92), E36 316i 1.8 Dolphin Shape M40, 318i 1.9 M44, 320i 2.0 M50, 323i 2.5 M52, 325i M50, 328i 2.8, 3.0 M52, Z3 2.8, 3.0 Roadster (92-00), E37 M3 M Coupe S50 (93-01), 5 Series E28 520i 2.0 M20, 525e 2.5 M30, 528i 2.8 M30, 535i 3.0 M30 (85-89), E34 520i 2.0 M50, 525i 2.5 M50, 530i 3.0 M60, 535i 3.5 M30, 540i 4.0 M60 (90-00), M5 Coupe M30, M5 Coupe MS38 (86-94)



## BUYERS GUIDE - OIL SEALS

<b>9431</b>	Rear Wheel Oil Seal	C.A.M. Inyathi, Jinbei Haise Minibus 2.2i Std., Rhino 2.2i, 2.8i (Import Diff.) (2007-), Toyota Hiace YH51/61 2.0 SWB/LWB 16 Seater Commuter, Super 10 Seater Custom Wagon, P/van 3Y Pet. (83-86), YH53/63 2.2 SWB/LWB P/van, Van, LS, GLX, Exec. Wagon 4Y Pet. (All Imp. Models) (86-88), Hilux LN30/40/50/51/55 2.2 SWB/LWB P/up L Dies., 2.4 SWB/LWB D/cab, Raider P/up 2L Dies., YN58 2.2 LWB D/cab, Raider, SRX P/up 4Y Pet. (79-98), YN67 2.2 LWB D/cab, Raider D/cab P/up 4Y Pet. - 4X4 (86-94), YN51/56 1.8 SWB/LWB D/cab, S, SR, Raider P/up 2Y Pet., YN140 1.8 SWB/LWB D/cab, Raider, S, SRX P/up 2Y Pet. (86-05), LN65 2.4 LWB D/cab, Raider D/cab P/up 2L Dies., RN67 2.4 LWB D/cab, Raider D/cab P/up 22R Pet. - 4X4 (89-98)
<b>9432</b>	Front Wheel Oil Seal	Fiat Uno 1.0 Cento 156A2, 1.1 Espresso P/van 160A3, 1.1 Fire, Rio, Mia, Tempo 160A3, 1.4 Pacer, Beat, Mia, Tempo, SX 146C1 (90-05)
<b>9435</b>	Rear Gearbox Oil Seal	Ford Cortina MkIII 2.0, 2.5, 3.0 (71-77), Cortina MkIV 2.0, 3.0 (77-80), Cortina MkV 2.0, 3.0 (80-84), Granada 2.0, 2.5, 3.0 (72-86), Cortina MkIII LDV 2.5 (74-77), Cortina MkIV LDV 3.0 (78-80), Cortina MkV LDV 3.0 (81-86)
<b>9436</b>	Front Gearbox Oil Seal	Ford Cortina MkIII 2.0, 2.5, 3.0 (71-77), Cortina MkIV 2.0, 3.0 (77-80), Cortina MkV 2.0, 3.0 (80-84), Granada 2.0, 2.5, 3.0 (72-86), Cortina MkIII LDV 2.5 (74-77), Cortina MkIV LDV 3.0 (78-80), Cortina MkV LDV 3.0 (81-86)
<b>9437</b>	Front, Rear Wheel Oil Seal	Toyota Hilux YN67 2.2 LWB D/cab, Raider D/cab P/up 4Y Pet. - 4X4 (86-94), LN65 2.4 LWB D/cab, Raider D/cab P/up 2L Dies. - 4X4 (89-98), LN67 2.8D LWB, D/cab, Raider D/cab P/up 3L Dies. (95-98), Land Cruiser FJ80 4.0 DLX, GX, VX P/up 3F/F-E Pet. (90-92), FZJ/HZJ75 4.2 GX S/W, P/up 1FZF/HZ Dies. (91-97), FZJ80 4.5 Std., GX, VX, Turbo S/W, P/up 1FZ-FE Dies., Turbo Dies. (92-95), FZJ80 4.5 Std., GX, VX, Turbo S/W, P/up 1FZ-FE Dies., Turbo Dies. (95-06), FZJ105 4.5 Std., GX, Turbo P/up, S/W 1FZ-FE Dies., Turbo Dies. (95-98), HDJ/HZJ80 4.2 GX, Turbo S/W, P/up 1HD-FT, 1HZ Dies., T. Dies. (90-95), HDJ/HZJ80 4.2 Std., GX, VX, Turbo S/W, P/up 1HD-FT, 1HZ Dies., Turbo Dies. (95-01), HDJ100 4.2 Std., GX, VX S/W, 1HZ Pet., 4.5, 4.7 V8 (97-04), HZJ76 4.2D (2009-), HZJ105 4.2 Std., GX DSL, Turbo P/up, S/W 1HZ Dies., Turbo Dies. (98-06), PHJ75 3.9 DLX, GX, GX Turbo P/up Perkins236 2H Dies., FJ75 4.0 DLX, GX, VX 3F/F-E Pet. (85-92), UZJ100 4.5 V8 Std., GX, VX S/W, P/up 2UZ-FE Pet. - 4X4 (98-06)
<b>9442</b>	Front Wheel Oil Seal	BMW 7 Series E23 728, i M30, 730 M30, 733i M30, 735i M90, 745i M88 (78-89), Toyota Condor 1.6 Estate, TE, 5L, 1.8 2Y, 2.0i Estate, TE, 1RZ Pet., 2.4i Estate, TE, TX 2RZ-E, 3.0D Estate, TE, 5L Dies. - 4X2 (00-05), Cressida TX30 1.8 DX 3T, TX62 1.8 L, LS 3T, YX70 1.8 LS, Exec. (80-89), RX60 2.0 GL, GLE, GLX, S/W 21R, RX70, YX72 2.0 GL, GL, GLE, GLX (81-92), GX60 2.0 GLi6 1G-E, GX7 2.0 GLi6 1G-E, 1G-FE (83-92), MX63 2.8i 5M-E, MX73 2.8i RSi, RSi Exec. 5M-GE (84-89), MX75 3.0i ECT, GLS 7MG-E (86-92), RX72 2.4 GL, GL S/W, GLE, GLE S/W 22R, RX73 2.4 GLE, GLE S/W 22R With I.R.S. (Independent Rear Suspension) (87-92), Stallion KF50 1.5 SR5, Commuter, Bus, P/up, P/van 5K Pet., YF50 1.8 SR5, P/up, P/van, Van 2Y Pet., LF50 2.4D P/up 2L5F Dies. (87-04), Venture YF50 1.8 8/10 Seater P/van 2Y Pet., 2.2 10 Seater, GLE, Getaway 9 Seater S/W 4Y Pet., LF50 2.4D 10 Seater S/W 2L5F Dies. (91-04)
<b>9444</b>	Front Wheel Oil Seal	Ford Bantam 130 Explorer P/up B3, 160, i Explorer, Leisure, Sport, P/up B6/ F6 (94-03), Laser 1.3 L, GL, 13, Dash E3 / B3, 1.6, i GL, 16, Sport, TX3 B6/ F6, 2.0, i RS FE (86-95), 1.4 L CHV-FUA, 1.5 GL, GLS, Sport E5/B5 (86-92), Meteor 1.3 GL, L, 13 E3/B3, 1.4 LX CVH, 1.5 GL, GLS E5, 1.6, i GL, GLE, GLi, 16, Sport B6/CVH/F6, 2.0 8/16V GLE, GLi FE (86-95), Tracer 1.3 Sedan, H/back - Tonic, Plus B3, 1.6 Sedan, H/back - Plus, Sport, Tonic B6/F6 (95-02), Mazda 323 FWD 1.3 S, H/back, Sedan E3, 1.5 GLC, SL, SLX, Sport H/back, Sedan E5 (81-88), 1.3 L, H/back, Sedan E/B3, 1.5, L H/back, Sedan E5, 1.6 EGi Hatch, L, Sedan, SL Hatch, SL Sedan, Sport Hatch B6i/ F6 (84-91), 2.0 EGi Hatch, SLE Hatch, SLi Sedan, 200e Hatch, Sedan, 200i Hatch 8/16V FE-2000 (89-95), 130 Hatch, Midge, Sedan, Sting B3, 160, i, S Hatch, Midge, Sedan, Sting F6 (90-95), 130 Hatch, Midge, Sedan, Sting B3, 160, i, S Hatch, Midge, Sedan, Sting F6, 200i, e Hatch 8/16V FE 2000 (95-05), Rustler 130 SWB Drifter, Explorer P/up B3 Pet., 160, i SWB Explorer, Drifter P/up F6/B6i Pet. (94-02)
<b>9445</b>	Front Wheel Oil Seal	Ford Bantam 130 Explorer P/up B3, 160, i Explorer, Leisure, Sport, P/up B6/ F6 (94-03), Laser 1.3 L, GL, 13, Dash E3 / B3, 1.6, i GL, 16, Sport, TX3 B6/ F6, 2.0, i RS FE (86-95), 1.4 L CHV-FUA, 1.5 GL, GLS, Sport E5/B5 (86-92), Meteor 1.3 GL, L, 13 E3/B3, 1.4 LX CVH, 1.5 GL, GLS E5, 1.6, i GL, GLE, GLi, 16, Sport B6/CVH/F6, 2.0 8/16V GLE, GLi FE (86-95), Tracer 1.3 Sedan, H/back - Tonic, Plus B3, 1.6 Sedan, H/back - Plus, Sport, Tonic B6/F6 (95-02), Mazda 323 FWD 1.3 S, H/back, Sedan E3, 1.5 GLC, SL, SLX, Sport H/back, Sedan E5 (81-88), 1.3 L, H/back, Sedan E/B3, 1.5, L H/back, Sedan E5, 1.6 EGi Hatch, L, Sedan, SL Hatch, SL Sedan, Sport Hatch B6i/ F6 (84-91), 2.0 EGi Hatch, SLE Hatch, SLi Sedan, 200e Hatch, Sedan, 200i Hatch 8/16V FE-2000 (89-95), 130 Hatch, Midge, Sedan, Sting B3, 160, i, S Hatch, Midge, Sedan, Sting F6 (90-95), 130 Hatch, Midge, Sedan, Sting B3, 160, i, S Hatch, Midge, Sedan, Sting F6, 200i, e Hatch 8/16V FE 2000 (95-05), Rustler 130 SWB Drifter, Explorer P/up B3 Pet., 160, i SWB Explorer, Drifter P/up F6/B6i Pet. (94-02)
<b>9446</b>	Use - 9654	

## BUYERS GUIDE - OIL SEALS

<b>9447</b>	Rear Wheel Oil Seal	Ford Laser 1.3 L, GL, 13, Dash E3 / B3 (86-02), 1.4 L CHV-FUA, 1.5 GL, GLS, Sport E5/B5 (86-92), 1.6, i GL, 16, Sport, TX3 B6/ F6, 2.0, i RS FE (86-02), Meteor 1.3 GL, L, 13 E3/B3, 1.4 LX CVH, 1.5 GL, GLS E5, 1.6, i GL, GLE, GLi,16, Sport B6/CVH/F6, 2.0 8/16V GLE, GLi FE (86-95), Tracer 1.3 Sedan, H/back –Tonic, Plus B3, 1.6 Sedan, H/back – Plus, Sport, Tonic B6/F6 (86-02), Kia Pride Pride 1.3i LX 5 Dr. H/back, Rio I 1.3 5 Dr. H/back A3E, 1.5 5 Dr. H/back A5D (98-04), Mazda 323 FWD 1.3 S, H/back, Sedan E3, 1.5 GLC, SL, SLX, Sport H/back, Sedan E5 (81-88), 1.3 L, H/back, Sedan E/B3, 1.5, L H/back, Sedan E5, 1.6 EGi Hatch, L, Sedan, SL Hatch, SL Sedan, Sport Hatch B6i/F6 (84-91), 2.0 EGi Hatch, SLE Hatch, SLi Sedan, 200e Hatch, Sedan, 200i Hatch 8/16V FE-2000 (89-95), 130 Hatch, Midge, Sedan, Sting B3, 160, i, S Hatch, Midge, Sedan, Sting F6 (90-95), 130 Hatch, Midge, Sedan, Sting B3, 160, i, S Hatch, Midge, Sedan, Sting F6, 200i, e Hatch 8/16V FE 2000 (95-05)
<b>9449</b>	Front Wheel Oil Seal	Ford Bantam 1300 P/up Kent 2V, 1400 Leisure, Nite P/up CVH/FUA, 1600 Leisure Explorer, Nite P/up CVH (83-94), Escort FWD MkIII 1.3 GL, L Kent, 1.6 GLE, L, Sport, XR3, i HL16CVH (81-86), Sapphire 1.6 L Kent, 2.0, i GL, GLE, GLEA, GLi, GLi Exec. Koln, 3.0 Ghia, GLX Essex (89-93), Sierra 1.6 GL, GL S/W, L Kent, 2.0 GL, GL S/W Koln, 2.0 LX Koln, 2.3 GLE, Cologne, 3.0, i GLS, GLX, LX, RS, XR6 Essex (83-93), Mazda Rustler 1.3 SWB P/up Kent 2V Pet., 1.4 SWB P/up CVH/ FUA Pet., 1.6 SWB, LX P/up CVH/ LUC Pet. (86-94)
<b>9450</b>	Front Wheel Oil Seal	Ford Bantam 1300 P/up Kent 2V, 1400 Leisure, Nite P/up CVH/FUA, 1600 Leisure Explorer, Nite P/up CVH (83-94), Escort FWD MkIII 1.3 GL, L Kent, 1.6 GLE, L, Sport, XR3, i HL16CVH (81-86), Mazda Rustler 1.3 SWB P/up Kent 2V Pet., 1.4 SWB P/up CVH/FUA Pet., 1.6 SWB, LX P/up CVH/ LUC Pet. (86-94)
<b>9452</b>	Rear Main Bearing Oil Seal	Ford Bantam 1400 Leisure, Nite P/up CVH/FUA, 1600 Leisure Explorer, Nite P/up CVH (83-94), Escort FWD MkIII 1.3 GL, L Kent, 1.6 GLE, L, Sport, XR3, i HL16CVH (81-86), Fiesta I 1.4, i Flair, Trend, Fun, Zetec CVH/PTE, 1.6, i Ambiente', Flair, Forte', Ghia, Rsi, Sport, Trend (97-04), Focus I 2.0i 4/5 Door, L Trend, RS, ST170 Zetec E (00-05), Laser 1.4 L CHV-FUA (86-92), Meteor 1.4 LX CVH (86-95), 121 Soho 1.4i 3/5 Dr. H/back Zetec CVH/PTE (97-99), Rustler 1.4 SWB P/up CVH/ FUA Pet., 1.6 SWB, LX P/up CVH/ LUC Pet. (86-94)
<b>9453</b>	Rear Main Bearing Oil Seal	Nissan 680 2.2 (78-80)
<b>9454</b>	Timing Cover Oil Seal	Mitsubishi Canter 3.3 4D30A Dies., 3.8 ADE236 Dies. (80-97)
<b>9455</b>	Pinion Oil Seal	Mitsubishi Canter 2.5, 2.6, 3.3, 3.8 (80-97)
<b>9456</b>	Front Wheel Oil Seal	Mitsubishi Canter 2.5 SWB/LWB D/side, Chassis cab 4G55 Dies., 2.6 4G54 Pet., 3.3 4D30A Dies., 3.8 ADE236 Dies. (80-97)
<b>9457</b>	Rear Main Bearing Oil Seal	Mitsubishi Canter 3.3, 3.8 (80-97)
<b>9458</b>	Rear Main Bearing Oil Seal	Mazda E2000 (67-80), T2000 (81-86)
<b>9462</b>	Front Wheel Oil Seal	Opel Rekord 2.0 Berlina, GL, GLS, L, S/W CIH, 2.0i CLE, CLS, GL, GLE, Irmscher, 2.2E CIH, 380i, V6 CD, GSi 38GE (82-95)
<b>9464</b>	Rear Main Bearing Oil Seal	Chevrolet Aveo 1.5 L, LS, LT, 1.6 LS (03-15), Cruze 1.6 L, LS F16D3, 1.8 LS, LT F18D4 (09-15), Optra 1.6 Ls F16D3 (04-11), Orlando 1.8 F18D4 (2011-), Sonic 1.4 Pet. Hatch / Sedan, 1.6 Pet. Hatch / Sedan (11-15), Utility 1.3D, 1.4 Pet., 1.8 Pet. (11-15), Daewoo Cielo 1.5 GL, GLX, GTX, 150i L, Espero 1.8 CD, C18LE (96-99), Lanos I 1.35i S, 1.6 SX, Lanos II 1.4 S, 1.6 SX, Numbira I 1.6 SX, Numbira II 1.6 SX, SX S/W (97-03), Tacuma 1.6 SX (01-03), Honda Accord VII 2.0i V-Tec (03-08), Accord VIII 2.4i V-Tec K24Z3 (08-15), Ballade 1.5i L15A7 (2011-), Brio 1.2 L12B1 (2012-), Civic VIII 1.8i VTEC EXi, LXi, VXi, R18A2, 2.0i VTEC Type R, K20Z4 (07-13), CR-V II 2.0 K20A4 - 4X4 (05-09), CR-V III 2.0 i-VTEC R20A1, 2.2 i-CTDi N22A2, 2.2 i-DTEC N22B3, 2.4 i-Vtec K24Z1, K24Z4 - 4X4 (09-12), CR-V IV 2.0 R20A6, 9, 2.0 i-VTEC R20A5, 6, 9, 2.2 i-DTEC N22B4, 2.4i K24Z9 - 4X2, 4X4 (2012-), FR-V 1.8i R18A1 (07-10), Jazz 1.4 Dsi, 1.5 V-TEC L15A (03-07), 1.3 i-VTEC LX Man., Auto., 1.4i L13Z1, 1.5 i-VTEC EX L15A (07-15), Hyundai Accent MC 1.6 G4ED (06-11-), Opel Adam 1.4 B14XER, A14XER, Adam S 1.4T B14NEH (2014-), Ascona 1.3 L 13NV/SC (82-87), Astra F 140i, iS 14NV, 160i, iE, iS, Estate 16NZ (93-99), Astra G 1.6 CS, Classic CD, CDE, Comfort C16SEL (99-06), Astra H 1.4 Essentia Z14XEP, 1.6 Classic Club, Elegance, Enjoy, Essentia, Sport Z16XEP, 1.8 Enjoy, GTC, GTC Sport, Twintop, Enjoy, Z18XER (04-10), Astra J 1.4T, 1.6i (2010-), Corsa B 130, i, Lite, iE, iS, Chill Hatch / Sedan 13NE, 140i, Classic, Active, Lite, Lite+, Comfort, Chill, Sport, S 14NE, Hatch/ Sedan, 160, i, iE, Classic, GSi, i Sport, S Hatch/ Sedan, 16SE (96-03), Corsa C 140i Classic, Comfort, Chill, Classic Essentia, Hatch Club, Sport, Lite Sport, S14NE, 160i Classic, Classic Elegance, Classic CD, CDE, Sport, 16SE (03-08), Corsa D 1.4i Essentia, Enjoy, Cosmo, Sport, 1.6i Sport, OPC (08-15), Corsa LDV 130i Utility P/up 13NE, 1.4i Utility, S P/up 14NE, 1.6i Utility Sport P/up 16NZ, 1.7D Utility P/up X17D (97-04), Corsa LDV II 1.4i Utility, Club Sport, S P/up 14XE (03-10), Corsa P/Van 1.3i Pronto 13NE, 1.4i Combo P/ van (99-00), Kadett D, E 1.3 Cub, GL, GLS, LS, Rebel 13NV, 140 CL, Cub 14NE/NV, 1.6 GL, GLS, GSE, L, Rebel, Cub 16SH/SE, 160i, GSi Aspen 16SE (80-93), Kadett F 180i, iE, GSi 18SE, 200is 20XE (93-99), Meriva 1.4 Essentia, Enjoy, 1.6 Club, Comfort, Enjoy MPV Z16SE/-XE (03-09), 1.4T (12-15), Mokka 1.4T A14NET, B14NET (15-16), Monza 160 GSi, i Aspen 16SE/NZ, CLS 16SV (86-93), Zafira III 1.6 Essentia MPV (05-09)



## BUYERS GUIDE - OIL SEALS

<b>9467</b>	Gearbox Oil Seal Front, Rear	Ford Bantam 1400 Leisure, Nite P/up CVH/FUA, 1600 Leisure Explorer, Nite P/up CVH (83-94), Escort FWD MkIII 1.3 GL, L Kent, 1.6 GLE, L, Sport, XR3, i HL16CVH (81-86), Fiesta I 1.3, i Flair, Flite, Play, Fun, Endura-EM5, 1.4, i Flair, Trend, Fun, Zetec CVH/PTE, 1.6, i Ambiente', Flair, Forte', Ghia, Rsi, Sport, Trend (97-04), Ikon 1.3, Low, LX CLTA, 1.4, Low, LX, 1.4 Tdci, 1.6i, Low, High, LX, CLX, CLTA (01-06), Mazda 121 Soho 1.3, i 3/5 Dr. H/back, Endura-EM5, 1.4i 3/5 Dr. H/back Zetec CVH/PTE (97-99), Rustler 1.4 SWB P/up CVH/FUA Pet., 1.6 SWB, LX P/up CVH/ LUC Pet. (86-94)
<b>9468</b>	Front Wheel Oil Seal	Isuzu KB20 1.6 P/up G161Z Pet., KB21 1.6 P/up G161Z Pet., KB22 1.8 P/up G180Z Pet., KBD20 2.0 P/up C190, KBD21 2.0 P/up C190, KBD22 2.2 LE, P/up C223, KB23 2.0 P/up G200Z, KB24 2.3 LE 4ZD1, KB25 1.6 P/up G161Z, KB26 1.6 P/up G161Z, 1.8 P/up G180Z, KBD23 2.5 LE, P/up 4JA1, KBD25 2.0 P/up C190 (78-89), KBD26 2.0 P/up C190, KBD27 2.2 C223, KBD28 2.5 4JA1 (81-89)
<b>9469</b>	Drive Shaft Oil Seal	Honda Ballade SC9 150, i EW (84-89)
<b>9471</b>	Rear Main Bearing Oil Seal	Chevrolet 1300 (75-78), Ascona 1.3 (78-81), Hatch 1.3 (76-78), Honda Ballade 1.3 (82-85), Opel Kadett 1.1 (66-74)
<b>9472</b>	Front Wheel Oil Seal	Honda Ballade SA4 1300 EN4 (82-85)
<b>9473</b>	Rear Main Bearing Oil Seal	Opel Ascona 1.6 GL 16SH, 1.8 GLS 18L (82-87), Kadett D, E 1.6 GL, GLS, GSE, L, Rebel, Cub 16SH/ SE, 160i, GSi Aspen 16SE (80-93), 1.8 GTE 18E, L 18LV, GSi Hatch 18L, GLX 18SV, GSi 18E/ SE (84-89), Monza 160 GSi, i Aspen (86-93)
<b>9475</b>	Rear Main Bearing Oil Seal	Opel Rekord 2.0 Berlina, GL, GLS, L, S/W CIH, 2.0i CLE, CLS, GL, GLE, Irmscher, 2.2E CIH, 380i, V6 CD, GSi 38GE (82-95)
<b>9477</b>	Front Gearbox Oil Seal	Opel Rekord Auto. (82-95)
<b>9478</b>	Rear Gearbox Oil Seal	Opel Rekord Auto. (82-95)
<b>9479</b>	Drive Shaft Oil Seal	Opel Ascona (82-87)
<b>9481</b>	Timing Cover, Cam Oil Seal	Renault R9 1.4 GTL, TL, TSE C1/2/3J, R11 1.4 TS, TX, TXE C1/2/3J (83-86)
<b>9483</b>	Drive Shaft Oil Seal	Renault Clio III 1.4, 1.5, 1.6, 2.0 (06-10), R9, R11 1.4, 1.7, Scenic III 1.6 (83-86)
<b>9484</b>	Rear Main Bearing Oil Seal	Isuzu KB22 1.8 P/up G180Z Pet., KBD20 2.0 P/up C190, KBD21 2.0 P/up C190, KBD22 2.2 LE, P/up C223, KB23 2.0 P/up G200Z, KB24 2.3 LE 4ZD1, KB25 1.6 P/up G161Z, KB26 1.6 P/up G161Z, 1.8 P/up G180Z, KBD25 2.0 P/up C190 (78-89), KBD26 2.0 P/up C190 (81-89), KB27 1.8 P/up G180Z, KB28 2.0 P/up G200Z (83-89), KB40 1.6 G161Z, KB41 1.6 G161Z, 1.8 G180Z, KB42 1.8 G180Z, KB43 2.0 G200Z - 4X4, KBD41 2.0 P/up C190, KBD42 2.2 P/up C223 - 4X4 (79-89)
<b>9485</b>	Front Wheel Oil Seal	Toyota Corolla RWD TE31 1.6 Sprinter, SR4/5, Black Hawk, Silver Wolf 2T, AE/TE71 1.6 GL, S/W, GLS Sprinter, SE 2T, TB TE72, 1.8 GLS, SE 3T (80-88), Corolla KE70 1.3 P/van 4K (84-88)
<b>9488</b>	Pinion Oil Seal	Ford Sierra 1.6, 2.0, 2.3, 3.0 Import (83-93)
<b>9489</b>	Rear Gearbox Oil Seal	Ford Sapphire 2.0, 2.0i, 3.0, Sierra 2.0, 2.3, 3.0 (83-93)
<b>9491</b>	Front Wheel Oil Seal	Nissan Laurel C31 2.0 CA/L20, 2.8 SGL 5L28 (80-87), Skyline R30 1.8 L18, 2.0 GL L20, 2.8 GLX, GTX L28/2 (82-87)
<b>9495</b>	Drive Shaft Oil Seal	Opel Kadett 1.2, 1.3, 1.4, 1.6 (80-93)
<b>9496</b>	Rear Main Bearing Oil Seal	Opel Kadett D, E 1.2 (80-93)
<b>9497</b>	Drive Shaft Oil Seal	Opel Kadett 1.4, 1.6, 1.8 (82-93)
<b>9499</b>	Front Gearbox Oil Seal	Opel Ascona 1.6 (82-87)
<b>9500</b>	Rear Main Bearing Oil Seal	Mercedes-Benz W211 E-Class E240, E320, E500, E63 (2002-), BM906 Series Sprinter 318, 518, W164 ML Class ML320CDi, ML500, ML63 AMG (2006-)
<b>9501</b>	Rear Main Bearing Oil Seal	Mercedes-Benz BM906 Series Sprinter 309, 311, 315, 509, 511, 515, W639 Vito 115CDi (2006-)
<b>9502</b>	Rear Wheel Oil Seal	Mahindra Scorpio 2.0, 2.2, 2.2 CRDE, 2.5 NEF, 2.6 Turbo, 2.6 TD /CRDE - 4X2, 4X4 (2005-), Scorpio Pick-Up 2.2 CRDE, 2.5, 2.5 TD, 2.5 NEF Tci (2006-), Nissan Navara D40 Series 2.5DCi, LE, SE, XE D/Cab P/up, 4.0i V6, LE D/Cab P/up - 4X2, Navara & Pathfinder D40/ R51 2.5DCi D/ Cab P/up, 3.0DCi V6, 4.0i V6, LE D/Cab P/up - 4X4 (05-17)

## BUYERS GUIDE - OIL SEALS

<b>9503</b>	Front Gearbox Oil Seal	Toyota Fortuner 3.0 D-4D SUV 1KD-FTV, 4.0 V6, Epic SUV 1GR-FE Pet. - 4X2, 4X4 (06-11), 2.5D-4D 2KD-FTV, 3.0D-4D 1KD-FTV - 4X2, 4X4 (11-16), Hilux "Vigo" 2.0i U16/17 S/Cab, S, SRX LWB Pet. P/up 1TR-FE Pet., 2.5TDi D-4D S/Cab, S, SRX, S/Cab, S/Cab SRX HO, Raised Body Raider, D/Cab LWB 2KD-FTV, 3.0 D-4D TDi Raider, D/C Raider, Raised Body LWB P/up 1KD-FTV Dies., 4.0i D/Cab Raider Raised Body LWB P/up GR-FE Pet. - 4X2, 3.0 D-4D TDi D/C Raider 1KD-FTV Dies., LWB P/up, 4.0 D/Cab Raider 1GR-FE Pet. LWB P/up - 4X4 (05-09), 2.7i S/Cab Raider, D/Cab Raider, S/Cab HO Raised Body LWB P/up 2TR-FE Pet. - 4X2 (05-11), 2.5TDi D-4D S/Cab, D/Cab SRX, Legend40 2KD-FTV Dies. LWB P/up, 2.7i S/Cab SRX, Legend40 2TR-FE Pet. LWB P/up - 4X4 (05-15), 3.0D-4D TDi D/C xtra cab, Raider, Legend40 1KD-FTV Dies. LWB 4.0 D/Cab Raider, 1GR-FE Pet. - 4X4 (2009-), 2.5TDi D-4D S/Cab, S, SRX, S/Cab, S/Cab SRX HO, Raised Body Raider, D/Cab LWB P/up 2KD-FTV, 2.7i Raised Body Raider, D/Cab LWB P/up 2TR-FE Pet. (09-11), 3.0D-4D TDi D/C Raised Body Raider, Xtra cab, Legend40 LWB P/up KD-FTV Dies., 4.0i D/C Raised Body Raider, Legend40 LWB P/up 1GR-FE Pet. (09-16), Hilux 2.5D-4D Raised Body 2KD-FTV 5 Spd man. - 4X4 (11-16), 2.7 VVTi 2TR-FE, 3.0D-4D 1KD-FTV, 4.0 1GR-FE - 4X2 (11-16), 3.0D-4D 1KD-FTV, 4.0 1GR-FE - 4X4 (11-16), Hilux "Revo" 2.0 VVTi 1TR-FE, 2.4 GD-6 Raised Body 2GD-FTV, 2.7 VVTi Raised Body 2TR-FE - 4X2 (2016-), Land Cruiser FZJ105 4.5 V8 VX, Turbo P/up, S/W 2UZ-FE Pet., HZJ105 4.2 Std., GX DSL, Turbo P/up, S/W 1HZ Dies., Turbo Dies. - 4X4 (98-06), Quantum 2.5 D-4D, "Family", S-long MPV, Van 2KD-FTV Dies., 2.7 "Family", S-long "Ses'fikile" MPV, Van 2TR-FE Pet. (2005-)
<b>9504</b>	Transfer Case Oil Seal	Toyota Fortuner 3.0 D-4D SUV 1KD-FTV, 4.0 V6, Epic SUV 1GR-FE - 4X4 (06-11), 3.0D-4D 1KD-FTV - 4X2, 4X4 (11-16), Hilux "Vigo" 3.0 D-4D TDi D/C Raider 1KD-FTV Dies., LWB P/up, 4.0 D/Cab Raider 1GR-FE Pet. LWB P/up - 4X4 (05-09), 2.5TDi D-4D S/Cab, D/Cab SRX, Legend40 2KD-FTV Dies. LWB P/up, 2.7i S/Cab SRX, Legend40 2TR-FE Pet. LWB P/up - 4X4 (05-15), 3.0D-4D TDi D/C xtra cab, Raider, Legend40 1KD-FTV Dies. LWB, 4.0 D/Cab Raider, 1GR-FE Pet. - 4X4 (2009-), 2.5D-4D Raised Body 2KD-FTV 5 Spd man. - 4X4 (11-16)
<b>9505</b>	Extension Housing Oil Seal	Toyota Fortuner 3.0 D-4D SUV 1KD-FTV, 4.0 V6, Epic SUV 1GR-FE - 4X4 (06-11), 3.0D-4D 1KD-FTV - 4X2, 4X4 (11-16), Hilux "Vigo" 3.0 D-4D TDi D/C Raider 1KD-FTV Dies., LWB P/up, 4.0 D/Cab Raider 1GR-FE Pet. LWB P/up - 4X4 (05-09), 2.5TDi D-4D S/Cab, D/Cab SRX, Legend40 2KD-FTV Dies. LWB P/up, 2.7i S/Cab SRX, Legend40 2TR-FE Pet. LWB P/up - 4X4 (05-15), 3.0D-4D TDi D/C xtra cab, Raider, Legend40 1KD-FTV Dies. LWB, 4.0 D/Cab Raider, 1GR-FE Pet. - 4X4 (2009-), 2.5D-4D Raised Body 2KD-FTV 5 Spd man., 3.0D-4D 1KD-FTV, 4.0 1GR-FE - 4X4 (11-16)
<b>9506</b>	Drive Shaft Oil Seal	Toyota Fortuner 3.0ld, 4.0l - 4X4 (2006-), Hilux 2.0l, 2.5Tdi D-4D. 3.0ld, 4.0l 4X4 (2005-)
<b>9510</b>	Use - 9563	
<b>9511</b>	Rear Main Bearing Oil Seal	Ford Ranger 2.5 Diesel, Turbo Diesel D/Cab, High Trail, XL, DT XLT High Trail D/Cab, Super Cab - 4X2, Mazda BT-50 2500 Tdi (07-12)
<b>9512</b>	Drive Shaft Oil Seal	Ford Ranger 2.5TD, 3.0TDCi, 4.0 (2004-), Mazda Drifter 2.5TD, 2.6i, 3.0TDCi, 4.0 (04-07), BT-50 2.6i, 3.0CRDi (2007-)
<b>9516</b>	Drive Shaft Oil Seal	Ford Ranger T6 2.5 - 4x4 (2012-), Mazda BT-50 2500 Tdi - 4X2, 4X4 (07-12)
<b>9517</b>	Rear Gearbox Oil Seal	Mazda BT-50 2.6i SLE D/cab., S/cab., 3000 CRDi SLE D/cab., Freestyle SLX S/cab., D/cab - 4X2, 4X4 (07-12)
<b>9518</b>	Timing Cover Oil Seal	Isuzu KB250Dc 2.5, KB300TDi 3.0 LX - 4X2, 4X4 (04-09), KB300TDi 3.0 D-TEQ - 4X2, 4X4 (07-11)
<b>9519</b>	Drive Shaft Oil Seal	Mitsubishi Triton 2.4 MPI D/cab P/up 2.5 Di-D C/cab P/up, 2.5 Di-D D/cab P/up, 3.2 Di-D D/cab P/up, 3.5 Club cab P/up, 3.5 MPi Double cab P/up - 4X2, 4X4 (2007-)
<b>9521</b>	Timing Cover Oil Seal	Honda Civic VII Series 2.0 Type R (2006-), CR-V IV 2.0 R20A6, 9, 2.0 i-VTEC R20A5, 6, 9, 2.2 i-DTEC N22B4, 2.4i K24Z9 - 4X2, 4X4 (2012-)
<b>9522</b>	Drive Shaft Oil Seal	Honda Civic VIII 1.8i VTEC EXi, LXi, VXi, R18A2, 2.0i VTEC Type R, K20Z4 (07-13), CR-V II 2.0 K20A4 - 4X4 (05-09), CR-V III 2.0 i-VTEC R20A1, 2.2 i-CTDi N22A2, 2.2 i-DTEC N22B3, 2.4 i-Vtec K24Z1, K24Z4 - 4X4 (09-12), Jazz 1.4 Dsi, 1.5 V-TEC L15A (03-07), 1.3 i-VTEC LX Man., Auto., 1.4i L13Z1, 1.5 i-VTEC EX L15A (07-15), Jazz IV 1.5 Elegance L15Z2 (2015-)
<b>9523</b>	Front Gearbox Oil Seal	Hyundai i10 PA 1.1 G3LA, 1.2 G4LA (08-15), i20 PB/BT 1.2, 1.4, 1.6 (2009-)
<b>9524</b>	Timing Cover Oil Seal	Iveco Turbo Daily 35/10, 35/12 2.3i P/van, Bus (2006-)
<b>9525</b>	Rear Main Bearing Oil Seal	Iveco Turbo Daily 35/10, 35/12 2.3i P/van, Bus (2006-)
<b>9526</b>	Cam Oil Seal	Iveco Turbo Daily 35/10, 35/12 2.3i P/van, Bus (2006-)
<b>9527</b>	Drive Shaft Oil Seal	Mercedes-Benz W245 B-Class B170, B180, B200CDi, Turbo (2005-)
<b>9528</b>	Drive Shaft Oil Seal	Mercedes-Benz W204 C-Class C180K, C200K, C220CDi, C350, C63 AMG (2007-)
<b>9529</b>	Front Wheel Oil Seal Inner	Mercedes-Benz Sprinter BM906 Series 2.2i Bus, P/van, W639 Series Vito 115CDi Bus, Van, P/van (2006-)
<b>9530</b>	Rear Wheel Oil Seal Inner	Mercedes-Benz Sprinter BM906 Series 2.2i Bus, P/van, W639 Series Vito 115CDi Bus, Van, P/van (2006-)

## BUYERS GUIDE - OIL SEALS

<b>9531</b>	Drive Shaft Oil Seal	Mercedes-Benz Sprinter BM906 Series 2.2i Bus, P/van, W639 Series Vito 115CDi Bus, Van, P/van (2006-)
<b>9532</b>	USE 9742	
<b>9533</b>	Cam Oil Seal	Isuzu KB160 1.6 Fleetside P/up, KB200 2.0 LE, Fleetside, D/cab P/up, KB220 2.2 LE, P/up, KB230 2.3 D/cab P/up (89-04), KB260 2.6 LE, D/cab, LX, P/up 4ZE1, KB320 3.2 LE, D/cab, LX, Frontier, Reef, Blazer P/up 6VD1 (92-04), KB220 2.2 LE P/up, KB230 2.3 P/up 4ZD1, KB260 2.6 D/cab, LE, LX, KB320 3.2 V6 Frontier LX - 4X4 (89-04)
<b>9534</b>	Rear Main Bearing Oil Seal	Mercedes-Benz A-Class W168 A160 Classic, Elegance, A190 Elegance (00-05)
<b>9535</b>	Rear Main Bearing Oil Seal	Mercedes-Benz W169 Series/ A Class A180, CDi, CVT, A200, CDi, CVT (2005-)
<b>9536</b>	Timing Cover Oil Seal	Tata Telcoline 2.0 Turbo Diesel P/up (2004-)
<b>9538</b>	Timing Cover Oil Seal	Daihatsu Charade 1.0 (2003-), Sirion 1.0 (00-08), Ford Fiesta 1.4i (04-08)
<b>9539</b>	Timing Cover Oil Seal	Mazda B-Series B2600i 2.6i LWB D/cab Drifter, SLX P/up 4G54 Pet. - 4X2, 4X4 (2000-), Drifter 2.6i LWB Hi Ride, SL Hi Ride S/cab, SLE, SLX D/cab SLX Hi Ride D/cab, SLX Hi Trail D/cab P/up Pet. - 4X2, 2.6i V6 LWB SL S/cab, SLE, SLX D/cab P/up 4G54 Pet. - 4X4 (02-09)
<b>9540</b>	Rear Gearbox Oil Seal	Toyota Fortuner 2.5D-4D 2KD-FTV - 4X2, 4X4 (11-16), Hilux LN192R 3.0iD LWB Raider, Raider D/ cab, P/up KZ-TE Dies. - 4X2, 3.0iD LWB Raider S/cab & KZ-TE D/cab P/up, Legend35 - 4X4 (98-05), 2.5D-4D Raised Body, Std. Body 2KD-FTV 5 Spd Man., 2.7 VVTi 2TR-FE, 3.0D-4D 1KD-FTV - 4X2 (11-16), Hilux "Vigo" 3.0 D-4D TDi Raider, D/C Raider, Raised Body LWB P/up 1KD-FTV Dies., 4.0i D/Cab Raider Raised Body LWB P/up GR-FE Pet. - 4X2 (05-09), 2.7i S/Cab Raider, D/ Cab Raider, S/Cab HO Raised Body LWB P/up 2TR-FE Pet. - 4X2 (05-11), 2.5TDi D-4D S/Cab, S, SRX, S/Cab, S/Cab SRX HO, Raised Body Raider, D/Cab LWB P/up 2KD-FTV, 2.7i Raised Body Raider, D/Cab LWB P/up 2TR-FE Pet., 3.0D-4D TDi D/C Raised Body Raider, Xtra cab, Legend40 LWB P/up KD-FTV Dies., 4.0i D/C Raised Body Raider, Legend40 LWB P/up 1GR-FE Pet. (09-11), Hilux "Revo" 2.0 VVTi 1TR-FE, 2.4 GD-6 Raised Body 2GD-FTV, 2.7 VVTi Raised Body 2TR-FE, 2.8 GD-6 Raised Body 1GD-FTV - 4X2 (2016-), Quantum 2.5 D-4D, "Family", S-long MPV, Van 2KD-FTV Dies., 2.7 "Family", S-long "Ses'fikile" MPV, Van 2TR-FE Pet. (2005-)
<b>9541</b>	Rear Wheel Oil Seal Outer	Nissan Patrol 3.0, 4.2 (95-04)
<b>9542</b>	Rear Wheel Oil Seal Inner	Nissan Patrol 3.0, 4.2 (95-04)
<b>9543</b>	Front Wheel Oil Seal Inner	Kia Sportage 2.0 - 4X4 (99-04)
<b>9544</b>	Front Wheel Oil Seal Outer	Kia Sportage 2.0 - 4X4 (99-04)
<b>9545</b>	Front Wheel Oil Seal Inner	Volvo S40 1.9, 2.0T, V40 1.9, 2.0T (97-98)
<b>9546</b>	Front Wheel Oil Seal Inner	Volvo S40 1.9, 2.0T, V40 1.9, 2.0T (97-98)
<b>9547</b>	Timing Cover Oil Seal	Audi A8 3.7, 4.2 Quattro (96-05), S4 4.2 Quattro (03-05), BMW 120d, 320d, 330d, 335i (2005-), X3 2.0d, 3.0d (2004-), X5 3.0d (2001-), F30 320i, 330i, 340i Sport (2015-), VW Touareg 3.6 FSi, 4.2 FSi (2007-)
<b>9548</b>	Cam Oil Seal	Audi A1 1.2 TFSi CBZA, 1.6 TDi CAYC (11-18), A3 1.8 8L1 AGN, 1.8T AGU, BPU (98-04), 2.0 FSi BVZ, 2.0 FSi 8PA Sportback BLX, 2.0 TFSi CCZA, CBFA, 2.0 TDi BMM, CLJA, 3.2 Quattro, DSG, BUB (03-13), 1.8 TFSi CDAA, 1.9 TDi BXE (08-13), 1.2 TFSi CJZJ, CJZA, 1.4 TFSi CXSA, 1.6 TDi CLHA, 1.8 TFSi Quattro CJSA, CJSB, 2.0 TDi DBGA (12-17), A4 1.8 8D2, B5 Exec ADR, 1.8T APU (95-01), 1.8T Avant, Multitronic, BFB, B6 AVJ 8E2, 1.9 TDi AVF, Avant B6, 8E5, 8E2 (00-08), 2.0 Multitronic Avant 8EC, 8E2 ALT, 2.0 TDi 125, 8EC BLB, Avant Multitronic, 2.0TFSi DTM 147 BGB, 3.2 FSi Quattro, 8EC Multitronic Avant, Tiptronic Avant, AUK (00-08), 2.4 Multitronic, BDV, 2.5 TDi 8D/E2 Quattro AFB, Quattro Tiptronic, 2.6 8D2 / 8D5 Exec., 3.0 Quattro Tiptronic, ASN, 3.0 Cabriolet ASN, 8H7, 3.0 TDi 8EC Quattro BKN, 3.0 TDi Quattro Avant Tiptronic, BKN, ASB (02-08), 1.8 TFSi CABB, CDHB, CJEB, CDHA, CABA, 2.0 T, 2.0 TFSi CAEB, CDNC, GLC, CMGB, 2.0 TDi BRD, CAGA, CJCA, CMEA, CMFA, 2.0 TFSi Quattro CPMA, CDNC, 2.0 TDi Quattro CGLC, 3.0 TDi Quattro CAPA, CCLA, CCWA, CDUC, CKVB, CKVC (08-14), A5 2.0 TFSi, Tdi, 2.0 TFSi Quattro, 3.0 TDi Quattro, 3.2 FSi Quattro (08-14), A6 2.8 Quattro 4A, AAH, ACK, 3.0 Quattro Tiptronic BBJ (94-00), 2.4 Avant Multitronic., Tiptronic, AGA, ALF, AML, APS, ARJ, 2.5TDi Multitronic Avant SW., BCZ/BDG/BFC, 2.6 ABC (97-03), 2.7T Quattro AJK, ARE, BES, 4.2 Quattro Tiptronic ARS (00-08), 2.4 BDV (02-05), 2.0 TFSi BPJ (09-11), 2.0 TDi CGLC, CMGB, 2.0 TFSi CDNB (11-15), A8 3.7 Tiptronic AQG, 4D2, 4.2 Quattro 4E2/8 BFM (95-02), S3 1.8T 8L1 Quattro AMK, BAM, APY (00-04), S4 2.2T Quattro AAN (92-95), 4.2 Quattro, Avant 8E2/E5, S/W, BBK, AQF (03-08), TT 1.8T Coupe, Sport, Roadster, Coupe 8N3/9 APX, 1.8T Quattro APX, BAM, BFV (00-07), 2.0 TFSi BWA, 2.0 TTS Quattro CDLA, CDMA, 3.2 Coupe, Roadster DSG, BHE, BUB (04-10), 1.8 TFSi CDAA, 2.0 TFSi Quattro CCSA, CETA, 2.5 RS Quattro CEPA (10-15), Q3 2.0 TDi CFFB, CLJA, 2.0 TDi Quattro CFGC, CLLB, 2.0 TFSi Quattro CCZC, CPSA (12-15), Q5 2.0 TDi CAHA, CGLB, CMGA, CGLC, CMGB, 2.0 TDi, 3.0 TDi Quattro (09-14), Dodge Caliber 1.8 SE, SXT, EBE, 2.0 TD, SXT, CVT, ECN, 2.4 RT, SXT, EDA (06-12), Journey 2.0 CRD, R/T, ECE, 2.4 SXT, ED3, 2.7 V6 R/T, SXT, EER, 3.6 V6 R/T, SXT, ERB (2008-), Jeep Compass 2.0 ECN, 2.0CRD ECD, ECE, 2.4 ED3, ERZ, Patriot 2.0CRD ECD, ECE (2007-), Seat Altea 2.0FSi Tiptronic, 2.0TDi Man., DSG Auto, Ibiza 1.8T Cupra, BBU, 1.9TDi 96, 118 Cupra, 2.0 AZL, BBX, BPX, BLK, ASZ, BLT, Leon 2.0 Fsi, 2.0T, FSi Cupra, 2.0T Fsi, 2.0TDi (06-09)



# BUYERS GUIDE - OIL SEALS

<p><b>9548... Continued</b></p>	<p>Cam Oil Seal</p>	<p>VW Amarok 2.0 Tdi, 2.0 Bi-Tdi - 4X2, 4X4 (10-16), Beetle 1.8T Coupe APH, 2.0i Cabriolet, Highline AZJ (00-12), 1.2 Tsi, 1.4 Tsi (2012-), Caddy 1.6i Life Van, MPV BGU, 1.9TDi Life, Maxi Van, MPV BJB, 2.0SDi Van, P/van BDJ, 2.0TDi (2004-), CC 2.0TDi (2009-), Crafter 2.5TDi 35 Series SWB P/van, 50 HR Series LWB/ XLWB P/van - 4X4 (07-12), 2.0 TDi, Bi-TDi "35", 2.0 TDi, Bi-TDi "50" (2012-), EOS 2.0 FSi, TSi, TFSi (07-12), Golf IV 1.6i Comfortline, Std., Estate AKL, 1.8, T GTi, Highline AGU/ AGN, 1.9 TDi Highline, Estate AHF, 2.0i Cabrio, Highline APK (99-04), Golf V 1.6i Comfortline, Tiptronic, Trendline BGU, 1.9TDi Comfortline, Highline (04-09), Golf VI 1.4TSi Comfortline, Trendline, Highline, 1.6i Comfortline, Trendline, 1.6TDi, 2.0TDi Highline, DSG (09-13), Golf VII 1.2TSi, 1.4TSi, 2.0 GTi, 2.0TDi (2013-), Jetta IV 1.6i Comfortline, Std. AKL, 1.8T Highline, Exec AGU, 1.9 TDi Highline AHF, 2.0i Highline APK, 2.3 V5 AGZ (99-06), Jetta V 1.4TSi, 1.6TDi, 1.6i Comfortline, Tiptronic, Trendline, 1.9TDi Comfortline, Comfortline DSG, 2.0i Trendline, Comfortline, 2.0FSi Sportline, 2.0 T FSi Sportline DSG, 2.0TDi Sportline (2006-), Jetta VI 1.2TSi, 1.4TSi, 1.6TDi, 2.0TDi (2011-), Kombi T3 2.1 Fi Caravelle, Microbus DJ Pet., 2.3i Microbus, Volkswiebus AFU Pet., 2.5i Microbus, Caravelle AAY Pet., 2.6i Microbus, Caravelle, Exclusive, ADV Pet. - 4X2 (85-04), T4 2.5Tdi Microbus, Caravelle, Trend, High ACV, AAB Dies., Turbo Dies. (99-06), T5 1.9TDi Beach, Van, P/van, S/Cab P/up SWB, D/Cab P/up LWB, Crew Bus AXC Dies., 2.5TDi Beach, California, Caravelle, 96/128, S/Cab, D/cab, HO P/up SWB/ LWB P/up, Crew Bus P/van, Van, AXD Dies., 3.2 Caravelle, S/Cab, D/cab P/up BDL (04-10), 2.0TDi, 2.0 BiTDi (2010-), Passat IV 1.8T AEB, 2.3 V5 AZX, 2.8, 4 Motion, Quattro, Tiptronic ACK/ AMX, 3.2 V6 Sportline DSG AXZ (99-05), Passat V 1.9TDi Comfortline AVB, 2.0FSi Comfortline, Tipt., Highline BCR BLY, 2.0 T FSi Sportline Tiptronic AXX/BPY, 2.0TDi Highline, DSG BKP/BMP, 3.2 V6 Auto. DSG (05-11), Passat (B7) 2.0TSi, 2.0TDi (08-11), Polo 6N 1.4 Classic, Playa Lux AEX, 1.6 Classic, Playa, Lux AEE, 1.8 Classic, Playa, Lux ADZ (96-03), Polo 9N 1.8T GTi, Classic Trendline AKK, 1.9TDi Highline, Classic Highline, Sportline, ATD/ AXR, 2.0i Highline, Classic Highline BBX (02-10), Cross Polo 1.6TDi, 1.9TDi (07-10), Polo 6R 1.2TDi CFWA (10-15), Polo 6C 1.6TDi CLSA (2014-), Scirocco 2.0TSi R (2009-), Sharan 1.8T MPV AJH, 1.9TDi MPV ASZ., 2.8 MPV AAA (99-08), Tiguan 1.4TSi Trend&amp;Fun 5Dr. SUV, 2.0TDi, 2.0TSi Track&amp;Field, Sport&amp;Style Man., Tiptronic 5Dr. SUV, 2.0TDi Track&amp;Field, Sport&amp;Style Man., Tiptronic 5Dr. SUV - 4X2, 4X4 (08-17), Touran 1.9TDi TrendLine DSG MPV, 2.0FSi HighLine MPV AXW, 2.0TDi HighLine, DSG MPV (04-11), Touareg 2.5TDi R5 SUV BAC/ BPE, 3.0TDi SUV BKS, 3.6 FSi SUV BHK/ BHL, 4.2 FSi SUV AXQ, 5.0TDi SUV AYH - 4X4 (04-11)</p>
<p><b>9549</b></p>	<p>Timing Cover Oil Seal</p>	<p>Audi A1 1.4 TFSi CAXA/CAVG (11-18), A3 1.8 8L1 AGN, 1.8T AGU, BPU (98-04), 2.0 FSi BVZ, 2.0 FSi 8PA Sportback BLX, 2.0 TFSi CCZA, CBFA, 2.0 TDi BMM, CLJA, 3.2 Quattro, DSG, BUB (03-13), 1.4 TFSi CMSA, 1.6 TDi CAYC, 1.9 TDi BXE (08-13), 1.4 TFSi CZCA, CZEA, 2.0TDi CRFC (13-17), A4 1.8T Avant, Multitronic, BFB, B6 AVJ 8E2, 1.9 TDi AVF, Avant B6, 8E5, 8E2 (00-08), 2.0 Multitronic Avant 8EC, 8E2 ALT, 2.0 TDi 125, 8EC BLB, Avant Multitronic, 2.0TFSi DTM 147 BGB, 3.2 FSi Quattro, 8EC Multitronic Avant, Tiptronic Avant, AUK (00-08), 2.4 Multitronic, BDV, 2.5 TDi 8D/E2 Quattro AFB, Quattro Tiptronic, 2.6 8D2 / 8D5 Exec., 3.0 Cabriolet ASN, 8H7, 3.0 TDi 8EC Quattro BKN, 3.0 TDi Quattro Avant Tiptronic, BKN, ASB, 3.0 Quattro Tiptronic, ASN (02-08), 2.0 TDi BRD, CAGA, CJCA, CMEA, CMFA, 2.0 TDi Quattro CGLC, 3.0 TDi Quattro CAPA, CCLA, CCWA, CDUC, CKVB, CKVC (08-14), A5 2.0 TFSi, Tdi, 3.0 TDi Quattro (08-14), A6 2.8 Quattro 4A, AAH, ACK, 3.0 Quattro Tiptronic BBJ (94-00), 2.4 Avant Multitronic., Tiptronic, AGA, ALF, AML, APS, ARJ, 2.5TDi Multitronic Avant SW., BCZ/BDG/BFC, 2.6 ABC (97-03), 2.4 BDV, 2.5 TDi BCZ, BDG, BFC, 4.2 Quattro Tiptronic ARS (00-08), 2.0 TFSi BPJ (09-11), 2.0 TDi CGLC, CMGB (11-15), S3 2.0TFSi CDLC (07-13), S4 2.2T Quattro AAN (92-95), TT 1.8T Coupe, Sport, Roadster, Coupe 8N3/9 APX, 1.8T Quattro APX, BAM, BFV (00-07), 2.0 TFSi BWA, 2.0 TTS Quattro CDLA, CDMA, 3.2 Coupe, Roadster DSG, BHE, BUB (06-10), Q3 2.0 TDi CFFB, CLJA, 2.0 TDi Quattro CFGC, CLLB (12-15), Q5 2.0 TDi CAHA, CGLB, CMGA, CGLC, CMGB, 2.0 TDi (09-14), Dodge Caliber 1.8 SE, SXT, EBE, 2.4 RT, SXT, EDA (06-12), Journey 2.0 CRD, R/T, ECE (2008-), Jeep Compass 2.0 ECN, 2.0CRD ECD, ECE, 2.4 ED3, ERZ, Patriot 2.0CRD ECD, ECE (2007-), Seat Altea 2.0FSi Tiptronic, 2.0TDi Man., DSG Auto., Ibiza 1.6 Sport, BAH, 1.8T Cupra, BBU, 1.9TDi 96, 118 Cupra, 2.0 AZL, BBX, BPX, BLK, ASZ, BLT, Leon 2.0 Fsi, 2.0T, FSi Cupra, 2.0T Fsi, 2.0TDi (06-09), VW Amarok 2.0 Tdi, 2.0 Bi-Tdi - 4X2, 4X4 (10-16), Beetle 1.8T Coupe APH, 2.0i Cabriolet, Highline AZJ (00-12), 1.2 Tsi, 1.4 Tsi (2012-), Caddy 1.6i Life Van, MPV BGU, 1.9TDi Life, Maxi Van, MPV BJB, 2.0SDi Van, P/van BDJ, 2.0TDi (2004-), CC 2.0TSi, 2.0TDi (2009-), Crafter 2.5TDi 35 Series SWB P/van, 50 HR Series LWB/ XLWB P/van - 4X4 (07-12), 2.0 TDi, Bi-TDi "35", 2.0 TDi, Bi-TDi "50" (2012-), EOS 1.4 TSi, 2.0 FSi, TSi, TFSi (07-12), Golf IV 1.6i Comfortline, Std., Estate AKL, 1.8, T GTi, Highline AGU/ AGN, 1.9 TDi Highline, Estate AHF, 2.0i Cabrio, Highline APK (99-04), Golf V 1.6i Comfortline, Tiptronic, Trendline BGU, 1.9TDi Comfortline, Highline (04-09), Golf VI 1.4TSi Comfortline, Trendline, Highline, 1.6i Comfortline, Trendline, 1.6TDi, 2.0i GTi, Tiptronic, 2.0TSi 4Motion, 2.0TDi Highline, DSG (09-13), Jetta IV 1.6i Comfortline, Std. AKL, 1.8T Highline, Exec AGU, 1.9 TDi Highline AHF, 2.0i Highline APK, 2.3 V5 AGZ (99-06), Jetta V 1.4TSi, 1.6TDi, 1.6i Comfortline, Tiptronic, Trendline, 1.9TDi Comfortline, Comfortline DSG, 2.0i Trendline, Comfortline, 2.0FSi Sportline, 2.0 T FSi Sportline DSG, 2.0TDi Sportline (2006-), Jetta VI 1.2TSi, 1.4TSi, 1.6TDi, 2.0TDi (2011-), Kombi T3 2.1 Fi Caravelle, Microbus DJ Pet., 2.3i Microbus, Volkswiebus AFU Pet., 2.5i Microbus, Caravelle AAY Pet., 2.6i Microbus, Caravelle, Exclusive, ADV Pet. - 4X2 (85-04), T4 2.5Tdi Microbus, Caravelle, Trend, High ACV, AAB Dies., Turbo Dies. (99-06), T5 1.9TDi Beach, Van, P/van, S/Cab P/up SWB, D/Cab P/up LWB, Crew Bus AXC Dies., 2.5TDi Beach, California, Caravelle, 96/128, S/Cab, D/cab, HO P/up SWB/ LWB P/up, Crew Bus P/van, Van, AXD Dies., 3.2 Caravelle, S/Cab, D/cab P/up BDL (04-10), 2.0TDi, 2.0 BiTDi (2010-), Passat IV 2.3 V5 AZX (03-05), 2.8, 4 Motion, Quattro, Tiptronic ACK/ AMX, 3.2 V6 Sportline DSG AXZ (99-05), Passat V 1.9TDi Comfortline AVB, 2.0FSi Comfortline, Tipt., Highline BCR BLY, 2.0 T FSi Sportline Tiptronic AXX/BPY, 2.0TDi Highline, DSG BKP/BMP, 3.2 V6 Auto. DSG (05-10), Passat (B7) 1.8TSi, 2.0TDi (08-11)</p>

## BUYERS GUIDE - OIL SEALS

<b>9549... Continued</b>	Timing Cover Oil Seal	Polo 9N 1.8T GTi, Classic Trendline AKK, 1.9TDi Highline, Classic Highline, Sportline, ATD/ AXR, 2.0i Highline, Classic Highline BBX (02-10), Cross Polo 1.6TDi, 1.9TDi (07-10), Polo 6R 1.2TDi CFWA (10-15), Polo 6R 1.2TDi CFWA, 1.4 CLSA, CLPB, 1.4TSi GTi CTHE, 1.6 CLSA, 1.6TDi (09-15), Polo 6C 1.6TDi CLSA (2014-), Scirocco 1.4TSi, 2.0TSi R (2009-), Sharan 1.8T MPV AJH, 1.9TDi MPV ASZ., 2.8 MPV AAA (99-08), Tiguan 1.4TSi Trend&Fun 5Dr. SUV, 2.0TDi, 2.0TSi Track&Field, Sport&Style Man., Tiptronic 5Dr. SUV, 2.0TDi Track&Field, Sport&Style Man., Tiptronic 5Dr. SUV - 4X2, 4X4 (08-17), Touran 1.9TDi TrendLine DSG MPV, 2.0FSi HighLine MPV AXW, 2.0TDi HighLine, DSG MPV (04-11)
<b>9550</b>	Timing Cover Oil Seal	Ford Escort FWD MkVI 1.4i H/back, Sedan CVH-PTE, 1.6i GL, GLE H/back, Sedan Zetec, 1.8i GLi, TDi H/back, Sedan Zetec, 1.8TDi Endura (95-00), Fiesta I 1.4, i Flair, Trend, Fun Zetec CVH/PTE, 1.6, i Ambiente', Flair, Forte' Ghia, Rsi, Sport, Trend (97-04), Fiesta II 1.6i RSi, TDCi Rocam, 2.0 ST, ST150 (04-09), Figo 1.4 Ambiente', Trend, FXJA/B (2010-), Ikon 1.4, Low, LX, 1.6i (07-11), Mondeo 1.8i LX, Tdi LX Zetec M5 Endura TD, 2.0i Aspen, CLX, CLX, Ghia, Trend Zetec M5, 2.5i Si Duratec M5 (97-01), Land Rover Discovery III 2.7 TD V6 (05-09)
<b>9551</b>	Front Wheel Oil Seal	Chevrolet Spark 0.8 L, LS, 1.0 LT, LS (03-10), Daewoo Matiz 800cc S, SE F8CV (99-03)
<b>9552</b>	Spark Plug Tube Seal	Toyota Conquest/Tazz AE92R 160i LS, RS, RSi, Sport, RSE, Tazz 4A-F, A-FE, A-GE (88-01), AE92R 160i Edition, Sport, Tazz, XE 4AF (01-06), Corolla FWD AE92R 1.6, 160 GL, GLE, GLi, Exec., GLS, Exec., GLX, Sport Sprinter 4A-F, A-FE, A-GE (88-96), Hilux RZN194 2.7i LWB D/cab, Raider, SRX, Legend35 Raider, 3RZFE Pet. (98-05), Land Cruiser FZJ/HZJ75 4.2 GX S/W, P/up 1FZF/HZ Dies. - 4X4 (93-99)
<b>9553</b>	Drive Shaft Oil Seal	Honda Ballade 150, 160, 180 - Some Models (92-00)
<b>9554</b>	Drive Shaft Oil Seal	Ford B-Max 1.0 EcoBoost M1JE, M1JH (2015-), Escort FWD MkVI 1.4i H/back, Sedan CVH-PTE, 1.6i GL, GLE H/back, Sedan Zetec, 1.8i GLi, TDi H/back, Sedan Zetec, 1.8TDi Endura (95-00), Fiesta I 1.3, i Flair, Flite, Play, Fun Endura-EM5, 1.4, i Flair, Trend, Fun Zetec CVH/PTE, 1.6, i Ambiente', Flair, Forte' Ghia, Rsi, Sport, Trend (97-04), Fiesta II 1.4i Trend Zetec, 1.6i RSi, TDCi Rocam, 2.0 ST, ST150 (04-09), Fiesta III 1.0 EcoBoost, 1.4 Sedan, 1.4i Ambiente', Trend, Titanium, 1.6 Limited, 1.6i Ambiente', Sport, Trend, Titanium, TDCi, 1.6 Gtdi (2008-), Figo 1.4 Ambiente', Trend, FXJA/B, 1.4 TDCi Ambiente', F6JB/D (2010-), Focus I 1.6i 4/5 Door, Ambiente' Zetec S, 1.8 TDCi F9DA, F9DB, 2.0i 4/5 Door, L Trend, RS, ST170 Zetec E (00-05), Focus II 1.6 Si, Ambiente, Trend., 2.0 Si, Trend., TDCi Ghia, TDCi Si., 2.5 ST. HYDA (05-09), Ikon 1.3, Low, LX CLTA, 1.6i, Low, High, LX, CLX CLTA (01-06), 1.4, Low, LX, 1.4 Tdci, 1.6i (07-11), Tourneo / Transit Connect/ Grand Connect 1.0 EcoBoost Trend MPV SWB B3GA, 1.5 TDCi Ambiente Dsl P-Van LWB XWGA, 1.6 TDCi EcoBoost LWB T1GA (2013-), Honda Jazz 1.3 i-VTEC LX Man., Auto., 1.4i L13Z1, 1.5 i-VTEC EX L15A (07-15), Renault Clio III 2.0 Sport, R27, Ltd. Edition F4R832/830 (2010-)
<b>9555</b>	Cam Oil Seal	Ford Fiesta 1.6 Pet. (2008-)
<b>9556</b>	Timing Cover Oil Seal	Ford Fiesta 1.6TDCi (2008-)
<b>9557</b>	Timing Cover Oil Seal	Fiat Strada 1.7D P/up (05-08)
<b>9558</b>	Cam Oil Seal	Fiat Strada 1.2 P/up (05-10)
<b>9560</b>	Rear Wheel Oil Seal	Ford Ranger T6 2.2 D HP, MP, 2.5, 3.2 D Wildtrack, 3.2 TDCi - 4X2, 2.2 D HP, MP, 2.2 D MP, 3.2 D Wildtrack, 3.2 TDCi - 4X4 (2012-), Isuzu KB250Dc 2.5, KB300TDi 3.0 LX (04-09), KB300TDi 3.0 D-TEQ (07-11)
<b>9561</b>	Crankshaft Oil Seal - Front	Ford Ranger T6 2.2, 3.2 - 4X2, 4X4 (2011-), Tourneo 2.2 Tdci LWB & SWB Turbo 6spd Man. (2013-), Transit 2.2 Tdci Hi LWB & SWB, 2.2 Tdci LOW LWB & SWB, 2.2 Tdci Sport SWB (2013-), Land Rover Defender 90/110/130 2.2, 2.4 (2002-), Mazda BT-50 2.2 MZ-CD P4-AT, 3.2 MZ-CD P5-AT - 4X2, 3.2 MZ-CD P5-AT - 4X4 (2012-), Peugeot Boxer 2.2Hdi P2ZDTE (06-17)
<b>9562</b>	Side Shaft Seal	Nissan Navara D40 Series 2.5DCi, LE, SE, XE D/Cab P/up, 4.0i V6, LE D/Cab P/up - 4X2, Navara & Pathfinder D40/ R51 2.5DCi D/Cab P/up, 3.0DCi V6, 4.0i V6, LE D/Cab P/up - 4X4 (05-17)
<b>9563</b>	Rear Wheel Oil Seal For PQ879	Isuzu KB200i 2.0 LX, KB240i 2.4 LX, KB250i 2.5 LX, KB200i 2.0 LX, KB240i 2.4 LX, KB250i 2.5 LX - 4X4 (04-13), KB250Dc 2.5, KB300TDi 3.0 LX - 4X2, 4X4 (04-09), KB300TDi 3.0 D-TEQ - 4X2, 4X4 (07-11)
<b>9564</b>	Rear Wheel Oil Seal For PQ879	Isuzu KB200i 2.0 LX, KB240i 2.4 LX, KB250i 2.5 LX, KB200i 2.0 LX, KB240i 2.4 LX, KB250i 2.5 LX - 4X4 (04-13), KB250Dc 2.5, KB300TDi 3.0 LX - 4X2, 4X4 (04-09), KB300TDi 3.0 D-TEQ - 4X2, 4X4 (07-11)
<b>9565</b>	Crankshaft Oil Seal	Ford "Boet" Bantam Rocam 1.3i XL, XLT, 1.4i TDCi, 1.6i XL, XLT, XLE, 1.8D XL (02-12), Ikon 1.4, Low, LX, 1.4 Tdci, 1.6i (07-11), Ka 1.3i Ambiente, Trend, Collection Rocam A9A, A9B (05-09), Mercedes-Benz W169 A-Class A170 M266.940 (05-13), W176 A180, A200, A250 (2013-), W212 E-Class E200, Cgi, E250, CDi, Cgi (2009-), W245 B-Class B170, B180, B200 CDI, Turbo (05-12), W246 B180, B200, B250 (2012-)
<b>9567</b>	Rear Wheel Bearing Oil Seal	Chevrolet Spark 0.8 L, LS, 1.0 LT, LS (03-10), Daewoo Matiz 800cc S, SE F8CV (99-03)



## BUYERS GUIDE - OIL SEALS

<b>9568</b>	Pinion Oil Seal	Toyota Fortuner 2.5D-4D 2KD-FTV - 4X2, 4X4 (11-16), Hilux "Vigo" 2.0i U16/17 S/Cab, S, SRX LWB Pet. P/up 1TR-FE Pet., 2.5TDi D-4D S/Cab, S, SRX, S/Cab, S/Cab SRX HO, Raised Body Raider, D/Cab LWB 2KD-FTV, 3.0 D-4D TDi Raider, D/C Raider, Raised Body LWB P/up 1KD-FTV Dies., 4.0i D/Cab Raider Raised Body LWB P/up GR-FE Pet. - 4X2 (05-09), 2.7i S/Cab Raider, D/Cab Raider, S/Cab HO Raised Body LWB P/up 2TR-FE Pet. (05-11), 2.0i S/Cab, S, SRX LWB Pet. P/up 1TR-FE Pet., 2.5TDi D-4D S/Cab, S, SRX, S/Cab, S/Cab SRX HO, Raised Body Raider, D/Cab LWB P/up 2KD-FTV, 2.7i Raised Body Raider, D/Cab LWB P/up 2TR-FE Pet. (09-11), 3.0D-4D TDi D/C Raised Body Raider, Xtra cab, Legend40 LWB P/up KD-FTV Dies., 4.0i D/C Raised Body Raider, Legend40 LWB P/up 1GR-FE Pet. (09-16), Hilux 2.0 VVTi 1TR-FE 5 Spd Man. S/cab, 2.5D-4D Raised Body, Std. Body 2KD-FTV 5 Spd Man. - 4X2, 2.5D-4D Raised Body 2KD-FTV 5 Spd man. - 4X4 (11-16)
<b>9569</b>	Timing Cover Oil Seal	Mercedes-Benz W176 A-Class A180 Cdi, A220 Cdi (2013-), Nissan Juke 1.5 dCi K9K - 4X2 (2010-), Micra (K12/13) 1.5 dCi Tekna, Acenta HR15DE (2004-), Micra (K14) 0.9 H4B400 (2018-), NP200 1.5DCi S, SE P/up (2008-), Qashqai 1.5DCi (07-13), Renault Captur 1.5 Dci K9K (2016-), Clio III 1.4 Expression, Extreme, 1.5 DCi Expression., K9K770, 1.6 Expression, Dynamique, Extreme K4M 748, 2.0 (06-10), Duster 1.5DCi K9K, 1.6 K4M (2013-), Fluence 1.6 (11-16), Kadjar 1.5dCi K9K (2015-), Kangoo 1.4 Multix Authentique MPV E7J780, 1.5DCi (03-10), 1.6 (11-13), Logan 1.6 Expression (2009-), Megane III 1.6 DCi (2010-), Scenic 1.6 (11-13)
<b>9570</b>	Gearbox Oil Seal	Alfa Romeo 145 2.0 Quadrofoglio AR32301 (96-01), 146 2.0 Ti Twin Spark AR67204 (96-99), 147 1.6 Progression, TS AR32104, 1.9 JTD, 2.0 Destinctive, Selespeed TS AR3231 (01-10), 155 2.0 TS AR32301 (96-99), GTV/Spider 3.0 V6 (99-04), Fiat Doblo 1.9 Cargo P/van 223A6.000, Multipla 1.9 JTD ELX MPV 182A4.000 (03-06), Palio I 1.2 ED, EL, Go!, Paint Ltd. M657BA.12T 178B5.000, 1.6 EL, ELX, HL, Weekend S/W, 178B3.000 (00-05), Palio II 1.2 Espresso 178B6.000, 1.2 Go!, 178B5.000, 1.6 178B3.000, 1.7TD, EL. (05-10), Panda 1.1 Active, 187A1.000, 1.2 Dynamic 169A4.000, 188A4.000, 1.4 100HP 169A3.000 (2006-), Siena I/II 1.2 EL, EL, Plus!, M657BA 12T, 1.6 EL, Plus!, ELX HL 178B3.000, 1.6 EL+, HL, ELX, 178B3000, 1.7TD EL 176A3.000 (00-10), Stilo 1.9 JTD Dynamic, MultiWagon JTD Dynamic 192A1.000, 937A7.000 (03-06), Strada 1.2 EL P/up, 1.4, 1.6 EL, EL Sporting, ELX P/up, 1.7D EL P/up (05-10), Uno 1.0 Cento 156A2, 1.1 Espresso P/van 160A3, 1.1 Fire, Rio, Mia, Tempo 160A3, 1.4 Pacer, Beat, Mia, Tempo, SX 146C1, 1.4 Turbo 146A (90-95)
<b>9571</b>	Use - 9450	
<b>9572</b>	Timing Cover Oil Seal	Ford Telstar 2.0 GL, GLE, GLi, Mystique FS/KF (94-99), Mazda 2 (DE) 1.3 Active, Dynamic, 1.5 Dynamic, Individual (07-15), 3 (BL, BK) 1.6 Original, Active, Dynamic B6ZE, Z6 (04-14), 626 2.0i 16V Medium High, V6 24V High KF/KS, 2.5i V6 Exec. KL, MX-6 2.5 V6 KL (93-98)
<b>9574</b>	Spark Plug Tube Seal	Nissan Sentra 1.3, 1.4, i, 1.6, i, 1.8i (87-02)
<b>9575</b>	Timing Cover Oil Seal	Dodge Journey 2.7 (2008-)
<b>9576</b>	Timing Cover Oil Seal	Toyota Auris 1.3, 1.6i RS, RT, Corolla FWD 1.3i Impact, Professional, Advanced, (2007-), Yaris 1.3 ZEN3 (10-18)
<b>9577</b>	Front Wheel Oil Seal	Toyota Fortuner 3.0 D-4D SUV 1KD-FTV, 4.0 V6, Epic SUV 1GR-FE Pet. - 4X2, 4X4 (06-11), 2.5D-4D 2KD-FTV, 3.0D-4D 1KD-FTV, 4.0 V6 1GR-FE, 4.0 V6 Raised Body 1GR-FE - 4X4 (11-16), Hilux "Vigo" 2.5TDi D-4D S/Cab, S, SRX, S/Cab, S/Cab SRX HO, Raised Body Raider, D/Cab LWB 2KD-FTV, 3.0 D-4D TDi Raider, D/C Raider, Raised Body LWB P/up 1KD-FTV Dies., 4.0i D/Cab Raider Raised Body LWB P/up GR-FE Pet. - 4X2, 3.0 D-4D TDi D/C Raider 1KD-FTV Dies., LWB P/up, 4.0 D/Cab Raider 1GR-FE Pet. LWB P/up - 4X4 (05-09), 2.7i S/Cab Raider, D/Cab Raider, S/Cab HO Raised Body LWB P/up 2TR-FE Pet. - 4X2 (05-11), 2.5TDi D-4D S/Cab, D/Cab SRX, Legend40 2KD-FTV Dies. LWB P/up, 2.7i S/Cab SRX, Legend40 2TR-FE Pet. LWB P/up - 4X4 (05-15), 3.0D-4D TDi D/C xtra cab, Raider, Legend40 1KD-FTV Dies. LWB 4.0 D/Cab Raider, 1GR-FE Pet. - 4X4 (2009-), 2.5TDi D-4D S/Cab, S, SRX, S/Cab, S/Cab SRX HO, Raised Body Raider, D/Cab LWB P/up 2KD-FTV, 2.7i Raised Body Raider, D/Cab LWB P/up 2TR-FE Pet. (09-11), 3.0D-4D TDi D/C Raised Body Raider, Xtra cab, Legend40 LWB P/up KD-FTV Dies., 4.0i D/C Raised Body Raider, Legend40 LWB P/up 1GR-FE Pet. (09-16), Hilux 2.5D-4D Raised Body 2KD-FTV 5 Spd man. - 4X4 (11-16), 2.7 VVTi 2TR-FE, 3.0D-4D 1KD-FTV, 4.0 1GR-FE - 4X2 (11-16), 3.0D-4D 1KD-FTV, 4.0 1GR-FE - 4X4 (11-16), Hilux "Revo" 2.4 GD-6 2GD-FTV, 2.8 GD-6 Raised Body 1GD-FTV, 4.0 V6 Raised Body 1GR-FE - 4X4 (2016-)
<b>9578</b>	Timing Cover Oil Seal	Ford Ecosport 1.0 (2013-), 2008- Fiesta III 1.0 (2008-)
<b>9579</b>	Rear Main Bearing Oil Seal	Ford B-Max 1.0 EcoBoost M1JE, M1JH (2015-), Ecosport 1.0 (2013-), 2008- Fiesta III 1.0 (2008-), Tourneo / Transit Connect/Grand Connect 1.0 EcoBoost Trend MPV SWB B3GA, 1.5 TDCi Ambiente Dsl P-Van LWB XWGA, 1.6 TDCi EcoBoost LWB T1GA (2013-)
<b>9581</b>	Timing Cover Oil Seal	Audi A3 (08-14), A4 (07-14), A5 (08-14), A6, S3 2.0TFSi CJXB (11-14), TT 1.8, 2.0, 2.5 (10-14)
<b>9583</b>	Timing Cover Oil Seal	Audi A5 3.0 TDi Quattro (12-14), Ford B-Max 1.0 EcoBoost M1JE, M1JH (2015-)
<b>9584</b>	Rear Main Bearing Oil Seal	Audi A4 3.0TDi, A5 3.0TDi (12-14), TT 2.5 (10-14), Q5 3.0TDi (13-14)
<b>9588</b>	Timing Cover Oil Seal	Audi A3 1.2 TFSi, 1.4 TFSi (12-14), VW Golf VII 1.4 (2013-), UP 1.0 (2015-)
<b>9590</b>	Timing Cover Oil Seal	Audi A1 1.0 TFSi (11-18), A3 1.2 TFSi, 1.4 TFSi (12-14), VW Golf VII 1.4 (2013-), UP 1.0 (2015-)
<b>9591</b>	Timing Cover Oil Seal	Audi A1 1.0 TFSi (11-18), A3 1.2 TFSi, 1.4 TFSi (12-14), VW Golf VII 1.4 (2013-), UP 1.0 (2015-)
<b>9593</b>	Cam Oil Seal	Audi A4 3.0 (02-08)
<b>9595</b>	Rear Main Bearing Oil Seal	BMW 1 Series 125i (11-16), F30/1 3 Series 320i, 328i, 335i (2012-), F7, F10/1, F18 523i, 528i (2011-), 535i (-2011), X1 2.8 (09-15), X3 3.5 (2010-), X5 3.5 (2013-), F30 320i (2015-)

## BUYERS GUIDE - OIL SEALS

<b>9596</b>	Timing Cover Oil Seal	BMW 11-16 1 Series F20/1 125i, 2012- F30/1/4 3 Series 320i, 328i 335i, 2011- F7/10/1, F18 528i, 09-15 X1 2.8, 2015- F30 320i
<b>9597</b>	Cam Oil Seal	BMW 1 Series F20/1 125i (11-16), F30/1 3 Series 328i (2012-), X1 2.8 (09-15)
<b>9598</b>	Rear Main Bearing Oil Seal	BMW F30/34/1 3 Series 320d, 330d (2012-), E60/1 5 Series 250d (2004-), F7, 10/1, F18 Series 520d, 530d, 535d (2011-), X1 2.0, 2.3, 2.5 (09-15), X3 2.0, 2.8, 3.0 (2010-), X5 3.0d, 4.0d (2013-), F30 320d (2015-)
<b>9599</b>	Timing Cover Oil Seal	BMW F30/1 3 Series 320d, 330d (2012-), E60/1 5 Series 520d (2004-), F7/10/1, F18 Series 520d, 530d, 535d (2011-), X1 2.0, 2.3, 2.5 (09-15), X3 2.0, 2.8, 3.0 (2010-), X5 3.0d, 4.0d (2013-), F30 320d (2015-)
<b>9601</b>	Rear Wheel Oil Seal	Toyota Condor 1.6 Estate, TE, 5L, 1.8 2Y, 2.0i Estate, TE, 1RZ Pet., 2.4i Estate, TE, TX 2RZ-E, 3.0D Estate, TE, 5L Dies. - 4X2, 2.4i Estate, TX Estate 2RZ-E, 3.0 Estate, TX Estate 5L - 4X4 (00-05), Stallion KF50 1.5 SR5, Commuter, Bus, P/up, P/van 5K Pet., YF50 1.8 SR5, P/up, P/van, Van 2Y Pet., LF50 2.4D P/up 2L5F Dies. (87-04), TUV KF20 1.3 Chassis Cab, P/up, P/van, Bus 4K Pet., 1.5 P/up 5K Pet. (82-87)
<b>9602</b>	Rear Main Bearing Oil Seal	Isuzu KBD23 2.5 LE, P/up 4JA1, KBD25 2.0 P/up C190 (78-89), KBD26 2.0 P/up C190, KBD27 2.2 C223, KBD28 2.5 4JA1 (81-89), KB27 1.8 P/up G180Z, KB28 2.0 P/up G200Z, KB29 2.3 P/up 4ZD1 (83-89), KB40 1.6 G161Z, KB41 1.6 G161Z, 1.8 G180Z, KB42 1.8 G180Z, KB43 2.0 G200Z, KB44 2.3 4ZD1 - 4X4 (79-89), KB160 1.6 Fleetside P/up, KB200 2.0 LE, Fleetside, D/cab P/up, KB220 2.2 LE, P/up, KB230 2.3 D/cab P/up (89-04), KB260 2.6 LE, D/cab, LX P/up 4ZE1, KB320 3.2 LE, D/cab, LX, Frontier, Reef, Blazer P/up 6VD1 (92-04), KB220 2.2 LE P/up, KB230 2.3 P/up 4ZD1, KB260 2.6 D/cab, LE, LX, KB320 3.2 V6 Frontier LX (89-04), KB250D 2.5 Fleetside, LE, D/Cab P/up 4JA1, KB280DT 2.8 D/cab LE, LX, Frontier P/up Turbo 4JB1 - 4X2, KB250D 2.5 LE, D/cab P/up 4JA1, KB280DT 2.8 LE, LX, D/cab P/up Turbo 4JB1 - 4X4 (89-04), Relay .0 P/van, Bus 4ZC1 (89-95), WFR 1.8 11FVX/ 12FVX Bus, P/van 4ZB1 (83-89)
<b>9603</b>	Front Wheel Oil Seal	Isuzu KB40 1.6 G161Z, KB41 1.6 G161Z, 1.8 G180Z, KB42 1.8 G180Z, KB43 2.0 G200Z, KBD40, KBD41 2.0 P/up C190, KBD42 2.2 P/up C223 - 4X4 (79-89), Relay 2.0 P/van, Bus 4ZC1 (89-95), WFR 1.8 11FVX/ 12FVX Bus, P/van 4ZB1 (83-89)
<b>9605</b>	Pinion Oil Seal	Nissan 1-Tonner/Hardbody AW/D21 2.4 Z24S, 2.7 TD27, 3.0 VG30E - 4X4 (88-99), 720 D20 1.8 L18S, 2.0 NA20, 2.2 Z22 - 4X4 (80-88), Patrol Y60 3.0 VG30E - 4X4 (95-00), Sani AW/D21 2.2 Z22, 2.4 Z24, 2.7 TD27, 3.0 VG30E - 4X4 (86-98)
<b>9606</b>	Front Wheel Oil Seal	Daihatsu Charade 0.8 CX, CXL G11 CB22, Turbo G21 CB60 (83-85), Cuore 847cc ED10 (97-03)
<b>9607</b>	Front Wheel Oil Seal	Daihatsu Charade 0.8 CX, CXL G11 CB22, Turbo G21 CB60 (83-85), Cuore 847cc ED10 (97-03)
<b>9608</b>	Rear Main Bearing Oil Seal	Daihatsu Charade 0.8 (83-85)
<b>9610</b>	Gearbox Oil Seal Rear	Nissan B140 1.4 A14SP/van, S/W, Deluxe, Std. Sport, CHAMP P/up (80-08)
<b>9611</b>	Front Wheel Oil Seal Outer	Nissan 720 D20 C,D 1.8 (-1984)
<b>9612</b>	Front Wheel Oil Seal Inner	Nissan 720 D20 C,D 1.8 (-1984)
<b>9616</b>	Pinion Oil Seal	Isuzu KB20 1.6 P/up G161Z Pet., KB21 1.6 P/up G161Z Pet., KB22 1.8 P/up G180Z Pet., KBD20 2.0 P/up C190, KBD21 2.0 P/up C190, KBD22 2.2 LE, P/up C223, KB23 2.0 P/up G200Z, KB24 2.3 LE 4ZD1, KB25 1.6 P/up G161Z, KB26 1.6 P/up G161Z, 1.8 P/up G180Z, KBD23 2.5 LE, P/up 4JA1, KBD25 2.0 P/up C190 (78-89), KBD26 2.0 P/up C190, KBD27 2.2 C223, KBD28 2.5 4JA1 (81-89), KB27 1.8 P/up G180Z, KB28 2.0 P/up G200Z, KB29 2.3 P/up 4ZD1 (83-89), KB40 1.6 G161Z, KB41 1.6 G161Z, 1.8 G180Z, KB42 1.8 G180Z, KB43 2.0 G200Z, KB44 2.3 4ZD1, KBD40, KBD41 2.0 P/up C190, KBD42 2.2 P/up C223 - 4X4 (79-89), Relay 2.0 P/van, Bus 4ZC1 (89-95)
<b>9618</b>	Gearbox Oil Seal Rear	Isuzu KB20 1.6 P/up G161Z Pet., KB21 1.6 P/up G161Z Pet., KB22 1.8 P/up G180Z Pet., KBD20 2.0 P/up C190, KBD21 2.0 P/up C190, KBD22 2.2 LE, P/up C223, KB23 2.0 P/u G200Z, KB25 1.6 P/up G161Z, KB26 1.6 P/up G161Z, 1.8 P/up G180Z, KBD25 2.0 P/up C190 (78-89), KBD26 2.0 P/up C190 (81-89), KB27 1.8 P/up G180Z, KB28 2.0 P/up G200Z (83-89), Relay 2.0 P/van, Bus 4ZC1 (89-95)
<b>9620</b>	Rear Main Bearing Oil Seal	Ford Husky 1.8 1 Ton P/up 4G62, 2.0 1 Ton P/up, Bus, P/van 4G63 (85-99), Hyundai Bakkie 2.5i D4BH Dies., 2.6i D4BB Dies. (97-01), H100 P/Van 2.5i D4BH Dies., 2.6i D4BB Dies. (00-07), Elantra J1 1.6 Exec., G4CR, 1.8 Exec., G4CN (93-95), S-Coupe 1.5 (94-95), J2 1.6 RD G4GR, 1.8 G4FG, 2.0 G4GC (95-01), XD 1.6 G4ED, 2.0 G4GC, CRDi D4EA (02-07), HD 2.0 GLS, G4GC (07-11), Getz 1.3 G4EA, 1.4i G4EE, 1.5 D3EA, D4FA, 1.6 G4ED-G (03-12), i30 2.0 G4GC-G (2010-), Sonata Y3 2.0 G4CP (94-04), Tiburon 2.0 G4DF (96-10), Tucson JM 2.0 G4GC, 2.0 CRDi D4EA, 2.7i V6 G6BA-G - 4X2 (04-10), Sportage JE 2.0 SUV G4GC, 2.0 CRDi SUV D4EA - 4X2, 4X4 (04-10), Mazda B-Series B2600 2.6 LWB D/cab, Magnum, Drifter P/up 4G54 Pet. - 4X2, 4X4 (86-95), Mitsubishi Canter 2.5 SWB/LWB D/side, Chassis cab 4G55 Dies., 2.6 4G54 Pet. (80-97), Colt LDV 2.0 4G63 Pet., 2.5D 4D56 Dies., 2.6 WB Hi-Line P/up 4G54 Pet. -4X2, 2.5D LWB Hi-Line P/up 4D56 Dies., 2.6 LWB Lo-/Hi-Line, P/up 4G54 Pet. - 4X4 (94-98), L300 1.8 4G62 Pet., 2.0 P/up 4G63 Pet., Starwagon 2.0 S, SL, SLE, P/up, P/van 4G63 Pet. (82-01)
<b>9621</b>	Rear Wheel Oil Seal Inner	Mitsubishi Canter 2.5, 2.6, 3.3, 3.8 (80-97)

## BUYERS GUIDE - OIL SEALS

<b>9622</b>	Drive Shaft Oil Seal	Honda Ballade SA4 1300 EN4 (82-85), SC9 "Flip Up Lights" 130 EV2, 150, i EW, 160i DOHC ZC1 (84-89), SH4 150 16V SOHC D15B3, 160i 16V SOHC, DOHC D16A9 (89-92), SR4 150 Encore, Luxline, Spreeline D15B3, 160E, i D16A7, 180E, i B18B3 (92-98), SO4 150i Encore, Luxline, Spreeline D15Z4, 160i Luxline, Spreeline, V-Tec D16Y9, D16Z, 180i Luxline B18B4 (96-00), Civic SO3 150i Luxline, Spreeline D15Z4, 160i Luxline, V-Tec D16Z (96-00), Civic VII 150i, 170i V-Tec (03-06), CR-V 2.0 5 Dr. SUV B20Z1, CR-V CTDi - 4X4 (1997-), Jazz 1.4 Dsi, 1.5 V-TEC L15A (03-07), 1.3 i-VTEC LX Man., Auto., 1.4i L13Z1, 1.5 i-VTEC EX L15A (07-15), Hyundai Accent X3 1.3 G4EH, 1.5 G4EK (94-00), LC 1.3 G4EH, 1.5 G4EK, 1.6 G4ED (00-06), Accent 1.6 G4FG Pet. (2017-), Atos 1.0 Prime G4HC (00-05), 1.1 G4HG (2005-), Elantra J1 1.6 Exec., G4CR, 1.8 Exec., G4CN (93-95), J2 1.6 RD G4GR, 1.8 G4FG, 2.0 G4GC (95-01), XD 1.6 G4ED, 2.0 G4GC, CRDi D4EA (02-07), Getz 1.3 G4EA, 1.4i G4EE, 1.5 D3EA, D4FA, 1.6 G4ED-G (03-13), Grand i10 1.1 G3LA, 1.2 G4LA (2014-), i10 1.1 G4HG 1.2 G4LA (08-14), S-Coupe 1.5 (94-95), Sonata Y3 2.0 G4CP, 2.5 V6 G6BV, 3.0 V6 G6AT (94-04), Tiburon 2.0 G4DF (96-10), Kia Picanto 1.1 LX, EX 5 Dr. H/back G4HG (04-11), Rio IV 1.2 G4LA, 1.4 G4LC (2017-)
<b>9623</b>	Front Wheel Oil Seal	Hyundai Accent X3 1.3 G4EH, 1.5 G4EK (94-00), Atos 1.0 Prime G4HC (00-05), Elantra J1 1.6 Exec., G4CR, 1.8 Exec., G4CN (93-95), S-Coupe 1.5 (94-95)
<b>9626</b>	Timing Cover, Cam Oil Seal	Chevrolet Trailblazer 2.5D XLD25, LVN, 2.8D LWH, 3.6 LY7 - 4X2, 4X4 (12-14), Honda Ballade SC9 "Flip Up Lights" 130 EV2, 150, i EW, 160i DOHC ZC1 (84-89), SH4 150 16V SOHC D15B3, 160i 16V SOHC, DOHC D16A9 (89-92), SR4 150 Encore, Luxline, Spreeline D15B3, 160E, i D16A7, 180E, i B18B3 (92-98), SO4 150i Encore, Luxline, Spreeline D15Z4, 160i Luxline, Spreeline, V-Tec D16Y9, D16Z, 180i Luxline B18B4 (96-00), Atos 1.0 Prime G4HC (00-05), 1.1 G4HG (2005-), Jeep Cherokee (KJ) 2.5CRD KJ R425, 2.8CRD KJ ENR (02-08), Volvo C30 2.5i T5, R-Design Man., Geartronic (08-13), C70 2.3 Cabrio, Coupe B5234 T3/ T9 (99-06), S40 2.0T 4Dr. Sedan B4204 T2/T3, V40 2.0T Estate B4204S (97-04), S40 2.5i D5 Sedan Man Geartronic (2004-), S70 2.3 T5 Cabrio, Coupe B5434T4, 2.4 Cabrio, Coupe B5254S, V70 2.3 T5 Estate B5434T4, 2.4, T Estate B5254S, 2.5T Estate (97-04), S80 2.4T TS D5244T, 2.5T D5252T, 2.9 TS Executive (02-06), S90 2.9 X44 B6304S, V90 2.9 X44 B6304S (97-00), V50 2.5i T5 B5254T (All models available in Manual or Geartronic) (04-12), V70 2.4 XC Estate B5254S, XC70 2.5T Estate, XC90 2.9 T6 5/ 7 Seater Estate B6304 (00-06)
<b>9627</b>	Timing Cover, Cam Oil Seal	Ford Husky 1.8 1 Ton P/up 4G62, 2.0 1 Ton P/up, Bus, P/van 4G63 (85-99), Sapphire 2.0, i GL, GLE, GLEA, GLi, GLi Exec. Koln (89-93), Sierra 2.0 LX Koln (83-93), GWM Steed 3 2.2i S/Cab, D/Cab (10-13), Honda Ballade SA4 1300 EN4 (82-85), Hyundai Accent X3 1.3 G4EH, 1.5 G4EK (94-00), LC 1.3 G4EH, 1.5 G4EK (00-06), Bakkie 2.5i D4BH Dies., 2.6i D4BB Dies. (97-01), H100 P/Van 2.5i D4BH Dies., 2.6i D4BB Dies. (00-07), Elantra J1 1.6 Exec., G4CR, 1.8 Exec., G4CN (93-95), J2 1.6 RD G4GR, 1.8 G4FG, 2.0 G4GC (95-01), XD 1.6 G4ED, 2.0 G4GC, CRDi D4EA (02-07), Getz 1.3 G4EA, 1.4i G4EE, 1.5 D3EA, D4FA, 1.6 G4ED-G (03-12), S-Coupe 1.5 (94-95), Sonata Y3 2.0 G4CP, 2.5 V6 G6BV, 3.0 V6 G6AT (94-04), Tiburon 2.0 G4DF (96-10), Tucson JM 2.0 G4GC, 2.0 CRDi D4EA, 2.7i V6 G6BA-G - 4X2, 4X4 (04-10), Kia Picanto 1.1 LX, EX 5 Dr. H/back G4HG (04-11), Mitsubishi Colt LDV 1.6 SWB/LWB Lo-Line P/up 4G32 Pet., 2.0 4G63 Pet., 2.5D 4D56 Dies., 2.6 WB Hi-Line P/up 4G54 Pet., 2.8D LWB Std., Hi line P/up Dies., 2.8TDi LWB Club Cab S cab, Turbo, 3.0i V6 LWB Club S/cab P/up Pet. (94-98), 2.5D LWB Hi-Line P/up 4D56 Dies., 2.6 LWB Lo-/Hi-Line, P/up 4G54 Pet., 3.0 V6 LWB Lo-/Hi-Line D/cab, Rodeo 6G72 Pet. - 4X4 (95-98), 2.0 LWB Std. P/up, 2.0i LWB Hi-Line, 2.4i LWB Hi-Line Rodeo S-/D/cab, Hi-Line/Rider P/up Pet., 2.5D 4D56 Dies. (98-09), 2.4i LWB Hi-Line D/cab, Trailbuster S/cab, P/up Pet. - 4X4 (98-09), 2.8TDi LWB Pioneer, Rodeo D/cab P/up Turbo Dies., 3.0i V6 LWB Rodeo D/cab P/up Pet. (99-09), 2.8D, TDi LWB Club cab, Trailbuster S/cab, Rodeo /cab P/up Dies./ Turbo Dies., 3.0i V6 LWB Rodeo D/cab P/up Pet. - 4X4 (99-09), L300 1.6 Mini Bus, Van 4G32 Pet., 1.8 4G62 Pet., 2.0 P/up 4G63 Pet., Starwagon 2.0 S, SL, SLE, P/up, P/van 4G63 Pet. (82-01), Lancer 1.6 GLX 4G18 (03-08), Pajero 2.8 Tdi, 3.0 V6 SWB GLS Wagon 6G72 Pet., 3.5 V6 SWB GLS Wagon 6G74 Pet. - 4X4 (90-01), Triton 2.5 Di-D D/cab P/up - 4X2, 4X4 (2007-), Opel Kadett E 200 CD 20SHE (87-93), Kadett F 200is 20XE (93-99), Monza 2.0 CD (86-93), Peugeot Partner 1.9D (03-10), Tata Telcoline 2.0 Turbo Diesel S/Cab P/up - 4X2, 4X4 (04-10)
<b>9628</b>	Rear Wheel Oil Seal	Ford Husky 1.8 1 Ton P/up 4G62, 2.0 1 Ton P/up, Bus, P/van 4G63 (85-99), Mitsubishi L300 1.6 Mini Bus, Van 4G32 Pet., 1.8 4G62 Pet., 2.0 P/up 4G63 Pet., Starwagon 2.0 S, SL, SLE, P/up, P/van 4G63 Pet. (82-01)
<b>9629</b>	Timing Cover Oil Seal	Mazda B2200 (83-86), E3000 (67-81), T3000 (81-86)
<b>9633</b>	Rear Wheel Oil Seal	Ford Bantam 1300 P/up Kent 2V, 1400 Leisure, Nite P/up CVH/FUA, 1600 Leisure Explorer, Nite P/up CVH (83-94), Mazda 323 FWD 130 Explorer P/up B3, 160, i Explorer, Leisure, Sport, P/up B6/ F6 (94-03), 130 Hatch, Midge, Sedan, Sting B3, 160, i, S Hatch, Midge, Sedan, Sting F6, 200i, e Hatch 8/16V FE 2000 (95-05), Mazda Rustler 1.3 SWB P/up Kent 2V Pet., 1.4 SWB P/up CVH/ FUA Pet., 1.6 SWB, LX P/up CVH/ LUC Pet. (86-94), 130 SWB Drifter, Explorer P/up B3 Pet., 160, i SWB Explorer, Drifter P/up F6/B6i Pet. (94-02)
<b>9634</b>	Timing Cover, Cam, Pinion	Ford Bantam 1300 P/up Kent 2V (83-94), Fiesta I 1.3, i Flair, Flite, Play, Fun Endura-EM5 (97-04), Ikon 1.6i, Low, High, LX, CLX CLTA (01-06), Ka 1.3i Ambiente, Trend, Collection Rocam A9A, A9B (05-09), Sapphire 1.6 L Kent (89-93), Sierra 1.6 GL, GL S/W, L Kent (83-93), Mazda 121 Soho 1.3, i 3/5 Dr. H/back Endura-EM5 (97-99), Rustler 1.3 SWB P/up Kent 2V Pet. (86-94)



## BUYERS GUIDE - OIL SEALS

<b>9636</b>	Gearbox Oil Seal Rear	Hyundai Bakkie 2.5i D4BH Dies., 2.6i D4BB Dies. (97-01), H100 P/Van 2.5i D4BH Dies., 2.6i D4BB Dies. (00-07), Mitsubishi Canter 2.5 SWB/LWB D/side, Chassis cab 4G55 Dies., 2.6 4G54 Pet. (80-97), Colt LDV 1.6 SWB/LWB Lo-Line P/up 4G32 Pet., 2.0 4G63 Pet., 2.5D 4D56 Dies., 2.6 WB Hi-Line P/up 4G54 Pet. (94-98), 2.0 LWB Std. P/up, 2.0i LWB Hi-Line, 2.4i LWB Hi-Line Rodeo S-/D/cab, Hi-Line/Rider P/up Pet., 2.5D 4D56 Dies. - 4X2, 2.4i LWB Hi-Line D/cab, Trailbuster S/ cab, P/up Pet. - 4X4 (98-09), L300 1.6 Mini Bus, Van 4G32 Pet., 1.8 4G62 Pet., 2.0 P/up 4G63 Pet., Starwagon 2.0 S, SL, SLE, P/up, P/van 4G63 Pet. (82-01)
<b>9637</b>	Pinion Oil Seal	Ford Husky 1.8, 2.0 (Import) (85-99), Mitsubishi L300 1.6, 1.8 2.0 (Import) (82-99)
<b>9638</b>	Gearbox Oil Seal	Mitsubishi Canter 3.3, 3.8 (80-97)
<b>9639</b>	Rear Wheel Oil Seal Outer	Mitsubishi Canter 2.5, 2.6, 3.3, 3.8 (80-97)
<b>9641</b>	Rear Wheel Oil Seal	Toyota Land Cruiser FJ80 4.0 DLX, GX, VX P/up 3F/F-E Pet. - 4X4 (90-92), FZJ/HZJ75 4.2 GX S/W, P/up 1FZF/HZ Dies. - 4X4 (91-97), FZJ80 4.5 Std., GX, VX, Turbo S/W, P/up 1FZ-FE Dies., Turbo Dies. (92-06), HDJ/HZJ80 4.2 GX, Turbo S/W, P/up 1HD-FT, 1HZ Dies., T. Dies. (90-95), HDJ/HZJ80 4.2 Std., GX, VX, Turbo S/W, P/up 1HD-FT, 1HZ Dies., Turbo Dies. (95-01), PHJ75 3.9 DLX, GX, GX Turbo P/up Perkins 236 2H Dies., FJ75 4.0 DLX, GX, VX 3F/F-E Pet., HJ75 (85-92), Stout RK110 2.0 SWB P/up 5R Pet. (79-89)
<b>9642</b>	Rear Main Bearing Oil Seal	Geely MK 1.5 MR479QA, 1.6 MR481QA (2010-), Toyota Conquest/Tazz 1.6 GL, RS, RSi 4A-L, A-GEL, AE92R 160i LS, RS, RSi, Sport, RSE, Tazz 4A-F, A-FE, A-GE, AE92R 160i Edition, Sport, Tazz, XE 4AFE (85-06), Conquest AE93 180i RS, RSi, Sport 7A-FE (93-96), Corolla KE70 1.3 P/ van 4K (84-88), Corolla FWD AE82R 1.6 GL, GLE, GLi, GLS, GLX, Avante, GLE, GLi, S/W 4A-L, A-GEL (84-88), AE/EE80R 1.3 GL, L, 2A-L, E-L (84-88), AE92R 1.6, 160 GL, GLE, GLi, Exec., GLS, Exec., GLX, Sport Sprinter 4A-F, A-FE, A-GE (88-96), AE93R 180i GL, GLE, GSE, GSX, Sprinter 7A-FE (93-96), AE111R 160i GL, GLE, RSi, RXi 4A-FE, A-GE (96-02), Stallion KF50 1.5 SR5, Com-muter, Bus, P/up, P/van 5K Pet. (87-04), Tuv KF20 1.3 Chassis Cab, P/up, P/van, Bus 4K Pet., 1.5 P/up 5K Pet. (82-87)
<b>9643</b>	Timing Cover, Cam Oil Seal	Toyota Condor 2.4i Estate, TE, TX 2RZ-E - 4X2, 2.4i Estate, TX Estate 2RZ-E, 3.0 Estate, TX Estate 5L - 4X4 (00-05), Conquest/Tazz 1.6 GL, RS, RSi 4A-L, A-GEL, AE92R 160i LS, RS, RSi, Sport, RSE, Tazz 4A-F, A-FE, A-GE, AE92R 160i Edition, Sport, Tazz, XE 4AFE (85-06), Conquest AE93 180i RS, RSi, Sport 7A-FE (93-96), Corolla FWD AE82R 1.6 GL, GLE, GLi, GLS, GLX, Avante, GLE, GLi, S/W 4A-L, A-GEL (84-88), AE/EE80R 1.3 GL, L, 2A-L, E-L (84-88), AE92R 1.6, 160 GL, GLE, GLi, Exec., GLS, Exec., GLX, Sport Sprinter 4A-F, A-FE, A-GE (88-93), AE93R 180i GL, GLE, GSE, GSX, Sprinter 7A-FE (93-96), AE111R 160i GL, GLE, RSi, RXi 4A-FE, A-GE, AE112 180i GLE, GSE 7A-FE (96-02), KS1 160i GLE, GLS, GSX, Sprinter VVT-i 3ZZ-FE DOHC, GF2 180i GLE, GLS, GSX, Sprinter VVT-i 1ZZ-FE DOHC (02-08), Corolla Verso ZZE122 160i S, SX MPV, 180i SX, SX MMT, TX, TX MMT MPV 1ZZ-FE (04-09), Hilux RN58 2.4 22R Pet., LN140/145 2.4i DLX, P/up 2L Dies., RZN194 2.7i LWB D/cab, Raider, SRX, Legend35 Raider, 3RZFE Pet. (94-05), Hilux "Vigo" 2.5TDi D-4D S/Cab, S, SRX, S/Cab, S/Cab SRX HO, Raised Body Raider, D/ Cab LWB 2KD-FTV, 2.7i S/Cab Raider, D/Cab Raider, S/Cab HO Raised Body LWB P/up 2TR-FE Pet. - 4X2 (05-11), 2.5TDi D-4D S/Cab, D/Cab SRX, Legend40 2KD-FTV Dies. LWB P/up - 4X4 (05-15), 2.5TDi D-4D S/Cab, S, SRX, S/Cab, S/Cab SRX HO, Raised Body Raider, D/Cab LWB P/ up 2KD-FTV, 2.7i Raised Body Raider, D/Cab LWB P/up 2TR-FE Pet. (09-11), Runx 140i RT, RS, Sport 4ZZ-FE, 160i RS, RT, RX, Sport 3ZZ-FE, 180i RSi, RX 1ZZ-FE (03-08), Stallion KF50 1.5 SR5, Commuter, Bus, P/up, P/van 5K Pet., YF50 1.8 SR5, P/up, P/van, Van 2Y Pet., LF50 2.4D P/ up 2L5F Dies. (87-04), Venture YF50 1.8 8/10 Seater P/van 2Y Pet., 2.2 10 Seater, GLE, Getaway 9 Seater S/W 4Y Pet., LF50 2.4D 10 Seater S/W 2L5F Dies. (91-04)
<b>9644</b>	Rear Wheel Oil Seal	Ford Bantam 130 Explorer P/up B3, 160, i Explorer, Leisure, Sport, P/up B6/ F6 (94-03), "Boet" Bantam Rocam 1.3i XL, XLT, 1.4i TDCi, 1.6i XL, XLT, XLE, 1.8D XL (02-12), Escort FWD MkVI 1.4i H/back, Sedan CVH-PTE, 1.6i GL, GLE H/back, Sedan Zetec, 1.8i GLi, TDi H/back, Sedan Zetec, 1.8TDi Endura (95-00), Fiesta I 1.3, i Flair, Flite, Play, Fun Endura-EM5, 1.4, i Flair, Trend, Fun Ze-tec CVH/PTE, 1.6, i Ambiente', Flair, Forte' Ghia, Rsi, Sport, Trend (97-04), Ikon 1.3, Low, LX CLTA, 1.6i, Low, High, LX, CLX CLTA (01-06), Ka 1.3i Ambiente, Trend, Collection Rocam A9A, A9B (05-09), Mazda 121 Soho 1.3, i 3/5 Dr. H/back Endura-EM5, 1.4i 3/5 Dr. H/back Zetec CVH/PTE (97-99), Toyota Conquest/Tazz EE80 1.3 GL, GS, L, S 2EL, AE82R 1.6 GL, RS, RSi 4A-L, A-GEL, Corolla FWD 1.6 GL, GLE, GLi, GLS, GLX, Avante, GLE, GLi, S/W 4A-L, A-GEL, AE/EE80R 1.3 GL, L, 2A-L, E-L (85-91), 1.6, 160 GL, GLE, GLi, Exec., GLS, Exec., GLX, Sport Sprinter 4A-F, A-FE, A-GE (88-91)
<b>9645</b>	Front Wheel Oil Seal	Toyota Conquest/Tazz EE80 1.3 GL, GS, L, S 2EL (85-93), AE82R 1.6 GL, RS, RSi 4A-L, A-GEL (85-88), Corolla FWD 1.6 GL, GLE, GLi, GLS, GLX, Avante, GLE, GLi, S/W 4A-L, A-GEL, AE/ EE80R 1.3 GL, L, 2A-L, E-L (84-88), Rav4 I SXA10/11 2.0 3/5 Dr. SWB SUV 3S-FE Pet. - 4X4 (94-01)

## BUYERS GUIDE - OIL SEALS

<b>9646</b>	Drive Shaft Oil Seal	<p>Citroen C1 1.0 1KR, 1.0i Furio, Play 1KR (06-15), Opel Astra F 140i, iS 14NV, 160i, iE, iS, Estate 16NZ (93-99), Corsa B 130, i, Lite, iE, iS, Chill Hatch / Sedan 13NE, 140i, Classic, Active, Lite, Lite+, Comfort, Chill, Sport, S 14NE, Hatch/ Sedan, 160, i, iE, Classic, GSi, i Sport, S Hatch/ Sedan, 16SE, 1.8i GSi Hatch (96-03), Corsa C 140i Classic, Comfort, Chill, Classic Essentia, Hatch Club, Sport, Lite Sport, S14NE, 160i Classic, Classic Elegance, Classic CD, CDE, Sport, 16SE, 1.7TDi Sport, Classic, CDTi Enjoy, Hatch CDTi Elegance, Classic DTi Elegance X17D, 1.8i GSi Hatch, Classic (03-08), Corsa LDV 130i Utility P/up 13NE, 1.4i Utility, S P/up 14NE, 1.6i Utility Sport P/up 16NZ, 1.7D Utility P/up X17D (97-04), Corsa LDV II 1.4i Utility, Club Sport, S P/up 14XE, 1.7TDi Utility Club, Sport P/up, 1.8i Utility Club, Sport P/up (03-10), Corsa P/van 1.3i Pronto 13NE, 1.4i Combo P/van (1999-), Kadett F 140, S 14NE, 160i, iS, GSi, Aspen 16SV/ NZ (93-99), Peugeot 107 1.0 XR, XR+, X-Line (06-16), Toyota Auris 1.3, 1.4i RS, RT, 1.6i RS, RT (2007-), Aygo 1.0 Fresh, Inferno, Wild 3/5-door, X-Cite, X-Play 1KR (2011-), Camry I SXV10/11 R 200i Si 3S-FE, 220 SEi, Si, 5S-FE (92-01), Conquest/Tazz EE80 1.3 GL, GS, L, S 2EL, EE90R 130 Sport, Tazz, Edition, Zipp, Tropique, Tazz EE90R 130 Edition, Ruby, Tropique, Sport, McTazz, XE 2E (85-06), AE82R 1.6 GL, RS, RSi 4A-L, A-GEL, AE92R 160i LS, RS, RSi, Sport, RSE, Tazz 4A-F, A-FE, A-GE, AE92R 160i Edition, Sport, Tazz, XE 4AFE (85-06), Conquest AE93 180i RS, RSi, Sport 7A-FE (93-96), EE90 130 Carri P/van, 2E (98-06), Corolla FWD AE82R 1.6 GL, GLE, GLi, GLS, GLX, Avante, GLE, GLi, S/W 4A-L, A-GEL (84-88), AE/EE80R 1.3 GL, L, 2A-L, E-L, EE90R 1.3 GL, GLE, L, Sprinter 2E-L, E EE110R 130 GLE, Sprinter 2E (84-02), AE92R 1.6, 160 GL, GLE, GLi, Exec., GLS, Exec., GLX, Sport Sprinter 4A-F, A-FE, A-GE (88-96), AE93R 180i GL, GLE, GSE, GSX, Sprinter 7A-FE (93-96), AE111R 160i GL, GLE, RSi, RXi 4A-FE, A-GE, AE112 180i GLE, GSE 7A-FE (96-02), F11 140i GLE, GLS, Sprinter 4ZZ-FE, KS1 160i GLE, GLS, GSX, Sprinter VVT-i 3ZZ-FE DOHC, GF2 180i GLE, GLS, GSX, Sprinter VVT-I 1ZZ-FE DOHC (02-08), 1.3i Impact, Professional, Advanced, 1.4i, 1.6i Professional, Advanced, 1.8i (2007-), Corolla Verso ZZE122 160i S, SX MPV, 180i SX, SX MMT, TX, TX MMT MPV 1ZZ-FE (04-09), Etios 1.5 2NRF (2013-), Runx 140i RT, RS, Sport 4ZZ-FE, 160i RS, RT, RX, Sport 3ZZ-FE, 180i RSi, RX 1ZZ-FE (03-08), Yaris 1.0 T1, 1.3 T3, +, Spirit, T3 Spirit - Saloon &amp; Hatch 2NZ-FE (05-10)</p>
<b>9648</b>	Rear Main Bearing Oil Seal	<p>C.A.M. Inyathi Jinbei Haise Minibus 2.2i Std. (2007-), Daihatsu Feroza 1.6 F300HDE (98-99), GWM Steed 3 2.2i S/Cab, D/Cab (10-13), Nissan Hardbody QW/D22 2.0 NA20S, 2.0i KA20, 2.4i Z24, KA24E/DE - 4X2 (98-11), 2.4i KA24E, 3.0TD ZD30 - 4X4 (04-11), NP300 D22 2.0i, S, SE KA20 (2008-), Micra (K12/13) 1.5 dCi Tekna, Acenta JR15DE (2004-), NP200 1.6, S, SE P/up (2008-), NV200 1.6 HR16DE (2013-), Peugeot 605 3.0 V6 SRI ZP/LZ (96-98), Renault Clio I, II 1.4 Alaise, Privilege, Expression, RT, Va Va Voom K4J7/EJ634, 1.5 DCi Expression., K9K700/-702, 3.0 V6 Sport F7R (99-06), Clio III 1.4 Expression, Extreme, 1.6 Expression, Dynamique, Extreme K4M 748 (06-10), Duster 1.5 DCi K9K, 1.6 K4M - 4X2, 4X4 (2013-), Espace 2.0 Authentique Expression, RXE, RXT MPV J7R, F4R, 3.0 L7X727, 3.0 Previl (96-08), Fluence 1.6 (11-16), Kangoo 1.4 Express van E7J780 (01-10), 1.4 Multix Authentique MPV E7J780, 1.5DCi (03-10), 1.6 (11-13), Laguna I 1.6 RT, RTE K4M720, 3.0 Privilege, RXT L7X731 L7X700 (96-07), Logan 1.6 Expression (2009-), Megane I 1.6 Classic RXE, RT, RXT, RSi Coupe, RN Hatch, RT Coupe, Hatch, RXE, RXI Cabriolet K7M700/ 02/03 (96-02), Megane II 1.4 Authentique, Dynamique E7J626/-50, 1.6 Classic Privilege, Expression, Dynamique, Authentique, Shake it! CC Dynamique K4M701, K4M760/ -1 (02-10), Megane III 1.6, DCi (2010-), Modus 1.4 Dynamique, Expressio K4J770, 1.6 Expression K4M761-11 (05-08), Sandero 1.4 Authentique, 1.6 Cup, Dynamique, Expression, Pack (09-15), Scenic I 1.4 RTE, 1.6 RT, RXE (98-02), Scenic II 1.4 Authentique K4J750, 1.6 Authentique, Expression, Joie de Vivre K4M761/782 (01-04), Scenic III 1.6 (11-13), Twingo 1.6 RS K4M854 (08-13), Toyota Condor 1.6 Estate, TE, 5L, 1.8 2Y, 2.0i Estate, TE, 1RZ Pet. - 4X2 (00-05), Cressida TX30 1.8 DX 3T, TX62 1.8 L, LS 3T, YX70 1.8 LS, Exec. (80-89), GX60 2.0 GLi6 1G-E, GX7 2.0 GLi6 1G-E, 1G-FE (83-92), RX73 2.4 GLE, GLE S/W 22R With I.R.S. (Independent Rear Suspension) (87-92), Hiace YH50/60 1.8 SWB / LWB P/van, LS Wagon 2Y Pet. (83-91), YH51/61 2.0 SWB/LWB 16 Seater Commuter, Super 10 Seater Custom Wagon, P/van 3Y Pet. (83-86), YH53/63 2.2 SWB/ LWB P/van, Van, LS, GLX, Exec. Wagon 4Y Pet. (All Imp. Models) (86-88), YH53/63 2.2 SWB/LWB P/van, Van, LS, Super T/14/16, GLX, Exec. Wagon, Siyaya Bus, P/van 4Y Pet. (All Local Models) (88-09), Hilux LN30/40/50/51/55 2.2 SWB/LWB P/up L Dies., 2.4 SWB/LWB D/cab, Raider P/up 2L Dies., YN58 2.2 LWB D/cab, Raider, SRX P/up 4Y Pet. (79-98), YN67 2.2 LWB D/cab, Raider D/ cab P/up 4Y Pet. - 4X4 (86-94), YN51/56 1.8 SWB/LWB D/cab, S, SR, Raider P/up 2Y Pet., YN140 1.8 SWB/LWB D/cab, Raider, S, SRX P/up 2Y Pet. (86-05), RN67 2.4 LWB D/cab, Raider D/cab P/ up 22R Pet. - 4X4 (94-98), RN58 2.4 22R Pet. (94-05), Stallion YF50 1.8 SR5, P/up, P/van, Van 2Y Pet. (87-04), Venture YF50 1.8 8/10 Seater P/van 2Y Pet., 2.2 10 Seater, GLE, Getaway 9 Seater S/W 4Y Pet. (91-04)</p>



## BUYERS GUIDE - OIL SEALS

<b>9649</b>	Rear Main Bearing Oil Seal	Citroen C4 1.6 Hdi DV6TED4 (05-10), Opel Vivaro 1.9CDTi P/van, 2.0i P/van (06-15), Peugeot 1007 1.6 MPV TU5JP4 (05-08), 206 1.4 X-Line, XS-Line, XS-Line HDi, Popart, Popart+ TU3JP, 1.6 XS-Line, CC, SW XS, XT, XT Premium TU5JP4 (01-08), 306 1.6 XT S/W TU5JP (95-03), 307 1.6 Estate, X-Line, XR, XT TU5JP4, HDi, X-Line HDi, XS HD EW10J4 (01-08), Toyota Camry I SXV10/11 R, 200i Si 3S-FE, 220 SEi, Si, 5S-FE (92-01), Condor 2.4i Estate, TE, TX 2RZ-E, 3.0D Estate, TE, 5L Dies. - 4X2, 2.4i Estate, TX Estate 2RZ-E, 3.0 Estate, TX Estate 5L - 4X4 (00-05), Fortuner 3.0 D-4D SUV 1KD-FTV - 4X2, 4X4 (06-11), Hilux LN30/40/50/51/55 2.2 SWB/LWB P/up L Dies., 2.4 SWB/LWB D/cab, Raider P/up 2L Dies. (79-98), LN65 2.4 LWB D/cab, Raider D/cab P/up 2L Dies. - 4X4 (89-98), LN140/145 2.4i DLX, P/up 2L Dies. (98-05), LN57 2.8D LWB D/cab, Raider P/up 3L Dies. - 4X2, LN67 2.8D LWB, D/cab, Raider D/cab P/up 3L Dies. - 4X4 (95-98), LN192R 3.0D LWB Raider D-E, Raider DLX D/cab D-E, Legend35 Raider, P/up 5L Dies., 3.0iD LWB Raider, Raider D/cab, P/up KZ-TE Dies. (98-05), LN167 3.0D D/cab D-E, DLX, S/D/cab DE, Raider DE, Legend35 LWB P/up 5L Dies., 3.0iD LWB Raider S/cab & KZ-TE D/cab P/up, Legend35 - 4X4 (98-05), Land Cruiser FZJ105 4.5 Std., GX, Turbo P/up, S/W 1FZ-FE Dies., Turbo Dies. (95-98), FZJ105 4.5 V8 VX, Turbo P/up, S/W 2UZ-FE Pet., HZJ105 4.2 Std., GX DSL, Turbo P/up, S/W 1HZ Dies., Turbo Dies., UZJ100 4.5 V8 Std., GX, VX S/W, P/up 2UZ-FE Pet. - 4X4 (98-06), Rav4 I SXA10/11 2.0 3/5 Dr. SWB SUV 3S-FE Pet. - 4X4 (94-01), Rav4 II ZCA20 1.8 SUV 1ZZFE, ACA20 2.0 SUV 1AZ-FE (02-06), Stallion LF50 2.4D P/up 2L5F Dies. (87-04), Venture LF50 2.4D 10 Seater S/W 2L5F Dies. (91-04), VW Sharan 2.8 MPV AAA (99-08)
<b>9652</b>	Drive Shaft Oil Seal	Renault R5 1.3, GTL, LS, LSS, TS 810-25, 1.4 TS 847-C2J, 1.3 Panel Van 810-25 (75-85)
<b>9653</b>	Rear Wheel Oil Seal Inner	Renault R5 1.3, 1.4 (77-85), R5 1.3 (80-85)
<b>9654</b>	Drive Shaft Oil Seal	Ford Bantam 130 Explorer P/up B3, 160, i Explorer, Leisure, Sport, P/up B6/ F6 (94-03), Laser 1.3 L, GL, 13, Dash E3 / B3, 1.6, i GL, 16, Sport, TX3 B6/ F6, 2.0, i RS FE (86-95), 1.4 L CHV-FUA, 1.5 GL, GLS, Sport E5/B5 (86-92), Meteor 1.3 GL, L, 13 E3/B3, 1.4 LX CVH, 1.5 GL, GLS E5, 1.6, i GL, GLE, GLi, 16, Sport B6/CVH/F6, 2.0 8/16V GLE, GLi FE (86-95), Tracer 1.3 Sedan, H/back - Tonic, Plus B3, 1.6 Sedan, H/back - Plus, Sport, Tonic B6/F6 (95-02), Ranger 1.8 XL, P/up, 2.2 XL, P/up (00-10), Telstar 2.0 GL, GLE, GLi, Mystique FS/KF, 2.5 V6 Ghia, GLi KL, TX5 2.5 V6 RSi KL (94-99), Hyundai Grand i10 1.1 G3LA, 1.2 G4LA (14-19), Grand i10 III 1.0 Mpi G3LA, G3LD Pet. (2019-), i10 1.1 G4HG 1.2 G4LA (08-14), Kia Carens 1.8 LS 5 Dr. MPV TBD In-Line (00-03), Clarus 2.0 GLX 4 Dr. Sedan FE (98-01), Picanto III (JA) 1.0 G3LA, G3LD Pet., 1.2 G4LA Pet. (2017-), Pride 1.3i LX 5 Dr. H/back, Rio I 1.3 5 Dr. H/back A3E, 1.5 5 Dr. H/back A5D (98-04), Sephia 1.5i LS, RS 4 Dr. Sedan BFD (04-05), Shuma I 1.5i LS 4 Dr. Sedan BFD, 1.8i GS 5 Dr. H/back TBD (98-01), Spectra 1.6 Exec. A6 (01-03), Sportage JA 2.0 SUV 5 Spd. FE Pet. - 4X4 (98-03), Mazda 2 (DE) 1.3 Active, Dynamic, 1.5 Dynamic, Individual (07-15), (DL) 1.5, 1.5D (2015-), 3 (BM) 1.6 Z6Y1 (2014-), 323 FWD 1.3 S, H/back, Sedan E3, 1.5 GLC, SL, SLX, Sport H/back, Sedan E5 (81-88), 1.3 L, H/back, Sedan E/B3, 1.5, L H/back, Sedan E5, 1.6 EGi Hatch, L, Sedan, SL Hatch, SL Sedan, Sport Hatch B6i/F6 (84-91), 2.0 EGi Hatch, SLE Hatch, SLi Sedan, 200e Hatch, Sedan, 200i Hatch 8/16V FE-2000 (89-95), 130 Hatch, Midge, Sedan, Sting B3, 160, i, S Hatch, Midge, Sedan, Sting F6 (90-95), 130 Hatch, Midge, Sedan, Sting B3, 160, i, S Hatch, Midge, Sedan, Sting F6, 200i, e Hatch 8/16V FE 2000 (95-05), 626 1.6 S Sedan, Hatch F6, 1.8 L Sedan, Hatch F8, 2.0 SL, SLE, SLX, 2.0i EGi, SLi FE (Rear Drum brakes), 2.0i 16V SLi FE (Rear Disc brakes) (83-93), 2.0i 16V Medium High, V6 24V High KF/KS, 2.5i V6 Exec. KL, MX-6 2.5 V6 KL (93-98), 26 2.0 S/W, Sedan FE (98-03), Astina 180 Se Hatch Bpi (95-00)
<b>9654... Continued</b>	Drive Shaft Oil Seal	Etude 160, e, i, iE, iSE Sport, 180, e, SE, 160 iE, iSE, Sport, 180 iSE, iSX, Sport (95-04), Rustler 130 SWB Drifter, Explorer P/up B3 Pet., 160, i SWB Explorer, Drifter P/up F6/B6i Pet. (94-02)
<b>9656</b>	Pinion Oil Seal	Nissan Langley 1.3, 1.5 (83-88), Pulsar 1.3, 1.4, 1.5 (80-87)
<b>9658</b>	Rear Wheel Oil Seal Outer	Toyota Dyna 3.0, 3.8, 4.0 (85-02)
<b>9660</b>	Front Wheel Oil Seal	Toyota Dyna 2.0, 2.2, 2.4, 3.0, 3.7, 4.0 (85-02)
<b>9661</b>	Front Wheel Oil Seal Inner	Toyota Dyna 3.0, 3.8, 4.0 (85-02)
<b>9663</b>	Rear Wheel Oil Seal	Mazda 626 1.6 S Sedan, Hatch F6, 1.8 L Sedan, Hatch F8, 2.0 SL, SLE, SLX, 2.0i EGi, SLi FE (Rear Drum brakes) (83-93)
<b>9666</b>	Timing Cover, Cam, Pinion Oil Seal	Ford Bantam 160, i Explorer, Leisure, Sport, P/up B6/ F6 (94-03), Courier 1.6 P/up F6, 1.8 Chassis cab, Explorer, Std., XLT P/up F8., 2.0 XLT FE., 2.2 D/cab, Explorer, Leisure, Std., XLT P (86-00), Laser 1.6, i GL, 16, Sport, TX3 B6/ F6, 2.0, i RS FE, Tracer 1.6 Sedan, H/back - Plus, Sport, Tonic B6/F6 (92-02), Meteor 1.6, i GL, GLE, GLi, 16, Sport B6/CVH/F6, 2.0 8/16V GLE, GLi FE (86-95), Ranger 1.8 XL, P/up, 2.2 XL, P/up (00-10), Spectron 2.2 Bus, P/van F2 (91-04), Telstar 2.0 GL, GLE, GLi, Mystique FS/KF, 2.5 V6 Ghia, GLi KL, TX5 2.5 V6 RSi KL (94-99), Hyundai i10 PA 1.2 G4LA (08-15), Grand i10 1.1 G3LA, 1.2 G4LA (2014-), Grand i10 III 1.0 Mpi G3LA, G3LD Pet. (2019-), Kia Carens 1.8 LS 5 Dr. MPV TBD In-Line (00-03), Carnival 2.5 K55, KRV6, 2.9 CRDi J3 (00-04), Clarus 2.0 GLX 4 Dr. Sedan FE (98-01), Picanto 1.2 G4LA (11-17), Picanto III (JA) 1.0 G3LA, G3LD Pet., 1.2 G4LA Pet. (2017-), Rio II 1.4 High, A5D, 1.6 Sport G4ED (2004-), Rio III 1.2 CVVT G4LA (2011-), Rio IV 1.2 G4LA, 1.4 G4LC (2018-), Sportage JA 2.0 SUV 5 Spd. FE Pet. - 4X4 (98-03),

# BUYERS GUIDE - OIL SEALS

<p><b>9666... Continued</b></p>	<p>Timing Cover, Cam, Pinion Oil Seal</p>	<p>Land Rover Freelander 1.8i S/W Pet., 2.0 Di S/W, Td4 SUV Pet., 2.5 V6 SUV KV6 Pet. (98-04), Mazda 323 FWD 1.3 L, H/back, Sedan E/B3, 1.5, L H/back, Sedan E5, 1.6 EGi Hatch, L, Sedan, SL Hatch, SL Sedan, Sport Hatch B6i/F6 (89-91), 2.0 EGi Hatch, SLE Hatch, SLi Sedan, 200e Hatch, Sedan, 200i Hatch 8/16V FE-2000 (89-95), 130 Hatch, Midge, Sedan, Sting B3, 160, i, S Hatch, Midge, Sedan, Sting F6 (90-95), 130 Hatch, Midge, Sedan, Sting B3, 160, i, S Hatch, Midge, Sedan, Sting F6, 200i, e Hatch 8/16V FE 2000 (95-05), 626 1.8 L Sedan, Hatch F8, 2.0 SL, SLE, SLX, 2.0i EGi, SLi FE (Rear Drum brakes) (83-93), 2.0i 16V SLi FE (Rear Disc brakes) (89-93), 2.0 S/W, Sedan FE (98-03), Astina 180 Se Hatch BPI (95-00), B-Series B1600 1.6 SWB Magnum P/up F6 Pet., B1800 1.8 SWB/LWB Magnum, Drifter P/up F8 Pet., B2000 2.0 LWB Drifter, Magnum P/up FE Pet., B2200 2.2 LWB D/cab, Drifter, Magnum P/up R2 Dies., 2.2 LWB D/cab, Drifter, Magnum P/up F2 Pet. (86-00), Drifter 1.8 SWB/LWB XL P/up Pet., 2.2 SWB/LWB XL P/up Pet. (00-09), Etude 160, e, i, iE, iSE Sport, 180, e, SE (95-00), Etude 160 iE, iSE, Sport, 180 iSE, iSX, Sport (99-04), Marathon 2.2 LWB Bus, P/van F2 Pet. (91-04), Rustler 160, i SWB Explorer, Drifter P/up F6/B6i Pet. (94-02), Mitsubishi Canter 2.5 SWB/LWB D/side, Chassis cab 4G55 Dies., 2.6 4G54 Pet. (80-97), Nissan 1-Tonner/Hardbody 3.0 VG30E (90-99), Hardbody QW/D22 2.7D TD27i, 3.0 i VG30E, 3.0TD ZD30, 3.2 QD32, 3.3i VG33E (98-10), Maxima GV 300SE VG30E (91-97), Patrol Y60 3.0 VG30E - 4X4 (95-00), Sani AW/D21 2.4, i Z24, 2.5 TD25, 2.7D, TD TD27, 3.0 VG30E - 4X2, 3.0 VG30E - 4X4 (86-99), Skyline R30 1.8 L18, 2.0 GL L20 (82-87), R31 2.0 GL, GLE CA20 (87-92), Toyota Camry I SXV10/11 R 200i Si 3S-FE, 220 SEI, Si, 5S-FE (92-01), Rav4 I SXA10/11 2.0 3/5 Dr. SWB SUV 3S-FE Pet. - 4X4 (94-01), Rav4 II ZCA20 1.8 SUV 1ZZFE, ACA20 2.0 SUV 1AZ-FE - 4X2, 4X4 (02-06)</p>
<p><b>9667</b></p>	<p>Rear Main Bearing Oil Seal</p>	<p>Ford Bantam 160, i Explorer, Leisure, Sport, P/up B6/ F6 (94-03), Courier 1.6 P/up F6, 1.8 Chassis cab, Explorer, Std., XLT P/up F8., 2.0 XLT FE., 2.2 D/cab, Explorer, Leisure, Std., XLT P (86-00), Laser 1.6, i GL, 16, Sport, TX3 B6/ F6, 2.0, i RS FE, Tracer 1.6 Sedan, H/back - Plus, Sport, Tonic B6/F6 (86-02), Meteor 1.6, i GL, GLE, GLi, 16, Sport B6/CVH/F6, 2.0 8/16V GLE, GLi FE (86-95), Ranger 1.8 XL, P/up, 2.2 XL, P/up (00-10), Spectron 2.2 Bus, P/ van F2 (91-04), Telstar 2.0 GL, GLE, GLi, Mystique FS/KF (94-99), Hyundai Sante Fe' 2.4 SUV G4JS, 2.7 V6 SUV G6BA-G - 4X4 (01-05), Sonata Y3 2.5 V6 G6BV, 3.0 V6 G6AT (94-04), Kia Clarus 2.0 GLX 4 Dr. Sedan FE (98-01), K2700i 2.7D Workhorse LW Dies."Bakkie" D/S (2004-), Land Rover Freelander 1.8i S/W Pet., 2.0 Di S/W, Td4 SUV Pet. (98-04), Mazda 323 FWD 2.0 EGi Hatch, SLi Sedan, 200e Hatch, Sedan, 200i Hatch 8/16V FE-2000 (89-95), 160, i, S Hatch, Midge, Sedan, Sting F6 (90-95), 200i, e Hatch 8/16V FE 2000 (95-05), 626 2.0 SL, SLE, SLX, 2.0i EGi, SLi FE (Rear Drum brakes) (83-93), 2.0i 16V SLi FE (Rear Disc brakes) (89-93), 2.0i 16V Medium High, V6 24V High KF/KS (93-98), 2.0 S/W, Sedan FE (98-03), Mazda B-Series B1600 1.6 SWB Magnum P/up F6 Pet., B1800 1.8 SWB/LWB Magnum, Drifter P/up F8 Pet., B2000 2.0 LWB Drifter, Magnum P/up FE Pet., B2200 2.2 LWB D/cab, Drifter, Magnum P/up R2 Dies., 2.2 LWB D/cab, Drifter, Magnum P/up F2 Pet. (86-00), Drifter 1.8 SWB/LWB XL P/up Pet., 2.2 SWB/LWB XL P/up Pet. (00-09), Marathon 2.2 LWB Bus, P/van F2 Pet. (91-04), Rustler 160, i SWB Explorer, Drifter P/up F6/B6i Pet. (94-02), Mitsubishi Pajero 2.8 TDi, 3.0 V6 SWB GLS Wagon 6G72 Pet., 3.5 V6 SWB GLS Wagon 6G74 Pet. - 4X4 (90-01), Peugeot 405 1.6 GR XU52C/K (95-97), Toyota Rav4 III 2.0i 1AZ-FE GX, VX, Fierce SUV, 2.2i D-4D 2AD-FTV GX, VX SUV - 4X4 (06-13)</p>
<p><b>9669</b></p>	<p>Front Wheel Oil Seal / Rear Main Bearing Oil Seal / Cam Oil Seal</p>	<p>Ford Courier 1.6 P/up F6, 1.8 Chassis cab, Explorer, Std., XLT P/up F8., 2.0 XLT FE., 2.2 D/cab, Explorer, Leisure, Std., XLT P (86-00), 3.0 V6 D/cab, Explorer, L, Leisure, Std., P/up Essex (86-97), 2.5 Turbo Diesel D/cab, Leisure P/up WL4, 3.4 V6 Leisure D/cab, P/up Essex - 4X2 (96-01), Ranger 1.8 XL, P/up, 2.2 XL, P/up (00-05), 2.5 Diesel, Turbo Diesel D/cab, High Trail, XL, DT XLT High Trail D/Cab, Super Cab - 4X2 (00-04), Ranger T6 2.2 D HP, MP - 4X2, 4X4 (2012-), Spectron 2.2 Bus, P/van F2 (91-04), Kia Carnival 2.5 K55, KRV6, 2.9 CRDi J3 (00-04), Mazda 626 1.6 S Sedan, Hatch F6, 1.8 L Sedan, Hatch F8, 2.0 SL, SLE, SLX, 2.0i EGi, SLi FE (Rear Drum brakes) (83-93), B-Series B2600 2.6 LWB D/cab, Magnum, Drifter P/up 4G54 Pet., B2600i 2.6i LWB D/cab Drifter, SLX P/up 4G54 Pet. (86-01), B3000 3.0 V6 LWB D/cab, Magnum Drifter P/up Essex Pet. - 4X2 (86-97), B1600 1.6 SWB Magnum P/up F6 Pet., B1800 1.8 SWB/LWB Magnum, Drifter P/up F8 Pet., B2000 2.0 LWB Drifter, Magnum P/up FE Pet., B2200 2.2 LWB D/cab, Drifter, Magnum P/ up R2 Dies., 2.2 LWB D/cab, Drifter, Magnum P/up F2 Pet. (86-00), B3400 3.4 V6 LWB Magnum D/cab P/up Essex Pet., B2500 2.5 LWB Diesel, Turbo Diesel D/cab, Drifter, SLX P/up WL4 Dies., Turbo - 4X2 (96-00), Drifter 1.8 SWB/LWB XL P/up Pet., 2.2 SWB/LWB XL P/up Pet., 2.5Td LWB Hi Ride, SL SLE,SLX D/cab, Hi Ride, Hi Trail D/cab P/up WL4 Dies./Turbo Dies. - 4X2 (00-04), 2.6i LWB Hi Ride, SL Hi Ride S/cab, SLE, SLX D/cab SLX Hi Ride D/cab, SLX Hi Trail D/cab P/up Pet. - 4X2 (00-09), Marathon 2.2 LWB Bus, P/van F2 Pet. (91-04), Toyota Cressida MX75 3.0i ECT, GLS 7MG-E (86-92)</p>
<p><b>9670</b></p>	<p>Use - 9654, 354814, 9838</p>	
<p><b>9671</b></p>	<p>Drive Shaft Oil Seal</p>	<p>Chevrolet Spark 0.8 L, LS, 1.0 LT, LS (03-10), 1.0 B110S1, 1.2 B12D1 (2010-)</p>
<p><b>9672</b></p>	<p>Drive Shaft Oil Seal</p>	<p>Chevrolet Spark 0.8 L, LS, 1.0 LT, LS (03-10), 1.0 B110S1, 1.2 B12D1 (2010-)</p>
<p><b>9673</b></p>	<p>Drive Shaft Oil Seal</p>	<p>Toyotat Land Cruiser FJ80 4.0 DLX, GX, VX P/up 3F/F-E Pet. (90-92), FZJ80 4.5 Std., GX, VX, Turbo S/W, P/up 1FZ-FE Dies., Turbo Dies. (92-06), HDJ/HZJ80 4.2 GX, Turbo S/W, P/up1HD-FT, 1HZ Dies., T. Dies. - 4X4 (95-01)</p>
<p><b>9675</b></p>	<p>Drive Shaft Oil Seal</p>	<p>Ford Sapphire 1.6 L Kent, 2.0, i GL, GLE, GLEA, GLi, GLi Exec. Koln, 3.0 Ghia, GLX Essex (89-93), Sierra 1.6 GL, GL S/W, L Kent, 2.0 GL, GL S/W Koln, 2.0 LX Koln, 2.3 GLE, Cologne, 3.0, i GLS, GLX, LX, RS, XR6 Essex (83-93)</p>
<p><b>9678</b></p>	<p>Drive Shaft Oil Seal</p>	<p>Ford "Boet" Bantam Rocam 1.3i, XL, XLT, 1.4i TDCi, 1.6i, XL, XLT, XLE, 1.8D XL (02-12), Escort FWD MkIII 1.3 GL, L Kent, 1.6 GLE, L, Sport, XR3, i HL16CVH (81-86)</p>

## BUYERS GUIDE - OIL SEALS

<b>9680</b>	Pinion, Gearbox Oil Seal	Ford Sapphire 1.6 L Kent, 2.0, i GL, GLE, GLEA, GLi, GLi Exec. Koln, 3.0 Ghia, GLX Essex (89-93), Sierra 1.6 GL, GL S/W, L Kent, 2.0 GL, GL S/W Koln, 2.0 LX Koln, 2.3 GLE, Cologne, 3.0, i GLS, GLX, LX, RS, XR6 Essex (83-93), Nissan 1-Tonner/Hardbody AW/D21 1.6 L16S-J, 1.8 L18S-R, 2.0 NA20, 2.4 Z24/S, 2.5D TD25i, 2.7D TD27, 3.0 VG30E - 4X2 (88-98), 2.4 Z24S, 2.7 TD27, 3.0 VG30E - 4X4 (88-99), 720 D20 1.8 L18S, 2.0 NA20, 2.2 Z22 - 4X4 (80-88), Hardbody QW/D22 2.0 NA20S, 2.0i KA20, 2.4i Z24, KA24E/DE, 2.7D TD27i, 3.0 i VG30E, 3.0TD ZD30, 3.2 QD32, 3.3i VG33E - 4X2 (98-11), Patrol Y60 3.0 VG30E - 4X4 (95-00), Sani AW/D21 2.4, i Z24, 2.5 TD25, 2.7D, TD TD27, 3.0 VG30E - 4X2, 2.2 Z22, 2.4 Z24, 2.7 TD27, 3.0 VG30E - 4X4 (86-99), Skyline R31 2.0 GL, GLE CA20 (87-92)
<b>9682</b>	Timing Cover, Cam Oil Seal	Ford Bantam 130 Explorer P/up B3, 160, i Explorer, Leisure, Sport, P/up B6/ F6 (94-03), Laser 1.3 L, GL, 13, Dash E3 / B3, Tracer 1.3 Sedan, H/back -Tonic, Plus B3 (86-02), 1.5 GL, GLS, Sport E5/B5 (86-92), Laser 1.6, i GL, 16, Sport, TX3 B6/ F6, 2.0, i RS FE, Tracer 1.6 Sedan, H/back - Plus, Sport, Tonic B6/F6 (92-02), Meteor 1.3 GL, L, 13 E3/B3, 1.4 LX CVH, 1.5 GL, GLS E5, 1.6, i GL, GLE, GLi, 16, Sport B6/CVH/F6, 2.0 8/16V GLE, GLi FE (86-95), Kia Pride 1.3i LX 5 Dr. H/ back, Rio I 1.3 5 Dr. H/back A3E (98-04), Shuma I 1.8i GS 5 Dr. H/back TBD (98-01), Mazda 323 FWD 1.3 L, H/back, Sedan E/B3, 1.5, L H/back, Sedan E5, 1.6 EGi Hatch, L, Sedan, SL Hatch, SL Sedan, Sport Hatch B6i/F6 (85-91), 130 Hatch, Midge, Sedan, Sting B3 (90-95), 130 Hatch, Midge, Sedan, Sting B3, 160, i, S Hatch, Midge, Sedan, Sting F6 (95-05), 626 2.5i V6 Exec. KL, MX-6 2.5 V6 KL (93-98), Astina 180 Se Hatch BPi (98-03), B-Series B2000 2.0 LWB Drifter, Magnum P/up FE Pet., B2200 2.2 LWB D/cab, Drifter, Magnum P/up R2 Dies., 2.2 LWB D/cab, Drifter, Magnum P/up F2 Pet. (86-00), MX-5 1.6 (90-93), 1.8 16V (01-09), 2.0 (05-14), Rustler 130 SWB Drifter, Explorer P/up B3 Pet. (94-02)
<b>9683</b>	Drive Shaft Oil Seal	BMW 3 Series E30 316 1.8 M10, 316i 1.6 M40, 318i 1.8 M40, 320i M20/50, 323i M50, 325i M52, 333i M30 (84-92), E36 316i 1.8 Dolphin Shape M40, 318i 1.9 M44, 320i 2.0 M50, 323i 2.5 M52, 325i M50, 328i 2.8, 3.0 M52, Z3 2.8, 3.0 Roadster (92-00), M3 Coupe 6 Cyl. (01-04), E46 316i 1.8 M40, 318i M43, 320i, d M54/47, 323i M52, 325i, it M50, 328i M52TU, 330d 3.0 M57, 330i, Ci, 3.0 M54 (98-05)
<b>9684</b>	Pinion Oil Seal	BMW 116i, 118i, 120d, 120i, 130i, 135i (2004-), 318i, 320i, 323i (83-89)
<b>9685</b>	Pinion Oil Seal	BMW 316, i, 318i, 320i, 323i, 325i, 333i (83-93), 325Ci, i, 330Ci, 330i, 333i (2005-), X3 2.0d, 3.0d, 3.0i, 3.0si (2004-), X5 4.4i, 4.6iS (2001-)
<b>9686</b>	Drive Shaft Oil Seal	BMW 318i, 320i, 323i, 325i, 333i (83-92)
<b>9687</b>	Drive Shaft / Gearbox Oil Seal	BMW E30 Series 333i (83-92), 316i, 320i, 323i, 325i, 333i (83-84)
<b>9688</b>	Drive Shaft Oil Seal	BMW E30 Series 318i (83-84)
<b>9692</b>	Drive Shaft Oil Seal	Nissan 1-Tonner/Hardbody AW/D21 1.6 L16S-J, 1.8 L18S-R, 2.0 NA20, 2.4 Z24/S, 2.5D TD25i, 2.7D TD27, 3.0 VG30E (88-98), Hardbody QW/D22 2.0 NA20S, 2.0i KA20, 2.4i Z24, KA24E/DE, 2.7D TD27i, 3.0 i VG30E, 3.0TD ZD30, 3.2 QD32, 3.3i VG33E - 4X2 (98-11), NP300 D22 2.0i, S, SE KA20, 2.5TDi, S, SE YD25, 2.4i, S/C, D/C Highrider KA24 DE, 2.5TDi, S, SE Highrider YD25 - 4X2 (2008-), Sani AW/D21 2.4, i Z24, 2.5 TD25, 2.7D, TD TD27, 3.0 VG30E - 4X2 (89-99), Skyline R30 2.8 GLX, GTX L28/2 (83-86), R31 2.0 SGi, SGLi RB20E, 3.0 SGLi RB30E With I.R.S. (87-92)
<b>9693</b>	Pinion Oil Seal	Nissan Skyline 2.8, 2.0, 3.0 (82-92), Safari 2.8 - 4X4 (80-90)
<b>9694</b>	Front Wheel Oil Seal	Nissan Skyline R31 2.0 GL, GLE CA20, 2.0 SGi, SGLi RB20E, 3.0 SGLi RB30E With I.R.S. (87-92),
<b>9695</b>	Timing Cover Oil Seal	Mercedes-Benz A160, A170, A190 (00-08)
<b>9696</b>	Front Wheel Oil Seal Inner	Nissan 720 D20 A, B 1.8, 2.0, 2.2 (1988-)
<b>9697</b>	Front Wheel Oil Seal Outer	Nissan 720 D20 A, B 1.8, 2.0, 2.2 (1988-)
<b>9699</b>	Drive Shaft Oil Seal	Citroen C1 1.0 1KR, 1.0i Furio, Play 1KR (06-15), Peugeot 107 1.0 XR, XR+, X-Line (06-16), Toyota Auris 1.3, 1.4i RS, RT, 1.6i RS, RT (2007-), Conquest/Tazz EE80 1.3 GL, GS, L, S 2EL, EE90R 130 Sport, Tazz, Edition, Zipp, Tropicque, Tazz EE90R 130 Edition, Ruby, Tropicque, Sport, McTazz, XE 2E (85-06), AE82R 1.6 GL, RS, RSi 4A-L, A-GEL, AE92R 160i LS, RS, RSi, Sport, RSE, Tazz 4A-F, A-FE, A-GE, AE92R 160i Edition, Sport, Tazz, XE 4AFE (85-06), Conquest AE93 180i RS, RSi, Sport 7A-FE (93-96), EE90 130 Carri P/van, 2E (98-06), Corolla FWD AE82R 1.6 GL, GLE, GLi, GLS, GLX, Avante, GLE, GLi, S/W 4A-L, A-GEL (84-88), AE/EE80R 1.3 GL, L, 2A-L, E-L, EE90R 1.3 GL, GLE, L, Sprinter 2E-L, E EE110R 130 GLE, Sprinter 2E (84-02), AE92R 1.6, 160 GL, GLE, GLi, Exec., GLS, Exec., GLX, Sport Sprinter 4A-F, A-FE, A-GE (88-96), AE93R 180i GL, GLE, GSE, GSX, Sprinter 7A-FE (93-96), AE111R 160i GL, GLE, RSi, RXi 4A-FE, A-GE, AE112 180i GLE, GSE 7A-FE (96-02), F11 140i GLE, GLS, Sprinter 4ZZ-FE, KS1 160i GLE, GLS, GSX, Sprinter VVT-i 3ZZ-FE DOHC, GF2 180i GLE, GLS, GSX, Sprinter VVT-I 1ZZ-FE DOHC (02-08), 1.3i Impact, Professional, Advanced, 1.4i, 1.6i Professional, Advanced, 1.8i (2007-), Etios 1.5 (2013-), Runx 140i RT, RS, Sport 4ZZ-FE, 160i RS, RT, RX, Sport 3ZZ-FE, 180i RSi, RX 1ZZ-FE (03-08), Yaris 1.0 T1, 1.3 T3, +, Spirit, T3 Spirit - Saloon & Hatch 2NZ-FE (05-10)
<b>9703</b>	Rear Main Bearing Oil Seal	Toyota Conquest/Tazz EE80 1.3 GL, GS, L, S 2EL, EE90R 130 Sport, Tazz, Edition, Zipp, Tropicque, Tazz EE90R 130 Edition, Ruby, Tropicque, Sport, McTazz, XE 2E (85-06), EE90 130 Carri P/van, 2E (98-06), Corolla FWD EE90R 1.3 GL, GLE, L, Sprinter 2E-L, E EE110R, 130 GLE, Sprinter 2E (88-02), Cressida RX72 2.4 GL, GL S/W, GLE, GLE S/W 22R (87-92)
<b>9704</b>	Timing Cover, Cam Oil Seal	Toyota Cressida MX73 2.8i 5M-E (84-89)



## BUYERS GUIDE - OIL SEALS

<b>9705</b>	Timing Cover Oil Seal	Toyota Stallion KF50 1.5 SR5,Commuter, Bus, P/up, P/van 5K Pet. (87-04), Tuv KF20 1.5 P/up 5K Pet. (82-87)
<b>9706</b>	Drive Shaft Oil Seal	Toyota Cressida GX60 2.0 GLi6 1G-E, GX7 2.0 GLi6 1G-E, 1G-FE (83-92), MX63 2.8i 5M-E, MX73 2.8i RSi, RSi Exec. 5M-GE (84-89), RX73 2.4 GLE, GLE S/W 22R With I.R.S. (Independent Rear Suspension) (87-92)
<b>9707</b>	Pinion Oil Seal	Toyota Cressida 2.0 Auto. (83-92)
<b>9709</b>	Use - 9648	
<b>9711</b>	Use - 9641	
<b>9715</b>	Timing Cover, Cam Oil Seal	Alfa Romeo 155 2.5 V6 AR67301 (96-99), BMW 3 Series E36 M3 Coupe 6 Cyl. (01-04), E46 316i 1.8 M40, 318i M43, 320i, d M54/47, 323i M52, 325i, it M50, 328i M52TU, 330d 3.0 M57, 330i, Ci, 3.0 M54 (98-05), Daewoo Nubira I 1.6 SX, 2.0 CDX, Nubira II 1.6 SX, SX S/W, 2.0 CDX, Exec., S/W (97-03), Isuzu KB200i 2.0 LX, KB240i 2.4 LX, KB250i 2.5 LX - 4X2, 4X4 (04-09), Opel Ascona 1.6 GL 16SH, 1.8 GLS 18L (82-87), Astra F 140i, iS 14NV, 160i, iE, iS, Estate 16NZ, 180i, iE 18SE/ XE, XL, 200i, e, ts 20SE/ XE (93-99), Astra G 1.8 Classic CDE, Caravan CD S/W, Elegance, Irmischer X18XE1, 2.0 Coupe', CSX X20XEV, 2.2i Classic Exec (99-06), Astra H 2.0 Coupe' Turbo, GSi, GTC Turbo, GTC Turbo OPC, GTC Turbo Sport, Turbo Sport, Twin top (04-10), Corsa B 1.8i GSi Hatch (96-03), Corsa C 1.8i GSi Hatch, Classic (03-08), Corsa LDV II 1.8i Utility Club, Sport P/up (03-10), Kadett D, E 1.6 GL, GLS, GSE, L, Rebel, Cub 16SH/ SE, 160i, GSi Aspen 16SE (80-93), 1.8 GTE 18E, L 18LV, GSi Hatch 18L, GLX 18SV, GSi 18E/ SE (84-93), Kadett E 2.0 GSi 20XE, SGi 20SEH, 200, iS 20SE, Boss 20SEH, CD 20SHE, GSi, Super Boss 20SEH (87-93), Kadett F 140, S 14NE, 160i, iS, GSi, Aspen 16SV/ NZ, 180i, iE, GSi 18SE (93-99), Meriva 1.8 Elegance MPV Easytronic (03-09), Monza 1.8 CLX, GLE, GLX, Convertible, GLi 18SE/ SV, 2.0 CD, CLi 2.0XE, CLE, GLE 20SE/ V (86-93), Zafira I 1.8i CD, Enjoy, Elegance MPV Z18XE/-1 (01-05)
<b>9716</b>	Front Gearbox Oil Seal	Chevrolet Utility 1.3D, 1.4 Pet., 1.8 Pet. (11-15), Opel Kadett 1.3, 1.4, 1.6 (85-93), Monza 1.6 (86-93)
<b>9716</b>	Gearbox Oil Seal Front	Opel Monza 160 GSi, i Aspen 16SE/ NZ, CLS 16SV (86-93)
<b>9717</b>	Gearbox Oil Seal Front	Daewoo Cielo 1.5 GL, GLX, GTX, 150i L, Espero 1.8 CD, C18LE, 2.0 CD, C20LE (96-99), Lanos I 1.35i S, 1.6 SX, Lanos II 1.4 S, 1.6 SX (97-03), Nubira I 1.6 SX, 2.0 CDX, Nubira II 1.6 SX, SX S/W, 2.0 CDX, Exec., S/W (97-03), Tacuma 1.6 SX, 2.0 CDX, CDX Plus (01-03), Opel Astra G 2.0 Coupe', CSX X20XEV, 2.2i Classic Exec. (99-05), Kadett D, E 1.6 GL, GLS, GSE, L, Rebel, Cub 16SH/ SE, 160i, GSi Aspen 16SE (80-93), Kadett E 2.0 GSi 20XE, SGi 20SEH, 200, iS 20SE, Boss 20SEH, CD 20SHE, GSi, Super Boss 20SEH (87-93), Kadett F 160i, iS, GSi, Aspen 16SV/ NZ (93-99), Monza 1.8 CLX, GLE, GLX, Convertible, GLi 18SE/ SV, 2.0 CD, CLi 2.0XE, CLE, GLE 20SE/ V (86-93)
<b>9718</b>	Pinion Oil Seal	C.A.M. Inyathi, Jinbei Haise Minibus 2.2i Std. (2007-), Ford Courier 2.5 Turbo Diesel D/cab, Leisure P/up WL4 - 4X2, 4X4 (96-00), 3.4 V6 Leisure D/cab, P/up Essex - 4X2, 3.4 V6 Leisure, P/up Essex. - 4X4 (97-01), Ranger 1.8 XL, P/up, 2.2 XL, P/up (00-10), 2.5 Diesel, Turbo Diesel D/ Cab, High Trail, XL, DT XLT High Trail D/Cab, Super Cab - 4X2, 2.5 D/Cab,High Trail, XL, DT XLT High Super Cab, 2.5TD Montana D/Cab WL4, 3.0TDCi, 4.0 Super Cab XLT - 4X4 (00-12), Isuzu KB320 3.2 LE, D/cab, LX, Frontier, Reef, Blazer P/up 6VD1 (92-04), KB200i 2.0 LX, KB240i 2.4 LX, KB250i 2.5 LX - 4X2, 4X4 (04-13), KB250Dc 2.5, KB300TDi 3.0 LX (04-09), WFR 1.8 11FVX/ 12FVX Bus, P/van 4ZB1 (83-89), Mazda B-Series B2500 2.5, Td LWB D/Cab, Drifter, SLX P/up WL4 Dies./Turbo Dies. - 4X2, 4X4 (96-00), B2600 2.6 LWB D/cab, Magnum, Drifter P/up 4G54 Pet. (86-01), B2600i 2.6i LWB D/cab Drifter, SLX P/up 4G54 Pet. - 4X2, 4X4 (00-09), B3400 3.4 V6 LWB Magnum D/cab P/up Essex Pet. - 4X2, 4X4 (96-01), Drifter 1.8 SWB/LWB XL P/up Pet., 2.2 SWB/LWB XL P/up Pet. (00-09), 2.5Td LWB Hi Ride, SL SLE,SLX D/cab, Hi Ride, Hi Trail D/ cab P/up WL4 Dies./Turbo Dies., 2.6i LWB Hi Ride, SL Hi Ride S/cab, SLE, SLX D/cab SLX Hi Ride D/cab, SLX Hi Trail D/cab P/up Pet. - 4X2, 4X4 (00-09), Mitsubishi Colt LDV 1.6 SWB/LWB Lo-Line P/up 4G32 Pet., 2.0 4G63 Pet., 2.5D 4D56 Dies., 2.6 WB Hi-Line P/up 4G54 Pet. 4X2, 2.5D LWB Hi-Line P/up 4D56 Dies., 2.6 LWB Lo-/Hi-Line, P/up 4G54 Pet., 3.0 V6 LWB Lo-/Hi-Line D/cab, Rodeo 6G72 Pet. - 4X4 (94-98), Pajero 2.8 Tdi, 3.0 V6 SWB GLS Wagon 6G72 Pet., 3.5 V6 SWB GLS Wagon 6G74 Pet. - 4X4 (90-01), Nissan 1-Tonner/Hadbody AW/D21 1.6 L16S-J, 1.8 L18S-R, 2.0 NA20, 2.4 Z24/S, 2.5D TD25i, 2.7D TD27, 3.0 VG30E (88-98), Hardbody QW/D22 2.7D TD27i, 3.0 i VG30E, 3.0TD ZD30, 3.2 QD32, 3.3i VG33E (98-10), Sani AW/D21 2.4, i Z24, 2.5 TD25, 2.7D, TD TD27, 3.0 VG30E (89-99), Skyline R31 3.0 SGLi RB30E With I.R.S. (87-92), Hiace YH53/63 2.2 SWB/LWB P/van, Van, LS, Super T/14/16, GLX, Exec. Wagon, Siyaya Bus, P/van 4Y Pet. (Some Models) (88-09)
<b>9719</b>	Timing Cover Oil Seal	Mercedes-Benz W123 240, 300 (77-86)
<b>9720</b>	Timing Cover, Cam Oil Seal	Mercedes-Benz W123 250 M123.920/1 (77-86), W124 200E M102.922, 220E M111.960, 230E M102.982, 260E M103.940, 280E M104.942, 300D M103.985, M606.910, 320 Sportline M104.922 (86-96), W124 E Class E200 M102.922, E220 M111.960, E320 Sportline, M104.992 (93-96), W126 280SE M110 987/9, 300SE M103.981, 380SE M116.963, 420SE M116.965, 500SE M117.965 (86-93), Vito/Viano W638 113CDi, 115CDi, 116CDi, 120CDi, 122CDi (03-06)
<b>9721</b>	Timing Cover/ Cam Oil Seal	Mercedes-Benz 280E (77-86), W245 B-Class B170, B180, B200CDi, Turbo (2005-), W211 Series E-Class E200K, E240, E280, E300, E320, E350, E500 (2002-), Sprinter BM906 Series 2.2i Bus, P/ van, W639 Series Vito 115CDi Bus, Van, P/van, W164 Series ML320CDi, ML350, ML500, ML63 AMG (2006-)
<b>9722</b>	Rear Main Bearing Oil Seal	Mercedes-Benz W123 Series 200, 230 (77-86)

## BUYERS GUIDE - OIL SEALS

<b>9723</b>	Rear Main Bearing Oil Seal	Mercedes-Benz W124 200E M102.922, 220E M111.960, 230E M102.982, 260E M103.940, 280E M104.942, 300D M103.985, M606.910, 320 Sportline M104.922 (86-96), W124 E Class E200 M102.922, E220 M111.960, E320 Sportline, M104.992 (93-96), W126 380SE M116.963 (86-93), R170 SLK200K M111.958 (02-04)
<b>9724</b>	Timing Cover Oil Seal	Mercedes-Benz W123 Series 200, 230 (77-86)
<b>9728</b>	Timing Cover, Cam Oil Seal	Nissan 1-Tonner/Hardbody AW/D21 3.0 VG30E - 4X2, 4X4 (88-99), Hardbody QW/D22 3.0 i VG30E, 3.0TD ZD30 - 4X2 (98-10), Laurel C31 2.0 CA/L20 (80-87), Maxima GV 300SE VG30E (91-97), Patrol Y60 3.0 VG30E - 4X4 (95-00), Sani AW/D1 2.5 TD25, 3.0 VG30E - 4X2 (88-99), 3.0 VG30E - 4X4 (86-98), Skyline R31 2.0 GL, GLE CA20 (87-92)
<b>9729</b>	Rear Main Bearing Oil Seal	Nissan 1-Tonner/Hardbody AW/D21 3.0 VG30E - 4X2, 4X4 (90-99), Hardbody QW/D22 3.0 i VG30E, 3.0TD ZD30 - 4X2, 4X4 (98-04), NP300 D22 2.5TDi, S, SE Highrider YD25 - 4X2, 4X4 (2008-), Laurel C31 2.0 CA/L20 (80-87), Maxima GV 300SE VG30E (91-97), Micra (K12) 1.4 Accenta, Accenta+, Accenta Sport, Visia, Comfort, Elegance, SE CR14PE (2004-), Pathfinder D40/R51 2.5DCi D/Cab P/up, 3.0DCi V6, 4.0i V6, LE D/Cab P/up - 4X4 (05-17), Patrol Y60 3.0 VG30E - 4X4 (95-00), Sabre 160 GX, GXi GA16DS (94-02), Sani AW/D21 3.0 VG30E - 4X2, 4X4 (86-99), Sentra 160 GSi, GX, GXi, SE, Si GA16DE/DNE/ DS (92-02), Skyline R31 2.0 GL, GLE CA20, 2.0 SGLi, SGLi RB20E (87-92)
<b>9732</b>	Front Wheel Oil Seal Inner	Nissan Safari 2.8 (80-84)
<b>9734</b>	Rear Wheel Oil Seal	Nissan Safari 2.8 (80-90)
<b>9735</b>	Rear Wheel Oil Seal Outer	Nissan Safari 2.8 (80-90)
<b>9739</b>	Pinion Oil Seal	Mitsubishi Colt LDV 2.8D, 3.0, 3.0i - 4X4 (94-09), Pajero 3.0 (90-98), Nissan Caball 2.0, 3.0 (66-84)
<b>9740</b>	Gearbox Oil Seal	Toyota Stout RK110 2.0 (79-89)
<b>9742</b>	Rear Main Bearing Oil Seal	Ford Bantam 130 Explorer P/up B3 (94-03), Laser 1.3 L, GL, 13, Dash B3, Tracer 1.3 Sedan, H/back -Tonic, Plus B3 (86-02), Laser 1.5 GL, GLS, Sport B5 (86-92), 1.6, i GL, 16, Sport, TX3 B6/F6 (86-95), Meteor 1.3 GL, L, 13 B3 (86-95), 1.6, 2.0 Gli (86-95), Kia Pride 1.3i LX 5 Dr. H/back, Rio I 1.3 5 Dr. H/back A3E, 1.5 5 Dr. H/back A5D (98-04), Sephia 1.5i LS, RS 4 Dr. Sedan BFD (04-05), Shuma I 1.5i LS 4 Dr. Sedan BFD, 1.8i GS 5 Dr. H/back TBD (98-01), Spectra 1.6 Exec. A6 (01-03), Mazda 2 (DE) 1.3 Active, Dynamic, 1.5 Dynamic, Individual (07-15), 3 (BL, BK) 1.6 Original, Active, Dynamic B6ZE, Z6 (04-14), 323 FWD 1.6 EG Hatch, L, Sedan, SL Hatch, SL Sedan, Sport Hatch B6i/F6 (84-91), 2.0 SLE (89-95), 130 Hatch, Midge, Sedan, Sting B3 (90-95), 130 Hatch, Midge, Sedan, Sting B3, 160, i, S Hatch, Midge, Sedan, Sting F6 (95-05), Astina 180 Se Hatch BPI (95-00), CX-3 2.0 PEX3 (2015-), CX-5 2.0 PEY4 (12-15), Etude 160, e, i, iE, iSE Sport (95-00), MX-5 1.6 (90-93), 1.8 16V (01-09), 2.0 (05-14), Rustler 130 SWB Drifter, Explorer P/up B3 Pet. (94-02)
<b>9748</b>	Rear Wheel Oil Seal	Toyota Cressida GX60 2.0 GLi6 1G-E, GX7 2.0 GLi6 1G-E, 1G-FE (83-92), MX63 2.8i 5M-E, MX73 2.8i RSi, RSi Exec. 5M-GE (84-89), MX75 3.0i ECT, GLS 7MG-E (86-92), RX73 2.4 GLE, GLE S/W 22R With I.R.S. (Independent Rear Suspension) (87-92), Rav4 II ZCA20 1.8 SUV 1ZZFE, ACA20 2.0 SUV 1AZ-FE (02-06)
<b>9750</b>	Front Wheel Oil Seal Inner	Toyota Stout RK110 2.0 (79-89)
<b>9751</b>	USE 9821	
<b>9752</b>	Rear Main Bearing Oil Seal	Land Rover 109 2.25 (61-80), 88 2.25 (58-78), Mitsubishi Canter 3.3 (80-97), Toyota Land Cruiser 3.9, 4.2 - 4X4 (69-87)
<b>9754</b>	Timing Cover, Cam Oil Seal	Citroen C4 2.0i VTS Coupe' EW10J4S (05-10), Nissan Langley 1.3 GL E13, 1.5 GL, L, SSS, Trebon, Exa Turbo E15 (83-88), Pulsar 1.3 S E13, 1.5 GL, Panache, SX E15 (80-87), Sentra 1.3 GL, SX E13S, 1.6 GL, GX, GXE GXEi Coupe, SGLi E16E/S (87-92), Peugeot 206 1.4 X-Line, XS-Line, XS-Line HDi, Popart, Popart+ TU3JP, 1.6 XS-Line, CC, SW XS, XT, X, 2.0 CC, GTi, 180 EW10J4, XT HDi DW10TD (01-08), 306 1.6 XT S/W TU5JP, 2.0 Cabrio, XSi XU10J4R/ RS/, XU10J2/K (95-03), 307 2.0 CC, CC 100/ 130/ 180, XS, S/W EW10J4 (01-08), 405 1.8 GR XU7JP/LZ, 2.0 SRi XU7J2/CL (95-97), 406 2.0 Coupe, Estate, SLi, ST, ST Comfort, Estate, STi, Si EW10J4R/ XU10J4R/ XU10J2TE (96-05)
<b>9755</b>	Timing Cover, Cam Oil Seal	Nissan Langley 1.3 GL E13, 1.5 GL, L, SSS, Trebon, Exa Turbo E15 (83-88), Pulsar 1.3 S E13, 1.4 DL, GX A14, 1.5 GL, Panache, SX E15 (80-87), Sentra 1.3 GL, SX E13S, 1.6 GL, GX, GXE GXEi Coupe, SGLi E16E/S (87-92)
<b>9756</b>	Timing Cover, Cam Drive Shaft	Isuzu KB160 1.6 Fleetside P/up, KB200 2.0 LE, Fleetside, D/cab P/up, KB220 2.2 LE, P/up, KB230 2.3 D/cab P/up (89-04), KB260 2.6 LE, D/cab, LX P/up 4ZE1 (92-04), KB220 2.2 LE P/up, KB230 2.3 P/up 4ZD1, KB260 2.6 D/cab, LE, LX (89-04), Relay 2.0 P/van, Bus 4ZC1 (89-95), WFR 1.8 11FVX/ 12FVX Bus, P/van 4ZB1 (83-89), Langley 1.3 GL E13, 1.5 GL, L, SSS, Trebon, Exa Turbo E15 (83-88), Livina 1.6 Acenta, +, Visia, X-Gear (07-15), Micra (K12) 1.4 Accenta, Accenta+, Accenta Sport, Visia, Comfort, Elegance, SE CR14PE (2004-), Sentra 1.3 GL, SX E13S, 1.6 GL, GX, GXE GXEi Coupe, SGLi E16E/S (87-92), 140, i, GX, GXi, Si GA14DNE / DS (92-02)



## BUYERS GUIDE - OIL SEALS

<b>9757</b>	Gearbox Oil Seal Front	Audi 100/4 1.6 LS YV, 100/5 1.9 WH, 400 1.8 JW, 500 2.1/2.2 WB, WC SE PR (77-92), 500 2.2 E PR, 2.3 E, SE, AAR, 2.8 SEL AAH (92-94), Kia Shuma 1.5i LS 4 Dr. Sedan BFD, 1.8i GS 5 Dr. H/back TBD (98-01), Spectra 1.6 Exec. A6 (01-03), Nissan Almera 1.5 HR15DE, 1.6 Comfort, Elegance, Luxury 16DE/GA16DE, 1.8 Elegance, Luxury 18DE (2001-), Datsun Go/Go+ 1.2 HR12DE (2014-), Langley 1.3 GL E13, 1.5 GL, L, SSS, Trebon, Exa Turbo E15 (83-88), Pulsar 1.3 S E13, 1.4 DL, GX A14, 1.5 GL, Panache, SX E15 (80-87), Sabre 160 GX, GXi GA16DS, 200 GXi SR20DE (94-02), Sentra 1.3 GL, SX E13S, 1.6 GL, GX, GXE GXEi Coupe, SGLi E16E/S (87-92), 140, i, GX, GXi, Si GA14DNE / DS, 160 GSi, GX, GXi, SE, Si GA16DE/DNE/ DS, 200 GSi, STi SR20DE (92-02)
<b>9757... Continued</b>	Gearbox Oil Seal Front	VW Passat I & II 1.9 GLS H/back, GLX Sedan, S/W WN, 2.2 CLi, CLX SG/MX (81-87), Passat IV 2.3 V5 AZX (03-05), Passat V 1.9TDi Comfortline AVB, 2.0FSI Comfortline, Tipt., Highline BCR BLY, 2.0 T FSI Sportline Tiptronic AXX/BPY, 2.0TDi Highline, DSG BKP/BMP, 3.2 V6 Auto. DSG (05-10)
<b>9758</b>	Rear Wheel Oil Seal	Nissan Sentra 1.3 GL, SX E13S, 1.6 GL, GX, GXE GXEi Coupe, SGLi E16E/S (87-92), 1.8i Coupe, Sedan Exec. CA18DE (89-92)
<b>9759</b>	Pinion Oil Seal	VW Passat I, II 1.3, 1.5, 1.6, 1.8, 1.9, 2.0 (81-87)
<b>9763</b>	Gearbox Oil Seal Front	Hyundai Terracan 2.9 CRDi SUV, 3.5i V6 SUV (03-08), Mitsubishi Colt LDV 3.0 V6 LWB Lo-/Hi-Line D/cab, Rodeo 6G72 Pet. - 4X4 (95-98), Pajero 2.8 Tdi, 3.0 V6 SWB GLS Wagon 6G72 Pet., 3.5 V6 SWB GLS Wagon 6G74 Pet. - 4X4 (90-01), Peugeot 406 3.0 ST, SV Executive ES9J4S (96-05), 605 3.0 V6 SRi ZPJ/LZ (96-98), Renault Clio I, II 3.0 V6 Sport F7R (01-09), Espace 2.0 Authentique Expression, RXE, RXT MPV J7R, F4R, 3.0 L7X727, 3.0 Previl (96-08), Laguna I 3.0 Privilege, RXT L7X731 L7X700 (96-02)
<b>9764</b>	Rear Wheel Oil Seal	Isuzu KB20 1.6 P/up G161Z Pet., KB21 1.6 P/up G161Z Pet., KB22 1.8 P/up G180Z Pet., KBD20 2.0 P/up C190, KBD21 2.0 P/up C190, KBD22 2.2 LE, P/up C223, KB23 2.0 P/up G200Z, KB24 2.3 LE 4ZD1, KB25 1.6 P/up G161Z, KB26 1.6 P/up G161Z, 1.8 P/up G180Z, KBD23 2.5 LE, P/up 4JA1, KBD25 2.0 P/up C190 (78-89), KBD26 2.0 P/up C190, KBD27 2.2 C223, KBD28 2.5 4JA1 (81-89), KB27 1.8 P/up G180Z, KB28 2.0 P/up G200Z, KB29 2.3 P/up 4ZD1 (83-89), KB40 1.6 G161Z, KB41 1.6 G161Z, 1.8 G180Z, KB42 1.8 G180Z, KB43 2.0 G200Z, KB44 2.3 4ZD+1, KBD40, KBD41 2.0 P/up C190, KBD42 2.2 P/up C223 - 4X4 (79-89), KB250D 2.5 Fleetside, LE, D/ Cab P/up 4JA1, KB280DT 2.8 D/cab LE, LX, Frontier P/up Turbo 4JB1 (89-04), Relay 2.0 P/van, Bus 4ZC1 (Import) (89-95)
<b>9765</b>	Timing Cover, Cam Oil Seal	Toyota Avanza, Conquest, Tazz, Corolla, Cressida, Runx, Yaris, Daihatsu Sirion, Terios
<b>9766</b>	Drive Shaft Oil Seal	Toyota Hilux YN67 2.2 LWB D/cab, Raider D/cab P/up 4Y Pet. - 4X4 (86-94), LN65 2.4 LWB D/cab, Raider D/cab P/up 2L Dies. - 4X4 (89-98)
<b>9768</b>	Rear Wheel Oil Seal	Ford Sapphire 1.6 L Kent, 2.0, i GL, GLE, GLEA, GLi, GLi Exec. Koln, 3.0 Ghia, GLX Essex (89-93), Sierra 2.0 LX Koln, 3.0, i GLS, GLX, LX, RS, XR6 Essex (83-93)
<b>9771</b>	Gearbox Oil Seal Rear	Isuzu KB24 2.3 LE 4ZD1, KBD23 2.5 LE, P/up 4JA1 (79-89), KBD27 2.2 C223, KBD28 2.5 4JA1 (81-89), KB29 2.3 P/up 4ZD1 (83-89), KB40 1.6 G161Z, KB41 1.6 G161Z, 1.8 G180Z, KB42 1.8 G180Z, KB43 2.0 G200Z, KB44 2.3 4ZD1, KBD40, KBD41 2.0 P/up C190, KBD42 2.2 P/up C223 - 4X4 (79-89), KB160 1.6 Fleetside P/up, KB200 2.0 LE, Fleetside, D/cab P/up, KB220 2.2 LE, P/up, KB230 2.3 D/cab P/up (89-04), KB260 2.6 LE, D/cab, LX P/up 4ZE1, KB320 3.2 LE, D/cab, LX, Frontier, Reef, Blazer P/up 6VD1 (92-04), KB220 2.2 LE P/up, KB230 2.3 P/up 4ZD1, KB260 2.6 D/cab, LE, LX, KB320 3.2 V6 Frontier LX - 4X4 (89-04), KB200i 2.0 LX, KB240i 2.4 LX, KB250i 2.5 LX (04-12), KB200i 2.0 LX, KB240i 2.4 LX, KB250i 2.5 LX - 4X4 (04-13), KB250D 2.5 Fleetside, LE, D/Cab P/up 4JA1, KB280DT 2.8 D/cab LE, LX, Frontier P/up Turbo 4JB1 (89-04), WFR 1.8 11FVX/ 12FVX Bus, P/van 4ZB1 (83-89)
<b>9772</b>	Timing Cover Oil Seal	Isuzu KB20 1.6 P/up G161Z Pet., KB21 1.6 P/up G161Z Pet., KB22 1.8 P/up G180Z Pet., KBD20 2.0 P/up C190, KBD21 2.0 P/up C190, KBD22 2.2 LE, P/up C223, KB24 2.3 LE 4ZD1, KBD23 2.5 LE, P/up 4JA1, KBD25 2.0 P/up C190 (78-89), KBD26 2.0 P/up C190, KBD27 2.2 C223, KBD28 2.5 4JA1 (81-89), KB27 1.8 P/up G180Z, KB28 2.0 P/up G200Z (83-89), KB40 1.6 G161Z, KB41 1.6 G161Z, 1.8 G180Z, KB42 1.8 G180Z, KB43 2.0 G200Z, KB44 2.3 4ZD1, KBD40, KBD41 2.0 P/up C190, KBD42 2.2 P/up C223 - 4X4 (79-89), KB250D 2.5 Fleetside, LE, D/Cab P/up 4JA1, KB280DT 2.8 D/cab LE, LX, Frontier P/up Turbo 4JB1 - 4X2, KB250D 2.5 LE, D/cab P/up 4JA1, KB280DT 2.8 LE, LX, D/cab P/up Turbo 4JB1 - 4X4 (89-04)
<b>9773</b>	Gearbox Oil Seal Front	Isuzu KB160 1.6 Fleetside P/up, KB200 2.0 LE, Fleetside, D/cab P/up, KB220 2.2 LE, P/up, KB230 2.3 D/cab P/up (89-04), KB220 2.2 LE P/up, KB230 2.3 P/up 4ZD1, KB260 2.6 D/cab, LE, LX, KB320 3.2 V6 Frontier LX - 4X4 (89-04), KB200i 2.0 LX, KB240i 2.4 LX, KB250i 2.5 LX (04-12), KB200i 2.0 LX, KB240i 2.4 LX, KB250i 2.5 LX - 4X4 (04-13), KB250D 2.5 Fleetside, LE, D+E339/ Cab P/up 4JA1 - 4X2, KB250D 2.5 LE, D/cab P/up 4JA1 - 4X4 (89-04), WFR 1.8 11FVX/ 12FVX Bus, P/van 4ZB1 (83-89)
<b>9775</b>	Front Wheel Oil Seal Inner	Isuzu KB44 (79-89), KBD40/41/42 (87-89)
<b>9776</b>	Rear Main Bearing Oil Seal	Daihatsu Coure 847cc ED10 (97-03), Isuzu KB220 2.2 LE P/up, KB230 2.3 P/up 4ZD1, KB260 2.6 D/cab, LE, LX, KB320 3.2 V6 Frontier LX - 4X4 (89-04), KB200i 2.0 LX, KB240i 2.4 LX, KB250i 2.5 LX (04-12), KB200i 2.0 LX, KB240i 2.4 LX, KB250i 2.5 LX - 4X4 (04-13), KB250D 2.5 LE, D/cab P/up 4JA1, KB280DT 2.8 LE, LX, D/cab P/up Turbo 4JB1 - 4X4 (89-04), KB250Dc 2.5, KB300TDi 3.0 LX - 4X2, 4X4 (04-09), KB300TDi 3.0 D-TEQ - 4X2, 4X4 (07-11)

# BUYERS GUIDE - OIL SEALS

<b>9777</b>	Rear Main Bearing Oil Seal	Isuzu KB20/21 1.6 (78-89)
<b>9779</b>	Pinion Oil Seal	Isuzu KB250D, KB260, KB280DT, KB320 (89-04)
<b>9783</b>	Drive Shaft Oil Seal	Toyota Cressida 3.0, 3.0i (89-92)
<b>9785</b>	Rear Gearbox Oil Seal	Toyota Dyna 2.0, 2.2, 2.4, 3.0, 3.7, 4.0 (85-02)
<b>9787</b>	Pinion Oil Seal	Toyota Dyna 2.0, 2.2, 3.0 (85-95)
<b>9788</b>	Rear Wheel Oil Seal Outer	Toyota 85-02 Dyna 2.0, 2.2, 2.4, 3.0, 3.7, 4.0 (85-02)
<b>9789</b>	Cam Oil Seal	Toyota Camry 3.0 (97-01)
<b>9790</b>	Rear Main Bearing Oil Seal	Toyota Fortuner 3.0 D-4D SUV 1KD-FTV - 4X2, 4X4 (06-11), 2.5D-4D 2KD-FTV, 3.0D-4D 1KD-FTV - 4X2, 4X4 (11-16), 2.4GD Raised Body 2GD-FTV, 2.7 VVTi Raised Body 2TR-FE, 2.8GD Raised Body 1GD-FTV - 4X2, 2.8GD DSi Raised Body 1GD-FTV, 3.0D-4D 1KD-FTV, 4.0 V6 1GR-FE - 4X4 (2015-), ilux "Vigo" 4X2 2.5TDi D-4D S/Cab, S, SRX, S/Cab, S/Cab SRX HO, Raised Body Raider, D/Cab LWB 2KD-FT, 3.0 D-4D TDi Raider, D/C Raider, Raised Body LWB P/up 1KD-FTV Dies., 4.0i D/Cab Raider Raised Body LWB P/up GR-FE Pet. - 4X2, 3.0 D-4D TDi D/C Raider 1KD-FTV Dies., LWB P/up - 4X4 (05-09), 2.5TDi D-4D S/Cab, D/Cab SRX, Legend40 2KD-FTV Dies. LWB P/up, 2.7i S/Cab SRX, Legend40 2TR-FE Pet.LWB P/up - 4X4 (05-15), 3.0D-4D TDi D/C xtra cab, Raider, Legend40 1KD-FTV Dies. LWB, 4.0 D/Cab Raider, 1GR-FE Pet. - 4X4 (2009-), 2.5TDi D-4D S/Cab, S, SRX, S/Cab, S/Cab SRX HO, Raised Body Raider, D/Cab LWB P/up 2KD-FTV, 3.0D-4D TDi D/C Raised Body Raider, Xtra cab, Legend40 LWB P/up KD-FTV Dies. (09-16), Hilux 2.5D-4D Raised Body, Std. Body 2KD-FTV 5 Spd Man., 3.0D-4D 1KD-FTV, 4.0 1GR-FE - 4X2, 2.5D-4D Raised Body 2KD-FTV 5 Spd man., 3.0D-4D 1KD-FTV, 4.0 1GR-FE - 4X4 (11-16), Hilux "Revo" 2.4 GD-6 Raised Body 2GD-FTV, 2.7 VVTi Raised Body 2TR-FE, 2.8 GD-6 Raised Body 1GD-FTV - 4X2, 2.4 GD-6 2GD-FTV, 2.8 GD-6 Raised Body 1GD-FTV - 4X4 (2016-), Land Cruiser FZJ/HZJ754.2 GX S/W, P/up 1HZ Dies. (91-97), FZJ105 4.5 V8 VX, Turbo P/up, S/W 2UZ-FE Pet. (98-06), HDJ/HZJ80 4.2 GX, Turbo S/W, P/up1HD-FT, 1HZ Dies., T. Dies. (90-95), HDJ/HZJ80 4.2 Std., GX, VX, Turbo S/W, P/up 1HD-FT, 1HZ Dies., Turbo Dies. (95-01), HDJ100 4.2 Std., GX, VX S/W, 1HZ Pet., 4.5, 4.7 V8 (97-04), HDJ200 4.5 D-4D, 4.6 V8, 4.7 V8 (2007-), HZJ105 4.2 Std., GX DSL, Turbo P/up, S/W 1HZ Dies., Turbo Dies. (98-06), Prado 90/95 3.0 1KZ-TE GX, GX TDi S/W Dies., VX S/W Pet., 3.4 V6 GX, VX S/W Pet. 5VZ-FE (97-04), Prado 120 3.0D 1KZ-TE VX S/W, 4.0 1GR-FE GX, VX S/W (02-10), Quantum 2.5 D-4D, "Family", S-long MPV, Van 2KD-FTV Dies. (2005-)
<b>9791</b>	Drive Shaft Oil Seal	Nissan Maxima CA33 & QX 2.0 VQ20E, 3.0 VQ30DE (96-04)
<b>9795</b>	Front Wheel Oil Seal	Toyota Conquest/Tazz EE80 1.3 GL, GS, L, S 2EL, EE90R 130 Sport, Tazz, Edition, Zipp, Tropique, Tazz EE90R 130 Edition, Ruby, Tropique, Sport, McTazz, XE 2E (88-06), AE82R 1.6 GL, RS, RSi 4A-L, A-GEL, AE92R 160i LS, RS, RSi, Sport, RSE, Tazz 4A-F, A-FE, A-GE, AE92R 160i Edition, Sport, Tazz, XE 4AFE (88-06), AE93 180i RS, RSi, Sport 7A-FE (93-96), EE90 130 Carri P/van, 2E (98-06), Corolla FWD EE90R 1.3 GL, GLE, L, Sprinter 2E-L, E EE110R 130 GLE, Sprinter 2E (88-02), AE92R 1.6, 160 GL, GLE, GLi, Exec., GLS, Exec., GLX, Sport Sprinter 4A-F, A-FE, A-GE (88-96), AE93R 180i GL, GLE, GSE, GSX, Sprinter 7A-FE (93-96), AE111R 160i GL, GLE, RSi, RXi 4A-FE, A-GE, AE112 180i GLE, GSE 7A-FE (96-02)
<b>9797</b>	Use - 9649	
<b>9799</b>	Drive Shaft Oil Seal	Toyota Camry I SXV10/11 R 200i Si 3S-FE, 220 SEi, Si, 5S-FE (92-01), Corolla Quest FWD 1.6 Auto, Plus (2014-)
<b>9800</b>	Pinion Oil Seal	Toyota Condor 2.4i Estate, TX Estate 2RZ-E, 3.0 Estate, TX Estate 5L (00-05), Hilux LN65 2.4 LWB D/cab, Raider D/cab P/up 2L Dies. (89-98), RN67 2.4 LWB D/cab, Raider D/cab P/up 22R Pet. (94-98), LN67 2.8D LWB, D/cab, Raider D/cab P/up 3L Dies. (95-98), RZN169 2.7i LWB D/cab, DLX S/cab, Raider S/D/cab, SRX D/cab, Legend 35 LWB P/up 3RZFE Pet. - 4X4 (98-05), Land Cruiser FJ80 4.0 DLX, GX, VX P/up 3F/F-E Pet. (90-92), FZJ/HZJ75 4.2 GX S/W, P/up 1FZF/HZ Dies. (91-97), FZJ80 4.5 Std., GX, VX, Turbo S/W, P/up 1FZ-FE Dies., Turbo Dies. (92-95), HDJ/HZJ80 4.2 GX, Turbo S/W, P/up1HD-FT, 1HZ Dies., T. Dies. (90-95), PHJ75 3.9 DLX, GX, GX Turbo P/up Perkins236 2H Dies., FJ75 4.0 DLX, GX, VX 3F/F-E Pet., HJ75 - 4X4 (85-92)
<b>9804</b>	Cam, Pinion Oil Seal	Toyota Auris 1.4i RS, RT, 1.6i RS, RT, 1.8i RS, RX (2007-), Avensis 2.4i Exclusive (06-09), Camry I SXV10/11 R 200i Si 3S-FE, 220 SEi, Si, 5S-FE (92-01), MCV10/ VCV10 300SEi 1MZ-FE / 3VZ-FE, Quad Cam (92-97), Camry II 2.4i Xii, 3.0 GLX 1MZ-FE (01-06), Corolla FWD F11 140i GLE, GLS, Sprinter 4ZZ-FE, KS1 160i GLE, GLS, GSX, Sprinter VVT-i 3ZZ-FE DOHC, GF2 180i GLE, GLS, GSX, Sprinter VVT-i 1ZZ-FE DOHC (02-08), 1.4i (2007-), Corolla Verso ZZE122 160i S, SX MPV, 180i SX, SX MMT, TX, TX MMT MPV 1ZZ-FE (04-09), Land Cruiser FZJ80 4.5 Std., GX, VX, Turbo S/W, P/up 1FZ-FE Dies., Turbo Dies. (95-06), FZJ105 4.5 Std., GX, Turbo P/up, S/W 1FZ-FE Dies., Turbo Dies. (95-98), FZJ105 4.5 V8 VX, Turbo P/up, S/W 2UZ-FE Pet. (98-06), HDJ/HZJ80 4.2 Std., GX, VX, Turbo S/W, P/up 1HD-FT, 1HZ Dies., Turbo Dies. (95-01), HDJ100 4.2 Std., GX, VX S/W, 1HZ Pet., 4.5, 4.7 V8 (97-04), HZJ105 4.2 Std., GX DSL, Turbo P/up, S/W 1HZ Dies., Turbo Dies. (98-06), UZJ100 4.5 V8 Std., GX, VX S/W, P/up 2UZ-FE Pet. (98-06), Prado 90/95 3.0 1KZ-TE GX, GX TDi S/W Dies., VX S/W Pet., 3.4 V6 GX, VX S/W Pet. 5VZ-FE - 4X4 (97-04), Rav4 I SXA10/11 2.0 3/5 Dr. SWB SUV 3S-FE Pet. - 4X4 (94-01), Rav4 II ZCA20 1.8 SUV 1ZZFE, ACA20 2.0 SUV 1AZ-FE - 4X2, 4X4 (02-06), Rav4 III 2.0i 1AZ-FE GX, VX, Fierce SUV, 2.2i D-4D 2AD-FTV GX, VX SUV - 4X4 (06-13), Runx 180i RSi, RX 1ZZ-FE (03-08), Yaris 1.8 TS Hatch (05-10)
<b>9805</b>	Drive Shaft Oil Seal	Toyota Avensis 2.0i Advanced, 2.2 D4D Exclusive (06-09), Camry I MCV10/ VCV10 300SEi 1MZ-FE/ 3VZ-FE, Quad Cam (94-01)

## BUYERS GUIDE - OIL SEALS

<b>9807</b>	Rear Main Bearing Oil Seal	Toyota Camry I MCV10/ VCV10 300SEi 1MZ-FE/ 3VZ-FE, Quad Cam (94-01), Camry II 3.0 GLX 1MZ-FE (01-06)
<b>9810</b>	Front Gearbox Oil Seal	Toyota Camry 2.2, 2.4i, 3.0 (92-06)
<b>9811</b>	Pinion Oil Seal	Toyota Dyna 2.2, 2.4, 3.0, 3.7, 3.8, 4.0 (85-02)
<b>9812</b>	Front Gearbox Oil Seal	Nissan Sentra 1.6 (87-02)
<b>9813</b>	Rear Wheel Oil Seal	Nissan 1-Tonner/Hardbody AW/D21 2.4 Z24S - 4X4 (88-98), Sani AW/D21 2.2 Z22, 2.4 Z24 - 4X4 (86-98)
<b>9814</b>	Rear Main Bearing Oil Seal	Nissan 1-Tonner/Hardbody AW/D21 2.5D TD25i, 2.7D TD27 - 4X2 (88-98), 2.7 TD27 - 4X4 (90-99), Sani AW/D21 2.5 TD25 - 4X2 (89-99), 2.7 TD27 - 4X4 (86-98)
<b>9816</b>	Drive Shaft Oil Seal	Nissan Sentra 1.8i (89-92)
<b>9817</b>	Front Gearbox Oil Seal	Nissan Skyline 2.8, 2.0, 3.0 (82-92)
<b>9818</b>	Timing Cover, Cam Oil Seal	Nissan 1-Tonner/Hardbody AW/D21 2.5D TD25i, 2.7D TD27 - 4X2 (88-98), 2.7 TD27 - 4X4 (90-99), Hardbody Qw/D22 2.7D TD27i, 3.0 i VG30E, 3.0TD ZD30, 3.2 QD32, 3.3i VG33E - 4X2, 2.7 TD27, 3.0 VG30E, 3.0TD ZD30, 3.2, 3.2D QD32, 3.3i VG33 - 4X4 (98-10), Patrol Y61 4.2 TD42 (99-04), Sani AW/D21 2.7D, TD TD27 - 4X2 (89-99), 2.7 TD27 - 4X4 (86-98), Terrano II 2.7 TD27 - 4X4 (00-02)
<b>9821</b>	Front Wheel Oil Seal	Nissan 1-Tonner/Hardbody AW/D21 2.4 Z24S - 4x4 (88-98), 2.7 TD27, 3.0 VG30E - 4X4 (90-99), Hardbody QW/D22 2.4i KA24E, 2.7 TD27, 3.0 VG30E, 3.0TD ZD30, 3.2D QD32, 3.3i VG33 - 4X4 (98-10), NP300 D22 2.4i, S/C, D/C Highrider KA24 DE, 2.5TDi, S, SE Highrider YD25 - 4X2, NP300 D22 2.4i, S/C, D/C, Highrider KA24 DE, 2.5TDi, S, SE, Highrider YD25 - 4X4 (2008-), Patrol Y60 3.0 VG30E - 4X4 (95-00), Y61 3.0Di, 4.2 TD42 - 4X4 (99-04), Sani AW/D21 2.2 Z22, 2.4 Z24, 2.7 TD27, 3.0 VG30E - 4X4 (86-98), Terrano II 2.7 TD27 - 4X4 (00-02)
<b>9822</b>	Pinion Oil Seal	Nissan Hardbody 2.4 (91-98), Sani 2.4 (91-94)
<b>9823</b>	Gearbox Oil Seal Front	Nissan 1-Tonner/Hardbody AW/D21 2.4 Z24S - 4x4 (88-98), 2.7 TD27, 3.0 VG30E - 4X4 (90-99), NP300 D22 2.5TDi, S, SE YD25 - 4X2, 2.4i, S/C, D/C, Highrider KA24 DE, 2.5TDi, S, SE, Highrider YD25 - 4X4 (2008-), Patrol Y60 3.0 VG30E - 4X4 (95-00), Sani AW/D21 2.2 Z22, 2.4 Z24, 2.7 TD27, 3.0 VG30E - 4X4 (86-98)
<b>9824</b>	Timing Cover, Cam Oil Seal	Nissan Sentra 1.3 GL, SX E13S, 1.6 GL, GX, GXE GXEi Coupe, SGLi E16E/S (87-92)
<b>9825</b>	Rear Main Bearing Oil Seal	Nissan Almera 1.6 Comfort, Elegance, Luxury 16DE/GA16DE, 1.8 Elegance, Luxury 18DE (01-06), Hardbody QW/D22 3.0 i VG30E, 3.0TD ZD30 - 4X2, 4X4 (04-10), Navara 2.5DCi, LE, SE, XE D/Cab P/up, 4.0i V6, LE D/Cab P/up - 4X2, Navara & Pathfinder D40/R51 2.5DCi D/Cab P/up, 3.0DCi V6, 4.0i V6, LE D/Cab P/up - 4X4 (05-17), NV350 2.5 QR25DE, 2.5D YD25DDTi (2013-), Patrol Y61 3.0Di - 4X4 (99-04), Primera 160 Si, SE SR16DE, 200 GSi, Si, STi, Elegance, Luxury SR20DE (98-02), Sabre 200 GXi SR20DE (94-02), Sentra 1.8i Coupe, Sedan Exec. CA18DE (89-92), 140, i, GX, GXi, Si GA14DNE / DS, 200 GSi, STi SR20DE (92-02), X-Trail T30 2.0 QR20DE MPV, 2.0 MPV 20DE, 2.2D SE, SEL MPV, 2.5 25DE MPV - 4X2, 4X4 (01-09), T31 2.0 D, DCi - 4X4 (08-14), T32 2.5 SE CVT QR25 - 4X4 (2014-), Renault Koleos 2.5 Dynamique SUV, 2.5 Dynamique, Premium CVT SUV - 4X4 (2009-), Megane III 1.6, DCi (2010-)
<b>9829</b>	Drive Shaft Oil Seal	VW Golf II 2.0 8/16V GTi AAL (84-92), Golf III 2.8 VR6, Exec. AAA (92-99), Jetta II 2.0 8/16V CLi, Exec. AAL (85-92), Jetta III 2.8 VR6 Exec. AAA (92-99)
<b>9830</b>	Gearbox Oil Seal Front	VW Fox 1.3 L, L Trippa GY, 1.6 L HM, 1.8 L Sport HV (87-96), Golf II 1.8 8/16V CSX, GTS, GTi KR, EV, 2.0 8/16V GTi AAL (84-92), Golf III 1.6 GS ACG, 1.8 GSX, GTS ACH (92-99), Jetta II 1.6 CSL HM, 1.8 8/16V CLi, CLi Exec., CLX, CSi, CSX EV/KR, 2.0 8/16V CLi, Exec. AAL (85-92), Jetta III 1.6 CSL ACG, 1.8 CLX/ CSX ACH, 2.0 CLi, Exec. 2E, 2.8 VR6 Exec. AAA (92-99)
<b>9832</b>	Pinion Oil Seal	Ford Courier 2.5, 3.0 - 4X4 (90-00), Ranger 2.5D,TD (2000-), Kia Sportage 2.0 (99-02), Mazda B2500, B2600, B2600i, B3000 (96-00), 02-07 Drifter 2.5Td, 2.6i (02-07)
<b>9833</b>	Rear Wheel Oil Seal Outer	Mazda 626 2.0 (89-92)
<b>9834</b>	Rear Wheel Oil Seal	Ford Courier 3.0 V6 Std., XLT, D/cab, Leisure, Explorer, Exec. P/up Essex - 4X4 (97-00), Spectron 2.2 Bus, P/van F2 (91-04), Mazda B-Series B2600 2.6 V6 LWB D/cab, Magnum, Drifter P/up 4G54 Pet., B3000 3.0 V6 LWB D/cab, Magnum, Drifter, Magnum Drifter P/up Essex Pet. - 4X4 (86-97), Marathon 2.2 LWB Bus, P/van F2 Pet. (91-04)
<b>9835</b>	Rear Wheel Oil Seal	Ford Courier 3.0 V6 Std., XLT, D/cab, Leisure, Explorer, Exec. P/up Essex - 4X4 (97-00), Spectron 2.2 Bus, P/van F2 (91-04), Mazda B-Series B2600 2.6 V6 LWB D/cab, Magnum, Drifter P/up 4G54 Pet., B3000 3.0 V6 LWB D/cab, Magnum, Drifter, Magnum Drifter P/up Essex Pet. - 4X4 (86-97), Marathon 2.2 LWB Bus, P/van F2 Pet. (91-04)
<b>9836</b>	Front Gearbox Oil Seal / Timing Cover Oil Seal	Ford Sapphire 1.6, 2.0, 3.0 Auto. (89-93), Sierra 1.6, 2.0, 2.3, 3.0 Auto. (83-93), Kia Cerato 2.0 (04-08)



## BUYERS GUIDE - OIL SEALS

<b>9838</b>	Gearbox Oil Seal Rear	Ford Courier 2.5 Turbo Diesel D/cab, Leisure P/up WL4, 3.0 V6 Std., XLT, D/cab, Leisure, Explorer, Exec. P/up Essex, 3.4 V6 Leisure, P/up Essex. - 4X2, 4X4 (96-00), Ranger 2.5 Diesel, Turbo Diesel D/Cab, High Trail, XL, DT XLT High Trail D/Cab, Super Cab - 4X2, 2.5 D/Cab, High Trail, XL, DT XLT High Super Cab, 2.5TD Montana D/Cab WL4, 3.0TDCi, 4.0 Super Cab XLT - 4X4 (00-12), Spectron 2.2 Bus, P/van F2 (91-04), Mazda B-Series B2500 2.5 LWB Diesel, Turbo Diesel D/cab, Drifter, SLX P/up WL4 Dies., Turbo - 4X2 (97-00), B2600 2.6 LWB D/cab, Magnum, Drifter P/up 4G54 Pet. - 4X2, B2600 2.6 V6 LWB D/cab, Magnum, Drifter P/up 4G54 Pet. - 4X4 (86-95), B2600i 2.6i LWB D/cab Drifter, SLX P/up 4G54 Pet. - 4X2 (86-01), B2600i 2.6i V6 LWB Drifter, D/cab Drifter SLX P/up 4G54 Pet. - 4X4 (00-09), B3400 3.4 V6 LWB Magnum D/cab P/up Essex - 4X4 (96-01), BT-50 2500 TDi - 4X2, 4X4 (07-12), Drifter 2.5Td LWB Hi Ride, SL SLE, SLX D/cab, Hi Ride, Hi Trail D/cab P/up WL4 Dies./Turbo Dies. - 4X2, 4X4 (00-09), 2.6i LWB Hi Ride, SL Hi Ride S/cab, SLE, SLX D/cab SLX Hi Ride D/cab, SLX Hi Trail D/cab P/up Pet. - 4X2, 2.6i V6 LWB SL S/cab, SLE, SLX D/cab P/up 4G54 Pet. - 4X4 (00-09), Marathon 2.2 LWB Bus, P/van F2 Pet. (91-04)
<b>9839</b>	Pinion Oil Seal	Ford Courier 3.0 V6 Std., XLT, D/cab, Leisure, Explorer, Exec. P/up Essex - 4X4 (97-00), Escort FWD MkVI 1.4i H/back, Sedan CVH-PTE, 1.6i GL, GLE H/back, Sedan Zetec, 1.8i GLi, TDi H/back, Sedan Zetec, 1.8TDi Endura (95-00), Fiesta I 1.3, i Flair, Flite, Play, Fun Endura-EM5, 1.4, i Flair, Trend, Fun Zetec CVH/PTE, 1.6, i Ambiente', Flair, Forte' Ghia, Rsi, Sport, Trend (97-04), Ikon 1.3, Low, LX CLTA, 1.6i, Low, High, LX, CLX CLTA (01-06), Spectron 2.2 Bus, P/van F2 (91-04), Mazda 121 Soho 1.3, i 3/5 Dr. H/back Endura-EM5, 1.4i 3/5 Dr. H/back Zetec CVH/PTE (97-99), Mazda B-Series B2600 2.6 V6 LWB D/cab, Magnum, Drifter P/up 4G54 Pet., B3000 3.0 V6 LWB D/cab, Magnum, Drifter, Magnum Drifter P/up Essex Pet. - 4X4 (86-97), Marathon 2.2 LWB Bus, P/van F2 Pet. (91-04)
<b>9845</b>	Pinion Oil Seal	VW Jetta II 1.8, 2.0 (85-92)
<b>9846</b>	Timing Cover / Cam Oil Seal	Ford Cortina MkIV 2.0 (77-80)
<b>9847</b>	Gearbox Oil Seal Rear	Ford Courier 3.0 V6 D/cab, Explorer, L, Leisure, Std., P/up Essex (86-97), Sapphire 1.6 L Kent, 2.0, i GL, GLE, GLEA, GLi, GLi Exec. Koln, 3.0 Ghia, GLX Essex (89-93), Sierra 1.6 GL, GL S/W, L Kent, 2.0 GL, GL S/W Koln, 2.0 LX Koln, 3.0, i GLS, GLX, LX, RS, XR6 Essex (83-93), Mazda B-Series B3000 3.0 V6 LWB D/cab, Magnum Drifter P/up Essex Pet. 4X2, 4X4 (86-97)
<b>9848</b>	Drive Shaft Oil Seal	Honda Ballade SR4 150 Encore, Luxline, Spreeline D15B3, 160E, i D16A7, 180E, i B18B3 (92-98), SO4 150i Encore, Luxline, Spreeline D15Z4, 160i Luxline, Spreeline, V-Tec D16Y9, D16Z, 180i Luxline B18B4 (96-00), Civic SO3 150i Luxline, Spreeline D15Z4, 160i Luxline, V-Tec D16Z (96-00), Civic VII 150i, 170i V-Tec (03-06)
<b>9849</b>	Gearbox Oil Seal Front	Honda Ballade SH4 150 16V SOHC D15B3, 160i 16V SOHC, DOHC D16A9 (89-92), SR4 150 Encore, Luxline, Spreeline D15B3, 160E, i D16A7 (92-98)
<b>9850</b>	Cam oil seal	Honda Ballade SC9 "Flip Up Lights" 130 EV2, 150, i EW (84-89), SH4 150 16V SOHC D15B3, 160i 16V SOHC (89-92), SR4 150 Encore, Luxline, Spreeline D15B3, 160E, i D16A7, 180E, i B18B3 (92-98), SO4 150i Encore, Luxline, Spreeline D15Z4, 160i Luxline, Spreeline, V-Tec D16Y9, D16Z, 180i Luxline B18B4 (96-00), Civic SO3 150i Luxline, Spreeline D15Z4, 160i Luxline, V-Tec D16Z (96-00), Civic VII 150i, 170i V-Tec (03-06), Prelude 1.8 EX ES/ET (84-87)
<b>9851</b>	Front Wheel Oil Seal Inner	Honda Ballade 130, 150, 160 (84-92)
<b>9852</b>	Drive Shaft Oil Seal	Honda Ballade 150, 160 (89-92)
<b>9853</b>	Timing Cover Oil Seal	Honda Ballade SC9 "Flip Up Lights" 130 EV2, 150, i EW, 160i DOHC ZC1 (84-89), SH4 150 16V SOHC D15B3, 160i 16V SOHC, DOHC D16A9 (89-92), SR4 150 Encore, Luxline, Spreeline D15B3, 160E, i D16A7, 180E, i B18B3 (92-98), SO4 150i Encore, Luxline, Spreeline D15Z4, 160i Luxline, Spreeline, V-Tec D16Y9, D16Z, 180i Luxline B18B4 (96-00), Civic VII SO3 150i Luxline, Spreeline D15Z4, 160i Luxline, V-Tec D16Z (96-00)
<b>9854</b>	Gearbox Oil Seal Front	Honda Ballade SA4 1300 EN4 (82-85), SC9 "Flip Up Lights" 130 EV2, 150, i EW, 160i DOHC ZC1 (84-89), SH4 150 16V SOHC D15B3, 160i 16V SOHC, DOHC D16A9 (89-92), SR4 150 Encore, Luxline, Spreeline D15B3, 160E, i D16A7, 180E, i B18B3 (92-98), CR-V 2.0 5 Dr. SUV B20Z1 (97-02), CR-V CTDi 2005-)
<b>9855</b>	Rear Wheel Oil Seal Inner	Honda Ballade 130, 150 (84-89)
<b>9856</b>	Gearbox Oil Seal Front	VW Citi Golf 1.3 L ET/GY, 1.6 Blues, Chico, Chico Lux, Deco, Designa, L, Ritz, Shuttle, Sonic, Sport HM, HV, FR, 1.6iL, Life, VeloCiti, TenaCiti, CitiStorm, - Sport, - Rox, Rhythm, MKI AFX, 1.8 CTi, Designa, L Sport BZF (83-09), 1.3 L Shuttle, Chico, Chico Lux ET/ GY/ AJD (87-03), 1.4, iL, Chico, Rhythm, Citi com, VeloCiti, TenaCiti, CitiStorm, - Sport, Rox, Rhythm, Wolf, - XCite, Billabong AGY/ BSV (99-09), Fox 1.3 L, L Trippa GY, 1.6 L HM, 1.8 L Sport HV (87-96), Golf II 1.3 CL GY, 1.6 CSL HM, 1.8 8/16V CSX, GTS, GTi KR, EV, 2.0 8/16V GTi AAL (84-92), Golf III 1.6 GS ACG, 1.8 GSX, GTS ACH, 2.0 GTi, Exec. 2E, 2.8 VR6, Exec. AAA (92-99), Jetta II 1.6 CSL HM, 1.8 8/16V CLi, CLi Exec., CLX, CSi, CSX EV/KR, 2.0 8/16V CLi, Exec. AAL (85-92), Jetta III 1.6 CSL ACG, 1.8 CLX/ CSX ACH, 2.0 CLi, Exec. 2E, 2.8 VR6 Exec. AAA (92-99)

## BUYERS GUIDE - OIL SEALS

<b>9857</b>	Timing Cover, Cam, Gearbox	Honda Ballade SC9 "Flip Up Lights" 160i DOHC ZC1 (84-89), SH4 160i 16V DOHC D16A9 (89-92), SR4 150 Encore, Luxline, Spreeline D15B3, 160E, i D16A7, 180E, i B18B3 (92-98), SO4 150i Encore, Luxline, Spreeline D15Z4, 160i Luxline, Spreeline, V-Tec D16Y9, D16Z, 180i Luxline B18B4 (96-00), Hyundai Santa Fe' 2.4 SUV G4JS, 2.7 V6 SUV G6BA-G - 4X4 (01-05), Isuzu KB20 1.6 P/up G161Z Pet., KB21 1.6 P/up G161Z Pet., KB22 1.8 P/up G180Z Pet., KBD20 2.0 P/up C190, KBD21 2.0 P/up C190, KBD22 2.2 LE, P/up C223, KB23 2.0 P/up G200Z, KB24 2.3 LE 4ZD1, KB25 1.6 P/up G161Z, KB26 1.6 P/up G161Z, 1.8 P/up G180Z, KBD23 2.5 LE, P/up 4JA1, KBD25 2.0 P/up C190 (78-89), KBD26 2.0 P/up C190, KBD27 2.2 C223, KBD28 2.5 4JA1 (81-89), KB27 1.8 P/up G180Z, KB28 2.0 P/up G200Z, KB29 2.3 P/up 4ZD1 (83-89), KB40 1.6 G161Z, KB41 1.6 G161Z, 1.8 G180Z, KB42 1.8 G180Z, KB43 2.0 G200Z, KB44 2.3 4ZD1, KBD40, KBD41 2.0 P/up C190, KBD42 2.2 P/up C223 - 4X4 (79-89), KB260 2.6 LE, D/cab, LX P/up 4ZE1, KB320 3.2 LE, D/cab, LX, Frontier, Reef, Blazer P/up 6VD1 (92-04), KB280DT 2.8 D/cab LE, LX, Frontier P/up Turbo 4JB1 - 4X2, 2.8 LE, LX, D/cab P/up Turbo 4JB1 - 4X4 (89-04), Relay 2.0 P/van, Bus 4ZC1 (89-95), Kia Carens 1.8 LS 5 Dr. MPV TBD In-Line (00-03), Carnival 2.5 K55, KRV6, 2.9 CRDi J3 (00-04), Clarus 2.0 GLX 4 Dr. Sedan FE (98-01), Sportage (JA) 2.0 SUV 5 Spd. FE Pet. - 4X4 (98-04), Land Rover Freelander 1.8i S/W Pet., 2.0 Di S/W, Td4 SUV Pet., 2.5 V6 SUV KV6 Pet. (98-04), Mazda 5 2.0 Original, Active, Individual (07-14), 6 2.0 Active, Original, Elegant, 2.3 Dynamic, Dynamic Individual, Sporty, Sporty Lux, 2.3 MPS AWD, 2.5 Dynamic Activematic, Individual (03-14), Rustler 130 SWB Drifter, Explorer P/up B3 Pet., 160, i SWB Explorer, Drifter P/up F6/B6i Pet. (94-02), Nissan Sentra 1.8i Coupe, Sedan Exec. CA18DE (89-92)
<b>9858</b>	Rear Gearbox Oil Seal	Ford Courier 2.5, 3.0 - 4X4 (90-00), Ranger 2.5D, TD (2000-), Mazda B2500, B2600i (96-02), Drifter 2.5Td, 2.6i (02-07)
<b>9859</b>	Use - 486810	
<b>9862</b>	Use - 9838	
<b>9863</b>	Drive Shaft Oil Seal	Nissan 1-Tonner/Hardbody AW/D21 2.4 Z24S, 2.7 TD27, 3.0 VG30E - 4X4 (88-99), Hardbody QW/D22 2.4i KA24E, 2.7 TD27, 3.0 VG30E, 3.0TD ZD30, 3.2, 3.2D QD32, 3.3i VG33 - 4X4 (98-10), Patrol Y60 3.0 VG30E - 4X4 (95-00), Y61 3.0Di, 4.2 TD42 - 4X4 (99-04), Sani AW/D21 2.2 Z22, 2.4 Z24, 2.7 TD27, 3.0 VG30E - 4X4 (86-98), Terrano II 2.7 TD27 - 4X4 (00-02)
<b>9864</b>	Rear Main Bearing Oil Seal	Toyota Dyna 2.2 (85-95)
<b>9865</b>	Front Gearbox Oil Seal	VW Golf III 2.8 (93-96), Jetta III 2.8 (93-99)
<b>9866</b>	Gearbox, Drive Shaft Oil Seal	Nissan 1-Tonner/Hardbody AW/D21 3.0 VG30E - 4X2 (88-98), Sentra 160 GSi, GX, GXi, SE, Si GA16DE/DNE/ DS (92-02)
<b>9867</b>	Front Wheel Oil Seal	Nissan Sabre 160 GX, GXi GA16DS, 200 GXi SR20DE (94-02), Sentra 140, i, GX, GXi, Si GA14DNE / DS, 160 GSi, GX, GXi, SE, Si GA16DE/DNE/ DS, 200 GSi, STi SR20DE (92-02)
<b>9868</b>	Timing Cover, Cam Oil Seal	Nissan Hardbody QW/D22 2.0 NA20S, 2.0i KA20, 2.4i Z24, KA24E/DE - 4X2, 2.4i KA24E, 3.0TD ZD30 - 4X4 (98-10), NP300 2.4i, S/C, D/C Highrider KA24 DE - 4X2, 4X4 (2008-), Juke 1.6 DIG-T (2010-), 1.6 Tekna, Acenta (2013-), NV350 2.5 QR25DE, 2.5D YD25DDTi (2013-), Patrol Y613. 0Di - 4X4 (99-04), Qashqai 2.0 Pet. (2007-), Sabre 200 GXi SR20DE (94-02), Sentra 200 GSi, STi SR20DE (92-02), Tiida 1.8 Acenta (06-13), X-Trail T30 2.0 QR20DE MPV, 2.0 MPV 20DE, 2.5 25DE MPV - 4X2, 4X4 (01-09), T31 2.0 D, DCi - 4X2, 4X4 (08-14), T32 2.0 MR20DD - 4X2 (2014-), Renault Fluence 2.0 (11-16), Koleos 2.5 Dynamique SUV (2009-), 2.5 Dynamique, Premium CVT SUV - 4X4 (2009-)
<b>9869</b>	Timing Cover / Cam Oil Seal	Isuzu KB230 (89-95)
<b>9870</b>	Timing Cover Oil Seal	Ford "Boet" Bantam Rocam 130 Explorer P/up B3, 160, i Explorer, Leisure, Sport, P/up B6/ F6 (94-03), Mazda 323 FWD 2.0 EGi Hatch, SLE Hatch, SLi Sedan, 200e Hatch, Sedan, 200i Hatch 8/16V FE-2000 (89-95), 130 Hatch, Midge, Sedan, Sting B3 (90-95), 130 Hatch, Midge, Sedan, Sting B3 (95-05), Rustler 130 SWB Drifter, Explorer P/up B3 Pet., 160, i SWB Explorer, Drifter P/up F6/B6i Pet. (94-02)
<b>9871</b>	Drive Shaft / Gearbox Oil Seal	Nissan Primera 160 Si, SE SR16DE, 200 GSi, Si, STi, Elegance, Luxury SR20DE (98-02), Qashqai 1.6 Visia, Acenta, 1.6 HR16DE (2007-), Sabre 200 GXi SR20DE (94-02), Sentra 200 GSi, STi SR20DE (92-02)
<b>9872</b>	Drive Shaft Oil Seal	Nissan Almera 1.5 HR15DE (2013-), 1.6 Comfort, Elegance, Luxury 16DE/GA16DE, 1.8 Elegance, Luxury 18DE (01-06), Primera 160 Si, SE SR16DE, 200 GSi, Si, STi, Elegance, Luxury SR20DE (98-02), Sentra 200 GSi, STi SR20DE (92-02), X-Trail T32 2.5 CVT QR25DE - 4X4 (2014-)
<b>9874</b>	Front Gearbox Oil Seal	Audi 500 2.8 (92-94), A4 1.8, 1.8T, 1.9, 2.4, 2.6, 2.8 (95-03), A6 2.4, 2.6, 2.7T, 2.8, 4.2 (94-05), A8 3.7, 4.2 (95-03), S4 2.2 (92-94), 4.2 (03-05)
<b>9875</b>	Rear Gearbox Oil Seal	Audi 500 2.3, 2.8 (92-94), A3 1.8, T (98-03), A4 1.8T, 2.0 (2000-), VW Beetle 2.0 (2000-), Golf IV 1.6i (99-04), Jetta IV 1.6i (99-06), Sharan 1.8T, 2.8 (99-09)
<b>9878</b>	Pinion Oil Seal	Ford Falcon 4.0 (96-01)
<b>9880</b>	Front Wheel Oil Seal	Ford Falcon 4.0 GLi, Fairmont, Fairmont, Futura XR6 MPI (96-03), Ranchero 4.0 GLi, Outback, XR6 P/up 250 (97-99)



## BUYERS GUIDE - OIL SEALS

<b>9883</b>	Front Wheel Oil Seal	Toyota Hilux RN67 2.4 LWB D/cab, Raider D/cab P/up 22R Pet. - 4X4 (94-98), RZN194 2.7i LWB D/cab, Raider, SRX, Legend35 Raider, 3RZFE Pet. (98-05), LN192R 3.0D LWB Raider D-E, Raider DLX D/cab D-E, Legend35 Raider, P/up 5L Dies., 3.0iD LWB Raider, Raider D/cab, P/up KZ-TE Dies. (98-05), RZN169 2.7i LWB D/cab, DLX S/cab, Raider S/D/cab, SRX D/cab, Legend 35 LWB P/up 3RZFE Pet., LN167 3.0D D/cab D-E, DLX, S/D/cab DE, Raider DE, Legend35 LWB P/up 5L Dies., 3.0iD LWB Raider S/cab & KZ-TE D/cab P/up, Legend35 - 4X4 (98-05),
<b>9885</b>	Pinion Oil Seal	Mercedes-Benz W124 E Class E200 M102.922, E220 M111.960, E320 Sportline, M104.992 (93-96), R170 SLK200 (97-02), W202/3 C-Class C180 Classic M111.920, C200 M111.941, C220 M111.961, C230 M111.974, C240 M111.944, C250 M605.910, C270CDi M612.962, C280 M104.941 (94-08), W208 CLK230, M111.973, CLK320, M112.940, CLK430, CLK500 (98-03), W210/211 E-Class E200, K M111.941/956, E230 M111.970, E240 M112.911, E280 M112.921, E320 M112.941, E320CDi OM646.961, E350 M272.964, E500 M113.967 (96-10)
<b>9886</b>	Pinion Oil Seal	Mercedes-Benz 190E 1.8, 2.0, 2.3 (93-94), 200, 200E, 220E, 230E, 260E, 280E, S, SE, 300D, E, 320E, 350SE, 500SE (86-96), C200, C230, C240, C250, C270 (94-08), CLK230, CLK320 (98-04), E200, E220, E230, E270, E320 (96-04), S320, S420, S500 (93-98), SLK230 (97-04), Sprinter 2.2 (96-06)
<b>9887</b>	Pinion Oil Seal	Mitsubishi Colt LDV 2.5D, 2.6, 3.0 - 4X4 (Rear Import) (95-98)
<b>9889</b>	Use - 9620	
<b>9890</b>	Rear Main Bearing Oil Seal	Ford Fiesta II 1.6i RSi, TDCi Rocam, 2.0 ST, ST150 (04-09), Figo 1.4 Ambiente', Trend, FXJA/B (2010-), Ikon 1.4, Low, LX, 1.6i (07-11), Mondeo 1.8i LX, Tdi LX Zetec M5 Endura TD, 2.0i Aspen, CLX, CLX, Ghia, Trend Zetec M5, 2.5i Si Duratec M5 (97-01)
<b>9891</b>	Front Wheel Oil Seal	C.A.M. Rhino 2.2i, 2.8i (2007-), Hyundai Terracan 2.9 CRDi SUV, 3.5i V6 SUV - 4X4 (03-08), Mitsubishi Colt LDV 2.5D LWB Hi-Line P/up 4D56 Dies., 2.6 LWB Lo-/Hi-Line, P/up 4G54 Pet., 3.0 V6 LWB Lo-/Hi-Line D/cab, Rodeo 6G72 Pet. - 4X4 (95-98), 2.4i LWB Hi-Line D/cab, Trailbuster S/cab, P/up Pet. (98-09), 2.8TDi LWB Pioneer, Rodeo D/cab P/up Turbo Dies., 2.8D, TDi LWB Club cab, Trailbuster S/cab, Rodeo /cab P/up Dies./ Turbo Dies., 3.0i V6 LWB Rodeo D/cab P/up Pet. - 4X4 (99-09), Pajero 2.8 Tdi, 3.0 V6 SWB GLS Wagon 6G72 Pet., 3.5 V6 SWB GLS Wagon 6G74 Pet. - 4X4 (90-01)
<b>9897</b>	Rear Main Bearing Oil Seal	Toyota Land Cruiser 4.5 - 4X4 (92-04)
<b>9898</b>	Timing Cover Oil Seal	Toyota Land Cruiser FZJ/HZJ75 4.2 GX S/W, P/up 1FZF/HZ Dies. (91-97), FZJ105 4.5 V8 VX, Turbo P/up, S/W 2UZ-FE Pet. (98-06), HDJ/HZJ80 4.2 GX, Turbo S/W, P/up 1HD-FT, 1HZ Dies., T. Dies. (90-95), HDJ/HZJ80 4.2 Std., GX, VX, Turbo S/W, P/up 1HD-FT, 1HZ Dies., Turbo Dies. (95-01), HDJ200 4.5 D-4D, 4.6 V8, 4.7 V8 (2007-), Prado 90/95 3.0 1KZ-TE GX, GX TDi S/W Dies., VX S/W Pet., 3.4 V6 GX, VX S/W Pet. 5VZ-FE - 4X4 (97-04)
<b>9899</b>	Timing Cover Oil Seal	Toyota Land Cruiser 1FZF (91-97)
<b>9900</b>	Timing Cover Oil Seal	Toyota Land Cruiser FZJ/HZJ75 4.2 GX S/W, P/up 1FZF/HZ Dies. (91-97), FZJ105 4.5 V8 VX, Turbo P/up, S/W 2UZ-FE Pet. (98-06), HDJ/HZJ80 4.2 GX, Turbo S/W, P/up 1HD-FT, 1HZ Dies., T. Dies. (90-95), HDJ/HZJ80 4.2 Std., GX, VX, Turbo S/W, P/up 1HD-FT, 1HZ Dies., Turbo Dies. (95-01), HDJ100 4.2 Std., GX, VX S/W, 1HZ Pet., 4.5, 4.7 V8 (97-04), HDJ200 4.5 D-4D, 4.6 V8, 4.7 V8 (2007-), HZJ105 4.2 Std., GX DSL, Turbo P/up, S/W 1HZ Dies., Turbo Dies., UZJ100 4.5 V8 Std., GX, VX S/W, P/up 2UZ-FE Pet. (98-06), Prado 90/95 3.0 1KZ-TE GX, GX TDi S/W Dies., VX S/W Pet., 3.4 V6 GX, VX S/W Pet. 5VZ-FE - 4X4 (97-04)
<b>9901</b>	Drive Shaft Oil Seal	Toyota Rav4 2.0 (94-02)
<b>9902</b>	Timing Cover / Cam Oil Seal	Toyota Land Cruiser 4.0 (86-92)
<b>9903</b>	Rear Main Bearing Oil Seal	Toyota Land Cruiser 4.0 (86-92)
<b>9905</b>	Gearbox Oil Seal	VW Polo 6N 1.4 Classic, Playa Lux AEX, 1.6 Classic, Playa, Lux AEE, 1.8 Classic, Playa, Lux ADZ (96-03)
<b>9907</b>	Drive Shaft Oil Seal	Mercedes-Benz W202/3 C-Class C180 Classic M111.920, C200 M111.941, C220 M111.961, C230 M111.974, C240 M111.944, C250 M605.910, C270CDi M612.962, C280 M104.941 (94-08), W208 CLK230, M111.973, CLK320, M112.940, CLK430, CLK500 (98-03)
<b>9908</b>	Drive Shaft Oil Seal	Mercedes-Benz 190E 1.8, 2.0, 2.3 (93-94), 200, 200E, 220E, 230E, 260E, 280E, S, SE, 300D, E, 320E, 350SE, 500SE (86-96), C200, C230, C240, C250, C270 (94-08), CLK230, CLK320 (98-04), E200, E220, E230, E270, E320 (96-04), S320, S420, S500 (93-98), SLK230 (97-04), Sprinter 2.2 (96-06)
<b>9909</b>	Drive Shaft Oil Seal	Mercedes-Benz W202/3 C-Class C250 (94-08), Vito/Viano 113CDi, 115CDi, 116CDi, 120CDi, 122CDi (03-06)
<b>9910</b>	Drive Shaft Oil Seal	Mercedes-Benz W123 200, 230, 240D, 250, 280, 300D (77-86)
<b>9913</b>	Front Wheel Oil Seal Outer	Toyota Rav4 2.0 - 4X4 (94-02)

## BUYERS GUIDE - OIL SEALS

<b>9914</b>	Rear Main Bearing Oil Seal	Chevrolet Captiva 2.4 LT Z24SED - 4X2, 4X4 (07-11), 2.4 LT, LS 5-dr LE5 - 4X2, 4X4 (11-17), Optra 1.8 Lt T18SED (04-11), Daewoo Nubira I 2.0 CDX, Nubira II 2.0 CDX, Exec., S/W (97-03), Tacuma 2.0 CDX, CDX Plus (01-03), Isuzu KB200i 2.0 LX, KB240i 2.4 LX - 4X2, 4X4 (04-13), KB250i 2.5 LX, KB250Dc 2.5, KB300TDi 3.0 LX - 4X2, 4X4 (04-09), Opel Astra F 160i, iE, iS, Estate 16NZ, 180i, iE 18SE/ XE, XL (93-99), Astra G 2.0 Coupe', CSX X20XE, 2.2i Classic Exec. (99-05), Astra H 2.0 Coupe' Turbo, GSi, GTC Turbo, GTC Turbo OPC, GTC Turbo Sport, Turbo Sport, Twin top (04-10), Corsa B 1.8i GSi Hatch (96-03), Corsa C 1.8i GSi Hatch, Classic (03-08), Corsa LDV 1.8i Utility Club, Sport P/up (03-10), Kadett D, E 1.8 GTE 18E, L 18LV, GSi Hatch 18L, GLX 18SV, GSi 18E/ S (89-93), Kadett E 2.0 GSi 20XE, SGi 20SEH, 200, iS 20SE, Boss 20SEH, CD 20SHE, GSi, Super Boss 20SEH (87-93), Kadett F 180i, iE, GSi 18SE, 200is 20XE (93-99), Meriva 1.8 Elegance MPV Easytronic (03-09), Monza 1.8 CLX, GLE, GLX, Convertible, GLi 18SE/ SV, 2.0 CD, CLi 2.0XE, CLE, GLE 20SE/ V (86-93), Zafira II 1.9CDTi Elegance, 2.0i Turbo OPC, 2.2i Enjoy, Elegance MPV Z22SE (05-09)
<b>9917</b>	Rear Main Bearing Oil Seal	Opel Astra G 1.8 Classic CDE, Caravan CD S/W, Elegance, Irmischer X18XE1 (99-06), Corsa C 1.7TDi Sport, Classic, CDTi Enjoy, Hatch CDTi Elegance, Classic DTi Elegance X17D (03-08), Corsa LDV 1.7D Utility P/up X17D (97-04), Corsa LDV II 1.7DTi Utility Club, Sport P/up (03-10), Meriva 1.7 CDTi Enjoy, Elegance (03-09), Zafira I 1.8i CD, Enjoy, Elegance MPV Z18XE/-1 (01-05), Zafira II 1.8i Enjoy, Elegance MPV Z18XE/-1 (05-09)
<b>9918</b>	Front Wheel Oil Seal	Ford Courier 2.5TD D/cab, Leisure P/up WL4, 3.0 V6 Std., XLT, D/cab, Leisure, Explorer, Exec. P/ up Essex, 3.4 V6 Leisure, P/up Essex. - 4X4 (96-00), Ranger 1.8 XL, P/up, 2.2 XL, P/up (04-10), 2.5 D/Cab, High Trail, XL, DT XLT High Super Cab, 2.5TD Montana D/Cab WL4, 3.0TDCi, 4.0 Super Cab XLT - 4X4 (00-12), Mazda B-Series B2600 2.6 V6 LWB D/cab, Magnum, Drifter P/up 4G54 Pet. (86-95), B3000 3.0 V6 LWB D/cab, Magnum, Drifter, Magnum Drifter P/up Essex Pet. (86-97), B2500 2.5, Td LWB D/Cab, Drifter, SLX P/up WL4 Dies./Turbo Dies. (96-99), B3400 3.4 V6 LWB Magnum D/cab P/up Essex (96-01), B2600i 2.6i V6 LWB Drifter, D/cab Drifter SLX P/up 4G54 Pet. 4X4 (00-09), Drifter 1.8 SWB/LWB XL P/up Pet., 2.2 SWB/LWB XL P/up Pet. (00-09), 2.5Td LWB D/cab, DL, SL, SLE, SLX S/cab, D/cab P/up WL4 Dies./Turbo Dies., 2.6i V6 LWB SL S/cab, SLE, SLX D/cab P/up 4G54 Pet. 4X4 (02-04)
<b>9919</b>	Gearbox Oil Seal	Toyota Land Cruiser FZJ/HZJ75 4.2 GX S/W, P/up 1FZF/HZ Dies. (91-97), FZJ80 4.5 Std., GX, VX, Turbo S/W, P/up 1FZ-FE Dies., Turbo Dies. (92-95), FZJ80 4.5 Std., GX, VX, Turbo S/W, P/ up 1FZ-FE Dies., Turbo Dies. (95-06), FZJ105 4.5 Std., GX, Turbo P/up, S/W 1FZ-FE Dies., Turbo Dies. (95-98), HDJ/HZJ80 4.2 GX, Turbo S/W, P/up 1HD-FT, 1HZ Dies., T. Dies. (90-95), HDJ/ HZJ80 4.2 Std., GX, VX, Turbo S/W, P/up 1HD-FT, 1HZ Dies., Turbo Dies. (95-01), HDJ100 4.2 Std., GX, VX S/W, 1HZ Pet., 4.5, 4.7 V8 (97-04), HZJ105 4.2 Std., GX DSL, Turbo P/up, S/W 1HZ Dies., Turbo Dies. (98-06), UZJ100 4.5 V8 Std., GX, VX S/W, P/up 2UZ-FE Pet. - 4X4 (98-06)
<b>9920</b>	Gearbox Oil Seal Front	Toyota Land Cruiser PHJ75 3.9 DLX, GX, GX Turbo P/up Perkins236 2H Dies., FJ75 4.0 DLX, GX, VX 3F/F-E Pet., HJ75 - 4X4 (85-92)
<b>9921</b>	Gearbox Oil Seal Rear	Toyota Land Cruiser FJ80 4.0 DLX, GX, VX P/up 3F/F-E Pet. (90-92), PHJ75 3.9 DLX, GX, GX Turbo P/up Perkins236 2H Dies., FJ75 4.0 DLX, GX, VX 3F/F-E Pet., HJ75 - 4X4 (85-92)
<b>9924</b>	Front Gearbox Oil Seal	Audi A4 2.4, 2.6, 2.8 (95-01), A8 3.7, 4.2 (95-03), S4 2.2 (92-94), 4.2 (03-05), VW Passat 1.8T, 2.8 (99-06)
<b>9925</b>	Timing Cover Oil Seal	BMW 3 Series E30 316 1.8 M10, 316i 1.6 M40, 318i 1.8 M40, 320i M20/50, 323i M50, 325i M52, 333i M30 (83-92), E36 316i 1.8 Dolphin Shape M40, 318i 1.9 M44, 320i 2.0 M50, 323i 2.5 M52, 325i M50, 328i 2.8, 3.0 M52, Z3 2.8, 3.0 Roadster (92-00), E37 M3 M Coupe S50 (93-01)
<b>9928</b>	Pinion Oil Seal	BMW 316i, 318i, 320i, 323i, 325i, 328i (92-00), 525i, M Coupe (90-01), M3 (93-98), Z3 (97-99)
<b>9929</b>	Pinion Oil Seal	BMW 520i, 525i, 530i, 535i, 540i, 750i (88-96), M5 (90-94)
<b>9931</b>	Rear Main Bearing Oil Seal	BMW 1 Series E87 116i 1.6 N45, 118i 2.0 N46, 120i 2.0 N46, 130i 3.0 N52 (04-15), 3 Series E36 M3 Coupe 6 Cyl. (01-04), 5 Series E39 523i 2.5 M52, 525i 2.5 M54, 528i 2.8 M52, 530i, d 3.0 M54/ M57, 540i 4.4 M62 (98-04), E60/61 523i 2.5 N52 / N53, 525i 2.5 M54 / N52, 530i M54 / N52, 530d 3.0 M57 (04-10), F07, F10/ F11, F18 528i (2011-), 7 Series E23 728, i M30, 730 M30, 733i M30, 735i M90, 745i M88 (78-89), E32 730i M30/60, 735i M106, 740i M60 (87-95), M5 V8 Coupe (99-03), X1 xDrive E84 18i 2.0 N46 - 4X4 (09-15), X3 E83 2.5i SUV M54, E83LCi 2.5si SUV N52N - 4X4 (04-07), E83LCi 3.0i SUV M57N2 - 4X4 (05-10), X5 E53/70 3.0i SUV M54 - 4X4 (2001-)
<b>9932</b>	Rear Main Bearing Oil Seal	BMW E32 Series 750iL (87-95), E31 Series (91-94), E38 Series (95-03)
<b>9933</b>	Rear Main Bearing Oil Seal	Ford Falcon 4.0 (96-01)
<b>9934</b>	Front Gearbox Oil Seal	Ford Falcon 4.0 (96-01)
<b>9935</b>	Rear Main Bearing Oil Seal	Ford Telstar 2.5 V6 Ghia, GLi KL, TX5 2.5 V6 RSi KL (94-99), Mazda 626 2.5i V6 Exec. KL, MX-6 2.5 V6 KL (93-98)
<b>9937</b>	Use - 9622	
<b>9937</b>	Drive Shaft Oil Seal	Honda Ballade SR4 150 Encore, Luxline, Spreeline D15B3, 160E, i D16A7, 180E, i B18B3 (92-98), SO4 150i Encore, Luxline, Spreeline D15Z4, 160i Luxline, Spreeline, Vtec D16Y9, D16Z, 180i Luxline B18B4 (96-00)
<b>9938</b>	Drive Shaft Oil Seal	Honda Civic 150, 160 (96-00), CR-V 2.0 (97-03)
<b>9940</b>	Front Wheel Oil Seal	Nissan Sabre 160 GX, GXi GA16DS, 200 GXi SR20DE (94-02), Sentra 140, i, GX, GXi, Si GA14DNE / DS, 160 GSi, GX, GXi, SE, Si GA16DE/DNE/ DS, 200 GSi, STi SR20DE (92-02)

## BUYERS GUIDE - OIL SEALS

<b>9942</b>	Front Wheel Oil Seal Inner	Mercedes-Benz 200, 230, 230E, 240D, 250, 280E, S, SE, 300D, SE, 380SE, 420SE, 500SE (77-93)
<b>9943</b>	Front Wheel Oil Seal Inner	Mercedes-Benz Sprinter 2.2 (96-06)
<b>9944</b>	Drive Shaft Oil Seal	Mercedes-Benz Sprinter 2.2 (96-06)
<b>9946</b>	Use - 9946	
<b>9946</b>	Front Wheel Oil Seal	Ford Courier 2.5TD D/cab, Leisure P/up WL4, 3.0 V6 Std., XLT, D/cab, Leisure, Explorer, Exec. P/up Essex, 3.4 V6 Leisure, P/up Essex. - 4X4 (96-00), Ranger 1.8 XL, P/up, 2.2 XL, P/up (04-10), Ranger 2.5 Diesel, Turbo Diesel D/Cab, High Trail, XL, DT XLT High Trail D/Cab, Super Cab, 3.0TDCi Super Cab XLT Hi-Trail., 4.0 SubCab XLT Hi Trail, Super Cab XLT Hi-Trail. - 4X2, 2.5 D/Cab, High Trail, XL, DT XLT High Super Cab, 2.5TD Montana D/Cab WL4, 3.0TDCi, 4.0 Super Cab XLT - 4X4 (00-12), Mazda B-Series B2500 2.5, Td LWB D/Cab, Drifter, SLX P/up WL4 Dies./Turbo Dies. (96-99), B2600 2.6 V6 LWB D/cab, Magnum, Drifter P/up 4G54 Pet. (86-95), B2600i 2.6i V6 LWB Drifter, D/cab Drifter SLX P/up 4G54 Pet. 4X4 (00-09), B3000 3.0 V6 LWB D/cab, Magnum, Drifter, Magnum Drifter P/up Essex Pet. - 4X4 (86-97), B3400 3.4 V6 LWB Magnum D/cab P/up Essex (96-01), BT-50 2500 Tdi, 2.6i SLE D/cab., S/cab., 3000 CRDi SLE D/cab., Freestyle SLX S/cab., D/cab - 4X2, 4X4 (07-12), BT-50 3.2 MZ-CD P5-AT - 4X4 (2012-), Drifter 1.8 SWB/LWB XL P/up Pet., 2.2 SWB/LWB XL P/up Pet. (00-09), 2.5Td LWB Hi Ride, SL SLE, SLX D/cab, Hi Ride, Hi Trail D/cab P/up WL4 Dies./Turbo Dies. - 4X2, 2.5Td LWB D/cab, DL, SL, SLE, SLX S/cab, D/cab P/up WL4 Dies./Turbo Dies. - 4X4, 2.6i LWB Hi Ride, SL Hi Ride S/cab, SLE, SLX D/cab SLX Hi Ride D/cab, SLX Hi Trail D/cab P/up Pet. - 4X2, 2.6i V6 LWB SL S/cab, SLE, SLX D/cab P/up 4G54 Pet. - 4X4 (04-09)
<b>9947</b>	Gearbox Oil Seal	Fiat Seicento 1.1 S, Sporting 176B2.000 (01-03), Stilo 1.6 Active, MultiWagon, 182B6 (03-06), Uno 1.4 Turbo 146A (96-98), 1.0 Cento 156A2, 1.1 Espresso P/van 160A3, 1.1 Fire, Rio, Mia, Tempo 160A3, 1.4 Pacer, Beat, Mia, Tempo, SX 146C1 (96-05)
<b>9948</b>	Front Wheel Oil Seal	Ford Telstar 2.0 GL, GLE, GLi, Mystique FS/KF, 2.5 V6 Ghia, GLi KL, TX5 2.5 V6 RSi KL (94-99), Kia Carens 1.8 LS 5 Dr. MPV TBD In-Line (00-03), Kia Sephia 1.5i LS, RS 4 Dr. Sedan BFD (04-05), Shuma I 1.5i LS 4 Dr. Sedan BFD, 1.8i GS 5 Dr. H/back TBD (98-01), Spectra 1.6 Exec. A6 (01-03), Mazda 626 2.0i 16V Medium High, V6 24V High KF/KS, 2.5i V6 Exec. KL, MX-6 2.5 V6 KL (93-98), 2.0 S/W, Sedan FE (98-03), Astina 180 Se Hatch Bpi (95-00), Etude 160, e, i, iE, iSE Sport, 180, e, SE, 160 iE, iSE, Sport, 180 iSE, iSX, Sport (95-04), MX-5 1.6 (90-93), 1.8 16V (01-09), 2.0 (05-14)
<b>9952</b>	Pinion Oil Seal	Mitsubishi Colt LDV 3.0 (95-98), Pajero 3.0 V6, 3.5 V6 - 4X4 (91-01)
<b>9953</b>	Front, Rear Wheel Oil Seal	Land Rover 110 Series II, IIA, III 2.6 LWB P/up 6 Cyl. OHI SE Pet., 3.5 LWB "PUP" P/up V8 ADE236 Pet. (84-96), Defender 90 2.5 TDi Country, 2.8i CSW S/W, 3.5 CSW S/W, Defender 110 2.5 TD, i TD5 Storm, 2.8, i CSW S/W, 3.5 CSW S/W (89-04), Defender 90 2.2 TD, 2.4 TD, 2.5 TD5, Defender 110 2.2 TD, 2.5 TD, I (2002-), Defender 130 2.5TD, i TD5 Storm, 3.5 CSW S/W, Discovery 2.5TD, i TD5 ES, GS, XS, S S/W, 3.5 P/up, S/W, 3.9i ES, S P/up, S/W (89-04)
<b>9955</b>	Rear Wheel Oil Seal	C.A.M. Rhino 2.2i, 2.8i (2007-), Hyundai Bakkie 2.5i D4BH Dies., 2.6i D4BB Dies. (97-01), H100 P/Van 2.5i D4BH Dies. 2.6i D4BB Dies. (00-07), Mitsubishi Colt LDV 1.6 SWB/LWB Lo-Line P/up 4G32 Pet., 2.0 4G63 Pet., 2.5D 4D56 Dies., 2.6 WB Hi-Line P/up 4G54 Pet. - 4X2 (94-98), 2.5D LWB Hi-Line P/up 4D56 Dies., 2.6 LWB Lo-/Hi-Line, P/up 4G54 Pet., 3.0 V6 LWB Lo-/Hi-Line D/cab, Rodeo 6G72 Pet. - 4X4 (95-98), 2.8TDi LWB Pioneer, Rodeo D/cab P/up Turbo Dies., 3.0i V6 LWB Rodeo D/cab P/up Pet. - 4X2, 2.8D, TDi LWB Club cab, Trailbuster S/cab, Rodeo /cab P/up Dies./ Turbo Dies., 3.0i V6 LWB Rodeo D/cab P/up Pet. - 4X4 (99-09), Pajero 2.8 Tdi, 3.0 V6 SWB GLS Wagon 6G72 Pet., 3.5 V6 SWB GLS Wagon 6G74 Pet. - 4X4 (90-01)
<b>9957</b>	Timing Cover Oil Seal	Alfa Romeo 145 2.0 (96-01), 146 2.0 (96-99), 147 1.6, 2.0 (01-10), 155 2.0 (96-99), 156 2.0 (98-07), GTV/Spider 2.0 (96-06), Fiat Multipla 1.9 (03-07), Punto 1.8 (2004-), Stilo 1.9 (03-06), Doblo 1.9 (03-07)
<b>9958</b>	Rear Main Bearing Oil Seal	Alfa Romeo 145 2.0 (96-01), 146 2.0 (96-99), 147 2.0 (01-10), 155 2.0 (96-99), 156 2.0 (98-07), GTV/Spider 2.0 (96-06), Fiat Punto 1.8 (2004-)
<b>9959</b>	Drive Shaft Oil Seal	Alfa Romeo 145 2.0 (96-01), 146 2.0 (96-99), 147 1.6, 2.0 (01-10), 155 2.0, 2.5 (96-99), 156 2.0, 2.5 (98-07), 164 3.0 (96-99), 166 3.0 (99-03), GTV/Spider 2.0 (96-06), Fiat Multipla 1.9 (03-07), Stilo 1.9 (03-06), Doblo 1.9 (03-07)
<b>9960</b>	Drive Shaft Oil Seal	Alfa Romeo 145 2.0 (96-01), 146 2.0 (96-99), 147 1.6, 2.0 (01-10), 155 2.0 (96-99), 156 2.0, 2.5 (98-07), GTV/Spider 2.0 (96-06), Fiat Multipla 1.9 (03-07), Stilo 1.9 (03-06), Doblo 1.9 (03-07)
<b>9961</b>	Drive Shaft Oil Seal	Alfa Romeo 155 2.5 (96-99), 156 2.5 (98-07)
<b>9962</b>	Rear Main Bearing Oil Seal	Alfa Romeo 155 2.5 (96-99), 156 2.5 (98-07), GTV 3.0 V6 (99-04)



## BUYERS GUIDE - OIL SEALS

<b>9963</b>	Timing Cover Oil Seal	Mercedes-Benz W140 S-Class S320 M104.990, S420 M119.971, S500 M119.980 (93-99), W163 ML230 5 Dr. SUV M111.977, ML320 5 Dr. SUV M112.942, ML430 5 Dr. SUV M113.942 (98-06), R170 SLK200, SLK320 M112.947 (97-02), W201 190E 1.8 M102.920, 2.0 M102.922, 2.3 Sportline M102.983 (93-94), W202/3 C-Class C180 Classic M111.920, C200 M111.941, C220 M111.961, C230 M111.974, C240 M111.944, C250 M605.910, C270CDi M612.962, C280 M104.941 (94-08), W208 CLK230, M111.973, CLK320, M112.940, CLK430, CLK500 (98-03), W210/211 E-Class E200, K M111.941/956, E230 M111.970, E240 M112.911, E280 M112.921, E320 M112.941, E320CDi OM646.961, E350 M272.964, E500 M113.967 (96-10), BM903/4 Sprinter 308D 2.2 OM 601 LA Dies., 312D 2.2 OM602 LA Dies., 313 2.2 LWB, SWB Bus, P/van OM611 LA Pet., 412D 2.8 OM612, 413CDi 2.2, 416CDi 2.2 (96-06), Vito/Viano W638 113CDi, 115CDi, 116CDi, 120CDi, 122CDi (03-06), Ssangyong Korando 2.3 K230 EL, Open Top S/W, 2.9 K290 EL, TDi, Open Top S/W, 3.2 K320 EL S/W, Musso 2.3 E230 EL S/W, 2.9 602, EL, EX, TDi, Exec., E290 TDi, Exec., 3.2 E320 EL Exec. (95-04)
<b>9964</b>	Rear Main Bearing Oil Seal	Mercedes-Benz 190E 1.8, 2.0, 2.3 (93-94), 200, 200E, 220E, 230E, 260E, 280E, S, SE, 300D, E, 320E, 350SE, 500SE (86-96), C200, C230, C240, C250, C270 (94-08), CLK230, CLK320 (98-03), E200, E220, E230, E270, E320 (96-04), S320, S420, S500 (93-98), SLK230 (97-03), Sprinter 2.2 (96-06), Vito 2.2 (03-06), SsangYong Korando 2.3, 2.9, 3.2 (95-04), Musso 2.3, 2.9, 3.2 (95-04)
<b>9965</b>	Timing Cover Oil Seal	Nissan Maxima 2.0, 3.0 (97-04), Murano 3.5 SUV, Navara 4.0i V6 P/up - All - 4X2, 4X4, Pathfinder 4.0i V6 P/up - All - 4X2, 4X4 (2005-)
<b>9966</b>	Timing Cover, Cam Oil Seal	Nissan Datsun Go/Go+ 1.2 HR12DE (2014-), Juke 1.2 DIG-T HRA20DDT, 1.6 HR16DE - 4X2 (2010-), Opel Corsa C 1.7TDi Sport, Classic, CDTi Enjoy, Hatch CDTi Elegance, Classic DTi Elegance X17D (03-08), Corsa LDV 1.7D Utility P/up X17D (97-04), Corsa LDV II 1.7DTi Utility Club, Sport P/up (03-10), Meriva 1.7 CDTi Enjoy, Elegance (03-09), Renault Captur 0.9 Tce H4B400 (2016-), Kadjar 1.2 TCe H5F408 (2015-)
<b>9967</b>	Gearbox, Timing Cover Oil Seal	Daewoo Cielo 1.5 GL, GLX, GTX, 150i L, Espero 1.8 CD, C18LE, 2.0 CD, C20LE (96-99), Opel Ascona 1.3 L 13NV/SC (82-87), Astra F 140i, iS 14NV, 160i, iE, iS, Estate 16NZ (93-99), Corsa B 130, i, Lite, iE, iS, Chill Hatch / Sedan 13NE, 140i, Classic, Active, Lite, Lite+, Comfort, Chill, Sport, S 14NE, Hatch/ Sedan, 160, i, iE, Classic, GSi, i Sport, S Hatch/ Sedan, 16SE, 1.8i GSi Hatch (96-03), Corsa C 140i Classic, Comfort, Chill, Classic Essentia, Hatch Club, Sport, Lite Sport, S14NE, 160i Classic, Classic Elegance, Classic CD, CDE, Sport, 16SE, 1.7TDi Sport, Classic, CDTi Enjoy, Hatch CDTi Elegance, Classic DTi Elegance X17D, 1.8i GSi Hatch, Classic (03-08), Corsa LDV 130i Utility P/up 13NE, 1.4i Utility, S P/up 14NE, 1.6i Utility Sport P/up 16NZ, 1.7D Utility P/up X17D (97-04), Corsa LDV II 1.4i Utility, Club Sport, S P/up 14XE, 1.7DTi Utility Club, Sport P/up, 1.8i Utility Club, Sport P/up (03-10), Corsa P/van 1.3i Pronto 13NE, 1.4i Combo P/van (1999-), Kadett D, E 1.2 L 12NS, 1.3 Cub, GL, GLS, LS, Rebel 13NV, 140 CL, Cub 14NE/ NV, 1.6 GL, GLS, GSE, L, Rebel, Cub 16SH/ SE, 160i, GSi Aspen 16SE (80-93), Kadett F 140, S 14NE, 160i, iS, GSi, Aspen 16SV/ NZ (93-99), Meriva 1.3 CDTi Enjoy, 1.4 Essentia, Enjoy, 1.6 Club, Comfort, Enjoy MPV Z16SE/-XE, 1.7 CDTi Enjoy, Elegance, 1.8 Elegance MPV Easytronic (03-09), Monza 160 GSi, i Aspen 16SE/ NZ, CLS 16SV (86-93)
<b>9968</b>	Drive Shaft Oil Seal	Daewoo Lanos II 1.4, 1.6 (00-03)
<b>9969</b>	Use - 9716	
<b>9970</b>	Use - 9104	
<b>9971</b>	Timing Cover, Cam Oil Seal	Chevrolet Spark 0.8 L, LS, 1.0 LT, LS (03-10), Daewoo Matiz 800cc S, SE F8CV (99-03)
<b>9972</b>	Gearbox Oil Seal Front	Chevrolet Aveo 1.5 L, LS, LT, 1.6 LS (03-15), Spark 0.8 L, LS, 1.0 LT, LS (03-10), 1.0 B110S1, 1.2 B12D1 (2010-), Daewoo Matiz 800cc S, SE F8CV (99-03)
<b>9973</b>	Front Wheel Oil Seal	Chevrolet Spark 0.8 L, LS, 1.0 LT, LS (03-10), Daewoo Matiz 800cc S, SE F8CV (99-03)
<b>9974</b>	Drive Shaft Oil Seal	Chevrolet Aveo 1.5 L, LS, LT, 1.6 LS (03-15), Daewoo Cielo 1.5 GL, GLX, GTX, 150i L, Espero 1.8 CD, C18LE, 2.0 CD, C20LE (96-99), Opel Astra G 1.6 CS, Classic CD, CDE, Comfort C16SEL, 1.8 Classic CDE, Caravan CD S/W, Elegance, Irmscher X18XE1, 2.0 Coupe', CSX X20XEV, 2.2i Classic Exec. (99-06), Astra H 1.4 Essentia, Z14XEP, 1.6 Classic Club, Elegance, Enjoy, Essentia, Sport Z16XEP, 1.8 Enjoy, GTC, GTC Sport, Twintop, Enjoy, Z18XER, 1.9 CDTi Enjoy, GTC, CDTi, GTC CDTi Sport, 2.0 Coupe' Turbo, GSi, GTC Turbo, GTC Turbo OPC, GTC Turbo Sport, Turbo Sport, Twin top (04-10), Corsa D 1.3CDTi Enjoy, 1.4i Essentia, Enjoy, Cosmo, Sport, 1.6i Sport, OPC (08-15), Meriva 1.3 CDTi Enjoy, 1.4 Essentia, Enjoy, 1.6 Club, Comfort, Enjoy MPV Z16SE/-XE, 1.7 CDTi Enjoy, Elegance, 1.8 Elegance MPV Easytronic (03-09), Zafira I 1.8i CD, Enjoy, Elegance MPV Z18XE/-1 (01-05), Zafira II 1.6 Essentia MPV, 1.8i Enjoy, Elegance MPV Z18XE/-1, 1.9CDTi Elegance, 2.0i Turbo OPC, 2.2i Enjoy, Elegance MPV Z22SE (05-09)
<b>9975</b>	Rear Main Bearing Oil Seal	Ford Focus II 2.5ST (2005-), Volvo C30 2.5 (2008-), C70 2.3, 2.5T (02-04), S40 2.4i, 2.5i (04-09), S60 2.0T, 2.3, 2.4, T, 2.5T (01-06), S70 2.3, 2.4 (97-01), S80 2.4T, 2.5T (02-06), S90 2.9 (97-00), V40 2.0T (98-04), V50 2.4i, 2.5i (04-09), V70 2.0T, 2.3, 2.4, T, 2.5T (00-06), V90 2.9 (97-00), S60 2.5 R, V70 2.5T R - 4X4 (03-06), XC70 2.4, 2.5T (00-07), XC90 2.4, 2.5T (04-09)
<b>9976</b>	Front Gearbox Oil Seal	Land Rover Defender 110 2.5Tdi, 3.5, Defender 130 2.5, Td, Tdi, 3.5, Defender 90, Discovery 2.5Tdi, 3.5, 3.9i (95-05)

## BUYERS GUIDE - OIL SEALS

<b>9977</b>	Drive Shaft Oil Seal Left	Fiat Palio I 1.2 ED, EL, Go!, Paint Ltd. M657BA.12T 178B5.000, 1.6 EL, ELX, HL, Weekend S/W, 178B3.000 (00-05), Palio II 1.2 Espresso 178B6.000, 1.2 Go!,178B5.000, 1.6 178B3.000, 1.7TD, EL. (05-10), Panda 1.2 Dynamic 169A4.000, 188A4.000 (2013-), 1.4 100HP 169A3.000 (2006-), Punto 1.2 Dynamic 188A5000 (04-13), Seicento 1.1 S, Sporting 176B2.000 (01-03), Siena I/II 1.2 EL, EL, Plus!, M657BA 12T, 1.6 EL, Plus!, ELX HL 178B3.000, 1.6 EL+, HL, ELX, 178B3000, 1.7TD EL 176A3.000 (00-10), Stilo 1.6 Active, MultiWagon, 182B6 (03-06), Strada 1.2 EL P/up, 1.4, 1.6 EL, EL Sporting, ELX P/up, 1.7D EL P/up (05-10), Uno 1.0 Cento 156A2, 1.1 Espresso P/van 160A3, 1.1 Fire, Rio, Mia, Tempo 160A3, 1.4 Pacer, Beat,Mia, Tempo, SX 146C1 (90-05)
<b>9978</b>	Drive Shaft Oil Seal Right	Fiat Palio I 1.2 ED, EL, Go!, Paint Ltd. M657BA.12T 178B5.000, 1.6 EL, ELX, HL, Weekend S/W, 178B3.000 (00-05), Palio II 1.2 Espresso 178B6.000, 1.2 Go!,178B5.000, 1.6 178B3.000, 1.7TD, EL. (05-10), Panda 1.2 Dynamic 169A4.000, 188A4.000 (2013-), 1.4 100HP 169A3.000 (2006-), Punto 1.2 Dynamic 188A5000 (04-13), Seicento 1.1 S, Sporting 176B2.000 (01-03), Siena I/II 1.2 EL, EL, Plus!, M657BA 12T, 1.6 EL, Plus!, ELX HL 178B3.000, 1.6 EL+, HL, ELX, 178B3000, 1.7TD EL 176A3.000 (00-10), Stilo 1.6 Active, MultiWagon, 182B6 (03-06), Strada 1.2 EL P/up, 1.4, 1.6 EL, EL Sporting, ELX P/up, 1.7D EL P/up (05-10), Uno 1.0 Cento 156A2, 1.1 Espresso P/van 160A3, 1.1 Fire, Rio, Mia, Tempo 160A3, 1.4 Pacer, Beat,Mia, Tempo, SX 146C1 (90-05)
<b>9979</b>	Rear Main Bearing Oil Seal	Citroen Berlingo 1.9D LWB P/van XUD9A Dies. (03-15), C4 2.0i VTS Coupe' EW10J4S (05-10), C5 2.0 SX, EW10J4S (01-05), Picasso 2.0HDI (03-06), Xsara 2.0 Picasso HDi, VTS, Exclusive, HDi Exclusive DW10/TD (03-08), Fiat Ulysse 2.0 MPV XU10 J2/Z (99-02), Ford Focus II 2.0 TDCi (05-09), Focus III 2.0 Tdci G6DA, BYD (09-15), Land Rover Freelander II 2.2 D, 2.2 TD4 (2007-), Peugeot 206 2.0 CC, GTi, 180 EW10J4, XT HDi DW10TD (01-08), 2.0 HDi (04-06), 306 2.0 Cabrio, XSi XU10J4R/ RS/, XU10J2/K (95-03), 307 2.0 CC, CC 100/ 130/ 180, XS, S/W EW10J4 XS HDi DW10TD (01-08), 308 2.0 HDi (2008-), 3008 2.0 HDi (2010-), 405 1.8 GR XU7JP/LZ, 2.0 SRi XU7J2/CL (95-97), 406 2.0 Coupe, Estate, SLi, ST, ST Comfort, Estate, STi, Si EW10J4R/ XU10J4R/ XU10J2TE (96-05), Partner 1.9D, 2.0 HDi (03-10), Volvo S40 2.0D VS Sedan D4204T (2004-), V50 2.0D B5244S (04-12)
<b>9980</b>	Rear Main Bearing Oil Seal	Citroen C5 3.0 (01-05), Peugeot Boxer 2.5TD (02-09)
<b>9981</b>	Front GearboxOil Seal	Citroen C3 1.4i (02-09), C4 1.6, HDi, 2.0, Berlingo 1.4, 1.9D (01-09), Peugeot 206 2.0 (00-06), 306 1.6, 2.0 (95-03), 307 1.6, 2.0 (01-08), 405, 406 1.6, 1.8, 2.0 (95-97)
<b>9982</b>	Rear Main Bearing Oil Seal	Peugeot Boxer 1.9D (06-09), Renault Clio I/II/III 1.6, 2.0 (2001-), Espace 2.0, Grand Espace 2.0, Laguna 1.8, 1.9dCi, 2.0 (02-04), Megane 2.0 (96-02), Megane II 1.9dCi, 2.0, T (2002-), Scenic I, II 1.9dCi, 2.0 (1998-)
<b>9983</b>	Rear Gearbox Oil Seal	Renault Grand Espace 3.0 (00-04), Laguna 3.0 (96-99)
<b>9984</b>	Front Wheel Oil Seal	Toyota Condor 2.4i Estate, TX Estate 2RZ-E, 3.0 Estate, TX Estate 5L - 4X4 (00-05)
<b>9985</b>	Rear Wheel Oil Seal	Toyota Condor 1.6 Estate, TE, 5L, 1.8 2Y, 2.0i Estate, TE, 1RZ Pet., 2.4i Estate, TE, TX 2RZ-E, 3.0D Estate, TE, 5L Dies. - 4X2, 2.4i Estate, TX Estate 2RZ-E, 3.0 Estate, TX Estate 5L - 4X4 (00-05)
<b>9986</b>	Front Wheel Oil Seal	Nissan Maxima GV Series 300SE VG30E (91-97), CA33 & QX Series 2.0 VQ20E, 3.0 VQ30DE (96-04), Primera 160 Si, SE SR16DE, 200 GSi, Si , STi, Elegance, Luxury SR20DE (98-02)
<b>9987</b>	Pinion Oil Seal	Mitsubishi Pajero 3.0 V6, 3.5 - 4X4 (91-01)
<b>9988</b>	Front Wheel Oil Seal	Tata Safari 2.2 CRDi GLX Dies. - 4X4 (2007-), Telcoline 2.0 Turbo Dies. S/Cab, D/cab P/up - 4X4 (04-10)
<b>9989</b>	Timing Cover Oil Seal	Toyota Land Cruiser 4.5, 4.7 (92-05)
<b>9990</b>	Rear Wheel Oil Seal Outer	Toyota Land Cruiser 4.2, 4.5 (96-98)
<b>9991</b>	Front Wheel Oil Seal Inner	Toyota Land Cruiser 4.5, 4.7 (98-05)
<b>9992</b>	Pinion Oil Seal	Toyota Dyna 2.2, 3.7, 4.0 (97-02)
<b>9993</b>	Rear Main Bearing Oil Seal	Toyota Land Cruiser 4.5, 4.7 (98-04)
<b>9994</b>	Cam Oil seal	Ford Courier 2.5 Turbo Diesel D/cab, Leisure P/up WL4 - 4X2, 4X4 (96-00), Ranger 2.5 Diesel, Turbo Diesel D/Cab, High Trail, XL, DT XLT High Trail D/Cab, Super Cab - 4X2 (00-09), 2.5 D/ Cab,High Trail, XL, DT XLT High Super Cab, 2.5TD Montana D/Cab WL4, 3.0TDCi, 4.0 Super Cab XLT - 4X4 (00-12), Mazda B-Series B2500 2.5 LWB Diesel, Turbo Diesel D/cab, Drifter, SLX P/up WL4 Dies., Turbo - 4X2, 2.5, Td LWB D/Cab, Drifter, SLX P/up WL4 Dies./Turbo Dies. - 4X4 (96-00), B2600i 2.6i LWB D/cab Drifter, SLX P/up 4G54 Pet. - 4X2, 2.6i V6 LWB Drifter, D/cab Drifter SLX P/up 4G54 Pet. - 4X4 (00-09), Drifter 2.5Td LWB Hi Ride, SL SLE,SLX D/cab, Hi Ride, Hi Trail D/cab P/up WL4 Dies./Turbo Dies. - 4X2, 4X4 (00-09), 2.6i LWB Hi Ride, SL Hi Ride S/cab, SLE, SLX D/cab SLX Hi Ride D/cab, SLX Hi Trail D/cab P/up Pet. - 4X2, 4X4 (00-09)
<b>9995</b>	Timing Cover Oil Seal	Ford Courier 2.5 Turbo Diesel D/cab, Leisure P/up WL4 - 4X2, 4X4 (96-00), Ranger 2.5 Diesel, Turbo Diesel D/Cab, High Trail, XL, DT XLT High Trail D/Cab, Super Cab - 4X2 (00-09), 2.5 D/ Cab,High Trail, XL, DT XLT High Super Cab, 2.5TD Montana D/Cab WL4, 3.0TDCi, 4.0 Super Cab XLT - 4X4 (00-12), Kia K2700i 2.7D Workhorse LWB Dies."Bakkie" D/S (2004-), Mazda B2500 2.5 LWB Diesel, Turbo Diesel D/cab, Drifter, SLX P/up WL4 Dies., Turbo - 4X2, 2.5, Td LWB D/Cab, Drifter, SLX P/up WL4 Dies./Turbo Dies. - 4X4 (96-00), Drifter 2.5Td LWB Hi Ride, SL SLE,SLX D/ cab, Hi Ride, Hi Trail D/cab P/up WL4 Dies./Turbo Dies. - 4X2, 4X4 (00-09)



## BUYERS GUIDE - OIL SEALS

<b>9996</b>	Rear Main Bearing Oil Seal	Ford Courier 2.5 Turbo Diesel D/cab, Leisure P/up WL4 - 4X2, 4X4 (96-00), Ranger 2.5 Diesel, Turbo Diesel D/Cab, High Trail, XL, DT XLT High Trail D/Cab, Super Cab - 4X2 (00-09), 2.5 D/Cab, High Trail, XL, DT XLT High Super Cab, 2.5TD Montana D/Cab WL4, 3.0TDCi, 4.0 Super Cab XLT - 4X4 (00-12), Kia Carnival 2.5 K55, KRV6, 2.9 CRDi J3 (00-04), Land Rover Freelander 2.5 V6 SUV KV6 Pet. (98-04), Mazda B-Series B2500 2.5 LWB Diesel, Turbo Diesel D/cab, Drifter, SLX P/up WL4 Dies., Turbo - 4X2, 2.5, Td LWB D/Cab, Drifter, SLX P/up WL4 Dies./Turbo Dies. - 4X4 (96-00), B2600i 2.6i LWB D/cab Drifter, SLX P/up 4G54 Pet. - 4X2, 2.6i V6 LWB Drifter, D/cab Drifter SLX P/up 4G54 Pet. - 4X4 (00-09), BT-50 2.6i SLE D/cab., S/cab., 3000 CRDi SLE D/cab., Freestyle SLX S/cab., D/cab - 4X2 (07-12), Drifter 2.5Td LWB Hi Ride, SL SLE, SLX D/cab, Hi Ride, Hi Trail D/cab P/up WL4 Dies./Turbo Dies. - 4X2, 4X4 (00-09), 2.6i LWB Hi Ride, SL Hi Ride S/cab, SLE, SLX D/cab SLX Hi Ride D/cab, SLX Hi Trail D/cab P/up Pet. - 4X2, 4X4 (00-09)
<b>9998</b>	Gearbox Oil Seal Front	Ford Focus I 1.6i 4/5 Door, Ambiente' Zetec S, 1.8 TDCi F9DA, F9DB, 2.0i 4/5 Door, L Trend, RS, ST170 Zetec E (00-05)
<b>9999</b>	Drive Shaft Oil Seal	Hyundai Bakkie, Van 2.5i, 2.6i, H100 2.5i, 2.6i (1997-)
<b>213207</b>	Use - 9716	
<b>223206</b>	Front Gearbox Oil Seal	Hyundai Atos 1.0, 1.1 (2000-)
<b>223507</b>	Front Gearbox Oil Seal	Audi A3 1.8 8L1 AGN, 1.8T AGU, BPU (98-04), 2.0 FSi BVZ, 2.0 FSi 8PA Sportback BLX, 2.0 TFSi CCZA, CBFA, 2.0 TDi BMM, CLJA, 3.2 Quattro, DSG, BUB (03-13), A4 1.8T Avant, Multitronic, BFB, B6 AVJ 8E2, 1.9 TDi AVF, Avant B6, 8E5, 8E2, 2.0 Multitronic Avant 8EC, 8E2 ALT, 2.0 TDi 125, 8EC BLB, Avant Multitronic, 2.0TFSi DTM 147 BGB, 3.2 FSi Quattro, 8EC Multitronic Avant, Tiptronic Avant, AUK (00-08), TT 1.8T Coupe, Sport, Roadster, Coupe 8N3/9 APX, 1.8T Quattro APX, BAM, BFV (00-07), TT 1.8T Coupe, Sport, Roadster, Coupe 8N3/9 APX, 1.8T Quattro APX, BAM, BFV (00-07), 2.0 TFSi BWA, 2.0 TTS Quattro CDLA, CDMA, 3.2 Coupe, Roadster DSG, BHE, BUB (06-10), 1.8 TFSi CDAA, 2.0 TFSi Quattro CCSA, CETA, 2.5 RS Quattro CEPA (10-15), Honda Ballade SA4 1300 EN4 (82-85), SC9 "Flip up Lights" 130 EV2, 150, i EW (84-89), Seat Altea 2.0FSi Tiptronic, 2.0TDi Man., DSG Auto. (06-09), Ibiza 1.4 Sport, BXW, 1.6 Sport, BAH, 1.8T Cupra, BBU, 1.9TDi 96, 118 Cupra, 2.0 AZL, BBX, BPX, BLK, ASZ, BLT (06-09), Beetle 2.0i Cabriolet, Highline AZJ (00-12), Caddy 1.6i Club, Citi, P/up HM Pet. (97-03), 1.9TDi Life, Maxi Van, MPV BJB, 2.0SDi Van, P/van BDJ, 2.0TDi (2004-), Citi Golf 1.3 L ET/GY (83-09), Golf I 1.1 GL, L, LS ET/EG, 1.3 GL, L, LS GF (78-84), Golf IV 1.8, T GTi, Highline AGU/ AGN, 1.9 TDi Highline, Estate AHF, 2.0i Cabrio, Highline APK (99-04), Golf V 1.6i Comfortline, Tiptronic, Trendline BGU, 1.9TDi Comfortline, Highline, 2.0i Comfortline, GTi, GTi Trendline DSG/ AXX/BWA, 2.0FSi Sport, Sport Tiptronic AXW, 2.0TDi, Sport DSG/ BKD (04-09), Golf VI 1.4TSi Comfortline, Trendline, Highline, 1.6i Comfortline, Trendline, 1.6TDi, 2.0i GTi, Tiptronic, 2.0TSi 4Motion, 2.0TDi Highline, DSG (09-13), Jetta I 1.3 GL, GX ET/ GF (80-85), Jetta IV 1.6i Comfortline, Std. AKL, 1.8T Highline, Exec AGU, 1.9 TDi Highline AHF, 2.0i Highline APK, 2.3 V5 AGZ (99-06), Jetta V 1.4TSi, 1.6TDi (09-11), 1.6i Comfortline, Tiptronic, Trendline, 1.9TDi Comfortline, Comfortline DSG, 2.0i Trendline, Comfortline, 2.0FSi Sportline, 2.0 T FSi Sportline DSG, 2.0TDi Sportline (2006-), Kombi T4 2.5Tdi Microbus, Caravelle, Trend, High ACV, AAB Dies., Turbo Dies. (99-06), T5 1.9TDi Beach, Van, P/van, S/Cab P/up SWB, D/Cab P/up LWB, Crew Bus AXC Dies., 2.5TDi Beach, California, Caravelle, 96/128, S/Cab, D/cab, HO P/up SWB/ LWB P/up, Crew Bus P/van, Van, AXD Dies., 3.2 Caravelle, S/Cab, D/cab P/up BDL (04-10),
<b>223507... Continued</b>	Front Gearbox Oil Seal	Polo 9N 1.4TDi, Classic, Trendline AMF, 1.4TDi Classic, Trendline ARC, 1.4i Trendline, Comfortline, AUA/ BBY, BLM, 1.6i Comfortline, SE, Classic Comfortline, Tipt Trendline, Classic Lux BTS/ AFV, BAH, 1.8T GTi, Classic Trendline AKK (02-10), 1.9TDi Highline, Classic Highline, Sportline, ATD/ AXR, 2.0i Highline, Classic Highline BBX, Cross Polo 1.6TDi, 1.9TDi (07-10), Scirocco 1.4TSi, 2.0TSi, DSG, 2.0TSi R (2009-), Sharan 1.8T MPV AJH, 1.9TDi MPV ASZ, 2.8 MPV AAA (99-08), Tiguan 1.4TSi Trend&Fun 5Dr. SUV, 2.0TSi, 2.0TDi - 4X2, 1.4TSi Track&Field, Trend&Fun 5Dr. SUV, 2.0TSi Track&Field, Sport&Style Man., Tiptronic 5Dr. SUV, 2.0TDi Track&Field, Sport&Style Man., Tiptronic 5Dr. SUV - 4X4 (08-17), Touran 1.9TDi TrendLine DSG MPV, 2.0FSi HighLine MPV AXW, 2.0TDi HighLine, DSG MPV (04-11)
<b>224006</b>	Front / Rear Gearbox Oil Seal	Alfa Romeo 145 2.0 (96-01), 146 2.0 (96-99), 147 1.6, 2.0 (01-07), 155 2.0 (96-98), GTV 2.0 (96-99), Spider 2.0 (96-06), Fiat 128 1.1, 1.3 (71-84), Multipla 1.9 (03-08), Palio/Siena I/II 1.2, 1.6, 1.7D (2000-), Stilo 1.6, 1.9 (2003-), Uno 1.4 (90-98), 128 1.1, 1.3 (73-84), Doblo 1.9 (03-05)
<b>224008</b>	Front Gearbox Oil Seal	Ford Escort FWD MkVI 1.4i H/back, Sedan CVH-PTE, 1.6i GL, GLE H/back, Sedan Zetec, 1.8i GLi, TDi H/back, Sedan Zetec, 1.8TDi Endura (95-00), VW Caddy 1.6 SWB, Caddy Club P/up JK Dies., HM Pet., 1.8 SWB L, Sport P/up HV Pet. (81-87), Caddy 1.6i Club, Citi, P/up HM Pet. (97-03), Citi Golf 1.3 L ET/GY, 1.6 Blues, Chico, Chico Lux, Deco, Designa, L, Ritz, Shuttle, Sonic, Sport HM, HV, FR, 1.6iL, Life, VeloCiti, TenaCiti, CitiStorm, - Sport, - Rox, Rhythm, MKI AFX, 1.8 CTi, Designa, L Sport BZF (83-09), 1.3 L Shuttle, Chico, Chico Lux ET/ GY/ AJD (87-03), 1.4, iL, Chico, Rhythm, Citi com, VeloCiti, TenaCiti, CitiStorm, - Sport, Rox, Rhythm, Wolf, - XCite, Billabong AGY/ BSV (99-09), Fox 1.3 L, L Trippa GY, 1.6 L HM, 1.8 L Sport HV (87-96), Golf II 1.3 CL GY, 1.6 CSL HM, 1.8 8/16V CSX, GTS, GTi KR, EV, 2.0 8/16V GTi AAL (84-92), Golf III 1.6 GS ACG, 1.8 GSX, GTS ACH, 2.0 GTi, Exec. 2E (92-99), Jetta I 1.3 GL, GX ET/ GF, 1.5 GLS/ GLX JB, 1.6 GLS EM, 1.8 GLi DX (80-85), Jetta II 1.6 CSL HM, 1.8 8/16V CLi, CLi Exec., CLX, CSi, CSX EV/KR, 2.0 8/16V CLi, Exec. AAL (85-92), Jetta III 1.6 CSL ACG, 1.8 CLX/ CSX ACH, 2.0 CLi, Exec. 2E, 2.8 VR6 Exec. AAA (92-99)
<b>224016</b>	Front Gearbox Oil Seal	VW Kombi T2 2.0, L Exec., Microbus, Kamper, P/up, P/van CU, CJ Pet., T3 1.9 Microbus, P/van DG Pet. (75-89), T3 1.8 P/van, GUS, Volksiebus AAX Pet. (89-99), T3 2.1 Fi Caravelle, Microbus DJ Pet., 2.3i Microbus, Volksiebus AFU Pet., 2.5i Microbus, Caravelle AAY Pet., 2.6i Microbus, Caravelle, Exclusive, ADV Pet. - 4X2 (85-04), T3 2.1 Fi Syncro Caravelle DJ Pet. - 4X4 (89-93)

## BUYERS GUIDE - OIL SEALS

<b>224507</b>	Cam Oil Seal	Renault Grand Scenic 1.9dCi, 2.0 (2005-), Laguna 1.8, 2.0 (96-00), Megane 1.6, 2.0 (96-02), Megane II 1.5dCi, 1.6, 1.9dCi, 2.0 (2003-), Scenic 2.0 (98-00), Scenic II 1.6, 1.9dCi, 2.0 (2003-)
<b>233506</b>	Timing Cover, Pinion Oil Seal	Fiat Palio I 1.2 ED, EL, Go!, Paint Ltd. M657BA.12T 178B5.000 (00-05), Palio II 1.2 Espresso 178B6.000, 1.2 Go!, 178B5.000 (05-10), Panda 1.1 Active, 187A1.000, 1.2 Dynamic 169A4.000, 188A4.000 (2006-), Seicento 1.1 S, Sporting 176B2.000 (01-03), Siena I/II 1.2 EL, EL, Plus!, M657BA 12T, 1.6 EL, Plus!, ELX HL 178B3.000, 1.6 EL+, HL, ELX, 178B3000, 1.7TD EL 176A3.000 (00-10), Strada 1.2 EL P/up (05-10), Uno 1.0 Cento 156A2, 1.1 Espresso P/van 160A3, 1.1 Fire, Rio, Mia, Tempo 160A3 (90-05), VW Caddy 1.6 SWB, Caddy Club P/up JK Dies., HM Pet., 1.8 SWB L, Sport P/up HV Pet. (81-97), 1.6i Club, Citi, P/up HM Pet. (97-03), Citi Golf 1.3 L ET/GY, 1.6 Blues, Chico, Chico Lux, Deco, Designa, L, Ritz, Shuttle, Sonic, Sport HM, HV, FR, 1.6iL, Life, VeloCiti, TenaCiti, CitiStorm, - Sport, - Rox, Rhythm, MKI AFX, 1.8 CTi, Designa, L Sport BZF (83-09), 1.3 L Shuttle, Chico, Chico Lux ET/ GY/ AJD (87-03), 1.4, iL, Chico, Rhythm, Citi com, VeloCiti, TenaCiti, CitiStorm, - Sport, Rox, Rhythm, Wolf, - XCite, Billabong AGY/ BSV (99-09), Fox 1.3 L, L Trippa GY, 1.6 L HM, 1.8 L Sport HV (87-96), Golf I 1.1 GL, L, LS ET/EG, 1.3 GL, L, LS GF, 1.5 GL Diesel, GLS, LS CK/ EM/ JB, 1.6 GL Diesel, GT, GTS, GTX JK/ CR FR, 1.8 GTi EV (78-84), Golf II 1.3 CL GY, 1.6 CSL HM, 1.8 8/16V CSX, GTS, GTi KR, EV, 2.0 8/16V GTi AAL (84-92), Golf III 1.6 GS ACG, 1.8 GSX, GTS ACH, 2.0 GTi, Exec. 2E, 2.8 VR6, Exec. AAA (92-99), Jetta I 1.3 GL, GX ET/ GF, 1.5 GLS/ GLX JB, 1.6 GLS EM, 1.8 GLi DX (80-85), Jetta II 1.6 CSL HM, 1.8 8/16V CLi, CLi Exec., CLX, CSi, CSX EV/KR, 2.0 8/16V CLi, Exec. AAL (85-92)
<b>243806</b>	Front Gearbox Oil Seal	Audi A3 1.8 8L1 AGN, 1.8T AGU, BPU (98-04), 2.0 FSi BVZ, 2.0 FSi 8PA Sportback BLX, 2.0 TFSi CCZA, CBFA, 2.0 TDi BMM, CLJA, 3.2 Quattro, DSG, BUB (03-13), A4 2.0 TDi 125, 8EC BLB, Avant Multitronic, 2.0TFSi DTM 147 BGB, 3.2 FSi Quattro, 8EC Multitronic Avant, Tiptronic Avant, AUK (00-08), TT 2.0 TFSi BWA, 2.0 TTS Quattro CDLA, CDMA, 3.2 Coupe, Roadster DSG, BHE, BUB (06-10), 1.8 TFSi CDAA, 2.0 TFSi Quattro CCSA, CETA, 2.5 RS Quattro CEPA (10-15), Seat Ibiza 1.4 Sport, BXW, 1.6 Sport, BAH, 1.8T Cupra, BBU, 1.9TDi 96, 118 Cupra, 2.0 AZL, BBX, BPX, BLK, ASZ, BLT (06-09), VW Beetle 1.8T Coupe APH (00-12), Caddy 1.6i Life Van, MPV BGU (2004-), Golf V 1.6i Comfortline, Tiptronic, Trendline BGU, 1.9TDi Comfortline, Highline, 2.0i Comfortline, GTi, GTi Trendline DSG/ AXX/BWA, 2.0FSi Sport, Sport Tiptronic AXW, 2.0TDi, Sport DSG/ BKD (04-09), Golf VI 1.4TSi Comfortline, Trendline, Highline, 1.6i Comfortline, Trendline, 1.6TDi, 2.0i GTi, Tiptronic, 2.0TSi 4Motion, 2.0TDi Highline, DSG (09-13), Jetta V 1.4TSi, 1.6TDi (09-11), 1.6i Comfortline, Tiptronic, Trendline, 1.9TDi Comfortline, Comfortline DSG, 2.0i Trendline, Comfortline, 2.0FSi Sportline, 2.0 T FSi Sportline DSG, 2.0TDi Sportline (2006-), Polo 9N 1.4TDi, Classic, Trendline AMF, 1.4TDi Classic, Trendline ARC, 1.4i Trendline, Comfortline, AUA/ BBY, BLM, 1.6i Comfortline, SE, Classic Comfortline, Tipt Trendline, Classic Lux BTS/ AFV, BAH, 1.8T GTi, Classic Trendline AKK (02-10), 1.9TDi Highline, Classic Highline, Sportline, ATD/ AXR, 2.0i Highline, Classic Highline BBX, Cross Polo 1.6TDi, 1.9TDi (07-10), Scirocco 1.4TSi, 2.0TSi, DSG, 2.0TSi R (2009-), Tiguan 1.4TSi Trend&Fun 5Dr. SUV, 2.0TSi, 2.0TDi - 4X2, 1.4TSi Track&Field, Trend&Fun 5Dr. SUV, 2.0TSi Track&Field, Sport&Style Man., Tiptronic 5Dr. SUV, 2.0TDi Track&Field, Sport&Style Man., Tiptronic 5Dr. SUV - 4X4 (08-17), Touran 1.9TDi TrendLine DSG MPV, 2.0FSi HighLine MPV AXW, 2.0TDi HighLine, DSG MPV (04-11)
<b>244008</b>	Front Gearbox Oil Seal	Ford Laser 1.3 L, GL, 13, Dash E3 / B3, 1.6, i GL, 16, Sport, TX3 B6/ F6, 2.0, i RS FE (86-95), 1.4 L CHV-FUA, 1.5 GL, GLS, Sport E5/B5 (86-92), Meteor 1.3 GL, L, 13 E3/B3, 1.4 LX CVH, 1.5 GL, GLS E5, 1.6, i GL, GLE, GLi, 16, Sport B6/CVH/F6, 2.0 8/16V GLE, GLi FE (86-95), Tracer 1.3 Sedan, H/back -Tonic, Plus B3, 1.6 Sedan, H/back - Plus, Sport, Tonic B6/F6 (95-02), Kia Pride 1.3i LX 5 Dr. H/back, Rio I 1.3 5 Dr. H/back A3E, 1.5 5 Dr. H/back A5D (98-04), Sephia 1.5i LS, RS 4 Dr. Sedan BFD (04-05), Mazda 323 FWD 1.3 S, H/back, Sedan E3, 1.5 GLC, SL, SLX, Sport H/back, Sedan E5 (81-88), 1.3 L, H/back, Sedan E/B3, 1.5, L H/back, Sedan E5, 1.6 EGi Hatch, L, Sedan, SL Hatch, SL Sedan, Sport Hatch B6i/F6 (84-91), 2.0 EGi Hatch, SLE Hatch, SLi Sedan, 200e Hatch, Sedan, 200i Hatch 8/16V FE-2000 (89-95), 130 Hatch, Midge, Sedan, Sting B3, 160, i, S Hatch, Midge, Sedan, Sting F6 (90-95), 130 Hatch, Midge, Sedan, Sting B3, 160, i, S Hatch, Midge, Sedan, Sting F6, 200i, e Hatch 8/16V FE 2000 (95-05), Nissan B140 1.4 A14SP/van, S/W, Deluxe, Std. Sport, CHAMP P/up (80-08), VW Golf I 1.1 GL, L, LS ET/EG, 1.3 GL, L, LS GF, 1.5 GL Diesel, GLS, LS CK/ EM/ JB, 1.6 GL Diesel, GT, GTS, GTX JK/ CR FR, 1.8 GTi EV (78-84), Golf IV 1.6i Comfortline, Std., Estate AKL (99-04), Jetta IV 1.6i Comfortline, Std., Estate AKL (99-06)
<b>253506</b>	Front Gearbox Oil Seal	Daihatsu Charade 0.8 CX, CXL G11 CB22, Turbo G21 CB60 (83-85), Hyundai Accent LC 1.3 G4EH, 1.5 G4EK, 1.6 G4ED (00-06), Elantra HD 1.6 GLS, 2.0 GLS, G4GC (07-11), Sonata Y3 2.0 G4CP, 2.5 V6 G6BV, 3.0 V6 G6AT (94-04)
<b>253507</b>	Front Gearbox Oil Seal	Opel Kadett 1.1 (66-74)
<b>253707</b>	Front Gearbox Oil Seal	Alfa Romeo Berlina 1750, 2000, Gt 1.6 (68-77), Gtv 1750, 2000 (68-77)
<b>253708</b>	Front Gearbox Oil Seal	Toyota Conquest/ Tazz EE80 1.3 GL, GS, L, S 2EL, EE90R 130 Sport, Tazz, Edition, Zipp, Tropique, Tazz EE90R 130 Edition, Ruby, Tropique, Sport, McTazz, XE 2E, AE82R 1.6 GL, RS, RSi 4A-L, A-GEL, AE92R 160i LS, RS, RSi, Sport, RSE, Tazz 4A-F, A-FE, A-GE, AE92R 160i Edition, Sport, Tazz, XE 4AFE (85-06), Conquest AE93 180i RS, RSi, Sport 7A-FE (93-96), EE90 130 Carri P/van, 2E (98-06), Corolla FWD AE82R 1.6 GL, GLE, GLi, GLS, GLX, Avante, GLE, GLi, S/W 4A-L, A-GEL (84-88), AE92R 1.6, 160 GL, GLE, GLi, Exec., GLS, Exec., GLX, Sport Sprinter 4A-F, A-FE, A-GE (88-96), AE93R 180i GL, GLE, GSE, GSX, Sprinter 7A-FE (93-96), AE111R 160i GL, GLE, RSi, RXi 4A-FE, A-GE, AE112 180i GLE, GSE 7A-FE (96-02), F11 140i GLE, GLS, Sprinter 4ZZ-FE, KS1 160i GLE, GLS, GSX, Sprinter VVT-i 3ZZ-FE DOHC, GF2 180i GLE, GLS, GSX, Sprinter VVT-i 1ZZ-FE DOHC (02-08), Corolla Verso ZZE122 160i S, SX MPV, 180i SX, SX MMT, TX, TX MMT MPV 1ZZ-FE (04-09), Runx 140i RT, RS, Sport 4ZZ-FE, 160i RS, RT, RX, Sport 3ZZ-FE, 180i RSi, RX 1ZZ-FE (03-08)

# BUYERS GUIDE - OIL SEALS

<b>253807</b>	Gearbox Oil Seal, Timing Cover / Cam Oil Seal	Toyota Avanza 1.3i P/Van, S, SX MPV K3VE, 1.5i SX, TX MPV 3SZVE (06-12), Toyota Corolla RWD TE31 1.6 Sprinter, SR4/5, Black Hawk, Silver Wolf 2T, AE/TE71 1.6 GL, S/W, GLS Sprinter, SE 2T, TB, TE72 1.8 GLS, SE 3T (80-88), Corolla TE71 1.6 P/van 2T (83-89), KE70 1.3 P/van 4K (84-88), Corolla FWD AE/EE80R 1.3 GL, L, 2A-L, E-L, EE90R 1.3 GL, GLE, L, Sprinter 2E-L, E EE110R, 130 GLE, Sprinter 2E (84-02), Tuv KF20 1.3 Chassis Cab, P/up, P/van, Bus 4K Pet., 1.5 P/up 5K Pet. (82-87), Yaris 1.0 T1, 1.3 T3, +, Spirit, T3 Spirit - Saloon & Hatch 2NZ-FE (05-10)
<b>254007</b>	Cam, Gearbox Oil Seal	Various Makes, Models
<b>254008</b>	Use - 9757	
<b>254207</b>	Cam Oil Seal	Nissan Interstar 2.5DCi SR, HR P/Van (2006-), Livina 1.6 Acenta, +, Visia, X-Gear (07-15), Grand Livina 1.6 Acenta, + HR16DE (08-14), Primastar 1.9 DCi Minibus (07-11), Tiida 1.6 Acenta, Visia, +, 1.8 Acenta (06-13), X-Trail 2.0 CVT 6 Speed MR20DD - 4X2 (2014-), Opel Vivaro 1.9CDTi P/Van (06-15), Laguna I 1.8 RN, RN Estate, Authentique, Expression F4P7 RT B568/-9F3P/-P6, 1.9dCi F9Q716, 2.0 RT, RT Estate, RXE, Expression K4M720/724, N7Q700 (96-07), 3.0 Privilege, RXT L7X731 L7X700 (96-02), Megane I 2.0 Coupe 8/16V F3R710/50, RXE, RSi Coupe, Cabriolet F3R796/-7/-8 (96-02), Megane II 1.5dCi Authentique, Shake it! K9K722, 1.6 Classic Privilege, Expression, Dynamique, Authentique, Shake it! CC Dynamique K4M701, K4M760/-1, 1.9dCi CC, Dynamique, Privilege, Dynamic + F9Q800 (02-10), Scenic 2.0 RXE, Rxi (98-02), Scenic II 1.9dCi Dynamic, Privilege MPV F9Q740, 1.9dCi Dynamique, Expression, Navigator MPV F9Q812 (02-10), Scenic III 1.9dCi (11-13), Trafic 1.9dCi 100 P/Van F9Q760 (05-07)
<b>264208</b>	Gearbox Oil Seal	Honda Ballade SO4 150i Encore, Luxline, Spreeline D15Z4, 160i Luxline, Spreeline, V-Tec D16Y9, D16Z, 180i Luxline B18B4 (96-00)
<b>274206</b>	Rear Gearbox Oil Seal	Ford Focus 1.6, 2.0 (00-05), Mondeo 1.8 Tdi, 1.8i, 2.0, 2.0i, 2.5i (97-01)
<b>274207</b>	Front Gearbox Oil Seal	Honda Ballade SC9 160i (Flip up light) (84-89)
<b>274307</b>	Front Gearbox Oil Seal	Mazda BT-50 2.5TDi (2007-)
<b>274308</b>	Front Gearbox Oil Seal	Ford Bantam 130 Explorer P/up B3, 160, i Explorer, Leisure, Sport, P/up B6/ F6 (94-03), Courier 1.6 P/up F6, 1.8 Chassis cab, Explorer, Std., XLT P/up F8., 2.0 XLT FE., 2.2 D/cab, Explorer, Leisure, Std., XLT P (86-00), 3.0 V6 D/cab, Explorer, L, Leisure, Std., P/up Essex (86-97), 2.5 Turbo Diesel D/cab, Leisure P/up WL4, 3.4 V6 Leisure D/cab, P/up Essex - 4X2, 4X4 (96-00), 3.0 V6 Std., XLT, D/cab, Leisure, Explorer, Exec. P/up Essex. 3.4 V6 Leisure, P/up Essex. - 4X4 (96-00), Ranger 1.8 XL, P/up, 2.2 XL, P/up - 4X2, 4X4 (00-05), 2.5 Diesel, Turbo Diesel D/Cab, High Trail, XL, DT XLT High Trail D/Cab, Super Cab - 4X2 (00-09), 2.5 D/Cab, High Trail, XL, DT XLT High Super Cab, 2.5TD Montana D/Cab WL4, 3.0TDCi, 4.0 Super Cab XLT - 4X4 (00-12), Spectron 2.2 Bus, P/van F2 (91-04), Mazda 626 1.6 S Sedan, Hatch F6, 1.8 L Sedan, Hatch F8, 2.0 SL, SLE, SLX, 2.0i EG, SLi FE (Rear Drum brakes), 2.0i 16V SLi FE (Rear Disc brakes) (83-93), 2.0 S/W, Sedan FE (98-03), Astina 180 Se Hatch Bpi (95-00), B-Series Magnum P/up F6 Pet., B1800 1.8 SWB/LWB Magnum, Drifter P/up F8 Pet. (86-00), B2000 2.0 SWB P/up MA Pet., B2200 2.2 SWB/LWB P/up S2 Dies. (82-86), B2600 2.6 LWB D/cab, Magnum, Drifter P/up 4G54 Pet. - 4X2, 4X4(86-95), B2600i 2.6i LWB D/cab Drifter, SLX P/up 4G54 Pet. - 4X2, 4X4 (97-01), B3000 3.0 V6 LWB D/cab, Magnum Drifter P/up Essex Pet. - 4X2, 4X4 (86-97), B2000 2.0 LWB Drifter, Magnum P/up FE Pet., B2200 2.2 LWB D/cab, Drifter, Magnum P/up R2 Dies., 2.2 LWB D/cab, Drifter, Magnum P/up F2 Pet. (86-00), B2500 2.5, Td LWB D/cab, Drifter, SLX P/up WL4 Dies./Turbo Dies. - 4X2, 4X4 (96-99), B3400 3.4 V6 LWB Magnum D/cab P/up Essex - 4X4 (96-01), Drifter 1.8 SWB/LWB XL P/up Pet., 2.2 SWB/LWB XL P/up Pet., 2.5Td LWB Hi Ride, SL SLE, SLX D/cab, Hi Ride, Hi Trail D/cab P/up WL4 Dies./Turbo Dies. - 4X2 (00-09), 2.5Td LWB D/cab, DL, SL, SLE, SLX S/cab, D/cab P/up WL4 Dies./Turbo Dies. - 4X4 (02-09), 2.6i LWB Hi Ride, SL Hi Ride S/cab, SLE, SLX D/cab SLX Hi Ride D/cab, SLX Hi Trail D/cab P/up Pet. - 4X2 (00-09), 2.6i V6 LWB SL S/cab, SLE, SLX D/cab P/up 4G54 Pet. - 4X4 (02-09), Etude 160, e, i, iE, iSE Sport, 180, e, SE (95-00), Etude 160 iE, iSE, Sport, 180 iSE, iSX, Sport (99-04), Marathon 2.2 LWB Bus, P/van F2 Pet. (91-04), Nissan Maxima CA33 & QX 2.0 VQ20E, 3.0 VQ30DE (96-04)
<b>274309</b>	Use - 9857	
<b>274707</b>	Timing Cover / Cam Oil Seal	Citroen C4 1.6 HDi (01-09), Xsara 2.0 (01-06), Ford Fiesta 1.6TDCi (2008-), Focus II 2.0TDCi (2005-), Peugeot 307 2.0 (01-08), 308 1.6HDi (2008-), Boxer 2.2HDi (06-09), Volvo S40 2.0D, V50 2.0D (04-09)
<b>284007</b>	Pinion Oil Seal	Audi 100 1.8, 1.9 (70-77), BMW 735i, 750i (87-94), Honda Civic 150, 160 (96-00)
<b>284008</b>	Front Gearbox Oil Seal	Mazda 2 (DE) 1.3, 1.5 (2007-)
<b>284205</b>	Cam oil seal	Nissan Micra (K12/13) 1.5 dCi Tekna, Acenta HR15DE (2004-), Micra (K14) 0.9 K9K (2018-), NP200 1.5DCi S, SE P/up, 1.6, S, SE P/up (2008-), NV200 1.5 Dci, 1.6 HR16DE (2013-), Qashqai 1.5DCi, 1.5DCi K9K282, K9K292, 1.5DCi K9K636, K9K646 (2007-), Renault Clio I, II 1.2 Authentique, Expression, Generation, Va Va Voom D4F706, 1.5 DCi Expression., K9K700/-702 (99-10), Duster 1.5 DCi K9K, 1.6 K4M - 4X2, 4X4 (2013-), Kangoo 1.5dCi Express van K9K700 (01-10), Laguna I 1.6 RT, RTE K4M720 (96-07), Logan 1.6 Expression (2009-), Megane II 1.4 Authentique, Dynamique E7J626/-50 (02-10), Modus 1.2 Authentique D4F706, 1.4 Dynamique, Expressio K4J770 (05-08), Scenic II 1.4 Authentique K4J750 (01-04), 1.6 Authentique, Expression, Joie de Vivre K4M761/78 (02-10), Twingo 1.6 RS K4M854 (08-13)
<b>284207</b>	Front Gearbox Oil Seal	Audi A3 1.8, 1.8T, 2.0 FSi, TDi, T FSi, 3.2 (1998-), A3 1.4 T FSi (13-17), A4 1.8T, 1.9TDi, 2.0, TDi, T FSi, 3.2, FSi (2000-), S3 2.0TFSi (07-13), TT 1.8T, 2.0T FSi, 3.2 (00-06), Seat Altea 2.0FSi, TDi (06-08), Ibiza 1.4, 1.6, 1.8T, 1.9TDi, 2.0, Leon 2.0FSi, T, T FSi, TDi (06-08), VW Golf V 1.6i, 1.9TDi, 2.0, FSi, TDi (04-09), Jetta V 1.6i, 1.9TDi, 2.0, FSi, T FSi, TDi (2006-), Touran 1.9TDi, 2.0FSi, TDi (2004-)



# BUYERS GUIDE - OIL SEALS

<b>285610</b>	Use - 9307	
<b>287010</b>	Rear Gearbox Oil Seal	Renault Clio II/III 2.0 (2001-), Espace 2.0, Grand Espace 2.0 (02-04), Laguna 1.9dCi (03-07), Megane 2.0 (97-02), Megane II 1.9dCi, 2.0, Scenic 1.9dCi, 2.0 (2002-)
<b>304007</b>	Gearbox Oil Seal	Renault Espace 2.0 Authentique Expression, RXE, RXT MPV J7R, F4R, 3.0 L7X727, 3.0 Previl (96-08), Laguna I 1.9dCi F9Q716, 2.0 RT, RT Estate, RXE, Expression K4M720/724, N7Q700 (96-07), Megane I 2.0 Coupe 8/16V F3R710/50, RXE, RSi Coupe, Cabriolet F3R796/ -7/8 (96-02), Megane II 1.9dCi CC, Dynamique, Privilege, Dynamic + F9Q800, 2.0 Classic Dynamique, Dynamique + , Privilege, CC Privilege, GT F7R710 /-77, 2.0T Sport, F1 Team R26 LE, SE, Coupe Dynamique (02-10), Scenic II 1.6 Authentique, Expression, Joie de Vivre K4M761/782, 1.9dCi Dynamique, Expression, Navigator MPV F9Q812, 2.0 Dynamique, Privilege, Navigator MPV F4R770/771 (02-10)
<b>304207</b>	Pinion Oil Seal, Timing Cover / Cam Oil Seal	Alfa Romeo 145 2.0 Quadrofoglio AR32301 (96-01), 146 2.0 Ti Twin Spark AR67204 (96-99), 147 1.6 Progression, TS AR32104, 1.9 JTD, 2.0 Destinctive, Selespeed TS AR3231 (01-10), 155 2.0 2.0 TS AR32301 (96-99), 156 2.0 Twin Spark Selespeed Sportswagon AR32301 (98-07), GTV / Spider 2.0 (96-06), Chevrolet Aveo 1.5 L, LS, LT (03-15), Daihatsu Charade 1.0 (03-11), Cuore 847cc ED10 (97-03), Fiat Doblo 1.9 Cargo P/van 223A6.000, Multipla 1.9 JTD ELX MPV 182A4.000 (03-06), Palio I 1.2 ED, EL, Go!, Paint Ltd. M657BA.12T 178B5.000, 1.6 EL, ELX, HL, Weekend S/W, 178B3.000 (00-05), Palio II 1.2 Espresso 178B6.000, 1.2 Go!, 178B5.000, 1.6 178B3.000, 1.7TD, EL. (05-10), Panda 1.1 Active, 187A1.000, 1.2 Dynamic 169A4.000, 188A4.000 (2006-), Punto 1.8 HGT 188A1.000, 188A6.000 (04-13), Seicento 1.1 S, Sporting 176B2.000 (01-03), Siena I/II 1.2 EL, EL, Plus!, M657BA 12T, 1.6 EL, Plus!, ELX HL 178B3.000, 1.6 EL+, HL, ELX, 178B3000, 1.7TD EL 176A3.000 (00-10), Stilo 1.6 Active, MultiWagon, 182B6 (03-06), Strada 1.2 EL P/up, 1.6 EL, EL Sporting, ELX P/up (05-10), Uno 1.0 Cento 156A2, 1.1 Espresso P/van 160A3, 1.1 Fire, Rio, Mia, Tempo 160A3 (90-05), Mitsubishi Pajero 3500 - 4X4 (02-07), Renault Clio I, II 1.4 Alaise, Privilege, Expression, RT, Va Va Voom K4J7/EJ634, 1.6 Expression, Dynamique, Privilege, Sport K4M744/ -745/-748, 2.0 Sport F4R (99-10), Clio III 1.6 Expression, Dynamique, Extreme K4M 748, 2.0 Sport, R27, Ltd. Edition F4R832/830 (06-10), Kangoo 1.4 Express van E7J780 (01-10), 1.4 Multix Authentique MPV E7J780 (03-10), 1.6 (11-13), Megane I 1.6 Classic RXE, RT, RXT, RSi Coupe, RN Hatch, RT Coupe, Hatch, RXE, RXI Cabriolet K7M700/ 02/-03 (96-02), Megane II 1.6 Classic Privilege, Expression, Dynamique, Authentique, Shake it! CC Dynamique K4M701, K4M760/ -1 (02-10), Modus 1.6 Expression K4M761-11 (05-08), Sandero 1.4 Authentique, 1.6 Cup, Dynamique, Expression, Pack (09-15), Scenic 1.4 RTE, 1.6 RT, RXE (98-02), Toyota Auris 1.3, 1.4i RS, RT, 1.6i RS, RT, 1.8i RS, RX, 2.0Di D-4D RS, RX (2007-), Avensis 2.0i Advanced, 2.2 D4D Exclusive, 2.4i Exclusive (06-09), Camry I SXV10/11 R 200i Si 3S-FE, 220 SEi, Si, 5S-FE (92-01), MCV10/ VCV10 300SEi 1MZ-FE/3VZ-FE, Quad Cam (94-01), Corolla FWD 1.3i Impact, Professional, Advanced, 1.4i, 1.6i Professional, Advanced, 1.8i (2007-), Corolla FWD 2.0, 2.0D D-4D Advanced, Exclusive (07-14), Rav4 III 2.0i 1AZ-FE GX, VX, Fierce SUV, 2.2i D-4D 2AD-FTV GX, VX SUV - 4X4 (06-13), VW Kombi T3 1.8 P/van, GUS, Volksiebus AAX Pet. (89-99), T3 2.1 Fi Caravelle, Microbus DJ Pet., 2.3i Microbus, Volksiebus AFU Pet., 2.5i Microbus, Caravelle AAY Pet., 2.6i Microbus, Caravelle, Exclusive, ADV Pet. - 4X2 (85-04), T3 2.1 Fi Syncro Caravelle DJ Pet. - 4X4 (89-93)
<b>304208</b>	Timing Cover / Cam Oil Seal	Chevrolet Aveo 1.6 LS (03-15), Opra 1.6 Ls F16D3 (04-11), Daewoo Lanos I 1.35i S, 1.6 SX, Lanos II 1.4 S, 1.6 SX (97-03), Nubira I 1.6 SX, 2.0 CDX, Nubira II 1.6 SX, SX S/W, 2.0 CDX, Exec., S/W (97-03), Tacuma 1.6 SX, 2.0 CDX, CDX Plus (01-03), Hyundai Santa Fe' 2.4 SUV G4JS, 2.7 V6 SUV G6BA-G - 4X4 (01-05), Kia Sportage JE 2.7 V6 SUV G6BA - 4X2, 4X4 (04-10), Renault R5 1.3, GTL, LS, LSS, TS 810-25, 1.4 TS 847-C2J (75-85), 1.3 Panel Van 810-25 (80-85)
<b>304506</b>	Front Gearbox Oil Seal, Timing Cover / Cam Oil Seal	Ford Husky 1.8 1 Ton P/up 4G62, 2.0 1 Ton P/up, Bus, P/van 4G63 (85-99), Isuzu WFR 1.8 11FVX/ 12FVX Bus, P/van 4ZB1 (83-89), Mitsubishi Colt LDV 2.8TDi LWB Pioneer, Rodeo D/cab P/up Turbo Dies., 3.0i V6 LWB Rodeo D/cab P/up Pet. - 4X2, 2.8D, TDi LWB Club cab, Trailbuster S/cab, Rodeo /cab P/up Dies./ Turbo Dies., 3.0i V6 LWB Rodeo D/cab P/up Pet. - 4X4 (99-09)
<b>304507</b>	Front Gearbox Oil Seal	Mitsubishi Colt LDV 2.0, 2.0i, 2.4i, 2.5, 2.8D - 4X2, 2.4i, 2.8D - 4X4 (98-09)
<b>304508</b>	Front Gearbox Oil Seal, Timing Cover / Cam Oil Seal	Hyundai Bakkie 2.5i D4BH Dies., 2.6i D4BB Dies. (97-01), H100 P/Van 2.5i D4BH Dies., 2.6i D4BB Dies. (00-07), Isuzu Relay 2.0 P/van, Bus 4ZC1 (89-95), Mitsubishi Colt LDV 1.6 SWB/LWB Lo-Line P/up 4G32 Pet., 2.0 4G63 Pet., 2.5D 4D56 Dies., 2.6 WB Hi-Line P/up 4G54 Pet. (94-98), 2.5D LWB Hi-Line P/up 4D56 Dies., 2.6 LWB Lo-/Hi-Line, P/up 4G54 Pet., 3.0 V6 LWB Lo-/ Hi-Line D/cab, Rodeo 6G72 Pet. - 4X4 (95-98), Nissan 1-Tonner/Hardbody AW/D21 1.6 L16S-J, 1.8 L18S-R, 2.0 NA20, 2.4 Z24/S, 2.5D TD25i, 2.7D TD27, 3.0 VG30E (88-98), 1-Tonner/Hardbody AW/D21 2.4 Z24S - 4X4 (88-98), 2.7 TD27, 3.0 VG30E - 4X4 (90-99), 720 D20 1.8 L18S Kingcab, Sport, 2.2D SD/Z22 Tracker, 2.3 SD23 - 4X2, 1.8 L18S, 2.0 NA20, 2.2 Z22 - 4X4 (80-88), B140 1.4 A14SP/van, S/W, Deluxe, Std. Sport, CHAMP P/up (80-93), E20 1.8 L18 Bus, P/van Coach, Coach GL, GLE, Econolux, Ekonovan, Ekonowagon, 2.0 Bus, Van H20 (80-96), Hardbody QW/D22 2.0 NA20S, 2.0i KA20, 2.4i Z24, KA24E/DE, 2.7D TD27i, 3.0 i VG30E, 3.0TD ZD30, 3.2 QD32, 3.3i VG33E - 4X2, 2.4i KA24E, 2.7 TD27, 3.0 VG30E, 3.0TD ZD30, 3.2, 3.2D QD32, 3.3i VG33 - 4X4 (98-11), NP300 D22 2.0i, S, SE KA20, 2.4i, S/C, D/C Highrider KA24 DE, 2.5TDi, S, SE Highrider YD25 (2008-), Laurel C31 2.8 SGL 5L28 (80-87), Patrol Y60 3.0 VG30E - 4X4 (95-00), Y61 3.0Di, 4.2 TD42 - 4X4 (99-04), Sani AW/D21 2.4, i Z24, 2.5 TD25, 2.7D, TD TD27, 3.0 VG30E - 4X2 (86-99), 2.2 Z22, 2.4 Z24, 2.7 TD27, 3.0 VG30E - 4X4 (86-98), Skyline R30 1.8 L18, 2.0 GL L20, R31 2.0 GL, GLE CA20 (82-92), R30 2.8 GLX, GTX L28/2 (83-86), R31 2.0 SGi, SGLi RB20E, 3.0 SGLi RB30E With I.R.S. (87-92), Terrano II 2.7 TD27 - 4X4 (00-02)

## BUYERS GUIDE - OIL SEALS

<p><b>304508.. Continued</b></p>	<p>Front Gearbox Oil Seal, Timing Cover / Cam Oil Seal</p>	<p>Toyota Condor 1.6 Estate, TE, 5L, 1.8 2Y, 2.0i Estate, TE, 1RZ Pet., 2.4i Estate, TE, TX 2RZ-E, 3.0D Estate, TE, 5L Dies. - 4X2, 4X4 (00-05), Cressida TX30 1.8 DX 3T, TX62 1.8 L, LS 3T, YX70 1.8 LS, Exec. (80-89), RX60 2.0 GL, GLE, GLX, S/W 21R, RX70, YX72 2.0 GL, GL, GLE, GLX (81-92), GX60 2.0 GLi6 1G-E, GX7 2.0 GLi6 1G-E, 1G-FE (83-92), MX63 2.8i 5M-E, MX73 2.8i RSi, RSi Exec. 5M-GE (84-89), MX75 3.0i ECT, GLS 7MG-E (86-92), RX72 2.4 GL, GL S/W, GLE, GLE S/W 22R, RX73 2.4 GLE, GLE S/W 22R With I.R.S. (Independent Rear Suspension) (87-92), Fortuner 3.0 D-4D SUV 1KD-FTV - 4X4 (2006-), Hiace YH51/61 2.0 SWB/LWB 16 Seater Commuter, Super 10 Seater Custom Wagon, P/van 3Y Pet. (83-86), YH53/63 2.2 SWB/LWB P/van, Van, LS, GLX, Exec. Wagon 4Y Pet. (All Imp. Models) (86-88), YH53/63 2.2 SWB/LWB P/van, Van, LS, Super T/14/16, GLX, Exec. Wagon, Siyaya Bus, P/van 4Y Pet. (All Local Models) (88-09), Hilux LN30/40/50/51/55 2.2 SWB/LWB P/up L Dies., 2.4 SWB/LWB D/cab, Raider P/up 2L Dies., YN58 2.2 LWB D/cab, Raider, SRX P/up 4Y Pet. (79-98), YN67 2.2 LWB D/cab, Raider D/cab P/up 4Y Pet. - 4X4 (86-94), YN51/56 1.8 SWB/LWB D/cab, S, SR, Raider P/up 2Y Pet., YN140 1.8 SWB/LWB D/cab, Raider, S, SRX P/up 2Y Pet. (86-05), LN65 2.4 LWB D/cab, Raider D/cab P/up 2L Dies. - 4X4 (89-98), RN67 2.4 LWB D/cab, Raider D/cab P/up 22R Pet. - 4X4 (94-98), RN58 2.4 22R Pet., LN140/145 2.4i DLX, P/up 2L Dies., RZN194 2.7i LWB D/cab, Raider, SRX, Legend35 Raider, 3RZFE Pet. (94-05), LN57 2.8D LWB D/cab, Raider P/up 3L Dies. - 4X2, LN67 2.8D LWB, D/cab, Raider D/cab P/up 3L Dies. - 4X4 (95-98), RZN147 2.0 SWB/LWB D/cab, DLX, Raider, S, SR, SRX P/up 1RZ Pet., LN192R 3.0D LWB Raider D-E, Raider DLX D/cab D-E, Legend35 Raider, P/up 5L Dies., 3.0iD LWB Raider, Raider D/cab, P/up KZ-TE Dies. (98-05), RZN169 2.7i LWB D/cab, DLX S/cab, Raider S/D/cab, SRX D/cab, Legend 35 LWB P/up 3RZFE Pet., LN167 3.0D D/cab D-E, DLX, S/D/cab DE, Raider DE, Legend35 LWB P/up 5L Dies., 3.0iD LWB Raider S/cab &amp; KZ-TE D/cab P/up, Legend35 - 4X4 (98-05), Hilux "Vigo" 2.0i S/Cab, S, SRX LWB Pet. P/up 1TR-FE Pet. (09-11), Hilux 2.0 VVTi 1TR-FE 5 Spd Man. S/cab, 2.5D-4D Raised Body, Std. Body 2KD-FTV 5 Spd Man. - 4X2, 2.5D-4D Raised Body 2KD-FTV 5 Spd man. - 4X4 (11-16), Stallion KF50 1.5 SR5, Commuter, Bus, P/up, P/van 5K Pet., YF50 1.8 SR5, P/up, P/van, Van 2Y Pet., LF50 2.4D P/up 2L5F Dies. (87-04), Venture YF50 1.8 8/10 Seater P/van 2Y Pet., 2.2 10 Seater, GLE, Getaway 9 Seater S/W 4Y Pet., LF50 2.4D 10 Seater S/W 2L5F Dies. (91-04)</p>
<p><b>304608</b></p>	<p>Front Gearbox Oil Seal</p>	<p>VW Kombi 1.9TDi, 2.5TDi, 3.2 V6 Crew Bus, Caravelle, P/up (2004-)</p>
<p><b>304707</b></p>	<p>Front Gearbox Oil Seal / Timing Cover / Cam Oil Seal</p>	<p>BMW 518, 520 (74-79), Mercedes-Benz 190E 1.8, 2.0, 2.3 (93-94), 200, 200E, 220E, 230E, 260E, 300D (86-96), C180, C200, C220, C230, C250, C270, C280, C320 (94-08), E200, E220, E230 (96-04), Volvo C70 2.5T (2006-), S60 2.0T, 2.3, 2.4, T, 2.5T (01-06), V70 2.0T, 2.5T (04-07), S60 2.5R (03-07), V70 2.5T R (05-08), XC70 2.5T (03-07), XC90 2.4, 2.5T (04-09)</p>
<p><b>304710</b></p>	<p>Drive Shaft Oil Seal - RHS</p>	<p>Citroen C3 1.4i HDi, DV4TED4, 1.6i Pluriel, Sensodrive, TU5JP4 (02-10), C5 2.0 SX, EW10J4S (01-05), Xsara 1.6 SX TU5JP, 1.8 Picasso Exclusive, EW7J4, 2.0 Picasso HDi, VTS, Exclusive, HDi Exclusive DW10/TD (03-08), Fiat Ulysse 2.0 MPV XU10 J2/Z (99-02), Peugeot 1007 1.6 MPV TU5JP4 (05-08), 206 1.4 X-Line, XS-Line, XS-Line HDi, Popart, Popart+ TU3JP, 1.6 XS-Line, CC, SW XS, XT, XT Premium TU5JP4, 2.0 CC, GTi, 180 EW10J4, XT HDi DW10TD (01-08), 207 1.4i XL, XR, XR+, Urban, Active, 1.4 Hdi, 1.6i XS, GTi, CC Sport 1 &amp; 2, HDi XS, Dynamic, VTi Dynamic, 1.6 Hdi (06-13), 306 1.6 XT S/W TU5JP, 2.0 Cabrio, XSi XU10J4R/ RS/, XU10J2/K (95-03), 307 1.6 Estate, X-Line, XR, XT TU5JP4, HDi, X-Line HDi, XS HD EW10J4, 2.0 CC, CC 100/ 130/ 180, XS, S/W EW10J4 XS HDi DW10TD (01-08), 405 1.6 GR XU52C/K, 1.8 GR XU7JP/LZ, 2.0 SRi XU7J2/CL (95-97), 406 2.0 Coupe, Estate, SLi, ST, ST Comfort, Estate, STi, Si EW10J4R/XU-10J4R/ XU10J2TE, 3.0 ST, SV Executive ES9J4S (96-05)</p>
<p><b>305007</b></p>	<p>Front Gearbox Oil Seal</p>	<p>BMW 3 Series E36 E36 316i 1.8 Dolphin Shape M40, 318i 1.9 M44, 320i 2.0 M50, 323i 2.5 M52, 325i M50, 328i 2.8, 3.0 M52, Z3 2.8, 3.0 Roadster (92-00), E37 M3 M Coupe S50 (93-01)</p>
<p><b>305207</b></p>	<p>Cam Oil Seal</p>	<p>Fiat Palio I 1.2 ED, EL, Go!, Paint Ltd. M657BA.12T 178B5.000, 1.6 EL, ELX, HL, Weekend S/W, 178B3.000 (00-05), Palio II 1.2 Go!, 178B5.000, 1.6 178B3.000, 1.7TD, EL. (05-10), Stilo 1.9 JTD Dynamic, MultiWagon JTD Dynamic 192A1.000, 937A7.000 (03-06), Strada 1.7D EL P/up (05-10), Uno 1.4 Turbo 146A (90-98), 1.4 Pacer, Beat, Mia, Tempo, SX 146C1 (90-05)</p>
<p><b>315110</b></p>	<p>Front Gearbox Oil Seal</p>	<p>Land Rover Defender 110 2.5 Tdi, 2.5Td, 3.5, Defender 130 2.5, 2.5Td, 2.5Tdi, 3.5, Defender 90 2.5 Tdi, 3.5 (95-05)</p>
<p><b>324406</b></p>	<p>Timing Cover Oil Seal</p>	<p>Renault Clio II/III 1.2 (2002-), Twingo 1.2 (2009-)</p>
<p><b>324708</b></p>	<p>Timing Cover / Cam Oil Seal</p>	<p>Chana Star 1.0 P/up, 1.3 P/up (06-12), Chevrolet Spark 0.8 L, LS, 1.0 LT, LS (03-10), Suzuki Jimny 1.3i SUV M13A, 1.5 K15B - 4X4 (2014-)</p>



## BUYERS GUIDE - OIL SEALS

<b>324710</b>	Cam, Pinion, Timing Cover	Alfa Romeo 155 2.5 V6 AR67301 (96-99), Audi 100/4 1.6 LS YV, 100/5 1.9 WH, 200 2.1 GLS, GLX, 400 1.8 JW, 500 2.1/2.2 WB, WC SE PR (77-92), 500 2.2 E PR, 2.3 E, SE, AAR, 2.8 SEL AAH (92-94), A4 1.8 8D2, B5 Exec ADR, 1.8T APU (95-01), A4 2.5 TDi 8D/E2 Quattro AFB, Quattro Tiptronic, 2.6 8D2 / 8D5 Exec. (95-00), 3.0 Quattro Tiptronic, ASN (02-08), A6 2.8 Quattro 4A, AAH, ACK, 3.0 Quattro Tiptronic BBJ (94-00), 2.4 Avant Multitronic., Tiptronic, AGA, ALF, AML, APS, ARJ, 2.5TDi Multitronic Avant SW., BCZ/BDG/BFC, 2.6 ABC (97-03), 2.7T Quattro AJK, ARE, BES (00-06), 4.2 Quattro Tiptronic ARS (00-08), A8 3.7 Tiptronic AQQ, 4D2, 4.2 Quattro 4E2/8 BFM (95-02), S4 2.2T Quattro AAN (92-95), 4.2 Quattro, Avant 8E2/E5, S/W, BBK, AQF (03-08), VW Caddy 1.6 SWB, Caddy Club P/up JK Dies., HM Pet., 1.8 SWB L, Sport P/up HV Pet. (81-97), 1.6i Club, Citi, P/up HM Pet. (97-03), Citi Golf 1.3 L ET/GY, 1.6 Blues, Chico, Chico Lux, Deco, Designa, L, Ritz, Shuttle, Sonic, Sport HM, HV, FR, 1.6iL, Life, VeloCiti, TenaCiti, CitiStorm, - Sport, - Rox, Rhythm, MKI AFX, 1.8 CTi, Designa, L Sport BZF (83-09), 1.3 L ET/GY (83-87), 1.3 L Shuttle, Chico, Chico, Lux ET/ GY/ AJD (87-03), 1.4, iL, Chico, Rhythm, Citi com, VeloCiti, TenaCiti, CitiStorm, - Sport, Rox, Rhythm, Wolf, - XCite, Billabong AGY/BSV (99-09), Fox 1.3 L, L Trippa GY, 1.6 L HM, 1.8 L Sport HV (87-96), Golf I 1.1 GL, L, LS ET/EG, 1.3 GL, L, LS GF (78-82), 1.5 GL Diesel, GLS, LS CK/EM/JB, 1.6 GL Diesel, GT, GTS, GTX JK/CR FR, 1.8 Gti EV (78-84), Golf II 1.3 CL GY, 1.6 CSL HM, 1.8 8/16V CSX, GTS, GTi KR, EV, 2.0 8/16V GTi AAL (84-92), Golf III 1.6 GS ACG, 1.8 GSX, GTS ACH, 2.0 GTi, Exec. 2E, 2.8 VR6, Exec. AAA (92-99), Jetta I 1.3 GL, GX ET/ GF, 1.5 GLS, GLX JB, 1.6 GLS EM, 1.8 GLi DX (80-85), Jetta II 1.6 CSL HM, 1.8 8/16V CLi, CLi Exec., CLX, CSi, CSX EV/KR, 2.0 8/16V CLi, Exec. AAL (85-92), Jetta III 1.6 CSL ACG, 1.8 CLX/CSX ACH, 2.0 CLi, Exec. 2E, 2.8 VR6 Exec. AAA (92-99), Kombi T3 1.8 P/van, GUS, Volksiebus AAX Pet. (89-99), Passat I & II 1.3 L, LS H/back, Sedan, Variant ZF, 1.5 GL, LS Fastback, S/W CK, 1.6 GL, GLS, LS, LX Fastback, S/W, Sedan, Coupe, Variant, YN/YP/WN, 1.8 CL Sedan, S/W JV/KR (74-87), Passat I & II 1.9 GLS H/back, GLX Sedan, S/W WN, 2.2 CLi, CLX SG/MX (81-87), Passat IV 2.8, 4 Motion, Quattro, Tiptronic ACK/ AMX (99-05)
<b>324807</b>	Gearbox / Timing Cover, Cam Oil Seal	Daihatsu Charade 0.8 CX, CXL G11 CB22, Turbo G21 CB60 (83-85), Cuore 847cc ED10 (97-03), Toyota Hiace YH50/60 1.8 SWB / LWB P/van, LS Wagon 2Y Pet. (83-91), Land Cruiser FZJ/HZJ75 4.2 GX S/W, P/up 1HZ Dies. - 4X4 (91-97)
<b>324808</b>	Front Gearbox Oil Seal	Toyota Hilux LN30/40/50/51/55 2.2 SWB/LWB P/up L Dies., 2.4 SWB/LWB D/cab, Raider P/up 2L Dies., YN58 2.2 LWB D/cab, Raider, SRX P/up 4Y Pet. (79-98), YN51/56 1.8 SWB/LWB D/cab, S, SR, Raider P/up 2Y Pet., YN140 1.8 SWB/LWB D/cab, Raider, S, SRX P/up 2Y Pet. (86-05), Stallion KF50 1.5 SR5, Commuter, Bus, P/up, P/van 5K Pet., YF50 1.8 SR5, P/up, P/van, Van 2Y Pet., LF50 2.4D P/up 2L5F Dies. (87-04)
<b>324810</b>	Rear Gearbox Oil Seal	Mazda 323 FWD 1.3 S, H/back, Sedan E3, 1.5 GLC, SL, SLX, Sport H/back, Sedan E5 (81-88)
<b>325010</b>	Drive Shaft Oil Seal	Citroen C5 3.0 (01-05), Berlingo 1.4, 1.9D (2003-)
<b>325211</b>	Drive Shaft Oil Seal	Nissan 720 D20 1.8 L18S Kingcab, Sport, 2.2D SD/Z22 Tracker, 2.3 SD23 - 4X2, 1.8 L18S, 2.0 NA20, 2.2 Z22 - 4X4 (80-88), Pulsar 1.3 S E13, 1.4 DL, GX A14, 1.5 GL, Panache, SX E15 (80-87), Toyota Corolla RWD TE31 1.6 Sprinter, SR4/5, Black Hawk, Silver Wolf 2T, AE/TE71 1.6 GL, S/W, GLS Sprinter, SE 2T, TB TE72, 1.8 GLS, SE 3T (80-88), Corolla TE71 1.6 P/van 2T (83-89), KE70 1.3 P/van 4K (84-88)
<b>325307</b>	Use - 9503	
<b>325812</b>	Gearbox, Pinion Oil Seal	Nissan Stanza 1.6 DL, Resort, S/W L16, 1.8 GL, Resort, S/W SSS L18 (80-84)
<b>326512</b>	Drive Shaft Oil Seal	Mitsubishi Colt LDV 1.6 SWB/LWB Lo-Line P/up 4G32 Pet., 2.0 4G63 Pet., 2.5D 4D56 Dies., 2.6 WB Hi-Line P/up 4G54 Pet. (94-98), 2.0 LWB Std. P/up, 2.0i LWB Hi-Line, 2.4i LWB Hi-Line Rodeo S-/D/cab, Hi-Line/Rider P/up Pet., 2.5D 4D56 Dies. (98-09)
<b>334705</b>	Timing Cover Oil Seal	Ford Fiesta III 1.4 Sedan, 1.4i Ambiente', Trend, Titanium, 1.6 Limited, 1.6i Ambiente', Sport, Trend, Titanium, TDCi, 1.6 Gtdi (2008-), Focus I 1.6i 4/5 Door, Ambiente' Zetec S (00-05), Focus II 1.6 Si, Ambiente, Trend. (05-09), Focus III 1.6i PNDA (09-15), Volvo C30 1.6 Man. (08-13), S60 1.6 T3, T4 (2010-), V40 1.6 T3, T4 (2012-)
<b>335010</b>	Rear Gearbox Oil Seal	Opel Rekord 2.0 Berlina, GL, GLS, L, S/W CIH, 2.0i CLE, CLS, GL, GLE, Irmscher, 2.2E CIH, 380i, V6 CD, GSi 38GE (82-95)
<b>344606</b>	Cam Oil Seal	Daihatsu Charade 1.0 (2003-), Sirion 1.0 (00-08)
<b>345007</b>	Timing Cover / Cam / Gearbox Oil Seal	Ford Bantam 1400 Leisure, Nite P/up CVH/FUA, 1600 Leisure Explorer, Nite P/up CVH (83-94), Escort FWD MkIII 1.3 GL, L Kent, 1.6 GLE, L, Sport, XR3, i HL16CVH (81-86), Mondeo 1.8i LX, Tdi LX Zetec M5 Endura TD, 2.0i Aspen, CLX, CLX, Ghia, Trend Zetec M5, 2.5i Si Duratec M5 (97-01), Telstar 2.0 GL, GLE, GLi, Mystique FS/KF, 2.5 V6 Ghia, GLi KL, TX5 2.5 V6 RSi KL (94-99), Mazda 626 2.0i 16V Medium High, V6 24V High KF/KS, 2.5i V6 Exec. KL, MX-6 2.5 V6 KL (93-98), Rustler 1.4 SWB P/up CVH/FUA Pet., 1.6 SWB, LX P/up CVH/ LUC Pet. (86-94), Mitsubishi Canter 2.5 SWB/LWB D/side, Chassis cab 4G55 Dies., 2.6 4G54 Pet., 3.3 4D30A Dies., 3.8 ADE236 Dies. (80-97), Nissan Laurel C31 2.0 CA/L20 (80-87), Stanza 1.6 DL, Resort, S/W L16, 1.8 GL, Resort, S/W SSS L18 (80-84)
<b>345207</b>	Timing Cover Oil Seal	Kia Sephia 1.5 (98-01), Shuma 1.5i, 1.8i (99-02), Spectra 1.6 (01-03)
<b>345208</b>	Rear Gearbox Oil Seal	Mercedes-Benz 220, 220D, 230, 230/4, 230/6, 240D, 250SE, 280, E, S, SE (65-77), VW Beetle 1.8T, 2.0 (2000-), Golf IV 1.6i, 1.8, T, 2.0i (99-05), Jetta IV 1.6i, 1.8, T, 2.0i (99-06)
<b>345511</b>	Rear Wheel Oil Seal Inner	Nissan E20 1.8, 2.0 (80-96), 720 1.8, 2.2D, 2.3 4X2, 4X4 (80-88)

## BUYERS GUIDE - OIL SEALS

<b>354706</b>	Timing Cover Oil Seal	Ford Focus II 2.5ST 2005-), Renault Clio I/II/III 1.4, 1.5DCi, 1.6 (1999-), Laguna 1.6 (99-01), Logan 1.6 (2009-), Megane 1.6 (96-01), Megane II 1.4, 1.5DCi, 1.6 (2002-), Sandero 1.4, 1.6 (2009-), Scenic 1.4, 1.6 (1998-), Kangoo 1.4 (2001-), Twingo 1.6 (2009-), Volvo C30 2.5 (2008-), C70 2.3 (02-04), S/V40 2.0T (98-04), S40 2.4, 2.5 T5, V50 2.4, 2.5 T5 (04-09), S/V70 2.3, 2.4 (97-01), S80 2.4T, 2.5T (02-06), S90 2.9, V90 2.9 (97-00), V70 2.4 - 4X4 (00-07)
<b>354712</b>	Rear Gearbox Oil Seal	Nissan Sani 2.4, 2.7 (98-99), Hardbody 2.0, 2.4i, 2.7, 3.2, 3.3 (98-08), NP300 Hardbody 2.0i P/up (2008-)
<b>354807</b>	Timing, Cam, Gearbox Oil Seal	Chevrolet Aveo 1.5 L, LS, LT (03-15), Captiva 2.4 LT Z24SED - 4X2, 4X4 (07-11), Cruze 1.6 L, LS F16D3, 1.8 LS, LT F18D4 (09-15), Optra 1.8 Lt T18SED (04-11), Orlando 1.8 F18D4 (2011-), Sonic 1.6 Pet. Hatch / Sedan (11-15), Chrysler PT-Cruiser 2.0 ECC Pet., 2.4 ED2 Pet. (02-09), Voyager 2.4 SE MPV, 2.4 SWB, 3.3 SWB (02-07), Daewoo Cielo 1.5 GL, GLX, GTX, 150i L, Espero 1.8 CD, C18LE (96-99), Lanos I 1.35i S, 1.6 SX, Lanos II 1.4 S, 1.6 SX, Numbira I 1.6 SX, 2.0 CDX, Numbira II 1.6 SX, SX S/W, 2.0 CDX, Exec., S/W (97-03), Tacuma 1.6 SX, 2.0 CDX, CDX Plus (01-03), Hyundai Accent X3 1.3 G4EH, 1.5 G4EK (94-00), Accent LC 1.3 G4EH, 1.5 G4EK, 1.6 G4ED (00-06), Elantra HD 1.6 GLS, 2.0 GLS, G4GC (07-11), Jeep Cherokee (KJ) 2.4 KJ EDI (02-08), Kia Rio II 1.4 High, A5D, 1.6 Sport G4ED (2004-), Nissan NP200 1.5DCi S, SE P/up, 1.6, S, SE P/up (2008-), Opel Ascona 1.3 L 13NV/SC, 1.6 GL 16SH, 1.8 GLS 18L (82-87), Astra F 140i, iS 14NV, 160i, iE, iS, Estate 16NZ (93-99), Astra G 1.6 CS, Classic CD, CDE, Comfort C16SEL, 1.8 Classic CDE, Caravan CD S/W, Elegance, Irmscher X18XE1, 2.0 Coupe', CSX X20XEV, 2.2i Classic Exec. (99-06), Astra H 1.4 Essentia, Z14XEP, 1.6 Classic Club, Elegance, Enjoy, Essentia, Sport Z16XEP, 1.8 Enjoy, GTC, GTC Sport, Twintop, Enjoy, Z18XER, 1.9 CDTi Enjoy, GTC, CDTi, GTC CDTi Sport, 2.0 Coupe' Turbo, GSi, GTC Turbo, GTC Turbo OPC, GTC Turbo Sport, Turbo Sport, Twin top (04-10), Astra J 1.6i (2010-), Opel Corsa B 130, i, Lite, iE, iS, Chill Hatch / Sedan 13NE, 140i, Classic, Active, Lite, Lite+, Comfort, Chill, Sport, S 14NE, Hatch/ Sedan, 160, i, iE, Classic, GSi, i Sport, S Hatch/ Sedan, 16SE, 1.8i GSi Hatch (96-03), Corsa C 140i Classic, Comfort, Chill, Classic Essentia, Hatch Club, Sport, Lite Sport, S14NE, 160i Classic, Classic Elegance, Classic CD, CDE, Sport, 16SE, 1.8i GSi Hatch, Classic (03-08), Corsa D 1.3CDTi Enjoy, 1.4i Essentia, Enjoy, Cosmo, Sport, 1.6i Sport, OPC (08-15), Opel Corsa LDV 130i Utility P/up 13NE, 1.4i Utility, S P/up 14NE, 1.6i Utility Sport P/up 16NZ (97-04), Corsa LDV II 1.4i Utility, Club Sport, S P/up 14XE (03-10), Corsa P/van 1.3i Pronto 13NE, 1.4i Combo P/van (1999-), Kadett D, E 1.2 L 12NS, 1.3 Cub, GL, GLS, LS, Rebel 13NV, 140 CL, Cub 14NE/ NV, 1.6 GL, GLS, GSE, L, Rebel, Cub 16SH/ SE, 160i, GSi Aspen 16SE (80-93), 1.8 GTE 18E, L 18LV, GSi Hatch 18L, GLX 18SV, GSi 18E/ SE (84-93), Kadett E 2.0 GSi 20XE, SGI 20SEH, 200, iS 20SE, Boss 20SEH, CD 20SHE, GSi, Super Boss 20SEH (87-93), Kadett F 140, S 14NE, 160i, iS, GSi, Aspen 16SV/ NZ, 180i, iE, GSi 18SE, 200is 20XE (93-99), Meriva 1.3 CDTi Enjoy, 1.4 Essentia, Enjoy, 1.6 Club, Comfort, Enjoy MPV Z16SE/-XE, 1.8 Elegance MPV Easytronic (03-09), Monza 160 GSi, i Aspen 16SE/ NZ, CLS 16SV, 1.8 CLX, GLE, GLX, Convertible, GLi 18SE/ SV, 2.0 CD, CLi 2.0XE, CLE, GLE 20SE/ V (86-93), Zafira I 1.8i CD, Enjoy, Elegance MPV Z18XE/-1 (01-05), Zafira II 1.6 Essentia MPV, 1.8i Enjoy, Elegance MPV Z18XE/-1, 1.9CDTi Elegance, 2.0i Turbo OPC, 2.2i Enjoy, Elegance MPV Z22SE (05-09), Renault Espace 2.0 Authentique Expression, RXE, RXT MPV J7R, F4R, 3.0 L7X727, 3.0 Previl (96-08), Toyota Land Cruiser FZJ/HZJ75 4.2 GX S/W, P/up 1FZF/HZ Dies., (91-97), FZJ80 4.5 Std., GX, VX, Turbo S/W, P/up 1FZ-FE Dies., Turbo Dies. (92-95), FZJ80 4.5 Std., GX, VX, Turbo S/W, P/up 1FZ-FE Dies., Turbo Dies. (95-06), HDJ/HZJ80 4.2 GX, Turbo S/W, P/up1HD-FT, 1HZ Dies.,T. Dies. (90-95), HDJ/HZJ80 4.2 Std., GX, VX, Turbo S/W, P/up 1HD-FT, 1HZ Dies., Turbo Dies. (95-01), HDJ100 4.2 Std., GX, VX S/W, 1HZ Pet., 4.5, 4.7 V8 - 4X4 (97-04), UZJ100 4.5 V8 Std., GX, VX S/W, P/up 2UZ-FE Pet. - 4X4 (98-06)
<b>354810</b>	Timing Cover Oil Seal	Audi 200 2.1 GLS, GLX (77-92), 500 2.2 E PR, 2.3 E, SE, AAR, 2.8 SEL AAH (92-94), VW Caddy 1.6i Club, Citi, P/up HM Pet. (97-03), Passat I & II 1.9 GLS H/back, GLX Sedan, S/W WN, 2.2 CLi, CLX SG/MX (81-87)
<b>354814</b>	Gearbox Oil Seal Rear	Ford Courier 1.6 P/up F6, 1.8 Chassis cab, Explorer, Std., XLT P/up F8., 2.0 XLT FE., 2.2 D/cab, Explorer, Leisure, Std., XLT P (86-00), Mazda B-Series B2000 2.0 SWB P/up MA Pet., B2200 2.2 SWB/LWB P/up S2 Dies. (82-86), B2600 2.6 LWB D/cab, Magnum, Drifter P/up 4G54 Pet. - 4X2 (86-95), B1600 1.6 SWB Magnum P/up F6 Pet., B1800 1.8 SWB/LWB Magnum, Drifter P/up F8 Pet., B2000 2.0 LWB Drifter, Magnum P/up FE Pet., B2200 2.2 LWB D/cab, Drifter, Magnum P/up R2 Dies., 2.2 LWB D/cab, Drifter, Magnum P/up F2 Pet. (86-00), Drifter 1.8 SWB/LWB XL P/up Pet., 2.2 SWB/LWB XL P/up Pet. (00-09)
<b>355007</b>	Timing Cover / Cam Oil Seal	Ford Bantam 1400 Leisure, Nite P/up CVH/FUA, 1600 Leisure Explorer, Nite P/up CVH (83-94), Escort FWD MkIII 1.3 GL, L Kent, 1.6 GLE, L, Sport, XR3, i HL16CVH (81-86), Focus I 2.0i 4/5 Door,L Trend, RS, ST170 Zetec E (00-05), Laser 1.4 L CHV-FUA (86-92), Kia Sportage (JE) 2.0 SUV G4GC, 2.0 CRDi SUV D4EA (04-10), Mazda 121 Soho 1.4i 3/5 Dr. H/back Zetec CVH/PTE (97-99), Rustler 1.4 SWB P/up CVH/FUA Pet., 1.6 SWB, LX P/up CVH/ LUC Pet. (86-94), Peugeot Boxer 2.5TD 1.8 Ton Delivery Van DJ5TED (98-01), Tata Indica/Vista 1.4 LEi, LSi, LX, Lxi, 1.4TDi DLX, DLS, Indigo 1.4 GLS S/W, 1.4TDi DLX S/W (2005-)
<b>355008</b>	Timing Cover / Cam Oil Seal	Citroen Berlingo 1.4i P/van, 1.9D (2003-), Ford Escort 1.3, 1.4i, 1.6, XR3 (84-00), Laser 1.4, Meteor 1.4 (89-92), Fiesta 1.4i, 1.6i (99-08), Focus 1.6, 1.8 TDCi , 2.0 (00-05), Ikon 1.6i (01-06), Bantam 1.4, 1.6, 1.6i, 1.8di (1986-), Hyundai Matrix 1.8 (02-07), Mazda 121 Soho 1.4i (97-99), Rustler 1.4 (85-93), Mitsubishi Lancer 1.5, 1.6, 2.0, Outlander 2.4 (03-08), Peugeot Boxer 1.9D HDi, 2.5TD Delivery Van (02-06), Boxer 1.9D, 2.5TDi (06-09), Tata Indica/Indigo 1.4 (2005-)

## BUYERS GUIDE - OIL SEALS

<b>355010</b>	Gearbox Oil Seal	Ford Focus I 2.0i 4/5 Door,L Trend, RS, ST170 Zetec E (00-05), Land Rover 110 Series II, IIA, III 2.6 LWB P/up 6 Cyl. OHI SE Pet., 3.5 LWB "PUP" P/up V8 ADE236 Pet. (84-96), Nissan 1-Tonner/Hardbody AW/D21 2.7 TD27, 3.0 VG30E - 4X4 (90-99), 720 D20 1.8 L18S Kingcab, Sport, 2.2D SD/Z22 Tracker, 2.3 SD23 - 4X2, 1.8 L18S, 2.0 NA20, 2.2 Z22 - 4X4 (80-88), E20 1.8 L18 Bus, P/ van Coach, Coach GL, GLE, Econolux, Ekonovan, Ekonowagon, 2.0 Bus, Van H20 (Import) (80-96), Hardbody QW/D22 2.4i KA24E, 2.7 TD27, 3.0 VG30E, 3.0TD ZD30, 3.2D QD32, 3.3i VG33 - 4X4 (98-10), Laurel C31 2.0 CA/L20, 2.8 SGL 5L28 (80-87), Patrol Y60 3.0 VG30E - 4X4 (95-00), Sani AW/D21 2.2 Z22, 2.7 TD27, 3.0 VG30E - 4X4 (86-98), Stanza 1.6 DL, Resort, S/W L16, 1.8 GL, Resort, S/W SSS L18 (80-84), Skyline R30 1.8 L18, 2.0 GL L20, R31 2.0 GL, GLE CA20 (82-92), R30 2.8 GLX, GTX L28/2 (83-86), R31 2.0 SGI, SGLi RB20E, 3.0 SGLi RB30E With I.R.S. (87-92)
<b>355012</b>	Rear Gearbox Oil Seal	Nissan Sani 2.4, 2.5, 2.7, 3.0 (89-99), 1-Tonner, Hardbody 1.6, 1.8, 2.0, 2.4, 2.5, 2.7, 3.0 - 4X2, 2.4 - 4X4 (88-08)
<b>355012</b>	Gearbox Oil Seal Rear	Nissan 89-99 Sani 2.4, 2.5, 2.7, 3.0, 88-08 1Tonner, Hardbody 1.6, 1.8, 2.0, 2.4, 2.5, 2.7, 3.0
<b>355207</b>	Front Gearbox Oil Seal	BMW 518i, 520i, 525e, 525i, 528i, 535i, 540i (82-96), 635CSi (84-89), 728, 728i, 735i, 745i (78-87), M5 (86-94)
<b>355510</b>	Rear Wheel Oil Seal Inner	Nissan 2000, 2300, 2400, 240C, 260C, 300C (68-78), Opel Astra 1.8, 2.0, 92-97 Calibra 2.0, Kadett 2.0 (93-99)
<b>355511</b>	Timing Cover Oil Seal / Rear Wheel Oil Seal - Inner / Pinion Oil Seal	BMW 3 Series E30 316 1.8 M10, 316i 1.6 M40, 318i 1.8 M40, 320i M20/50, 323i M50, 325i M52, 333i M30 (83-89), Nissan 1-Tonner/Hardbody AW/D21 2.4 Z24S - 4X4 (88-88), Sani AW/D21 2.2 Z22, 2.4 Z24 - 4X4 (86-98), Peugeot 605 3.0 V6 SRi ZPJ/LZ (96-98), Boxer 2.5TD 1.8 Ton Delivery Van DJ5TED (98-01), Toyota Corolla TE71 1.6 P/van 2T (83-89), KE70 1.3 P/van 4K (84-88)
<b>355810</b>	Timing Cover / Cam Oil Seal	Alfa Romeo 33 1.5 (83-85), Alfasud 1.2, 1.3, 1.5 (74-85), Export 1.5 (80-85)
<b>356210</b>	Timing Cover / Cam Oil Seal	Mitsubishi
<b>356212</b>	Timing Cover / Cam Oil Seal	Mitsubishi Models
<b>356413</b>	Pinion Oil Seal	Nissan B140 1.4 A14SP/van, S/W, Deluxe, Std. Sport, CHAMP P/up (93-08), Skyline R30 1.8 L18 (82-87)
<b>356512</b>	Drive Shaft Oil Seal	Mitsubishi Colt LDV 2.5D LWB Hi-Line P/up 4D56 Dies., 2.6 LWB Lo-/Hi-Line, P/up 4G54 Pet., 3.0 V6 LWB Lo-/Hi-Line D/cab, Rodeo 6G72 Pet. - 4X4 (95-98), Pajero 2.8 Tdi, 3.0 V6 SWB GLS Wagon 6G72 Pet., 3.5 V6 SWB GLS Wagon 6G74 Pet. - 4X4 (90-01)
<b>356513</b>	Pinion Oil Seal	Isuzu KB230, KB250D, KB40, KB41, KB42, KB43, KB44, KBD40, KBD41, KBD42 (81-95)
<b>356808</b>	Drive Shaft Oil Seal	Honda Ballade 150 (84-89)
<b>357609</b>	Drive Shaft Oil Seal	Honda Ballade 150 (85-96)
<b>364609</b>	Rear Wheel Oil Seal Outer	Toyota Land Cruiser 3.0, 3.4, 4.2, 4.5, 4.7 (97-04)
<b>365007</b>	Timing Cover / Cam Oil Seal	Chevrolet Captiva 2.0D LTZ (07-11), Citroen C3 1.4i (2003-), C5 2.0, Xsara 1.6, Xsara Picasso 1.8 (01-05), Fiat Ulysse 2.0 (99-01)
<b>365008</b>	Cam Oil Seal	Chevrolet Cruze 2.0d (2009-)
<b>366010</b>	Drive shaft Oil Seal	VW Fox 1.6 (90-94), Golf I 1.5, 1.6 (78-85)
<b>377812</b>	Front Wheel Oil Seal Inner	Mercedes-Benz 190E 1.8, 2.0, 2.3 (93-94), 200, 200E, 220E, 230E, 260E, 300D, 300E, 320E (86-96)
<b>385006</b>	Timing Cover, Cam Oil Seal	Citroen C1 1.0 1KR, 1.0i Furio, Play 1KR (06-15), Xsara 1.6 SX TU5JP (03-08), Honda Civic VII 150i, 170i V-Tec (03-06), Mitsubishi Colt LDV 2.8D LWB Std., Hi line P/up Dies., 2.8TDi LWB Club CabS cab,Turbo, 3.0i V6 LWB Club S/cab P/up Pet. (94-98), 2.8TDi LWB Pioneer, Rodeo D/cab P/up Turbo Dies., 3.0i V6 LWB Rodeo D/cab P/up Pet. - 4x2, 2.8D, TDi LWB Club cab,Trailbuster S/cab, Rodeo /cab P/up Dies./ Turbo Dies., 3.0i V6 LWB Rodeo D/cab P/up Pet. - 4x4 (99-09), Peugeot 107 1.0 XR, XR+, X-Line (06-16), 207 1.6i XS, GTi, CC Sport 1 & 2, HDi XS, Dynamic, VTi Dynamic, 1.6 Hdi (06-13), Partner 1.6 , Hdi, 1.9D, 2.0 HDi (03-10), Toyota Auris 1.8i RS, RX (2007-), Avensis 2.0i Advanced (06-09), Aygo 1.0 Fresh, Inferno, Wild 3/5-door, X-Cite, X-Play 1KR (2011-), Corolla FWD 1.6i Professional, Advanced, 1.8i (2007-), 2.0 (07-14), Corolla Verso 1.6, 1.8 (09-14), Corolla Quest 1.6 Auto, Plus (2014-), RAv4 III 2.0i 1AZ-FE GX, VX, Fierce SUV - 4X4 (06-13), Rav4 IV 2.0, 2.5 2AR-FE - 4X2, 4X4 (2013-), Yaris 1.0 T1 (05-10), 1.0 (10-18)
<b>385007</b>	Timing Cover, Cam Oil Seal	BMW 3 Series E30 316 1.8 M10, 316i 1.6 M40, 318i 1.8 M40, 320i M20/50, 323i M50, 325i M52, 333i M30 (83-92), E36 316i 1.8 Dolphin Shape M40, 318i 1.9 M44, 320i 2.0 M50, 323i 2.5 M52, 325i M50, 328i 2.8, 3.0 M52, Z3 2.8, 3.0 Roadster (92-00), E37 M3 M Coupe S50 (93-01), 5 Series E28 520i 2.0 M20, 525e 2.5 M30, 528i 2.8 M30, 535i 3.0 M30 (85-89), E34 520i 2.0 M50, 525i 2.5 M50, 530i 3.0 M60, 535i 3.5 M30, 540i 4.0 M60 (90-00), Citroen C4 1.6 VTR Coupe' TU5JP4, 1.6 Hdi DV6TED4, 2.0i VTS Coupe' EW10J4S (05-10), Daihatsu Terios 1.3 SUV K3-VE, 1.5i Off-Road, 5/7 Seater SUV 3SZ-VE, 1.5 - 4X2, 4X4 (02-15), Honda CR-V 2.0 5 Dr. SUV B20Z1 CR-V CTDi - 4X4 (97-02), Odyssey 2.2 5 Dr. S/W, 2.3 V-Tec 5 Dr. S/W (96-02),Peugeot 1007 1.6 MPV TU5JP4 (05-08), 307 1.6 Estate, X-Line, XR, XT TU5JP4, HDi, X-Line HDi, XS HD EW10J4 (01-08), 405 1.6 GR XU52C/K (95-97), Toyota Avanza 1.5i SX, TX MPV 3SZVE (06-12), Avensis 2.0i Advanced, 2.2i Exclusive (06-09), Cressida RX72 2.4 GL, GL S/W, GLE, GLE S/W 22R (87-92)
<b>385008</b>	Timing Cover / Cam Oil Seal	Toyota Camry 2.2, 2.4i, 3.0 (01-06)
<b>385206</b>	Front, Rear Wheel Oil Seal	Hyundai Atos 1.0 Prime G4HC (00-05), 1.1 G4HG (2005-), Elantra J1 1.6 Exec., G4CR, 1.8 Exec., G4CN (93-95)



## BUYERS GUIDE - OIL SEALS

<b>385207</b>	Front, Rear Wheel Oil Seal	Hyundai Atos 1.0 (2000-), Elantra 1.6, 1.8 (93-95)
<b>385210</b>	Gearbox Oil Seal Rear	Mercedes-Benz 200, 230, 240D (65-68)
<b>385295</b>	Front Wheel Oil Seal	Nissan 1200, B120 1.2 (78-80)
<b>385407</b>	Pinion Oil Seal	VW Kombi 2.1 Fi, 2.5i, 2.6i, 2.1 Fi - 4X4 (85-00)
<b>385408</b>	Drive Shaft Oil Seal	Honda Ballade 160 (87-89)
<b>385509</b>	Front Gearbox Oil Seal / Timing Cover Oil Seal	Nissan B140 1.4 A14SP/van, S/W, Deluxe, Std. Sport, CHAMP P/up (80-08), Pulsar 1.4 DL, GX A14 (80-87), Camry I SXV10/11 R 200i Si 3S-FE, 220 SEi, Si, 5S-FE (92-01), Toyota Conquest / Tazz AE82R 1.6 GL, RS, RSi 4A-L, A-GEL (85-88), AE92R 160i LS, RS, RSi, Sport, RSE, Tazz 4A-F, A-FE, A-GE (88-01), AE92R 160i Edition, Sport, Tazz, XE 4AFE (01-06), Conquest AE93 180i RS, RSi, Sport 7A-FE (93-96), Corolla RWD TE31 1.6 Sprinter, SR4/5, Black Hawk, Silver Wolf 2T, AE/TE71 1.6 GL, S/W, GLS Sprinter, SE 2T, TB TE72, 1.8 GLS, SE 3T (80-88), Corolla FWD AE82R 1.6 GL, GLE, GLi, GLS, GLX, Avante, GLE, GLi, S/W 4A-L, A-GEL (84-88), AE92R 1.6, 160 GL, GLE, GLi, Exec., GLS, Exec., GLX, Sport Sprinter 4A-F, A-FE, A-GE (88-96), AE93R 180i GL, GLE, GSE, GSX, Sprinter 7A-FE (93-96), AE111R 160i GL, GLE, RSi, RXi 4A-FE, A-GE, AE112 180i GLE, GSE 7A-FE (96-02), Cressida MX75 3.0i ECT, GLS 7MG-E (86-92), RX72 2.4 GL, GL S/W, GLE, GLE S/W 22R, RX73 2.4 GLE, GLE S/W 22R With I.R.S. (Independent Rear Suspension) (87-92), Rav4 II ZCA20 1.8 SUV 1ZZFE, ACA20 2.0 SUV 1AZ-FE (02-06)
<b>385811</b>	Gearbox Oil Seal Rear	C.A.M. Inyathi, Jinbei Haise Minibus 2.2i Std. (2007-), Toyota Condor 1.6 Estate, TE, 5L, 1.8 2Y, 2.0i Estate, TE, 1RZ Pet., 2.4i Estate, TE, TX 2RZ-E, 3.0D Estate, TE, 5L Dies. - 4X2 (00-05), 2.4i Estate, TX Estate 2RZ-E, 3.0 Estate, TX Estate 5L - 4X4 (00-05), Corolla RWD TE31 1.6 Sprinter, SR4/5, Black Hawk, Silver Wolf 2T, AE/TE71 1.6 GL, S/W, GLS Sprinter, SE 2T, TB TE72, 1.8 GLS, SE 3T (80-88), Corolla TE71 1.6 P/van 2T (83-89), KE70 1.3 P/van 4K (84-88), Corolla FWD F11 140i GLE, GLS, Sprinter 4ZZ-FE, KS1 160i GLE, GLS, GSX, Sprinter VVT-i 3ZZ-FE DOHC, GF2 180i GLE, GLS, GSX, Sprinter VVT-i 1ZZ-FE DOHC (02-08), Corolla Verso ZZE122 160i S, SX MPV, 180i SX, SX MMT, TX, TX MMT MPV 1ZZ-FE (04-09), Cressida TX30 1.8 DX 3T, TX62 1.8 L, LS 3T, YX70 1.8 LS, Exec. (80-89), RX60 2.0 GL, GLE, GLX, S/W 21R, RX70, YX72 2.0 GL, GL, GLE, GLX (81-92), GX60 2.0 GLi6 1G-E, GX7 2.0 GLi6 1G-E, 1G-FE (83-92), MX63 2.8i 5M-E, MX73 2.8i RSi, RSi Exec. 5M-GE (84-89), MX75 3.0i ECT, GLS 7MG-E (86-92), RX72 2.4 GL, GL S/W, GLE, GLE S/W 22R, RX73 2.4 GLE, GLE S/W 22R With I.R.S. (Independent Rear Suspension) (87-92), Hiace YH50/60 1.8 SWB / LWB P/van, LS Wagon 2Y Pet. (83-91), YH51/61 2.0 SWB/LWB 16 Seater Commuter, Super 10 Seater Custom Wagon, P/van 3Y Pet. (83-86), YH53/63 2.2 SWB/LWB P/van, Van, LS, GLX, Exec. Wagon 4Y Pet. (All Imp. Models) (86-88), YH53/63 2.2 SWB/LWB P/van, Van, LS, Super T/14/16, GLX, Exec. Wagon, Siyaya Bus, P/van 4Y Pet. (All Local Models) (88-09), Hilux LN30/40/50/51/55 2.2 SWB/LWB P/up L Dies., 2.4 SWB/LWB D/cab, Raider P/up 2L Dies., YN58 2.2 LWB D/cab, Raider, SRX P/up 4Y Pet. (79-98), YN67 2.2 LWB D/cab, Raider D/cab P/up 4Y Pet. - 4X4 (86-94), YN51/56 1.8 SWB/LWB D/cab, S, SR, Raider P/up 2Y Pet., YN140 1.8 SWB/LWB D/cab, Raider, S, SRX P/up 2Y Pet. (86-05), LN65 2.4 LWB D/cab, Raider D/cab P/up 2L Dies. - 4X4 (89-98), RN67 2.4 LWB D/cab, Raider D/cab P/up 22R Pet. - 4X4 (94-98), RN58 2.4 22R Pet. (94-98), LN140/145 2.4i DLX, P/up 2L Dies., RZN194 2.7i LWB D/cab, Raider, SRX, Legend35 Raider, 3RZFE Pet. (98-05), LN57 2.8D LWB D/cab, Raider P/up 3L Dies. - 4X2 (95-98), LN67 2.8D LWB, D/cab, Raider D/cab P/up 3L Dies. (95-98), RZN147 2.0 SWB/LWB D/cab, DLX, Raider, S, SR, SRX P/up 1RZ Pet. (98-05), LN192R 3.0D LWB Raider D-E, Raider DLX D/cab D-E, Legend35 Raider, P/up 5L Dies., 3.0iD LWB Raider, Raider D/cab, P/up KZ-TE Dies. (98-05), RZN169 2.7i LWB D/cab, DLX S/cab, Raider S/D/cab, SRX D/cab, Legend 35 LWB P/up 3RZFE Pet, LN167 3.0D D/cab D-E, DLX, S/D/cab DE, Raider DE, Legend35 LWB P/up 5L Dies., 3.0iD LWB Raider S/cab & KZ-TE D/cab P/up, Legend35 - 4X4 (98-05), Hilux "VIGO" 2.0i U16/17 S/Cab, S, SRX LWB Pet. P/up 1TR-FE Pet. - 4X2 (05-09), Hilux "VIGO" 2.0i S/Cab, S, SRX LWB Pet. P/up 1TR-FE Pet. - 4X2 (09-11), Rav4 I SXA10/11 Series 2.0 3/5 Dr. SWB SUV 3S-FE Pet. - 4X4 (94-01), Rav4 II ZCA20 1.8 SUV 1ZZFE, ACA20 2.0 SUV 1AZ-FE - 4X2, 4X4 (02-06), Runx 140i RT, RS, Sport 4ZZ-FE, 160i RS, RT, RX, Sport 3ZZ-FE, 180i RSi, RX 1ZZ-FE (03-08), Stallion KF50 1.5 SR5, Commuter, Bus, P/up, P/van 5K Pet., YF50 1.8 SR5, P/up, P/van, Van 2Y Pet., LF50 2.4D P/up 2L5F Dies. (87-04), Tuv KF20 1.3 Chassis Cab, P/up, P/van, Bus 4K Pet. (82-87), Venture YF50 1.8 8/10 Seater P/van 2Y Pet., 2.2 10 Seater, GLE, Getaway 9 Seater S/W 4Y Pet., LF50 2.4D 10 Seater S/W 2L5F Dies. (91-04)
<b>386210</b>	Gearbox Oil Seal Rear	Mercedes-Benz 230 (66-68)
<b>386509</b>	Gearbox Oil Seal Rear	Toyota Stout RK110 2.0 SWB P/up 5R Pet. (79-89)
<b>387411</b>	Pinion Oil Seal	Toyota Cressida TX30 1.8 DX 3T, TX62 1.8 L, LS 3T, YX70 1.8 LS, Exec. (80-89), RX60 2.0 GL, GLE, GLX, S/W 21R, RX70, YX72 2.0 GL, GL, GLE, GLX (81-92), GX60 2.0 GLi6 1G-E, GX7 2.0 GLi6 1G-E, 1G-FE (83-92), MX63 2.8i 5M-E, MX73 2.8i RSi, RSi Exec. 5M-GE (84-89), MX75 3.0i ECT, GLS 7MG-E (86-92), RX73 2.4 GLE, GLE S/W 22R With I.R.S. (Independent Rear Suspension) (87-92), Toyota Hiace YH51/61 2.0 SWB/LWB 16 Seater Commuter, Super 10 Seater Custom Wagon, P/van 3Y Pet. (83-86), YH53/63 2.2 SWB/LWB P/van, Van, LS, GLX, Exec. Wagon 4Y Pet. (All Imp. Models) (86-88), Hilux LN30/40/50/51/55 2.2 SWB/LWB P/up L Dies., 2.4 SWB/LWB D/cab, Raider P/up 2L Dies., YN58 2.2 LWB D/cab, Raider, SRX P/up 4Y Pet. (79-98), YN67 2.2 LWB D/cab, Raider D/cab P/up 4Y Pet. - 4X4 (86-94), YN51/56 1.8 SWB/LWB D/cab, S, SR, Raider P/up 2Y Pet., YN140 1.8 SWB/LWB D/cab, Raider, S, SRX P/up 2Y Pet. (86-05), Land Cruiser PHJ75 3.9 DLX, GX, GX Turbo P/up Perkins236 2H Dies., FJ75 4.0 DLX, GX, VX 3F/F-E Pet. - 4X4 (85-92), Stallion KF50 1.5 SR5, Commuter, Bus, P/up, P/van 5K Pet., YF50 1.8 SR5, P/up, P/van, Van 2Y Pet., LF50 2.4D P/up 2L5F Dies. (87-04), Stout RK110 2.0 SWB P/up 5R Pet. (79-89), Tuv KF20 1.3 Chassis Cab, P/up, P/van, Bus 4K Pet., 1.5 P/up 5K Pet. (82-87)

# BUYERS GUIDE - OIL SEALS

<b>396211</b>	Timing Cover / Cam Oil Seal	Nissan 521 1.5 (70-73), 620 1.5 (73-79), 680 1.5 (77-80), E20 1.5, 1.6 (73-76)
<b>405207</b>	Front, Rear Wheel Oil Seal / Gearbox Oil Seal / Timing Cover Oil Seal	BMW 3 Series E30 316 1.8 M10, 316i 1.6 M40, 318i 1.8 M40, 320i M20/50, 323i M50, 325i M52, 333i M30 (83-92), 7 Series E32 730i M30/60, 735i M106, 740i M60, 750iL M70 (87-95), 8 Series E31 850iL V12 M70 (91-94), Chevrolet Sonic 1.3D (11-15), Spark 0.8 L, LS, 1.0 LT, LS (03-10), Daewoo Matiz 800cc S, SE F8CV (99-03), Fiat Punto 1.3D 2U 188 JTD Dynamic, JTD Multijet 188A9.000 (04-13), Grande Punto 1.3D JTD Dynamic, JTD Multijet 199A2.000, 199A3.000 (06-10), Honda Prelude 2.2 V-Tec, Si F22, A22 (91-98), Nissan Almera 1.5 HR15DE (2013-), 1.6 Comfort, Elegance, Luxury 16DE/GA16DE, 1.8 Elegance, Luxury, 18DE (01-06), Nissan Juke 1.2 DIG-T HRA20DDT - 4X2 (2010-), Livina 1.6 Acenta, +, Visia, X-Gear (07-15), Grand Livina 1.6 Acenta, + HR16DE (08-14), Micra (K12/13) 1.4 Accenta, Accenta+, Accenta Sport, Visia, Comfort, Elegance, SE CR14PE (2004-), Primera 160 Si, SE SR16DE (98-02), Qashqai 1.6 Visia, Acenta, 1.6 HR16DE (2007-), Sabre 160 GX, GXi GA16DS (94-02), Sentra 1.8i Coupe, Sedan Exec. CA18DE (88-92), 140, i, GX, GXi, Si GA14DNE / DS, 160 GSi, GX, GXi, SE, Si GA16DE/DNE/ DS (92-02), Skyline R31 2.0 SGi, SGLi RB20E, 3.0 SGLi RB30E With I.R.S. (87-92), Tiida 1.6 Acenta, Visia, + (06-13), Corsa D 1.3CDTi Enjoy (08-15), Meriva 1.3 CDTi Enjoy (03-09), Renault 1.2 Tce H4B400 (2016-), Megane III 1.4Tce (2010-), Toyota Corolla TE71 1.6 P/van 2T (83-89), Tuv KF20 1.3 Chassis Cab, P/up, P/van, Bus 4K Pet., 1.5 P/up 5K Pet. (82-87)
<b>405209</b>	Use - 9770KIT	
<b>405209</b>	Drive Shaft Oil Seal	VW Passat I & II 1.3 L, LS H/back, Sedan, Variant ZF, 1.5 GL, LS Fastback, S/W CK, 1.6 GL, GLS, LS, LX Fastback, S/W, Sedan, Coupe, Variant, YN/YP/WN, 1.8 CL Sedan, S/W JV/KR (74-87), Passat I & II 1.9 GLS H/back, GLX Sedan, S/W WN, 2.2 CLi, CLX SG/MX (81-87),
<b>405307</b>	Cam Oil Seal	Ford Focus I 1.6, 2.0 (00-05), Mondeo 1.8, 2.0 (97-01)
<b>405405</b>	Front Wheel Oil Seal	Mazda 323 1.3, 1.4, 1.6 (77-81), Capella 1.6, 1.8, 573 (74-79), F1000, F1300 (69-80)
<b>405508</b>	Drive Shaft, Timing, Gearbox	BMW 3 Series E30 316 1.8 M10, 316i 1.6 M40, 318i 1.8 M40, 320i M20/50, 323i M50, 325i M52, 333i M30 (83-92), 3 Series E36 E36 316i 1.8 Dolphin Shape M40, 318i 1.9 M44, 320i 2.0 M50, 323i 2.5 M52, 325i M50, 328i 2.8, 3.0 M52, Z3 2.8, 3.0 Roadster (92-00), E37 M3 M Coupe S50 (93-01), 5 Series E28 520i 2.0 M20, 525e 2.5 M30, 528i 2.8 M30, 535i 3.0 M30 (85-89), E34 520i 2.0 M50, 525i 2.5 M50, 530i 3.0 M60, 535i 3.5 M30, 540i 4.0 M60 (90-00), 7 Series E23 728, i M30, 730 M30, 733i M30, 735i M90, 745i M88 (78-89), E32 730i M30/60, 735i M106, 740i M60, 750iL M70 (87-95), 8 Series E31 850iL V12 M70 (91-94), M5 Coupe M30, M5 Coupe MS38 (86-94), Citroen C4 1.6 Hdi DV6TED4, 2.0i VTS Coupe' EW10J4S (05-10), C5 2.0 SX, EW10J4S (01-05), Xsara 1.8 Picasso Exclusive, EW7J4 (03-08), Ford Cortina MkIII 1.6 L P/up Kent, 1.6 L, Std., XL Kent, 2.0 OHC GT, V4 L, XL, S/W Essex EV20, 2.0 V4 P/up Koln T20, 2.5 L P/up Essex EV25, 2.5 XL, S/W Essex EV25, 3.0 GT, L, XL, XLE "Big Six" Essex EV30 (71-77), Cortina MkIV 1.3 L Kent, 1.6 GL, L, S/W Kent, 1.6 P/up Kent, 2.0 GL, GLE, S/W Koln T20, 3.0 V6 Ghia, GLS, S, S/W Essex EV30 (77-80), Cortina MkV 1.3 L Kent, 1.6 GL, L, Kent, 2.0 Ghia, GL Koln T20, 3.0 V6 GLS, GLS XR6, Essex EV30 (80-86), Escort MkI/II 1.3 30, 35, 45 P/van Kent, 1.6 45 P/van Kent (68-81), Escort RWD MkII 1.3 L Kent, 1.6 GL, Sport Kent, RS2000 Koln (75-81), Escort FWD MkIII 1.3 GL, L Kent, 1.6 GLE, L, Sport, XR3, i HL16CVH (81-86), Fiesta I 1.3, i Flair, Flite, Play, Fun Endura-EM5, 1.4, i Flair, Trend, Fun Zetec CVH/PTE, 1.6, i Ambiente', Flair, Forte' Ghia, Rsi, Sport, Trend (97-04), Ikon 1.3, Low, LX CLTA, 1.6i, Low, High, LX, CLX CLTA (01-06), Laser 1.3 L, GL, 13, Dash E3 / B3, 1.5 GL, GLS, Sport E5 (86-92), Meteor 1.3 GL, L, 13 E3/B3, 1.4 LX CVH, 1.5 GL, GLS E5 (86-90), Mazda 121 Soho 1.3, i 3/5 Dr. H/back Endura-EM5, 1.4i 3/5 Dr. H/back Zetec CVH/PTE (97-99), 323 FWD 1.3 S, H/back, Sedan E3, 1.5 GLC, SL, SLX, Sport H/back, Sedan E5 (81-88), 323 FWD 1.3 L, H/back, Sedan E/B3, 1.5, L H/back, Sedan E5, 1.6 EG Hatch, L, Sedan, SL Hatch, SL Sedan, Sport Hatch B6i/F6 (84-88), Mercedes-Benz W201 190E 1.8 M102.920, 2.0 M102.922, 2.3 Sportline M102.983 (93-94), W202/3 C-Class C180 Classic M111.920, C200 M111.941, C220 M111.961, C230 M111.974, C240 M111.944, C250 M605.910, C270CDi M612.962, C280 M104.941 (94-08), W210/211 E-Class E200, K M111.941/956, E230 M111.970, E240 M112.911, E280 M112.921, E320 M112.941, E320CDi OM646.961, E350 M272.964, E500 M113.967 (96-10), Peugeot 206 2.0 CC, GTi, 180 EW10J4, XT HDi DW10TD (01-08), 307 2.0 CC, CC 100/ 130/ 180, XS, S/W EW10J4 XS HDi DW10TD (01-08), 406 3.0 ST, SV Executive ES9J4S (96-05), Tata Indica / Vista 1.4 LEi, LSi, LX, Lxi, 1.4TDi DLX, DLS, Indigo 1.4 GLS S/W, 1.4TDi DLX S/W (2005-)
<b>405510</b>	Drive Shaft Oil Seal / Rear Gearbox Oil Seal	BMW 635CSi (84-89), 728i (85-87), Ford Bantam 1.3, 1.4, 1.6 (83-94), Mazda Rustler 1.3, 1.4, 1.6 (85-94), Mercedes-Benz 200, 220D, 230, 230/4, 230/6, 230E, 240D, 250, 250SE, 280, S, SE, 300D (68-86)
<b>405607</b>	Drive Shaft Oil Seal / Timing Cover / Cam Oil Seal	Fiat Palio I 1.6 EL, ELX, HL, Weekend S/W, 178B3.000 (00-05), Palio II 1.6 178B3.000 (05-10), Siena I/II 1.2 EL, EL, Plus!, M657BA 12T, 1.6 EL, Plus!, ELX HL 178B3.000, 1.6 EL+, HL, ELX, 178B3000, 1.7TD EL 176A3.000 (00-10), Stilo 1.6 Active, MultiWagon (03-06), Strada 1.6 EL, EL Sporting, ELX P/up (05-10), Uno 1.4 Turbo 146A (90-98), 1.4 Pacer, Beat, Mia, Tempo, SX 146C1 (90-05), Honda Ballade SH4 160i 16V SOHC, DOHC D16A9 (89-92), Isuzu KB24 2.3 LE 4ZD1 (79-89), KB29 2.3 P/up 4ZD1 (83-89), Land Rover Defender 90 2.5 TDi Country (89-04), Nissan Langley 1.3 GL E13, 1.5 GL, L, SSS, Trebon, Exa Turbo E15 (83-88), Sabre 160 GX, GXi GA16DS (94-02), Sentra 1.3 GL, SX E13S, 1.6 GL, GX, GXE GXEi Coupe, SGLi E16E/S (87-92)
<b>405710</b>	Front Wheel Oil Seal	Fiat 124 1.4, 1.6, 1.8 (67-77), 128 1.1, 1.3 (71-84)



## BUYERS GUIDE - OIL SEALS

<b>405810</b>	Drive Shaft / Gearbox Oil Seal	BMW 318i, 320i, 323i, 325i (83-92), 518, 518i, 520, 520i, 525, 525e, 525i, 528, 528i, 535i (74-89), 635CSi (80-89), 728, 728i, 730, 730i, 733i, 735i, 740i, 745i, 750i (78-95), Citroen C3 1.4i, 1.6i (2002-), C4 1.6, HDi, 2.0 (01-09), C5 2.0, 3.0, Xsara 1.6, Xsara Picasso 1.8 (01-06), Berlingo 1.4, 1.9D (2003-), Fiat Ulysse 2.0 (99-01), Honda CR-V 2.0 (97-02), Nissan Sani 2.4, 2.5, 2.7, 3.0 (89-99), Hardbody 2.0, 2.4, 2.5, 2.7, 3.0 - 4X2, 2.4 - 4X4 (88-08), Peugeot 1007 1.6 (05-08), 206 1.4, 1.6, 2.0 (00-06), 207 1.4, 1.6 (2006-), 305 1.5 (79-84), 306 1.6, 2.0 (95-03), 307 1.6, 2.0 (01-08), 404 1.8, 1618 (63-78), 405 1.6, 1.8, 2.0 (95-97), 406 2.0 (96-03), 504 1.8, 2.0, 2.3 (71-85), 505 2.0 (80-85), 404 1618, 2.0 (67-80), Toyota Cressida 3.0i (89-92)
<b>405810</b>	Drive Shaft, Gearbox Oil Seal	BMW 3, 5 & 6 Series, Citroen C3, Xsara, Fiat Ulysse, Honda Cr-V, Nissan Hardbody, Toyota Cressida
<b>406010</b>	Front Gearbox / Rear Wheel Oil Seal Inner	C.A.M. Inyathi 2.2i Minibus, Van (2006-), Nissan Laurel 2.0 (80-83), Peugeot 305 1.5 (79-84)
<b>406010</b>	Gearbox, Rear Wheel Oil Seal	C.A.M. Inyathi 2.2i Minibus, Van (2006-), Nissan Laurel 2.0 (80-83), Peugeot 305 1.5 (79-84)
<b>406208</b>	Use - 9565 (PTFE Seal)	
<b>406210</b>	Drive Shaft / Gear Oil Seal	Honda Ballade SH4 160i 16V SOHC, DOHC D16A9 (89-92), Mercedes-Benz W123 200 M115.938/9, 230, E M115.954, 240D M616.912, 250 M123.920/1, 280E M110.983, 300D M617.912 (77-86), W202 C-Class C180 Classic M111.920, C200 M111.941, C220 M111.961, C230 M111.974, C240 M111.944, C250 M605.910, C270CDi M612.962, C280 M104.941 (94-08), W208 CLK230, M111.973, CLK320, M112.940, CLK430, CLK500 (98-03), W210/211 E-Class E200, K M111.941/956, E230 M111.970, E240 M112.911, E280 M112.921, E320 M112.941, E320CDi OM646.961, E350 M272.964, E500 M113.967 (96-10)
<b>406510</b>	Rear Gearbox Oil Seal	Mercedes-Benz 380SE (81-87), 320E (93-93)
<b>406512</b>	Pinion Oil Seal	Mitsubishi Colt 1.1 (66-73), Colt LDV 2.4i, 2.5, 2.6, 2.8D, Pajero 1.6, 1.8 - 4X4 (95-04)
<b>407009</b>	Front Gearbox Oil Seal	VW Touareg 2.5TDi, 3.0TDi, 3.6 FSi, 4.2, FSi, 5.0TDi (2004-)
<b>407012</b>	Pinion Oil Seal	Mercedes-Benz 200, 220, 220D, 230, 230/4, 230/6, 230E, 240D, 250, 280, E, SE, 300D, 300SE, 380SE, 420SE (68-92)
<b>407512</b>	Pinion Oil Seal	Mazda B1500, B1600, B1800 (67-80)
<b>407609</b>	Drive Shaft Oil Seal	Honda Ballade 160 (89-92), CR-V 2.0 (97-02)
<b>407609</b>	Drive Shaft Oil Seal	Honda Ballade 160 (89-92), Cr-V 2.0 (97-02)
<b>413807</b>	Front Gearbox Oil Seal	Honda Ballade 180, Civic 150, 160 (96-00)
<b>415607</b>	Rear Wheel Oil Seal	Nissan 1200, 1400, 1600J, 1800J, 280, Laurel, Skyline, Stanza, Toyota Corolla 1.2 (72-80)
<b>417209</b>	Rear Gearbox Oil Seal	VW Touareg 2.5TDi - Manual (2004-)
<b>417211</b>	Rear Gearbox Oil Seal	VW Touareg 2.5TDi – Auto., 3.0TDi, 3.6 FSi, 4.2, FSi, 5.0TDi (2004-)
<b>425307</b>	Timing Cover / Cam Oil Seal	Ford Focus 1.6, 2.0 (00-05), Mondeo 1.8 Tdi, 1.8i, 2.0, 2.0i, 2.5i (97-04)
<b>425307</b>	Timing Cover, Cam Oil Seal	Ford Focus 1.6, 2.0 (00-05), Mondeo 1.8 Tdi, 1.8i, 2.0, 2.0i, 2.5i (97-04)
<b>425308</b>	Timing Cover / Cam Oil Seal	Ford Escort 1.6i, 1.8i (95-00), Mitsubishi Colt 1.1 (66-73)
<b>425406</b>	Timing Cover / Cam Oil Seal	Nissan Interstar 2.5Dci SR, HR P/Van (2006-), Primstar 1.9 DCi Minibus (07-11), Opel Viva-ro 1.9CDTi P/Van (06-15), Renault Clio I, II 2.0 Sport F4R (01-09), Clio III 2.0 Sport, R27, Ltd. Edition F4R832/830 (07-14), Espace 2.0 Authentique Expression, RXE, RXT MPV J7R, F4R, 3.0 L7X727, 3.0 Previl (96-08), Laguna I 1.8 RN, RN Estate, Authentique, Expression F4P7 RT B568/-9F3P/-P6, 1.9dCi F9Q716, 2.0 RT, RT Estate, RXE, Expression K4M720/724, N7Q700 (96-07), Laguna II 1.8 Authentique, Expression, 1.9dCi, Dynamic, 2.0T Dynamic, Expression, 3.0 Privilege, Initial (01-09), Megane I 2.0 Coupe 8/16V F3R710/50, RXE, RSi Coupe, Cabriolet F3R796/-7/-8 (96-02), Megane II 1.5dCi Authentique, Shake it! K9K722, 1.6 Classic Privilege, Expression, Dynamique, Authentique, Shake it! CC Dynamique K4M701, K4M760/ -1, 1.9dCi CC, Dynamique, Privilege, Dynamic + F9Q800, 2.0 Classic Dynamique, Dynamique + , Privilege, CC Privilege, GT F7R710 /-77, 2.0T Sport, F1 Team R26 LE, SE, Coupe Dynamique (02-10), Megane III 2.0 RB7, RS 250, RS 265 (2010-), Scenic I 2.0 RXE, RXi (98-02), Scenic II 1.9dCi Dynamic, Privilege MPV F9Q740, 1.9dCi Dynamique, Expression, Navigator MPV F9Q812, 2.0 Dynamique, Privilege, Navigator MPV F4R770/771 (02-10), Scenic III 1.9dCi (11-13), Trafic 1.9dCi 100 P/Van F9Q760 (05-07)
<b>425506</b>	Front Wheel Oil Seal Outer / Timing Cover / Cam Oil Seal	Isuzu KB320 (98-04), Toyota Camry 2.2, 2.4i, 3.0 (01-06)
<b>425507</b>	Gearbox, Rear Wheel Oil Seal	Dodge Caliber 1.8 SE, SXT, EBE, 2.0 TD, SXT, CVT, ECN, 2.4 RT, SXT, EDA (06-12), Journey 2.0 CRD, R/T, ECE, 2.4 SXT, ED3, 2.7 V6 R/T, SXT, EER, 3.6 V6 R/T, SXT, ERB (2008-), Nissan B140 1.4 A14SP/van, S/W, Deluxe, Std. Sport, CHAMP P/up (83-08), VW Kombi T3 2.1 Fi Caravelle, Microbus DJ Pet., 2.3i Microbus, Volksiebus AFU Pet., 2.5i Microbus, Caravelle AAY Pet., 2.6i Microbus, Caravelle, Exclusive, ADV Pet. - 4X2 (85-04), T3 2.1 Fi Syncro Caravelle DJ Pet. - 4X4 (89-93)

# BUYERS GUIDE - OIL SEALS

<b>425607</b>	Timing, Cam, Front, Rear Wheel	Chevrolet Aveo 1.6 LS (03-15), Optra 1.6 Ls F16D3 (04-11), Citroen C5 3.0 Exclusive A-T ES9J4S (01-05), Daewoo Cielo 1.5 GL, GLX, GTX, 150i L, Espero 1.8 CD, C18LE (96-99), Lanos I 1.35i S, 1.6 SX, Lanos II 1.4 S, 1.6 SX, Numbira I 1.6 SX, 2.0 CDX, Numbira II 1.6 SX, SX S/W, 2.0 CDX, Exec., S/W (97-03), Ford Bantam 1400 Leisure, Nite P/up CVH/FUA, 1600 Leisure Explorer, Nite P/up CVH (83-94), Cortina MkIII 2.0 OHC GT, V4 L, XL, S/W Essex EV20 (71-77), Cortina MkIV 2.0 GL, GLE, S/W Koln T20 (77-80), Cortina MkV 2.0 Ghia, GL Koln T20 (80-86), Escort RWD MkII RS2000 Koln (75-81), Escort FWD MkIII 1.3 GL, L Kent, 1.6 GLE, L, Sport, XR3, i HL16CVH (81-86), Escort FWD MkVI 1.4i H/back, Sedan CVH-PTE, 1.6i GL, GLE H/back, Sedan Zetec, 1.8i GLi, TDi H/back, Sedan Zetec, 1.8TDi Endura (95-00), Fiesta I 1.4, i Flair, Trend, Fun Zetec CVH/PTE, 1.6, i Ambiente', Flair, Forte' Ghia, Rsi, Sport, Trend (97-04), Laser 1.4 L CHV-FUA (86-92), 1.6, i GL, 16, Sport, TX3 B6/ F6 (86-91), Sapphire 2.0, i GL, GLE, GLEA, GLi, GLi Exec. Koln (89-93), Sierra 2.0 GL, GL S/W Koln, 2.0 LX Koln, 2.3 GLE, Cologne (83-93), Honda Ballade SA4 1300 EN4 (82-85), Prelude 1.8 EX ES/ET (84-87), Mazda 121 Soho 1.4i 3/5 Dr. H/back Zetec CVH/PTE (97-99), Rustler 1.4 SWB P/up CVH/FUA Pet., 1.6 SWB, LX P/up CVH/ LUC Pet. (86-94)
<b>426007</b>	Gearbox Oil Seal / Timing Cover / Cam Oil Seal	C.A.M. Inyathi, Jinbei Haise Minibus 2.2i Std. (2007-), Toyota Camry I SXV10/11 R 200i Si 3S-FE, 220 SEi, Si, 5S-FE (92-01), Condor 1.6 Estate, TE, 5L, 1.8 2Y, 2.0i Estate, TE, 1RZ Pet., 2.4i Estate, TE, TX 2RZ-E, 3.0D Estate, TE, 5L Dies. - 4X2, 2.4i Estate, TX Estate 2RZ-E, 3.0 Estate, TX Estate 5L - 4X4 (00-05), Cressida TX30 1.8 DX 3T, TX62 1.8 L, LS 3T, YX70 1.8 LS, Exec. (80-89), GX60 2.0 GLi6 1G-E, GX7 2.0 GLi6 1G-E, 1G-FE (83-92), MX75 3.0i ECT, GLS 7MG-E (86-92), FJ Cruiser 4.0 V6 (2011-), Fortuner 4.0 V6, Epic SUV 1GR-FE Pet. - 4X2, 3.0 D-4D SUV 1KD-FTV, 4.0 V6, Epic SUV 1GR-FE - 4X4 (06-11), 2.5D-4D 2KD-FTV, 3.0D-4D 1KD-FTV - 4X2, 4X4 (11-16), Hiace YH50/60 1.8 SWB / LWB P/van, LS Wagon 2Y Pet. (83-91), YH51/61 2.0 SWB/LWB 16 Seater Commuter, Super 10 Seater Custom Wagon, P/van 3Y Pet. (83-86), YH53/63 2.2 SWB/LWB P/van, Van, LS, GLX, Exec. Wagon 4Y Pet. (All Imp. Models) (86-88), YH53/63 2.2 SWB/LWB P/van, Van, LS, Super T/14/16, GLX, Exec. Wagon, Siyaya Bus, P/van 4Y Pet. (All Local Models) (88-09), Hilux LN30/40/50/51/55 2.2 SWB/LWB P/up L Dies., 2.4 SWB/LWB D/cab, Raider P/up 2L Dies., YN58 2.2 LWB D/cab, Raider, SRX P/up 4Y Pet. (79-98), YN67 2.2 LWB D/cab, Raider D/cab P/up 4Y Pet. - 4X4 (86-94)
<b>426007... Continued</b>	Gearbox Oil Seal / Timing Cover / Cam Oil Seal	Hilux YN51/56 1.8 SWB/LWB D/cab, S, SR, Raider P/up 2Y Pet., YN140 1.8 SWB/LWB D/cab, Raider, S, SRX P/up 2Y Pet. (86-05), LN65 2.4 LWB D/cab, Raider D/cab P/up 2L Dies. - 4X4 (89-98), RN58 2.4 22R Pet., LN140/145 2.4i DLX, P/up 2L Dies., RZN194 2.7i LWB D/cab, Raider, SRX, Legend35 Raider, 3RZFE Pet. (94-05), LN57 2.8D LWB D/cab, Raider P/up 3L Dies. - 4X2 (95-98), LN67 2.8D LWB, D/cab, Raider D/cab P/up 3L Dies. - 4X4 (95-98), LN192R 3.0D LWB Raider D-E, Raider DLX D/cab D-E, Legend35 Raider, P/up 5L Dies., 3.0iD LWB Raider, Raider D/cab, P/up KZ-TE Dies. (98-05), Hilux RZN169 2.7i LWB D/cab, DLX S/cab, Raider S/D/cab, SRX D/cab, Legend 35 LWB P/up 3RZFE Pet, LN167 3.0D D/cab D-E, DLX, S/D/cab DE, Raider DE, Legend35 LWB P/up 5L Dies., 3.0iD LWB Raider S/cab & KZ-TE D/cab P/up, Legend35 - 4X4 (98-05), Land Cruiser FJ80 4.0 DLX, GX, VX P/up 3F/F-E Pet. (90-92), FZJ80 4.5 Std., GX, VX, Turbo S/W, P/up 1FZ-FE Dies., Turbo Dies. (92-95), FZJ80 4.5 Std., GX, VX, Turbo S/W, P/up 1FZ-FE Dies., Turbo Dies. (95-06), FZJ105 4.5 Std., GX, Turbo P/up, S/W 1FZ-FE Dies., Turbo Dies. (95-98), FZJ105 4.5 V8 VX, Turbo P/up, S/W 2UZ-FE Pet. (98-06), HDJ/HZJ80 4.2 GX, Turbo S/W, P/up 1HD-FT, 1HZ Dies., T. Dies. (90-95), HDJ/HZJ80 4.2 Std., GX, VX, Turbo S/W, P/up 1HD-FT, 1HZ Dies., Turbo Dies. (95-01), HDJ100 4.2 Std., GX, VX S/W, 1HZ Pet., 4.5, 4.7 V8 (97-04), HZJ105 4.2 Std., GX DSL, Turbo P/up, S/W 1HZ Dies., Turbo Dies. (98-06), UZJ100 4.5 V8 Std., GX, VX S/W, P/up 2UZ-FE Pet. - 4X4 (98-06), Rav4 I SXA10/11 Series 2.0 3/5 Dr. SWB SUV 3S-FE Pet. - 4X4 (94-01), Stallion YF50 1.8 SR5, P/up, P/van, Van 2Y Pet., LF50 2.4D P/up 2L5F Dies. (87-04), Venture YF50 1.8 8/10 Seater P/van 2Y Pet., 2.2 10 Seater, GLE, Getaway 9 Seater S/W 4Y Pet., LF50 2.4D 10 Seater S/W 2L5F Dies. (91-04)
<b>426010</b>	Timing, Front Wheel Oil Seal	42 X 60 X 10
<b>426207</b>	Gearbox, Timing, Rear Wheel Oil Seal	BMW 7 Series E23 728, i M30, 730 M30, 733i M30, 735i M90 (78-85), Fiat Ulysse 2.0 MPV XU10 J2/Z (99-02), Honda Ballade SR4 180E, i B18B3 (92-98), Peugeot 206 2.0 Hdi (04-06), 306 2.0 Cabrio, XSi XU10J4R/ RS/, XU10J2/K (95-03), 307 2.0 CC, CC 100/ 130/ 180, XS, S/W EW10J4 XS HDi DW10TD (01-08), 405 1.6 GR XU52C/K, 1.8 GR XU7JP/LZ, 2.0 SRi XU7J2/CL (95-97), 406 2.0 Coupe, Estate, SLi, ST, ST Comfort, Estate, STi, Si EW10J4R/XU10J4R/ XU10J2TE (96-05), 605 3.0 V6 SRi ZPJ/LZ (96-98), Renault Clio I, II 3.0 V6 Sport F7R (01-09), Espace 2.0 Authentique Expression, RXE, RXT MPV J7R, F4R, 3.0 L7X727, 3.0 Previl (96-08), Laguna I 3.0 Privilege, RXT L7X731 L7X700 (96-02), Volvo S40 2.0D VS Sedan D4204T (2004-), V50 2.0D B5244S (04-12)
<b>426210</b>	Front Wheel Oil Seal Outer / Timing Cover / Cam Oil Seal	Peugeot 404 1.8, 1618, 2.0 (63-80), VW 411 1.7 (69-74), 412 1.7 (72-74), Kombi 1.7, 1.8, 2.0, 2.0L (72-83)
<b>426210</b>	Timing, Front Wheel Oil Seal	Peugeot 404 (63-80), Volkswagen 411 (69-74), 412 (72-74), Kombi 1.7, 1.8, 2.0, 2.0L (72-83)
<b>426212</b>	Timing Cover, Cam Oil Seal	BMW 2500, 2800, 3.0L, 3.0S (69-78), 333i (85-87), 525, 528, 528i, 530, 535i (74-89), 728, 728i, 730, 730i, 733i, 735i, 745i (78-92), M5 (86-89), M535i (81-85)
<b>426512</b>	Gearbox Oil Seal	Mazda T2000, T3000 (81-86)
<b>426606</b>	Timing Cover, Cam Oil Seal	Citroen C3 1.4i, 1.6i (2002-), C4 1.6 (01-09), Xsara 1.6 (01-06), Berlingo 1.4 (2003-), Peugeot 1007 1.6 (05-08), 206 1.4, 1.6 (01-06), 207 1.4, 1.6 (2006-), 306 1.6 (01-03), 307 1.6 (01-08), 308 1.6i (2008-)
<b>426607</b>	Timing Cover Oil Seal	Peugeot 207 1.4, 1.6 - Alt. (2006-)
<b>436010</b>	Drive Shaft Oil Seal	Peugeot 605 3.0 (96-02), Boxer 2.5TD (02-06)

## BUYERS GUIDE - OIL SEALS

<b>446007</b>	Timing Cover, Cam Oil Seal	Ford Husky 1.8 1 Ton P/up 4G62, 2.0 1 Ton P/up, Bus, P/van 4G63 (85-99), Hyundai Bakkie 2.5i D4BH Dies., 2.6i D4BB Dies. (97-01), Sonata Y3 2.0 G4CP, 2.5 V6 G6BV, 3.0 V6 G6AT (94-04), Mitsubishi Colt LDV 1.6 SWB/LWB Lo-Line P/up 4G32 Pet., 2.0 4G63 Pet., 2.5D 4D56 Dies., 2.6 WB Hi-Line P/up 4G54 Pet. (94-98), 2.5D LWB Hi-Line P/up 4D56 Dies., 2.6 LWB Lo-/Hi-Line, P/up 4G54 Pet. - 4X4 (95-98), 2.0 LWB Std. P/up, 2.0i LWB Hi-Line, 2.4i LWB Hi-Line Rodeo S-/D/cab, Hi-Line/Rider P/up Pet., 2.5D 4D56 Dies. (98-09), 2.4i LWB Hi-Line D/cab, Trailbuster S/cab, P/up Pet. - 4X4 (99-09), L300 1.6 Mini Bus, Van 4G32 Pet., 1.8 4G62 Pet., 2.0 P/up 4G63 Pet., Starwagon 2.0 S, SL, SLE, P/up, P/van 4G63 Pet. (82-01), Outlander 2.4 GLS MPV & SUV 4G69 - 4X4 (03-08), Triton 2.4 MPI D/cab P/up, 2.5 Di-D C/cab P/up, 2.5 Di-D D/cab P/up (2007-)
<b>446010</b>	Gearbox Oil Seal Rear	BMW 3 Series E36 M3 Coupe 6 Cyl. (01-04), E36 316i 1.8 Dolphin Shape M40, 318i 1.9 M44, 320i 2.0 M50, 323i 2.5 M52, 325i M50, 328i 2.8, 3.0 M52, Z3 2.8, 3.0 Roadster (92-00), E37 M3 M Coupe S50 (93-01), E46 316i 1.8 M40, 318i M43, 320i, d M54/47, 323i M52, 325i, it M50, 328i M52TU (98-05)
<b>455707</b>	Timing Cover, Cam Oil Seal	Volvo C70 2.5T, S40 2.0T (97-04), V40 2.0T (98-04), V70 2.0T, 2.5T (04-07), XC70 2.5T (03-07), XC90 2.4, 2.5T (04-09)
<b>455910</b>	Front Wheel Oil Seal	Fiat 125, 131, 132 (69-80)
<b>456008</b>	Drive Shaft Oil Seal / Timing Cover Oil Seal	Audi 100/4 1.6 LS YV, 100/5 1.9 WH, 200 2.1 GLS, GLX, 400 1.8 JW, 500 2.1/2.2 WB, WC SE PR (77-92), 500 2.2 E PR, 2.3 E, SE, AAR, 2.8 SEL AAH (92-94), A3 2.0 FSi BVZ, 2.0 FSi 8PA Sportback BLX, 2.0 TFSi CCZA, CBFA, 2.0 TDi BMM, CLJA, 3.2 Quattro, DSG, BUB (03-13), A4 1.8 8D2, B5 Exec ADR, 1.8T APU (95-01), 2.4 Multitronic, BDV, 2.5 TDi 8D/E2 Quattro AFB, Quattro Tiptronic, 2.6 8D2 / 8D5 Exec., 3.0 Quattro Tiptronic, ASN, 3.0 Cabriolet ASN, 8H7, 3.0 TDi 8EC Quattro BKN, 3.0 TDi Quattro Avant Tiptronic, BKN, ASB (02-08), A6 A6 2.8 Quattro 4A, AAH, ACK, 3.0 Quattro Tiptronic BBJ (94-00), 2.4 Avant Multitronic., Tiptronic, AGA, ALF, AML, APS, ARJ, 2.5TDi Multitronic Avant SW., BCZ/BDG/BFC, 2.6 ABC (97-03), 4.2 Quattro Tiptronic ARS (00-08), A8 3.7 Tiptronic AQG, 4D2, 4.2 Quattro 4E2/8 BFM (95-02), S3 1.8T 8L1 Quattro AMK, BAM, APY (00-04), S4 2.2T Quattro AAN (92-95), 4.2 Quattro, Avant 8E2/E5, S/W, BBK, AQF (03-08), VW Amarok 2.0 Tsi, 2.0 Tdi, 2.0 Bi-Tdi - 4X2 (10-16), CC 2.0Tsi, 2.0TDi, 3.6 V6 FSi 4Motion (2009-), Golf VI 2.0i GTi, Tiptronic (09-13), Kombi T2 2.0, L Exec., Microbus, Kamper, P/up, P/van CU, CJ Pet., T3 1.9 Microbus, P/van DG Pet. (84-89), T3 2.1 Fi Caravelle, Microbus DJ Pet., 2.3i Microbus, Volksiebus AFU Pet., 2.5i Microbus, Caravelle AAY Pet., 2.6i Microbus, Caravelle, Exclusive, ADV Pet. - 4X2 (85-04), T3 2.1 Fi Syncro Caravelle DJ Pet. - 4X4 (89-93), T4 2.5Tdi Microbus, Caravelle, Trend, High ACV, AAB Dies., Turbo Dies. (99-06), Passat I & II 1.3 L, LS H/back, Sedan, Variant ZF, 1.5 GL, LS Fastback, S/W CK, 1.6 GL, GLS, LS, LX Fastback, S/W, Sedan, Coupe, Variant, YN/YP/WN, 1.8 CL Sedan, S/W JV/KR (74-87), 1.9 GLS H/back, GLX Sedan, S/W WN, 2.2 CLi, CLX SG/MX (81-87), Passat IV 1.8T AEB (99-05), 2.3 V5 AZX (03-05), 2.8, 4 Motion, Quattro, Tiptronic ACK/ AMX, 3.2 V6 Sportline DSG AXZ (99-05), Passat V 1.9TDi Comfortline AVB, 2.0FSi Comfortline, Tipt., Highline BCR BLY, 2.0 T FSi Sportline Tiptronic AXX/BPY, 2.0TDi Highline, DSG BKP/BMP, 3.2 V6 Auto. DSG (05-11), Passat B7 1.8Tsi, 2.0Tsi, 2.0TDi (08-11), Scirocco 2.0Tsi (2009-), Sharan 1.8T MPV AJH, 2.8 MPV AAA (99-08)
<b>456009</b>	Timing Cover, Cam Oil Seal	Chevrolet Commodore (1982), Opel (82-88), Manta (71-76), Rekord 2.2 (86-91), Senator 3.0 (82-86)
<b>456010</b>	Timing Cover Oil Seal	Opel Rekord 2.0 (82-95)
<b>456207</b>	Front Wheel Oil Seal	BMW 1800Sa, 1804, 2000Sa, 2004, 2500, 2800, 3.0L, 3.0S, 518, 518i, 520, 520i, 525, 528, 528i, 530
<b>456208</b>	Timing Cover / Cam Oil Seal	Toyota Cressida 2.0 (82-92)
<b>456210</b>	Timing Cover, Cam Oil Seal	Daihatsu Rocky, Mercedes-Benz, Opel Kadett, Peugeot 504, 505, 404, VW Beetle, Variant, Kombi
<b>456412</b>	Front Wheel Oil Seal	Mercedes Benz 190E 1.8, 2.0, 2.3 (93-94), 280E (93-96)
<b>456505</b>	Front Wheel Oil Seal	Mazda B1500, B1600, B1800, B2000, B2200 (67-86)
<b>456507</b>	Timing Cover / Cam Oil Seal	Volvo C30 2.5 (2008-), C70 2.3 (02-04), S40 2.4, V50 2.4 (04-09), S/V70 2.3, 2.4 (97-01), S80 2.4T, 2.5T (02-06), S90 2.9, V90 2.9 (97-00), V70 2.4, XC70 2.4 - 4X4 (00-09)
<b>456510</b>	Timing Cover / Cam Oil Seal	BMW 520i, 540i (85-96), VW Sharan 1.8T, 1.9TDi, 2.8 (99-09), Kombi 2.5 Tdi, 2.8i (99-04)
<b>456812</b>	Gearbox Oil Seal Rear	Mitsubishi Colt LDV 3.0i V6 LWB Rodeo D/cab P/up Pet. - 4X2, 4X4 (99-09), Nissan E20 2.0 Bus, Van H20 (80-96), Cressida TX30 1.8 DX 3T, TX62 1.8 L, LS 3T, YX70 1.8 LS, Exec. (80-89), RX60 2.0 GL, GLE, GLX, S/W 21R, RX70, YX72 2.0 GL, GL, GLE, GLX (81-92), GX60 2.0 GLi6 1G-E, GX7 2.0 GLi6 1G-E, 1G-FE (83-92), MX63 2.8i 5M-E (84-89), RX72 2.4 GL, GL S/W, GLE, GLE S/W 22R, RX73 2.4 GLE, GLE S/W 22R With I.R.S. (Independent Rear Suspension) (87-92), Hilux RN67 2.4 LWB D/cab, Raider D/cab P/up 22R Pet. (94-98), RN58 2.4 22R Pet., LN140/145 2.4i DLX, P/up 2L Dies., RZN194 2.7i LWB D/cab, Raider, SRX, Legend35 Raider, 3RZFE Pet. (94-05), Stout RK110 2.0 SWB P/up 5R Pet. (79-89)
<b>457215</b>	Pinion Oil Seal	VW Kombi 1.6, 1.8, 1.9, 2.0, 2.0L, 2.1 Fi, 2.3i, 2.5i, 2.6i, 4X4 2.1 Fi (75-04)
<b>457510</b>	Pinion Oil Seal	BMW E90 Series (05-11), E28 Series (85-89), E31 Series (91-94), E32 Series (87-95), E38 Series (95-03), X3 (04-06), X5 (2005-), F30 320i, 320d, 330i, F34 Gran Turismo 320d 2.0 (2015-)
<b>457512</b>	Pinion Oil Seal	Nissan 720 D20 1.8 L18S Kingcab, Sport, 2.2D SD/Z22 Tracker, 2.3 SD23 - 4x2, 1.8 L18S, 2.0 NA20, 2.2 Z22 - 4x4 (80-88), E20 1.8 L18 Bus, P/van Coach, Coach GL, GLE, Econolux, Ekonovan, Ekonowagon, 2.0 Bus, Van H20 (80-96), Laurel C31 2.0 CA/L20, 2.8 SGL 5L28 (80-87), Skyline R30 2.0 GL L20 (82-87)
<b>476209</b>	Rear Wheel Oil Seal Inner	Suzuki Jimny 1.3i - 4X4 (2008-)



# BUYERS GUIDE - OIL SEALS

<b>486207</b>	Drive Shaft Oil Seal	Audi A3 1.4 T Fsi (13-17), Tt 1.8, 1.8T (00-06)
<b>486208</b>	Drive Shaft, Gearbox Oil Seal	Audi A3 2.0 FSi BVZ, 2.0 FSi 8PA Sportback BLX, 2.0 TFSi CCZA, CBFA, 2.0 TDi BMM, CLJA, 3.2 Quattro, DSG, BUB (03-13), 1.4 TFSi CMSA, 1.6 TDi CAYC (08-13), A4 2.0 Multitronic Avant 8EC, 8E2 ALT, 2.0 TDi 125, 8EC BLB, Avant Multitronic, 2.0TFSi DTM 147 BGB, 3.2 FSi Quattro, 8EC Multitronic Avant, Tiptronic Avant, AUK (00-08), TT 2.0 TFSi BWA, 2.0 TTS Quattro CDLA, CDMA (04-10), 1.8 TFSi CDAA, 2.0 TFSi Quattro CCSA, CETA, 2.5 RS Quattro CEPA (10-15), Seat Ibiza 1.4 Sport, BXW, 1.6 Sport, BAH, 1.8T Cupra, BBU, 1.9TDi 96, 118 Cupra, 2.0 AZL, BBX, BPX, BLK, ASZ, BLT (06-09), Leon 2.0 Fsi, 2.0T, FSi Cupra, 2.0T Fsi, 2.0TDi (06-09), Toyota Land Cruiser FZJ/HZJ75 4.2 GX S/W, P/up 1FZF/HZ Dies. (91-97), FZJ80 4.5 Std., GX, VX, Turbo S/W, P/up 1FZ-FE Dies., Turbo Dies. (92-95), FZJ80 4.5 Std., GX, VX, Turbo S/W, P/up 1FZ-FE Dies., Turbo Dies. (95-06), FZJ105 4.5 Std., GX, Turbo P/up, S/W 1FZ-FE Dies., Turbo Dies. (95-98), FZJ105 4.5 V8 VX, Turbo P/up, S/W 2UZ-FE Pet. (98-06), HDJ/HZJ80 4.2 GX, Turbo S/W, P/up1HD-FT, 1HZ Dies., T. Dies. (90-95), HDJ/HZJ80 4.2 Std., GX, VX, Turbo S/W, P/up 1HD-FT, 1HZ Dies., Turbo Dies. (95-01), HDJ100 4.2 Std., GX, VX S/W, 1HZ Pet., 4.5, 4.7 V8 (97-04), HZJ105 4.2 Std., GX DSL, Turbo P/up, S/W 1HZ Dies., Turbo Dies. (98-06), UZJ100 4.5 V8 Std., GX, VX S/W, P/up 2UZ-FE Pet. - 4X4 (98-06), VW Caddy 1.6i Life Van, MPV BGU, 1.9TDi Life, Maxi Van, MPV BJB, 2.0SDi Van, P/van BDJ, 2.0TDi (2004-), Golf V 1.6i Comfortline, Tiptronic, Trendline BGU, 1.9TDi Comfortline, Highline (04-09), Golf VI 1.4TSi Comfortline, Trendline, Highline, 1.6i Comfortline, Trendline, 1.6TDi, 2.0i GTi, Tiptronic, 2.0TSi 4Motion, 2.0TDi Highline, DSG (09-13), Jetta V 1.4TSi, 1.6TDi, 1.6i Comfortline, Tiptronic, Trendline, 1.9TDi Comfortline, Comfortline DSG, 2.0i Trendline, Comfortline, 2.0FSi Sportline, 2.0 T FSi Sportline DSG, 2.0TDi Sportline (2006-), Scirocco 1.4TSi, 2.0TSi, DSG, 2.0TSi R (2009-), Tiguan 2.0TSi Track&Field, Sport&Style Man., Tiptronic 5Dr. SUV, 2.0TDi Track&Field, Sport&Style Man., Tiptronic 5Dr. SUV - 4X4 (08-17), Touran 1.9TDi TrendLine DSG MPV, 2.0FSi HighLine MPV AXW, 2.0TDi HighLine, DSG MPV (04-11)
<b>486209</b>	Rear Wheel Oil Seal Outer	Toyota Cressida 2.0, 2.4, 2.8i, 3.0, 3.0i (82-92)
<b>486210</b>	Front, Rear Wheel Oil Seal	Chana Star 1.0 P/up, 1.3 P/up (06-12)
<b>486412</b>	Front Wheel Oil Seal	Mercedes-Benz W124 E Class E200 M102.922, E220 M111.960, E320 Sportline, M104.992 (93-96), R170 SLK200, SLK320 M112.947 (97-02), R170 SLK200K M111.958, SLK320, SLK32 AMG M112.960 (02-04), W202/3 C-Class C180 Classic M111.920, C200 M111.941, C220 M111.961, C230 M111.974, C240 M111.944, C250 M605.910, C270CDi M612.962, C280 M104.941 (94-08), W208 CLK230, M111.973, CLK320, M112.940, CLK430, CLK500 (98-03), W210 E-Class E200, K M111.941/956, E230 M111.970, E240 M112.911, E280 M112.921, E320 M112.941, E320CDi OM646.961, E350 M272.964, E500 M113.967 (96-10)
<b>486510</b>	Timing Cover Oil Seal / Rear Wheel Oil Seal	Alfa Romeo 155 2.5 V6 AR67301 (96-99), GTV / Spider 3.0V6 (99-04), BMW 3 Series E46 316i 1.8 M40, 318i M43, 320i, d M54/47, 323i M52, 325i, it M50, 328i M52TU (98-05), 5 Series E28 520i 2.0 M20, 525e 2.5 M30, 528i 2.8 M30, 535i 3.0 M30 (85-89), E34 520i 2.0 M50, 525i 2.5 M50, 530i 3.0 M60, 535i 3.5 M30, 540i 4.0 M60 (90-00), E39 523i 2.5 M52, 525i 2.5 M54, 528i 2.8 M52, 530i, d 3.0 M54/ M57, 540i 4.4 M62 (98-04), M5 V8 Coupe (99-03), X3 E83 2.5i SUV M54, E83LCi, 2.5si SUV N52N - 4X4 (04-07), X5 E53/70 3.0i SUV M54, 4.6iS SUV M62 - 4X4 (2001-), C.A.M. Rhino 2.2i, 2.8i (2007-), Mitsubishi Colt LDV 1.6 SWB/LWB Lo-Line P/up 4G32 Pet., 2.0 4G63 Pet., 2.5D 4D56 Dies., 2.6 WB Hi-Line P/up 4G54 Pet. (94-98), 2.5D LWB Hi-Line P/up 4D56 Dies., 2.6 LWB Lo-/Hi-Line, P/up 4G54 Pet., 3.0 V6 LWB Lo-/Hi- Line D/cab, Rodeo 6G72 Pet. - 4X4 (95-98), Pajero 2.8 Tdi, 3.0 V6 SWB GLS Wagon 6G72 Pet., 3.5 V6 SWB GLS Wagon 6G74 Pet. - 4X4 (90-01)
<b>486807</b>	Timing Cover / Cam Oil Seal	Toyota Hilux RZN194 2.7i LWB D/cab, Raider, SRX, Legend35 Raider, 3RZFE Pet. (98-05), LN67 2.8D LWB, D/cab, Raider D/cab P/up 3L Dies. - 4X4 (95-98), RZN147 2.0 SWB/LWB D/cab, DLX, Raider, S, SR, SRX P/up 1RZ Pet. (98-05), Hilux "Vigo" 2.0i U16/17 S/Cab, S, SRX LWB Pet. P/up 1TR-FE Pet., 2.7i S/Cab Raider, D/Cab Raider, S/Cab HO Raised Body LWB P/up 2TR-FE Pet. - 4X2 (05-11), 2.0i S/Cab, S, SRX LWB Pet. P/up 1TR-FE Pet., 2.5TDi D-4D S/Cab, S, SRX, S/Cab, S/Cab SRX HO, Raised Body Raider, D/Cab LWB P/up 2KD-FTV, 2.7i Raised Body Raider, D/Cab LWB P/up 2TR-FE Pet. (09-11), Hilux 2.0 VVTi 1TR-FE 5 Spd Man. S/cab, 2.7 VVTi 2TR-FE - 4X2 (11-16), Quantum 2.7 "Family", S-long "Ses'fikile" MPV, Van 2TR-FE Pet. (2005-)
<b>486810</b>	Timing Cover / Cam Oil Seal	Mazda B-Series B2600 2.6 LWB D/cab, Magnum, Drifter P/up 4G54 Pet. - 4X2, 4X4 (86-95), Mitsubishi Canter 2.5 SWB/LWB D/side, Chassis cab 4G55 Dies., 2.6 4G54 Pet. (80-97), Colt LDV 3.0 V6 LWB Lo-/Hi- Line D/cab, Rodeo 6G72 Pet. - 4X4 (95-98), Pajero 2.8 Tdi, 3.0 V6 SWB GLS Wagon 6G72 Pet., 3.5 V6 SWB GLS Wagon 6G74 Pet. - 4X4 (90-01), VW Kombi T3 1.9 Microbus, P/van DG Pet. (75-89), T3 2.1 Fi Caravelle, Microbus DJ Pet. - 4X2 (85-04), 2.1 Fi Syncro Caravelle DJ Pet. - 4X4 (89-93)

## BUYERS GUIDE - OIL SEALS

<b>487009</b>	Rear Wheel Oil Seal	Isuzu KB20 1.6 P/up G161Z Pet., KB21 1.6 P/up G161Z Pet., KB22 1.8 P/up G180Z Pet., KBD20 2.0 P/up C190, KBD21 2.0 P/up C190, KBD22 2.2 LE, P/up C223, KB23 2.0 P/up G200Z, KB24 2.3 LE 4ZD1, KB25 1.6 P/up G161Z, KB26 1.6 P/up G161Z, 1.8 P/up G180Z, KBD23 2.5 LE, P/up 4JA1, KBD25 2.0 P/up C190 (78-89), KBD26 2.0 P/up C190, KBD27 2.2 C223, KBD28 2.5 4JA1 (81-89), KB27 1.8 P/up G180Z, KB28 2.0 P/up G200Z, KB29 2.3 P/up 4ZD1 (83-89), KB40 1.6 G161Z, KB41 1.6 G161Z, 1.8 G180Z, KB42 1.8 G180Z, KB43 2.0 G200Z, KB44 2.3 4ZD+1, KBD40, KBD41 2.0 P/up C190, KBD42 2.2 P/up C223 - 4X4 (79-89), KB250D 2.5 Fleetside, LE, D/Cab P/up 4JA1, KB280DT 2.8 D/cab LE, LX, Frontier P/up Turbo 4JB1 (89-04), Relay 2.0 P/van, Bus 4ZC1 (Import) (89-95), Nissan 1-Tonner/Hardbody AW/D21 1.6 L16S-J, 1.8 L18S-R, 2.0 NA20, 2.4 Z24/S - 4X2, 2.4 Z24S - 4X4 (88-98), 720 D20 1.8 L18S Kingcab, Sport - 4X2, 1.8 L18S, 2.0 NA20, 2.2 Z22 - 4X4 (80-88), E20 1.8 L18 Bus, P/van Coach, Coach GL, GLE, Econolux, Ekonovan, Ekonowagon (80-96), Hardbody QW/D22 2.0 NA20S, 2.0i KA20 (98-04), Laurel C31 2.8 SGL 5L28 (80-87), Sani AW/D21 2.4, i Z24 - 4X2, 2.2 Z22, 2.4 Z24 - 4X4 (86-99), Stanza 1.6 DL, Resort, S/W L16, 1.8 GL, Resort, S/W SSS L18 (80-84), Skyline R30 1.8 L18, 2.0 GL L20 (82-87)
<b>487012</b>	Timing Cover / Cam Oil Seal	Mazda Capella (74-79), Luce 573 (75-78), B1600, B1800, B2000 (71-86), Toyota Cressida 2.8i (86-89)
<b>487279</b>	Rear Wheel Oil Seal	VW Kombi 1.6, 1.7, 1.8, 1.9, 2.0, 2.0L, 2.1 Fi, 2.3i, 2.5i, 2.6i, 4X4 2.1 Fi (67-04)
<b>487410</b>	Drive Shaft Oil Seal	Mitsubishi Colt Ldv 2.4i, 2.8D, 3.0i (98-09)
<b>488212</b>	Pinion Oil Seal	Toyota Dyna 3.7, 4.0 (95-02)
<b>506508</b>	Drive Shaft, Front Wheel Oil Seal	Audi A3 2.0 FSi BVZ, 2.0 FSi 8PA Sportback BLX, 2.0 TFSi CCZA, CBFA, 2.0 TDi BMM, CLJA, 3.2 Quattro, DSG, BUB (03-13), MM, CLJA, 3.2 Quattro, DSG, BUB (03-13), 1.4 TFSi CMSA, 1.6 TDi CAYC, 1.8 TFSi CDAA, 1.9 TDi BXE (08-13), A4 2.0 Multitronic Avant 8EC, 8E2 ALT, 2.0 TDi 125, 8EC BLB, Avant Multitronic, 2.0TFSi DTM 147 BGB (00-08), Seat Ibiza 1.4 Sport, BXW, 1.6 Sport, BAH, 1.8T Cupra, BBU, 1.9TDi 96, 118 Cupra, 2.0 AZL, BBX, BPX, BLK, ASZ, BLT (06-09), Leon 2.0 Fsi, 2.0T, FSi Cupra, 2.0T Fsi, 2.0TDi (06-09), VW Beetle 2.0i Cabriolet, Highline AZJ (00-12), Golf IV 1.6i Comfortline, Std., Estate AKL (99-04), Golf V 1.6i Comfortline, Tiptronic, Trendline BGU, 1.9TDi Comfortline, Highline, 2.0i Comfortline, GTi, GTi Trendline DSG/ AXX/BWA, 2.0FSi Sport, Sport Tiptronic AXW, 2.0TDi, Sport DSG/ BKD (04-09), Golf VI 1.4TSi Comfortline, Trendline, Highline, 1.6i Comfortline, Trendline, 1.6TDi, 2.0i GTi, Tiptronic, 2.0TSi 4Motion, 2.0TDi Highline, DSG (09-13), Jetta IV 1.6i Comfortline, Std. AKL (99-06), Jetta V 1.4TSi, 1.6TDi, 1.6i Comfortline, Tiptronic, Trendline, 1.9TDi Comfortline, Comfortline DSG, 2.0i Trendline, Comfortline, 2.0FSi Sportline, 2.0 T FSi Sportline DSG, 2.0TDi Sportline (2006-), Jetta VI 1.2TSi, 1.4TSi, 1.6TDi, 2.0TDi (2011-), Kombi T5 1.9TDi Beach, Van, P/van, S/Cab P/up SWB, D/Cab P/up LWB, Crew Bus AXC Dies., 2.5TDi Beach, California, Caravelle, 96/128, S/Cab, D/cab, HO P/up SWB/ LWB P/up, Crew Bus P/van, Van, AXD Dies., 3.2 Caravelle, S/Cab, D/cab P/up BDL (04-10), Polo 9N 1.9TDi Highline, Classic Highline, Sportline, ATD/ AXR, 2.0i Highline, Classic Highline BBX (02-10), Polo 9N 1.9TDi Highline, Classic Highline, Sportline, ATD/ AXR, 2.0i Highline, Classic Highline BBX (02-10), Scirocco 1.4TSi, 2.0TSi, DSG, 2.0TSi R (2009-), Tiguan 1.4TSi Trend&Fun 5Dr. SUV, 2.0TSi, 2.0TDi - 4X2, 1.4TSi Track&Field, Trend&Fun 5Dr. SUV, 2.0TSi Track&Field, Sport&Style Man., Tiptronic 5Dr. SUV, 2.0TDi Track&Field, Sport&Style Man., Tiptronic 5Dr. SUV - 4X4 (08-17)
<b>506509</b>	Gearbox, Front Wheel Oil Seal	Ford Husky 1.8 1 Ton P/up 4G62, 2.0 1 Ton P/up, Bus, P/van 4G63 (85-99), Hyundai Bakkie 2.5i D4BH Dies., 2.6i D4BB Dies. (97-01), H100 P/Van 2.5i D4BH Dies., 2.6i D4BB Dies. (00-07), Mitsubishi Colt LDV 1.6 SWB/LWB Lo-Line P/up 4G32 Pet., 2.0 4G63 Pet., 2.5D 4D56 Dies., 2.6 WB Hi-Line P/up 4G54 Pet., 2.8D LWB Std., Hi line P/up Dies., 2.8TDi LWB Club CabS cab, Turbo, 3.0i V6 LWB Club S/cab P/up Pet. (94-98), 2.0 LWB Std. P/up, 2.0i LWB Hi-Line, 2.4i LWB Hi-Line Rodeo S-/D/cab, Hi-Line/Rider P/up Pet., 2.5D 4D56 Dies. (98-09), 2.4i LWB Hi-Line D/cab, Trailbuster S/cab, P/up Pet. - 4X4 (98-09), 2.8TDi LWB Pioneer, Rodeo D/cab P/up Turbo Dies., 3.0i V6 LWB Rodeo D/cab P/up Pet. (99-09), L300 1.6 Mini Bus, Van 4G32 Pet., 1.8 4G62 Pet., 2.0 P/up 4G63 Pet., Starwagon 2.0 S, SL, SLE, P/up, P/van 4G63 Pet. (82-01), Renault Laguna I 2.0 RT, RT Estate, RXE, Expression K4M720/724, N7Q700 (96-07), Megane II 1.9dCi CC, Dynamique, Privilege, Dynamic + F9Q800, 2.0 Classic Dynamique, Dynamique + , Privilege, CC Privilege, GT F7R710 /-77, 2.0T Sport, F1 Team R26 LE, SE, Coupe Dynamique (02-10), Scenic I 2.0 RXE, RXi (98-02)
<b>506510</b>	Drive Shaft Oil Seal	Seat Ibiza 1.8T, 2.0, Leon 2.0FSi, T, T FSi, TDi (06-08)
<b>506709</b>	Front Wheel Oil Seal	C.A.M. Rhino 2.8i (2007-), Isuzu KBD20 2.0 P/up C190, KBD21 2.0 P/up C190, KBD22 2.2 LE, P/up C223 (87-89), KB27 1.8 P/up G180Z, KB28 2.0 P/up G200Z, KB29 2.3 P/up 4ZD1 (83-89), KB160 1.6 Fleetside P/up, KB200 2.0 LE, Fleetside, D/cab P/up, KB220 2.2 LE, P/up, KB230 2.3 D/cab P/up (89-04), KB260 2.6 LE, D/cab, LX P/up 4ZE1, KB320 3.2 LE, D/cab, LX, Frontier, Reef, Blazer P/up 6VD1 (92-04), KB200i 2.0 LX, KB240i 2.4 LX, KB250i 2.5 LX (04-12), KB250D 2.5 Fleetside, LE, D/Cab P/up 4JA1, KB280DT 2.8 D/cab LE, LX, Frontier P/up Turbo 4JB1 (89-04), KB250i 2.5 LX, KB250Dc 2.5, KB300TDi 3.0 LX (04-09), KB300TDi 3.0 D-TEQ (07-11)
<b>506711</b>	Rear Wheel Oil Seal	GWM Steed 3 2.2i S/Cab, D/Cab (10-13), Nissan 720 D20 1.8 L18S Kingcab, Sport, 2.2D SD/ Z22 Tracker 2.3 SD23 - 4X2, 1.8 L18S, 2.0 NA20, 2.2 Z22 - 4X4 (80-88), E20 1.8 L18 Bus, P/van Coach, Coach GL, GLE, Econolux, Ekonovan, Ekonowagon, 2.0 Bus, Van H20 (80-96)
<b>506808</b>	Front, Rear Wheel Oil Seal	Tata Safari 2.2 CRDi GLS Diesel (2007-), Super Ace 1.4TD (2012-), Telcoline 2.0 Turbo Dies. S/ Cab P/up (04-10), Xenon 2.0TDi, 3.0TDi (2008-)



## BUYERS GUIDE - OIL SEALS

<b>506809</b>	Timing Cover / Cam Oil Seal	C.A.M. Inyathi, Jinbei Haise Minibus 2.2i Std., Rhino 2.2i, 2.8i (2007-), Renault R9 1.7 TX, TXE F2/3N (83-86), Toyota Hiace YH50/60 1.8 SWB / LWB P/van, LS Wagon 2Y Pet. (83-91), YH51/61 2.0 SWB/LWB 16 Seater Commuter, Super 10 Seater Custom Wagon, P/van 3Y Pet. (83-86), YH53/63 2.2 SWB/LWB P/van, Van, LS, GLX, Exec. Wagon 4Y Pet. (All Imp. Models) (86-88), YH53/63 2.2 SWB/LWB P/van, Van, LS, Super T/14/16, GLX, Exec. Wagon, Siyaya Bus, P/van 4Y Pet. (All Local Models) (88-09), Hilux LN30/40/50/51/55 2.2 SWB/LWB P/up L Dies., 2.4 SWB/LWB D/cab, Raider P/up 2L Dies., YN58 2.2 LWB D/cab, Raider, SRX P/up 4Y Pet. (79-98), YN51/56 1.8 SWB/LWB D/cab, S, SR, Raider P/up 2Y Pet., YN140 1.8 SWB/LWB D/cab, Raider, S, SRX P/up 2Y Pet. (86-05), RN58 2.4 22R Pet., LN140/145 2.4i DLX, P/up 2L Dies. (94-98), LN57 2.8D LWB D/cab, Raider P/up 3L Dies. - 4X2 (95-98), RZN147 2.0 SWB/LWB D/cab, DLX, Raider, S, SR, SRX P/up 1RZ Pet. (98-05)
<b>506810</b>	Timing Cover / Cam Oil Seal	Toyota Land Cruiser 120 3.0iD, 4.0i V6 (02-09)
<b>507009</b>	Rear Wheel Oil Seal	GWM Double Cab Lux 2.2 TDi, MPI, Standard (2007-), Toyota Fortuner 3.0 D-4D SUV 1KD-FTV, 4.0 V6, Epic SUV 1GR-FE - 4X2, 4X4 (06-09), Hiace YH51/61 2.0 SWB/LWB 16 Seater Commuter, Super 10 Seater Custom Wagon, P/van 3Y Pet. (83-86), YH53/63 2.2 SWB/LWB P/van, Van, LS, GLX, Exec. Wagon 4Y Pet. (All Imp. Models) (86-88), Hilux LN30/40/50/51/55 2.2 SWB/LWB P/up L Dies., 2.4 SWB/LWB D/cab, Raider P/up 2L Dies., YN58 2.2 LWB D/cab, Raider, SRX P/up 4Y Pet. (79-98), YN67 2.2 LWB D/cab, Raider D/cab P/up 4Y Pet. - 4X4 (86-94), YN51/56 1.8 SWB/LWB D/cab, S, SR, Raider P/up 2Y Pet., YN140 1.8 SWB/LWB D/cab, Raider, S, SRX P/up 2Y Pet. (86-05), LN65 2.4 LWB D/cab, Raider D/cab P/up 2L Dies., RN67 2.4 LWB D/cab, Raider D/cab P/up 22R Pet. - 4X4 (89-98), RZN169 2.7i LWB D/cab, DLX S/cab, Raider S/D/cab, SRX D/cab, Legend 35 LWB P/up 3RZFE Pet, LN167 3.0D D/cab D-E, DLX, S/D/cab DE, Raider DE, Legend35 LWB P/up 5L Dies., 3.0iD LWB Raider S/cab & KZ-TE D/cab P/up, Legend35 - 4X4 (98-05), Hilux "VIGO" 2.0i U16/17 S/Cab, S, SRX LWB Pet. P/up 1TR-FE Pet., 2.5TDi D-4D S/Cab, S, SRX, S/Cab, S/Cab SRX HO, Raised Body Raider, D/Cab LWB 2KD-FTV, 3.0 D-4D TDi Raider, D/C Raider, Raised Body LWB P/up 1KD-FTV Dies., 4.0i D/Cab Raider Raised Body LWB P/up GR-FE Pet. - 4X2, 4X4 (05-09), 2.7i S/Cab Raider, D/Cab Raider, S/Cab HO Raised Body LWB P/up 2TR-FE Pet. - 4X2 (05-11), 2.5TDi D-4D S/Cab, D/Cab SRX, Legend40 2KD-FTV Dies. LWB P/up, 2.7i S/Cab SRX, Legend40 2TR-FE Pet. LWB P/up - 4X4 (05-15), Quantum 2.5 D-4D, "Family", S-long MPV, Van 2KD-FTV Dies., 2.7 "Family", S-long "Ses'fikile" MPV, Van 2TR-FE Pet. (2005-)
<b>507013</b>	Front Wheel Oil Seal	Mercedes-Benz W123 200 M115.938/9, 230, E M115.954, 240D M616.912, 250 M123.920/1, 280E M110.983, 300D M617.912 (77-86), W126 280SE M110 987/9, 300SE M103.981, 380SE M116.963, 420SE M116.965, 500SE M117.965 (86-93)
<b>507212</b>	Timing Cover / Cam Oil Seal	Toyota Land Cruiser PHJ75 3.9 DLX, GX, GX Turbo P/up Perkins236 2H Dies., FJ75 4.0 DLX, GX, VX 3F/F-E Pet., (85-92)
<b>507411</b>	Timing Cover / Cam Oil Seal	Mitsubishi Colt LDV 2.5D LWB Hi-Line P/up 4D56 Dies., 2.6 LWB Lo-/Hi-Line, P/up 4G54 Pet., 3.0 V6 LWB Lo-/Hi-Line D/cab, Rodeo 6G72 Pet. - 4X4 (95-98), Pajero 3.2 DI-D - 4X4 (02-07), 3.2 DI-D, 3.2 DI-DC 4M41 - 4X4 (2007-), Triton 3.2 Di-D D/cab P/up, 3.5 Club cab P/up, 3.5 MPI Double cab P/up - 4X2, 4X4 (2007-)
<b>507509</b>	Rear Wheel Oil Seal Outer	Mitsubishi Colt LDV 2.8D, 2.8TD - 4X2, 2.4i, 2.8D, 3.0i - 4X4 (98-09), Triton 2.4, 2.5DiD, 2.2DiD, 3.5 V6 P/up (2007-)
<b>516507</b>	Timing Cover/ Cam Oil Seal	Volvo C30 2.5 (2008-), C70 2.3 (02-04), S40 2.4, V50 2.4 (04-09), S70 2.3, 2.4 (97-01), S80 2.4T, 2.5T (02-06), S/V90 2.9 (97-00), V70 2.3, 2.4, T, 2.5T (00-06), XC70 2.4 (00-07)
<b>526509</b>	Rear Wheel Oil Seal Inner	Toyota Corolla 1.6 (Import) (83-89)
<b>546513</b>	Front Wheel Oil Seal	Nissan 1-Tonner/Hardbody AW/D21 1.6 L16S-J, 1.8 L18S-R, 2.0 NA20, 2.4 Z24/S, 2.5D TD25i, 2.7D TD27, 3.0 VG30E (88-98), 720 D20 1.8 L18S Kingcab, Sport, 2.2D SD/Z22 Tracker, 2.3 SD23 - 4X2 (80-88), Hardbody QW/D22 2.0 NA20S, 2.0i KA20, 2.4i Z24, KA24E/DE, 2.7D TD27i, 3.0 i VG30E, 3.0TD ZD30, 3.2 QD32, 3.3i VG33E - 4X2, 2.4i KA24E, 2.7 TD27, 3.0 VG30E, 3.0TD ZD30, 3.2, 3.2D QD32, 3.3i VG33 - 4X4 (98-11), NP300 D22 2.0i, S, SE KA20, 2.5TDi, S, SE YD25 (2008-)
<b>546808</b>	Drive Shaft Oil Seal / Front Wheel Oil Seal Inner	Audi S3 2.0TFSi (07-13)
<b>547308</b>	Drive Shaft Oil Seal	Audi A3 1.6, 3.2 (2003-), A4 3.2, FSi (2001-), S3 2.0TFSi CJXB (13-17), TT 3.2 (04-06), Seat Altea 2.0FSi,TDi (06-08), VW Touran 1.9TDi, 2.0FSi, TDi (2004-)
<b>557008</b>	Front Wheel Oil Seal	Opel Kadett E 2.0 GSi 20XE, SGi 20SEH, 200, iS 20SE, Boss 20SEH, CD 20SHE, GSi, Super Boss 20SEH (87-93), Kadett F 180i, iE, GSi 18SE, 200is 20XE (93-99), Monza 1.8 CLX, GLE, GLX, Convertible, GLi 18SE/SV, 2.0 CD, CLi 2.0XE, CLE, GLE 20SE/V (86-93)
<b>557010</b>	Rear Main Bearing Oil Seal	Leyland Apache 1.3, Mini 1.0, 1.1, 1275, 850, Peugeot 305 1.5, 504 2.0, 2.3, 505 2.0
<b>557112</b>	Front Wheel Oil Seal Inner	Mercedes-Benz S320, S420, S500 (93-00)
<b>577107</b>	Drive Shaft Oil Seal	VW Caddy 1.6i Club, Citi Club P/up (96-05)
<b>577511</b>	Front Wheel Oil Seal Inner	Mitsubishi Pajero 3.0 (90-98)
<b>587007</b>	Rear Wheel Oil Seal Outer	Toyota Land Cruiser 4.5 (98-04)
<b>587410</b>	Rear Main Bearing Oil Seal	Daihatsu Charade 1.0 (2003-), Sirion 1.0 (00-08)
<b>587515</b>	Rear Wheel Oil Seal Outer	Peugeot Boxer 1.8, 2.5TD (02-06)
<b>597008</b>	Drive Shaft Oil Seal	Toyota Rav4 1.8, 2.0 (03-06)

# BUYERS GUIDE - OIL SEALS

<b>597212</b>	Rear Wheel Oil Seal	Mercedes-Benz W123 200 M115.938/9, 230, E M115.954, 240D M616.912, 250 M123.920/1, 280E M110.983, 300D M617.912 (77-86), W126 280SE M110 987/9, 300SE M103.981, 380SE M116.963, 420SE M116.965, 500SE M117.965 (86-93)
<b>607408</b>	Drive Shaft Oil Seal	Audi A3 2.0 FSi BVZ, 2.0 FSi 8PA Sportback BLX, 2.0 TFSi CCZA, CBFA, 2.0 TDi BMM, CLJA, 3.2 Quattro, DSG, BUB (03-13), 1.6 TDi CLHA (12-17), 1.4 TFSi CZCA, CZEA, 2.0TDi CRFC (13-17), A4 2.0 Multitronic Avant 8EC, 8E2 ALT, 2.0 TDi 125, 8EC BLB, Avant Multitronic, 2.0TFSi DTM 147 BGB, 3.2 FSi Quattro, 8EC Multitronic Avant, Tiptronic Avant, AUK (00-08), S3 2.0 TFSi CJXB (13-17), TT 2.0 TFSi BWA, 2.0 TTS Quattro CDLA, CDMA (06-10), 3.2 Coupe, Roadster DSG, BHE, BUB (04-10), 1.8 TFSi CDAA, 2.0 TFSi Quattro CCSA, CETA, 2.5 RS Quattro CEPA (10-15), Seat Altea 2.0FSi Tiptronic, 2.0TDi Man., DSG Auto (06-09), Ibiza 1.4 Sport, BXW, 1.6 Sport, BAH, 1.8T Cupra, BBU, 1.9TDi 96, 118 Cupra, 2.0 AZL, BBX, BPX, BLK, ASZ, BLT (06-09), Leon 2.0 Fsi, 2.0T, FSi Cupra, 2.0T Fsi, 2.0TDi (06-09), VW Beetle 2.0i Cabriolet, Highline AZJ (00-12), Golf V 1.6i Comfortline, Tiptronic, Trendline BGU, 1.9TDi Comfortline, Highline, 2.0i Comfortline, GTi, GTi Trendline DSG/ AXX/BWA, 2.0FSi Sport, Sport Tiptronic AXW, 2.0TDi, Sport DSG/ BKD (04-09), Golf VI 1.4TSi Comfortline, Trendline, Highline, 1.6i Comfortline, Trendline, 1.6TDi, 2.0i GTi, Tiptronic, 2.0TSi 4Motion, 2.0TDi Highline, DSG (09-13), Jetta V 1.4TSi, 1.6TDi, 1.6i Comfortline, Tiptronic, Trendline, 1.9TDi Comfortline, Comfortline DSG, 2.0i Trendline, Comfortline, 2.0FSi Sportline, 2.0 T FSi Sportline DSG, 2.0TDi Sportline (2006-), Kombi T5 1.9TDi Beach, Van, P/van, S/Cab P/up SWB, D/Cab P/up LWB, Crew Bus AXC Dies., 2.5TDi Beach, California, Caravelle, 96/128, S/Cab, D/cab, HO P/up SWB/ LWB P/up, Crew Bus P/van, Van, AXD Dies., 3.2 Caravelle, S/Cab, D/cab P/up BDL (04-10),
<b>607408... Continued</b>	Drive Shaft Oil Seal	VW Polo 9N 1.4TDi, Classic, Trendline AMF, 1.4TDi Classic, Trendline ARC, 1.4i Trendline, Comfortline, AUA/ BBY, BLM, 1.6i Comfortline, SE, Classic Comfortline, Tipt Trendline, Classic Lux BTS/ AFV, BAH, 1.8T GTi, Classic Trendline AKK (02-10), Polo 9N 1.9TDi Highline, Classic Highline, Sportline, ATD/ AXR, 2.0i Highline, Classic Highline BBX (02-10), Cross Polo 1.6TDi, 1.9TDi (07-10), Scirocco 1.4TSi, 2.0TSi, DSG, 2.0TSi R (2009-), Sharan 1.8T MPV AJH, 1.9TDi MPV ASZ, 2.8 MPV AAA (99-08), Tiguan 1.4TSi Trend&Fun 5Dr. SUV, 2.0TSi, 2.0TDi - 4X2, 2.0TSi Track&Field, Sport&Style Man., Tiptronic 5Dr. SUV, 2.0TDi Track&Field, Sport&Style Man., Tiptronic 5Dr. SUV, 1.4TSi Track&Field, Trend&Fun 5Dr. SUV - 4X4 (08-17), Touran 1.9TDi TrendLine DSG MPV, 2.0FSi HighLine MPV AXW, 2.0TDi HighLine, DSG MPV (04-11)
<b>608008</b>	Rear Main Bearing Oil Seal	Chana Star 1.0 (06-12), Chevrolet Spark 0.8, 1.0 (03-10), Daewoo Matiz 800Cc (99-03)
<b>608009</b>	Rear Wheel Oil Seal Outer	BMW E23 Series (Std.) (78-85)
<b>608212</b>	Rear Main Bearing Oil Seal	Nissan B140 1.4 A14SP/van, S/W, Deluxe, Std. Sport, CHAMP P/up (80-08), Pulsar 1.4 DL, GX A14, 1.5 GL, Panache, SX E15 (80-87)
<b>637609</b>	Timing Cover / Cam Oil Seal	VW Touareg 5.0TDi (2004-)
<b>638012</b>	Front Wheel Oil Seal Inner	Peugeot Boxer 1.9TDi, 1.8, 2.5TD (02-06)
<b>648008</b>	Rear Main Bearing Oil Seal	Fiat Uno 1.0 Cento 156A2, 1.1 Espresso P/van 160A3, 1.1 Fire, Rio, Mia, Tempo 160A3, 1.4 Pacer, Beat, Mia, Tempo, SX 146C1 (90-05)
<b>648806</b>	Timing Cover / Cam Oil Seal	Peugeot Boxer 1.9TDi, 1.8, 2.5TD (02-06), Boxer 1.9D, 2.5TDi (06-09)
<b>657907</b>	Front Crank Oil Seal	Toyota Fortuner 3.0 D-4D SUV 1KD-FTV - 4X2, 4X4 (06-16), Hilux "Vigo" 2.0i U16/17 S/Cab, S, SRX LWB Pet. P/up 1TR-FE Pet., 2.5TDi D-4D S/Cab, S, SRX, S/Cab, S/Cab SRX HO, Raised Body Raider, D/Cab LWB 2KD-FTV, 3.0 D-4D TDi Raider, D/C Raider, Raised Body LWB P/up 1KD-FTV Dies., 4.0i D/Cab Raider Raised Body LWB P/up GR-FE Pet. - 4X2, 3.0 D-4D TDi D/C Raider 1KD-FTV Dies., LWB P/up, 4.0 D/Cab Raider 1GR-FE Pet. LWB P/up - 4X4 (05-09), 2.7i S/Cab Raider, D/Cab Raider, S/Cab HO Raised Body LWB P/up 2TR-FE Pet. - 4X2, 2.5TDi D-4D S/Cab, D/Cab SRX, Legend40 2KD-FTV Dies. LWB P/up, 2.7i S/Cab SRX, Legend40 2TR-FE Pet. LWB P/up - 4X4 (05-15), 3.0D-4D TDi D/C xtra cab, Raider, Legend40 1KD-FTV Dies. LWB, 4.0 D/Cab Raider, 1GR-FE Pet. - 4X4 (2009-), 2.0i S/Cab, S, SRX LWB Pet. P/up 1TR-FE Pet., 2.5TDi D-4D S/Cab, S, SRX, S/Cab, S/Cab SRX HO, Raised Body Raider, D/Cab r LWB P/up 2KD-FTV, 2.7i Raised Body Raider, D/Cab LWB P/up 2TR-FE Pet., 3.0D-4D TDi D/C Raised Body Raider, Xtra cab, Legend40 LWB P/up KD-FTV Dies., 4.0i D/C Raised Body Raider, Legend40 LWB P/up 1GR-FE Pet. (09-16), Hilux 2.0VVTi 1TR-FE 5 Spd Man. S/cab, 2.5D-4D Raised Body 2KD-FTV 5 Spd Man., 2.5D-4D Std. Body 2KD-FTV 5 Spd Man., 3.0D-4D 1KD-FTV - 4X2, 3.0D-4D 1KD-FTV - 4X4 (11-16), Quantum 2.5 D-4D, "Family", S-long MPV, Van 2KD-FTV Dies., 2.7 "Family", S-long "Ses'fikile" MPV, Van 2TR-FE Pet. (2005-)
<b>698510</b>	Front Wheel Oil Seal Inner	Peugeot Boxer 1.9TDi, 1.8, 2.5TD (02-06)
<b>708607</b>	Rear Main Bearing Oil Seal	Renault Clio I/II/III 1.2 (02-06), Twingo 1.2 (2009-)
<b>708808</b>	Rear Main Bearing Oil Seal	Fiat Uno 1.4 Turbo 146A (90-98), 1.0 Cento 156A2, 1.1 Espresso P/van 160A3, 1.1 Fire, Rio, Mia, Tempo 160A3, 1.4 Pacer, Beat, Mia, Tempo, SX 146C1 (95-96)
<b>708812</b>	Rear Main Bearing Oil Seal	Ford Laser 1.3 L, GL, 13, Dash E3 (86-95), 1.5 GL, GLS, Sport E5 (86-92), Meteor 1.3 GL, L, 13 E3/B3, 1.4 LX CVH (86-95), Mazda 323 FWD 1.3 S, H/back, Sedan E3, 1.5 GLC, SL, SLX, Sport H/back, Sedan E5 (81-88), 1.3 L, H/back, Sedan E/B3, 1.5, L H/back, Sedan E5 (84-91)
<b>709010</b>	Rear Main Bearing Oil Seal	Renault R5 1.3, GTL, LS, LSS, TS 810-25 (75-85)
<b>709014</b>	Front Wheel Oil Seal Inner	Peugeot Boxer 1.9TDi, 1.8, 2.5TD (02-06)
<b>728418</b>	Rear Wheel Oil Seal	Mercedes-Benz W123 200 M115.938/9, 230, E M115.954, 240D M616.912, 250 M123.920/1, 280E M110.983, 300D M617.912 (77-86), W126 280SE M110 987/9, 300SE M103.981, 380SE M116.963, 420SE M116.965, 500SE M117.965 (86-93)

## BUYERS GUIDE - OIL SEALS

<b>748808</b>	Rear Main Bearing Oil Seal	Fiat 500 1.2 169A4.000 (08-16), Doblo 1.9 Cargo P/van 223A6.000 (03-06), Multipla 1.9 JTD ELX MPV 182A4.000 (03-06), Palio I 1.2 ED, EL, Go!, Paint Ltd. M657BA.12T 178B5.000, 1.6 EL, ELX, HL, Weekend S/W, 178B3.000 (00-05), Palio II 1.2 Espresso 178B6.000, 1.2 Go!, 178B5.000, 1.6 178B3.000 (05-10), Panda 1.1 Active, 187A1.000, 1.2 Dynamic 169A4.000, 188A4.000, 1.4 100HP 169A3.000 (2006-), Punto 1.4 Multiair (04-13), Grande Punto I 1.2 199A4.000, 1.4 (06-10), Grande Punto II 1.2 199A4.000, 1.4 16V, 1.4 (08-12), Seicento 1.1 S, Sporting 176B2.000 (01-03), Siena I/II FIAT SIENA I/II 1.2 EL, EL, Plus!, M657BA 12T, 1.6 EL, Plus!, ELX HL 178B3.000, 1.6 EL+, HL, ELX, 178B3000, 1.7TD EL 176A3.000 (00-10), Stilo 1.6 Active, MultiWagon, 182B6, 1.9 JTD Dynamic, MultiWagon JTD Dynamic 192A1.000, 937A7.000 (03-06), Strada 1.2 EL P/up, 1.6 EL, EL Sporting, ELX P/up (05-10), Uno 1.4 1.0 Cento 156A2, 1.1 Espresso P/van 160A3, 1.1 Fire, Rio, Mia, Tempo 160A3, 1.4 Pacer, Beat, Mia, Tempo, SX 146C1 (95-96)
<b>749010</b>	Rear Main Bearing Oil Seal	Fiat Palio/Siena II 1.7D (05-10), Strada 1.7D P/up (05-08)
<b>759512</b>	Rear Main Bearing Oil Seal	VW Kombi T2 2.0, L Exec., Microbus, Kamper, P/up, P/van CU, CJ Pet., T3 1.9 Microbus, P/van DG Pet. (84-89), T3 2.1 Fi Caravelle, Microbus DJ Pet. - 4X2 (85-04), T3 2.1 Fi Syncro Caravelle DJ Pet. - 4X4 (89-93)
<b>809610</b>	Rear Main Bearing Oil Seal	Mitsubishi Colt LDV 2.5 (98-09)
<b>7510013</b>	Rear Main Bearing Oil Seal	Toyota Corolla RWD TE31 1.6 Sprinter, SR4/5, Black Hawk, Silver Wolf 2T, AE/TE71 1.6 GL, S/W, GLS Sprinter, SE 2T, TB, TE72 1.8 GLS, SE 3T (Sedan) (80-88), Corolla TE71 1.6 P/van 2T (83-89), Cressida TX30 1.8 DX 3T, TX62 1.8 L, LS 3T, YX70 1.8 LS, Exec. (3T) (80-89), RX72 2.4 GL, GL S/W, GLE, GLE S/W 22R (87-92)
<b>8010010</b>	Rear Main Bearing Oil Seal	Honda Accord VIII 2.0i V-Tec R20A3, 2.2 i-D-Tec N22B1/2, 2.4i V-Tec K24Z3 (08-15), Ballade SC9 "Flip up Lights" 130 EV2, 150, i EW, 160i DOHC ZC1 (84-89), SH4 150 16V SOHC D15B3, 160i 16V SOHC, DOHC D16A9 (89-92), SR4 150 Encore, Luxline, Spreeline D15B3, 160E, i D16A7, 180E, i B18B3 (92-98), SO4 150i Encore, Luxline, Spreeline D15Z4, 160i Luxline, Spreeline, V-Tec D16Y9, D16Z, 180i Luxline B18B4 (96-00), Civic SO3 150i Luxline, Spreeline D15Z4, 160i Luxline, V-Tec D16Z (96-00), Civic VII 150i, 170i V-Tec (03-06), CR-V 2.0 5 Dr. SUV B20Z1 (97-02), CR-V CTDi (2005-), Odyssey 2.2 5 Dr. S/W, 2.3 V-Tec 5 Dr. S/W (96-02), Prelude 1.8 EX ES/ET, 2.2 V-Tec, Si F22, A22 (84-98), Nissan 1-Tonner/Hardbody AW/D21 1.6 L16S-J, 1.8 L18S-R (88-98), 720 D20 2.2D SD/Z22 Tracker - 4X2 (80-88), Langley 1.3 GL E13, 1.5 GL, L, SSS, Trebon, Exa Turbo E15 (83-88), Pulsar 1.3 S E13 (80-87), Sentra 1.3 GL, SX E13S, 1.6 GL, GX, GXE GXEi Coupe, SGLi E16E/S (87-92)
<b>8010012</b>	Rear Main Bearing Oil Seal	Nissan 1-Tonner/Hardbody AW/D21 2.0 NA20, 2.4 Z24/S - 4X2, 2.4 Z24S - 4X4 (88-98), 720 D20 1.8 L18S Kingcab, Sport, 2.3 SD23 - 4X2, 1.8 L18S, 2.0 NA20, 2.2 Z22 - 4X4 (80-88), E20 1.8 L18 Bus, P/van Coach, Coach GL, GLE, Econolux, Ekonovan, Ekonowagon, 2.0 Bus, Van H20 (80-96), Laurel 2.8 SGL 5L28 (80-87), Sani AW/D21 2.4, i Z24 - 4X2, 2.2 Z22, 2.4 Z24 - 4X4 (89-99), Stanza 1.6 DL, Resort, S/W L16, 1.8 GL, Resort, S/W SSS L18 (80-84), Skyline R30 1.8 L18, 2.8 GLX, GTX L28/2 (82-87), R31 3.0 SGLi RB30E With I.R.S. (87-92), Renault R5 1.4 TS 847-C2J (75-85), R9 1.4 GTL, TL, TSE C1/2/3J, R11 1.4 TS, TX, TXE C1/2/3J (83-86), Toyota RX60 2.0 GL, GLE, GLX, S/W 21R, RX70, YX72 2.0 GL, GL, GLE, GLX (81-92), GX60 2.0 GLi6 1G-E, GX7 2.0 GLi6 1G-E, 1G-FE (83-92), MX63 2.8i 5M-E, MX73 2.8i RSi, RSi Exec. 5M-GE (84-89), MX75 3.0i ECT, GLS 7MG-E (86-92), Stout RK110 2.0 SWB P/up 5R Pet. (79-89)
<b>8010512</b>	Rear Main Bearing Oil Seal	Mazda 616 1.6 (71-74), Capella 1.6, 1.8 (74-79), B1600, B1800 (71-86)
<b>8010513</b>	Rear Main Bearing Oil Seal	Mazda B2000 2.0 (82-86)
<b>8210512</b>	Rear Main Bearing Oil Seal	Alfa Romeo Alfetta, Berlina 1750, 2000, Giulietta 1.8, 2.0, Gtv 1750, 2.0, Audi 80 1.5
<b>8510308</b>	Rear Main Bearing Oil Seal	Dodge Caliber 1.8 SE, SXT, EBE, 2.0 TD, SXT, CVT, ECN, 2.4 RT, SXT, EDA (06-12), Journey 2.0 CRD, R/T, ECE, 2.4 SXT, ED3, 2.7 V6 R/T, SXT, EER, 3.6 V6 R/T, SXT, ERB (2008-), Hyundai H1 2.4 G4KC CVVT P/van Man., Wagon (2009-), iX35 2.4 G4KE - 4X2, 4X4 (2010-), Jeep Compass 2.0 ECN, 2.4 ED3, ERZ (2007-), Patriot 2.4 ED3 (2007-), Kia Cerato 1.6 LX G4FC, 2.0 G4KD (2008-), Optima 2.4 G4KJ (12-14), Soul 2.0 G4KD (2009-), Sportage 2.4 G4KE - 4X2, 4X4 (2010-), Mitsubishi ASX 2.0 4B11 (2011-), Colt LDV 2.0 LWB Std. P/up, 2.0i LWB Hi-Line, 2.4i LWB Hi-Line Rodeo S-/D/cab, Hi-Line/Rider P/up Pet. - 4X2, 2.4i LWB Hi-Line D/cab, Trailbuster S/cab, P/up Pet. - 4X4 (98-09), Lancer 2.0 4B11 (2007-)
<b>8510508</b>	Rear Main Bearing Oil Seal	Nissan Micra 1.5dCi (2005-)
<b>8510509</b>	Rear Main Bearing Oil Seal	Citroen Berlingo 1.4 P/van TU3JP Pet. (03-15), C3 1.4i HDi, DV4TED4, 1.6i Pluriel, Sensodrive, TU5JP4 (02-10), C4 Aircross 1.6 VTi EP6C, 1.6 e-Hdi (10-15), DS3 1.2i VTi EB2F, 1.6 VTi EP6C, 1.6 e-Hdi 9HP (2010-), Picasso 1.6 (03-06), Xsara 1.6 SX TU5JP (03-08), Tata Indica/Vista 1.4 LEi, LSi, LX, LXi, 1.4TDi DLX, DLS, Indigo 1.4 GLS S/W, 1.4TDi DLX S/W (2005-)
<b>8510510</b>	Rear Main Bearing Oil Seal	Toyota Camry 2.2 (01-06)
<b>8510511</b>	Rear Main Bearing Oil Seal	Audi A3 3.2 (2003-), A4 3.2, FSi (2001-), TT 3.2 (04-06), VW Passat 2.3 V5 (03-05), Kombi 3.2 P/up, Caravelle (2005-)



## BUYERS GUIDE - OIL SEALS

<b>8510512</b>	Rear Main Bearing Oil Seal	Audi 100/4 1.6 LS YV, 100/5 1.9 WH, 200 2.1 GLS, GLX, 400 1.8 JW, 500 2.1/2.2 WB, WC SE PR (77-92), 500 2.2 E PR, 2.3 E, SE, AAR, 2.8 SEL AAH (92-94), A3 1.8 8L1 AGN, 1.8T AGU, BPU (98-04), A4 1.8 8D2, B5 Exec ADR, 1.8T APU (95-01), 1.8T Avant, Multitronic, BFB, B6 AVJ 8E2, 1.9 TDi AVF, Avant B6, 8E5, 8E2 (00-08), S3 1.8T 8L1 Quattro AMK, BAM, APY (00-04), S4 2.2T Quattro AAN (92-95), Renault R9 1.7 TXE F2/3N, R11 1.7 TX, TXE F2/3N (83-86), VW Beetle 1.8T Coupe APH, 2.0i Cabriolet, Highline AZJ (00-12), Caddy 1.6 SWB, Caddy Club P/up JK Dies., HM Pet., 1.8 SWB L, Sport P/up HV Pet. (81-97), Citi Golf 1.3 L ET/GY, 1.6 Blues, Chico, Chico Lux, Deco, Designa, L, Ritz, Shuttle, Sonic, Sport HM, HV, FR, 1.6iL, Life, VeloCiti, TenaCiti, CitiStorm, - Sport, - Rox, Rhythm, MKI AFX, 1.8 CTi, Designa, L Sport BZF (83-09), 1.3 L Shuttle, Chico, Chico, Lux ET/ GY/ AJD (87-03), 1.4, iL, Chico, Rhythm, Citi com, VeloCiti, TenaCiti, CitiStorm, - Sport, Rox, Rhythm, Wolf, - XCite, Billabong AGY/BSV (99-09), Fox 1.3 L, L Trippa GY, 1.6 L HM, 1.8 L Sport HV (87-96), Golf I 1.1 GL, L, LS ET/EG, 1.3 GL, L, LS GF (78-82), 1.5 GL Diesel, GLS, LS CK/EM/JB, 1.6 GL Diesel, GT, GTS, GTX JK/CR FR, 1.8 Gti EV (78-84), Golf II 1.3 CL GY, 1.6 CSL HM, 1.8 8/16V CSX, GTS, GTi KR, EV, 2.0 8/16V GTi AAL (84-92), Golf III 1.6 GS ACG, 1.8 GSX, GTS ACH, 2.0 GTi, Exec. 2E, 2.8 VR6, Exec. AAA (92-99), Golf IV 1.6i Comfortline, Std., Estate AKL, 1.8, T GTi, Highline AGU/ AGN, 1.9 TDi Highline, Estate AHF, 2.0i Cabrio, Highline APK (99-04), Jetta I 1.3 GL, GX ET/ GF, 1.5 GLS, GLX JB, 1.6 GLS EM, 1.8 GLi DX (80-85), Jetta II 1.6 CSL HM, 1.8 8/16V CLi, CLi Exec., CLX, CSi, CSX EV/KR, 2.0 8/16V CLi, Exec. AAL (85-92), Jetta III 1.6 CSL ACG, 1.8 CLX/CSX ACH, 2.0 CLi, Exec. 2E, 2.8 VR6 Exec. AAA (92-99), Jetta IV 1.6i Comfortline, Std. AKL, 1.8T Highline, Exec AGU, 1.9 TDi Highline AHF, 2.0i Highline APK, 2.3 V5 AGZ (99-03), Passat I & II 1.3 L, LS H/back, Sedan, Variant ZF, 1.5 GL, LS Fastback, S/W CK, 1.6 GL, GLS, LS, LX Fastback, S/W, Sedan, Coupe, Variant, YN/YP/WN, 1.8 CL Sedan, S/W JV/KR (74-87), Passat I & II 1.9 GLS H/back, GLX Sedan, S/W WN, 2.2 CLi, CLX SG/MX (81-87), Passat IV 1.8T AEB (99-05)
<b>9010909</b>	Rear Main Bearing Oil Seal	Mazda Etude 180 iSE, iSX, Sport (99-04)
<b>9011011</b>	Rear Main Bearing Oil Seal	Renault Espace 2.0 (99-02)
<b>9111412</b>	Rear Main Bearing Oil Seal	Mitsubishi Colt LDV 2.8TDi LWB Club CabS cab,Turbo (94-98), 2.8TDi LWB Pioneer, Rodeo D/cab P/up Turbo Dies. - 4X2, 2.8D, TDi LWB Club cab, Trailbuster S/cab, Rodeo /cab P/up Dies./ Turbo Dies. - 4X4 (99-09), Pajero 3.2 DI-D - 4X4 (02-07), 3.2 DI-D, DI-DC 4M41 - 4X4 (2007-), Triton 2.4 MPI D/cab P/up 2.5 Di-D C/cab P/up, 3.2 Di-D D/cab P/up, 3.5 Club cab P/up, 3.5 MPI Double cab P/up - 4X2, 4X4 (2007-)
<b>9611211</b>	Rear Main Bearing Oil Seal	Isuzu KB320 (98-04)
<b>9611412</b>	Rear Main Bearing Oil Seal	Mitsubishi Colt LDV 2.8TDi LWB Club CabS cab,Turbo (94-98), 2.8TDi LWB Pioneer, Rodeo D/cab P/up Turbo Dies. - 4X2, 2.8D, TDi LWB Club cab, Trailbuster S/cab, Rodeo /cab P/up Dies./ Turbo Dies. - 4X4 (99-09)
<b>10012513</b>	Rear Main Bearing Oil Seal	Mazda B2200 2.2 (82-86)
<b>385811RK</b>	Rear Gearbox Oil Seal	C.A.M. Inyathi, Jinbei Haise Minibus 2.2i Std. (2007-), Toyota TX30 1.8 DX 3T, TX62 1.8 L, LS 3T, YX70 1.8 LS, Exec. (80-89), RX60 2.0 GL, GLE, GLX, S/W 21R, RX70, YX72 2.0 GL, GL, GLE, GLX (81-92), GX60 2.0 GLi6 1G-E, GX7 2.0 GLi6 1G-E, 1G-FE (83-92), MX63 2.8i 5M-E, MX73 2.8i RSi, RSi Exec. 5M-GE (84-89), RX72 2.4 GL, GL S/W, GLE, GLE S/W 22R, RX73 2.4 GLE, GLE S/W 22R With I.R.S. (Independent Rear Suspension) (87-92), Hiace YH50/60 1.8 SWB / LWB P/van, LS Wagon 2Y Pet. (83-91), YH51/61 2.0 SWB/LWB 16 Seater Commuter, Super 10 Seater Custom Wagon, P/van 3Y Pet. (83-86), YH53/63 2.2 SWB/LWB P/van, Van, LS, GLX, Exec. Wagon 4Y Pet. (All Imp. Models) (86-88), YH53/63 2.2 SWB/LWB P/van, Van, LS, Super T/14/16, GLX, Exec. Wagon, Siyaya Bus, P/van 4Y Pet. (All Local Models) (88-09), Hilux LN30/40/50/51/55 2.2 SWB/LWB P/up L Dies., 2.4 SWB/LWB D/cab, Raider P/up 2L Dies., YN58 2.2 LWB D/cab, Raider, SRX P/up 4Y Pet. (79-98), YN51/56 1.8 SWB/LWB D/cab, S, SR, Raider P/up 2Y Pet., YN140 1.8 SWB/LWB D/cab, Raider, S, SRX P/up 2Y Pet. (86-05), RN58 2.4 22R Pet. (94-98), LN140/145 2.4i DLX, P/up 2L Dies., RZN194 2.7i LWB D/cab, Raider, SRX, Legend35 Raider, 3RZFE Pet. (98-05), Hilux LN57 2.8D LWB D/cab, Raider P/up 3L Dies. - 4X2 (95-98), RZN147 2.0 SWB/LWB D/cab, DLX, Raider, S, SR, SRX P/up 1RZ Pet. (98-05), LN192R 3.0D LWB Raider D-E, Raider DLX D/cab D-E, Legend35 Raider, P/up 5L Dies., 3.0iD LWB Raider, Raider D/cab, P/up KZ-TE Dies. (98-05), Hilux "VIGO" 2.0i U16/17 S/Cab, S, SRX LWB Pet. P/up 1TR-FE Pet. - 4X2 (05-09), Hilux "VIGO" 2.0i S/Cab, S, SRX LWB Pet. P/up 1TR-FE Pet. - 4X2 (09-11)
<b>405208SP</b>	Rear Wheel Oil Seal	Audi 100/4 1.6 LS YV, 100/5 1.9 WH, 200 2.1 GLS, GLX, 400 1.8 JW, 500 2.1/2.2 WB, WC SE PR (77-92), 500 2.2 E PR, 2.3 E, SE, AAR, 2.8 SEL AAH (92-94), A4 1.8 8D2, B5 Exec ADR, 1.8T APU (95-01), A6 2.4 Avant Multitronic., Tiptronic, AGA, ALF, AML, APS, ARJ, 2.5TDi Multitronic Avant SW., BCZ/BDG/BFC, 2.6 ABC (Std) (97-03), Daewoo Cielo 1.5 GL, GLX, GTX, 150i L, Espero 1.8 CD, C18LE (96-99), Lanos I 1.35i S, 1.6 SX, Lanos II 1.4 S, 1.6 SX, Numbira I 1.6 SX, 2.0 CDX, Numbira II 1.6 SX, SX S/W, 2.0 CDX, Exec., S/W (97-03), Opel Ascona 1.3 L 13NV/SC, 1.6 GL 16SH (82-87), Opel Ascona 1.3 L 13NV/SC, 1.6 GL 16SH (82-87), Astra F 140i, iS 14NV, 160i, iE, iS, Estate 16NZ, 180i, iE 18SE/ XE, XL, 200i, e, ts 20SE/ XE (93-99), Corsa B 130, i, Lite, iE, iS, Chill Hatch / Sedan 13NE, 140i, Classic, Active, Lite, Lite+, Comfort, Chill, Sport, S 14NE, Hatch/ Sedan, 160, i, iE, Classic, GSi, i Sport, S Hatch/ Sedan, 16SE, 1.8i GSi Hatch (96-03), Corsa LDV 130i Utility P/up 13NE, 1.4i Utility, S P/up 14NE, 1.6i Utility Sport P/up 16NZ, 1.7D Utility P/up X17D (97-04), Corsa P/Van 1.3i Pronto 13NE (99-00), Kadett D, E 1.2 L 12NS, 1.3 Cub, GL, GLS, LS, Rebel 13NV, 140 CL, Cub 14NE/NV, 1.6 GL, GLS, GSE, L, Rebel, Cub 16SH/SE, 160i, GSi Aspen 16SE (80-93), 1.8 GTE 18E, L 18LV, GSi Hatch 18L, GLX (84-93), Kadett E 2.0 GSi 20XE, SGi 20SEH, 200, iS 20SE, Boss 20SEH, CD 20SHE, GSi, Super Boss 20SEH (87-93), Kadett F 140, S 14NE, 160i, iS, GSi, Aspen 16SV/NZ (93-99), 180i, iE, GSi 18SE, 200is 20XE (93-99), Monza 160 GSi, i Aspen 16SE/NZ, CLS 16SV, 1.8 CLX, GLE, GLX, Convertible, GLi 18SE/SV, 2.0 CD, CLi 2.0XE, CLE, GLE 20SE/V (86-93)

## BUYERS GUIDE - OIL SEALS

<b>405208SP.. Continued</b>	Rear Wheel Oil Seal	VW Caddy 1.6 SWB, Caddy Club P/up JK Dies., HM Pet., 1.8 SWB L, Sport P/up HV Pet. (81-97), Golf 1.3 L ET/GY, 1.6 Blues, Chico, Chico Lux, Deco, Designa, L, Ritz, Shuttle, Sonic, Sport HM, HV, FR, 1.6iL, Life, VeloCiti, TenaCiti, CitiStorm, - Sport, - Rox, Rhythm, MKI AFX, 1.8 CTi, Designa, L Sport BZF (83-09), 1.3 L Shuttle, Chico, Chico Lux ET/ GY/ AJD (87-03), 1.4, iL, Chico, Rhythm, Citi com, VeloCiti, TenaCiti, CitiStorm, - Sport, Rox, Rhythm, Wolf, - XCite, Billabong AGY/ BSV (99-09), Fox 1.3 L, L Trippa GY, 1.6 L HM, 1.8 L Sport HV (87-96), Golf I 1.1 GL, L, LS ET/EG, 1.3 GL, L, LS GF, 1.5 GL Diesel, GLS, LS CK/EM/JB, 1.6 GL Diesel, GT, GTS, GTX JK/ CR FR, 1.8 Gti EV (78-84), Golf II 1.3 CL GY, 1.6 CSL HM, 1.8 8/16V CSX, GTS, GTi KR, EV, 2.0 8/16V GTi AAL (84-92), Golf III 1.6 GS ACG, 1.8 GSX, GTS ACH, 2.0 GTi, Exec. 2E, 2.8 VR6, Exec. AAA (92-99), Jetta I 1.3 GL, GX ET/ GF, 1.5 GLS, GLX JB, 1.6 GLS EM, 1.8 GLi DX (80-85), Jetta II 1.6 CSL HM, 1.8 8/16V CLi, CLi Exec., CLX, CSi, CSX EV/KR, 2.0 8/16V CLi, Exec. AAL (85-92), Jetta III 1.6 CSL ACG, 1.8 CLX/CSX ACH, 2.0 CLi, Exec. 2E, 2.8 VR6 Exec. AAA (92-99), Passat I & II 1.3 L, LS H/back, Sedan, Variant ZF, 1.5 GL, LS Fastback, S/W CK, 1.6 GL, GLS, LS, LX Fastback, S/W, Sedan, Coupe, Variant, YN/YP/WN, 1.8 CL Sedan, S/W JV/KR (74-87), Passat I & II 1.9 GLS H/back, GLX Sedan, S/W WN, 2.2 CLi, CLX SG/MX (81-87), Polo 6N 1.4 Classic, Playa Lux AEX, 1.6 Classic, Playa, Lux AEE, 1.8 Classic, Playa, Lux ADZ (96-03)
<b>425507D</b>	Rear Wheel Oil Seal	Nissan 120Y, 140Y, 1600, 160U, 1800, 180U, 1200, 1400, B140 1.4 S/W, P/Up (69-08)
<b>44600L</b>	Oil Seal	Various Trailer Model Applications
<b>457212/15</b>	Pinion Oil Seal	Mitsubishi 98-09 Colt LDV 2.8D, 2.8TD, 4X4 2.4i, 2.8D, 3.0i
<b>486206D</b>	Front Wheel Oil Seal	Nissan B140 1.4 A14SP/van, S/W, Deluxe, Std. Sport, CHAMP P/up (80-83), Stanza 1.6 DL, Resort, S/W L16, 1.8 GL, Resort, S/W SSS L18 (80-84)
<b>62858/17</b>	Rear Wheel Oil Seal	Toyota Land Cruiser FJ80 4.0 DLX, GX, VX P/up 3F/F-E Pet. (90-92), FZJ80 4.5 Std., GX, VX, Turbo S/W, P/up 1FZ-FE Dies., Turbo Dies. (92-95), FZJ80 4.5 Std., GX, VX, Turbo S/W, P/up 1FZ-FE Dies., Turbo Dies. (95-06), FZJ105 4.5 Std., GX, Turbo P/up, S/W 1FZ-FE Dies., Turbo Dies. (95-98), FZJ105 4.5 V8 VX, Turbo P/up, S/W 2UZ-FE Pet. (98-06), HDJ/HZJ80 4.2 GX, Turbo S/W, P/up 1HD-FT, 1HZ Dies., T. Dies. (90-95), HDJ/HZJ80 4.2 Std., GX, VX, Turbo S/W, P/up 1HD-FT, 1HZ Dies., Turbo Dies. (95-01), HDJ100 4.2 Std., GX, VX S/W, 1HZ Pet., 4.5, 4.7 V8 (97-04), HZJ105 4.2 Std., GX DSL, Turbo P/up, S/W 1HZ Dies., Turbo Dies. (98-06), UZJ100 4.5 V8 Std., GX, VX S/W, P/up 2UZ-FE Pet. - 4X4 (98-06)
<b>9061FS</b>	Rear Main Bearing Oil Seal	Ford Ranger T6 2.2, 3.2 - 4X2, 4X4 (2011-), Tourneo 2.2 Tdci LWB & SWB Turbo 6spd Man. (2013-), Transit 2.2 Tdci Hi LWB & SWB, 2.2 Tdci LOW LWB & SWB, 2.2 Tdci Sport SWB (2013-), Land Rover Defender 90/110/130 2.2, 2.4 (2002-), Mazda BT-50 2.2 MZ-CD P4-AT, 3.2 MZ-CD P5-AT - 4X2, 3.2 MZ-CD P5-AT - 4X4 (2012-), Peugeot Boxer 2.2HDi P2ZDTE (06-17)
<b>9071FS</b>	Rear Main Bearing Oil Seal	Land Rover Defender 90, 2.5 (2002-), Discovery II 2.5 (04-05)
<b>9073FS</b>	Rear Main Bearing Oil Seal	Land Rover Defender 110 2.5TDi, i (2002-)
<b>9077FS</b>	Rear Main Bearing Oil Seal	Land Rover Discovery III, IV (05-09)
<b>9082FS</b>	Rear Main Bearing Oil Seal	Mercedes-Benz W176 A-Class 180, 200, 250 (2013-), W246 B-Class 180, 200, 250 (2012-), W212 Series E Class 200, 250 (2009-)
<b>9083FS</b>	Rear Main Bearing Oil Seal	Mercedes-Benz W204 C-Class 350 CDi (07-14), W212 E-Class 350 CDi (2009-), Vito/Viano BM639 Series 3.0 Cdi (2006-)
<b>9092FS</b>	Rear Main Bearing Oil Seal	Toyota Auris 1.3, 1.6 (2007-), Corolla 1.3 (2007-), Yaris 1.3 (2011-)
<b>9111FS</b>	Rear Main Bearing Oil Seal	Nissan Hardbody QW/D22 2.7D, 3.0i, TD, 3.2, D, 3.3i, 4.2 - 4X2, 4X4 (98-10)
<b>9177FS</b>	Rear Main Bearing Oil Seal	Nissan X-Trail T32 1.6 Dci R9M (2014-), Renault Kadjar 1.6dCi R9M (2015-)
<b>9199FS</b>	Rear Main Bearing Oil Seal	VW Polo 9N 1.6 (02-10)
<b>9202FS</b>	Rear Main Bearing Oil Seal	Nissan Hardbody QW/D22 2.7D TD27i, 3.0TD ZD30, 3.2 QD32, 3.3i VG33E - 4X2, 2.7 TD27, 3.0TD ZD30, 3.2, 3.3i VG33 - 4X4 (98-10), Patrol Y61 4.2 TD42 - 4X4 (99-04), Sani AW/D21 2.7D, TD TD27 (89-99), Terrano II 2.7 TD27 - 4X4 (00-02)
<b>9206FS</b>	Rear Main Bearing Oil Seal	Audi A8 3.7, 4.2 (95-04), S4 4.2 (03-05), VW Touareg 3.6 FSi, 4.2, FSi (2007-)
<b>9222KIT</b>	Clutch Seal Kit	VW Citi Golf, Fox, Golf I, II, III, IV, Jetta I, II, III, IV
<b>9222KIT</b>	Clutch Seal Kit	VW Citi Golf 1.3, 1.4, i, 1.6, i, 1.8 (83-09), Fox 1.3, 1.6, 1.8 (87-95), Golf I 1.1, 1.3, 1.5, 1.6, 1.8 (78-85), Golf II 1.3, 1.6, 1.8, 2.0 (84-92), Golf III 1.6, 1.8, 2.0, 2.8 (92-99), Golf IV 1.6 (99-04), Jetta I 1.3, 1.5, 1.6, 1.8 (80-85), Jetta II 1.6, 1.8, 2.0 (85-93), Jetta III 1.6, 1.8, 2.0, 2.8 (92-99), Jetta IV 1.6 (99-06)
<b>9226FS</b>	Rear Main Bearing Oil Seal	Audi A4 3.2, FSi, S4 3.2 (2005-)
<b>9228FS</b>	Rear Main Bearing Oil Seal	Seat Altea 2.0FSi (06-08), VW Caddy 1.6i Life MPV, Van (2005-), Golf VI 1.6i (2009-)
<b>9229FS</b>	Rear Main Bearing Oil Seal	Audi A3 2.0 TDi (2003-), A4 2.0 TDi, TFSi (2005-), Dodge Caliber/Journey 2.4 CRD Diesel, Seat Altea 2.0TDi, Leon 2.0TDi (06-08), VW Golf V 1.9TDi, 2.0 TDi (04-09), Golf VI 2.0TDi (2009-), Jetta V 1.9TDi, 2.0TDi (2006-), Sharan 1.9TDi (03-09), Tiguan 2.0TDi (2009-), Touran 1.9TDi, 2.0TDi (2004-), Caddy 1.9TDi, 2.0SDi (2005-)
<b>9231FS</b>	Rear Main Bearing Oil Seal	Seat Ibiza 1.6 (06-08), VW Golf V 1.6i (04-09), Jetta V 1.6i (2006-)
<b>9232FS</b>	Rear Main Bearing Oil Seal	Audi A3 2.0 FSi, TFSi, A4 2.0, TFSi (2003-), TT 2.0T FSi (2006-), VW Golf V 2.0i, FSi, GTi (04-09), Golf VI 2.0GTi (2009-), Jetta V 2.0i, FSi, TFSi (2006-), Passat 2.0 FSi, TFSi (2005-), Scirocco 2.0TSI, Tiguan 2.0TSI (2009-), Touran 2.0FSi (2004-)



# BUYERS GUIDE - OIL SEALS

<b>9237FS</b>	Rear Main Bearing Oil Seal	Seat Ibiza 1.4 Sport, BXW (06-09), VW Polo 9N 1.4TDi Classic, Trendline ARC, 1.4i Trendline, Comfortline, AUA/ BBY, BLM, 1.6i Comfortline, SE, Classic Comfortline, Tipt Trendline, Classic Lux BTS/AFV, BAH (02-10), Tiguan 1.4TSi Trend&Fun 5Dr. SUV, 2.0TSi, 2.0TDi - 4X2, 1.4TSi Track&Field, Trend&Fun 5Dr. SUV - 4X4 (08-17)
<b>9284FS</b>	Rear Main Bearing Oil Seal	Audi A4 2.0T FSi, 2.4, 3.0, TDi, A4 2.5 TDi, A6 2.5 TDi (02-08)
<b>9375FS</b>	Rear Main Bearing Oil Seal	Ford Focus II 2.0 Si, Trend., TDCi Ghia, TDCi Si. (05-09), Focus III 2.0 Gtdi ST1 & ST2 R9DA (09-15), Mondeo 2.0 CJBA, CJBB (02-07), Mazda 3 (BL, BK) 2.0 BN Series (04-14), 5 2.0 Original, Active, Individual (07-14), 6 2.0 Active, Original, Elegant, 2.3 Dynamic, Dynamic Individual, Sporty, Sporty Lux, 2.3 MPS AWD, 2.5 Dynamic Activematic, Individual (03-14), CX-7 2.3 L3-VDT - AWD, 2.5 L5-VE (07-12), Volvo C30 1.8 Man., 2.0, R-Design, Powershift Man., Geartronic (08-13), S40 1.8 Sedan, 2.0 Sedan (2004-), S60 2.0 D3, D4, T5, T6 (2010-)
<b>9377FS</b>	Rear Main Bearing Oil Seal	Ford Fiesta 1.4i (04-08), Fiesta 1.4, 1.6 Pet. (2008-), Figo (2010-), Focus II 1.6 (2005-), Volvo C30 1.6 (2008-)
<b>9398FS</b>	Rear Main Bearing Oil Seal	Mercedes-Benz W211 E-Class E200K (2002-)
<b>9399FS</b>	Rear Gearbox Oil Seal	Mercedes-Benz W211 E-Class E200K, E240, E280, E320, E350 (2002-)
<b>9415NOK</b>	Rear Wheel Oil Seal Nok Seal	C.A.M. Inyathi, Jinbei Haise Minibus 2.2i Std., Rhino 2.2i, 2.8i (Local Diff.) (2007-), Ford Cortina MkIV 3.0 V6 Leisure, P/up Essex EV30 (77-80), Cortina MkV 1.6 P/up Kent, 2.4 P/up York D24, 3.0 V6 Leisure P/up Essex EV30 (80-86), Courier 1.6 P/up F6, 1.8 Chassis cab, Explorer, Std., XLT P/up F8, 2.0 XLT FE., 2.2 D/cab, Explorer, Leisure, Std., XLT P (86-00), Courier 3.0 V6 D/cab, Explorer, L, Leisure, Std., P/up Essex (86-97), Courier 2.5 Turbo Dies. D/cab, Leisure P/up WL4 - 4X2, 4X4 (96-00), Courier 3.0 V6 Std., XLT, D/cab, Leisure, Explorer, Exec. P/up Essex, 3.4 V6 Leisure, D/Cab, P/up Essex. - 4X2, 4X4 (97-01), Husky 1.8 1 Ton P/up 4G62, 2.0 1 Ton P/up, Bus, P/van 4G63 (Local) (85-99), Ranger 1.8 XL, P/up, 2.2 XL, P/up (00-10), 2.5 Diesel, Turbo Diesel D/ Cab, High Trail, XL, DT XLT High Trail D/Cab, Super Cab - 4X2 (00-05), 2.5 D/Cab, High Trail, XL, DT XLT High Super Cab, 2.5TD Montana D/Cab WL4, 3.0TDCi, 4.0 Super Cab XLT - 4X4 (00-05), Spectron 2.2 Bus, P/van F2 (91-04), Hyundai Bakkie 2.5i D4BH Dies., 2.6i D4BB Dies., H100 P/ Van 2.5i D4BH Dies., 2.6i D4BB Dies., (Local) (97-07), Isuzu KB20 1.6 P/up G161Z Pet., KB21 1.6 P/up G161Z Pet., KB22 1.8 P/up G180Z Pet., KBD20 2.0 P/up C190, KBD21 2.0 P/up C190, KBD22 2.2 LE, P/up C223, KB23 2.0 P/up G200Z, KB24 2.3 LE 4ZD1, KB25 1.6 P/up G161Z, KB26 1.6 P/up G161Z, 1.8 P/up G180Z, KBD23 2.5 LE, P/up 4JA1, KBD25 2.0 P/up C190 (78-89), KBD26 2.0 P/up C190, KBD27 2.2 C223, KBD28 2.5 4JA1 (81-89), KB27 1.8 P/up G180Z, KB28 2.0 P/up G200Z, KB29 2.3 P/up 4ZD1 (83-89), KB40 1.6 G161Z, KB41 1.6 G161Z, 1.8 G180Z, KB42 1.8 G180Z, KB43 2.0 G200Z, KB44 2.3 4ZD1, KBD40 KBD41 2.0 P/up C190, KBD42 2.2 P/ up C223 - 4X4 (Local) (79-89), KB160 1.6 Fleetside P/up, KB200 2.0 LE, Fleetside, D/cab P/up, KB220 2.2 LE, P/up, KB230 2.3 D/cab P/up (89-04), KB260 2.6 LE, D/cab, LX, P/up 4ZE1, KB320 3.2 LE, D/cab, LX, Frontier, Reef, Blazer P/up 6VD1 (92-04), KB220 2.2 LE P/up, KB230 2.3 P/up 4ZD1, KB260 2.6 D/cab, LE, LX, KB320 3.2 V6 Frontier LX - 4X4 (89-04), KB250D 2.5 Fleetside, LE, D/Cab P/up 4JA1, KB280DT 2.8 D/cab LE, LX, Frontier P/up Turbo 4JB1 (89-04), KB250D 2.5 LE, D/cab P/up 4JA1, KB280DT 2.8 LE, LX, D/cab P/up Turbo 4JB1 - 4X4 (04-09), Relay 2.0 P/ van, Bus 4ZC1 (89-95), WFR 1.8 11FVX/ 12FVX Bus, P/van 4ZB1 (83-89), Kia Sportage JA 2.0 SUV 5 Spd. FE Pet. - 4X4 (98-03), Mazda B-Series B2000 2.0 SWB P/up MA Pet., B2200 2.2 SWB/LWB P/up S2 Dies. (82-86), B2600 2.6 LWB D/cab, Magnum, Drifter P/up 4G54 Pet., B2600i 2.6i LWB D/cab Drifter, SLX P/up 4G54 Pet. - 4X2 (86-01), B2600 2.6 V6 LWB D/cab, Magnum, Drifter P/up 4G54 Pet. - 4X4 (86-95), B3000 3.0 V6 LWB D/cab, Magnum Drifter P/up Essex Pet. - 4X4 (86-97), B1600 1.6 SWB Magnum P/up F6 Pet., B1800 1.8 SWB/LWB Magnum, Drifter P/up F8 Pet. (86-00), B2000 2.0 LWB Drifter, Magnum P/up FE Pet., B2200 2.2 LWB D/cab, Drifter, Magnum P/up R2 Dies., 2.2 LWB D/cab, Drifter Magnum P/up F2 Pet. (86-00), B2500 2.5, Td LWB D/Cab, Drifter, SLX P/up WL4 Dies./Turbo Dies. - 4X4 (96-99), B3400 3.4 V6 LWB Magnum D/cab P/up Essex Pet. - 4X2, 4X4 (96-01), B2500 2.5 LWB Diesel, Turbo Diesel D/cab, Drifter, SLX P/up WL4 Dies., Turbo - 4X2 (97-00), B2600i 2.6i V6 LWB Drifter, D/cab Drifter SLX P/up 4G54 Pet. - 4X4 (00-09), Drifter 1.8 SWB/LWB XL P/up Pet., 2.2 SWB/LWB XL P/up Pet., 2.5Td LWB Hi Ride, SL SLE, SLX D/cab, Hi Ride, Hi Trail D/cab P/up WL4 Dies./Turbo Dies. - 4X2, 2.5Td LWB D/cab, DL, SL, SLE, SLX S/cab, D/cab P/up WL4 Dies./Turbo Dies. - 4X4, 2.6i LWB Hi Ride, SL Hi Ride S/cab, SLE, SLX D/cab SLX Hi Ride D/cab, SLX Hi Trail D/cab P/up Pet. - 4X2, 2.6i V6 LWB SL S/cab, SLE, SLX D/cab P/up 4G54 Pet. - 4X4 (00-05), Marathon 2.2 LWB Bus, P/van F2 Pet. (91-04), Mitsubishi Colt LDV 1.6 SWB/LWB Lo-Line P/up 4G32 Pet., 2.0 4G63 Pet., 2.5D 4D56 Dies., 2.6 WB Hi-Line P/up 4G54 Pet. (94-98), Colt LDV 2.5D LWB Hi-Line P/up 4D56 Dies., 2.6 LWB Lo-/Hi-Line, P/ up 4G54 Pet., 3.0 V6 LWB Lo-/Hi- Line D/cab, Rodeo 6G72 Pet. - 4X4 (95-98), L300 1.6 Mini Bus, Van 4G32 Pet., 1.8 4G62 Pet., 2.0 P/up 4G63 Pet, Starwagon 2.0 S, SL, SLE, P/up, P/van 4G63 Pet. (82-01), Pajero 2.8 Tdi, 3.0 V6 SWB GLS Wagon 6G72 Pet., 3.5 V6 SWB GLS Wagon 6G74 Pet. - 4X4 (90-01), Nissan 1-Tonner/Hardbody AW/D21 1.6 L16S-J, 1.8 L18S-R, 2.0 NA20, 2.4 Z24/S, 2.5D TD25i, 2.7D TD27, 3.0 VG30E (88-98), AW/D21 2.4 Z24S, 2.7 TD27, 3.0 VG30E - 4X4 (88-99), 720 D20 1.8 L18S Kingcab, Sport, 2.2D SD/Z22 Tracker, 2.3 SD23 - 4X2, 1.8 L18S, 2.0 NA20, 2.2 Z22 - 4X4 (80-88), E20 1.8 L18 Bus, P/van Coach, Coach GL, GLE, Econolux, Ekonovan, Ekonowagon, 2.0 Bus, Van H20 (80-96), Hardbody QW/D22 2.0 NA20S, 2.0i KA20, 2.4i Z24, KA24E/DE, 2.7D TD27i, 3.0 i VG30E, 3.0TD ZD30, 3.2 QD32, 3.3i VG33E - 4X2, 2.4i KA24E, 2.7 TD27, 3.0 VG30E, 3.0TD ZD30, 3.2, 3.2D QD32, 3.3i VG33 - 4X4 (98-04),

# BUYERS GUIDE - OIL SEALS

<b>9415NOK.. Continued</b>	Rear Wheel Oil Seal Nok Seal	Sani AW/D21 2.4, i Z24, 2.5 TD25, 2.7D, TD TD27, 3.0 VG30E - 4X2 (86-99), 2.2 Z22, 2.4 Z24, 2.7 TD27, 3.0 VG30E - 4X4 (86-98), Terrano II 2.7 TD2 - 4X4 (00-02), Ssangyong Korando 2.3 K230 EL, Open Top S/W, 2.9 K290 EL, TDi, Open Top S/W, 3.2 K320 EL S/W, MUSSO 2.3 E230 EL S/W, 2.9 602, EL, EX, TDi, Exec., E290 TDi, Exec., 3.2 E320 EL Exec. (95-04), Toyota Hiace YH50/60 1.8 SWB / LWB P/van, LS Wagon 2Y Pet. (83-91), YH51/61 2.0 SWB/LWB 16 Seater Commuter, Super 10 Seater Custom Wagon, P/van 3Y Pet. (83-86), YH53/63 2.2 SWB/LWB P/van, Van, LS, Super T/14/16, GLX, Exec. Wagon, Siyaya Bus, P/van 4Y Pet. (All Local Models) (88-09), Hilux LN30/40/50/51/55 2.2 SWB/LWB P/up L Dies., 2.4 SWB/LWB D/cab, Raider P/up 2L Dies., YN58 2.2 LWB D/cab, Raider, SRX P/up 4Y Pet. (79-98), YN67 2.2 LWB D/cab, Raider D/cab P/up 4Y Pet. - 4X4 (86-94), YN51/56 1.8 SWB/LWB D/cab, S, SR, Raider P/up 2Y Pet., YN140 1.8 SWB/LWB D/cab, Raider, S, SRX P/up 2Y Pet. (86-05), LN65 2.4 LWB D/cab, Raider D/cab P/up 2L Dies., RN67 2.4 LWB D/cab, Raider D/cab P/up 22R Pet. - 4X4 (89-98), RN58 2.4 22R Pet., LN140/145 2.4i DLX, P/up 2L Dies., RZN194 2.7i LWB D/cab, Raider, SRX, Legend35 Raider, 3RZFE Pet. (94-05), LN57 2.8D LWB D/cab, Raider P/up 3L Dies. - 4X2, LN67 2.8D LWB, D/cab, Raider D/cab P/up 3L Dies. - 4X4 (95-98), RZN147 2.0 SWB/LWB D/cab, DLX, Raider, S, SR, SRX P/up 1RZ Pet., LN192R 3.0D LWB Raider D-E, Raider DLX D/cab D-E, Legend35 Raider, P/up 5L Dies., 3.0iD LWB Raider, Raider D/cab, P/up KZ-TE Dies. (98-05), RZN169 2.7i LWB D/cab, DLX S/cab, Raider S/D/cab, SRX D/cab, Legend 35 LWB P/up 3RZFE Pet., LN167 3.0D D/cab D-E, DLX, S/D/cab DE, Raider DE, Legend35 LWB P/up 5L Dies., 3.0iD LWB Raider S/cab & KZ-TE D/cab P/up, Legend35 - 4X4 (98-05), Stallion KF50 1.5 SR5, Commuter, Bus, P/up, P/van 5K Pet., YF50 1.8 SR5, P/up, P/van, Van 2Y Pet., LF50 2.4D P/up 2L5F Dies. (87-04), TUV KF20 1.3 Chassis Cab, P/up, P/van, Bus 4K Pet., 1.5 P/up 5K Pet. (82-87), Venture YF50 1.8 8/10 Seater P/van 2Y Pet., 2.2 10 Seater, GLE, Getaway 9 Seater S/W 4Y Pet., LF50 2.4D 10 Seater S/W 2L5F Dies. (91-04)
<b>9437A</b>	Front, Rear Wheel Oil Seal	Toyota Hilux YN67 2.2 LWB D/cab, Raider D/cab P/up 4Y Pet. - 4X4 (86-94), LN65 2.4 LWB D/cab, Raider D/cab P/up 2L Dies. - 4X4 (89-98), LN67 2.8D LWB, D/cab, Raider D/cab P/up 3L Dies. (95-98), Land Cruiser FJ80 4.0 DLX, GX, VX P/up 3F/F-E Pet. (90-92), FZJ/HZJ75 4.2 GX S/W, P/up 1FZF/HZ Dies. (91-97), FZJ80 4.5 Std., GX, VX, Turbo S/W, P/up 1FZ-FE Dies., Turbo Dies. (92-95), FZJ80 4.5 Std., GX, VX, Turbo S/W, P/up 1FZ-FE Dies., Turbo Dies. (95-06), FZJ105 4.5 Std., GX, Turbo P/up, S/W 1FZ-FE Dies., Turbo Dies. (95-98), HDJ/HZJ80 4.2 GX, Turbo S/W, P/up 1HD-FT, 1HZ Dies., T. Dies. (90-95), HDJ/HZJ80 4.2 Std., GX, VX, Turbo S/W, P/up 1HD-FT, 1HZ Dies., Turbo Dies. (95-01), HDJ100 4.2 Std., GX, VX S/W, 1HZ Pet., 4.5, 4.7 V8 (97-04), HZJ76 4.2D (2009-), HZJ105 4.2 Std., GX DSL, Turbo P/up, S/W 1HZ Dies., Turbo Dies. (98-06), PHJ75 3.9 DLX, GX, GX Turbo P/up Perkins236 2H Dies., FJ75 4.0 DLX, GX, VX 3F/F-E Pet. (85-92), UZJ100 4.5 V8 Std., GX, VX S/W, P/up 2UZ-FE Pet. - 4X4 (98-06)
<b>9507FS</b>	Rear Main Bearing Oil Seal	VW Crafter 2.5TDi Bus, P/van (2007-)
<b>9513FS</b>	Use - 9375FS	
<b>9513FS</b>	Rear Main Bearing Oil Seal	Mazda 6 2.5 Dynamic Activematic, Individual (03-14)
<b>9537</b>	Rear Main Bearing Oil Seal	Ford KA 1.3 (2005-)
<b>9537V</b>	Rear Main Bearing Oil Seal	Ford KA 1.3 (2005-)
<b>9566FS</b>	Rear Main Bearing Oil Seal	Ford "Boet" Bantam Rocam 1.3i XL, XLT, 1.4i TDCi, 1.6i XL, XLT, XLE, 1.8D XL (02-12)
<b>9573FS</b>	Rear Main Bearing Seal Corteco	Audi A1 1.2 TFSi CBZA, 1.4 TFSi CAXA/CAVG, 1.6 TDi CAYC (11-18), A3 1.4 TFSi CMSA (08-13), 1.4 TFSi CZCA, CZEA, 2.0TDi CRFC (13-17), VW Beetle 1.2 Tsi, 1.4 Tsi (2012-), EOS 1.4 Tsi (07-12), Golf VI 1.4 TSi Comfortline, Trendline, Highline (09-13), Jetta VI 1.2 TSi, 1.4 TSi (2011-), Cross Polo 1.6TDi (07-10), Polo 6R 1.2TDi CFWA, 1.4 CLSA, CLPB, 1.4TSi GTi CTHE, 1.6 CLSA, 1.6TDi (09-15), Scirocco 1.4TSi (2009-), Touran 1.2TSi, 1.4TSi (2011-)
<b>9580FS</b>	Rear Main Bearing Oil Seal	Audi A3 1.6TDi, 2.0TDi (04-14), A4 2.0TDi (2008-), A5 2.0TDi (08-14), A6 2.0TDi (11-14), Q3 2.0TDi (12-14), Q5 2.0TDi (09-14), VW Amarok 2.0 (2010-), Caddy 2.0 TDI (2005-), Crafter 2.0 BiTDi (2012-), CC Diesel (2009-), Golf VI 1.6 TDI, 2.0TDi (09-13), Jetta 2.0TDi (2011-), Passat 2.0TDi (2008-), Polo 6C 1.6TDi (2014-), Touran 2.0TDi (2011-)
<b>9582FS</b>	Rear Main Bearing Oil Seal	Audi A3 1.8 TFSi CDAA, BYT, BZB (08-13), VW Amarok 2.0 TSI (2011-), Golf VI TSI GTI (09-13), Passat 1.8 TSI (2008-)
<b>9585FS</b>	Rear Main Bearing Oil Seal	Audi A3 1.6 TDI (2014-)
<b>9586FS</b>	Rear Main Bearing Seal Corteco	Audi A3 1.6 TDi CLHA, 2.0TDi CRFC (12-17), Golf VII 2.0TDi (2013-)
<b>9587FS</b>	Timing Cover Oil Seal	Audi A3 1.6 TDI (2014-), VW Golf VII 2.0 TDI (2013-)
<b>9589FS</b>	Rear Main Bearing Oil Seal	Audi A1 1.0 TFSi (11-18), A3 1.2 TFSi, 1.4 TFSi (12-14), A3 1.4 TFSi (13-17), VW Golf VII 1.4 (2013-), UP 1.0 (2015-)
<b>9592FS</b>	Rear Main Bearing Oil Seal	Audi A3 (12-14), A4 1.8TFSi (12-14), S3 2.0TFSi CJXB (13-17), Q5 (09-14), VW Golf VII (2013-)
<b>9602V</b>	Rear Main Bearing Oil Seal	Isuzu KBD25 2.0 P/up C190 (78-89), KBD28 2.5 4JA1 (81-89), KB29 2.3 P/up 4ZD1 (83-89), KB44 2.3 4ZD1 - 4X4 (79-89), KB260 2.6 LE, D/cab, LX P/up 4ZE1 (92-04), KB220 2.2 LE P/up, KB230 2.3 P/up 4ZD1, KB260 2.6 D/cab, LE, LX (89-04), KB250D 2.5 Fleetside, LE, D/Cab P/up 4JA1, KB280DT 2.8 D/cab LE, LX, Frontier P/up Turbo 4JB1 - 4X2, KB250D 2.5 LE, D/cab P/up 4JA1, KB280DT 2.8 LE, LX, D/cab P/up Turbo 4JB1 - 4X4 (89-04), KB250Dc 2.5, KB300TDi 3.0 LX - 4X2, 4X4 (04-09), KB300TDi 3.0 D-TEQ - 4X2, 4X4 (07-11), Relay .0 P/van, Bus 4ZC1 (89-95), WFR 1.8 11FVX/ 12FVX Bus, P/van 4ZB1 (83-89)



## BUYERS GUIDE - BEARING KITS

<b>PQ102P</b>	Front Wheel Bearing Kit	Mazda 1300 (70-74), 323 1.3, 1.4, 1.6 (77-81)
<b>PQ103</b>	Front Wheel Bearing Kit	Mazda 616 (71-74), Capella 1.6, 1.8 (74-79), Luce 573 (76-78)
<b>PQ104</b>	Front Wheel Bearing Kit	VW Beetle 1.3, 1.5, 1.6 (61-79)
<b>PQ105</b>	Front Wheel Bearing Kit	Audi 100/4 1.6 LS YV, 100/5 1.9 WH, 200 2.1 GLS, GLX, 400 1.8 JW, 500 2.1/2.2 WB, WC SE PR (77-92)
<b>PQ106</b>	Front & Rear Wheel Bearing Kit	BMW 3 Series E30 316 1.8 M10, 316i 1.6 M40, 318i 1.8 M40, 320i M20/50, 323i M50, 325i M52, 333i M30 (83-92), E36/ Dolphin Shape 316i 1.8 M40, 318i 1.9 M44, 320i 2.0 M50, 323i 2.5 M52, 325i M50, 328i 2.8, 3.0 M52, Z3 2.8, 3.0 Roadster (92-00), Chevrolet Aveo 1.5 L, LS, LT, 1.6 LS (03-15), Daewoo Espero 1.8 CD C18LE, 2.0 CD C20LE (96-99), Lanos I 1.35i S, 1.6 SX, Nubira I 1.6 SX, 2.0 CDX, Nubira II 1.6 SX, SX S/W, 2.0 CDX, Exec., S/W (97-03), Ford "Boet" Bantam Rocam 1.3i, XL, XLT, 1.4i TDCi, 1.6i, XL, XLT, XLE, 1.8D XL (02-12), Escort FWD MkVI 1.4i H/back, Sedan CVH/PTE, 1.6i GL, GLE H/back, Sedan Zetec, 1.8i GLi, TDi H/back, Sedan, Zetec, 1.8TDi Endura (95-00), Fiesta I 1.3, i Flair, Flite, Play, Fun, Endura-EM5, 1.4, i Flair, Trend, Fun, Zetec CVH/PTE, 1.6, i Ambiente', Flair, Forte', Ghia, Rsi, Sport, Trend (97-04), Fiesta II 1.4i, Trend Zetec (04-09), Ikon 1.3, Low, LX CLTA, 1.4, Low, LX, 1.4 Tdci, 1.6i, Low, High, LX, CLX, CLTA (01-11), Ka 1.3i Ambiente, Trend, Collection Rocam A9A, A9B (05-09), Mazda 121 Soho 1.3, i 3/5 Dr. H/back, Endura-EM5, 1.4i 3/5 Dr. H/back Zetec CVH/PTE (97-99), Opel Ascona 1.6 GL 16SH, 1.8 GLS 18L (82-87), Astra F 180i, iE 18SE/ XE, XL, 200i, e, ts 20SE/ XE (93-99), Corsa B 1.8i GSi H/back (96-03), Kadett D, E 1.6 GL, GLS, GSE, L, Rebel, Cub 16SH/ SE, 160i, GSi Aspen 16SE, 1.8 GTE 18E, L 18LV, GSi Hatch 18L, GLX 18SV, GSi 18E/ SE (80-93), Kadett E 2.0 GSi 20XE, SGi 20SEH, 200, iS 20SE, Boss 20SEH, CD 20SHE, GSi, Super Boss 20SEH (87-93), Kadett F 180i, iE, GSi 18SE, 200is 20XE (93-99), Monza 1.8 CLX, GLE, GLX, Convertible, GLi 18SE/SV, 2.0 CD, CLi 2.0XE, CLE, GLE 20SE/V (86-93)
<b>PQ107</b>	Front Wheel Bearing Kit	Daewoo Cielo 1.5 GL, GLX, GTX, 150i L (96-99), Lanos II 1.4 S, 1.6 SX (97-03), VW Caddy 1.6 SWB, Caddy Club P/up JK Dies., HM Pet., 1.8 SWB L, Sport P/up HV Pet. (81-97), Citi Golf 1.3 L ET/GY, 1.6 Blues, Chico, Chico Lux, Deco, Designa, L, Ritz, Shuttle, Sonic, Sport HM, HV, FR, 1.6iL, Life, VeloCiti, TenaCiti, CitiStorm, - Sport, - Rox, Rhythm, MKI AFX, 1.8 CTi, Designa, L Sport BZF (83-09), 1.3 L ET/GY (83-87), 1.3 L Shuttle, Chico, Chico, Lux ET/ GY/ AJD (87-03), 1.4, iL, Chico, Rhythm, Citi com, VeloCiti, TenaCiti, CitiStorm, - Sport, Rox, Rhythm, Wolf, - XCite, Billabong AGY/BSV (99-09), 1.6 Blues, Chico, Chico Lux, Deco, Designa, L, Ritz, Shuttle, Sonic, Sport HM, HV, FR, 1.6iL, Life, VeloCiti, TenaCiti, CitiStorm, -Sport, - Rox, Rhythm, MKI AFX, 1.8 CTi, Designa, L Sport BZF (83-09), Fox 1.3 L, L Trippa GY, 1.6 L HM, 1.8 L Sport HV (87-96), Golf I 1.1 GL, L, LS ET/EG, 1.3 GL, L, LS GF, 1.5 GL Diesel, GLS, LS CK/EM/ JB, 1.6 GL Diesel, GT, GTS, GTX JK/CR FR, 1.8 Gti EV (78-84), Jetta I 1.3 GL, GX ET/ GF, 1.5 GLS, GLX JB, 1.6 GLS EM, 1.8 GLi DX (80-85)
<b>PQ107A</b>	Front Wheel Bearing Kit	Daewoo Cielo 1.5 GL, GLX, GTX, 150i L (96-99), Lanos II 1.4 S, 1.6 SX (97-03), VW Caddy 1.6 SWB, Caddy Club P/up JK Dies., HM Pet., 1.8 SWB L, Sport P/up HV Pet. (81-97), Citi Golf 1.3 L ET/GY (83-87), 1.3 L Shuttle, Chico, Chico, Lux ET/ GY/ AJD (87-03), 1.4, iL, Chico, Rhythm, Citi com, VeloCiti, TenaCiti, CitiStorm, - Sport, Rox, Rhythm, Wolf, - XCite, Billabong AGY/BSV (99-09), 1.6 Blues, Chico, Chico Lux, Deco, Designa, L, Ritz, Shuttle, Sonic, Sport HM, HV, FR, 1.6iL, Life, VeloCiti, TenaCiti, CitiStorm, -Sport, - Rox, Rhythm, MKI AFX, 1.8 CTi, Designa, L Sport BZF (83-09), Fox 1.3 L, L Trippa GY, 1.6 L HM, 1.8 L Sport HV (87-96), Golf I 1.1 GL, L, LS ET/EG, 1.3 GL, L, LS GF, 1.5 GL Diesel, GLS, LS CK/EM/ JB, 1.6 GL Diesel, GT, GTS, GTX JK/CR FR, 1.8 Gti EV (78-84), Jetta I 1.3 GL, GX ET/ GF, 1.5 GLS, GLX JB, 1.6 GLS EM, 1.8 GLi DX (80-85)
<b>PQ108</b>	Rear Wheel Bearing Kit	Daewoo Cielo 1.5 GL, GLX, GTX, 150i L, Espero 1.8 CD, C18LE (96-99), Lanos I 1.35i S, 1.6 SX, Lanos II 1.4 S, 1.6 SX, Numbira I 1.6 SX, 2.0 CDX, Numbira II 1.6 SX, SX S/W, 2.0 CDX, Exec., S/W (97-03), Opel Ascona 1.3 L 13NV/SC, 1.6 GL 16SH (82-87), Astra F 140i, iS 14NV, 160i, iE, iS, Estate 16NZ, 180i, iE 18SE/ XE, XL, 200i, e, ts 20SE/ XE (93-99), Corsa B 130, i, Lite, iE, iS, Chill Hatch / Sedan 13NE, 140i, Classic, Active, Lite, Lite+, Comfort, Chill, Sport, S 14NE, Hatch/ Sedan, 160, i, iE, Classic, GSi, i Sport, S Hatch/ Sedan, 16SE, 1.8i GSi Hatch (96-03), Corsa LDV 130i Utility P/up 13NE, 1.4i Utility, S P/up 14NE, 1.6i Utility Sport P/up 16NZ, 1.7D Utility P/up X17D (97-04), Corsa P/Van 1.3i Pronto 13NE (99-00), Kadett D, E 1.2 L 12NS, 1.3 Cub, GL, GLS, LS, Rebel 13NV, 140 CL, Cub 14NE/NV, 1.6 GL, GLS, GSE, L, Rebel, Cub 16SH/SE, 160i, GSi Aspen 16SE (80-93), 1.8 GTE 18E, L 18LV, GSi Hatch 18L, GLX (84-93), Kadett E 2.0 GSi 20XE, SGi 20SEH, 200, iS 20SE, Boss 20SEH, CD 20SHE, GSi, Super Boss 20SEH (87-93), Kadett F 140, S 14NE, 160i, iS, GSi, Aspen 16SV/NZ (93-99), 180i, iE, GSi 18SE, 200is 20XE (93-99), Monza 160 GSi, i Aspen 16SE/NZ, CLS 16SV, 1.8 CLX, GLE, GLX, Convertible, GLi 18SE/SV, 2.0 CD, CLi 2.0XE, CLE, GLE 20SE/V (86-93)



## BUYERS GUIDE - BEARING KITS

<p><b>PQ108... Continued</b></p>	<p>Rear Wheel Bearing Kit</p>	<p>VW Citi Golf 1.3 L ET/GY, 1.6 Blues, Chico, Chico Lux, Deco, Designa, L, Ritz, Shuttle, Sonic, Sport HM, HV, FR, 1.6iL, Life, VeloCiti, TenaCiti, CitiStorm, - Sport, - Rox, Rhythm, MKI AFX, 1.8 CTi, Designa, L Sport BZF (83-09), 1.3 L Shuttle, Chico, Chico Lux ET/ GY/ AJD (87-03), 1.4, iL, Chico, Rhythm, Citi com, VeloCiti, TenaCiti, CitiStorm, - Sport, Rox, Rhythm, Wolf, - XCite, Billabong AGY/ BSV (99-09), Fox 1.3 L, L Trippa GY, 1.6 L HM, 1.8 L Sport HV (87-96), Golf I 1.1 GL, L, LS ET/EG, 1.3 GL, L, LS GF (78-82), 1.5 GL Diesel, GLS, LS CK/EM/ JB, 1.6 GL Diesel, GT, GTS, GTX JK/CR FR, 1.8 Gti EV (78-84), Golf II 1.3 CL GY, 1.6 CSL HM, 1.8 8/16V CSX, GTS, GTi KR, EV, 2.0 8/16V GTi AAL (84-92), Golf III 1.6 GS ACG, 1.8 GSX, GTS ACH, 2.0 GTi, Exec. 2E, 2.8 VR6, Exec. AAA (92-99), Jetta I 1.3 GL, GX ET/ GF, 1.5 GLS, GLX JB, 1.6 GLS EM, 1.8 GLi DX (80-85), Jetta II 1.6 CSL HM, 1.8 8/16V CLi, CLi Exec., CLX, CSi, CSX EV/KR, 2.0 8/16V CLi, Exec. AAL (85-92), Jetta III 1.6 CSL ACG, 1.8 CLX/CSX ACH, 2.0 CLi, Exec. 2E, 2.8 VR6 Exec. AAA (92-99), Passat I &amp; II 1.3 L, LS H/back, Sedan, Variant ZF, 1.5 GL, LS Fastback, S/W CK, 1.6 GL, GLS, LS, LX Fastback, S/W, Sedan, Coupe, Variant, YN/YP/WN, 1.8 CL Sedan, S/W JV/KR (74-87), Passat I &amp; II 1.9 GLS H/back, GLX Sedan, S/W WN, 2.2 CLi, CLX SG/MX (81-87), Polo 6N 1.4 Classic, Playa Lux AEX, 1.6 Classic, Playa, Lux AEE, 1.8 Classic, Playa, Lux ADZ (96-03)</p>
<p><b>PQ108A</b></p>	<p>Rear Wheel Bearing Kit</p>	<p>Daewoo Cielo 1.5 GL, GLX, GTX, 150i L, Espero 1.8 CD, C18LE (96-99), Lanos I 1.35i S, 1.6 SX, Lanos II 1.4 S, 1.6 SX, Numbira I 1.6 SX, 2.0 CDX, Numbira II 1.6 SX, SX S/W, 2.0 CDX, Exec., S/W (97-03), Opel Ascona 1.3 L 13NV/SC, 1.6 GL 16SH (82-87), Astra F 140i, iS 14NV, 160i, iE, iS, Estate 16NZ, 180i, iE 18SE/ XE, XL, 200i, e, ts 20SE/ XE (93-99), Corsa B 130, i, Lite, iE, iS, Chill Hatch / Sedan 13NE, 140i, Classic, Active, Lite, Lite+, Comfort, Chill, Sport, S 14NE, Hatch/ Sedan, 160, i, iE, Classic, GSi, i Sport, S Hatch/ Sedan, 16SE, 1.8i GSi Hatch (96-03), Corsa LDV 130i Utility P/up 13NE, 1.4i Utility, S P/up 14NE, 1.6i Utility Sport P/up 16NZ, 1.7D Utility P/up X17D (97-04), Corsa P/Van 1.3i Pronto 13NE (99-00), Kadett D, E 1.2 L 12NS, 1.3 Cub, GL, GLS, LS, Rebel 13NV, 140 CL, Cub 14NE/NV, 1.6 GL, GLS, GSE, L, Rebel, Cub 16SH/SE, 160i, GSi Aspen 16SE (80-93), 1.8 GTE 18E, L 18LV, GSi Hatch 18L, GLX (84-93), Kadett E 2.0 GSi 20XE, SGi 20SEH, 200, iS 20SE, Boss 20SEH, CD 20SHE, GSi, Super Boss 20SEH (87-93), Kadett F 140, S 14NE, 160i, iS, GSi, Aspen 16SV/NZ (93-99), 180i, iE, GSi 18SE, 200is 20XE (93-99), Monza 160 GSi, i Aspen 16SE/NZ, CLS 16SV, 1.8 CLX, GLE, GLX, Convertible, GLi 18SE/SV, 2.0 CD, CLi 2.0XE, CLE, GLE 20SE/V (86-93), VW Citi Golf 1.3 L ET/GY, 1.6 Blues, Chico, Chico Lux, Deco, Designa, L, Ritz, Shuttle, Sonic, Sport HM, HV, FR, 1.6iL, Life, VeloCiti, TenaCiti, CitiStorm, - Sport, - Rox, Rhythm, MKI AFX, 1.8 CTi, Designa, L Sport BZF (83-09), 1.3 L Shuttle, Chico, Chico Lux ET/ GY/ AJD (87-03), 1.4, iL, Chico, Rhythm, Citi com, VeloCiti, TenaCiti, CitiStorm, - Sport, Rox, Rhythm, Wolf, - XCite, Billabong AGY/ BSV (99-09), Fox 1.3 L, L Trippa GY, 1.6 L HM, 1.8 L Sport HV (87-96), Golf I 1.1 GL, L, LS ET/EG, 1.3 GL, L, LS GF (78-82), 1.5 GL Diesel, GLS, LS CK/EM/ JB, 1.6 GL Diesel, GT, GTS, GTX JK/CR FR, 1.8 Gti EV (78-84), Golf II 1.3 CL GY, 1.6 CSL HM, 1.8 8/16V CSX, GTS, GTi KR, EV, 2.0 8/16V GTi AAL (84-92), Golf III 1.6 GS ACG, 1.8 GSX, GTS ACH, 2.0 GTi, Exec. 2E, 2.8 VR6, Exec. AAA (92-99), Jetta I 1.3 GL, GX ET/ GF, 1.5 GLS, GLX JB, 1.6 GLS EM, 1.8 GLi DX (80-85), Jetta II 1.6 CSL HM, 1.8 8/16V CLi, CLi Exec., CLX, CSi, CSX EV/KR, 2.0 8/16V CLi, Exec. AAL (85-92), Jetta III 1.6 CSL ACG, 1.8 CLX/CSX ACH, 2.0 CLi, Exec. 2E, 2.8 VR6 Exec. AAA (92-99), Passat I &amp; II 1.3 L, LS H/back, Sedan, Variant ZF, 1.5 GL, LS Fastback, S/W CK, 1.6 GL, GLS, LS, LX Fastback, S/W, Sedan, Coupe, Variant, YN/YP/WN, 1.8 CL Sedan, S/W JV/KR (74-87), Passat I &amp; II 1.9 GLS H/back, GLX Sedan, S/W WN, 2.2 CLi, CLX SG/MX (81-87), Polo 6N 1.4 Classic, Playa Lux AEX, 1.6 Classic, Playa, Lux AEE, 1.8 Classic, Playa, Lux ADZ (96-03)</p>
<p><b>PQ109</b></p>	<p>Front Wheel Bearing Kit</p>	<p>Nissan Langley 1.5 GL, L, SSS, Trebon, Exa Turbo E15 (83-88), Pulsar 1.4 DL, GX A14, 1.5 GL, Panache, SX E15 (80-87)</p>
<p><b>PQ110</b></p>	<p>Front Wheel Bearing Kit</p>	<p>Ford Cortina MkIII 2.5 XL, S/W Essex EV25, 3.0 GT, L, XL, XLE "Big Six" Essex EV30 (71-77), Cortina MkIV 3.0 V6 Leisure, P/up Essex EV30 (77-80), MkV 3.0 V6 Leisure P/up Essex EV30 (80-86), Escort FWD MkIII 1.3 GL, L Kent, 1.6 GLE, L, Sport, XR3, i HL16CVH (81-86)</p>
<p><b>PQ113</b></p>	<p>Front Wheel Bearing Kit</p>	<p>Toyota Corolla RWD TE31 1.6 Sprinter, SR4/5, Black Hawk, Silver Wolf 2T, AE/TE71 1.6 GL, S/W, GLS Sprinter, SE 2T, TB TE72, 1.8 GLS, SE 3T (80-88), Corolla KE70 1.3 P/van 4K (84-88)</p>
<p><b>PQ114</b></p>	<p>Front Wheel Bearing Kit</p>	<p>Peugeot 404 1.8, 1618 (63-78), 504 2.0 (71-73), 404 1618, 2.0 (67-80)</p>
<p><b>PQ116</b></p>		<p>Peugeot 504, 505 (71-85), Renault R5 1.3, 1.4 (75-85)</p>
<p><b>PQ118</b></p>	<p>Front Wheel Bearing Kit</p>	<p>Mitsubishi Colt 1.6, 2.0, 2.6 (72-84)</p>
<p><b>PQ120</b></p>	<p>Front Wheel Bearing Kit</p>	<p>Ford Cortina MkIII 1.6 L P/up Kent, 1.6 L, Std., XL Kent, 2.0 OHC GT, V4 L, XL, S/W Essex EV20, 2.0 V4 P/up Koln T20, 2.5 L P/up Essex EV25 (71-77), Cortina MkIV 1.3 L Kent, 1.6 GL, L, S/W Kent, 1.6 P/up Kent, 2.0 GL, GLE, S/W Koln T20 (77-80), Cortina MkV 1.3 L Kent, 1.6 GL, L, Kent, 1.6 P/up Kent, 2.0 Ghia, GL Koln T20 (80-86), Escort MkI/II 1.3 30, 35, 45 P/van Kent, 1.6 45 P/van Kent (68-81), Escort RWD MkII 1.3 L Kent, 1.6 GL, Sport Kent, RS2000 Koln (75-81)</p>



## BUYERS GUIDE - BEARING KITS

<b>PQ121</b>	Front Wheel Bearing Kit	Nissan B140 1.4 A14SP/van, S/W, Deluxe, Std. Sport, CHAMP P/up (80-08)
<b>PQ122</b>	Front Wheel Bearing Kit	Opel Ascona 1.3 L 13NV/SC (82-87), Kadett D, E 1.2 L 12NS, 1.3 Cub, GL, GLS, LS, Rebel 13NV, 140 CL, Cub 14NE/ NV, 1.6 GL, GLS, GSE, L, Rebel, Cub 16SH/ SE, 160i, GSi Aspen 16SE (80-93), Monza 160 GSi, i Aspen 16SE/ NZ, CLS 16SV (86-93)
<b>PQ123</b>	Front Wheel Bearing Kit	Ford Escort RWD Mkl 1.1 Kent, 1.3 GT, L, Super, S/W Kent (68-75), Mkl/II 1.1 300 P/van Kent (68-81)
<b>PQ125</b>	Front Wheel Bearing Kit	Renault R5 1.3, GTL, LS, LSS, TS 810-25, 1.4 TS 847-C2J, 1.3 Panel Van (75-85)
<b>PQ126</b>	Front Wheel Bearing Kit	Daihatsu Charade 0.8 CX, CXL G11 CB22, Turbo G21 CB60 (83-85), Cuore 847cc ED10 (97-03)
<b>PQ131</b>	Front Wheel Bearing Kit	Opel Rekord 2.0 Berlina, GL, GLS, L, S/W CIH, 2.0i CLE, CLS, GL, GLE, Irmscher, 2.2E CIH, 380i, V6 CD, GSi 38GE (82-95)
<b>PQ133</b>	Front Wheel Bearing Kit	Fiat 132 1.6, 1.8, 2.0 (75-80)
<b>PQ134</b>	Front Wheel Bearing Kit	Nissan Stanza 1.6 DL, Resort, S/W L16, 1.8 GL, Resort, S/W SSS L18 (80-84)
<b>PQ136</b>	Front Wheel Bearing Kit	Toyota Condor 1.6 Estate, TE, 5L, 1.8 2Y, 2.0i Estate, TE, 1RZ Pet., 2.4i Estate, TE, TX 2RZ-E, 3.0D Estate, TE, 5L Dies. - 4X2 (00-05), Cressida TX30 1.8 DX 3T, TX62 1.8 L, LS 3T, YX70 1.8 LS, Exec. (80-89), RX60 2.0 GL, GLE, GLX, S/W 21R, RX70, YX72 2.0 GL, GL, GLE, GLX (81-92), GX60 2.0 GLi6 1G-E, GX7 2.0 GLi6 1G-E, 1G-FE (83-92), MX63 2.8i 5M-E, MX73 2.8i RSi, RSi Exec. 5M-GE (84-89), MX75 3.0i ECT, GLS 7MG-E (86-92), RX72 2.4 GL, GL S/W, GLE, GLE S/W 22R, RX73 2.4 GLE, GLE S/W 22R With I.R.S. (Independent Rear Suspension) (87-92), Stallion KF50 1.5 SR5, Commuter, Bus, P/up, P/van 5K Pet., YF50 1.8 SR5, P/up, P/van, Van 2Y Pet., LF50 2.4D P/up 2L5F Dies. (87-04), Venture YF50 1.8 8/10 Seater P/van 2Y Pet., 2.2 10 Seater, GLE, Getaway 9 Seater S/W 4Y Pet., LF50 2.4D 10 Seater S/W 2L5F Dies. (91-04)
<b>PQ137</b>	Front Wheel Bearing Kit	Opel Rekord 2.0 Berlina, GL, GLS, L, S/W CIH, 2.0i CLE, CLS, GL, GLE, Irmscher, 2.2E CIH, 380i, V6 CD, GSi 38GE (82-95)
<b>PQ138</b>	Front Wheel Bearing Kit	Nissan Laurel C31 2.0 CA/L20, 2.8 SGL 5L28 (80-87), Skyline R30 1.8 L18, 2.0 GL L20, 2.8 GLX, GTX L28/2 (82-87)
<b>PQ139</b>	Front Wheel Bearing Kit	Chery QQ3 0.8 TE, TX, 1.1 TXE (2008-), Mazda 626 1.6 S Sedan, Hatch F6, 1.8 L Sedan, Hatch F8, 2.0 SL, SLE, SLX, 2.0i EGi, SLi FE (Rear Drum brakes), 2.0i 16V SLi FE (Rear Disc brakes) (83-93), VW Passat I & II 1.3 L, LS H/back, Sedan, Variant ZF, 1.5 GL, LS Fastback, S/W CK, 1.6 GL, GLS, LS, LX Fastback, S/W, Sedan, Coupe, Variant, YN/YP/ WN, 1.8 CL Sedan, S/W JV/KR (74-87), Passat I & II 1.9 GLS H/back, GLX Sedan, S/W WN, 2.2 CLi, CLX SG/MX (81-87)
<b>PQ140</b>	Front Wheel Bearing Kit	Fiat 128 1100, 1300 (71-79)
<b>PQ141</b>	Front Wheel Bearing Kit	Ford Bantam 1300 P/up Kent 2V, 1400 Leisure, Nite P/up CVH/FUA, 1600 Leisure Explorer, Nite P/up CVH (83-94), Escort FWD MkIII 1.3 GL, L Kent, 1.6 GLE, L, Sport, XR3, i HL-16CVH (81-86), Mazda Rustler 1.3 SWB P/up Kent 2V Pet., 1.4 SWB P/up CVH/FUA Pet., 1.6 SWB, LX P/up CVH/ LUC Pet. (86-94)
<b>PQ142</b>	Front Wheel Bearing Kit	Ford Sapphire 1.6 L Kent, 2.0, i GL, GLE, GLEA, GLi, GLi Exec. Koln, 3.0 Ghia, GLX Essex (89-93), Sierra 1.6 GL, GL S/W, L Kent, 2.0 GL, GL S/W Koln, 2.0 LX Koln, 2.3 GLE, Cologne, 3.0, i GLS, GLX, LX, RS, XR6 Essex (83-93)
<b>PQ143</b>	Rear Wheel Bearing Kit	Hyundai Atos 1.0 Prime G4HC (00-05)
<b>PQ144</b>	Rear Wheel Bearing Kit	Mazda 626 1.6 S Sedan, Hatch F6, 1.8 L Sedan, Hatch F8, 2.0 SL, SLE, SLX, 2.0i EGi, SLi FE (Rear Drum brakes) (83-93)
<b>PQ145</b>	Rear Wheel Bearing Kit	Ford Cortina MkIII 1.6 L P/up Kent, 1.6 L, Std., XL Kent, 2.0 OHC GT, V4 L, XL, S/W Essex EV20, 2.0 V4 P/up Koln T20, 2.5 L P/up Essex EV25, 2.5 XL, S/W Essex EV25, 3.0 GT, L, XL, XLE "Big Six" Essex EV30 (71-77), Cortina MkIV 1.3 L Kent, 1.6 GL, L, S/W Kent, 1.6 P/up Kent, 2.0 GL, GLE, S/W Koln T20, 3.0 V6 Ghia, GLS, S, S/W Essex EV30 (77-80), Cortina MkV 1.3 L Kent, 1.6 GL, L, Kent, 2.0 Ghia, GL Koln T20, 3.0 V6 GLS, GLS XR6, Essex EV30 (80-86), Nissan Laurel C31 2.0 CA/L20, 2.8 SGL 5L28 (Local) (80-87), Skyline R30 1.8 L18, 2.0 GL L20, R31 2.0 GL, GLE CA20 (Local) (82-92), Opel Rekord 2.0 Berlina, GL, GLS, L, S/W CIH, 2.0i CLE, CLS, GL, GLE, Irmscher, 2.2E CIH, 380i, V6 CD, GSi 38GE (82-95), Toyota Corolla RWD TE31 1.6 Sprinter, SR4/5, Black Hawk, Silver Wolf 2T, AE/TE71 1.6 GL, S/W, GLS Sprinter, SE 2T, TB, TE72 1.8 GLS, SE 3T (80-88), Cressida TX30 1.8 DX 3T, TX62 1.8 L, LS 3T, YX70 1.8 LS, Exec. (2Y) (80-89), Cressida RX60 2.0 GL, GLE, GLX, S/W 21R, RX70, YX72 2.0 GL, GL, GLE, GLX (81-92), Cressida RX72 2.4 GL, GL S/W, GLE, GLE S/W 22R (87-92)
<b>PQ146</b>	Rear Wheel Bearing Kit	Chevrolet Spark 0.8 L, LS, 1.0 LT, LS (03-10), Daewoo Matiz 800cc S, SE F8CV (99-03)
<b>PQ150</b>	Rear Wheel Bearing Kit	Honda Ballade SA4 1300 EN4 (82-85), Prelude 1.8 EX ES/ET (84-87)
<b>PQ151</b>	Rear Wheel Bearing Kit	Audi 100/4 1.6 LS YV, 100/5 1.9 WH, 200 2.1 GLS, GLX, 400 1.8 JW, 500 2.1/2.2 WB, WC SE PR (77-92), 500 2.2 E PR, 2.3 E, SE, AAR, 2.8 SEL AAH (92-94), A4 1.8 8D2, B5 Exec ADR, 1.8T APU (95-01), A6 2.4 Avant Multitronic., Tiptronic, AGA, ALF, AML, APS, ARJ, 2.5TDi Multitronic Avant SW., BCZ/BDG/BFC, 2.6 ABC (Std) (97-03), VW Caddy 1.6 SWB, Caddy Club P/up JK Dies., HM Pet., 1.8 SWB L, Sport P/up HV Pet. (81-97)

## BUYERS GUIDE - BEARING KITS

<b>PQ152</b>	Rear Wheel Bearing Kit	Nissan Langley 1.3 GL E13, 1.5 GL, L, SSS, Trebon, Exa Turbo E15 (83-88), Pulsar 1.3 S E13, 1.4 DL, GX A14, 1.5 GL, Panache, SX E15 (80-87)
<b>PQ153P</b>	Rear Wheel Bearing Kit	Ford Falcon 4.0 GLi, Fairmont, Fairmont, Futura XR6 Mpi (96-03), Ranchero 4.0 GLi, Outback, XR6 P/up 250 (97-99)
<b>PQ154</b>	Rear Wheel Bearing Kit	Ford Escort RWD MkI 1.1 Kent, 1.3 GT, L, Super, S/W Kent, 1.6 GT, L, XL Kent (68-75), Escort MkI/II 1.1 300 P/van Kent, 1.3 30, 35, 45 P/van Kent, 1.6 45 P/van Kent (68-81), Escort RWD MkII 1.3 L Kent, 1.6 GL, Sport Kent, RS2000 Koln (Local) (75-81), Nissan B140 1.4 A14SP/van, S/W, Deluxe, Std. Sport, CHAMP P/up (80-08), Stanza 1.6 DL, Resort, S/W L16, 1.8 GL, Resort, S/W, SSS L18 (Local) (80-84), Toyota Corolla RWD TE31 1.6 Sprinter, SR4/5, Black Hawk, Silver Wolf 2T, AE/TE71 1.6 GL, S/W, GLS Sprinter, SE 2T, TB, TE72 1.8 GLS, SE 3T (Sedan) (80-88), Corolla TE71 1.6 P/van 2T (83-89), Corolla KE70 1.3 P/van 4K (Local) (84-88), Cressida TX30 1.8 DX 3T, TX62 1.8 L, LS 3T, YX70 1.8 LS, Exec. (3T) (80-89), RX60 2.0 GL, GLE, GLX, S/W 21R, RX70, YX72 2.0 GL, GL, GLE, GLX (81-92), RX72 2.4 GL, GL S/W, GLE, GLE S/W 22R (81-86)
<b>PQ156</b>	Rear Wheel Bearing Kit	Kia Pride 1.3i LX 5 Dr. H/back (90-04), Mazda 323 FWD 1.3 S, H/back, Sedan E3, 1.5 GLC, SL, SLX, Sport H/back, Sedan E5 (81-88)
<b>PQ161</b>	Rear Wheel Bearing Kit	VW Beetle 1.2, 1.3, 1.5, 1.6 (61-79)
<b>PQ164</b>	DNO	
<b>PQ166</b>	Front Wheel Bearing Kit	BMW 1800Sa, 1804, 2000Sa, 2004, 2500, 2800, 3.0L, 3.0S, 518, I, 520, I, 525, 528, 528i, 530, 535i
<b>PQ167</b>	Front Wheel Bearing Kit	VW Golf II 1.3 CL GY, 1.6 CSL HM, 1.8 8/16V CSX, GTS, GTi KR, EV, 2.0 8/16V GTi AAL (89-92), Golf III 1.6 GS ACG, 1.8 GSX, GTS ACH, 2.0 GTi, Exec. 2E, 2.8 VR6, Exec. AAA (92-99), Jetta II 1.6 CSL HM, 1.8 8/16V CLi, CLi Exec., CLX, CSi, CSX EV/KR, 2.0 8/16V CLi, Exec. AAL (88-92), Jetta III 1.6 CSL ACG, 1.8 CLX/ CSX ACH, 2.0 CLi, Exec. 2E, 2.8 VR6 Exec. AAA (92-99), Polo 6N 1.8 Classic, Playa, Lux ADZ (96-03)
<b>PQ168</b>	Front Wheel Bearing Kit	Ford Sapphire 1.6 L Kent, 2.0, i GL, GLE, GLEA, GLi, GLi Exec. Koln, 3.0 Ghia, GLX Essex (89-93), Sierra 1.6 GL, GL S/W, L Kent, 2.0 GL, GL S/W Koln, 2.0 LX Koln, 2.3 GLE, Cologne, 3.0, i GLS, GLX, LX, RS, XR6 Essex (83-93)
<b>PQ169</b>	Front Wheel Bearing Kit	VW Golf II 1.3 CL GY, 1.6 CSL HM, 1.8 8/16V CSX, GTS, GTi KR, EV, 2.0 8/16V GTi AAL (84-89), Jetta II 1.6 CSL HM, 1.8 8/16V CLi, CLi Exec., CLX, CSi, CSX EV/KR, 2.0 8/16V CLi, Exec. AAL (85-92)
<b>PQ170</b>	Front Wheel Bearing Kit	Isuzu KB20 1.6 P/up G161Z Pet., KB21 1.6 P/up G161Z Pet., KB22 1.8 P/up G180Z Pet., KBD20 2.0 P/up C190, KBD21 2.0 P/up C190, KBD22 2.2 LE, P/up C223, KB23 2.0 P/up G200Z, KB24 2.3 LE 4ZD1, KB25 1.6 P/up G161Z, KB26 1.6 P/up G161Z, 1.8 P/up G180Z, KBD23 2.5 LE, P/up 4JA1, KBD25 2.0 P/up C190 (78-89), KBD26 2.0 P/up C190, KBD27 2.2 C223, KBD28 2.5 4JA1 (81-89), KB27 1.8 P/up G180Z, KB28 2.0 P/up G200Z, KB29 2.3 P/up 4ZD1 (83-89)
<b>PQ171</b>	Front Wheel Bearing Kit	C.A.M. Inyathi, Jinbei Haise Minibus 2.2i Std., Rhino 2.2i, 2.8i (2007-), Toyota Hiace YH50/60 1.8 SWB / LWB P/van, LS Wagon 2Y Pet. (83-91), YH51/61 2.0 SWB/LWB 16 Seater Commuter, Super 10 Seater Custom Wagon, P/van 3Y Pet. (83-86), YH53/63 2.2 SWB/LWB P/van, Van, LS, GLX, Exec. Wagon 4Y Pet. (All Imp. Models) (86-88), YH53/63 2.2 SWB/LWB P/van, Van, LS, Super T/14/16, GLX, Exec. Wagon, Siyaya Bus, P/van 4Y Pet. (All Local Models) (88-09), Hilux LN30/40/50/51/55 2.2 SWB/LWB P/up L Dies., 2.4 SWB/LWB D/cab, Raider P/up 2L Dies., YN58 2.2 LWB D/cab, Raider, SRX P/up 4Y Pet. (79-98), YN51/56 1.8 SWB/LWB D/cab, S, SR, Raider P/up 2Y Pet., YN140 1.8 SWB/LWB D/cab, Raider, S, SRX P/up 2Y Pet. (86-05), RN58 2.4 22R Pet., LN140/145 2.4i DLX, P/up 2L Dies. (94-98), LN57 2.8D LWB D/cab, Raider P/up 3L Dies. - 4X2 (95-98), RZN147 2.0 SWB/LWB D/cab, DLX, Raider, S, SR, SRX P/up 1RZ Pet. (98-05)
<b>PQ172</b>	Rear Wheel Bearing Kit	Ford Sierra 1.6, 2.0, 2.3, 3.0 (83-89)
<b>PQ173</b>	Rear Wheel Bearing Kit	Ford Sierra 1.6 GL, GL S/W, L Kent, 2.0 GL, GL S/W Koln, 2.0 LX Koln, 2.3 GLE, Cologne, 3.0, i GLS, GLX, LX, RS, XR6 Essex (83-93)
<b>PQ174</b>	Rear Wheel Bearing Kit	Ford Sierra 1.6 GL, GL S/W, L Kent, 2.0 GL, GL S/W Koln, 2.0 LX Koln, 2.3 GLE, Cologne, 3.0, i GLS, GLX, LX, RS, XR6 Essex (83-93)
<b>PQ175</b>	Rear Wheel Bearing Kit	Datsun 1600, 1800 (69-78)
<b>PQ176</b>	Rear Wheel Bearing Kit	C.A.M. Inyathi, Jinbei Haise Minibus 2.2i Std., Rhino 2.2i, 2.8i (Local Diff.) (2007-), Ford Cortina MkIV 3.0 V6 Leisure, P/up Essex EV30 (77-80), Cortina MkV 1.6 P/up Kent, 2.4 P/up York D24, 3.0 V6 Leisure P/up Essex EV30 (80-86), Courier 1.6 P/up F6, 1.8 Chassis cab, Explorer, Std., XLT P/up F8, 2.0 XLT FE., 2.2 D/cab, Explorer, Leisure, Std., XLT P (86-00), Courier 3.0 V6 D/cab, Explorer, L, Leisure, Std., P/up Essex (86-97), Courier 2.5 Turbo Diesel D/cab, Leisure P/up WL4 - 4X2, 4X4 (96-00), Courier 3.0 V6 Std., XLT, D/cab, Leisure, Explorer, Exec. P/up Essex, 3.4 V6 Leisure, D/Cab, P/up Essex. - 4X2, 4X4 (97-01), Husky 1.8 1 Ton P/up 4G62, 2.0 1 Ton P/up, Bus, P/van 4G63 (Local) (85-99), Ranger 1.8 XL, P/up, 2.2 XL, P/up (00-10), 2.5 Diesel, Turbo Diesel D/Cab, High Trail, XL, DT XLT High Trail D/Cab, Super Cab - 4X2 (00-05), 2.5 D/Cab, High Trail, XL, DT XLT High Super Cab, 2.5TD Montana D/Cab WL4, 3.0TDCi, 4.0 Super Cab XLT - 4X4 (00-05)

# BUYERS GUIDE - BEARING KITS

<p><b>PQ176... Continued</b></p>	<p>Rear Wheel Bearing Kit</p>	<p>Spectron 2.2 Bus, P/van F2 (91-04), Hyundai Bakkie 2.5i D4BH Dies., 2.6i D4BB Dies., H100 P/Van 2.5i D4BH Dies., 2.6i D4BB Dies., (Local) (97-07), Isuzu KB20 1.6 P/up G161Z Pet., KB21 1.6 P/up G161Z Pet., KB22 1.8 P/up G180Z Pet., KBD20 2.0 P/up C190, KBD21 2.0 P/up C190, KBD22 2.2 LE, P/up C223, KB23 2.0 P/up G200Z, KB24 2.3 LE 4ZD1, KB25 1.6 P/up G161Z, KB26 1.6 P/up G161Z, 1.8 P/up G180Z, KBD23 2.5 LE, P/up 4JA1, KBD25 2.0 P/up C190 (78-89), KBD26 2.0 P/up C190, KBD27 2.2 C223, KBD28 2.5 4JA1 (81-89), KB27 1.8 P/up G180Z, KB28 2.0 P/up G200Z, KB29 2.3 P/up 4ZD1 (83-89), KB40 1.6 G161Z, KB41 1.6 G161Z, 1.8 G180Z, KB42 1.8 G180Z, KB43 2.0 G200Z, KB44 2.3 4ZD1, KBD40 KBD41 2.0 P/up C190, KBD42 2.2 P/up C223 - 4X4 (Local) (79-89), KB160 1.6 Fleetside P/up, KB200 2.0 LE, Fleetside, D/cab P/up, KB220 2.2 LE, P/up, KB230 2.3 D/cab P/up (89-04), KB260 2.6 LE, D/cab, LX, P/up 4ZE1, KB320 3.2 LE, D/cab, LX, Frontier, Reef, Blazer P/up 6VD1 (92-04), KB220 2.2 LE P/up, KB230 2.3 P/up 4ZD1, KB260 2.6 D/cab, LE, LX, KB320 3.2 V6 Frontier LX - 4X4 (89-04), KB250D 2.5 Fleetside, LE, D/Cab P/up 4JA1, KB280DT 2.8 D/cab LE, LX, Frontier P/up Turbo 4JB1 (89-04), KB250D 2.5 LE, D/cab P/up 4JA1, KB280DT 2.8 LE, LX, D/cab P/up Turbo 4JB1 - 4X4 (04-09), Relay 2.0 P/van, Bus 4ZC1 (89-95), WFR 1.8 11FVX/ 12FVX Bus, P/van 4ZB1 (83-89), Kia Sportage JA 2.0 SUV 5 Spd. FE Pet. - 4X4 (98-03), Mazda B-Series B2000 2.0 SWB P/up MA Pet., B2200 2.2 SWB/LWB P/up S2 Dies. (82-86), B2600 2.6 LWB D/cab, Magnum, Drifter P/up 4G54 Pet., B2600i 2.6i LWB D/cab Drifter, SLX P/up 4G54 Pet. - 4X2 (86-01), B2600 2.6 V6 LWB D/cab, Magnum, Drifter P/up 4G54 Pet. - 4X4 (86-95), B3000 3.0 V6 LWB D/cab, Magnum Drifter P/up Essex Pet. - 4X2, B3000 3.0 V6 LWB D/cab, Magnum, Drifter, Magnum Drifter P/up Essex Pet. - 4X4 ( 86-97), B1600 1.6 SWB Magnum P/up F6 Pet., B1800 1.8 SWB/LWB Magnum, Drifter P/up F8 Pet. (86-00), B2000 2.0 LWB Drifter, Magnum P/up FE Pet., B2200 2.2 LWB D/cab, Drifter, Magnum P/up R2 Dies., 2.2 LWB D/cab, Drifter Magnum P/up F2 Pet. (86-00), B2500 2.5, Td LWB D/Cab, Drifter, SLX P/up WL4 Dies./Turbo Dies. - 4X4 (96-99), B3400 3.4 V6 LWB Magnum D/cab P/up Essex Pet. - 4X2, 4X4 (96-01), B2500 2.5 LWB Diesel, Turbo Diesel D/cab, Drifter, SLX P/up WL4 Dies., Turbo - 4X2 (97-00), B2600i 2.6i V6 LWB Drifter, D/cab Drifter SLX P/up 4G54 Pet. - 4X4 (00-09), Drifter 1.8 SWB/LWB XL P/up Pet., 2.2 SWB/LWB XL P/up Pet., 2.5Td LWB Hi Ride, SL SLE, SLX D/cab, Hi Ride, Hi Trail D/cab P/up WL4 Dies./Turbo Dies. - 4X2, 2.5Td LWB D/cab, DL, SL, SLE, SLX S/cab, D/cab P/up WL4 Dies./Turbo Dies. - 4X4, 2.6i LWB Hi Ride, SL Hi Ride S/cab, SLE, SLX D/cab SLX Hi Ride D/cab, SLX Hi Trail D/cab P/up Pet. - 4X2, 2.6i V6 LWB SL S/cab, SLE, SLX D/cab P/up 4G54 Pet. - 4X4 (00-05), Marathon 2.2 LWB Bus, P/van F2 Pet. (91-04)</p>
<p><b>PQ176... Continued</b></p>	<p>Rear Wheel Bearing Kit</p>	<p>Mitsubishi Colt LDV 1.6 SWB/LWB Lo-Line P/up 4G32 Pet., 2.0 4G63 Pet., 2.5D 4D56 Dies., 2.6 WB Hi-Line P/up 4G54 Pet. (94-98), Colt LDV 2.5D LWB Hi-Line P/up 4D56 Dies., 2.6 LWB Lo-/Hi-Line, P/up 4G54 Pet., 3.0 V6 LWB Lo-/Hi-Line D/cab, Rodeo 6G72 Pet. - 4X4 (95-98), L300 1.6 Mini Bus, Van 4G32 Pet., 1.8 4G62 Pet., 2.0 P/up 4G63 Pet, Starwagon 2.0 S, SL, SLE, P/up, P/van 4G63 Pet. (82-01), Pajero 2.8 Tdi, 3.0 V6 SWB GLS Wagon 6G72 Pet., 3.5 V6 SWB GLS Wagon 6G74 Pet. - 4X4 (90-01), Nissan 1-Tonner/Hardbody AW/D21 1.6 L16S-J, 1.8 L18S-R, 2.0 NA20, 2.4 Z24/S, 2.5D TD25i, 2.7D TD27, 3.0 VG30E (88-98), AW/D21 2.4 Z24S, 2.7 TD27, 3.0 VG30E - 4X4 (88-99), 720 D20 1.8 L18S Kingcab, Sport, 2.2D SD/Z22 Tracker, 2.3 SD23 - 4X2, 1.8 L18S, 2.0 NA20, 2.2 Z22 - 4X4 (80-88), E20 1.8 L18 Bus, P/van Coach, Coach GL, GLE, Econolux, Ekonovan, Ekonowagon, 2.0 Bus, Van H20 (80-96), Hardbody QW/D22 2.0 NA20S, 2.0i KA20, 2.4i Z24, KA24E/DE, 2.7D TD27i, 3.0 i VG30E, 3.0TD ZD30, 3.2 QD32, 3.3i VG33E - 4X2, 2.4i KA24E, 2.7 TD27, 3.0 VG30E, 3.0TD ZD30, 3.2, 3.2D QD32, 3.3i VG33 - 4X4 (98-04), Sani AW/D21 2.4, i Z24, 2.5 TD25, 2.7D, TD TD27, 3.0 VG30E - 4X2 (86-99), 2.2 Z22, 2.4 Z24, 2.7 TD27, 3.0 VG30E - 4X4 (86-98), Terrano II 2.7 TD2 - 4X4 (00-02), Ssangyong Korando 2.3 K230 EL, Open Top S/W, 2.9 K290 EL, TDi, Open Top S/W, 3.2 K320 EL S/W, MUSSO 2.3 E230 EL S/W, 2.9 602, EL, EX, TDi, Exec., E290 TDi, Exec., 3.2 E320 EL Exec. (95-04)</p>
<p><b>PQ176... Continued</b></p>	<p>Rear Wheel Bearing Kit</p>	<p>Toyota Hiace YH50/60 1.8 SWB / LWB P/van, LS Wagon 2Y Pet. (83-91), YH51/61 2.0 SWB/LWB 16 Seater Commuter, Super 10 Seater Custom Wagon, P/van 3Y Pet. (83-86), YH53/63 2.2 SWB/LWB P/van, Van, LS, Super T/14/16, GLX, Exec. Wagon, Siyaya Bus, P/van 4Y Pet. (All Local Models) (88-09), Hilux LN30/40/50/51/55 2.2 SWB/LWB P/up L Dies., 2.4 SWB/LWB D/cab, Raider P/up 2L Dies., YN58 2.2 LWB D/cab, Raider, SRX P/up 4Y Pet. (79-98), YN67 2.2 LWB D/cab, Raider D/cab P/up 4Y Pet. - 4X4 (86-94), YN51/56 1.8 SWB/LWB D/cab, S, SR, Raider P/up 2Y Pet., YN140 1.8 SWB/LWB D/cab, Raider, S, SRX P/up 2Y Pet. (86-05), LN65 2.4 LWB D/cab, Raider D/cab P/up 2L Dies., RN67 2.4 LWB D/cab, Raider D/cab P/up 22R Pet. - 4X4 (89-98), RN58 2.4 22R Pet., LN140/145 2.4i DLX, P/up 2L Dies., RZN194 2.7i LWB D/cab, Raider, SRX, Legend35 Raider, 3RZFE Pet. (94-05), LN57 2.8D LWB D/cab, Raider P/up 3L Dies. - 4X2, LN67 2.8D LWB, D/cab, Raider D/cab P/up 3L Dies. - 4X4 (95-98), RZN147 2.0 SWB/LWB D/cab, DLX, Raider, S, SR, SRX P/up 1RZ Pet., LN192R 3.0D LWB Raider D-E, Raider DLX D/cab D-E, Legend35 Raider, P/up 5L Dies., 3.0iD LWB Raider, Raider D/cab, P/up KZ-TE Dies. (98-05), RZN169 2.7i LWB D/cab, DLX S/cab, Raider S/D/cab, SRX D/cab, Legend 35 LWB P/up 3RZFE Pet., LN167 3.0D D/cab D-E, DLX, S/D/cab DE, Raider DE, Legend35 LWB P/up 5L Dies., 3.0iD LWB Raider S/cab &amp; KZ-TE D/cab P/up, Legend35 - 4X4 (98-05),</p>



## BUYERS GUIDE - BEARING KITS

<b>PQ176... Continued</b>	Rear Wheel Bearing Kit	Stallion KF50 1.5 SR5, Commuter, Bus, P/up, P/van 5K Pet., YF50 1.8 SR5, P/up, P/van, Van 2Y Pet., LF50 2.4D P/up 2L5F Dies. (87-04), TUV KF20 1.3 Chassis Cab, P/up, P/van, Bus 4K Pet., 1.5 P/up 5K Pet. (82-87), Venture YF50 1.8 8/10 Seater P/van 2Y Pet., 2.2 10 Seater, GLE, Getaway 9 Seater S/W 4Y Pet., LF50 2.4D 10 Seater S/W 2L5F Dies. (91-04)
<b>PQ176A</b>	Rear Wheel Bearing Kit	Isuzu KB200i 2.0 LX, KB240i 2.4 LX, KB250i 2.5 LX, , KB250Dc 2.5, KB300TDi 3.0 LX - 4X2, 4X4 (04-09)
<b>PQ177</b>	Front Wheel Bearing Kit	Mazda B-Series B2000 2.0 SWB P/up MA Pet., B2200 2.2 SWB/LWB P/up S2 Dies. (82-86)
<b>PQ178</b>	Front Wheel Bearing Kit	Nissan 1-Tonner/Hardbody AW/D21 1.6 L16S-J, 1.8 L18S-R, 2.0 NA20, 2.4 Z24/S, 2.5D TD25i, 2.7D TD27, 3.0 VG30E (88-98), 720 D20 1.8 L18S Kingcab, Sport, 2.2D SD/Z22 Tracker, 2.3 SD23 - 4X2 (80-88), E20 1.8 L18 Bus, P/van Coach, Coach GL, GLE, Econolux, Ekonovan, Ekonowagon, 2.0 Bus, Van H20 (80-96), Hardbody QW/D22 2.0 NA20S, 2.0i KA20, 2.4i Z24, KA24E/DE, 2.7D TD27i, 3.0 i VG30E, 3.0TD ZD30, 3.2 QD32, 3.3i VG33E - 4X2, 2.4i KA24E, 2.7 TD27, 3.0 VG30E, 3.0TD ZD30, 3.2, 3.2D QD32, 3.3i VG33 - 4X4 (98-11), NP300 D22 2.0i, S, SE KA20, 2.5TDi, S, SE YD25 (2008-), Sani AW/D21 2.4, i Z24, 2.5 TD25, 2.7D, TD TD27, 3.0 VG30E - 4X2 (86-99)
<b>PQ179</b>	Front Wheel Bearing Kit	Volkswagen Kombi Bus (68-80)
<b>PQ180</b>	Front Wheel Bearing Kit	VW Kombi T2 2.0, L Exec., Microbus, Kamper, P/up, P/van CU, CJ Pet., T3 1.9 Microbus, P/van DG Pet. (75-83)
<b>PQ181</b>	Front Wheel Bearing Kit	VW Kombi T2 2.0, L Exec., Microbus, Kamper, P/up, P/van CU, CJ Pet., T3 1.9 Microbus, P/van DG Pet. (84-89), T3 1.8 P/van, GUS, Volksiebus AAX Pet. (89-99), T3 2.1 Fi Caravelle, Microbus DJ Pet., 2.3i Microbus, Volksiebus AFU Pet., 2.5i Microbus, Caravelle AAY Pet., 2.6i Microbus, Caravelle, Exclusive, ADV Pet. - 4X2 (85-04)
<b>PQ182</b>	Rear Wheel Bearing Kit	VW Kombi T2 2.0, L Exec., Microbus, Kamper, P/up, P/van CU, CJ Pet., T3 1.9 Microbus, P/van DG Pet. (75-89), T3 1.8 P/van, GUS, Volksiebus AAX Pet. (89-99), T3 2.1 Fi Caravelle, Microbus DJ Pet., 2.3i Microbus, Volksiebus AFU Pet., 2.5i Microbus, Caravelle AAY Pet., 2.6i Microbus, Caravelle, Exclusive, ADV Pet. - 4X2 (85-04), T3 2.1 Fi Syncro Caravelle DJ Pet. - 4X4 (89-93)
<b>PQ183</b>	Rear Wheel Bearing Kit	Nissan 720 D20 1.8 L18S Kingcab, Sport, 2.2D SD/Z22 Tracker, 2.3 SD23 - 4X2, 1.8 L18S, 2.0 NA20, 2.2 Z22 - 4X4 (80-88), E20 1.8 L18 Bus, P/van Coach, Coach GL, GLE, Econolux, Ekonovan, Ekonowagon, 2.0 Bus, Van H20 (Import) (80-96)
<b>PQ184</b>	Front Wheel Bearing Kit	Ford Bantam 130 Explorer P/up B3, 160, i Explorer, Leisure, Sport, P/up B6/ F6 (94-03), Laser 1.3 L, GL, 13, Dash E3 / B3, 1.6, i GL, 16, Sport, TX3 B6/ F6, 2.0, i RS FE (86-95), 1.4 L CHV-FUA, 1.5 GL, GLS, Sport E5/B5 (86-92), Meteor 1.3 GL, L, 13 E3/B3, 1.4 LX CVH, 1.5 GL, GLS E5, 1.6, i GL, GLE, GLi,16, Sport B6/CVH/F6, 2.0 8/16V GLE, GLi FE (86-95), Tracer 1.3 Sedan, H/back -Tonic, Plus B3, 1.6 Sedan, H/back - Plus, Sport, Tonic B6/F6 (95-02), Mazda 323 FWD 1.3 S, H/back, Sedan E3, 1.5 GLC, SL, SLX, Sport H/back, Sedan E5 (81-88), 1.3 L, H/back, Sedan E/B3, 1.5, L H/back, Sedan E5, 1.6 EGi Hatch, L, Sedan, SL Hatch, SL Sedan, Sport Hatch B6i/F6 (84-91), 2.0 EGi Hatch, SLE Hatch, SLi Sedan, 200e Hatch, Sedan, 200i Hatch 8/16V FE-2000 (89-95), 130 Hatch, Midge, Sedan, Sting B3, 160, i, S Hatch, Midge, Sedan, Sting F6 (90-95), 130 Hatch, Midge, Sedan, Sting B3, 160, i, S Hatch, Midge, Sedan, Sting F6, 200i, e Hatch 8/16V FE 2000 (95-05), Rustler 130 SWB Drifter, Explorer P/up B3 Pet., 160, i SWB Explorer, Drifter P/up F6/B6i Pet. (94-02)
<b>PQ184N</b>	Front Wheel Bearing Kit	Kia Pride 1.3i LX 5 Dr. H/back, Rio I 1.3 5 Dr. H/back A3E, 1.5 5 Dr. H/back A5D (98-04)
<b>PQ185</b>	Front Wheel Bearing Kit	Datsun 1200Gx, Nissan 1200, B120 (71-75)
<b>PQ186P</b>	Rear Wheel Bearing Kit	Nissan Laurel C31 Series 2.0, 2.8 [Imp.] (80-87), Stanza 1.6, 1.8 [Imp.] (80-84), Skyline R30 Series 1.8, 2.0 (82-87), R31 Series 2.0 [Imp.] (87-92), Toyota Corolla 1.3 [Imp.] (84-88)
<b>PQ188</b>	Front Wheel Bearing Kit	Honda Ballade SA4 1300 EN4 (82-85)
<b>PQ189</b>	Front Wheel Bearing Kit	Hyundai Accent X3 1.3 G4EH, 1.5 G4EK (94-00), Atos 1.0 Prime G4HC (00-05), Elantra J1 1.6 Exec., G4CR, 1.8 Exec., G4CN (93-95), S-Coupe 1.5 (94-95)
<b>PQ190</b>	Front Wheel Bearing Kit	Ford Husky 1.8 1 Ton P/up 4G62, 2.0 1 Ton P/up, Bus, P/van 4G63 (85-99), Hyundai Bakkie 2.5i D4BH Dies., 2.6i D4BB Dies. (97-01), H100 P/Van 2.5i D4BH Dies., 2.6i D4BB Dies. (00-07), Mitsubishi Colt LDV 1.6 SWB/LWB Lo-Line P/up 4G32 Pet., 2.0 4G63 Pet., 2.5D 4D56 Dies., 2.6 WB Hi-Line P/up 4G54 Pet., 2.8D LWB Std., Hi line P/up Dies., 2.8TDi LWB Club CabS cab,Turbo, 3.0i V6 LWB Club S/cab P/up Pet. (94-98), 2.0 LWB Std. P/up, 2.0i LWB Hi-Line, 2.4i LWB Hi-Line Rodeo S-/D/cab, Hi-Line/Rider P/up Pet., 2.5D 4D56 Dies. (98-09), 2.4i LWB Hi-Line D/cab, Trailbuster S/cab, P/up Pet. - 4X4 (98-09), 3.0i V6 LWB Rodeo D/cab P/up Pet. (99-09), L300 1.6 Mini Bus, Van 4G32 Pet., 1.8 4G62 Pet., 2.0 P/up 4G63 Pet., Starwagon 2.0 S, SL, SLE, P/up, P/van 4G63 Pet. (82-01)

## BUYERS GUIDE - BEARING KITS

<b>PQ191</b>	Rear Wheel Bearing Kit	C.A.M. Inyathi, Jinbei Haise Minibus 2.2i Std., Rhino 2.2i, 2.8i (Import Diff.) (2007-), Toyota Hiace YH51/61 2.0 SWB/LWB 16 Seater Commuter, Super 10 Seater Custom Wagon, P/van 3Y Pet. (83-86), YH53/63 2.2 SWB/LWB P/van, Van, LS, GLX, Exec. Wagon 4Y Pet. (All Imp. Models) (86-88), Hilux LN30/40/50/51/55 2.2 SWB/LWB P/up L Dies., 2.4 SWB/LWB D/cab, Raider P/up 2L Dies., YN58 2.2 LWB D/cab, Raider, SRX P/up 4Y Pet. (79-98), YN67 2.2 LWB D/cab, Raider D/cab P/up 4Y Pet. - 4X4 (86-94), YN51/56 1.8 SWB/LWB D/cab, S, SR, Raider P/up 2Y Pet., YN140 1.8 SWB/LWB D/cab, Raider, S, SRX P/up 2Y Pet. (86-05), LN65 2.4 LWB D/cab, Raider D/cab P/up 2L Dies., RN67 2.4 LWB D/cab, Raider D/cab P/up 22R Pet. - 4X4 (89-98)
<b>PQ193</b>	Front Wheel Bearing Kit	Alfa Romeo Giulietta 1.8 (79-82), Gtv 1750, 2000 (70-77)
<b>PQ194</b>	Front Wheel Bearing Kit	Alfa Romeo Alfetta 2.0 (76-85), Giulietta 1.8, 2.0, Gtv 2.5, 3.0 (79-85)
<b>PQ197</b>	Rear Wheel Bearing Kit	BMW 3 Series E30 316 1.8 M10, 316i 1.6 M40, 318i 1.8 M40, 320i M20/50, 323i M50, 325i M52, 333i M30 (83-92), E36 316i 1.8 Dolphin Shape M40, 318i 1.9 M44, 320i 2.0 M50, 323i 2.5 M52, 325i M50, 328i 2.8, 3.0 M52, Z3 2.8, 3.0 Roadster (92-00), E37 M3 M Coupe S50 (93-01), E46 316i 1.8 M40, 318i M43, 320i, d M54/47, 323i M52, 325i, it M50, 328i M52TU (98-05)
<b>PQ197ABS</b>	USE PQ912	
<b>PQ198</b>	Front Wheel Bearing Kit	Alfa Romeo Alfetta 1.6, 1.8 (73-80)
<b>PQ200</b>	Front Wheel Bearing Kit	BMW 3 Series E30 316 1.8 M10, 316i 1.6 M40, 318i 1.8 M40, 320i M20/50, 323i M50, 325i M52, 333i M30 (83-92)
<b>PQ202</b>	Front Wheel Bearing Kit	BMW 5 Series E28 520i 2.0 M20, 525e 2.5 M30, 528i 2.8 M30, 535i 3.0 M30 (85-89), E34 520i 2.0 M50, 525i 2.5 M50, 530i 3.0 M60, 535i 3.5 M30, 540i 4.0 M60 (96-00), 7 Series E23 728, i M30, 730 M30, 733i M30, 735i M90, 745i M88 (78-89), M5 Coupe M30, M5 Coupe MS38 (86-94)
<b>PQ203</b>	Front Wheel Bearing Kit	BMW 5 Series E28 520i 2.0 M20, 525e 2.5 M30, 528i 2.8 M30, 535i 3.0 M30 (85-89), 7 Series E23 728, i M30, 730 M30, 733i M30, 735i M90, 745i M88 (78-89)
<b>PQ204</b>	Front Wheel Bearing Kit	BMW 7 Series E23 728, i M30, 730 M30, 733i M30, 735i M90, 745i M88 (78-89)
<b>PQ205</b>	Rear Wheel Bearing Kit	BMW M5 Coupe M30, M5 Coupe MS38 (86-94), 5 Series E28 520i 2.0 M20, 525e 2.5 M30, 528i 2.8 M30, 535i 3.0 M30 (85-89), E34 520i 2.0 M50, 525i 2.5 M50, 530i 3.0 M60, 535i 3.5 M30, 540i 4.0 M60 (90-00)
<b>PQ206</b>	Rear Wheel Bearing Kit	BMW 5 Series E28 520i 2.0 M20, 525e 2.5 M30, 528i 2.8 M30, 535i 3.0 M30 (85-89), E34 520i 2.0 M50, 525i 2.5 M50, 530i 3.0 M60, 535i 3.5 M30, 540i 4.0 M60 (90-00), 7 Series E23 728, i M30, 730 M30, 733i M30, 735i M90, 745i M88 (78-89), E32 730i M30/60, 735i M106, 740i M60, 750iL M70 (87-95), M5 Coupe M30, M5 Coupe MS38 (86-94)
<b>PQ207</b>	Front Wheel Bearing Kit	BMW 3 Series E36 316i 1.8 Dolphin Shape M40, 318i 1.9 M44, 320i 2.0 M50, 323i 2.5 M52, 325i M50, 328i 2.8, 3.0 M52, Z3 2.8, 3.0 Roadster (92-00), E37 M3 M Coupe S50 (93-01), E46 316i 1.8 M40, 318i M43, 320i, d M54/47, 323i M52, 325i, it M50, 328i M52TU, 330d 3.0 M57, 330i, Ci, 3.0 M54 (98-05), 5 Series E34 520i 2.0 M50, 525i 2.5 M50, 530i 3.0 M60, 535i 3.5 M30, 540i 4.0 M60 (90-00), E32 730i M30/60, 735i M106, 740i M60, 750iL M70 (87-95), E31 850iL V12 M70 (91-94), M5 Coupe M30, M5 Coupe MS38 (86-94)
<b>PQ217</b>	Rear Wheel Bearing Kit	Kia Rio I 1.3 5 Dr. H/back A3E, 1.5 5 Dr. H/back A5D (98-04), Mazda 323 FWD 1.3 L, H/back, Sedan E/B3, 1.5, L H/back, Sedan E5, 1.6 EGi Hatch, L, Sedan, SL Hatch, SL Sedan, Sport Hatch B6i/F6 (84-91), 130 Hatch, Midge, Sedan, Sting B3, 160, i, S Hatch, Midge, Sedan, Sting F6, 200i, e Hatch 8/16V FE 2000 (95-05)
<b>PQ219</b>	Front & Rear Wheel Bearing Kit	Fiat 128 1.1, 1.3 (71-84), Tata Indica 1.4, 1.4TDi, Indigo 1.4, TDi – Some models (2005-)
<b>PQ222</b>	Front Wheel Bearing Kit	Ford Capri 1.6, 2.0, 3.0 (69-73), Corsair 1.7, 2.0 (64-71), Cortina MkI 1.5 (62-66), Cortina MkII 1.3, 1.6 (67-71)
<b>PQ229</b>	Wheel bearing kit	Ford Escort 1600 Gt, L, Lx (70-75)
<b>PQ231L</b>	Rear Wheel Bearing Kit	Ford Laser 1.3 L, GL, 13, Dash E3 / B3 (86-02), 1.4 L CHV-FUA, 1.5 GL, GLS, Sport E5/ B5 (86-92), 1.6, i GL, 16, Sport, TX3 B6/ F6, 2.0, i RS FE (86-02), Meteor 1.3 GL, L, 13 E3/ B3, 1.4 LX CVH, 1.5 GL, GLS E5, 1.6, i GL, GLE, GLi, 16, Sport B6/CVH/F6, 2.0 8/16V GLE, GLi FE (86-95), Tracer 1.3 Sedan, H/back –Tonic, Plus B3, 1.6 Sedan, H/back – Plus, Sport, Tonic B6/F6 (86-02), Mazda 323 FWD 1.3 L, H/back, Sedan E/B3, 1.5, L H/back, Sedan E5, 1.6 EGi Hatch, L, Sedan, SL Hatch, SL Sedan, Sport Hatch B6i/F6 (84-91), 2.0 EGi Hatch, SLE Hatch, SLi Sedan, 200e Hatch, Sedan, 200i Hatch 8/16V FE-2000 (89-95), 130 Hatch, Midge, Sedan, Sting B3, 160, i, S Hatch, Midge, Sedan, Sting F6 (90-95), 130 Hatch, Midge, Sedan, Sting B3, 160, i, S Hatch, Midge, Sedan, Sting F6, 200i, e Hatch 8/16V FE 2000 (95-05)



## BUYERS GUIDE - BEARING KITS

<b>PQ231R</b>	Rear Wheel Bearing Kit	Ford Laser 1.3 L, GL, 13, Dash E3 / B3 (86-02), 1.4 L CHV-FUA, 1.5 GL, GLS, Sport E5/ B5 (86-92), 1.6, i GL, 16, Sport, TX3 B6/ F6, 2.0, i RS FE (86-02), Meteor 1.3 GL, L, 13 E3/ B3, 1.4 LX CVH, 1.5 GL, GLS E5, 1.6, i GL, GLE, GLi, 16, Sport B6/CVH/F6, 2.0 8/16V GLE, GLi FE (86-95), Tracer 1.3 Sedan, H/back –Tonic, Plus B3, 1.6 Sedan, H/back – Plus, Sport, Tonic B6/F6 (86-02), Mazda 323 FWD 1.3 L, H/back, Sedan E/B3, 1.5, L H/back, Sedan E5, 1.6 EGi Hatch, L, Sedan, SL Hatch, SL Sedan, Sport Hatch B6i/F6 (84-91), 2.0 EGi Hatch, SLE Hatch, SLi Sedan, 200e Hatch, Sedan, 200i Hatch 8/16V FE-2000 (89-95), 130 Hatch, Midge, Sedan, Sting B3, 160, i, S Hatch, Midge, Sedan, Sting F6 (90-95), 130 Hatch, Midge, Sedan, Sting B3, 160, i, S Hatch, Midge, Sedan, Sting F6, 200i, e Hatch 8/16V FE 2000 (95-05)
<b>PQ232</b>	Front Wheel Bearing Kit	Nissan B140 1.4 A14SP/van, S/W, Deluxe, Std. Sport, CHAMP P/up (80-83)
<b>PQ233L</b>	Rear Wheel Bearing Kit	Ford Bantam 1300 P/up Kent 2V, 1400 Leisure, Nite P/up CVH/FUA, 1600 Leisure Explorer, Nite P/up CVH (83-94), 130 Explorer P/up B3, 160, i Explorer, Leisure, Sport, P/up B6/ F6 (94-03), Mazda Rustler 1.3 SWB P/up Kent 2V Pet., 1.4 SWB P/up CVH/FUA Pet., 1.6 SWB, LX P/up CVH/ LUC Pet. (86-94), 130 SWB Drifter, Explorer P/up B3 Pet., 160, i SWB Explorer, Drifter P/up F6/B6i Pet. (94-02)
<b>PQ233R</b>	Rear Wheel Bearing Kit	Ford Bantam 1300 P/up Kent 2V, 1400 Leisure, Nite P/up CVH/FUA, 1600 Leisure Explorer, Nite P/up CVH (83-94), 130 Explorer P/up B3, 160, i Explorer, Leisure, Sport, P/up B6/ F6 (94-03), Mazda Rustler 1.3 SWB P/up Kent 2V Pet., 1.4 SWB P/up CVH/FUA Pet., 1.6 SWB, LX P/up CVH/ LUC Pet. (86-94), 130 SWB Drifter, Explorer P/up B3 Pet., 160, i SWB Explorer, Drifter P/up F6/B6i Pet. (94-02)
<b>PQ234</b>	Front Wheel Bearing Kit	Ford Courier 1.6 P/up F6, 1.8 Chassis cab, Explorer, Std., XLT P/up F8., 2.0 XLT FE., 2.2 D/cab, Explorer, Leisure, Std., XLT P (86-00), 3.0 V6 D/cab, Explorer, L, Leisure, Std., P/up Essex (86-97), 2.5 Turbo Diesel D/cab, Leisure P/up WL4, 3.4 V6 Leisure D/cab, P/up Essex - 4X2 (96-01), Ranger 1.8 XL, P/up, 2.2 XL, P/up (00-05), 2.5 Diesel, Turbo Diesel D/Cab, High Trail, XL, DT XLT High Trail D/Cab, Super Cab - 4X2 (00-04), Spectron 2.2 Bus, P/van F2 (91-04), Mazda B-Series B2600 2.6 LWB D/cab, Magnum, Drifter P/up 4G54 Pet., B2600i 2.6i LWB D/cab Drifter, SLX P/up 4G54 Pet. (86-01), B3000 3.0 V6 LWB D/cab, Magnum Drifter P/up Essex Pet. - 4X2 (86-97), B1600 1.6 SWB Magnum P/up F6 Pet., B1800 1.8 SWB/LWB Magnum, Drifter P/up F8 Pet., B2000 2.0 LWB Drifter, Magnum P/up FE Pet., B2200 2.2 LWB D/cab, Drifter, Magnum P/up R2 Dies., 2.2 LWB D/cab, Drifter, Magnum P/up F2 Pet. (86-00), B3400 3.4 V6 LWB Magnum D/cab P/up Essex Pet., B2500 2.5 LWB Diesel, Turbo Diesel D/cab, Drifter, SLX P/up WL4 Dies., Turbo - 4X2 (96-00), Drifter 1.8 SWB/LWB XL P/up Pet., 2.2 SWB/LWB XL P/up Pet., 2.5Td LWB Hi Ride, SL SLE,SLX D/cab, Hi Ride, Hi Trail D/cab P/up WL4 Dies./Turbo Dies. - 4X2 (00-04), 2.6i LWB Hi Ride, SL Hi Ride S/cab, SLE, SLX D/cab SLX Hi Ride D/cab, SLX -Hi-Trail D/cab P/up Pet. - 4X2 (00-09), Marathon 2.2 LWB Bus, P/van F2 Pet. (91-04)
<b>PQ240</b>	Rear Wheel Bearing Kit	Isuzu KB20 1.6 P/up G161Z Pet., KB21 1.6 P/up G161Z Pet., KB22 1.8 P/up G180Z Pet., KBD20 2.0 P/up C190, KBD21 2.0 P/up C190, KBD22 2.2 LE, P/up C223, KB23 2.0 P/up G200Z, KB24 2.3 LE 4ZD1, KB25 1.6 P/up G161Z, KB26 1.6 P/up G161Z, 1.8 P/up G180Z, KBD23 2.5 LE, P/up 4JA1, KBD25 2.0 P/up C190 (78-89), KBD26 2.0 P/up C190, KBD27 2.2 C223, KBD28 2.5 4JA1 (81-89), KB27 1.8 P/up G180Z, KB28 2.0 P/up G200Z, KB29 2.3 P/up 4ZD1 (83-89), KB40 1.6 G161Z, KB41 1.6 G161Z, 1.8 G180Z, KB42 1.8 G180Z, KB43 2.0 G200Z, KB44 2.3 4ZD+1, KBD40, KBD41 2.0 P/up C190, KBD42 2.2 P/up C223 - 4X4 (79-89), KB250D 2.5 Fleetside, LE, D/Cab P/up 4JA1, KB280DT 2.8 D/cab LE, LX, Frontier P/up Turbo 4JB1 (89-04), Relay 2.0 P/van, Bus 4ZC1 (Import) (89-95)
<b>PQ241</b>	Front Wheel Bearing Kit	Isuzu KB40 1.6 G161Z, KB41 1.6 G161Z, 1.8 G180Z, KB42 1.8 G180Z, KB43 2.0 G200Z, KB44 2.3 4ZD1, KBD40, KBD41 2.0 P/up C190, KBD42 2.2 P/up C223 - 4X4 (79-89)
<b>PQ243</b>	Front Wheel Bearing Kit	Isuzu Relay 2.0 P/van, Bus 4ZC1 (89-95), WFR 1.8 11FVX/ 12FVX Bus, P/van 4ZB1 (83-89)
<b>PQ245</b>	Front & Rear Wheel Bearing Kit	Land Rover 110 Series II, IIA, III 2.6 LWB P/up 6 Cyl. OHI SE Pet., 3.5 LWB "PUP" P/up V8 ADE236 Pet. (84-96), Defender 90 2.5 TDi Country, 2.8i CSW S/W, 3.5 CSW S/W, Defender 110 2.5 TD, i TD5 Storm, 2.8, i CSW S/W, 3.5 CSW S/W (89-04), Defender 90 2.2 TD, 2.4 TD, 2.5 TD5, Defender 110 2.2 TD, 2.5 TD, I (2002-), Defender 130 2.5TD, i TD5 Storm, 3.5 CSW S/W, Discovery 2.5TD, i TD5 ES, GS, XS, S S/W, 3.5 P/up, S/W, 3.9i ES, S P/up, S/W (89-04)
<b>PQ246P</b>		Leyland Mini 850, 1.0
<b>PQ248P</b>	Front Wheel Bearing Kit	Leyland Mini 1275 (66-84)
<b>PQ267</b>	Rear Wheel Bearing Kit	Mazda B1500, B1600, B1800 (67-80)
<b>PQ268</b>	Front Wheel Bearing Kit	Mazda E2000, E3000 (67-75)
<b>PQ274</b>	Front Wheel Bearing Kit	Mercedes-Benz 200, 220D, 230, 240D, 250Se, 280, E, S, Se (65-77)

## BUYERS GUIDE - BEARING KITS

<b>PQ277</b>	Rear Wheel Bearing Kit	Mercedes-Benz W123 200 M115.938/9, 230, E M115.954, 240D M616.912, 250 M123.920/1, 280E M110.983, 300D M617.912 (77-86), W126 280SE M110 987/9, 300SE M103.981, 380SE M116.963, 420SE M116.965, 500SE M117.965 (86-93)
<b>PQ278</b>	Front Wheel Bearing Kit	Mercedes-Benz W123 200 M115.938/9, 230, E M115.954, 240D M616.912, 250 M123.920/1, 280E M110.983, 300D M617.912 (77-86), W126 280SE M110 987/9, 300SE M103.981, 380SE M116.963, 420SE M116.965, 500SE M117.965 (86-93)
<b>PQ280</b>	Wheel Bearing Kit Fg	Mitsubishi Colt 1600, 2000 (72-78), Galant 1600, 2000 (77-84)
<b>PQ281</b>	Front Wheel Bearing Kit	Mitsubishi Canter 2.5 SWB/LWB D/side, Chassis cab 4G55 Dies., 2.6 4G54 Pet., 3.3 4D30A Dies., 3.8 ADE236 Dies. (80-97)
<b>PQ282</b>	Rear Wheel Bearing Kit	Ford Husky 1.8 1 Ton P/up 4G62, 2.0 1 Ton P/up, Bus, P/van 4G63 (85-99), Mitsubishi L300 1.6 Mini Bus, Van 4G32 Pet., 1.8 4G62 Pet., 2.0 P/up 4G63 Pet., Starwagon 2.0 S, SL, SLE, P/up, P/van 4G63 Pet. (82-01)
<b>PQ287</b>	Rear Wheel Bearing Kit	Nissan Skyline R30 2.8 GLX, GTX L28/2 (83-86), R31 2.0 SGi, SGLi RB20E, 3.0 SGLi RB30E With I.R.S. (87-92)
<b>PQ288</b>	Front Wheel Bearing Kit	Nissan Skyline R30 1.8 L18, 2.0 GL L20, R31 2.0 GL, GLE CA20, 2.0 SGi, SGLi RB20E, 3.0 SGLi RB30E With I.R.S. (87-92)
<b>PQ289</b>	Front Wheel Bearing Kit	Nissan Langley 1.3 GL E13 (83-88), Pulsar 1.3 S E13 (80-87)
<b>PQ290</b>	Front Wheel Bearing Kit	Nissan Langley 1.5 GL, L, SSS, Trebon, Exa Turbo E15 (83-88), Pulsar 1.4 DL, GX A14, 1.5 GL, Panache, SX E15 (80-87)
<b>PQ296</b>	Front Wheel Bearing Kit	Nissan Safari 2.8 - 4X4 (80-84)
<b>PQ299</b>	Rear Wheel Bearing Kit	Nissan Safari 2.8 - 4X4 (80-90)
<b>PQ306</b>	Rear Wheel Bearing Kit	Peugeot 504 2.0 (71-73)
<b>PQ309</b>	Front Wheel Bearing Kit	Renault Clio I, II 1.2 Authentique, Expression, Generation, Va Va Voom D4F706, 1.4 Alaise, Privilege, Expression, RT, Va Va Voom K4J7/EJ634, 1.5 DCi Expression., K9K700/-702, 1.6 Expression, Dynamique, Privilege, Sport K4M744/ -745/-748, 2.0 Sport F4R, 3.0 V6 Sport F7R (99-04), R9 1.4 GTL, TL, TSE C1/2/3J, 1.7 TXE F2/3N, R11 1.4 TS, TX, TXE C1/2/3J, 1.7 TX, TXE F2/3N (83-86)
<b>PQ310</b>	Rear Wheel Bearing Kit	Renault Clio I, II 1.2 Authentique, Expression, Generation, Va Va Voom D4F706, 1.4 Alaise, Privilege, Expression, RT, Va Va Voom K4J7/EJ634, 1.5 DCi Expression., K9K700/-702, 1.6 Expression, Dynamique, Privilege, Sport K4M744/ -745/-748 (99-10), Clio III 1.4 Expression, Extreme, 1.5 DCi Expression., K9K770, 1.6 Expression, Dynamique, Extreme K4M 748 (06-10), R9 1.4 GTL, TL, TSE C1/2/3J, 1.7 TXE F2/3N, R11 1.4 TS, TX, TXE C1/2/3J, 1.7 TX, TXE F2/3N (83-86)
<b>PQ311</b>	Front Wheel Bearing Kit	Toyota Corolla TE71 1.6 P/van 2T (83-89), TUV KF20 1.3 Chassis Cab, P/up, P/van, Bus 4K Pet., 1.5 P/up 5K Pet. (82-87)
<b>PQ312P</b>	Rear Wheel Bearing Kit	Toyota Stallion KF50 1.5 SR5,Commuter, Bus, P/up, P/van 5K Pet., YF50 1.8 SR5, P/up, P/van, Van 2Y Pet., LF50 2.4D P/up 2L5F Dies. (87-04), TUV KF20 1.3 Chassis Cab, P/up, P/van, Bus 4K Pet., 1.5 P/up 5K Pet. (82-87)
<b>PQ313</b>	Front Wheel Bearing Kit	Toyota Conquest/Tazz EE80 1.3 GL, GS, L, S 2EL (85-93), AE82R 1.6 GL, RS, RSi 4A-L, A-GEL (85-88), Corolla FWD 1.6 GL,GLE, GLi, GLS, GLX, Avante, GLE, GLi, S/W 4A-L, A-GEL, AE/EE80R 1.3 GL, L, 2A-L, E-L (84-88), Rav4 I SXA10/11 2.0 3/5 Dr. SWB SUV 3S-FE Pet. - 4X4 (94-01)
<b>PQ313A</b>	Front Wheel Bearing Kit	Toyota Rav4 I SXA10/11 Series 2.0 3/5 Dr. SWB SUV 3S-FE Pet. - 4X4 (94-01)
<b>PQ314</b>	Rear Wheel Bearing Kit	Toyota Conquest/Tazz EE80 1.3 GL, GS, L, S 2EL, AE82R 1.6 GL, RS, RSi 4A-L, A-GEL, Corolla FWD 1.6 GL,GLE, GLi, GLS, GLX, Avante, GLE, GLi, S/W 4A-L, A-GEL, AE/EE80R 1.3 GL, L, 2A-L, E-L (85-91), 1.6, 160 GL,GLE, GLi, Exec., GLS, Exec., GLX, Sport Sprinter 4A-F, A-FE, A-GE (88-91)
<b>PQ315</b>	Rear Wheel Bearing Kit	Toyota Cressida GX60 2.0 GLi6 1G-E, GX7 2.0 GLi6 1G-E, 1G-FE (83-92), MX63 2.8i 5M-E, MX73 2.8i RSi, RSi Exec. 5M-GE (84-89), MX75 3.0i ECT, GLS 7MG-E (86-92), RX73 2.4 GLE, GLE S/W 22R With I.R.S. (Independent Rear Suspension) (87-92)
<b>PQ318</b>	Front Wheel Bearing Kit 4X4	Toyota Hilux YN67 2.2 LWB D/cab, Raider D/cab P/up 4Y Pet. - 4X4 (86-94), LN65 2.4 LWB D/cab, Raider D/cab P/up 2L Dies. - 4X4 (89-98), LN67 2.8D LWB, D/cab, Raider D/cab P/up 3L Dies. (95-98), Land Cruiser FJ80 4.0 DLX, GX, VX P/up 3F/F-E Pet. (90-92), FZJ/HZJ75 4.2 GX S/W, P/up 1FZF/HZ Dies. (91-97), FZJ80 4.5 Std., GX, VX, Turbo S/W, P/up 1FZ-FE Dies., Turbo Dies. (92-95), FZJ80 4.5 Std., GX, VX, Turbo S/W, P/up 1FZ-FE Dies., Turbo Dies. (95-06), FZJ105 4.5 Std., GX, Turbo P/up, S/W 1FZ-FE Dies., Turbo Dies. (95-98), HDJ/HZJ80 4.2 GX, Turbo S/W, P/up1HD-FT, 1HZ Dies.,T. Dies. (90-95), HDJ/HZJ80 4.2 Std., GX, VX, Turbo S/W, P/up 1HD-FT, 1HZ Dies.,Turbo Dies. (95-01), HDJ100 4.2 Std., GX, VX S/W, 1HZ Pet., 4.5, 4.7 V8 (97-04), HZJ76 4.2D (2009-), HZJ105 4.2 Std., GX DSL, Turbo P/up, S/W 1HZ Dies., Turbo Dies. (98-06), PHJ75 3.9 DLX, GX, GX Turbo P/up Perkins236 2H Dies., FJ75 4.0 DLX, GX, VX 3F/F-E Pet. (85-92), UZJ100 4.5 V8 Std., GX, VX S/W, P/up 2UZ-FE Pet. - 4X4 (98-06)
<b>PQ322</b>	Front Wheel Bearing Kit	Toyota Hiace 1.5, 1.6 (69-77)

## BUYERS GUIDE - BEARING KITS

<b>PQ327</b>	Rear Wheel Bearing Kit	Toyota Land Cruiser FZJ/HZJ75 4.2 GX S/W, P/up 1FZF/HZ Dies. (91-97), PHJ75 3.9 DLX, GX, GX Turbo P/up Perkins236 2H Dies., FJ75 4.0 DLX, GX, VX 3F/F-E Pet., (85-92), Stout RK110 2.0 SWB P/up 5R Pet. - 4X4 (78-89)
<b>PQ328</b>	Front Wheel Bearing Kit	VW Beetle 1.2 (61-65)
<b>PQ335</b>	Front Wheel Bearing Kit	Nissan Sentra 1.3 GL, SX E13S, 1.6 GL, GX, GXE GXEi Coupe, SGLi E16E/S, 1.8i Coupe, Sedan Exec. CA18DE (87-92)
<b>PQ336</b>	Front Wheel Bearing Kit	Volkswagen Kombi 1.6, 1.8 (74-80)
<b>PQ338</b>	Front Wheel Bearing Kit	Honda Ballade SC9 "Flip up Lights" 130 EV2, 150, i EW, 160i DOHC ZC1 (84-89), SH4 150 16V SOHC D15B3, 160i 16V SOHC, DOHC D16A9 (89-92)
<b>PQ339</b>	Rear Wheel Bearing Kit	Nissan Sentra 1.6 GL, GX, GXE GXEi Coupe, SGLi E16E/S, 1.8i Coupe, Sedan Exec. CA18DE (87-92)
<b>PQ340</b>	Rear Wheel Bearing Kit	Nissan Sentra 1.3 GL, SX E13S (87-92)
<b>PQ342</b>	Front Wheel Bearing Kit	BMW 3 Series E30 316 1.8 M10, 316i 1.6 M40, 318i 1.8 M40, 320i M20/50, 323i M50, 325i M52, 333i M30 (83-92)
<b>PQ344</b>	Front Wheel Bearing Kit	Chevrolet Nomad 2.5 (75-80)
<b>PQ346</b>	Front Wheel Bearing Kit 2X4	C.A.M. Rhino 2.8i (2007-), Isuzu KBD20 2.0 P/up C190, KBD21 2.0 P/up C190, KBD22 2.2 LE, P/up C223 (78-89), KB160 1.6 Fleetside P/up, KB200 2.0 LE, Fleetside, D/cab P/up, KB220 2.2 LE, P/up, KB230 2.3 D/cab P/up (89-04), KB260 2.6 LE, D/cab, LX P/up 4ZE1, KB320 3.2 LE, D/cab, LX, Frontier, Reef, Blazer P/up 6VD1 (92-04), KB250D 2.5 Fleet-side, LE, D/Cab P/up 4JA1, KB280DT 2.8 D/cab LE, LX, Frontier P/up Turbo 4JB1 (89-04), KB200i 2.0 LX, KB240i 2.4 LX (04-12), KB250i 2.5 LX, KB250Dc 2.5, KB300TDi 3.0 LX (04-09), KB300TDi 3.0 D-TEQ (07-11)
<b>PQ347</b>	Front Wheel Bearing Kit 4X4	Isuzu KB220 2.2 LE P/up, KB230 2.3 P/up 4ZD1, KB260 2.6 D/cab, LE, LX, KB320 3.2 V6 Frontier LX (89-04), KB200i 2.0 LX KB240i 2.4 LX (04-13), KB250i 2.5 LX (04-09), KB250D 2.5 LE, D/cab P/up 4JA1, KB280DT 2.8 LE, LX, D/cab P/up Turbo 4JB1 (89-04), KB250Dc 2.5, KB300TDi 3.0 LX (04-09), KB300TDi 3.0 D-TEQ - 4X4 (07-11)
<b>PQ351</b>	Rear Wheel Bearing Kit	Nissan 1-Tonner/Hardbody AW/D21 2.4 Z24S (88-98), Sani AW/D21 2.2 Z22, 2.4 Z24 - 4X4 (86-98)
<b>PQ352</b>	Front Wheel Bearing Kit	Nissan 1-Tonner/Hardbody AW/D21 2.4 Z24S - 4x4 (88-98), 2.7 TD27, 3.0 VG30E - 4X4 (90-99), Hardbody QW/D22 2.4i KA24E, 2.7 TD27, 3.0 VG30E, 3.0TD ZD30, 3.2D QD32, 3.3i VG33 - 4X4 (98-10), NP300 D22 2.4i, S/C, D/C Highrider KA24 DE, 2.5TDi, S, SE Highrider YD25 (2008-), Patrol Y60 3.0 VG30E - 4X4 (95-00), Y61 3.0Di, 4.2 TD42 - 4X4 (99-04), Sani AW/D21 2.2 Z22, 2.4 Z24, 2.7 TD27, 3.0 VG30E - 4X4 (86-98), Terrano II 2.7 TD27 - 4X4 (00-02)
<b>PQ353</b>	Front Wheel Bearing Kit	Toyota Camry I SXV10/11 R 200i Si 3S-FE, 220 SEi, Si, 5S-FE (92-01), MCV10/ VCV10 300SEi 1MZ-FE/3VZ-FE, Quad Cam (94-01), Rav4 II ZCA20 1.8 SUV 1ZZFE, ACA20 2.0 SUV 1AZ-FE - 4X2, 4X4 (02-06)
<b>PQ360</b>	Rear Wheel Bearing Kit	Toyota Camry I SXV10/11 R 200i Si 3S-FE, 220 SEi, Si, 5S-FE (92-01)
<b>PQ377</b>	Front Wheel Bearing Kit	Toyota Conquest/Tazz EE80 1.3 GL, GS, L, S 2EL, EE90R 130 Sport, Tazz, Edition, Zipp, Tropicque, Tazz EE90R 130 Edition, Ruby, Tropicque, Sport, McTazz, XE 2E (88-06), AE82R 1.6 GL, RS, RSi 4A-L, A-GEL, AE92R 160i LS, RS, RSi, Sport, RSE, Tazz 4A-F, A-FE, A-GE, AE92R 160i Edition, Sport, Tazz, XE 4AFE (88-06), AE93 180i RS, RSi, Sport 7A-FE (93-96), EE90 130 Carri P/van, 2E (98-06), Corolla FWD EE90R 1.3 GL, GLE, L, Sprinter 2E-L, E EE110R 130 GLE, Sprinter 2E (88-02), AE92R 1.6, 160 GL, GLE, GLi, Exec., GLS, Exec., GLX, Sport Sprinter 4A-F, A-FE, A-GE (88-96), AE93R 180i GL, GLE, GSE, GSX, Sprinter 7A-FE (93-96), AE111R 160i GL, GLE, RSi, RXi 4A-FE, A-GE, AE112 180i GLE, GSE 7A-FE (96-02)
<b>PQ378</b>	Front Wheel Bearing Kit	Toyota Dyna 2.0, 2.2, 2.4, 3.0, 3.7, 4.0 (85-02)
<b>PQ379</b>	Front Wheel Bearing Kit	Toyota Dyna 3.0, 3.8, 4.0 (85-02)
<b>PQ382</b>	Rear Wheel Bearing Kit	Toyota Dyna 2.0, 2.2, 2.4, 3.0, 3.7, 4.0 (85-02)
<b>PQ392</b>	Rear Wheel Bearing Kit	Toyota Dyna 3.0, 3.8, 4.0 (85-02)
<b>PQ393</b>	Front Wheel Bearing Kit	Fiat Uno 1.0 Cento 156A2, 1.1 Espresso P/van 160A3, 1.1 Fire, Rio, Mia, Tempo 160A3, 1.4 Pacer, Beat, Mia, Tempo, SX 146C1 (90-05)
<b>PQ400L</b>	Rear Wheel Bearing Kit	Ford Sapphire 1.6 L Kent, 2.0, i GL, GLE, GLEA, GLi, GLi Exec. Koln, 3.0 Ghia, GLX Essex (89-93), Sierra 2.0 LX Koln, 3.0, i GLS, GLX, LX, RS, XR6 Essex (83-93)
<b>PQ400R</b>	Rear Wheel Bearing Kit	Ford Sapphire 1.6 L Kent, 2.0, i GL, GLE, GLEA, GLi, GLi Exec. Koln, 3.0 Ghia, GLX Essex (89-93), Sierra 2.0 LX Koln, 3.0, i GLS, GLX, LX, RS, XR6 Essex (83-93)



## BUYERS GUIDE - BEARING KITS

<b>PQ401</b>	Front Wheel Bearing Kit	Ford Courier 2.5TD D/cab, Leisure P/up WL4, 3.0 V6 Std., XLT, D/cab, Leisure, Explorer, Exec. P/up Essex, 3.4 V6 Leisure, P/up Essex. - 4X4 (96-00), Ranger 1.8 XL, P/up, 2.2 XL, P/up (04-10), 2.5 D/Cab, High Trail, XL, DT XLT High Super Cab, 2.5TD Montana D/Cab WL4, 3.0TDCi, 4.0 Super Cab XLT - 4X4 (00-12), Mazda B-Series B2600 2.6 V6 LWB D/cab, Magnum, Drifter P/up 4G54 Pet. (86-95), B3000 3.0 V6 LWB D/cab, Magnum, Drifter, Magnum Drifter P/up Essex Pet. (86-97), B2500 2.5, Td LWB D/Cab, Drifter, SLX P/up WL4 Dies./Turbo Dies. (96-99), B3400 3.4 V6 LWB Magnum D/cab P/up Essex (96-01), B2600i 2.6i V6 LWB Drifter, D/cab Drifter SLX P/up 4G54 Pet. 4X4 (00-09), Drifter 1.8 SWB/LWB XL P/up Pet., 2.2 SWB/LWB XL P/up Pet. (00-09), 2.5Td LWB D/cab, DL, SL, SLE, SLX S/cab, D/cab P/up WL4 Dies./Turbo Dies., 2.6i V6 LWB SL S/cab, SLE, SLX D/cab P/up 4G54 Pet. 4X4 (02-04)
<b>PQ402</b>	Rear Wheel Bearing Kit 4X4	Ford Courier 3.0 V6 Std., XLT, D/cab, Leisure, Explorer, Exec. P/up Essex (97-00), Spectron 2.2 Bus, P/van F2 (91-04), Mazda B-Series B2600 2.6 V6 LWB D/cab, Magnum, Drifter P/up 4G54 Pet., B3000 3.0 V6 LWB D/cab, Magnum, Drifter, Magnum Drifter P/up Essex Pet. (Import) (4X4) (86-97), Marathon 2.2 LWB Bus, P/van F2 Pet. (91-04)
<b>PQ403</b>	Rear Wheel Bearing Kit	Mazda 626 2.0i 16V SLi FE (Rear Disc brakes) (89-93)
<b>PQ404</b>	Rear Wheel Bearing Kit	Honda Ballade SC9 "Flip up Lights" 130 EV2, 150, i EW, 160i DOHC ZC1 (Early) (84-89)
<b>PQ405</b>	Rear Wheel Bearing Kit	Honda Ballade SC9 "Flip up Lights" 130 EV2, 150, i EW, 160i DOHC ZC1 (Late) (84-89)
<b>PQ406</b>	Rear Wheel Bearing Kit	Honda Ballade SH4 150 16V SOHC D15B3, 160i 16V SOHC, DOHC D16A9 (89-92), SR4 150 Encore, Luxline, Spreeline D15B3, 160E, i D16A7, 180E, i B18B3 (92-98), SO4 150i Encore, Luxline, Spreeline D15Z4, 160i Luxline, Spreeline, V-Tec D16Y9, D16Z, 180i Luxline B18B4 (96-00), Civic SO3 150i Luxline, Spreeline D15Z4, 160i Luxline, V-Tec D16Z (96-00)
<b>PQ408</b>	Front & Rear Wheel Bearing Kit	Honda SR4 150 Encore, Luxline, Spreeline D15B3, 160E, i D16A7, 180E, i B18B3 (92-98), CR-V II 2.0 K20A4 - 4X4 (05-09), Odyssey 2.2 5 Dr. S/W, 2.3 V-Tec 5 Dr. S/W (96-02)
<b>PQ409</b>	Rear Wheel Bearing Kit	Honda Ballade SH4 150 16V SOHC D15B3, 160i 16V SOHC, DOHC D16A9 (89-92), SR4 150 Encore, Luxline, Spreeline D15B3, 160E, i D16A7, 180E, i B18B3 (92-98), SO4 150i Encore, Luxline, Spreeline D15Z4, 160i Luxline, Spreeline, V-Tec D16Y9, D16Z, 180i Luxline B18B4 (96-00), Civic SO3 150i Luxline, Spreeline D15Z4, 160i Luxline, V-Tec D16Z (96-00)
<b>PQ411</b>	Rear Wheel Bearing Kit	Fiat Uno 1.0 Cento 156A2, 1.1 Espresso P/van 160A3, 1.1 Fire, Rio, Mia, Tempo 160A3, 1.4 Pacer, Beat, Mia, Tempo, SX 146C1 (90-05)
<b>PQ412</b>	Rear Wheel Bearing Kit	Fiat Uno 1.4 Turbo 146A (90-98)
<b>PQ413</b>	USE PQ406	
<b>PQ414</b>	Front Wheel Bearing Kit	Nissan Sabre 160 GX, GXi GA16DS, 200 GXi SR20DE (94-02), Sentra 140, i, GX, GXi, Si GA14DNE / DS, 160 GSi, GX, GXi, SE, Si GA16DE/DNE/ DS, 200 GSi, STi SR20DE (92-02)
<b>PQ415</b>	Rear Wheel Bearing Kit	Nissan Sabre 160 GX, GXi GA16DS (94-02), Sentra 140, i, GX, GXi, Si GA14DNE / DS, 160 GSi, GX, GXi, SE, Si GA16DE/DNE/ DS, 200 GSi, STi SR20DE (92-02)
<b>PQ416</b>	Rear Wheel Bearing Kit	Nissan Sabre 200 GXi SR20DE (94-02), Sentra 200 GSi, STi SR20DE (92-02)
<b>PQ417</b>	Front Wheel Bearing Kit	Opel Astra F 140i, iS 14NV, 160i, iE, iS, Estate 16NZ (93-99), Corsa B 130, i, Lite, iE, iS, Chill Hatch / Sedan 13NE, 140i, Classic, Active, Lite, Lite+, Comfort, Chill, Sport, S 14NE, Hatch/ Sedan, 160, i, iE, Classic, GSi, i Sport, S Hatch/ Sedan, 16SE (96-03), Corsa LDV 130i Utility P/up 13NE, 1.4i Utility, S P/up 14NE, 1.6i Utility Sport P/up 16NZ, 1.7D Utility P/up X17D (97-04), Corsa P/Van 1.3i Pronto 13NE (99-00), Kadett F 140, S 14NE, 160i, iS, GSi, Aspen 16SV/ NZ (93-99)
<b>PQ418</b>	Rear Wheel Bearing Kit	Ford "Boet" Bantam Rocam 1.3i XL, XLT, 1.4i TDCi, 1.6i XL, XLT, XLE, 1.8D XL (02-12), Escort FWD MkVI 1.4i H/back, Sedan CVH-PTE, 1.6i GL, GLE H/back, Sedan Zetec, 1.8i GLi, TDi H/back, Sedan Zetec, 1.8TDi Endura (95-00), Fiesta I 1.3, i Flair, Flite, Play, Fun Endura-EM5, 1.4, i Flair, Trend, Fun Zetec CVH/PTE, 1.6, i Ambiente', Flair, Forte' Ghia, Rsi, Sport, Trend (97-04), Ikon 1.3, Low, LX CLTA, 1.6i, Low, High, LX, CLX CLTA (01-06), Ka 1.3i Ambiente, Trend, Collection Rocam A9A, A9B (05-09), Mazda 121 Soho 1.3, i 3/5 Dr. H/back Endura-EM5, 1.4i 3/5 Dr. H/back Zetec CVH/PTE (97-99)
<b>PQ420</b>	Rear Wheel Bearing Kit	Hyundai Accent X3 1.3 G4EH, 1.5 G4EK (94-00)
<b>PQ421</b>	Rear Wheel Bearing Kit	Hyundai Elantra J1 1.6 Exec., G4CR, 1.8 Exec., G4CN (93-95)
<b>PQ422</b>	Front Wheel Bearing Kit	Hyundai Accent LC 1.3 G4EH, 1.5 G4EK, 1.6 G4ED (00-06), MC 1.6 G4ED (06-11), RB RB (2011-), Atos 1.1 G4HG (05-13), Elantra J2 1.6 RD G4GR, 1.8 G4FG, 2.0 G4GC (95-01), Getz 1.3 G4EA, 1.4i G4EE, 1.5 D3EA, D4FA, 1.6 G4ED-G (03-12), i10 PA 1.1 G4HG, 1.2 G4LA (08-15), i20 PB/PBT 1.2 G4LA, 1.4 G4FA, 1.6 G4FC (2009-), Tiburon 2.0 G4DF (96-10), Kia Picanto 1.1 LX, EX 5 Dr. H/back G4HG (04-11), Rio II 1.4 High, A5D, 1.6 Sport G4ED (2004-), Rio III 1.2 CVVT G4LA, 1.4 G4FA (2011-)
<b>PQ423</b>	Rear Wheel Bearing Kit	Hyundai Accent X3 1.3 G4EH, 1.5 G4EK (94-00), Elantra J2 1.6 RD G4GR, 1.8 G4FG, 2.0 G4GC (95-01), S-Coupe 1.5 (94-95)

## BUYERS GUIDE - BEARING KITS

<b>PQ424</b>	Rear Wheel Bearing Kit	Hyundai Elantra J2 1.6 RD G4GR, 1.8 G4FG, 2.0 G4GC (95-01), Tiburon 2.0 G4DF (96-10)
<b>PQ425</b>	Rear Wheel Bearing Kit	Ford Telstar 2.0 GL, GLE, GLi, Mystique FS/KF, 2.5 V6 Ghia, GLi KL, TX5 2.5 V6 RSi KL (94-99), Mazda 626 2.0i 16V Medium High, V6 24V High KF/KS, 2.5i V6 Exec. KL, MX-6 2.5 V6 KL (93-98)
<b>PQ426</b>	Rear Wheel Bearing Kit	Ford Telstar 2.0 GL, GLE, GLi, Mystique FS/KF, 2.5 V6 Ghia, GLi KL, TX5 2.5 V6 RSi KL (94-99), Mazda 626 2.0i 16V Medium High, V6 24V High KF/KS, 2.5i V6 Exec. KL, MX-6 2.5 V6 KL (93-98), 626 2.0 S/W, Sedan FE (98-03)
<b>PQ427</b>	Front Wheel Bearing Kit	Ford Telstar 2.0 GL, GLE, GLi, Mystique FS/KF, 2.5 V6 Ghia, GLi KL, TX5 2.5 V6 RSi KL (94-99), Kia Carens 1.8 LS 5 Dr. MPV TBD In-Line (00-03), Spectra 1.6 Exec. A6 (01-03), Mazda 626 2.0i 16V Medium High, V6 24V High KF/KS, 2.5i V6 Exec. KL, MX-6 2.5 V6 KL (93-98)
<b>PQ428</b>	Front Wheel Bearing Kit	C.A.M. Rhino 2.2i, 2.8i (2007-), Hyundai Terracan 2.9 CRDi SUV, 3.5i V6 SUV - 4X4 (03-08), Mitsubishi Colt LDV 2.5D LWB Hi-Line P/up 4D56 Dies., 2.6 LWB Lo-/Hi-Line, P/up 4G54 Pet., 3.0 V6 LWB Lo-/Hi-Line D/cab, Rodeo 6G72 Pet. - 4X4 (95-98), 2.4i LWB Hi-Line D/cab, Trailbuster S/cab, P/up Pet. (98-09), 2.8TDi LWB Pioneer, Rodeo D/cab P/up Turbo Dies., 2.8D, TDi LWB Club cab, Trailbuster S/cab, Rodeo /cab P/up Dies./ Turbo Dies., 3.0i V6 LWB Rodeo D/cab P/up Pet. - 4X4 (99-09), Pajero 2.8 Tdi, 3.0 V6 SWB GLS Wagon 6G72 Pet., 3.5 V6 SWB GLS Wagon 6G74 Pet. - 4X4 (90-01)
<b>PQ430</b>	Rear Wheel Bearing Kit	C.A.M. Rhino 2.2i, 2.8i (2007-), Hyundai Bakkie 2.5i D4BH Dies., 2.6i D4BB Dies. (97-01), H100 P/Van 2.5i D4BH Dies. 2.6i D4BB Dies. (00-07), Mitsubishi Colt LDV 1.6 SWB/ LWB Lo-Line P/up 4G32 Pet., 2.0 4G63 Pet., 2.5D 4D56 Dies., 2.6 WB Hi-Line P/up 4G54 Pet. (94-98), 2.5D LWB Hi-Line P/up 4D56 Dies., 2.6 LWB Lo-/Hi-Line, P/up 4G54 Pet., 3.0 V6 LWB Lo-/Hi-Line D/cab, Rodeo 6G72 Pet. - 4X4 (95-98), Pajero 2.8 Tdi, 3.0 V6 SWB GLS Wagon 6G72 Pet., 3.5 V6 SWB GLS Wagon 6G74 Pet. - 4X4 (90-01)
<b>PQ431</b>	Front Wheel Bearing Kit	Toyota Hilux RZN169 2.7i LWB D/cab, DLX S/cab, Raider S/D/cab, SRX D/cab, Legend 35 LWB P/up 3RZFE Pet., LN167 3.0D D/cab D-E, DLX, S/D/cab DE, Raider DE, Legend35 LWB P/up 5L Dies., 3.0iD LWB Raider S/cab & KZ-TE D/cab P/up, Legend35 - 4X4 (98-05)
<b>PQ432</b>	Front Wheel Bearing Kit	Toyota Hilux RN67 2.4 LWB D/cab, Raider D/cab P/up 22R Pet. - 4X4 (94-98), RN58 2.4 22R Pet. (94-98), LN140/145 2.4i DLX, P/up 2L Dies., RZN194 2.7i LWB D/cab, Raider, SRX, Legend35 Raider, 3RZFE Pet., LN192R 3.0D LWB Raider D-E, Raider DLX D/cab D-E, Legend35 Raider, P/up 5L Dies., 3.0iD LWB Raider, Raider D/cab, P/up KZ-TE Dies. (98-05)
<b>PQ433</b>	Front & Rear Wheel Bearing Kit	Audi A4 1.8 8D2, B5 Exec ADR, 1.8T APU (95-01), 2.5 TDi 8D/E2 Quattro AFB, Quattro Tiptronic 2.6 8D2 / 8D5 Exec. (95-00), 3.0 Quattro Tiptronic, ASN (02-08), A6 2.8 Quattro 4A, AAH, ACK, 3.0 Quattro Tiptronic BBJ (94-00), A6 2.4 Avant Multitronic., Tiptronic, AGA, ALF, AML, APS, ARJ, 2.5TDi Multitronic Avant SW., BCZ/BDG/BFC, 2.6 ABC (97-03), VW Passat IV 1.8T AEB, 2.8, 4 Motion, Quattro, Tiptronic ACK/ AMX (99-05)
<b>PQ434</b>	Front Wheel Bearing Kit	Audi 500 2.2 E PR, 2.3 E, SE, AAR, 2.8 SEL AAH (92-94), A6 2.8 Quattro 4A, AAH, ACK, 3.0 Quattro Tiptronic BBJ (94-00), 2.4 Avant Multitronic., Tiptronic, AGA, ALF, AML, APS, ARJ, 2.5TDi Multitronic Avant SW., BCZ/BDG/BFC, 2.6 ABC (97-03), 2.7T Quattro AJK, ARE, BES (00-06), 2.4 BDV (02-05), A8 3.7 Tiptronic AQQ, 4D2, 4.2 Quattro 4E2/8 BFM (95-02), S4 2.2T Quattro AAN (92-95), VW Passat IV 1.8T AEB, 3.2 V6 Sportline DSG AXZ (99-05)
<b>PQ435</b>	Front Wheel Bearing Kit	Audi A4 2.5 TDi 8D/E2 Quattro AFB, Quattro Tiptronic, 2.6 8D2 / 8D5 Exec. (95-00), 3.0 Quattro Tiptronic, ASN (02-08)
<b>PQ436</b>	Front Wheel Bearing Kit	Ford Falcon 4.0 GLi, Fairmont, Fairmont, Futura XR6 Mpi (96-03), Ranchero 4.0 GLi, Outback, XR6 P/up 250 (97-99)
<b>PQ437</b>	Rear Wheel Bearing Kit	Chevrolet Aveo 1.5 L, LS, LT, 1.6 LS (03-13), Spark 1.0 B1I0S1, 1.2 B12D1 (2010-)
<b>PQ437A</b>	Rear Wheel Bearing Kit	Chevrolet Aveo 1.5 L, LS, LT, 1.6 LS (03-13), Spark 1.0 B1I0S1, 1.2 B12D1 (2010-)
<b>PQ437B</b>	Rear Wheel Bearing Kit	Chevrolet Aveo 1.5 L, LS, LT (03-15)
<b>PQ438</b>	Front Wheel Bearing Kit	Mercedes-Benz W124 E Class E200 M102.922, E220 M111.960, E320 Sportline, M104.992 (93-96), R170 SLK200, SLK320 M112.947 (97-02), R170 SLK200K M111.958, SLK320, SLK32 AMG M112.960 (02-04), W202 C-Class C180 Classic M111.920, C200 M111.941, C220 M111.961, C230 M111.974, C240 M111.944, C250 M605.910, C270CDi M612.962, C280 M104.941 (94-08), W208 CLK230, M111.973, CLK320, M112.940, CLK430, CLK500 (98-03), W210 E-Class E200, K M111.941/956, E230 M111.970, E240 M112.911, E280 M112.921, E320 M112.941, E320CDi OM646.961, E350 M272.964, E500 M113.967 (96-10)
<b>PQ439</b>	Front & Rear Wheel Bearing Kit	Daewoo Tacuma 1.6 SX, 2.0 CDX, CDX Plus (01-03), Opel Astra F 200i, e, ts 20SE/ XE (93-99), Kadett F 200is 20XE (93-99), Omega 2.2i Y22XE, 2.6i Elegance Y26SE (01-04)
<b>PQ440</b>	Front Wheel Bearing Kit	VW Caddy 1.6i Club, Citi, P/up HM Pet. (97-03), Polo 6N 1.4 Classic, Playa Lux AEX, 1.6 Classic, Playa, Lux AEE (96-03)
<b>PQ441</b>	Front Wheel Bearing Kit	Mercedes-Benz W201 190E 1.8 M102.920, 2.0 M102.922, 2.3 Sportline M102.983 (93-94)
<b>PQ442</b>	Front Wheel Bearing Kit	Mercedes-Benz 280E M104.942 (86-96)



## BUYERS GUIDE - BEARING KITS

<b>PQ443</b>	Rear Wheel Bearing Kit	Mercedes-Benz W124 200E M102.922, 220E M111.960, 230E M102.982, 260E M103.940, 280E M104.942, 300D M103.985, M606.910, 320 Sportline M104.922 (86-96), W124 E-Class E200 M102.922, E220 M111.960, E320 Sportline, M104.992 (93-96), R170 SLK200, SLK320 M112.947 (97-02), R170 SLK200K M111.958, SLK320, SLK32 AMG M112.960 (02-04), R171 SLK200K M271.954/958, SLK350 M272.963/ 969, SLK55 AMG M113.989 (04-11), R172 SLK250, SLK350 M276.956, SLK55 AMG M152.980 (2011-), W201 190E 1.8 M102.920, 2.0 M102.922, 2.3 Sportline M102.983 (93-94), W202/3 C-Class C180 Classic M111.920, C200 M111.941, C220 M111.961, C230 M111.974, C240 M111.944, C250 M605.910, C270CDi M612.962, C280 M104.941 (94-08), W208 CLK230, M111.973, CLK320, M112.940, CLK430, CLK500 (98-03), W210/211 E-Class E200, K M111.941/956, E230 M111.970, E240 M112.911, E280 M112.921, E320 M112.941, E320CDi OM646.961, E350 M272.964, E500 M113.967 (96-10)
<b>PQ444</b>	Front Wheel Bearing Kit	Mercedes-Benz W124 200E M102.922, 220E M111.960, 230E M102.982, 260E M103.940, 300D M103.985, M606.910, 320 Sportline M104.922 (86-96)
<b>PQ444A</b>	Component For PQ444	Mercedes Benz 190E 1.8, 2.0, 2.3 (93-94), 200, E, 220E, 230E, 260E, 300D, E, 320E (86-96)
<b>PQ445</b>	Rear Wheel Bearing Kit	Mercedes-Benz W124 200E M102.922, 220E M111.960, 230E M102.982, 260E M103.940, 280E M104.942, 300D M103.985, M606.910, 320 Sportline M104.922 (86-96), W124 E Class E200 M102.922, E220 M111.960, E320 Sportline, M104.992 (93-96), W202/3 C-Class C180 Classic M111.920, C200 M111.941, C220 M111.961, C230 M111.974, C240 M111.944, C250 M605.910, C270CDi M612.962, C280 M104.941 (94-08)
<b>PQ446</b>	Rear Wheel Bearing Kit	Nissan Maxima GV Series 300SE VG30E (91-97)
<b>PQ447</b>	Front Wheel Bearing Kit	Nissan Maxima GV Series 300SE VG30E (91-97), CA33 & QX Series 2.0 VQ20E, 3.0 VQ30DE (96-04), Primera 160 Si, SE SR16DE, 200 GSi, Si , STi, Elegance, Luxury SR20DE (98-02)
<b>PQ448</b>	USE PQ456	
<b>PQ449</b>	Front & Rear Wheel Bearing Kit	Audi A3 1.8 8L1 AGN, 1.8T AGU, BPU (98-04), A4 1.8T Avant, Multitronic, BFB, B6 AVJ 8E2, 1.9 TDi AVF, Avant B6, 8E5, 8E2 (00-08), S3 1.8T 8L1 Quattro AMK, BAM, APY (00-04), TT 1.8T Coupe, Sport, Roadster, Coupe 8N3/9 APX, 1.8T Quattro APX, BAM, BFV (00-07), Mazda 323 FWD 2.0 EG Hatch, SLE Hatch, SLi Sedan, 200e Hatch, Sedan, 200i Hatch 8/16V FE-2000 (89-95), 130 Hatch, Midge, Sedan, Sting B3, 160, i, S Hatch, Midge, Sedan, Sting F6, 200i, e Hatch 8/16V FE 2000 (95-05), VW Beetle 1.8T Coupe APH, 2.0i Cabriolet, Highline AZJ (00-12), Golf IV 1.6i Comfortline, Std., Estate AKL, 1.8, T GTi, Highline AGU/ AGN, 1.9 TDi Highline, Estate AHF, 2.0i Cabrio, Highline APK (99-04), Jetta IV 1.6i Comfortline, Std. AKL, 1.8T Highline, Exec AGU, 1.9 TDi Highline AHF, 2.0i Highline APK, 2.3 V5 AGZ (99-06)
<b>PQ450</b>	Rear Wheel Bearing Kit	Audi A3 1.8 8L1 AGN, 1.8T AGU, BPU (98-04), A4 1.8T Avant, Multitronic, BFB, B6 AVJ 8E2, 1.9 TDi AVF, Avant B6, 8E5, 8E2 (00-08), TT 1.8T Coupe, Sport, Roadster, Coupe 8N3/9 APX, 1.8T Quattro APX, BAM, BFV (00-07), VW Beetle 1.8T Coupe APH, 2.0i Cabriolet, Highline AZJ (00-12), Golf IV 1.6i Comfortline, Std., Estate AKL, 1.8, T GTi, Highline AGU/ AGN, 1.9 TDi Highline, Estate AHF, 2.0i Cabrio, Highline APK (99-04), Jetta IV 1.6i Comfortline, Std. AKL, 1.8T Highline, Exec AGU, 1.9 TDi Highline AHF, 2.0i Highline APK, 2.3 V5 AGZ (99-06), Cross Polo 1.6TDi (07-10), Polo 1.2 Trendline DSG Petrol CBZB, 1.2 Man. CGPA/ CGPB (10-15), 1.2TSi Comfortline Man. CBZC (2013-), Polo GP 1.0TSi Comfortline CHZC TSi R Line DSG CHZC (2016-)
<b>PQ452</b>	Rear Wheel Bearing Kit	Toyota Conquest, Tazz EE90R, 130 Sport, Tazz, Edition, Zipp, Tropique, Tazz EE90R 130 Edition, Ruby, Tropique, Sport, McTazz, XE 2E, AE92R 160i LS, RS, RSi, Sport, RSE, Tazz 4A-F, A-FE, A-GE, AE92R 160i Edition, Sport, Tazz, XE 4AFE (91-06), Conquest EE90 130 Carri P/van, 2E (98-06), Corolla FWD EE90R 1.3 GL, GLE, L, Sprinter 2E-L, E EE110R, 130 GLE, Sprinter 2E (91-02), AE92R 1.6, 160 GL, GLE, GLi, Exec., GLS, Exec., GLX, Sport Sprinter 4A-F, A-FE, A-GE (91-96), AE93R 180i GL, GLE, GSE, GSX, Sprinter 7A-FE (93-96), AE111R 160i GL, GLE, RSi, RXi 4A-FE, A-GE, AE112 180i GLE, GSE 7A-FE (96-02)
<b>PQ453</b>	Front Wheel Bearing Kit	Toyota Corolla FWD AE111R 160i GL, GLE, RSi, RXi 4A-FE, A-GE, AE112 180i GLE, GSE 7A-FE (96-02)
<b>PQ454</b>	Rear Wheel Bearing Kit	Toyota Conquest 1.3, 1.6, Corolla 1.3, 1.6, 1.8 (90-96)
<b>PQ455</b>	Rear Wheel Bearing Kit	Hyundai Accent LC 1.3 G4EH, 1.5 G4EK, 1.6 G4ED (00-06), Atos 1.0 Prime G4HC, 1.1 G4HG (00-13)
<b>PQ456</b>	Rear Wheel Bearing Kit	Toyota Conquest AE93 180i RS, RSi, Sport 7A-FE, Corolla FWD AE93R 180i GL, GLE, GSE, GSX, Sprinter 7A-FE (93-96), AE111R 160i GL, GLE, RSi, RXi 4A-FE, A-GE, AE112 180i GLE, GSE 7A-FE (96-02)
<b>PQ457</b>	Rear Wheel Bearing Kit	Toyota Rav4 I SXA10/11 Series 2.0 3/5 Dr. SWB SUV 3S-FE Pet. - 4X4 (94-01)
<b>PQ458</b>	Front Wheel Bearing Kit	VW Kombi T3 2.1 Fi Syncro Caravelle DJ Pet. - 4X4 (89-93)
<b>PQ459</b>	Rear Wheel Bearing Kit	Toyota Conquest 1.6 (88-91)

## BUYERS GUIDE - BEARING KITS

<b>PQ460</b>	Front Wheel Bearing Kit	Ford Mondeo 1.8i LX, Tdi LX Zetec M5 Endura TD, 2.0i Aspen, CLX, CLX, Ghia, Trend Zetec M5, 2.5i Si Duratec M5 (97-01)
<b>PQ461</b>	Rear Wheel Bearing Kit	Ford Mondeo 1.8i LX, Tdi LX Zetec M5 Endura TD, 2.0i Aspen, CLX, CLX, Ghia, Trend Zetec M5, 2.5i Si Duratec M5 (97-01)
<b>PQ462</b>	Rear Wheel Bearing Kit	Ford Mondeo 1.8i LX, Tdi LX Zetec M5 Endura TD, 2.0i Aspen, CLX, CLX, Ghia, Trend Zetec M5, 2.5i Si Duratec M5 (97-01)
<b>PQ463</b>	Rear Wheel Bearing Kit	Toyota Camry I MCV10/ VCV10 300SEi 1MZ-FE/3VZ-FE, Quad Cam (94-01)
<b>PQ464</b>	Front Wheel Bearing Kit	Honda Ballade SO4 150i Encore, Luxline, Spreeline D15Z4, 160i Luxline, Spreeline, V-Tec D16Y9, D16Z, 180i Luxline B18B4 (96-00), Civic SO3 150i Luxline, Spreeline D15Z4, 160i Luxline, V-Tec D16Z (96-00), Civic VII 150i, 170i V-Tec (03-06), Odyssey 2.2 5 Dr. S/W, 2.3 V-Tec 5 Dr. S/W (96-02)
<b>PQ465</b>	Rear Wheel Bearing Kit	Alfa Romeo 145 2.0 Quadrofoglio AR32301 (96-01), 146 2.0 Ti Twin Spark AR67204 (96-99), Mito 1.4 TB (2009-), Fiat 500 1.2 169A4.000, 1.4 16V 169A3.000 (08-15), Multipla 1.9 JTD ELX MPV 182A4.000 (03-06), Palio I 1.2 ED, EL, Go!, Paint Ltd. M657BA.12T 178B5.000, 1.6 EL, ELX, HL, Weekend S/W, 178B3.000 (00-05), Palio II 1.2 Espresso 178B6.000 (05-10), Panda 1.1 Active, 187A1.000, 1.2 Dynamic 169A4.000, 188A4.000, 1.4 100HP 169A3.000 (2006-), Punto 1.8 HGT 188A1.000, 188A6.000 (04-13), Stilo 1.6 Active, MultiWagon, 182B6, 1.9 JTD Dynamic, MultiWagon JTD Dynamic 192A1.000, 937A7.000 (03-06)
<b>PQ466</b>	Front Wheel Bearing Kit	Renault Laguna I 1.6 RT, RTE K4M720, 1.8 RN, RN Estate, Authentique, Expression F4P7 RT B568/-9F3P/-P6, 1.9dCi F9Q716, 2.0 RT, RT Estate, RXE, Expression K4M720/724, N7Q700 (96-07), 3.0 Privilege, RXT L7X731 L7X700 (96-02), Megane I 1.6 Classic RXE, RT, RXT, RSi Coupe, RN Hatch, RT Coupe, Hatch, RXE, RXI Cabriolet K7M700/ 02/-03 (96-02), 2.0 Coupe 8/16V F3R710/50, RXE, RSi Coupe, Cabriolet F3R796/ -7/-8 (96-02), Megane II 1.4 Authentique, Dynamique E7J626/-50 (02-10), Scenic I 1.4 RTE, 1.6 RT, RXE, 1.9 dCi, 2.0 RXE, Rxi (98-02), Scenic II 1.4 Authentique K4J750 (01-04)
<b>PQ467</b>	Front Wheel Bearing Kit	Renault Laguna I 1.6 RT, RTE K4M720, 1.8 RN, RN Estate, Authentique, Expression F4P7 RT B568/-9F3P/-P6, 1.9dCi F9Q716, 2.0 RT, RT Estate, RXE, Expression K4M720/724, N7Q700 (96-07), 3.0 Privilege, RXT L7X731 L7X700 (96-02), Megane I 1.6 Classic RXE, RT, RXT, RSi Coupe, RN Hatch, RT Coupe, Hatch, RXE, RXI Cabriolet K7M700/ 02/-03 (96-02), 2.0 Coupe 8/16V F3R710/50, RXE, RSi Coupe, Cabriolet F3R796/ -7/-8 (96-02), Megane II 1.4 Authentique, Dynamique E7J626/-50 (02-10), Sandero 1.4 Authentique, 1.6 Cup, Dynamique, Expression, Pack (09-15), Scenic I 1.4 RTE, 1.6 RT, RXE, 1.9 dCi, 2.0 RXE, Rxi (98-02), Scenic II 1.4 Authentique K4J750 (01-04), Clio I, II 1.2 Authentique, Expression, Generation, Va Va Voom D4F706, 1.4 Alaise, Privilege, Expression, RT, Va Va Voom K4J7/EJ634, 1.5 DCi Expression., K9K700/-702, 1.6 Expression, Dynamique, Privilege, Sport K4M744/ -745/-748 (99-04), 2.0 Sport F4R, 3.0 V6 Sport F7R (01-09), Kangoo 1.4 Express van E7J780, 1.5dCi Express van K9K700 (01-10), 1.4 Multix Authentique MPV E7J780, 1.5DCi (03-10)
<b>PQ468</b>	Rear Wheel Bearing Kit	Renault Espace 2.0 Authentique Expression, RXE, RXT MPV J7R, F4R, 3.0 L7X727, 3.0 Previl (96-08), Megane I 2.0 Coupe 8/16V F3R710/50, RXE, RSi Coupe, Cabriolet F3R796/ -7/-8 (96-02), Scenic I 1.4 RTE, 1.6 RT, RXE, 1.9 dCi, 2.0 RXE, Rxi (98-02), Scenic II 1.4 Authentique K4J750 (01-04)
<b>PQ469</b>	Rear Wheel Bearing Kit	Renault Megane I 1.6 Classic RXE, RT, RXT, RSi Coupe, RN Hatch, RT Coupe, Hatch, RXE, RXI Cabriolet K7M700/ 02/-03 (96-02), 2.0 Coupe 8/16V F3R710/50, RXE, RSi Coupe, Cabriolet F3R796/ -7/-8 (96-02), Scenic I 1.4 RTE, 1.6 RT, RXE, 1.9 dCi, 2.0 RXE, Rxi (98-02), Scenic II 1.4 Authentique K4J750 (01-04)
<b>PQ471</b>	Front & Rear Wheel Bearing Kit	Kia Clarus 2.0 GLX 4 Dr. Sedan FE (98-01), Sephia 1.5i LS, RS 4 Dr. Sedan BFD (04-05), Shuma I 1.5i LS 4 Dr. Sedan BFD, 1.8i GS 5 Dr. H/back TBD (98-01), Spectra 1.6 Exec. A6 (01-03), Mazda 626 2.0 S/W, Sedan FE (98-03), Astina 180 Se Hatch Bpi (95-00), Etude 160, e, i, iE, iSE Sport, 180, e, SE, 160 iE, iSE, Sport, 180 iSE, iSX, Sport (95-04), MX-5 1.6 (90-93), 1.8 16V (01-09), 2.0 (05-14)
<b>PQ472</b>	Front Wheel Bearing Kit	Alfa Romeo 146 2.0 Ti Twin Spark AR67204 (96-99), 155 2.0 TS AR32301, 2.5 V6 AR67301 (96-99), GTV / Spider 2.0 (96-06), Fiat Doblo 1.9 Cargo P/van 223A6.000, Multipla 1.6 Active, 1.6 SX, 1.9 JTD ELX MPV 182A4.000 (03-10), Punto 1.2 Dynamic 188A5000, 1.3D 2U 188 JTD Dynamic, JTD Multijet 188A9.000, 1.4 Multiair (04-13)
<b>PQ473</b>	Rear Wheel Bearing Kit	Fiat Multipla 1.6 Active, 1.6 SX, 1.9 JTD ELX MPV 182A4.000 (03-10), Palio I 1.2 ED, EL, Go!, Paint Ltd. M657BA.12T 178B5.000, 1.6 EL, ELX, HL, Weekend S/W, 178B3.000 (00-05), Panda 1.1 Active, 187A1.000, 1.2 Dynamic 169A4.000, 188A4.000, 1.4 100HP 169A3.000 (2006-), Punto 1.2 Dynamic 188A5000 (04-13), Siena I/II 1.2 EL, EL, Plus!, M657BA 12T, 1.6 EL, Plus!, ELX HL 178B3.000, 1.6 EL+, HL, ELX, 178B3000, 1.7TD EL 176A3.000 (00-10), Strada 1.2 EL P/up, 1.4, 1.6 EL, EL Sporting, ELX P/up, 1.7D EL P/up (05-10)

## BUYERS GUIDE - BEARING KITS

<b>PQ474</b>	Front Wheel Bearing Kit ASB	Alfa Romeo 145 2.0 Quadrofoglio AR32301 (96-01), 146 2.0 Ti Twin Spark AR67204 (96-99), 155 2.0 2.0 TS AR32301 (96-99), 2.0 GTV / Spider (96-06), Mito 1.4 TB (2009-), Fiat 500 0.9 199 B6.000, 1.4 16V 169A3.000 (08-15), Doblo 1.9 Cargo P/van 223A6.000 (03-06), Multipla 1.6 Active, 1.6 SX, 1.9 JTD ELX MPV 182A4.000 (03-10), Panda 1.2 Dynamic 169A4.000, 188A4.000, 1.4 100HP 169A3.000 (2006-), Punto 1.4 Multiair, 1.8 HGT 188A1.000, 188A6.000 (04-13), Grande Punto I 1.2 199A4.000, 1.3D JTD Dynamic, JTD Multijet 199A2.000, 199A3.000, 1.9 Multijet 939A1.000 (06-10), Opel Corsa E 1.0 T B10XFT, F10XFT, 1.4 T B14XEL, 1.4 T B14NEH (2015-)
<b>PQ475</b>	Rear Wheel Bearing Kit	Alfa Romeo 146 2.0 Ti Twin Spark AR67204 (96-99), 155 2.0 TS AR32301, 2.5 V6 AR67301 (96-99), Palio II 1.2 Go!, 178B5.000, 1.6 178B3.000, 1.7TD, EL. (05-10), Siena I/II 1.2 EL, EL, Plus!, M657BA 12T, 1.6 EL, Plus!, ELX HL 178B3.000, 1.6 EL+, HL, ELX, 178B3000, 1.7TD EL 176A3.000 (00-10)
<b>PQ476</b>	Rear Wheel Bearing Kit	Alfa Romeo 155 2.0 TS AR32301, 2.5 V6 AR67301 (96-99)
<b>PQ477</b>	Front Wheel Bearing Kit	Alfa Romeo 155 2.0 TS AR32301, 2.5 V6 AR67301 (96-99), GTV / Spider 3.0 V6 (99-04)
<b>PQ478</b>	Front Wheel Bearing Kit	Chrysler Voyager 2.0 SE MPV, 2.4 SE MPV (97-04), Grand Voyager 2.5 SE MPV, 3.3 LE, LX, Ltd., SE MPV (15 Rims) (96-04)
<b>PQ479</b>	Rear Wheel Bearing Kit	Chrysler Voyager 2.0 SE MPV, 2.4 SE MPV (97-04), Grand Voyager 2.5 SE MPV, 3.3 LE, LX, Ltd., SE MPV (96-04)
<b>PQ480</b>	Front Wheel Bearing Kit	Mercedes-Benz W123 200 M115.938/9, 230, E M115.954, 240D M616.912, 250 M123.920/1, 280E M110.983, 300D M617.912 (77-86), W126 280SE M110 987/9, 300SE M103.981, 380SE M116.963, 420SE M116.965, 500SE M117.965 (86-93)
<b>PQ481</b>	Front Wheel Bearing Kit	Mercedes-Benz BM903/4 Sprinter 308D 2.2 OM 601 LA dies., 312D 2.2 OM602 LA dies., 313 2.2 LWB,SWB Bus, P/van OM611 LA Pet., 412D 2.8 OM612, 413CDi 2.2, 416CDi 2.2 (96-06)
<b>PQ482</b>	Rear Wheel Bearing Kit	Mercedes-Benz BM903/4 Sprinter 308D 2.2 OM 601 LA dies., 312D 2.2 OM602 LA dies., 313 2.2 LWB,SWB Bus, P/van OM611 LA Pet., 412D 2.8 OM612, 413CDi 2.2, 416CDi 2.2 (96-06)
<b>PQ483</b>	Front Wheel Bearing Kit	Citroen Berlingo 1.4 P/van TU3JP Pet., 1.6 TU5JP4B, 1.6Hdi 90LS DV6TED4BU, DV6AUTED4, 1.9D LWB P/van XUD9A Dies. (03-15), Picasso 1.6, 1.6Hdi, 1.8, 2.0, 2.0Hdi (03-06), Xsara 1.6 SX TU5JP, 1.8 Picasso Exclusive, EW7J4, 2.0 Picasso HDi, VTS, Exclusive, HDi Exclusive DW10/TD (03-08), Peugeot 206 2.0 CC, GTi, 180 EW10J4, XT HDi DW10TD (01-08), 2.0 Hdi (04-06), 306 1.6 XT S/W TU5JP 2.0 Cabrio, XSi XU10J4R/RS/, XU10J2/K (95-03), 405 1.6 GR XU52C/K, 1.8 GR XU7JP/LZ, 2.0 SRI XU7J2/CL (95-97), 406 2.0 Coupe, Estate, SLi, ST, ST Comfort, Estate, STi, Si EW10J4R/XU10J4R/XU10J2TE, 3.0 ST, SV Executive ES9J4S (96-05), Partner 1.6 , Hdi, 1.9D, 2.0 HDI (03-10)
<b>PQ484</b>	Rear Wheel Bearing Kit	Citroen C2 1.4 HDi, DV4TD, 1.4i VTR TU3JP, 1.6i VTS TU5JP4S (04-10), C3 1.4i HDi, DV4TED4, 1.6i Pluriel, Sensodrive, TU5JP4 (02-10), Peugeot 206 1.4 X-Line, XS-Line, XS-Line HDi, Popart, Popart+ TU3JP, 1.6 XS-Line, CC, SW XS, XT, XT Premium TU5JP4, 2.0 CC, GTi, 180 EW10J4, XT HDi DW10TD (01-08), 2.0 Hdi (04-06), 306 1.6 XT S/W TU5JP 2.0 Cabrio, XSi XU10J4R/RS/, XU10J2/K (95-03)
<b>PQ484A</b>	Rear Wheel Bearing Kit	Citroen C2 1.4 HDi, DV4TD, 1.4i VTR TU3JP, 1.6i VTS TU5JP4S (04-10), C3 1.4i HDi, DV4TED4, 1.6i Pluriel, Sensodrive, TU5JP4 (02-10)
<b>PQ486</b>	Rear Wheel Bearing Kit	Renault Modus 1.2 Authentique D4F706, 1.4 Dynamique, Expressio K4J770, 1.6 Expression K4M761-11 (05-08)
<b>PQ487</b>	Rear Wheel Bearing Kit	Nissan Micra (K12/13) 1.2 HR12DE, 1.4 Accenta, Accenta+, Accenta Sport, Visia, Comfort, Elegance, SE CR14PE, 1.5 dCi Tekna, Acenta HR15DE (2004-), NP200 1.5DCi S, SE P/up, 1.6, S, SE P/up (2008-), Renault Clio I, II 1.2 Authentique, Expression, Generation, Va Va Voom D4F706, 1.4 Alaise, Privilege, Expression, RT, Va Va Voom K4J7/EJ634 (99-09), 1.6 Expression, Dynamique, Privilege, Sport K4M744/ -745/-748 (99-10), 2.0 Sport F4R, 3.0 V6 Sport F7R (01-09), Clio III 2.0 Sport, R27, Ltd. Edition F4R832/830 (07-14), Clio IV 0.9T, 1.2 (2013-), Logan 1.6 Expression (2009-), Megane I 1.6 Classic RXE, RT, RXT, RSi Coupe, RN Hatch, RT Coupe, Hatch, RXE, RXI Cabriolet K7M700/ 02/-03 (96-02), Megane II 1.4 Authentique, Dynamique E7J626/-50 (02-10), Sandero 1.4 Authentique, 1.6 Cup, Dynamique, Expression, Pack (09-15), Twingo 1.2 Dynamique, D4F772, 1.6 RS K4M854 (08-13)
<b>PQ491</b>	Front Wheel Bearing Kit	Opel Astra G 1.6 CS, Classic CD, CDE, Comfort C16SEL, 1.8 Classic CDE, Caravan CD S/W, Elegance, Irmscher X18XE1 (99-06), Zafira I 1.8i CD, Enjoy, Elegance MPV Z18XE/-1 (01-05)



## BUYERS GUIDE - BEARING KITS

<b>PQ492</b>	Rear Wheel Bearing Kit	Chevrolet Utility 1.3D, 1.4 Pet., 1.8 Pet. (11-15), Opel Astra G 1.6 CS, Classic CD, CDE, Comfort C16SEL, 1.8 Classic CDE, Caravan CD S/W, Elegance, Irmscher X18XE1 (99-06), Corsa C 140i Classic, Comfort, Chill, Classic Essentia, Hatch Club, Sport, Lite Sport, S14NE, 160i Classic, Classic Elegance, Classic CD, CDE, Sport, 16SE, 1.7TDi Sport, Classic, CDTi Enjoy, Hatch CDTi Elegance, Classic DTi Elegance X17D, 1.8i GSi Hatch, Classic (03-08), Corsa LDV II 1.4i Utility, Club Sport, S P/up 14XE, 1.7DTi Utility Club, Sport P/up, 1.8i Utility Club, Sport P/up (03-10), Corsa 1.4i Combo P/van (2006-), Meriva 1.3 CDTi Enjoy, 1.4 Essentia, Enjoy, 1.6 Club, Comfort, Enjoy MPV Z16SE/-XE, 1.7 CDTi Enjoy, Elegance, 1.8 Elegance MPV Easytronic (03-09), Zafira I 1.8i CD, Enjoy, Elegance MPV Z18XE/-1 (01-05)
<b>PQ493</b>	Front Wheel Bearing Kit	Opel Astra G 1.6 CS, Classic CD, CDE, Comfort C16SEL, 1.8 Classic CDE, Caravan CD S/W, Elegance, Irmscher X18XE1 (99-06), 2.0 Coupe', CSX X20XE1, 2.2i Classic Exec. (99-05)
<b>PQ494</b>	Rear Wheel Bearing Kit	Opel Astra G 2.0 Coupe', CSX X20XE1, 2.2i Classic Exec. (99-05), Meriva 1.3 CDTi Enjoy, 1.4 Essentia, Enjoy, 1.6 Club, Comfort, Enjoy MPV Z16SE/-XE, 1.7 CDTi Enjoy, Elegance, 1.8 Elegance MPV Easytronic (03-09)
<b>PQ495</b>	Rear Wheel Bearing Kit	Opel Astra G 2.0 Coupe', CSX X20XE1, 2.2i Classic Exec. (99-05)
<b>PQ496</b>	Front Wheel Bearing Kit	VW Kombi T4 2.5Tdi Microbus, Caravelle, Trend, High ACV, AAB Dies., Turbo Dies. (99-06)
<b>PQ496A</b>	Rear Wheel Bearing Kit	VW Kombi T4 2.5Tdi Microbus, Caravelle, Trend, High ACV, AAB Dies., Turbo Dies. (99-06)
<b>PQ499</b>	Front Wheel Bearing Kit	Ford B-Max 1.0 EcoBoost M1JE, M1JH (2015-), Fiesta II 1.4i Trend Zetec, 1.6i RSi, TDCi Rocam, 2.0 ST, ST150 (04-09), 1.0 Ecoboost, 1.4 Sedan, 1.4i Ambiente', Trend, Titanium, 1.6 Limited, 1.6i Ambiente', Sport, Trend, Titanium, TDCi (2008-), Figo 1.4 Ambiente', Trend, FXJA/B, 1.4 TDCi Ambiente', F6JB/D (2010-), Focus I 1.6i 4/5 Door, Ambiente' Zetec S, 1.8 TDCi F9DA, F9DB, 2.0i 4/5 Door, L Trend, RS, ST170 Zetec E (00-05), Ikon 1.3, Low, LX CLTA, 1.6i, Low, High, LX, CLX CLTA (01-06), 1.4, Low, LX, 1.4 Tdci, 1.6i (07-11), Ka 1.3i Ambiente, Trend, Collection Rocam A9A, A9B (05-09), Mazda 2 (DE) 1.3 Active, Dynamic, 1.5 Dynamic, Individual (07-12)
<b>PQ500</b>	Rear Wheel Bearing Kit	Ford Fiesta II 1.4i Trend Zetec, 1.6i RSi, TDCi Rocam, 2.0 ST, ST150 (04-09)
<b>PQ500ASB</b>	Rear Wheel Bearing Kit ASB	Ford Fiesta II 1.4i Trend Zetec, 1.6i RSi, TDCi Rocam, 2.0 ST, ST150 (04-09), Figo 1.4 Ambiente', Trend, FXJA/B, 1.4 TDCi Ambiente', F6JB/D (2010-), Focus I 1.6i 4/5 Door, Ambiente' Zetec S, 1.8 TDCi F9DA, F9DB, 2.0i 4/5 Door, L Trend, RS, ST170 Zetec E (00-05), Ikon 1.4, Low, LX, 1.4 Tdci, 1.6i (07-11)
<b>PQ500ASB-COMP</b>	Rear Wheel Bearing Kit Comp	Ford Fiesta II 1.4i Trend Zetec, 1.6i RSi, TDCi Rocam, 2.0 ST, ST150 (04-09), Figo 1.4 Ambiente', Trend, FXJA/B, 1.4 TDCi Ambiente', F6JB/D (2010-), Focus I 1.6i 4/5 Door, Ambiente' Zetec S, 1.8 TDCi F9DA, F9DB, 2.0i 4/5 Door, L Trend, RS, ST170 Zetec E (00-05), Ikon 1.4, Low, LX, 1.4 Tdci, 1.6i (07-11)
<b>PQ502</b>	Rear Wheel Bearing Kit	Fiat Seicento 1.1 S, Sporting 176B2.000 (01-03)
<b>PQ503</b>	Rear Wheel Bearing Kit	Peugeot 206 2.0 CC, GTi, 180 EW10J4, XT HDi DW10TD Pet. (01-08)
<b>PQ504</b>	Front & Rear Wheel Bearing Kit	Land Rover Freelander 1.8i S/W Pet., 2.0 Di S/W, Td4 SUV Pet., 2.5 V6 SUV KV6 Pet. (98-04)
<b>PQ504ASB</b>	Front & Rear Wheel Bearing Kit	Fiat Ulysse 2.0 MPV XU10 J2/Z (99-02), Land Rover Freelander 1.8i S/W Pet., 2.0 Di S/W, Td4 SUV Pet., 2.5 V6 SUV KV6 Pet. (98-04), Land Rover Freelander II 2.0, 2.2 D, 2.2 TD4, 3.2 V6 (07-10)
<b>PQ505</b>	Front Wheel Bearing Kit	Volvo S70 2.3 T5 Cabrio, Coupe B5434T4, 2.4 Cabrio, Coupe B5254S, V70 2.3 T5 Estate B5434T4, 2.4, T Estate B5254S, 2.5T Estate (97-98)
<b>PQ506</b>	Front Wheel Bearing Kit	Volvo S40 2.0T 4Dr. Sedan B4204 T2/T3, V40 2.0T Estate B4204S (98-04)
<b>PQ507</b>	Front Wheel Bearing Kit	Volvo S40 2.0T 4Dr. Sedan B4204 T2/T3, V40 2.0T Estate B4204S (97-98)
<b>PQ508</b>	Front Wheel Bearing Kit	Volvo C70 2.3 Cabrio, Coupe B5234 T3/ T9 (99-06), S70 2.3 T5 Cabrio, Coupe B5434T4, 2.4 Cabrio, Coupe B5254S, V70 2.3 T5 Estate B5434T4, 2.4, T Estate B5254S, 2.5T Estate (98-04), V70 2.4 XC Estate B5254S, XC70 2.5T Estate, XC90 2.9 T6 5/ 7 Seater Estate B6304 - 4X4 (00-06)
<b>PQ509</b>	Front Wheel Bearing Kit	Volvo C70 2.5T T5 (04-13), S60 2.0T Turbo B5204T5, 2.3 T5 B5234 T3, 2.4T B5244T3, 2.5T Turbo (01-09), S60 2.5R B5254 T4, 3.0 T6, V70 2.5T R B5254T - 4X4 (03-05), S80 2.4T TS D5244T, 2.5T D5252T, 2.9 TS Executive (02-06), V70 2.0T P80 Sedan, Estate B5204 T5, 2.4T, 2.5T P80 Sedan, Estate B5254T (04-08), XC70 2.5T P80 Estate B5254T, XC90 2.4 D5 5 & 7 Seater SUV D5244T, 2.5T 5 & 7 Seater SUV B5254T3 - 4X4 (04-08)
<b>PQ510</b>	Rear Wheel Bearing Kit	Volvo C70 2.5T T5 (04-13), S60 2.0T Turbo B5204T5, 2.3 T5 B5234 T3, 2.4T B5244T3, 2.5T Turbo (01-09), S60 2.5R B5254 T4, 3.0 T6, V70 2.5T R B5254T - 4X4 (03-05), S80 2.4T TS D5244T, 2.5T D5252T, 2.9 TS Executive (02-06), V70 2.0T P80 Sedan, Estate B5204 T5, 2.4T, 2.5T P80 Sedan, Estate B5254T (04-08), XC70 2.5T P80 Estate B5254T, XC90 2.4 D5 5 & 7 Seater SUV D5244T, 2.5T 5 & 7 Seater SUV B5254T3 - 4X4 (04-08)
<b>PQ513</b>	Front Wheel Bearing Kit	VW Sharan 1.8T MPV AJH, 1.9TDi MPV ASZ, 2.8 MPV AAA (99-08)

## BUYERS GUIDE - BEARING KITS

<b>PQ514</b>	Rear Wheel Bearing Kit	VW Sharan 1.8T MPV AJH, 1.9TDi MPV ASZ, 2.8 MPV AAA (99-08)
<b>PQ515</b>	Front Wheel Bearing Kit	Volvo 850 2.3 T-5S, R Sedan B5234 T2/ T4, 2.4 GLT Sedan B5254S (94-97)
<b>PQ516</b>	Rear Wheel Bearing Kit	Hyundai Sonata 2.0, Gti (94-96)
<b>PQ517</b>	Front Wheel Bearing Kit	Alfa Romeo 147 1.6 Progression, TS AR32104, 1.9 JTD, 2.0 Distinctive, Selespeed TS AR3231 (01-10), 156 2.0 Twin Spark Selespeed Sportswagon AR32301, 2.5 V6 AR32401, AR3240 Sportswagon (98-07)
<b>PQ519</b>	Front Wheel Bearing Kit	Hyundai Sonata Y3 2.0 G4CP, 2.5 V6 G6BV, 3.0 V6 G6AT (94-04)
<b>PQ521</b>	Rear Wheel Bearing Kit	Hyundai iX35 2.0 G4KD, 2.0 CRDi D4HA, 2.4 G4KE (2010-), Santa Fe' 2.4 SUV G4JS, 2.7 V6 SUV G6BA-G (01-05), Tucson JM 2.0 G4GC, 2.0 CRDi D4EA, 2.7i V6 G6BA-G (04-10), Kia Sportage JE 2.0 SUV G4GC, 2.0 CRDi SUV D4EA, 2.7 V6 SUV G6BA (04-10), Sportage SL 2.0 SUV G4NC, 2.0 CRDi D4HA, 2.4 G4KE - 4X4 (2010-)
<b>PQ522</b>	Rear Wheel Bearing Kit	Alfa Romeo 147 2.0 (96-06)
<b>PQ523</b>	Rear Wheel Bearing Kit	Alfa Romeo 147 2.0 (96-06), 164 3.0 (96-02)
<b>PQ524</b>	Front Wheel Bearing Kit	BMW 5 Series E39 523i 2.5 M52, 525i 2.5 M54, 528i 2.8 M52, 530i, d 3.0 M54/ M57, 540i 4.4 M62 (98-04), M5 V8 Coupe (99-03)
<b>PQ525</b>	Rear Wheel Bearing Kit	BMW 5 Series E39 523i 2.5 M52, 525i 2.5 M54, 528i 2.8 M52, 530i, d 3.0 M54/ M57, 540i 4.4 M62 (98-04), E60/61 520d 2.0 N47, 523i 2.5 N52 / N53, 525i 2.5 M54 / N52, 530i M54 / N52, 530d 3.0 M57 (04-10), M5 V8 Coupe (99-03)
<b>PQ526</b>	Front Wheel Bearing Kit	Chrysler Voyager 2.0 SE MPV, 2.4 SE MPV (97-04), Grand Voyager 2.5 SE MPV, 3.3 LE, LX, Ltd., SE MPV (96-04)
<b>PQ527</b>	Front Wheel Bearing Kit	BMW 3 Series E36 M3 Coupe 6 Cyl. (01-04), E46 330i, Ci, 3.0 M54 (98-05)
<b>PQ528</b>	Front Wheel Bearing Kit	Chevrolet Aveo 1.5 L, LS, LT, 1.6 LS (03-15), Spark 1.0 B110S1, 1.2 B12D1 (2010-)
<b>PQ529</b>	Rear Wheel Bearing Kit	Alfa Romeo GTV / Spider 2.0, 3.0 V6 (96-06)
<b>PQ530</b>	Front Wheel Bearing Kit	Chevrolet Optra 1.6 Ls F16D3, 1.8 Lt T18SED (04-11)
<b>PQ531</b>	Rear Wheel Bearing Kit	BMW 3 Series E36 M3 Coupe 6 Cyl. (01-04), E46 330i, Ci, 3.0 M54 (98-05), 7 Series E38 740i M60/62, 750iL M70 (95-03), 8 Series E31 850iL V12 M70 (91-94), X3 E83 2.5i SUV M54, E83LCi, 2.5si SUV N52N - 4X4 (04-07), X3 E83 2.0d SUV M47N2, E83LCi 3.0d, i SUV M57N2, 3.0si SUV N52N - 4X4 (05-10)
<b>PQ533</b>	Front Wheel Bearing Kit ASB	Opel Adam 1.0T Jam, Glam, Rocks B10XFT, 1.4 B14XER, A14XER, Adam S 1.4T B14NEH (2014-)
<b>PQ534</b>	Rear Wheel Bearing Kit	Daihatsu Charade 1.0 (03-11), Cuore 847cc ED10 (97-03)
<b>PQ535</b>	Front Wheel Bearing Kit	Peugeot 306 1.6 XT S/W TU5JP 2.0 Cabrio, XSi XU10J4R/ RS/, XU10J2/K (95-03)
<b>PQ536</b>	Rear Wheel Bearing Kit	Citroen Xsara 1.6 SX TU5JP, 1.8 Picasso Exclusive, EW7J4, 2.0 Picasso HDi, VTS, Exclusive, HDi Exclusive DW10/TD (03-08), Peugeot 306 1.6 XT S/W TU5JP 2.0 Cabrio, XSi XU10J4R/ RS/, XU10J2/K (95-03)
<b>PQ537</b>	Front Wheel Bearing Kit	Daihatsu Rocky 2.8 - 4X4 (97-99)
<b>PQ538</b>	Rear Wheel Bearing Kit	Daihatsu Rocky 2.8 - 4X4 (97-99)
<b>PQ542</b>	Front Wheel Bearing Kit	Peugeot 605 3.0 V6 SRi ZPJ/LZ (96-98)
<b>PQ546</b>	Front Wheel Bearing Kit	Alfa Romeo Giulietta 1.4 TB, Multiair, 940 A2.000, Progression 940 B7.000, 1.8 TBi Quadrifoglio 940 A1.000 (2011-)
<b>PQ547</b>	Rear Wheel Bearing Kit	Alfa Romeo Giulietta 1.4 TB, Multiair, 940 A2.000, Progression 940 B7.000, 1.8 TBi Quadrifoglio 940 A1.000 (2011-)
<b>PQ548</b>	Front Wheel Bearing Kit	Renault Espace 2.0 Authentique Expression, RXE, RXT MPV J7R, F4R, 3.0 L7X727, 3.0 Previl (96-08)
<b>PQ549</b>	Front Wheel Bearing Kit	Renault Espace 2.0 (99-02)
<b>PQ550</b>	Rear Wheel Bearing Kit	Renault Espace 2.0 Authentique Expression, RXE, RXT MPV J7R, F4R, 3.0 L7X727, 3.0 Previl (96-08)
<b>PQ551</b>	Front Wheel Bearing Kit	Iveco Turbo Daily 2.3 Turbo 35.10, 35.12 (1998-)
<b>PQ552</b>	Front Wheel Bearing Kit	Volvo 960 2.9 Sedan B6304 (94-97), S90 2.9 X44 B6304S, V90 2.9 X44 B6304S (97-00)
<b>PQ553</b>	Front Wheel Bearing Kit	Volvo 960 2.9 Sedan B6304 (94-97)
<b>PQ554</b>	Rear Wheel Bearing Kit	Volvo 960 2.9 Sedan B6304 (94-97)
<b>PQ555</b>	Front Wheel Bearing Kit	Alfa Romeo 156 2.0 Twin Spark Selespeed Sportswagon AR32301, 2.5 V6 AR32401, AR3240 Sportswagon (98-07)
<b>PQ556</b>	Rear Wheel Bearing Kit	Volvo S40 2.0T 4Dr. Sedan B4204 T2/T3, V40 2.0T Estate B4204S (97-04)
<b>PQ557</b>	Front Wheel Bearing Kit	Volvo 960 2.9 Sedan B6304 (94-97)



## BUYERS GUIDE - BEARING KITS

<b>PQ558</b>	Front & Rear Wheel Bearing Kit	Mercedes-Benz W140 S-Class S320 M104.990, S420 M119.971, S500 M119.980 (93-99), W163 ML230 5 Dr. SUV, M111.977, ML320 5 Dr. SUV, M112.942, ML430 5 Dr. SUV, M113.942 (98-06)
<b>PQ559</b>	Front & Rear Wheel Bearing Kit	Mercedes-Benz W168 A-Class A160, L Classic, Elegance M166.940, A190, L Elegance M167.690 (00-05)
<b>PQ560</b>	Front & Rear Wheel Bearing Kit	Alfa Romeo 159 1.8 Tbi, 1.9 JTS, 2.2 JTS, 2.4 JTDM Q-tronic, 3.2 Destinctive, V6 Q4, V6 Ti (05-13)
<b>PQ561</b>	Front Wheel Bearing Kit	Honda Prelude 1.8 EX ES/ET (84-87)
<b>PQ562</b>	Front Wheel Bearing Kit	Jeep Wrangler 4.0 (84-90)
<b>PQ563</b>	Rear Wheel Bearing Kit	Alfa Romeo 159 1.8 Tbi, 1.9 JTS, 2.2 JTS, 2.4 JTDM Q-tronic, 3.2 Destinctive, V6 Q4, V6 Ti (05-13)
<b>PQ564</b>	Front Wheel Bearing Kit	Daihatsu Feroza 1.6 F300HDE (98-99)
<b>PQ565</b>	Rear Wheel Bearing Kit	Daihatsu Feroza 1.6 F300HDE (98-99)
<b>PQ566</b>	Front Wheel Bearing Kit	Fiat Panda 1.1 Active, 187A1.000 (2006-), Seicento 1.1 S, Sporting 176B2.000 (01-03)
<b>PQ567</b>	Front Wheel Bearing Kit ASB	Fiat 500 1.2 169A4.000 (08-15), Panda 1.2 Dynamic 169A4.000, 188A4.000 (2006-), Seicento 1.1 S, Sporting 176B2.000 (01-03)
<b>PQ568</b>	Front Wheel Bearing Kit	Fiat Ulysse 2.0 MPV XU10 J2/Z (99-02)
<b>PQ569</b>	Rear Wheel Bearing Kit	Fiat Ulysse 2.0 MPV XU10 J2/Z (99-02)
<b>PQ570</b>	Rear Wheel Bearing Kit	Fiat Ulysse 2.0 MPV XU10 J2/Z (99-02)
<b>PQ571</b>	Rear Wheel Bearing Kit	Fiat Punto 1.4 Multiair (04-13), Grande Punto I 1.2 199A4.000, 1.3D JTD Dynamic, JTD Multijet 199A2.000, 199A3.000, 1.4, 1.9 Multijet 939A1.000 (06-10), Grande Punto II 1.2 199A4.000, 1.4 16V, 1.4, 1.4 T-Jet (08-12)
<b>PQ572L</b>	Front Wheel Hub Bearing Kit	Toyota Etios 1.5 xi/xs 5-door, 1.5 2NRFE (2012-)
<b>PQ572R</b>	Front Wheel Hub Bearing Kit	Toyota Etios 1.5 xi/xs 5-door, 1.5 2NRFE (2012-)
<b>PQ573</b>	Rear Wheel Hub Bearing Kit	Toyota Etios 1.5 xi/xs 5-door, 1.5 2NRFE (2012-)
<b>PQ574</b>	Rear Wheel Hub Bearing Kit	Chevrolet Optra 1.6 Ls F16D3, 1.8 Lt T18SED (04-11)
<b>PQ575</b>	Rear Wheel Hub Bearing Kit	Chevrolet Optra 1.6 Ls F16D3, 1.8 Lt T18SED (04-11)
<b>PQ576</b>	Front Wheel Bearing Kit	Citroen C4 1.6 VTR Coupe' TU5JP4, 1.6 Hdi DV6TED4, 2.0i VTS Coupe' EW10J4S (05-10), Dodge Caliber 1.8 SE, SXT, EBE, 2.0 TD, SXT, CVT, ECN, 2.4 RT, SXT, EDA (06-12), Jeep Compass 2.0 ECN, 2.0CRD ECD, ECE, 2.4 ED3, ERZ, Patriot 2.0CRD ECD, ECE, 2.4 ED (2007-), Mitsubishi ASX 2.0 4B11 (2011-), Lancer 1.5 4A91, 2.0 4B11, 2.0 EVO X AWD 4B11 T/C (2007-), Outlander 2.4 4B12 - 4X4 (07-14)
<b>PQ577</b>	Rear Wheel Hub Bearing Kit	Dodge Caliber 1.8 SE, SXT, EBE, 2.0 TD, SXT, CVT, ECN, 2.4 RT, SXT, EDA (06-12), Jeep Compass 2.0CRD (2007-), Mitsubishi ASX 2.0 4B11 (2011-), Lancer 1.5 4A91, 2.0 4B11, 2.0 EVO X AWD 4B11 T/C (2007-)
<b>PQ578</b>	Front Wheel Hub Bearing Kit	Dodge Journey 2.0 CRD, R/T, ECE, 2.4 SXT, ED3, 2.7 V6 R/T, SXT, EER, 3.6 V6 R/T, SXT, ERB (2008-)
<b>PQ579</b>	Front Wheel Bearing Kit	Honda Prelude 2.2 V-Tec, Si F22, A22 (91-98)
<b>PQ580</b>	Rear Wheel Bearing Kit	Honda Prelude 2.2 V-Tec, Si F22, A22 (91-98)
<b>PQ581</b>	Front Wheel Bearing Kit	Toyota Camry 2.2, 2.4i, 3.0 (01-06)
<b>PQ582</b>	Rear Wheel Bearing Kit	Kia Sephia 1.5i LS, RS 4 Dr. Sedan BFD (04-05), Shuma I 1.5i LS 4 Dr. Sedan BFD, 1.8i GS 5 Dr. H/back TBD (98-01), Spectra 1.6 Exec. A6 (01-03)
<b>PQ583</b>	Front Wheel Bearing Kit	Hyundai iX35 2.0 G4KD, 2.0 CRDi D4HA, 2.4 G4KE - 4X2, 4X4 (2010-), Sonata Y3 2.0 G4CP, 2.5 V6 G6BV, 3.0 V6 G6AT (01-04), 2.0 V6 [EF] (2001-), Tucson JM 2.0 G4GC, 2.0 CRDi D4EA, 2.7i V6 G6BA-G - 4X2, 4X4 (04-10), Kia Optima 2.4 G4KJ (12-14), Sportage JE 2.0 SUV G4GC, 2.0 CRDi SUV D4EA, 2.7 V6 SUV G6BA - 4X2, 4X4 (04-10), Sportage SL 2.0 SUV G4NC, 2.0 CRDi D4HA, 2.4 G4KE - 4X2, 4X4 (2010-)
<b>PQ584</b>	Rear Wheel Bearing Kit	Kia Sephia 1.5i LS, RS 4 Dr. Sedan BFD (04-05)
<b>PQ585</b>	Front Wheel Bearing Kit	Mercedes-Benz W140 S-Class S320 M104.990, S420 M119.971, S500 M119.980 (93-99)
<b>PQ586</b>	Rear Wheel Bearing Kit	Mercedes-Benz S320, S420, S500 (93-99)
<b>PQ587</b>	Rear Wheel Bearing Kit	Mercedes-Benz BM903/4 Sprinter 308D 2.2 OM 601 LA dies., 312D 2.2 OM602 LA dies., 313 2.2 LWB, SWB Bus, P/van OM611 LA Pet., 412D 2.8 OM612, 413CDi 2.2, 416CDi 2.2 (96-06)

## BUYERS GUIDE - BEARING KITS

<b>PQ588</b>	Front & Rear Wheel Bearing Kit	Mercedes-Benz Vito/Viano W638 113CDi, 115CDi, 116CDi, 120CDi, 122CDi (03-06)
<b>PQ589</b>	Front Wheel Bearing Kit	Alfa Romeo 147 1.6 Progression, TS AR32104, 1.9 JTD (01-10)
<b>PQ590</b>	Rear Wheel Bearing Kit	Alfa Romeo 147 1.6 Progression, TS AR32104, 1.9 JTD, 2.0 Destinctive, Selespeed TS AR3231 (01-10), 156 2.0 Twin Spark Selespeed Sportswagon AR32301, 2.5 V6 AR32401, AR3240 Sportswagon (98-07)
<b>PQ591</b>	Front Wheel Bearing Kit	Audi A6 2.7T (00-05)
<b>PQ592</b>	Rear Wheel Bearing Kit	Audi A6 2.7T Quattro AJK, ARE, BES (00-06)
<b>PQ593</b>	Front Wheel Bearing Kit ASB	Citroen Berlingo 1.4 P/van TU3JP Pet., 1.6 TU5JP4B, 1.6Hdi 90LS DV6TED4BU, DV6AUTED4, 1.9D LWB P/van XUD9A Dies. (03-15), C3 II 1.2i VTi EB2F, 1.4i Vti, 1.6i Vti, 1.6 Hdi, e-Hdi (2010-), C4 1.6 VTR Coupe' TU5JP4, 1.6 Hdi DV6TED4, 2.0i VTS Coupe' EW10J4S (05-10), C4 Aircross 1.6 VTi EP6C, 1.6 e-Hdi, 2.0i Aircross 4B11 (10-15), C5 2.0 SX, EW10J4S, 3.0 Exclusive A-T ES9J4S (01-05), DS3 1.2i VTi EB2F, 1.6 VTi EP6C, 1.6 e-Hdi 9HP (2010-), Peugeot 207 1.4i XL, XR, XR+, Urban, Active, 1.4 Hdi, 1.6i XS, GTi, CC Sport 1 & 2, HDi XS, Dynamic, VTi Dynamic, 1.6 Hdi (06-13), 208 1.0 Vti, 1.2 Vti, 1.6 VTi, Hdi, 1.6 Gti (2012-), 307 1.6 Estate, X-Line, XR, XT TU5JP4, HDi, X-Line HDi, XS HD EW10J4, 2.0 CC, CC 100/ 130/ 180, XS, S/W EW10J4 XS HDi DW10TD (01-08), 308 1.6i X-Line, XS, XT, CC, S/W, XS Hdi, 1.6 Vti, 2.0 Hdi, 308CC 1.6THP (2008-), 3008 1.6, 2.0 HDi (2010-), Partner 1.6 , Hdi, 1.9D, 2.0 HDI (03-10)
<b>PQ594</b>	Rear Wheel Bearing Kit	Citroen C5 2.0 SX, EW10J4S, 3.0 Exclusive A-T ES9J4S (01-05)
<b>PQ595L</b>	Rear Wheel Bearing Kit	Dodge Journey 2.0 CRD, R/T, ECE, 2.4 SXT, ED3, 2.7 V6 R/T, SXT, EER, 3.6 V6 R/T, SXT, ERB (2008-)
<b>PQ595R</b>	Rear Wheel Bearing Kit	Dodge Journey 2.0 CRD, R/T, ECE, 2.4 SXT, ED3, 2.7 V6 R/T, SXT, EER, 3.6 V6 R/T, SXT, ERB (2008-)
<b>PQ596</b>	Front Wheel Bearing Kit	Chevrolet Spark 0.8 L, LS, 1.0 LT, LS (03-10), Daewoo Matiz 800cc S, SE F8CV (99-03)
<b>PQ597</b>	Front Wheel Bearing Kit	Chevrolet Spark 0.8 L, LS, 1.0 LT, LS (03-10), Daewoo Matiz 800cc S, SE F8CV (99-03)
<b>PQ598</b>	Front Wheel Bearing Kit	Toyota Avensis 2.0i Advanced, 2.2 D4D Exclusive, 2.4i Exclusive (06-09), Corolla FWD F11 140i GLE, GLS, Sprinter 4ZZ-FE, KS1 160i GLE, GLS, GSX, Sprinter VVT-i 3ZZ-FE DOHC, GF2 180i GLE, GLS, GSX, Sprinter VVT-I 1ZZ-FE DOHC (02-08), Corolla Verso ZZE122 160i S, SX MPV, 180i SX, SX MMT, TX, TX MMT MPV 1ZZ-FE (04-09), Corolla FWD 2.0, 2.0D D-4D Advanced, Exclusive (07-14), Runx 140i RT, RS, Sport 4ZZ-FE, 160i RS, RT, RX, Sport 3ZZ-FE, 180i RSi, RX 1ZZ-FE (03-08)
<b>PQ599</b>	Rear Wheel Bearing Kit	Fiat Doblo 1.9 Cargo P/van 223A6.000 (03-06)
<b>PQ600</b>	Rear Wheel Bearing Kit	Fiat Doblo 1.9 Cargo P/van 223A6.000 (03-06)
<b>PQ602</b>	Front Wheel Bearing Kit	Opel Astra G 2.0 Coupe', CSX X20XEV, 2.2i Classic Exec. (99-05)
<b>PQ604</b>	Front Wheel Bearing Kit	Citroen C2 1.4 HDi, DV4TD, 1.4i VTR TU3JP, 1.6i VTS TU5JP4S (04-10), C3 1.4i HDi, DV4TED4, 1.6i Pluriel, Sensodrive, TU5JP4 (02-10), Peugeot 206 1.4 X-Line, XS-Line, XS-Line HDi, Popart, Popart+ TU3JP, 1.6 XS-Line, CC, SW XS, XT, XT Premium TU5JP4 (01-08)
<b>PQ605</b>	Rear Wheel Bearing Kit	Citroen C4 1.6 VTR Coupe' TU5JP4, 1.6 Hdi DV6TED4, 2.0i VTS Coupe' EW10J4S (05-10), Peugeot 207 1.4i XL, XR, XR+, Urban, Active, 1.4 Hdi, 1.6i XS, GTi, CC Sport 1 & 2, HDi XS, Dynamic, VTi Dynamic, 1.6 Hdi (06-13), 307 1.6 Estate, X-Line, XR, XT TU5JP4, HDi, X-Line HDi, XS HD EW10J4, 2.0 CC, CC 100/ 130/ 180, XS, S/W EW10J4 XS HDi DW10TD (01-04)
<b>PQ606</b>	Front Wheel Bearing Kit	Peugeot Boxer 2.5TD 1.8 Ton Delivery Van DJ5TED (98-01)
<b>PQ607</b>	Rear Wheel Bearing Kit	Peugeot Boxer 2.5TD 1.8 Ton Delivery Van DJ5TED (98-01)
<b>PQ608</b>	Rear Wheel Bearing Kit	Alfa Romeo 166 3.0 (99-04)
<b>PQ609</b>	Rear Wheel Bearing Kit	Daewoo Tacuma 1.6 SX, 2.0 CDX, CDX Plus (01-03)
<b>PQ610</b>	Front Wheel Bearing Kit	Peugeot Boxer 2.5TD 1.8 Ton Delivery Van DJ5TED (98-01)
<b>PQ611</b>	Front Wheel Bearing Kit	Peugeot Boxer 2.2Hdi P2ZDTE, 3.0Hdi F30DT, F1CE0481D, Boxer 350 2.8 8140.43S/ F28DTCR (01-08)
<b>PQ612</b>	Rear Wheel Bearing Kit ABS	Hyundai Sonata Y3 2.0 G4CP, 2.5 V6 G6BV, 3.0 V6 G6AT (94-04)
<b>PQ613</b>	USE PQ523	
<b>PQ614</b>	Rear Wheel Bearing Kit	Renault Kangoo 1.4 Express van E7J780, 1.5dCi Express van K9K700 (01-10), Laguna I 1.6 RT, RTE K4M720, 1.8 RN, RN Estate, Authentique, Expression F4P7 RT B568/-9F3P/-P6, 1.9dCi F9Q716, 2.0 RT, RT Estate, RXE, Expression K4M720/724, N7Q700 (96-07)
<b>PQ615</b>	Front Wheel Bearing Kit	Peugeot Boxer 350 2.8 8140.43S/F28DTCR 1.8 Ton (01-08)

## BUYERS GUIDE - BEARING KITS

<b>PQ616</b>	Rear Wheel Bearing Kit	Renault Laguna I 1.6 RT, RTE K4M720, 1.8 RN, RN Estate, Authentique, Expression F4P7 RT B568/-9F3P/-P6, 1.9dCi F9Q716, 2.0 RT, RT Estate, RXE, Expressio (96-07), 3.0 Privilege, RXT L7X731 L7X700 (96-02)
<b>PQ617</b>	Rear Wheel Bearing Kit	Volvo 850 2.3 T-5S, R Sedan B5234 T2/ T4, 2.4 GLT Sedan B5254S (94-97)
<b>PQ618</b>	Rear Wheel Bearing Kit	Volvo 960 2.9 Sedan B6304 (94-97), C70 2.3 Cabrio, Coupe B5234 T3/ T9 (99-06), S70 2.3 T5 Cabrio, Coupe B5434T4, 2.4 Cabrio, Coupe B5254S, V70 2.3 T5 Estate B5434T4, 2.4, T Estate B5254S, 2.5T Estate (97-04), S90 2.9 X44 B6304S, V90 2.9 X44 B6304S (97-00), V70 2.4 XC Estate B5254S, XC70 2.5T Estate, XC90 2.9 T6 5/ 7 Seater Estate B6304 - 4X4 (00-06)
<b>PQ619</b>	Rear Wheel Bearing Kit	Mercedes-Benz W168 A-Class A160, L Classic, Elegance M166.940, A190, L Elegance M167.690 (00-05)
<b>PQ620</b>	Rear Wheel Bearing Kit	Jeep Wrangler 4.0 (84-96)
<b>PQ621</b>	Front Wheel Bearing Kit	Nissan Livina 1.6 Acenta, +, Visia, X-Gear (07-15), Grand Livina 1.6 Acenta, + HR16DE (08-14), Tiida 1.6 Acenta, Visia, +, 1.8 Acenta (06-13)
<b>PQ622</b>	Front Wheel Bearing Kit ASB	Nissan Almera 1.5 HR15DE (2013-), Micra (K12/13) 1.2 HR12DE, 1.4 Accenta, Accenta+, Accenta Sport, Visia, Comfort, Elegance, SE CR14PE, 1.5 dCi Tekna, Acenta HR15DE (2004-), Micra (K14) 0.9 K9K (2018-), NP200 1.5DCi S, SE P/up, 1.6, S, SE P/up (2008-), Opel Corsa D 1.3CDTi Enjoy, 1.4i Essentia, Enjoy, Cosmo, Sport, 1.6i Sport, OPC (08-15), Renault Captur 0.9 Tce H4B400 (2016-), Clio, II 1.2 Authentique, Expression, Generation, Va Va Voom D4F706, 1.4 Alaise, Privilege, Expression, RT, Va Va Voom K4J7/ EJ634 (99-09), 1.5 DCi Expression, K9K700/-702, 1.6 Expression, Dynamique, Privilege, Sport K4M744/ -745/-748 (99-04), 2.0 Sport F4R, 3.0 V6 Sport F7R (01-09), Clio III 1.4 Expression, Extreme, 1.6 Expression, Dynamique, Extreme K4M 748 (06-10), Clio IV 0.9T, 1.2 (2013-), Kangoo 1.4 Multix Authentique MPV E7J780, 1.5DCi (03-10), 1.6 (11-13), Logan 1.6 Expression (2009-), Megane II 1.4 Authentique, Dynamique E7J626/-50, 1.5dCi Authentique, Shake it! K9K722, 1.6 Classic Privilege, Expression, Dynamique, Authentique, Shake it! CC Dynamique K4M701, K4M760/ -1 (2006-), 2.0 Classic Dynamique, Dynamique + , Privilege, CC Privilege, GT F7R710 /-77 (02-10), Modus 1.2 Authentique D4F706, 1.4 Dynamique, Expressio K4J770, 1.6 Expression K4M761-11 (05-08), Sandero 1.4 Authentique, 1.6 Cup, Dynamique, Expression, Pack (09-15), Scenic II 1.6 Authentique, Expression, Joie de Vivre K4M761/782 (2006-), 2.0 Dynamique, Privilege, Navigator MPV F4R770/771 (02-10), Twingo 1.2 Dynamique, D4F772 (08-13)
<b>PQ623</b>	Rear Wheel Bearing Kit	Citroen Berlingo 1.4 P/van TU3JP Pet., 1.6 TU5JP4B, 1.6HDi 90LS DV6TED4BU, DV6AUTED4, 1.9D LWB P/van XUD9A Dies. (03-15), Peugeot Partner 1.9D (03-10)
<b>PQ624</b>	Rear Wheel Bearing Kit	Citroen Berlingo 1.4 P/van TU3JP Pet., 1.6 TU5JP4B, 1.6HDi 90LS DV6TED4BU, DV6AUTED4, 1.9D LWB P/van XUD9A Dies. (03-15), Picasso 1.6, 1.6HDi, 1.8, 2.0, 2.0HDi (03-06), Xsara 1.6 SX TU5JP, 1.8 Picasso Exclusive, EW7J4, 2.0 Picasso HDi, VTS, Exclusive, HDi Exclusive DW10/TD (03-08)
<b>PQ625</b>	Front Wheel Bearing Kit	Nissan Primstar 1.9 DCi Minibus (07-11), Opel Vivaro 1.9CDTi P/Van, 2.0i P/van (06-15), Renault Megane II 2.0T Sport, F1 Team R26 LE, SE, Coupe Dynamique (02-10)
<b>PQ626</b>	Front Wheel Bearing Kit	Nissan Interstar 2.5DCi SR, HR P/Van (2006-)
<b>PQ627</b>	Front Wheel Bearing Kit	Toyota Condor 2.4i Estate, TX Estate 2RZ-E, 3.0 Estate, TX Estate 5L - 4X4 (00-05)
<b>PQ628</b>	Rear Wheel Bearing Kit	Toyota Condor 1.6 Estate, TE, 5L, 1.8 2Y, 2.0i Estate, TE, 1RZ Pet., 2.4i Estate, TE, TX 2RZ-E, 3.0D Estate, TE, 5L Dies. - 4X2, 2.4i Estate, TX Estate 2RZ-E, 3.0 Estate, TX Estate 5L - 4X4 (00-05)
<b>PQ629</b>	Rear Wheel Bearing Kit	Nissan Maxima CA33 & QX Series 2.0 VQ20E (96-04)
<b>PQ630</b>	Front Wheel Hub Bearing Kit	Nissan Murano 3.5 V6 SUV - 4X2, 4X4 (2005-)
<b>PQ631</b>	Front Wheel Hub Bearing Kit	Nissan Juke 1.2 DIG-T HRA20DDT, 1.5 dCi K9K, 1.6 HR16DE, 1.6 DIG-T MR16DDT - 4X2, 4X4 (2010-), Qashqai 1.5DCi, 1.6 Visia, Acenta, 2.0 DCi Acenta SUV, Pet. (2007-), 2.0 Acenta, n-tec, 2.0 DCi Tekna SUV - 4X4 (2007-), 1.5DCi K9K282, K9K292, 1.5DCi K9K636, K9K646, 1.6 HR16DE, 2.0 DCi M1D, M9R, MR20DE (2007-), X-Trail T31 2.0 D, Dci - 4X2, 4X4 (08-14), Renault Koleos 2.5 Dynamique SUV, 2.0dCi Dynamique Premium SUV, 2.5 Dynamique, Premium CVT SUV - 4X4 (2009-)
<b>PQ632</b>	Front Wheel Bearing Kit	Nissan Navara & Pathfinder D40/ R51 2.5DCi D/Cab P/up, 3.0DCi V6, 4.0i V6, LE D/Cab P/up - 4X4 (05-17)
<b>PQ633</b>	Front Wheel Bearing Kit	Fiat Punto 1.2 Dynamic 188A5000, 1.4 Multiair 16V (04-14), Grande Punto I 1.2 199A4.000, 1.4, 1.9 Multijet 939A1.000 (06-10), Grande Punto II 1.2 199A4.000, 1.4 16V, 1.4 T-Jet (08-12), Opel Adam 1.0T B10XFT, 1.4 B14XER, A14XER (2014-), Corsa D 1.4 Essentia, Enjoy, Cosmo, Sport (08-15), Corsa E 1.0 T B10XFT, F10XFT, 1.4 T B14XEL (2015-)
<b>PQ634</b>	Front Wheel Bearing Kit ASB	Citroen C1 1.0 1KR, 1.0i Furio, Play 1KR (06-15), Peugeot 107 1.0 XR, XR+, X-Line (06-16), Toyota Aygo 1.0 Fresh, Inferno, Wild 3/5-door, X-Cite, X-Play 1KR (2011-)
<b>PQ635</b>	Front Wheel Bearing Kit	Renault Laguna II 1.8 Authentique, Expression, 1.9dCi, Dynamic, 2.0T Dynamic, Expression, 3.0 Privilege, Initial (01-09)



## BUYERS GUIDE - BEARING KITS

<b>PQ636</b>	USE PQ631	
<b>PQ637</b>	Front Wheel Bearing Kit	Renault Logan 1.6 Expression (2009-), Sandero 1.4 Authentique, 1.6 Cup,Dynamique, Expression, Pack (09-15)
<b>PQ639</b>	Rear Wheel Bearing Kit	Nissan Primera 160 Si, SE SR16DE (98-02)
<b>PQ640</b>	Rear Wheel Bearing Kit	Nissan Almera 1.8 Elegance, Luxury 18DE (01-06), Primera 200 GSi, Si , STi, Elegance, Luxury SR20DE (98-02)
<b>PQ641</b>	Front Wheel Bearing Kit	Mitsubishi Lancer 1.6 GLX 4G18, 2.0 GLS 4G63 (03-08), Nissan Almera 1.6 Comfort, Elegance, Luxury 16DE/GA16DE, 1.8 Elegance, Luxury 18DE (01-06)
<b>PQ642</b>	Rear Wheel Bearing Kit	Kia Clarus 2.0 GLX 4 Dr. Sedan FE (98-01), Mazda 626 2.0 S/W, Sedan FE (98-03), Astina 180 Se Hatch Bpi (95-00)
<b>PQ643</b>	Rear Wheel Bearing Kit	Toyota Rav4 II ZCA20 1.8 SUV 1ZZFE - 4X2, 4X4 (02-06)
<b>PQ644</b>	Rear Wheel Hub Bearing Kit	Toyota Rav4 II ACA20 2.0 SUV 1AZ-FE - 4X4 (02-06)
<b>PQ645</b>	Rear Wheel Bearing Kit	Mitsubishi Colt LDV 2.8D LWB Std., Hi line P/up Dies., 2.8TDi LWB Club CabS cab,Turbo, 3.0i V6 LWB Club S/cab P/up Pet. (94-98), Colt LDV 2.0 LWB Std. P/up, 2.0i LWB Hi-Line, 2.4i LWB Hi-Line Rodeo S-/D/cab, Hi-Line/Rider P/up Pet., 2.5D 4D56 Dies. (98-09), Colt LDV 2.4i LWB Hi-Line D/cab, Trailbuster S/cab, P/up Pet. - 4X4 (98-09)
<b>PQ646</b>	Rear Wheel Bearing Kit	Mitsubishi Colt LDV 2.8D LWB Std., Hi line P/up Dies. (94-98), 2.4i LWB Hi-Line D/cab, Trailbuster S/cab, P/up Pet., 3.0i V6 LWB Rodeo D/cab P/up Pet. - 4X4 (98-09), Triton 2.4 MPI D/cab P/up 2.5 Di-D C/cab P/up, 2.5 Di-D D/cab P/up, 3.2 Di-D D/cab P/up, 3.5 Club cab P/up, 3.5 MPI Double cab P/up - 4X2, 4X4 (2007-)
<b>PQ647</b>	Rear Wheel Bearing Kit	Mitsubishi Colt LDV 2.8TDi LWB Pioneer, Rodeo D/cab P/up Turbo Dies., 3.0i V6 LWB Rodeo D/cab P/up Pet. (99-06), 2.8D, TDi LWB Club cab,Trailbuster S/cab, Rodeo /cab P/ up Dies./ Turbo Dies. - 4X4 (99-06)
<b>PQ648</b>	USE PQ190	
<b>PQ649</b>	Rear Wheel Bearing Kit	Toyota Fortuner 3.0 D-4D SUV 1KD-FTV, 4.0 V6, Epic SUV 1GR-FE - 4X2, 4X4 (06-09), Hilux RZN169 2.7i LWB D/cab, DLX S/cab, Raider S/D/cab, SRX D/cab, Legend 35 LWB P/ up 3RZFE Pet, LN167 3.0D D/cab D-E, DLX, S/D/cab DE, Raider DE, Legend35 LWB P/ up 5L Dies., 3.0iD LWB Raider S/cab & KZ-TE D/cab P/up, Legend35 - 4X4 (98-05), Hilux "VIGO" 2.0i U16/17 S/Cab, S, SRX LWB Pet. P/up 1TR-FE Pet., 2.5TDi D-4D S/Cab, S, SRX, S/Cab, S/Cab SRX HO, Raised Body Raider, D/Cab LWB 2KD-FTV, 3.0 D-4D TDi Raider, D/C Raider, Raised Body LWB P/up 1KD-FTV Dies., 4.0i D/Cab Raider Raised Body LWB P/up GR-FE Pet. - 4X2, 4X4 (05-09), 2.7i S/Cab Raider, D/Cab Raider, S/Cab HO Raised Body LWB P/up 2TR-FE Pet. - 4X2 (05-11), 2.5TDi D-4D S/Cab, D/Cab SRX, Legend40 2KD-FTV Dies. LWB P/up, 2.7i S/Cab SRX, Legend40 2TR-FE Pet. LWB P/up - 4X4 (05-15)
<b>PQ649ABS</b>	Rear Wheel Bearing Kit	Toyota Hilux RZN169 2.7i LWB D/cab, DLX S/cab, Raider S/D/cab, SRX D/cab, Legend 35 LWB P/up 3RZFE Pet, LN167 3.0D D/cab D-E, DLX, S/D/cab DE, Raider DE, Legend35 LWB P/up 5L Dies., 3.0iD LWB Raider S/cab & KZ-TE D/cab P/up, Legend35 - 4X4 (98-05), Hilux "VIGO" 2.0i U16/17 S/Cab, S, SRX LWB Pet. P/up 1TR-FE Pet., 2.5TDi D-4D S/Cab, S, SRX, S/Cab, S/Cab SRX HO, Raised Body Raider, D/Cab LWB 2KD-FTV, 3.0 D-4D TDi Raider, D/C Raider, Raised Body LWB P/up 1KD-FTV Dies., 4.0i D/Cab Raider Raised Body LWB P/up GR-FE Pet. - 4X2, 4X4 (05-09), 2.7i S/Cab Raider, D/Cab Raider, S/Cab HO Raised Body LWB P/up 2TR-FE Pet. - 4X2 (05-11), 2.5TDi D-4D S/Cab, D/Cab SRX, Legend40 2KD-FTV Dies. LWB P/up, 2.7i S/Cab SRX, Legend40 2TR-FE Pet. LWB P/up - 4X4 (05-15)
<b>PQ649N</b>	Rear Wheel Bearing Kit	Toyota Hi Lux 3.0D, Id, Hi Lux "Vigo" 2.0i, 2.5Tdi, 2.7i, 3.0 D-4D, 4.0, I - 4X2, 4X4
<b>PQ650</b>	Rear Wheel Bearing Kit	Toyota Corolla FWD F11 140i GLE, GLS, Sprinter 4ZZ-FE, KS1 160i GLE, GLS, GSX, Sprinter VVT-i 3ZZ-FE DOHC, GF2 180i GLE, GLS, GSX, Sprinter VVT-I 1ZZ-FE DOHC (02-08), Runx 140i RT, RS, Sport 4ZZ-FE, 160i RS, RT, RX, Sport 3ZZ-FE, 180i RSi, RX 1ZZ-FE (03-08)
<b>PQ651</b>	Front Wheel Bearing Kit	Suzuki Jimny 1.3i SUV M13A, 1.5 K15B - 4X4 (2014-)
<b>PQ652</b>	Rear Wheel Bearing Kit	Kia Shuma I 1.5i LS 4 Dr. Sedan BFD, 1.8i GS 5 Dr. H/back TBD (98-01), Spectra 1.6 Exec. A6 (01-03)
<b>PQ653</b>	Front Wheel Bearing Kit ASB	Suzuki Swift 1.5i GL, GLS M15A, 1.5 RS415, 1.6 RS416 (08-11), 1.2 GA, GL K12M, 1.2 AZG12, 1.4 GL, GLS, SE K14B, 1.4 AZG/AZH, 1.6, i M16A (11-18)
<b>PQ654</b>	Rear Wheel Hub Bearing Kit	Kia Carens 1.8 LS 5 Dr. MPV TBD In-Line (00-03)
<b>PQ655</b>	Front Wheel Bearing Kit	Kia Carnival 2.5 K55, KRV6, 2.9 CRDi J3 (00-04)
<b>PQ656</b>	Rear Wheel Bearing Kit	Kia Carnival 2.5 K55, KRV6, 2.9 CRDi J3 (00-04)
<b>PQ657</b>	Rear Wheel Bearing Kit	Toyota Camry II 2.0 (01-06)

## BUYERS GUIDE - BEARING KITS

<b>PQ658</b>	Rear Wheel Bearing Kit	Toyota Land Cruiser FZJ105 4.5 Std., GX, Turbo P/up, S/W 1FZ-FE Dies., Turbo Dies. - 4X4 (95-98), HZJ105 4.2 Std., GX DSL, Turbo P/up, S/W 1HZ Dies., Turbo Dies. - 4X4 (98-06)
<b>PQ659</b>	Front Wheel Bearing Kit ABS	Suzuki Swift 1.2 GA, GL K12M, 1.2 AZG12, 1.4 GL, GLS, SE K14B, 1.4 AZG/AZH, 1.6, i M16A (11-18), SX4 1.6 GL, GLX, MA16A, 2.0i Hatch J2OA, J2OB - 4X2, 4X4 (2008-)
<b>PQ660</b>	Front Wheel Bearing Kit	Toyota Auris 1.3, 1.4i RS, RT, 1.6i RS, RT, 1.8i RS, RX (2007-), Corolla FWD 1.3i Impact, Professional, Advanced, 1.4i, 1.6i Professional, Advanced, 1.8i (2007-), Corolla Verso 1.6, 1.8, 2.0 D-4D (09-14), Corolla Quest FWD 1.6 Auto, Plus (2014-), Rav4 III 2.0i 1AZ-FE GX, VX, Fierce SUV, 2.2i D-4D 2AD-FTV GX, VX SUV - 4X4 (06-13)
<b>PQ661</b>	Front Wheel Bearing Kit	Toyota Auris 2.0Di D-4D RS, RX (2007-), Corolla FWD 2.0, 2.0D D-4D Advanced, Exclusive (07-14), Corolla Verso 1.6, 1.8, 2.0 D-4D (09-14), Rav4 III 2.0i 1AZ-FE GX, VX, Fierce SUV, 2.2i D-4D 2AD-FTV GX, VX SUV - 4X4 (06-13), RAV4 IV 2.0, 2.2D 2AD-FTV, 2.5 2AR-FE - 4X2, 4X4 (2013-)
<b>PQ663</b>	Front Wheel Bearing Kit ASB	Toyota FJ Cruiser 4.0 V6 - 4X4 (2011-), Fortuner 3.0 D-4D SUV 1KD-FTV, 4.0 V6, Epic SUV, 1GR-FE Pet. - 4X2, 4X4 (06-11), 2.4GD Raised Body 2GD-FTV, 2.7 VVTi Raised Body 2TR-FE, 2.8GD Raised Body 1GD-FTV - 4X2, 2.8GD DSi Raised Body 1GD-FTV, 3.0D-4D 1KD-FTV, 4.0 V6 1GR-FE - 4X4 (2015-), Hilux "Vigo" 4X2 2.5TDi D-4D S/Cab, S, SRX, S/Cab, S/Cab SRX HO, Raised Body Raider, D/Cab LWB 2KD-FT, 3.0 D-4D TDi Raider, D/C Raider, Raised Body LWB P/up 1KD-FTV Dies., 4.0i D/Cab Raider Raised Body LWB P/up GR-FE Pet. - 4X2, 3.0 D-4D TDi D/C Raider 1KD-FTV Dies., LWB P/up, 4.0 D/Cab Raider 1GR-FE Pet. LWB P/up - 4X4 (05-09), 2.7i S/Cab Raider, D/Cab Raider, S/Cab HO Raised Body LWB P/up 2TR-FE Pet. - 4X2 (05-11), 2.5TDi D-4D S/Cab, D/Cab SRX, Legend40 2KD-FTV Dies. LWB P/up, 2.7i S/Cab SRX, Legend40 2TR-FE Pet. LWB P/up - 4X4 (05-15), 3.0D-4D TDi D/C xtra cab, Raider, Legend40 1KD-FTV Dies. LWB, 4.0 D/Cab Raider, 1GR-FE Pet. - 4X4 (2009-), 2.5TDi D-4D S/Cab, S, SRX, S/Cab, S/Cab SRX HO, Raised Body Raider, D/Cab LWB P/up 2KD-FTV, 2.7i Raised Body Raider, D/Cab LWB P/up 2TR-FE Pet., 3.0D-4D TDi D/C Raised Body Raider, Xtra cab, Legend40 LWB P/up KD-FTV Dies., 4.0i D/C Raised Body Raider, Legend40 LWB P/up 1GR-FE Pet. (09-16), Hilux "REVO" 2.0 VVTi 1TR-FE, 2.4 GD-6 Raised Body 2GD-FTV, 2.7 VVTi Raised Body 2TR-FE, 2.8 GD-6 Raised Body 1GD-FTV, 4.0 V6 Raised Body 1GR-FE - 4X2, 2.4 GD-6 2GD-FTV, 2.8 GD-6 Raised Body 1GD-FTV, 4.0 V6 Raised Body 1GR-FE - 4X4 (2016-), Land Cruiser Prado 120 3.0D 1KZ-TE VX S/W, 4.0 1GR-FE GX, VX S/W - 4X4 (02-10), Prado 150 3.0TDi 1KD-FTV, 4.0 V6 VVTi 1GR-FE - 4X4 (2009-)
<b>PQ664</b>	Front & Rear Wheel Bearing Kit	Audi A3 2.0 FSi BVZ, 2.0 FSi 8PA Sportback BLX, 2.0 TFSi CCZA, CBFA, 2.0 TDi BMM, CLJA, 3.2 Quattro, DSG, BUB (03-13), 1.4 TFSi CMSA, 1.6 TDi CAYC, 1.8 TFSi CDAA, 1.9 TDi BXE (08-13), 1.2 TFSi CJZJ, CJZA, 1.4 TFSi CXSA, 1.6 TDi CLHA, 1.8 TFSi Quattro CJSA, CJSB, 2.0 TDi DBGA (12-17), S3 2.0 TFSi CJXB (13-17), VW Caddy 1.6i Life Van, MPV BGU, 1.9TDi Life, Maxi Van, MPV BJB, 2.0SDi Van, P/van BDJ, 2.0TDi (2004-), Golf V 2.0i Comfortline, GTi, GTi Trendline DSG/ AXX/BWA, 2.0FSi Sport, Sport Tiptronic AXW, 2.0TDi, Sport DSG/ BKD (04-09), Golf VI 1.4TSi Comfortline, Trendline, Highline, 1.6i Comfortline, Trendline, 1.6TDi, 2.0i GTi, Tiptronic, 2.0TSi 4Motion, 2.0TDi Highline, DSG (09-13), Golf VII 1.2TSi, 1.4TSi, 2.0TDi (2013-), Scirocco 1.4TSi, 2.0TSi, DSG, 2.0TSi R (2009-), Tiguan 1.4TSi Trend&Fun 5Dr. SUV, 2.0TSi, 2.0TDi - 4X2 (08-17)
<b>PQ665</b>	Rear Wheel Bearing Kit	Toyota Land Cruiser 4.0, 4.2, 4.5 (90-06)
<b>PQ666</b>	Rear Wheel Bearing Kit	Toyota Land Cruiser 4.0, 4.2, 4.5 (90-06)
<b>PQ667</b>	Rear Wheel Bearing Kit	Toyota Land Cruiser 4.0, 4.2, 4.5 (90-06)
<b>PQ668</b>	Rear Wheel Bearing Kit	Toyota Land Cruiser 4.0, 4.2, 4.5 (90-06)
<b>PQ669</b>	Rear Wheel Bearing Kit	Toyota Land Cruiser 4.0, 4.2, 4.5 (90-06)
<b>PQ670</b>	Rear Wheel Bearing Kit	Toyota Land Cruiser 4.2, 4.5 (97-06)
<b>PQ671</b>	Rear Wheel Bearing Kit	Toyota Land Cruiser 3.0, 3.4, 4.2, 4.5 (95-06)
<b>PQ672</b>	Rear Wheel Bearing Kit	Toyota Land Cruiser 4.5 (98-06)
<b>PQ673</b>	Rear Wheel Bearing Kit	Toyota Land Cruiser 4.5 (98-06)
<b>PQ674</b>	Front Wheel Bearing Kit	Honda Accord VII 2.0i V-Tec, 2.4i V-Tec (03-08), Civic VIII 2.0i VTEC Type R, K20Z4 (07-13)
<b>PQ675</b>	Front Wheel Bearing Kit	Toyota Land Cruiser FZJ105 4.5 V8 VX, Turbo P/up, S/W 2UZ-FE Pet. - 4X4 (98-06)
<b>PQ676</b>	Front Wheel Bearing Kit	Hyundai Elantra XD 2.0 G4GC, CRDi D4EA (02-07), HD 1.6 GLS, 2.0 GLS, G4GC (07-11), Matrix 1.6 GLS G4ED, 1.8 G4GB-G (02-08), Tiburon 2.0 G4DF (2002-), Kia Cerato 1.6 LX G4FC, 2.0 CRDi (04-08)
<b>PQ677</b>	Rear Wheel Bearing Kit	Opel Astra G 1.6 CS, Classic CD, CDE, Comfort C16SEL, 1.8 Classic CDE, Caravan CD S/W, Elegance, Irmscher X18XE1 (99-06), Corsa C 140i Classic, Comfort, Chill, Classic Essentia, Hatch Club, Sport, Lite Sport, S14NE, 160i Classic, Classic Elegance, Classic CD, CDE, Sport, 16SE (03-08), Meriva 1.3 CDTi Enjoy, 1.4 Essentia, Enjoy, 1.6 Club, Comfort, Enjoy MPV Z16SE/-XE, 1.7 CDTi Enjoy, Elegance, 1.8 Elegance MPV Easytronic (03-09), Zafira I 1.8i CD, Enjoy, Elegance MPV Z18XE/-1 (01-05)



## BUYERS GUIDE - BEARING KITS

<b>PQ678</b>	Front Wheel Bearing Kit	Opel Astra G 1.6 CS, Classic CD, CDE, Comfort C16SEL, 1.8 Classic CDE, Caravan CD S/W, Elegance, Irmischer X18XE1 (99-06), Zafira I 1.8i CD, Enjoy, Elegance MPV Z18XE/-1 (01-05)
<b>PQ679</b>	Front Wheel Bearing Kit	Chevrolet Utility 1.3D, 1.4 Pet., 1.8 Pet. (11-15), Opel Corsa C 140i Classic, Comfort, Chill, Classic Essentia, Hatch Club, Sport, Lite Sport, S14NE, 160i Classic, Classic Elegance, Classic CD, CDE, Sport, 16SE, 1.7TDi Sport, Classic, CDTi Enjoy, Hatch CDTi Elegance, Classic DTi Elegance X17D, 1.8i GSi Hatch, Classic (03-08), Corsa LDV II 1.4i Utility, Club Sport, S P/up 14XE, 1.7DTi Utility Club, Sport P/up, 1.8i Utility Club, Sport P/up (03-10), Corsa P/van 1.4i (2006-), Meriva 1.3 CDTi Enjoy, 1.4 Essentia, Enjoy, 1.6 Club, Comfort, Enjoy MPV Z16SE/-XE, 1.7 CDTi Enjoy, Elegance, 1.8 Elegance MPV Easytronic (03-09)
<b>PQ680</b>	Front Wheel Bearing Kit	Kia K2700I 2.7D 2.7D Workhorse LWB Dies."Bakkie" D/S (2004-)
<b>PQ681</b>	Rear Wheel Bearing Kit	Chana Star 1.0 P/up, 1.3 P/up (06-12)
<b>PQ682</b>	Front Wheel Bearing Kit	Honda Civic VIII 1.8i VTEC EXi, LXi, VXi, R18A2 (07-13), Civic IX 1.8i VTEC R18Z4 (2012-)
<b>PQ683</b>	Front Wheel Bearing Kit	Honda Civic VIII 2.2CTDi Vxi (07-13), CR-V 2.0 K2OA4 - 4X4 (09-12), FR-V 1.8i R18A1 (07-10)
<b>PQ684</b>	Rear Wheel Bearing Kit	Audi A3 1.8 8L1 AGN, 1.8T AGU, BPU (98-04), A4 1.8T Avant, Multitronic, BFB, B6 AVJ 8E2, 1.9 TDi AVF, Avant B6, 8E5, 8E2 (00-08), VW Beetle 1.8T Coupe APH, 2.0i Cabriolet, Highline AZJ (00-12), Golf IV 1.6i Comfortline, Std., Estate AKL, 1.8, T GTi, Highline AGU/AGN, 1.9 TDi Highline, Estate AHF, 2.0i Cabrio, Highline APK (99-04), Jetta IV 1.6i Comfortline, Std. AKL, 1.8T Highline, Exec AGU, 1.9 TDi Highline AHF, 2.0i Highline APK, 2.3 V5 AGZ (99-06)
<b>PQ686</b>	Front Wheel Bearing Kit	Kia Carens 2.0 CVVT, 2.0 CRDi (2008-)
<b>PQ688</b>	Front & Rear Wheel Bearing Kit	Audi A1 1.0 TFSi CHZB, 1.2 TFSi CBZA, 1.4 TFSi CAXA/CAVG, 1.6 TDi CAYC, 1.8 TFSi DAJB (11-18), A3 2.0 FSi BVZ, 2.0 FSi 8PA Sportback BLX, 2.0 TFSi CCZA, CBFA, 2.0 TDi BMM, CLJA, 3.2 Quattro, DSG, BUB (03-13), 1.4 TFSi CMSA, 1.6 TDi CAYC, 1.8 TFSi CDAA, 1.9 TDi BXE (08-13), A4 2.0 Multitronic Avant 8EC, 8E2 ALT, 2.0 TDi 125, 8EC BLB, Avant Multitronic, 2.0TFSi DTM 147 BGB, 3.2 FSi Quattro, 8EC Multitronic Avant, Tiptronic Avant, AUK (00-08), S3 2.0TFSi CDLC (07-13), TT 2.0 TFSi BWA, 2.0 TTS Quattro CDLA, CDMA, 3.2 Coupe, Roadster DSG, BHE, BUB (04-10), 1.8 TFSi CDAA, 2.0 TFSi Quattro CCSA, CETA, 2.5 RS Quattro CEPA (10-15), Q3 2.0 TDi CFFB, CLJA, 2.0 TDi Quattro CFGC, CLLB, 2.0 TFSi Quattro CCZC, CPSA (12-15), Seat Altea 2.0FSi Tiptronic, 2.0TDi Man., DSG Auto (06-09), VW Beetle 1.2 Tsi, 1.4 Tsi (2012-), Caddy 1.6i Life Van, MPV BGU, 1.9TDi Life, Maxi Van, MPV BJB, 2.0SDi Van, P/van BDJ, 2.0TDi (2004-), CC 2.0TSi, 2.0TDi, 3.6 V6 FSi 4Motion (2009-), EOS 1.4 Tsi, 2.0 FSi, TSi, TFSi (07-12), Golf V 1.6i Comfortline, Tiptronic, Trendline BGU, 1.9TDi Comfortline, Highline (04-09), Golf VI 1.4TSi Comfortline, Trendline, Highline, 1.6i Comfortline, Trendline, 1.6TDi, 2.0i GTi, Tiptronic, 2.0TSi 4Motion, 2.0TDi Highline, DSG (09-13), Jetta V 1.4TSi, 1.6TDi, 1.6i Comfortline, Tiptronic, Trendline, 1.9TDi Comfortline, Comfortline DSG, 2.0i Trendline, Comfortline, 2.0FSi Sportline, 2.0 T FSi Sportline DSG, 2.0TDi Sportline (2006-), Jetta VI 1.2TSi, 1.4TSi, 1.6TDi, 2.0TDi (2011-), Passat B7 1.8TSi, 2.0TSi, 2.0TDi (08-11), Scirocco 1.4TSi, 2.0TSi, DSG, 2.0TSi R (2009-), Tiguan 1.4TSi Trend&Fun 5Dr. SUV, 2.0TDi, 2.0TSi Track&Field, Sport&Style Man., Tiptronic 5Dr. SUV, 2.0TDi Track&Field, Sport&Style Man., Tiptronic 5Dr. SUV - 4X2, 4X4 (08-17), Touran 1.9TDi TrendLine DSG MPV, 2.0FSi HighLine MPV AXW, 2.0TDi HighLine, DSG MPV (04-11), 1.2TSi, 1.4TSi, 2.0TDi (2011-)
<b>PQ689</b>	Rear Wheel Bearing Kit	Audi A3 2.0 FSi BVZ, 2.0 FSi 8PA Sportback BLX, 2.0 TFSi CCZA, CBFA, 2.0 TDi BMM, CLJA, 3.2 Quattro, DSG, BUB (03-13), 1.8 TFSi CDAA, 1.9 TDi BXE (08-13), A4 3.2 FSi Quattro, 8EC Multitronic Avant, Tiptronic Avant, AUK (01-08), TT 2.0 TFSi BWA, 2.0 TTS Quattro CDLA, CDMA, 3.2 Coupe, Roadster DSG, BHE, BUB (04-10), 1.8 TFSi CDAA, 2.5 RS Quattro CEPA (10-15), Q3 2.0 TDi CFFB, CLJA, 2.0 TDi Quattro CFGC, CLLB, 2.0 TFSi Quattro CCZC, CPSA (12-15), VW Beetle 1.2 Tsi, 1.4 Tsi (2012-), Caddy 1.6i Life Van, MPV BGU, 1.9TDi Life, Maxi Van, MPV BJB, 2.0SDi Van, P/van BDJ, 2.0TDi (2004-), CC 2.0TSi, 2.0TDi, 3.6 V6 FSi 4Motion (2009-), EOS 1.4 Tsi, 2.0 FSi, TSi, TFSi (07-12), Golf V 1.6i Comfortline, Tiptronic, Trendline BGU, 1.9TDi Comfortline, Highline, 2.0i Comfortline, GTi, GTi Trendline DSG/ AXX/BWA, 2.0FSi Sport, Sport Tiptronic AXW, 2.0TDi, Sport DSG/ BKD (04-09), Golf VI 1.4TSi Comfortline, Trendline, Highline, 1.6i Comfortline, Trendline, 1.6TDi, 2.0i GTi, Tiptronic, 2.0TSi 4Motion, 2.0TDi Highline, DSG (09-13), Jetta V 1.4TSi, 1.6TDi, 1.6i Comfortline, Tiptronic, Trendline, 1.9TDi Comfortline, Comfortline DSG, 2.0i Trendline, Comfortline, 2.0FSi Sportline, 2.0 T FSi Sportline DSG, 2.0TDi Sportline (2006-), Jetta VI 1.2TSi, 1.4TSi, 1.6TDi, 2.0TDi (2011-)
<b>PQ689... Continued</b>	Rear Wheel Bearing Kit	Passat B7 1.8TSi, 2.0TSi, 2.0TDi (08-11), Scirocco 1.4TSi, 2.0TSi, DSG, 2.0TSi R (2009-), Tiguan 1.4TSi Trend&Fun 5Dr. SUV, 2.0TSi, 2.0TDi - 4X2 (08-17), Touran 1.9TDi TrendLine DSG MPV, 2.0FSi HighLine MPV AXW, 2.0TDi HighLine, DSG MPV (04-11), 1.2TSi, 1.4TSi, 2.0TDi (2011-)

## BUYERS GUIDE - BEARING KITS

<b>PQ690</b>	Front Wheel Bearing Kit	Mercedes-Benz W169 A-Class A170 M266.940, A180 M266.940, A180 CDi OM640.940, A200 M266.960 (05-13), W245 B-Class B170, B180, B200 CDI, Turbo (05-12)
<b>PQ691</b>	Rear Wheel Bearing Kit	Audi A3 2.0 FSi BVZ, 2.0 FSi 8PA Sportback BLX, 2.0 TFSi CCZA, CBFA, 2.0 TDi BMM, CLJA, 3.2 Quattro, DSG, BUB (03-13), 1.4 TFSi CMSA, 1.6 TDi CAYC, 1.8 TFSi CDAA, 1.9 TDi BXE (08-13), 1.2 TFSi CJZJ, CJZA, 1.4 TFSi CXSA, 1.6 TDi CLHA, 1.8 TFSi Quattro CJSJ, CJSB, 2.0 TDi DBGA (12-17), 1.4 TFSi CZCA, CZEA, 2.0TDi CRFC (13-17), A4 2.0 Multitronic Avant 8EC, 8E2 ALT, 2.0 TDi 125, 8EC BLB, Avant Multitronic, 2.0TFSi DTM 147 BGB (00-08), TT 2.0 TFSi BWA, 2.0 TTS Quattro CDLA, CDMA (06-10), Seat Altea 2.0FSi Tiptronic, 2.0TDi Man., DSG Auto (06-09), VW Beetle 1.2 Tsi, 1.4 Tsi (2012-), Caddy 1.6i Life Van, MPV BGV, 1.9TDi Life, Maxi Van, MPV BJB, 2.0SDi Van, P/van BDJ, 2.0TDi (2004-), Golf V 1.6i Comfortline, Tiptronic, Trendline BGV, 1.9TDi Comfortline, Highline, 2.0i Comfortline, GTi, GTi Trendline DSG/ AX/BWA, 2.0FSi Sport, Sport Tiptronic AXW, 2.0TDi, Sport DSG/ BKD (04-09), Golf VI 1.4TSi Comfortline, Trendline, Highline, 1.6i Comfortline, Trendline, 1.6TDi, 2.0i GTi, Tiptronic, 2.0TSi 4Motion, 2.0TDi Highline, DSG (09-13), Golf VII 1.2TSi, 1.4TSi, 2.0 GTi, 2.0TDi (2013-), Jetta V 1.4TSi, 1.6TDi, 1.6i Comfortline, Tiptronic, Trendline, 1.9TDi Comfortline, Comfortline DSG, 2.0i Trendline, Comfortline, 2.0FSi Sportline, 2.0 T FSi Sportline DSG, 2.0TDi Sportline (2006-), Jetta VI 1.2TSi, 1.4TSi, 1.6TDi, 2.0TDi (2011-), Scirocco 1.4TSi, 2.0TSi, DSG, 2.0TSi R (2009-), Tiguan 1.4TSi Trend&Fun 5Dr. SUV, 2.0TSi, 2.0TDi - 4X2 (08-17)
<b>PQ692</b>	Front Wheel Bearing Kit	Chrysler Neon 1.8 PL, 2.0 PL, 2.0i R/T (02-06), PT-Cruiser 2.0 ECC Pet., 2.2 CRD, EDJ Dies., 2.4 ED2 Pet. (02-09)
<b>PQ693</b>	Front & Rear Wheel Bearing Kit	Audi A4 1.8T Avant, Multitronic, BFB, B6 AVJ 8E2, 1.9 TDi AVF, Avant B6, 8E5, 8E2, 3.2 FSi Quattro, 8EC Multitronic Avant, Tiptronic Avant, AUK (00-08), 2.4 Multitronic, BDV, 2.5 TDi 8D/E2 Quattro AFB, Quattro Tiptronic, 2.6 8D2 / 8D5 Exec., 3.0 Quattro Tiptronic, ASN, 3.0 Cabriolet ASN, 8H7, 3.0 TDi 8EC Quattro BKN, 3.0 TDi Quattro Avant Tiptronic, BKN, ASB (02-08), 1.8 TFSi CABB, CDHB, CJEB, CDHA, CABA, 2.0 T, 2.0 TFSi CAEB, CDNC, GLC, CMGB, 2.0 TDi BRD, CAGA, CJCA, CMEA, CMFA (08-14), 3.2 Fsi, 3.2 FSi Quattro AUK, CALA (06-12), A6 2.8 Quattro 4A, AAH, ACK, 3.0 Quattro Tiptronic BBJ (94-00), 2.7T Quattro AJK, ARE, BES (00-06), 4.2 Quattro Tiptronic ARS (00-08), 2.4 BDV (02-05), 2.5 TDi BCZ, BDG, BFC (03-04), VW Passat IV 2.3 V5 AZX (03-05), Passat V 1.9TDi Comfortline AVB, 2.0FSi Comfortline, Tipt., Highline BCR BLY, 2.0 T FSi Sportline Tiptronic AXX/BPY, 2.0TDi Highline, DSG BKP/BMP, 3.2 V6 Auto. DSG (05-11)
<b>PQ694</b>	Front & Rear Wheel Hub Bearing Kit	Audi A4 3.2 FSi Quattro, 8EC Multitronic Avant, Tiptronic Avant, AUK (01-08), 1.8 TFSi CABB, CDHB, CJEB, CDHA, CABA, 2.0 T, 2.0 TFSi CAEB, CDNC, GLC, CMGB, 2.0 TDi BRD, CAGA, CJCA, CMEA, CMFA, 2.0 TFSi Quattro CPMA, CDNC, 2.0 TDi Quattro CGLC, 3.0 TDi Quattro CAPA, CCLA, CCWA, CDUC, CKVB, CKVC (08-14), 3.2 Fsi, 3.2 FSi Quattro AUK, CALA (06-12), A5 2.0 TFSi, Tdi, 2.0 TFSi Quattro, 3.0 TDi Quattro, 3.2 FSi Quattro (08-14), A6 2.0 TDi CGLC, CMGB, 2.0 TFSi CDNB (11-15), 3.0 TDi CLAB, 3.0 TDi Quattro CDUC, CDUD, CKVB, CKVC, 3.0 TFSi Quattro CGWB, CGWD, CGXB, CTUA (11-14), Q5 2.0 TDi CAHA, CGLB, CMGA, CGLC, CMGB, 2.0 TDi, TFSi Quattro, 2.0 TFSi CDNB, CNCB, CNCD, CAEB, CPME, 3.0 TDi Quattro, 3.2 FSi Quattro CALB, CPNB (09-14)
<b>PQ695</b>	Rear Wheel Hub Bearing Kit	Audi A4 1.8 TFSi CABB, CDHB, CJEB, CDHA, CABA, 2.0 T, 2.0 TFSi CAEB, CDNC, GLC, CMGB, 2.0 TDi BRD, CAGA, CJCA, CMEA, CMFA (08-14), A5 2.0 TFSi, Tdi, 2.0 TFSi Quattro, 3.0 TDi Quattro, 3.2 FSi Quattro (08-14), A6 2.0 TDi CGLC, CMGB, 2.0 TFSi CDNB (11-15), 3.0 TDi CLAB, 3.0 TDi Quattro CDUC, CDUD, CKVB, CKVC, 3.0 TFSi Quattro CGWB, CGWD, CGXB, CTUA (11-14)
<b>PQ696</b>	Rear Wheel Hub Bearing Kit	Chrysler Neon 1.8 PL, 2.0 PL, 2.0i R/T (02-06), PT-Cruiser 2.0 ECC Pet., 2.2 CRD, EDJ Dies., 2.4 ED2 Pet. (02-09)
<b>PQ697</b>	Rear Wheel Hub Bearing ASB	Hyundai Accent MC 1.6 G4ED (06-11), RB 1.6 G4FC (2011-), i20 PB/PBT 1.2 G4LA, 1.4 G4FA, 1.6 G4FC (2009-), Kia Picanto 1.2 G4LA, Rio III 1.2 CVVT G4LA, 1.4 G4FA (2011-)
<b>PQ698</b>	Rear Wheel Bearing Kit	Nissan Almera 1.6 Comfort, Elegance, Luxury 16DE/GA16DE, 1.8 Elegance, Luxury 18DE (01-06)
<b>PQ699</b>	Rear Wheel Bearing Kit	Nissan Almera 1.6 Comfort, Elegance, Luxury 16DE/GA16DE, 1.8 Elegance, Luxury 18DE (01-06)
<b>PQ700</b>	Front Wheel Bearing Kit	Tata Safari 2.2 CRDi GLS Dies. (2007-), Super Ace 1.4TD (2012-), Telcoline 2.0 Turbo Dies. S/Cab P/up (04-10), Xenon 2.0TDi, 3.0TDi (2008-)

## BUYERS GUIDE - BEARING KITS

<b>PQ701</b>	Front Wheel Bearing Kit	Audi A1 1.0 TFSi CHZB, 1.2 TFSi CBZA, 1.4 TFSi CAXA/CAVG, 1.6 TDi CAYC, 1.8 TFSi DAJB (11-18), Seat Ibiza 1.4 Sport, BXW, 1.6 Sport, BAH, 1.8T Cupra, BBU, 1.9TDi 96, 118 Cupra, 2.0 AZL, BBX, BPX, BLK, ASZ, BLT (06-09), Leon 2.0 Fsi, 2.0T, FSi Cupra, 2.0T Fsi, 2.0TDi (06-09), VW Polo 9N 1.4TDi, Classic, Trendline AMF, 1.4TDi Classic, Trendline ARC, 1.4i Trendline, Comfortline, AUA/ BBY, BLM, 1.6i Comfortline, SE, Classic Comfortline, Tipt Trendline, Classic Lux BTS/ AFV, BAH, 1.8T GTi, Classic Trendline AKK (02-10), Polo 9N 1.9TDi Highline, Classic Highline, Sportline, ATD/ AXR, 2.0i Highline, Classic Highline BBX (02-10), Cross Polo 1.6TDi, 1.9TDi (07-10), Polo Vivo 1.4 CLPA, CLPB, 1.6 CLSA (2010-), Polo 6R 1.2TDi CFWA, 1.4 CLSA, CLPB, 1.4TSi GTi CTHE, 1.6 CLSA (10-15), 1.6TDi (09-15), Polo 1.2 Trendline DSG Petrol CBZB (2011-), 1.2 Man. CGPA/ CGPB (10-15), 1.2TSi Comfortline Man. CBZC (2013-), Polo 6C 1.0TSi CHZB, CHYA, CHYB, 1.2TSi CJZC/ CJZD, 1.4 CDDA/ CGGB/ CLPA, 1.4TDi CUTA/ CYZB, 1.5TDi CWXC, CWXB, 1.6TDi CLSA, 1.8TSi GTi DAJA (2014-), Polo GP 1.0TSi Comfortline CHZC TSi R Line DSG CHZC (2016-), Polo "VIVO" GT 1.0 TSi CHZC (2018-)
<b>PQ702</b>	Rear Wheel Bearing Kit	Audi A1 1.0 TFSi CHZB, 1.2 TFSi CBZA, 1.4 TFSi CAXA/CAVG, 1.6 TDi CAYC, 1.8 TFSi DAJB (11-18), Seat Ibiza 1.4 Sport, BXW, 1.6 Sport, BAH, 1.8T Cupra, BBU, 1.9TDi 96, 118 Cupra, 2.0 AZL, BBX, BPX, BLK, ASZ, BLT (06-09), Leon 2.0 Fsi, 2.0T, FSi Cupra, 2.0T Fsi, 2.0TDi (06-09), VW Polo 9N 1.4TDi, Classic, Trendline AMF, 1.4TDi Classic, Trendline ARC, 1.4i Trendline, Comfortline, AUA/ BBY, BLM, 1.6i Comfortline, SE, Classic Comfortline, Tipt Trendline, Classic Lux BTS/ AFV, BAH, 1.8T GTi, Classic Trendline AKK (02-10), Polo 9N 1.9TDi Highline, Classic Highline, Sportline, ATD/ AXR, 2.0i Highline, Classic Highline BBX (02-10), Cross Polo 1.6TDi, 1.9TDi (07-10), Polo Vivo 1.4 CLPA, CLPB, 1.6 CLSA (2010-), Polo 6R 1.2TDi CFWA, 1.4 CLSA, CLPB, 1.4TSi GTi CTHE, 1.6 CLSA (10-15), 1.6TDi (09-15), Polo 1.2 Trendline DSG Petrol CBZB (2011-), 1.2 Man. CGPA/ CGPB (10-15), 1.2TSi Comfortline Man. CBZC (2013-), Polo 6C 1.0TSi CHZB, CHYA, CHYB, 1.2TSi CJZC/ CJZD, 1.4 CDDA/ CGGB/ CLPA, 1.4TDi CUTA/ CYZB, 1.5TDi CWXC, CWXB, 1.6TDi CLSA, 1.8TSi GTi DAJA (2014-), Polo GP 1.0TSi Comfortline CHZC TSi R Line DSG CHZC (2016-), Polo "VIVO" GT 1.0 TSi CHZC (2018-)
<b>PQ703</b>	Rear Wheel Bearing Kit	Toyota Corolla FWD F11 140i GLE, GLS, Sprinter 4ZZ-FE, KS1 160i GLE, GLS, GSX, Sprinter VVT-i 3ZZ-FE DOHC, GF2 180i GLE, GLS, GSX, Sprinter VVT-i 1ZZ-FE DOHC (02-08), Runx 140i RT, RS, Sport 4ZZ-FE, 160i RS, RT, RX, Sport 3ZZ-FE, 180i RSi, RX 1ZZ-FE (03-08)
<b>PQ704</b>	Rear Wheel Bearing Kit	VW Caddy 1.6i Club, Citi, P/up HM Pet. (97-03)
<b>PQ705</b>	Front & Rear Wheel Bearing Kit	VW Kombi T5 1.9TDi Beach, Van, P/van, S/Cab P/up SWB, D/Cab P/up LWB, Crew Bus AXC Dies., 2.5TDi Beach, California, Caravelle, 96/128, S/Cab, D/cab, HO P/up SWB/ LWB P/up, Crew Bus P/van, Van, AXD Dies., 3.2 Caravelle, S/Cab, D/cab P/up BDL (04-10), 2.0TDi, 2.0 BITDi (2010-), Touareg 2.5TDi R5 SUV BAC/ BPE, 5.0TDi SUV AYH - 4X4 (04-11)
<b>PQ707</b>	Rear Wheel Bearing Kit	VW Kombi T5 1.9TDi Beach, Van, P/van, S/Cab P/up SWB, D/Cab P/up LWB, Crew Bus AXC Dies., 2.5TDi Beach, California, Caravelle, 96/128, S/Cab, D/cab, HO P/up SWB/ LWB P/up, Crew Bus P/van, Van, AXD Dies., 3.2 Caravelle, S/Cab, D/cab P/up BDL (04-10)
<b>PQ708</b>	Front & Rear Wheel Bearing Kit	Audi Q7 3.0 TDi BUG, CJGD, CLZB, CRCA, CASA, CCMA, CJGA, CNRB, 3.0 TDi, TFSi Quattro, 3.0 TFSi CJTB, CJWB, CNA, CTWA, 3.6 FSi Quattro BHK, 4.2 FSi, TDi Quattro BAR, CCFA, CCFC, BTR, 6.0 TDi Quattro (06-15), Touareg 3.0TDi SUV BKS, 3.6 FSi SUV BHK/ BHL, 4.2 FSi SUV AXQ, 5.0TDi SUV AYH - 4X4 (04-11)
<b>PQ709</b>	Front Wheel Bearing Kit	Tata Safari 2.2 CRDi GLX Dies. - 4X4 (2007-), Telcoline 2.0 Turbo Diesel S/Cab, D/cab P/up - 4X4 (04-10)
<b>PQ710</b>	USE PQ727	
<b>PQ711</b>	Rear Wheel Bearing Kit	Opel Corsa C 140i Classic, Comfort, Chill, Classic Essentia, Hatch Club, Sport, Lite Sport, S14NE, 160i Classic, Classic Elegance, Classic CD, CDE, Sport, 16SE, 1.7TDi Sport, Classic, CDTi Enjoy, Hatch CDTi Elegance, Classic DTi Elegance X17D, 1.8i GSi Hatch, Classic (03-08), Corsa LDV II 1.4i Utility, Club Sport, S P/up 14XE, 1.7DTi Utility Club, Sport P/up, 1.8i Utility Club, Sport P/up (03-10)
<b>PQ712</b>	Rear Wheel Bearing Kit	Renault Clio I, II 1.2 Authentique, Expression, Generation, Va Va Voom D4F706, 1.4 Alaise, Privilege, Expression, RT, Va Va Voom K4J7/EJ634 (99-09), 1.5 DCi Expression., K9K700/-702, 1.6 Expression, Dynamique, Privilege, Sport K4M744/-745/-748 (99-04), 2.0 Sport F4R, 3.0 V6 Sport F7R (01-09), Clio III 1.4 Expression, Extreme, 1.5 DCi Expression., K9K770. 1.6 Expression, Dynamique, Extreme K4M 748, 2.0 (06-10), 2.0 Sport, R27, Ltd. Edition F4R832/830 (07-14), Megane II 1.4 Authentique, Dynamique E7J626/-50, 1.5dCi Authentique, Shake it! K9K722, 1.6 Classic Privilege, Expression, Dynamique, Authentique, Shake it! CC Dynamique K4M701, K4M760/ -1, 2.0T Sport, F1 Team R26 LE, SE, Coupe Dynamique (02-10), Modus 1.2 Authentique D4F706, 1.4 Dynamique, Expressio K4J770, 1.6 Expression K4M761-11 (05-08), Scenic II 1.6 Authentique, Expression, Joie de Vivre K4M761/782, Grand Scenic 1.6, 1.9dCi Dynamic, Privilege MPV F9Q740, 2.0 Expression MPV 4FR740/-1, 1.9dCi Dynamique, Expression, Navigator MPV F9Q812, 2.0 Dynamique, Privilege, Navigator MPV F4R770/771 (02-10), Twingo 1.2 Dynamique, D4F772, 1.6 RS K4M854 (08-12)



## BUYERS GUIDE - BEARING KITS

<b>PQ713</b>	Rear Wheel Bearing Kit	Nissan Almera 1.5 HR15DE, Datsun Go/ Go+ 1.2 HR12DE (2013-), Micra (K12/13) 1.2 HR12DE, 1.4 Accenta, Accenta+, Accenta Sport, Visia, Comfort, Elegance, SE CR14PE, 1.5 dCi Tekna, Acenta HR15DE (2004-), Micra (K14) 0.9 K9K (2018-), Renault Megane II 1.5dCi Authentique, Shake it! K9K722, 1.6 Classic Privilege, Expression, Dynamique, Authentique, Shake it! CC Dynamique K4M701, K4M760/ -1, 1.9dCi CC, Dynamique, Privilege, Dynamic + F9Q800, 2.0 Classic Dynamique, Dynamique + , Privilege, CC Privilege, GT F7R710 /-77, 2.0T Sport, F1 Team R26 LE, SE, Coupe Dynamique (02-10), Megane III 1.2 GT-LINE Turbo, 1.4Tce, 1.6, Dci, 2.0 RB7, RS 250, RS 265 (2010-), Scenic II 1.6 Authentique, Expression, Joie de Vivre K4M761/782, Grand Scenic 1.6, 1.9dCi Dynamic, Privilege MPV F9Q740, 2.0 Expression MPV 4FR740/-1, 1.9dCi Dynamique, Expression, Navigator MPV F9Q812, 2.0 Dynamique, Privilege, Navigator MPV F4R770/771 (02-10)
<b>PQ714</b>	Front Wheel Bearing Kit	Chevrolet Aveo 1.5 L, LS, LT, 1.6 LS (03-15), Sonic 1.3D, 1.4 Pet. Hatch / Sedan, 1.6 Pet. Hatch / Sedan (11-15), Opel Meriva 1.4T (12-15), Mokka 1.4T A14NET, B14NET (15-16)
<b>PQ715</b>	Front Wheel Bearing Kit	Toyota Yaris 1.0 T1, 1.3 T3, +, Spirit , T3 Spirit - Saloon & Hatch 2NZ-FE, 1.8 TS Hatch (05-10), 1.0, 1.3 ZEN3, 1.5 Hybrid (10-18)
<b>PQ716</b>	Rear Wheel Hub Bearing Kit ASB	Hyundai Sonata Y3 2.0 G4CP, 2.5 V6 G6BV, 3.0 V6 G6AT (94-04)
<b>PQ717</b>	Front Wheel Bearing Kit	Chrysler Neon 1.8 PL, 2.0 PL, 2.0i R/T (02-06)
<b>PQ718</b>	USE PQ696	
<b>PQ719</b>	Rear Wheel Bearing Kit	Toyota Yaris 1.0 T1, 1.3 T3, +, Spirit , T3 Spirit - Saloon & Hatch 2NZ-FE, 1.8 TS Hatch (05-10), 1.0, 1.3 ZEN3, 1.5 Hybrid (10-18)
<b>PQ720</b>	Rear Wheel Bearing Kit	Renault Clio IV 0.9T, 1.2 (2013-), Kangoo 1.4 Express van E7J780, 1.5dCi Express van K9K700 (01-10), 1.4 Multix Authentique MPV E7J780, 1.5DCi (03-10), Logan 1.6 Expression (2009-), Sandero 1.4 Authentique, 1.6 Cup,Dynamique, Expression, Pack (09-15)
<b>PQ721</b>	USE PQ310	
<b>PQ722</b>	Rear Wheel Bearing Kit ASB	Citroen C2 1.4 HDi, DV4TD, 1.4i VTR TU3JP, 1.6i VTS TU5JP4S (04-10), C3 1.4i HDi, DV4TED4, 1.6i Pluriel, Sensodrive, TU5JP4 (02-10), Peugeot 1007 1.6 MPV TU5JP4 (05-08), 206 1.4 X-Line, XS-Line, XS-Line HDi, Popart, Popart+ TU3JP, 1.6 XS-Line, CC, SW XS, XT, XT Premium TU5JP4, 2.0 CC, GTi, 180 EW10J4, XT HDi DW10TD (01-08)
<b>PQ723</b>	Front Wheel Bearing Kit	Ford Focus II 1.6 Si, Ambiente, Trend., 2.0 Si, Trend., TDCi Ghia, TDCi Si., 2.5 ST. HYDA (05-09), Volvo V50 1.8, 2.0D B5244S, 2.0i, 2.4 D5, 2.4i B5244S, 2.5i T5 B5254T - All models available in Manual or Geartronic (04-12)
<b>PQ724</b>	USE PQ723	
<b>PQ725</b>	Rear Wheel Bearing Kit	Ford Focus II 1.6 Si, Ambiente, Trend., 2.0 Si, Trend., TDCi Ghia, TDCi Si., 2.5 ST. HYDA (05-09), Volvo C30 1.6 Man., 1.8 Man., 2.0, R-Design, Powershift Man., Geartronic, 2.5i T5, R-Design Man., Geartronic (08-13), S40 1.8 Sedan, 2.0 Sedan, 2.0D VS Sedan D4204T, 2.4 VS D5 Sedan D5252 T16/ D5244 T3, 2.4i B5244S4, 2.5i D5 Sedan Man Geartronic (2004-), Volvo V50 1.8, 2.0D B5244S, 2.0i, 2.4 D5, 2.4i B5244S, 2.5i T5 B5254T - All models available in Manual or Geartronic (04-12)
<b>PQ726</b>	Rear Wheel Bearing Kit	Volvo V70 2.5T R B5254T - 4X4 (03-06), XC70 2.5T P80 Estate B5254T, XC90 2.4 D5 5 & 7 Seater SUV D5244T, 2.5T 5 & 7 Seater SUV B5254T3 - 4X4 (04-08), XC90 2.4 D5 D5244T4/5 (04-11), 2.9 T6 B6294T (03-06), 4.4 V8 B8444S - 4X4 (06-11)
<b>PQ727</b>	Front Wheel Bearing Kit	Renault Captur 1.2 Tce H5F408, 1.5 Dci K9K (2016-), Clio I, II 1.2 Authentique, Expression, Generation, Va Va Voom D4F706, 1.4 Alaise, Privilege, Expression, RT, Va Va Voom K4J7/EJ634, 1.5 DCi Expression., K9K700/-702, 1.6 Expression, Dynamique, Privilege, Sport K4M744/ -745/-748, 2.0 Sport F4R, 3.0 V6 Sport F7R (04-09), Clio III 1.4 Expression, Extreme, 1.5 DCi Expression., K9K770, 1.6 Expression, Dynamique, Extreme K4M 748 (06-10), 2.0 Sport, R27, Ltd. Edition F4R832/830 (07-10), Megane II 1.5dCi Authentique, Shake it! K9K722, 1.6 Classic Privilege, Expression, Dynamique, Authentique, Shake it! CC Dynamique K4M701, K4M760/ -1, 1.9dCi CC, Dynamique, Privilege, Dynamic + F9Q800, 2.0T Sport, F1 Team R26 LE, SE, Coupe Dynamique (02-10), Scenic II 1.6 Authentique, Expression, Joie de Vivre K4M761/782, Grand Scenic 1.6, 1.9dCi Dynamic, Privilege MPV F9Q740, 2.0 Expression MPV 4FR740/-1, 1.9dCi Dynamique, Expression, Navigator MPV F9Q812 (02-10), Twingo 1.6 RS K4M854 (08-13)
<b>PQ728</b>	Front Wheel Bearing Kit	Toyota Quantum 2.5 D-4D, "Family", S-long MPV, Van 2KD-FTV Dies., 2.7 "Family", S-long "Ses'fikile" MPV, Van 2TR-FE Pet. (2005-)
<b>PQ728COMP</b>	Front Wheel Bearing Kit Comp	Toyota Quantum 2.5 D-4D, "Family", S-long MPV, Van 2KD-FTV Dies., 2.7 "Family", S-long "Ses'fikile" MPV, Van 2TR-FE Pet. (2005-)(Complete With Abs Ring And Hube)
<b>PQ729</b>	Bearing Kit Cont Brg. & Seal	Toyota Quantum 2.5 D-4D, "Family", S-long MPV, Van 2KD-FTV Dies., 2.7 "Family", S-long "Ses'fikile" MPV, Van 2TR-FE Pet. (2005-)
<b>PQ729A</b>	Bearing Kit Cont. Hub, No Seals	Toyota Quantum 2.5 D-4D, "Family", S-long MPV, Van 2KD-FTV Dies., 2.7 "Family", S-long "Ses'fikile" MPV, Van 2TR-FE Pet. (2005-)

## BUYERS GUIDE - BEARING KITS

<b>PQ729ABS</b>	Bearing Kit Cont Brg. & Seal	Toyota Quantum 2.5 D-4D, "Family", S-long MPV, Van 2KD-FTV Dies., 2.7 "Family", S-long "Ses'fikile" MPV, Van 2TR-FE Pet. (2005-)
<b>PQ729B</b>	Brg & Housing	Toyota Quantum 2.5l Mpv, Bus, P/Van, 2.7l Mpv, Bus, P/Van (2005-)
<b>PQ730</b>	Front Wheel Bearing Kit	Opel Astra H 1.4 Essentia, Z14XEP, 1.6 Classic Club, Elegance, Enjoy, Essentia, Sport Z16XEP, 1.8 Enjoy, GTC, GTC Sport, Twintop, Enjoy, Z18XER, 1.9 CDTi Enjoy, GTC, CDTi, GTC CDTi Sport, 2.0 Coupe' Turbo, GSi, GTC Turbo, GTC Turbo OPC, GTC Turbo Sport, Turbo Sport, Twin top (04-10), Zafira II 1.6 Essentia MPV, 1.8i Enjoy, Elegance MPV Z18XE/-1, 1.9CDTi Elegance, 2.0i Turbo OPC, 2.2i Enjoy, Elegance MPV Z22SE (05-09)
<b>PQ731</b>	Front Wheel Bearing Kit	Opel Astra H 1.4 Essentia, Z14XEP, 1.6 Classic Club, Elegance, Enjoy, Essentia, Sport Z16XEP, 1.8 Enjoy, GTC, GTC Sport, Twintop, Enjoy, Z18XER, 1.9 CDTi Enjoy, GTC, CDTi, GTC CDTi Sport, 2.0 Coupe' Turbo, GSi, GTC Turbo, GTC Turbo OPC, GTC Turbo Sport, Turbo Sport, Twin top (04-10), Zafira II 1.6 Essentia MPV, 1.8i Enjoy, Elegance MPV Z18XE/-1, 1.9CDTi Elegance, 2.0i Turbo OPC, 2.2i Enjoy, Elegance MPV Z22SE (05-09)
<b>PQ732</b>	Rear Wheel Bearing Kit	Chevrolet Utility 1.3D, 1.4 Pet., 1.8 Pet. (11-15), Opel Astra H 1.4 Essentia, Z14XEP, 1.6 Classic Club, Elegance, Enjoy, Essentia, Sport Z16XEP, 1.8 Enjoy, GTC, GTC Sport, Twintop, Enjoy, Z18XER, 1.9 CDTi Enjoy, GTC, CDTi, GTC CDTi Sport, 2.0 Coupe' Turbo, GSi, GTC Turbo, GTC Turbo OPC, GTC Turbo Sport, Turbo Sport, Twin top (04-10), Zafira II 1.6 Essentia MPV, 1.8i Enjoy, Elegance MPV Z18XE/-1, 1.9CDTi Elegance, 2.0i Turbo OPC, 2.2i Enjoy, Elegance MPV Z22SE (05-09)
<b>PQ733</b>	Rear Wheel Bearing Kit	Opel Astra H 1.4 Essentia, Z14XEP, 1.6 Classic Club, Elegance, Enjoy, Essentia, Sport Z16XEP, 1.8 Enjoy, GTC, GTC Sport, Twintop, Enjoy, Z18XER, 1.9 CDTi Enjoy, GTC, CDTi, GTC CDTi Sport, 2.0 Coupe' Turbo, GSi, GTC Turbo, GTC Turbo OPC, GTC Turbo Sport, Turbo Sport, Twin top (04-10), Meriva 1.4T (12-15), Zafira II 1.6 Essentia MPV, 1.8i Enjoy, Elegance MPV Z18XE/-1, 1.9CDTi Elegance, 2.0i Turbo OPC, 2.2i Enjoy, Elegance MPV Z22SE (05-09)
<b>PQ734</b>	Front Wheel Bearing Kit	Tata Indica / Vista 1.4 LEi, LSi, LX, Lxi, 1.4TDi DLX, DLS, Indigo 1.4 GLS S/W, 1.4TDi DLX S/W (2005-)
<b>PQ735</b>	Rear Wheel Bearing Kit	Tata Indica / Vista 1.4 LEi, LSi, LX, Lxi, 1.4TDi DLX, DLS, Indigo 1.4 GLS S/W, 1.4TDi DLX S/W (2005-)
<b>PQ736</b>	Rear Wheel Bearing Kit	Audi A4 2.4 Multitronic, BDV, 3.0 Cabriolet ASN, 8H7, 3.0 TDi 8EC Quattro BKN, 3.0 TDi Quattro Avant Tiptronic, BKN, ASB (02-08), A6 2.8 Quattro 4A, AAH, ACK, 3.0 Quattro Tiptronic BBJ (94-00), 2.4 BDV (02-05), 2.5 TDi BCZ, BDG, BFC (03-04), VW Passat IV 2.3 V5 AZX (03-05), Passat V 1.9TDi Comfortline AVB, 2.0FSI Comfortline, Tipt., Highline BCR BLY, 2.0 T FSI Sportline Tiptronic AXX/BPY, 2.0TDi Highline, DSG BKP/BMP, 3.2 V6 Auto. DSG (05-11)
<b>PQ737</b>	Rear Wheel Bearing Kit	VW Passat IV 2.8, 4 Motion, Quattro, Tiptronic ACK/ AMX, 3.2 V6 Sportline DSG AXZ (99-05)
<b>PQ738</b>	Front Wheel Bearing Kit	Chana Star 1.0 P/up, 1.3 P/up (06-12), DFM Mini Truck, Daihatsu Gran Max 1.5 l 3SZ-VE (2009-)
<b>PQ739</b>	Front Wheel Bearing Kit	BMW Mini Cooper R50/R52/56 1.6 Cooper, Convertible, W10B16A, Cooper S, CVT, W11B16A, R53 1.6 Cooper S W11B16A (02-09)
<b>PQ740</b>	Rear Wheel Hub Bearing Kit ASB	BMW Mini Cooper R50/R52/56 1.6 Cooper, Convertible, W10B16A, Cooper S, CVT, W11B16A, R53 1.6 Cooper S W11B16A (02-09) - 14mm Bolt Studs
<b>PQ741</b>	Front Wheel Bearing Kit	BMW Mini Cooper R50/R52/56 1.6 Cooper, Convertible, W10B16A, Cooper S, CVT, W11B16A, R53 1.6 Cooper S W11B16A (02-09), R55/R57/R58/R59 1.6L I4 (One/Cooper) Petrol turbocharged (Cooper S) 1.6L BMW N47 diesel I4 (Cooper D and One D) (2007-)
<b>PQ742</b>	Rear Wheel Bearing Kit	BMW Mini Cooper R50/R52/56 1.6 Cooper, Convertible, W10B16A, Cooper S, CVT, W11B16A, R53 1.6 Cooper S W11B16A (02-09)
<b>PQ743</b>	USE PQ469	
<b>PQ744</b>	USE PQ746	
<b>PQ745</b>	Rear Wheel Bearing Kit	BMW Mini Cooper R55/R57/R58/R59 1.6L I4 (One/Cooper) Petrol turbocharged (Cooper S) 1.6L BMW N47 diesel I4 (Cooper D and One D) (2007-)
<b>PQ746</b>	Front Wheel Bearing Kit	BMW X3 E83 2.5i SUV M54 E83LCi, 2.5si SUV N52N - 4X4 (04-07), X3 E83 2.0d SUV M47N2 E83LCi, 3.0d, i SUV M57N2, 3.0si SUV N52N - 4X4 (05-10), X5 E53 3.0d SUV M57N - 4X4 (01-06), X5 E53 3.0i SUV M54, 4.4i SUV N62, 4.6iS SUV M62, 4.8iS SUV N62 - 4X4 (2001-)
<b>PQ747</b>	Rear Wheel Bearing Kit	BMW X3 E83 2.5i SUV M54, E83LCi 2.5si SUV N52N - 4X4 (04-07), E83 2.0d SUV M47N2, E83LCi 3.0d, i SUV M57N2, 3.0si SUV N52N (05-10)



## BUYERS GUIDE - BEARING KITS

<b>PQ748</b>	Wheel Hub Bearing Kit	BMW Mini Cooper R60/R61 1.6L (One/Cooper), (Cooper S), 1.6L BMW N47 diesel (Cooper D and One D), 2.0L BMW N47 diesel (Cooper D Auto. and Cooper SD Models) - 4X2 (10-13) - Short Bolts
<b>PQ749</b>	Rear Wheel Hub Bearing Kit	BMW Mini Cooper R60/R61 1.6L (One/Cooper), (Cooper S), 1.6L BMW N47 diesel (Cooper D and One D), 2.0L BMW N47 diesel (Cooper D Auto. and Cooper SD Models) - 4X2 (10-13)
<b>PQ750</b>	Rear Wheel Bearing Kit	BMW Mini Cooper R60/R61 1.6L (One/Cooper), (Cooper S), 1.6L N47 diesel (Cooper D and One D), 2.0L N47 diesel (Cooper D Auto. and Cooper SD Models) (10-13)
<b>PQ751</b>	Front Wheel Bearing Kit	Fiat Punto 1.2 Dynamic 188A5000 (04-13)
<b>PQ752</b>	Front Wheel Bearing Kit	BMW 1 Series E87 116i 1.6 N45, 118i 2.0 N46, 120i 2.0 N46, 120d 2.0 N47, 130i 3.0 N52 (04-15), 3 Series E90 320d 2.0 Sedan & Touring, Start M47, 320i 2.0 Sedan & Touring, Start N46, 323i 2.5 Sedan & Touring, Start N52, 325i 2.5 Sedan & Touring, Start N52, 330Ci, d 3.0 Convertible N52 / M57, 335i, d 3.0 N54 / N55 (05-13), X1 xDrive E84 18i 2.0 N46, 20i 2.0 N20, 20d 2.0 N47, 23d 2.0 N47, 25d 2.0 47, 28i 2.0 N20 - 4X4 (09-15)
<b>PQ755L</b>	Rear Wheel Bearing Kit	Ford Ranger 2.5 Diesel, Turbo Diesel D/Cab, High Trail, XL, DT XLT High Trail D/Cab, Super Cab, 3.0TDCi Super Cab XLT Hi-Trail., 4.0 SubCab XLT Hi Trail, Super Cab XLT Hi-Trail. - 4X2, 2.5 D/Cab,High Trail, XL, DT XLT High Super Cab, 2.5TD Montana D/Cab WL4, 3.0TDCi, 4.0 Super Cab XLT - 4X4 (00-12), Mazda BT-50 2500 Tdi, 2.6i SLE D/cab., S/cab., 3000 CRDi SLE D/cab., Freestyle SLX S/cab., D/cab - 4X2, 4X4 (07-12), Drifter 2.5Td LWB Hi Ride, SL SLE,SLX D/cab, Hi Ride, Hi Trail D/cab P/up WL4 Dies./Turbo Dies. - 4X2, 2.5Td LWB D/cab, DL, SL, SLE, SLX S/cab, D/cab P/up WL4 Dies./Turbo Dies. - 4X4, 2.6i LWB Hi Ride, SL Hi Ride S/cab, SLE, SLX D/cab SLX Hi Ride D/cab, SLX Hi Trail D/cab P/up Pet. - 4X2, 2.6i V6 LWB SL S/cab, SLE, SLX D/cab P/up 4G54 Pet. - 4X4 (05-09)
<b>PQ755R</b>	Rear Wheel Bearing Kit	Ford Ranger 2.5 Diesel, Turbo Diesel D/Cab, High Trail, XL, DT XLT High Trail D/Cab, Super Cab, 3.0TDCi Super Cab XLT Hi-Trail., 4.0 SubCab XLT Hi Trail, Super Cab XLT Hi-Trail. - 4X2, 2.5 D/Cab,High Trail, XL, DT XLT High Super Cab, 2.5TD Montana D/Cab WL4, 3.0TDCi, 4.0 Super Cab XLT - 4X4 (00-12), Mazda BT-50 2500 Tdi, 2.6i SLE D/cab., S/cab., 3000 CRDi SLE D/cab., Freestyle SLX S/cab., D/cab - 4X2, 4X4 (07-12), Drifter 2.5Td LWB Hi Ride, SL SLE,SLX D/cab, Hi Ride, Hi Trail D/cab P/up WL4 Dies./Turbo Dies. - 4X2, 2.5Td LWB D/cab, DL, SL, SLE, SLX S/cab, D/cab P/up WL4 Dies./Turbo Dies. - 4X4, 2.6i LWB Hi Ride, SL Hi Ride S/cab, SLE, SLX D/cab SLX Hi Ride D/cab, SLX Hi Trail D/cab P/up Pet. - 4X2, 2.6i V6 LWB SL S/cab, SLE, SLX D/cab P/up 4G54 Pet. - 4X4 (05-09)
<b>PQ756</b>	Front Wheel Bearing Kit	Nissan X-Trail T30 2.0 QR20DE MPV, 2.0 MPV 20DE, 2.2D SE, SEL MPV, 2.5 25DE MPV - 4X2, 4X4 (01-09)
<b>PQ757</b>	Rear Wheel Bearing Kit	Nissan X-Trail T30 2.0 QR20DE MPV, 2.0 MPV 20DE, 2.2D SE, SEL MPV, 2.5 25DE MPV - 4X4 (01-09)
<b>PQ758</b>	Front Wheel Bearing Kit	Ford Everest 3.0 Tdci - 4X2, 4X4 (09-15), Ranger 2.5 Diesel, Turbo Diesel D/Cab, High Trail, XL, DT XLT High Trail D/Cab, Super Cab, 3.0TDCi Super Cab XLT Hi-Trail., 4.0 SubCab XLT Hi Trail, Super Cab XLT Hi-Trail. - 4X2, 2.5 D/Cab,High Trail, XL, DT XLT High Super Cab, 2.5TD Montana D/Cab WL4, 3.0TDCi, 4.0 Super Cab XLT - 4X4 (00-12), Mazda BT-50 2500 Tdi, 2.6i SLE D/cab., S/cab., 3000 CRDi SLE D/cab., Freestyle SLX S/cab., D/cab - 4X2, 4X4 (07-12), BT-50 3.2 MZ-CD P5-AT - 4X4 (2012-), Drifter 2.5Td LWB Hi Ride, SL SLE,SLX D/cab, Hi Ride, Hi Trail D/cab P/up WL4 Dies./Turbo Dies. - 4X2, 2.5Td LWB D/cab, DL, SL, SLE, SLX S/cab, D/cab P/up WL4 Dies./Turbo Dies. - 4X4, 2.6i LWB Hi Ride, SL Hi Ride S/cab, SLE, SLX D/cab SLX Hi Ride D/cab, SLX Hi Trail D/cab P/up Pet. - 4X2, 2.6i V6 LWB SL S/cab, SLE, SLX D/cab P/up 4G54 Pet. - 4X4 (05-09)
<b>PQ759</b>	Front Wheel Bearing Kit	GWM Double Cab Lux 2.2 TDi, MPI, Standard (2007-)
<b>PQ760</b>	Front Wheel Bearing Kit	Toyota Hilux "Vigo" 2.0i U16/17 S/Cab, S, SRX LWB Pet. P/up 1TR-FE Pet., 2.5TDi D-4D S/Cab, S, SRX, S/Cab, S/Cab SRX HO, Raised Body Raider, D/Cab LWB 2KD-FTV, 2.7i S/Cab Raider, D/Cab Raider, S/Cab HO Raised Body LWB P/up 2TR-FE Pet. - 4X2 (05-11), 2.0i S/Cab, S, SRX LWB Pet. P/up 1TR-FE Pet., 2.5TDi D-4D S/Cab, S, SRX, S/Cab, S/Cab SRX HO, Raised Body Raider, D/Cab LWB P/up 2KD-FTV, 2.7i Raised Body Raider, D/Cab LWB P/up 2TR-FE Pet. (09-11), 2.0 VVTi 1TR-FE 5 Spd Man. S/cab, 2.5D-4D Raised Body 2KD-FTV 5 Spd Man., 2.5D-4D Std. Body 2KD-FTV 5 Spd Man. - 4X2 (11-16), Hilux "REVO" 2.0 VVTi 1TR-FE, 2.4 GD-6 Raised Body 2GD-FTV, 2.7 VVTi Raised Body 2TR-FE - 4X2 (2016-)

## BUYERS GUIDE - BEARING KITS

<b>PQ761</b>	Front Wheel Bearing Kit	Toyota Fortuner 3.0 D-4D SUV 1KD-FTV, 4.0 V6, Epic SUV 1GR-FE Pet. - 4X2, 4X4 (06-11), 2.5D-4D 2KD-FTV, 3.0D-4D 1KD-FTV, 4.0 V6 1GR-FE, 4.0 V6 Raised Body 1GR-FE - 4X2, 4X4 (11-16), Hilux "Vigo" 2.5TDi D-4D S/Cab, S, SRX, S/Cab, S/Cab SRX HO, Raised Body Raider, D/Cab LWB 2KD-FTV, 3.0 D-4D TDi Raider, D/C Raider, Raised Body LWB P/up 1KD-FTV Dies., 4.0i D/Cab Raider Raised Body LWB P/up GR-FE Pet. - 4X2, 3.0 D-4D TDi D/C Raider 1KD-FTV Dies., LWB P/up, 4.0 D/Cab Raider 1GR-FE Pet. LWB P/up - 4X4 (05-09), 2.7i S/Cab Raider, D/Cab Raider, S/Cab HO Raised Body LWB P/up 2TR-FE Pet. - 4X2 (05-11), 2.5TDi D-4D S/Cab, D/Cab SRX, Legend40 2KD-FTV Dies. LWB P/up, 2.7i S/Cab SRX, Legend40 2TR-FE Pet. LWB P/up - 4X4 (05-15), 3.0D-4D TDi D/C xtra cab, Raider, Legend40 1KD-FTV Dies. LWB 4.0 D/Cab Raider, 1GR-FE Pet. - 4X4 (2009-), 2.5TDi D-4D S/Cab, S, SRX, S/Cab, S/Cab SRX HO, Raised Body Raider, D/Cab LWB P/up 2KD-FTV, 2.7i Raised Body Raider, D/Cab LWB P/up 2TR-FE Pet. (09-11), 3.0D-4D TDi D/C Raised Body Raider, Xtra cab, Legend40 LWB P/up KD-FTV Dies., 4.0i D/C Raised Body Raider, Legend40 LWB P/up 1GR-FE Pet. (09-16), Hilux 2.5D-4D Raised Body 2KD-FTV 5 Spd man. - 4X4 (11-16), 2.7 VVTi 2TR-FE, 3.0D-4D 1KD-FTV, 4.0 1GR-FE - 4X2 (11-16), 3.0D-4D 1KD-FTV, 4.0 1GR-FE - 4X4 (11-16)
<b>PQ761ABS</b>	Front Wheel Kit	Toyota Fortuner 4X4 (2006-), Hi Lux "Vigo" 4X4 (2005-)
<b>PQ762</b>	Front Wheel Bearing Kit	Chery QQ3 0.8 TE, TX, 1.1 TXE (2008-), Daihatsu Charade 1.0 (03-11), Cuore 847cc ED10 (97-03), Sirion 1.3, 1.5 (00-14)
<b>PQ763</b>	Front Wheel Bearing Kit	Daihatsu Sirion 1.3, 1.6 (00-14)
<b>PQ764</b>	Rear Wheel Bearing Kit	Daihatsu Sirion 1.3, 1.5 (00-14)
<b>PQ765</b>	USE PQ633	
<b>PQ766</b>	Rear Wheel Bearing Kit	Citroen C3 II 1.2i Vti EB2F, 1.4i Vti, 1.6i Vti, 1.6 HDi, e-Hdi (2010-), Peugeot 208 1.0 Vti, 1.2 Vti, 1.6 Vti, Hdi (2012-)
<b>PQ767</b>	Front Wheel Bearing Kit	Hyundai Elantra MD/UD 1.6 G4FG, 1.8 G4NB (11-16), i30 FD/GD 1.6 G4FG, G4GG, 1.8 G4NB, 2.0 G4GC-G (2010-), Veloster 1.6 GDi G4FD, G4FJ (2013-), Kia Cerato 1.6 LX G4FC, 2.0 G4KD (2008-), Soul 1.6 G4FC, 1.6 CRDi D4FB, 2.0 G4KD (2009-)
<b>PQ768</b>	Rear Wheel Hub Bearing Kit ABS	Hyundai Elantra HD 2.0 GLS, G4GC (07-11), i30 FD/GD 1.6 G4FG, G4GG, 1.8 G4NB, 2.0 G4GC-G (2010-)
<b>PQ769</b>	Rear Wheel Bearing Kit	Kia K2700i 2.7D Workhorse LWB Dies."Bakkie" D/S (2004-)
<b>PQ770</b>	Rear Wheel Hub Bearing Kit	Hyundai iX35 2.0 G4KD, 2.0 CRDi D4HA, 2.4 G4KE - 4X2, 4X4 (2010-), Sonata 2.0 V6 (EF), 2.4 (NF), 2.4 G4KC (YF), 2.7 V6 (EF) (2001-), Tucson JM 2.0 G4GC, 2.0 CRDi D4EA, 2.7i V6 G6BA-G - 4X2, 4X4 (04-10), Kia Optima 2.4 G4KJ (12-14), Sportage SL 2.0 SUV G4NC, 2.0 CRDi D4HA, 2.4 G4KE - 4X2, 4X4 (2010-)
<b>PQ771</b>	Rear Wheel Hub Bearing Kit	Mitsubishi Pajero 3.2 DI-D, 3500, 3.8i - 4X4 (02-07), 2.5 DI-D 4D56, 3.2 DI-D 4M41, 3.2 DI-DC 4M41, 3.8i V6 6G75 - 4X4 (2007-), 3.2 DI-D V98 BK Series - 4X4 (10-13)
<b>PQ772</b>	Front Wheel Hub Bearing Kit	Mitsubishi Pajero 3.2 4X4 (2005-) Not For Sa Models
<b>PQ772A</b>	Front Wheel Hub Bearing Kit	Mitsubishi Pajero 3.2 DI-D, 3500, 3.8i - 4X4 (02-07), 2.5 DI-D 4D56, 3.2 DI-D 4M41, 3.2 DI-DC 4M41, 3.8i V6 6G75 - 4X4 (2007-) - S.A Model!
<b>PQ773</b>	Rear Wheel Hub Bearing Kit	Hyundai Sonata 2.0 V6 (EF), 2.4 (NF), 2.4 G4KC (YF), 2.7 V6 (EF) (2001-)
<b>PQ774</b>	Rear Wheel Hub Bearing Kit	Hyundai Elantra XD 1.6 G4ED, 2.0 G4GC, CRDi D4EA (02-07), i10 PA 1.1 G4HG, 1.2 G4LA (08-15), Matrix 1.6 GLS G4ED, 1.8 G4GB-G (02-08), Kia Cerato 1.6 LX G4FC, 2.0 CRDi (04-08)
<b>PQ775</b>	Rear Wheel Bearing Kit	Hyundai H1 2.4 G4KC CVVT P/van Man., Wagon, 2.5 D4CB CRDi P/van Diesl. Man/Auto. (2009-)
<b>PQ776</b>	Front Wheel Bearing Kit	Citroen C2 1.4 HDi, DV4TD, 1.4i VTR TU3JP, 1.6i VTS TU5JP4S (04-10), C3 1.4i HDi, DV4TED4, 1.6i Pluriel, Sensodrive, TU5JP4 (02-10), C3 II 1.2i Vti EB2F, 1.4i Vti, 1.6i Vti, 1.6 HDi, e-Hdi (2010-), DS3 1.2i Vti EB2F, 1.6 Vti EP6C, 1.6 e-Hdi 9HP (2010-), Peugeot 1007 1.6 MPV TU5JP4 (05-08), 207 1.4i XL, XR, XR+, Urban, Active, 1.4 Hdi, 1.6i XS, GTi, CC Sport 1 & 2, HDi XS, Dynamic, Vti Dynamic, 1.6 Hdi (06-13), 208 1.0 Vti, 1.2 Vti, 1.6 Vti, Hdi, 1.6 Gti (2012-)
<b>PQ777</b>	Rear Wheel Bearing Kit	Hyundai Accent MC 1.6 G4ED (06-11), Getz 1.3 G4EA, 1.4i G4EE, 1.5 D3EA, D4FA, 1.6 G4ED-G (03-12), i10 PA 1.1 G4HG, 1.2 G4LA (08-15), Grand i10 1.1 G3LA (2017-), 1.2 G4LA (2014-), Kia Picanto 1.1 LX, EX 5 Dr. H/back G4HG (04-11)
<b>PQ778</b>	Front Wheel Bearing Kit	Mitsubishi Triton 2.4 MPI D/cab P/up 2.5 Di-D C/cab P/up, 2.5 Di-D D/cab P/up, 3.2 Di-D D/cab P/up, 3.5 Club cab P/up, 3.5 MPI Double cab P/up - 4X2, 4X4 (2007-)

## BUYERS GUIDE - BEARING KITS

<b>PQ779</b>	Front Wheel Bearing Kit	Fiat Palio I 1.2 ED, EL, Go!, Paint Ltd. M657BA.12T 178B5.000, 1.6 EL, ELX, HL, Weekend S/W, 178B3.000 (00-05), Siena I/II 1.2 EL, EL, Plus!, M657BA 12T, 1.6 EL, Plus!, ELX HL 178B3.000, 1.6 EL+, HL, ELX, 178B3000, 1.7TD EL 176A3.000 (00-10), Uno1.4 Turbo 146A (90-98), Tata Indica/ Vista 1.4 LEi, LSi, LX, Lxi, 1.4TDi DLX, DLS, Indigo 1.4 GLS S/W, 1.4TDi DLX S/W (2005-)
<b>PQ780</b>	Front Wheel Bearing Kit	Fiat Palio I 1.2 ED, EL, Go!, Paint Ltd. M657BA.12T 178B5.000, 1.6 EL, ELX, HL, Weekend S/W, 178B3.000 (00-05), Siena I/II 1.2 EL, EL, Plus!, M657BA 12T, 1.6 EL, Plus!, ELX HL 178B3.000, 1.6 EL+, HL, ELX, 178B3000, 1.7TD EL 176A3.000 (00-10)
<b>PQ781</b>	Front Wheel Bearing Kit	Toyota Avanza 1.3i P/Van, S, SX MPV K3VE, 1.5i SX, TX MPV 3SZVE (06-12)
<b>PQ781COMP</b>	Front Wheel Bearing Kit	Toyota Avanza 1.3i, 1.5i, 1.3i P/Van (2006-)
<b>PQ782</b>	Front Wheel Hub Bearing Kit	Hyundai H1 2.4 G4KC CVVT P/van Man., Wagon, 2.5 D4CB CRDi P/van Diesel. Man/Auto. (2009-)
<b>PQ783</b>	Rear Wheel Bearing Kit	Daihatsu Terios 1.3 SUV K3-VE, 1.5i Off-Road, 5/7 Seater SUV 3SZ-VE, 1.5 - 4X2, 4X4 (02-15), Toyota Avanza 1.5i SX, TX MPV 3SZVE (06-12), 1.3 S, SX MPV 3K3VE, 1.3 S P/Van 3K3VE, 1.5 SX, TX MPV 3SZVE (12-16), 1.3 S, SX MPV 1NRVE, 1.3 S P/Van 1NRVE, 1.5 SX, TX MPV 2NRVE (2016-)
<b>PQ784</b>	Front & Rear Wheel Bearing Kit ASB	Honda CR-V II 2.0 K2OA4 - 4X4 (05-09), Jazz 1.4 Dsi, 1.5 V-TEC L15A (03-07)
<b>PQ785</b>	Rear Wheel Bearing Kit	Honda Ballade 1.5i L15A7 (2011-), Brio 1.2 L12B1 (2012-), Jazz 1.4 Dsi, 1.5 V-TEC L15A (03-07)
<b>PQ786</b>	Rear Wheel Bearing Kit	Audi A4 1.8T Avant, Multitronic, BFB, B6 AVJ 8E2, 1.9 TDi AVF, Avant B6, 8E5, 8E2, 2.0 Multitronic Avant 8EC, 8E2 ALT, 2.0 TDi 125, 8EC BLB, Avant Multitronic, 2.0TFSi DTM 147 BGB, 3.2 FSi Quattro, 8EC Multitronic Avant, Tiptronic Avant, AUK (00-08), 2.4 Multitronic, BDV, 2.5 TDi 8D/E2 Quattro AFB, Quattro Tiptronic, 2.6 8D2 / 8D5 Exec., 3.0 Cabriolet ASN, 8H7, 3.0 TDi 8EC Quattro BKN, 3.0 TDi Quattro Avant Tiptronic, BKN, ASB, 3.0 Quattro Tiptronic, ASN (02-08), 1.8 TFSi CABB, CDHB, CJEB, CDHA, CABA, 2.0 T, 2.0 TFSi CAEB, CDNC, GLC, CMGB, 2.0 TDi BRD, CAGA, CJCA, CMEA, CMFA (08-14), 3.2 Fsi, 3.2 FSi Quattro AUK, CALA (06-12)
<b>PQ787</b>	Rear Wheel Bearing Kit	Hyundai Tucson 2.0, 2.7 (2004-)
<b>PQ788</b>	Rear Wheel Bearing Kit	Hyundai Tucson JM 2.0 G4GC, 2.0 CRDi D4EA, 2.7i V6 G6BA-G - 4X2, 4X4 (04-10), Kia Sportage JE 2.0 SUV G4GC, 2.0 CRDi SUV D4EA, 2.7 V6 SUV G6BA - 4X2, 4X4 (04-10)
<b>PQ789</b>	Rear Wheel Hub Bearing Kit	Hyundai Elantra XD 1.6 G4ED, 2.0 G4GC, CRDi D4EA (02-07)
<b>PQ790</b>	Rear Wheel Bearing Kit	Hyundai Matrix 1.6 GLS G4ED, 1.8 G4GB-G (02-08)
<b>PQ791</b>	Rear Wheel Bearing Kit	Hyundai Elantra HD 1.6 GLS, 2.0 GLS, G4GC (07-11), Tiburon 2.0 G4DF (96-10)
<b>PQ792</b>	Front Wheel Bearing Kit	Lexus RX 300, 350, 400, 450 (2003-), Mazda 6 2.0 Active, Original, Elegant, 2.3 Dynamic, - Dynamic Individual, Sporty, Sporty Lux, 2.3 MPS AWD, 2.5 Dynamic Activematic, Individual (03-14), CX-7 2.3 L3-VDT AWD, 2.5 L5-VE (07-12), 2.3 L3-VDT - 4X4 (07-12), Toyota Avensis 2.2 D4D Exclusive (06-09), Camry II 2.0, 2.4i Xli, 3.0 GLX 1MZ-FE (01-06), Corolla Verso ZZE122 160i S, SX MPV, 180i SX, SX MMT, TX, TX MMT MPV 1ZZ-FE (04-09)
<b>PQ793</b>	Rear Wheel Bearing Kit	Chevrolet Aveo 1.5 L, LS, LT, 1.6 LS (2011-), Sonic 1.3D, 1.4 Pet. Hatch / Sedan, 1.6 Pet. Hatch / Sedan (11-15), Opel Mokka 1.4T A14NET, B14NET (15-16)
<b>PQ794</b>	Rear Wheel Bearing Kit	Nissan Navara D40 Series 2.5DCi, LE, SE, XE D/Cab P/up, 4.0i V6, LE D/Cab P/up (05-17), Navara D40/ R51 2.5DCi D/Cab P/up, 3.0DCi V6, 4.0i V6, LE D/Cab P/up - 4X4 (05-17)
<b>PQ795</b>	Front Wheel Bearing Kit	Mazda 3 (BL, BK) 1.6 Original, Active, Dynamic B6ZE, Z6, 2.0 Individual LF17, 2.0 BN Series, 2.3, 2.3 MPS L6KG, 2.5 L5-VE (04-14), 5 2.0 Original, Active, Individual (07-14), 6 2.0 Active, Original, Elegant, 2.3 Dynamic, Dynamic Individual, Sporty, Sporty Lux, 2.3 MPS AWD, 2.5 Dynamic Activematic, Individual (03-14)
<b>PQ796</b>	Rear Wheel Bearing Kit	Toyota Corolla Verso ZZE122 160i S, SX MPV, 180i SX, SX MMT, TX, TX MMT MPV 1ZZ-FE (04-09)
<b>PQ797</b>	Front Wheel Bearing Kit	Mercedes-Benz R171 SLK200K M271.954/958, SLK350 M272.963/ 969, SLK55 AMG M113.989 (04-11), R172 SLK250, SLK350 M276.956, SLK55 AMG M152.980 (2011-), W203 C-Class C180 Classic M111.920, C200 M111.941, C220 M111.961, C230 M111.974, C240 M111.944, C250 M605.910, C270CDi M612.962, C280 M104.941 (94-08), W204 C-Class C180K, C200K, Cdi, C220 Cdi, C250, Cdi, C300, C350, Cdi, C63 AMG (07-14)
<b>PQ798</b>	Rear Wheel Bearing Kit	Mercedes-Benz W204 C-Class C180K, C200K, Cdi, C220 Cdi, C250, Cdi, C300, C350, Cdi, C63 AMG (07-14)
<b>PQ799</b>	Rear Wheel Hub Bearing Kit	Ford Fiesta III 1.0 Ecoboost, 1.4 Sedan, 1.4i Ambiente', Trend, Titanium, 1.6 Limited, 1.6i Ambiente', Sport, Trend, Titanium, TDCi, 1.6 Gtdi (2008-), Mazda 2 (DE) 1.3 Active, Dynamic, 1.5 Dynamic, Individual (07-15)
<b>PQ800</b>	Rear Wheel Bearing Kit	Mazda 6 2.0 Active, Original, Elegant, 2.3 Dynamic, Dynamic Individual, Sporty, Sporty Lux, 2.3 MPS AWD, 2.5 Dynamic Activematic, Individual (03-14)

## BUYERS GUIDE - BEARING KITS

<b>PQ801</b>	Rear Wheel Bearing Kit	Nissan Grand Livina 1.6 Acenta, + HR16DE (08-14), Tiida 1.6 Acenta, Visia, +, 1.8 Acenta (06-13)
<b>PQ802</b>	Rear Wheel Bearing Kit	Citroen C1 1.0 1KR, 1.0i Furio, Play 1KR (06-15), Peugeot 107 1.0 XR, XR+, X-Line (06-16), Toyota Aygo 1.0 Fresh, Inferno, Wild 3/5-door, X-Cite, X-Play 1KR (2011-)
<b>PQ803</b>	Rear Wheel Bearing Kit	Nissan Primastar 1.9 DCi Minibus (07-11), Opel Vivaro 1.9CDTi P/Van, 2.0i P/van (06-15), Renault Trafic 1.9dCi 100 P/Van F9Q760 (05-07)
<b>PQ804</b>	Rear Wheel Bearing Kit	Nissan Interstar 2.5DCi SR, HR P/Van (2006-)
<b>PQ805</b>	Front & Rear Wheel Bearing Kit	Hyundai Santa Fe' 2.4 SUV G4JS, 2.7 V6 SUV G6BA-G - 4X4 (01-05), Santa Fe' 2.2 CRDi D4EB "CM", 2.2 CRDi D4EB, D4HB - 4X2, 4X4 (06-10), Tucson 1.6 Gdi G4FD, 1.6 T-Gdi G4FJ, 2.0 CRDi D4HA (15-20), Kia Sorento 2.2 D4HB, 2.4, 3.5 V6 G6DC - 4X2, 4X4 (2006-), Sportage IV (QL, QLE) 1.6 Gdi G4FD, 1.6 TGDI AWD G4FJ, 2.0 G4NA, 2.0 CRDi G4HA, 2.4 Gdi G4KJ (2015-)
<b>PQ806</b>	Rear Wheel Hub Bearing Kit	Hyundai Santa Fe' 2.2 CRDi D4EB "CM", 2.2 CRDi D4EB, D4HB - 4X2, 4X4 (06-10), Kia Sorento 2.2 D4HB - 4X2 (2006-)
<b>PQ807</b>	Rear Wheel Bearing Kit	Nissan Murano 3.5 V6 SUV (2005-), 3.5 V6 SUV - 4X4 (2009-)
<b>PQ808</b>	Rear Wheel Bearing Kit	Hyundai H100 P/van 2.6 (02-04)
<b>PQ809</b>	Front Wheel Bearing Kit	Honda Accord VIII 2.0i V-Tec R20A3, 2.2 i-D-Tec N22B1/2, 2.4i V-Tec K24Z3 (08-15)
<b>PQ810</b>	Rear Wheel Bearing Kit	Honda Accord VIII 2.0i V-Tec R20A3, 2.2 i-D-Tec N22B1/2, 2.4i V-Tec K24Z3 (08-15)
<b>PQ811</b>	Front, Rear Wheel Bearing Kit	Honda Ballade 1.5i L15A7 (2011-), Brio 1.2 L12B1 (2012-), Jazz IV 1.3 i-VTEC LX Man., Auto., 1.4i L13Z1, 1.5 i-VTEC EX L15A (08-14), Jazz IV 1.2 Trend L12B4, 1.5 Elegance L15Z2 (2015-)
<b>PQ812</b>	Rear Wheel Hub Bearing Kit	Toyota Corolla Verso 1.6, 1.8, 2.0 D-4D (09-14), Yaris 1.0, 1.3 ZEN3, 1.5 Hybrid (10-18)
<b>PQ813</b>	Rear Wheel Bearing Kit	Honda Civic VII 150i, 170i V-Tec (03-06)
<b>PQ814</b>	Rear Wheel Bearing Kit	Honda Civic VII 150i, 170i V-Tec (03-06)
<b>PQ815</b>	Front Wheel Bearing Kit	Ford Focus III 1.6i PNDA, 1.8 Si, Ambiente, Trend., 2.0 Gdi MGDA, 2.0 TDci G6DA, BYD, 2.0 Gtdi ST1 & ST2 R9DA (09-15), Kuga 1.5 Ecoboost, 1.6 Ecoboost JQMA, JQMB, 1.6 Ecoboost Turbo JTMA, 2.0 Ecoboost, 2.0 TDCi, 2.0 TDCi TXDA, TXMA, 2.5 Turbo - 4X2, 4X4 (2011-), Tourneo / Transit Connect/Grand Connect 1.0 EcoBoost Trend MPV SWB B3GA, 1.5 TDCi Ambiente Dsl P-Van LWB XWGA, 1.6 TDCi EcoBoost LWB T1GA (2013-)
<b>PQ816</b>	Rear Wheel Bearing Kit	Ford Focus III 1.6i PNDA, 1.8 Si, Ambiente, Trend., 2.0 Gdi MGDA, 2.0 TDci G6DA, BYD, 2.0 Gtdi ST1 & ST2 R9DA (09-15)
<b>PQ817</b>	Rear Wheel Bearing Kit	Ford Focus II 1.6 Si, Ambiente, Trend., 2.0 Si, Trend., TDCi Ghia, TDCi Si., 2.5 ST. HYDA (05-09), Focus III 1.6i PNDA, 1.8 Si, Ambiente, Trend., 2.0 Gdi MGDA, 2.0 TDci G6DA, BYD, 2.0 Gtdi ST1 & ST2 R9DA (09-15)
<b>PQ818</b>	Front Wheel Bearing Kit ASB	Hyundai Tiburon 2.0 G4DF (96-10)
<b>PQ819</b>	Rear Wheel Hub Bearing Kit	Toyota Avensis 2.2 D4D Exclusive (06-09)
<b>PQ820</b>	Rear Wheel Bearing Kit	Nissan Juke 1.2 DIG-T HRA20DDT, 1.5 dCi K9K, 1.6 HR16DE - 4X2 (2010-), Livina 1.6 Acenta, +, Visia, X-Gear (07-15), Qashqai 1.5DCi, 1.6 Visia, Acenta, 2.0 DCi Acenta SUV, Petrol (2007-), 1.5DCi K9K282, K9K292, 1.5DCi K9K636, K9K646, 1.6 HR16DE, 2.0 DCi M1D, M9R, MR20DE (2007-), X-Trail T31 2.0 D, Dci - 4X2 (08-14), T32 1.6 Dci R9M, 2.0 CVT 6 speed MR20DD - 4X2 (2014-), Renault Koleos 2.5 Dynamique SUV (2009-)
<b>PQ821</b>	Rear Wheel Bearing Kit	Nissan Juke 1.6 DIG-T MR16DDT - 4X4 (2010-), Qashqai 2.0 Acenta, n-tec, 2.0 DCi Tekna SUV - 4X4 (2007-), X-Trail T31 2.0 D, Dci - 4X4 (08-14), T32 1.6 Dci R9M, 2.5 QR25DE - 4X4 (2014-), Renault Koleos 2.0dCi Dynamique Premium SUV, 2.5 Dynamique, Premium CVT SUV - 4X4 (2009-)
<b>PQ822</b>	Rear Wheel Bearing Kit	Opel Corsa C 140i Classic, Comfort, Chill, Classic Essentia, Hatch Club, Sport, Lite Sport, S14NE, 160i Classic, Classic Elegance, Classic CD, CDE, Sport,16SE, 1.7TDi Sport, Classic, CDTi Enjoy, Hatch CDTi Elegance, Classic DTi Elegance X17D, 1.8i GSi Hatch, Classic (03-08)
<b>PQ823</b>	Rear Wheel Bearing Kit	Opel Adam 1.0T Jam, Glam, Rocks B10XFT, 1.4 B14XER, A14XER, Adam S 1.4T B14NEH (2014-), Corsa D 1.3CDTi Enjoy, 1.4i Essentia, Enjoy, Cosmo, Sport, 1.6i Sport, OPC (08-15), Corsa E 1.0 T B10XFT, F10XFT, 1.4 T B14XEL, 1.4 T B14NEH (2015-), Meriva 1.3 CDTi Enjoy, 1.4 Essentia, Enjoy, 1.6 Club, Comfort, Enjoy MPV Z16SE/-XE, 1.7 CDTi Enjoy, Elegance, 1.8 Elegance MPV Easytronic (03-09)
<b>PQ824</b>	Rear Wheel Bearing Kit	Opel Adam 1.0T Jam, Glam, Rocks B10XFT, 1.4 B14XER, A14XER, Adam S 1.4T B14NEH (2014-), Corsa D 1.3CDTi Enjoy, 1.4i Essentia, Enjoy, Cosmo, Sport, 1.6i Sport, OPC (08-15), Corsa E 1.0 T B10XFT, F10XFT, 1.4 T B14XEL, 1.4 T B14NEH (2015-)
<b>PQ825</b>	Rear Wheel Bearing Kit	Peugeot 1007 1.6 MPV TU5JP4 (05-08)



## BUYERS GUIDE - BEARING KITS

<b>PQ826</b>	Rear Wheel Bearing Kit	Citroen C3 II 1.2i VTI EB2F, 1.4i Vti, 1.6i Vti, 1.6 HDi, e-Hdi (2010-), C4 1.6 VTR Coupe' TU5JP4, 1.6 Hdi DV6TED4, 2.0i VTS Coupe' EW10J4S (05-10), DS3 1.2i VTI EB2F, 1.6 VTI EP6C, 1.6 e-Hdi 9HP (2010-), Nissan NP200 1.5DCi S, SE P/up, 1.6, S, SE P/up (2008-), Peugeot 207 1.4i XL, XR, XR+, Urban, Active, 1.4 Hdi, 1.6i XS, GTi, CC Sport 1 & 2, HDi XS, Dynamic, VTI Dynamic, 1.6 Hdi (06-13), 208 1.6 Gti (2012-), 307 1.6 Estate, X-Line, XR, XT TU5JP4, HDi, X-Line HDi, XS HD EW10J4, 2.0 CC, CC 100/ 130/ 180, XS, S/W EW10J4 XS HDi DW10TD (06-08), Renault Scenic II 1.6 Authentique, Expression, Joie de Vivre K4M761/782 (02-10), Scenic III 1.6, 1.9dCi (11-13)
<b>PQ827</b>	Rear Wheel Bearing Kit	Peugeot 308 1.6 (2008-)
<b>PQ828</b>	Rear Wheel Bearing Kit	Peugeot Boxer - All With 1.2 Ton to 1.6 Ton Mass (06-09)
<b>PQ829</b>	Rear Wheel Bearing Kit	Peugeot Boxer - All With 1.6 Ton to 2.0 Ton Mass (06-09)
<b>PQ830</b>	Rear Wheel Bearing Kit	Renault Koleos 2.0DCi, 2.5 - All 2X4, 4X4 (2009-)
<b>PQ832</b>	Rear Wheel Bearing Kit	Suzuki Jimny 1.3i SUV M13A, 1.5 K15B - 4X4 (2014-)
<b>PQ833</b>	Rear Wheel Bearing Kit	Suzuki Jimny 1.3i SUV M13A - 4X4 (2014-)
<b>PQ834</b>	Front Wheel Bearing Kit	VW Amarok 2.0 Tsi, 2.0 Tdi, 2.0 Bi-Tdi - 4X2, 4X4 (10-16)
<b>PQ835</b>	Rear Wheel Bearing Kit	VW Amarok 2.0 Tsi, 2.0 Tdi, 2.0 Bi-Tdi - 4X2, 4X4 (10-16)
<b>PQ836</b>	Rear Wheel Bearing Kit	Suzuki Swift 1.5i GL, GLS M15A, 1.5 RS415, 1.6 RS416 (08-11)
<b>PQ837</b>	Rear Wheel Bearing Kit	Suzuki Swift 1.4 GL, GLS, SE K14B, 1.6, i M16A (11-18), SX4 4X2 1.6 GL, GLX, MA16A (2014-)
<b>PQ838</b>	Rear Wheel Bearing Kit	Toyota Auris 2.0Di D-4D RS, RX, Corolla FWD 1.3i Impact, Professional, Advanced, 1.4i, 1.6i Professional, Advanced, 1.8i (2007-), Corolla Quest FWD 1.6 Auto, Plus (2014-)
<b>PQ839</b>	Rear Wheel Bearing Kit	Toyota Auris 2.0Di D-4D RS, RX, Corolla FWD 1.3i Impact, Professional, Advanced, 1.4i, 1.6i Professional, Advanced, 1.8i, 2.0, 2.0D D-4D Advanced, Exclusive (2007-), Verso 1.6, 1.8, 2.0D-4D (09-14)
<b>PQ840</b>	Rear Wheel Bearing Kit	Toyota Avensis 2.0i Advanced, 2.4i Exclusive (06-09)
<b>PQ842L</b>	Rear Wheel Bearing Kit	Toyota FJ Cruiser 4.0 V6 - 4X4 (2011-), Land Cruiser PRADO 120 3.0D 1KZ-TE VX S/W, 4.0 1GR-FE GX, VX S/W - 4X4 (02-10), 150 3.0TDi 1KD-FTV, 4.0 V6 VVTi 1GR-FE (2009-)
<b>PQ842R</b>	Rear Wheel Bearing Kit	Toyota FJ Cruiser 4.0 V6 - 4X4 (2011-), Land Cruiser PRADO 120 3.0D 1KZ-TE VX S/W, 4.0 1GR-FE GX, VX S/W - 4X4 (02-10), 150 3.0TDi 1KD-FTV, 4.0 V6 VVTi 1GR-FE (2009-)
<b>PQ843</b>	Rear Wheel Hub Bearing Kit	Ford B-Max 1.0 EcoBoost M1JE, M1JH (2015-), Ecosport 1.0i Ecoboost Petrol, M1JC, 1.5 TDCi Diesel, UGJE, 1.5i Petrol, UEJB (2013-)
<b>PQ844</b>	Front & Rear Wheel Bearing Kit	Ford B-Max 1.0 EcoBoost M1JE, M1JH (2015-), Ecosport 1.0i Ecoboost Petrol, M1JC, 1.5 TDCi Diesel, UGJE, 1.5i Petrol, UEJB (2013-), Fiesta III 1.0 Ecoboost, 1.4 Sedan, 1.4i Ambiente', Trend, Titanium, 1.6 Limited, 1.6i Ambiente', Sport, Trend, Titanium, TDCi, 1.6 Gtdi (2008-)
<b>PQ845</b>	Front & Rear Wheel Bearing Kit	Audi A3 1.2 TFSi CJZJ, CJZA, 1.4 TFSi CXSA, 1.6 TDi CLHA, 1.8 TFSi Quattro CJSa, CJSB, 2.0 TDi DBGA (12-17), 1.4 TFSi CZCA, CZEA, 2.0TDi CRFC (13-17), S3 2.0 TFSi CJXB (13-17), VW Golf VII 1.2TSi, 1.4TSi, 2.0 Gti, 2.0TDi (2013-)
<b>PQ846</b>	Front Wheel Bearing Kit	Audi A3 1.2 TFSi CJZJ, CJZA, 1.4 TFSi CXSA, 1.4 TFSi CZCA, CZEA, 1.6 TDi CLHA, 1.8 TFSi Quattro CJSa, CJSB, 2.0 TDi DBGA, 2.0TDi CRFC (12-17), S3 2.0 TFSi CJXB (13-17), VW Golf VII 2.0 Gti (2013-)
<b>PQ847</b>	Front Wheel Bearing Kit	Audi A6 2.4 BDW, 3.2 FSi AUK (04-09), 2.0 TFSi BPJ (09-11)
<b>PQ848</b>	Rear Wheel Bearing Kit	Audi A6 2.4 BDW, 3.2 FSi AUK (04-09), 2.7 TDi BPP, CANA, 2.8 FSi BDX, CCEA (06-11), 2.0 TFSi BPJ (09-11)
<b>PQ849</b>	Front & Rear Wheel Bearing Kit	AUDI A6 2.7 TDi BPP, CANA, 2.8 FSi BDX, CCEA, 3.0 TDi Quattro ASB, 3.0 TFSi Quattro CAJA, CDYA, CDYC (06-11)
<b>PQ850</b>	Front Wheel Bearing Kit	BMW 1 Series F20/1 116i 1.6 N13, 118i 2.0 N13, 120d 2.0 N47, 125i 2.0 N20 (11-16), 3 Series F30/1 316i N13B16A, 320i 2.0 N20, 328i 2.0 N20, 330d 3.0 N57D30A, 335i 3.0 N55B30A (2012-), F30 318i 1.5 F30N B38 320i 2.0 B48, 320d 2.0 N47, 330i 2.0 B48, 340i 3.0 Sport B58 (2015-), F34 320i GT, 320d GT N47D20C, 328i GT N20B20A, N26B20A, 335i GT N55B30A (2012-), F34 Gran Turismo 320i 2.0 N20, 320d 2.0 B47 (2012-)
<b>PQ851</b>	Rear Wheel Bearing Kit	BMW 3 Series F30/1 316i N13B16A, 320i 2.0 N20, 328i 2.0 N20, 330d 3.0 N57D30A, 335i 3.0 N55B30A (2012-), F30 318i 1.5 F30N B38 320i 2.0 B48, 320d 2.0 N47, 330i 2.0 B48, 340i 3.0 Sport B58 (2015-), F34 320i GT, 320d GT N47D20C, 328i GT N20B20A, N26B20A, 335i GT N55B30A (2012-), F34 Gran Turismo 320i 2.0 N20, 320d 2.0 B47 (2013-)
<b>PQ852</b>	Front Wheel Bearing Kit	BMW 5 Series E39 523i 2.5 M52, 525i 2.5 M54, 528i 2.8 M52, 530i, d 3.0 M54/ M57, 540i 4.4 M62 (98-04), E60/ 61 520d 2.0 N47, 523i 2.5 N52 / N53, 525i 2.5 M54 / N52, 530i M54 / N52, 530d 3.0 M57 (04-10)
<b>PQ853</b>	Rear Wheel Bearing Kit	Renault Megane I 1.6 Classic RXE, RT, RXT, RSi Coupe, RN Hatch, RT Coupe, Hatch, RXE, RXi Cabriolet K7M700/ 02-03 (96-02), Scenic I 1.4 RTE, 1.6 RT, RXE, 1.9 dCi, 2.0 RXE, Rxi (98-02)



## BUYERS GUIDE - BEARING KITS

<b>PQ854</b>	Rear Wheel Bearing Kit	Ford Focus II 1.6 Si, Ambiente, Trend., 2.0 Si, Trend., TDCi Ghia, TDCi Si., 2.5 ST. HYDA (05-09), Volvo S40 1.8 Sedan, 2.0 Sedan, 2.0D VS Sedan D4204T, 2.4 VS D5 Sedan D5252 T16/ D5244 T3, 2.4i B5244S4, 2.5i D5 Sedan Man Geartronic (2004-)
<b>PQ855</b>	Front Wheel Bearing Kit	Ford Mondeo 2.0 CJBA, CJBB, 3.0 ST220 MEBA (02-07)
<b>PQ856</b>	Rear Wheel Bearing Kit	Ford Mondeo 2.0 CJBA, CJBB, 3.0 ST220 MEBA (02-07)
<b>PQ857</b>	Rear Wheel Bearing Kit	Jeep Cherokee (KJ) 2.4 KJ EDI, 2.5CRD KJ R425, 2.8CRD KJ ENR, 3.7 KJ EKG (02-08), Grand Cherokee 2.7CRD ENF, 3.0CRD EXL, 3.6 ERB, 3.7 V6 EKG, 4.7 V8 EVC, EVA, 5.7 EZB (05-12)
<b>PQ858</b>	Rear Wheel Bearing Kit	Toyota Rav4 III 2.0i 1AZ-FE GX, VX, Fierce SUV, 2.2i D-4D 2AD-FTV GX, VX SUV - 4X4 (06-13), Rav4 IV 2.0, 2.2D 2AD-FTV, 2.5 2AR-FE - 4X4 (2013-) - Use PQ1016
<b>PQ859</b>	Rear Wheel Bearing Kit	Daihatsu Terios 1.3 SUV K3-VE, 1.5i Off-Road, 5/7 Seater SUV 3SZ-VE, 1.5 - 4X2, 4X4 (02-15), Toyota Avanza 1.3i P/Van, S, SX MPV K3VE, 1.5i SX, TX MPV 3SZVE (06-12)
<b>PQ860</b>	Front Wheel Bearing Kit	BMW 5 Series F07, F10/ F11, F18 520d, GT, 523i, 528i, 530d, GT, 535i, GT, 535d (2011-)
<b>PQ861</b>	Rear Wheel Bearing Kit	BMW 5 Series F07, F10/ F11, F18 520d, GT, 523i, 528i, 530d, GT, 535i, GT, 535d (2011-)
<b>PQ862</b>	Front Wheel Bearing Kit	Jeep Cherokee (KJ) 2.4 KJ EDI, 2.5CRD KJ R425, 2.8CRD KJ ENR, 3.7 KJ EKG (05-08)
<b>PQ863</b>	Front Wheel Bearing Kit	Jeep Cherokee (KJ) 2.4 KJ EDI, 2.5CRD KJ R425, 2.8CRD KJ ENR, 3.7 KJ EKG (05-08)
<b>PQ865</b>	Rear Wheel Bearing Kit	Toyota Fortuner 3.0 D-4D SUV 1KD-FTV, 4.0 V6, Epic SUV 1GR-FE Pet. - 4X2, 3.0 D-4D SUV 1KD-FTV, 4.0 V6, Epic SUV 1GR-FE - 4X4 (06-09), Hilux "VIGO" 2.0i U16/17 S/Cab, S, SRX LWB Pet. P/up 1TR-FE Pet., 2.5TDi D-4D S/Cab, S, SRX, S/Cab, S/Cab SRX HO, Raised Body Raider, D/Cab LWB 2KD-FTV, 3.0 D-4D TDi Raider, D/C Raider, Raised Body LWB P/up 1KD-FTV Dies., 4.0i D/Cab Raider Raised Body LWB P/up GR-FE Pet. - 4X2, 3.0 D-4D TDi D/C Raider 1KD-FTV Dies., LWB P/up, 4.0 D/Cab Raider 1GR-FE Pet. LWB P/up - 4X4 (05-09), 2.7i S/Cab Raider, D/Cab Raider, S/Cab HO Raised Body LWB P/up 2TR-FE Pet. - 4X2 (05-11), 2.5TDi D-4D S/Cab, D/Cab SRX, Legend40 2KD-FTV Dies. LWB P/up, 2.7i S/Cab SRX, Legend40 2TR-FE Pet. LWB P/up - 4X4 (15-15)
<b>PQ866</b>	Rear Wheel Bearing Kit	Honda Accord VII 2.0i V-Tec, 2.4i V-Tec (03-08)
<b>PQ867</b>	USE PQ1063	
<b>PQ868</b>	Rear Wheel Bearing Kit	Honda Civic VIII 1.8i VTEC EXi, LXi, VXi, R18A2, 2.0i VTEC Type R, K20Z4, 2.2CTDi Vxi (07-13), Civic IX 1.8i VTEC R18Z4 (2012-)
<b>PQ869</b>	Rear Wheel Bearing Kit	Hyundai Accent LC 1.3 G4EH, 1.5 G4EK, 1.6 G4ED (00-06)
<b>PQ870</b>	Rear Wheel Bearing Kit	Hyundai Accent MC 1.6 G4ED (06-11), Accent MC 1.6 G4ED (2011-), Getz 1.3 G4EA, 1.4i G4EE, 1.5 D3EA, D4FA, 1.6 G4ED-G (03-12), i10 PA 1.1 G4HG, 1.2 G4LA (08-15), Grand i10 1.1 G3LA (2017-), 1.2 G4LA (2014-), i20 PB/PBT 1.2 G4LA, 1.4 G4FA, 1.6 G4FC (2009-), Kia Picanto 1.1 LX, EX 5 Dr. H/back G4HG (04-11), Rio II 1.4 High, A5D, 1.6 Sport G4ED (2004-)
<b>PQ871</b>	Rear Wheel Bearing Kit	Hyundai Terrecan 2.9CRDi, 3.5i V6 SUV (03-08)
<b>PQ872</b>	USE PQ788	
<b>PQ873</b>	Rear Wheel Bearing Kit	Kia Carens 2.0 CVVT, 2.0 CRDi (2008-)
<b>PQ874</b>	Rear Wheel Bearing Kit	Kia Rio II 1.4 High, A5D, 1.6 Sport G4ED (2004-)
<b>PQ875</b>	Rear Wheel Bearing Kit	Mercedes-Benz W169 A-Class A170 M266.940, A180 M266.940, A180 CDi OM640.940, A200 M266.960 (05-13), W245 B-Class B170, B180, B200 CDI, Turbo (05-12)
<b>PQ876</b>	Rear Wheel Hub Bearing Kit	Mercedes-Benz W211 E-Class E200, K M111.941/956, E230 M111.970, E240 M112.911, E280 M112.921, E320 M112.941, E320CDi OM646.961, E350 M272.964, E500 M113.967 (96-10), W212 E-Class E200, Cgi, E250, CDi, Cgi, E350, Cdi, E400, E500 (2009-)
<b>PQ877</b>	Rear Wheel Bearing Kit	Iveco Turbo Daily 2.3 Turbo 35.10, 35.12 (1998-)
<b>PQ878</b>	Rear Wheel Bearing Kit	Iveco Turbo Daily 2.3 Turbo 35.10, 35.12 (1998-)
<b>PQ879</b>	Rear Wheel Bearing Kit	Isuzu KB200i 2.0 LX, KB240i 2.4 LX (04-12), KB250i 2.5 LX - 4X2, 4X4 (04-09), KB250Dc 2.5, KB300TDi 3.0 LX - 4X2, 4X4 (04-09), KB300TDi 3.0 D-TEQ - 4X2, 4X4 (07-11)
<b>PQ880</b>	Rear Wheel Bearing Kit	Tata Bolt 1.2T XMS, XT (2015-), Indica / Vista 1.4 LEi, LSi, LX, Lxi, 1.4TDi DLX, DLS, Indigo 1.4 GLS S/W, 1.4TDi DLX S/W (2005-)
<b>PQ881</b>	Rear Wheel Bearing Kit	Hyundai Atos 1.0 Prime G4HC (00-05), 1.1 G4HG (2005-)
<b>PQ882</b>	USE PQ791	
<b>PQ883</b>	Rear Wheel Bearing Kit	Citroen C4 1.6 VTR Coupe' TU5JP4, 1.6 Hdi DV6TED4, 2.0i VTS Coupe' EW10J4S (05-10), Peugeot 307 1.6 Estate, X-Line, XR, XT TU5JP4, HDi, X-Line HDi, XS HD EW10J4, 2.0 CC, CC 100/ 130/ 180, XS, S/W EW10J4 XS HDi DW10TD (04-06)
<b>PQ884</b>	Rear Wheel Bearing Kit	Nissan Patrol Y60 3.0 VG30E - 4X4 (95-00), Y61 3.0Di, 4.2 TD42 - 4X4 (99-04)
<b>PQ885</b>	Rear Wheel Bearing Kit	BMW X5 E53 3.0d SUV M57N - 4X4 (01-06), X5 E53 3.0i SUV M54 - 4X4 (2001-), X5 E53 4.4i SUV N62, 4.8iS SUV N62 - 4X4, X5 E53 4.6iS SUV M62 - 4X4 (2002-)

## BUYERS GUIDE - BEARING KITS

<b>PQ886</b>	Front Wheel Bearing Kit	BMW X5 E70 3.0d SUV M57N - 4X4 (2007-), X5 E70 3.0i SUV M54 - 4X4 (2001-), X5 E70 4.4i SUV N62, 4.8iS SUV N62 - 4X4, X5E70 4.6iS SUV M62 - 4X4 (2002-)
<b>PQ887</b>	Rear Wheel Bearing Kit	BMW X5 E70 3.0d SUV M57N - 4X4 (2007-), X5 E70 3.0i SUV M54 - 4X4 (2001-), X5 E70 4.4i SUV N62, 4.8iS SUV N62 - 4X4, X5E70 4.6iS SUV M62 - 4X4 (2002-), X5 xDrive F15 30d 3.0 N57, 35i 3.0 N55, 40d 3.0 N57, 50i 4.4 N63 - 4X4 (2013-)
<b>PQ888</b>	Front Wheel Bearing Kit	Kia Sportage JA 2.0 SUV 5 Spd. FE Pet. - 4X4 (98-03)
<b>PQ889</b>	Front Wheel Bearing Kit	Hyundai Sonata Y3 2.0 G4CP, 2.5 V6 G6BV, 3.0 V6 G6AT (96-02)
<b>PQ890</b>	Rear Wheel Bearing Kit	Hyundai Tiburon 2.0, 2.7 (02-09)
<b>PQ891</b>	Rear Wheel Bearing Kit	Nissan X-Trail T30 2.0 QR20DE MPV, 2.0 MPV 20DE, 2.2D SE, SEL MPV, 2.5 25DE MPV - 4X2 (01-09)
<b>PQ892</b>	Rear Wheel Bearing Kit	Mazda 3 (BL, BK) 1.6 Original, Active, Dynamic B6ZE, Z6, 2.0 Individual LF17, 2.0 BN, 2.3, 2.3 MPS L6KG, 2.5 L5-VE (04-14), 5 2.0 Original, Active, Individual (07-14)
<b>PQ893</b>	Front Wheel Bearing Kit	Fiat Stilo 1.9 - Some Models (03-09)
<b>PQ894</b>	Front Wheel Bearing Kit	Fiat Stilo 1.9 - Others - Alt. (03-09)
<b>PQ895</b>	Front Wheel Bearing Kit	Fiat Strada 1.2 EL P/up, 1.4, 1.6 EL, EL Sporting, ELX P/up, 1.7D EL P/up (05-10)
<b>PQ896</b>	Rear Wheel Bearing Kit	Toyota Fortuner 3.0 D-4D SUV 1KD-FTV, 4.0 V6, Epic SUV 1GR-FE Pet - 4X2, 4X4 (09-11), 2.5D-4D 2KD-FTV, 3.0D-4D 1KD-FTV, 4.0 V6 1GR-FE, 4.0 V6 Raised Body 1GR-FE - 4X2, 4X4 (11-16), Hilux "Vigo" 2.5TDi D-4D S/Cab, D/Cab SRX, Legend40 2KD-FTV Dies. LWB P/up, 2.7i S/Cab SRX, Legend40 2TR-FE Pet. LWB P/up, 3.0D-4D TDi D/C xtra cab, Raider, Legend40 1KD-FTV Dies. LWB, 4.0 D/Cab Raider, 1GR-FE Pet. - 4X4 (2009-), 2.0i S/Cab, S, SRX LWB Pet. P/up 1TR-FE Pet., 2.5TDi D-4D S/Cab, S, SRX, S/Cab, S/Cab SRX HO, Raised Body Raider, D/Cab LWB P/up 2KD-FTV, 2.7i Raised Body Raider, D/Cab LWB P/up 2TR-FE Pet. (09-11)
<b>PQ897</b>	Front Wheel Bearing Kit	Chevrolet Cruze 1.6 L, LS F16D3, 1.8 LS, LT F18D4, 2.0D LT Z20S1 (09-15), Opel Astra J 1.4T, 1.6i (2010-)
<b>PQ898</b>	Front Wheel Hub Bearing Kit	Chevrolet Cruze 1.6 L, LS F16D3, 1.8 LS, LT F18D4, 2.0D LT Z20S1 (09-15), Orlando 1.8 F18D4 (2011-), Opel Astra J 1.4T, 1.6i (2010-)
<b>PQ899</b>	Front Wheel Bearing Kit	Mazda 3 (BL, BK) 1.6 Original, Active, Dynamic B6ZE, Z6, 2.0 Individual LF17, 2.0 BN, 2.3, 2.3 MPS L6KG, 2.5 L5-VE (04-14)
<b>PQ900</b>	USE PQ683	
<b>PQ901</b>	Rear Wheel Bearing Kit	Ford Fiesta III 1.0 Ecoboost, 1.4 Sedan, 1.4i Ambiente', Trend, Titanium, 1.6 Limited, 1.6i Ambiente', Sport, Trend, Titanium, TDCi, 1.6 Gtdi (2008-), Mazda 2 (DE) 1.3 Active, Dynamic, 1.5 Dynamic, Individual (07-15)
<b>PQ902</b>	Rear Wheel Bearing Kit	Nissan Almera 1.6 Comfort, Elegance, Luxury 16DE/GA16DE, 1.8 Elegance, Luxury, 18DE (01-06) - Alt. To PQ699
<b>PQ903</b>	Front Wheel Bearing Kit	Isuzu KB200i 2.0 LX, KB240i 2.4 LX, KB250i 2.5 LX - 4X2, 4X4, KB250Dc 2.5, KB300TDi 3.0 LX - 4X2, 4X4 (04-09), KB300TDi 3.0 D-TEQ (07-11)
<b>PQ904</b>	Front Wheel Bearing Kit	Mitsubishi Lancer 1.6 GLX 4G18, 2.0 GLS 4G63, Outlander 2.4 GLS MPV & SUV 4G69 - 4X4 (03-08)
<b>PQ905</b>	Rear Wheel Bearing Kit	Mitsubishi Lancer 1.6 GLX 4G18, 2.0 GLS 4G63 (03-08)
<b>PQ906</b>	Rear Wheel Bearing Kit	Mitsubishi Lancer 1.6 GLX 4G18, 2.0 GLS 4G63 (03-08)
<b>PQ907</b>	Rear Wheel Bearing Kit	Mitsubishi Outlander 2.4 GLS MPV & SUV 4G69 - 4X4 (03-08)
<b>PQ908</b>	Rear Wheel Bearing Kit	Chevrolet Cruze 1.6 L, LS F16D3, 1.8 LS, LT F18D4, 2.0D LT Z20S1 (09-15), Opel Astra J 1.4T, 1.6i (2010-)
<b>PQ909</b>	Rear Wheel Bearing Kit	Chevrolet Cruze 1.6 L, LS F16D3, 1.8 LS, LT F18D4, 2.0D LT Z20S1 (09-15), Orlando 1.8 F18D4 (2011-), Opel Astra J 1.4T, 1.6i (2010-)
<b>PQ910</b>	Front Wheel Bearing Kit	Chevrolet Captiva 2.0D LTZ Z20S, 2.4 LT Z24SED, 3.2 LTZ 10HM - 4X2, 4X4 (07-11), 2.2D LTZ 5-dr Dsl AWD AT., 2.2D LT 5-dr Dsl AT. LNQ, 2.4 LT, LS 5-dr LE5, 3.0 LTZ 5-dr AWD AT. (11-17)
<b>PQ911</b>	Rear Wheel Bearing Kit	Chevrolet Captiva 2.0D LTZ Z20S, 2.4 LT Z24SED, 3.2 LTZ 10HM - 4X2, 4X4 (07-11), 2.2D LTZ 5-dr Dsl AWD AT., 2.2D LT 5-dr Dsl AT. LNQ, 2.4 LT, LS 5-dr LE5, 3.0 LTZ 5-dr AWD AT. (11-17)
<b>PQ912</b>	Rear Wheel Bearing Kit	BMW 1 Series E87 116i 1.6 N45, 118i 2.0 N46, 120i 2.0 N46, 120d 2.0 N47, 130i 3.0 N52 (04-15), F20/1 116i 1.6 N13, 118i 2.0 N13, 120d 2.0 N47, 125i 2.0 N20 (11-16), 3 Series E90 320d 2.0 Sedan & Touring, Start M47, 320i 2.0 Sedan & Touring, Start N46, 323i 2.5 Sedan & Touring, Start N52, 325i 2.5 Sedan & Touring, Start N52 (05-13), F30/1 316i N13B16A, 320i 2.0 N20, 328i 2.0 N20, 330d 3.0 N57D30A, 335i 3.0 N55B30A (2012-), F34 320i GT, 320d GT N47D20C, 328i GT N20B20A, N26B20A, 335i GT N55B30A (2012-), F30 318i 1.5 F30N B38 320i 2.0 B48, 320d 2.0 N47, 330i 2.0 B48, 340i 3.0 Sport B58 (2015-)
<b>PQ913</b>	Rear Wheel Bearing Kit	Honda FR-V 1.8i R18A1 (07-10)

## BUYERS GUIDE - BEARING KITS

<b>PQ914</b>	USE PQ923	
<b>PQ914A</b>	USE PQ923	
<b>PQ915</b>	Front Wheel Bearing Kit	Ford Ranger T6 2.2 D HP, MP, 3.2 D Wildtrack, TDCi - 4X4 - 4X2 (2012-), Mazda BT-50 3.2 MZ-CD P5-AT - 4X4 (2012-)
<b>PQ916</b>	Front Wheel Bearing Kit	Nissan Navara & Pathfinder D40/ R51 2.5DCi D/Cab P/up, 3.0DCi V6, 4.0i V6, LE D/Cab P/up - 4X4 (05-17) (For Vehicles Manufactured In The Phillippines & Thailand)
<b>PQ917</b>	Rear Wheel Bearing Kit	Nissan Navara D40 Series 2.5DCi, LE, SE, XE D/Cab P/up, 4.0i V6, LE D/Cab P/up (05-17), Pathfinder D40/ R51 2.5DCi D/Cab P/up, 3.0DCi V6, 4.0i V6, LE D/Cab P/up - 4X4 (05-17)
<b>PQ918</b>	Rear Wheel Bearing Kit ASB	Honda CR-V III 2.0 i-VTEC R20A1, 2.2 i-CTDi N22A2, 2.2 i-DTEC N22B3, 2.4 i-Vtec K24Z1, K24Z4 - 4X4 (09-12), CR-V IV 2.0 R20A6, 9, 2.0 i-VTEC R20A5, 6, 9, 2.2 i-DTEC N22B4, 2.4i K24Z9 - 4X2, 4X4 (2012-)
<b>PQ919</b>	Front Wheel Bearing Kit ASB	Honda CR-V II 2.0 K20A4 - 4X4 (05-09), CR-V III 2.0 i-VTEC R20A1, 2.2 i-CTDi N22A2, 2.2 i-DTEC N22B3, 2.4 i-Vtec K24Z1, K24Z4 - 4X4 (09-12), CR-V IV 2.0 R20A6, 9, 2.0 i-VTEC R20A5, 6, 9, 2.2 i-DTEC N22B4, 2.4i K24Z9 - 4X2, 4X4 (2012-)
<b>PQ920L</b>	Rear Wheel Bearing Kit	Honda CR-V 2.0 5 Dr. SUV B20Z1 CR-V CTDi - 4X4 (97-02)
<b>PQ920R</b>	Rear Wheel Bearing Kit	Honda CR-V 2.0 5 Dr. SUV B20Z1 CR-V CTDi - 4X4 (97-02)
<b>PQ921</b>	Front Wheel Bearing Kit	Honda CR-V 2.0 5 Dr. SUV B20Z1 CR-V CTDi - 4X4 (97-02)
<b>PQ922</b>	Rear Wheel Bearing Kit ASB	BMW 1 Series F20/1 116i 1.6 N13, 118i 2.0 N13, 120d 2.0 N47, 125i 2.0 N20 (11-16), 3 Series E90 323i 2.5 Sedan & Touring, Start N52, 325i 2.5 Sedan & Touring, Start N52 (05-13), 330Ci, d 3.0 Convertible N52 / M57, 335i, d 3.0 N54 / N55 (05-11), F30/1 316i N13B16A, 320i 2.0 N20, 328i 2.0 N20, 330d 3.0 N57D30A, 335i 3.0 N55B30A (2012-), F34 320i GT, 320d GT N47D20C, 328i GT N20B20A, N26B20A, 335i GT N55B30A (2012-)
<b>PQ923</b>	Front Wheel Bearing Kit	Daihatsu Gran Max 1.5 I 3SZ-VE (2009-), Terios 1.3 SUV K3-VE, 1.5i Off-Road, 5/7 Seater SUV 3SZ-VE, 1.5 - 4X2, 4X4 (02-15), Toyota Avanza 1.3i P/Van, S, SX MPV K3VE, 1.5i SX, TX MPV 3SZVE (2011-), 1.3 S, SX MPV 3K3VE, 1.3 S P/Van 3K3VE, 1.5 SX, TX MPV 3SZVE (12-16), 1.3 S, SX MPV 1NRVE, 1.3 S P/Van 1NRVE, 1.5 SX, TX MPV 2NRVE (2015-) Double Row Angular Contat
<b>PQ926</b>	Front Wheel Bearing Kit	Geely MK 1.5 MR479QA, 1.6 MR481QA (2010-), GWM CB150 1.5 VVT (10-13), Florid 1.5i, 1.5 Cross (09-13)
<b>PQ927</b>	Front Wheel Bearing Kit	Mazda 6 2.0 Active, Original, Elegant, 2.3 Dynamic, Dynamic Individual, Sporty, Sporty Lux, 2.3 MPS AWD, 2.5 Dynamic Activematic, Individual (03-14), MX-5 2.0 (05-14)
<b>PQ928</b>	Front Wheel Bearing Kit	Mazda 3 (BL, BK) 1.6 Original, Active, Dynamic B6ZE, Z6, 2.0 Individual LF17, 2.0 BN Series, 2.3, 2.3 MPS L6KG, 2.5 L5-VE (04-14), 5 2.0 Original, Active, Individual (07-14), 6 2.0 Active, Original, Elegant, 2.3 Dynamic, Dynamic Individual, Sporty, Sporty Lux, 2.3 MPS AWD, 2.5 Dynamic Activematic, Individual (03-14)
<b>PQ929</b>	Front Wheel Bearing Kit	Toyota Rav4 II ZCA20 1.8 SUV 1ZZFE, ACA20 2.0 SUV 1AZ-FE - 4X2, 4X4 (02-06)
<b>PQ930</b>	Front Wheel Bearing Kit	Honda Jazz 1.3 i-VTEC LX Man., Auto., 1.4i L13Z1, 1.5 i-VTEC EX L15A (07-15)
<b>PQ931</b>	Rear Wheel Hub Bearing Kit	BMW X1 xDrive E84 18i 2.0 N46, 20i 2.0 N20, 20d 2.0 N47, 23d 2.0 N47, 25d 2.0 47, 28i 2.0 N20 - 4X4 (09-15)
<b>PQ932</b>	Front Wheel Hub Bearing Kit	BMW X1 xDrive E84 18i 2.0 N46, 20i 2.0 N20, 20d 2.0 N47, 23d 2.0 N47, 25d 2.0 47, 28i 2.0 N20 - 4X4 (09-15)
<b>PQ933</b>	Rear Wheel Hub Bearing Kit	BMW X3 xDrive F25 20i 2.0 N20, 20d 2.0 B47/ N47, 28i 2.0 N20, 30d 3.0 N57, 35i 3.0 N55 - 4X4 (2010-)
<b>PQ934</b>	Front Wheel Hub Bearing Kit	BMW X3 xDrive F25 20i 2.0 N20, 20d 2.0 B47/ N47, 28i 2.0 N20, 30d 3.0 N57, 35i 3.0 N55 - 4X4 (2010-)
<b>PQ935</b>	Front Wheel Bearing Kit	BMW X5 xDrive F15 30d 3.0 N57, 35i 3.0 N55, 40d 3.0 N57, 50i 4.4 N63 - 4X4 (2013-)
<b>PQ936</b>	Rear Wheel Bearing Kit	BMW X5 30D (10-14)
<b>PQ937</b>	Front Wheel Bearing Kit	Chrysler Neon 1.8 PL, 2.0 PL, 2.0i R/T (02-06), PT-Cruiser 2.0 ECC Pet., 2.2 CRD, EDJ Dies., 2.4 ED2 Pet. (02-09)
<b>PQ939</b>	Front Wheel Bearing Kit	Chrysler Voyager 2.4 SE MPV, 2.4 SWB, 3.3 SWB (02-07), Grand Voyager 2.8 CRD, 3.3, 3.8 (2002-)
<b>PQ940</b>	Rear Wheel Bearing Kit	Chrysler Voyager 2.4 SE MPV, 2.4 SWB, 3.3 SWB (02-07), Grand Voyager 2.8 CRD, 3.3, 3.8 (2002-)
<b>PQ941</b>	Front Wheel Bearing Kit	Chrysler Grand Voyager 2.8 CRD, 3.8 (2002-)
<b>PQ942</b>	Front Wheel Bearing Kit	Chrysler Grand Voyager 2.8 CRD, 3.8 - Alt. (2002-)
<b>PQ943</b>	Rear Wheel Bearing Kit	Chrysler Grand Voyager 2.8 CRD, 3.8 (2002-)
<b>PQ944</b>	Rear Wheel Bearing Kit	Chrysler Grand Voyager 2.8 CRD, 3.8 - Alt. (2002-)
<b>PQ945</b>	Front Wheel Bearing Kit	Daihatsu Materia 1.5 (07-11)

## BUYERS GUIDE - BEARING KITS

<b>PQ946</b>	Front Wheel Bearing Kit	Dodge Nitro 2.8 CRD ENS, 3.7 EKD - 4X4 (07-10), Jeep Cherokee (KJ) 2.8CRD KJ ENS, 3.7 KJ EKG (08-15)
<b>PQ947</b>	Rear Wheel Bearing Kit	Dodge Nitro 2.8 CRD ENS, 3.7 EKD - 4X4 (07-10), Jeep Cherokee (KJ) 2.8CRD KJ ENS, 3.7 KJ EKG (08-15), Wrangler (JK) 2.8CRD JK ENS, 3.6 JK ERB, 3.8 JK EGT, 4.0 TJ S01 (2002-)
<b>PQ948</b>	Front Wheel Bearing Kit	Kia Picanto 1.0 G3LA, 1.2 G4LA (2011-)
<b>PQ949</b>	Front Wheel Bearing Kit	Ford Ranger T6 2.2 D HP, MP, 2.5, 3.2 D Wildtrack, 3.2 TDCi - 4X2, 2.2 D HP, MP, 2.2 D MP - 4X4 (2012-), Mazda BT-50 2.2 MZ-CD P4-AT, 2.5 MZI L5-Y3, 3.2 MZ-CD P5-AT - 4X2 (2012-)
<b>PQ950</b>	Rear Wheel Bearing Kit	Hyundai Elantra MD/UD 1.6 G4FG, 1.8 G4NB (11-16), i30 FD/GD 1.6 G4FG, G4GG, 1.8 G4NB, 2.0 G4GC-G (2010-), Veloster 1.6 GDi G4FD, G4FJ (2013-)
<b>PQ951</b>	Rear Wheel Bearing Kit	Citroen C4 Aircross 1.6 VTi EP6C, 1.6 e-Hdi, 2.0i Aircross 4B11 (10-15), Jeep Compass 2.0 ECN, 2.4 ED3, ERZ (2007-), Patroit 2.0CRD ECD, ECE, 2.4 ED3 (2007-), Mitsubishi Outlander 2.4 4B12 - 4X4 (07-14)
<b>PQ952</b>	Front Wheel Bearing Kit	Jeep Grand Cherokee 2.7CRD ENF, 3.0CRD EXL, 3.6 ERB, 3.7 V6 EKG, 4.7 V8 EVC, EVA, 5.7 EZB (05-12)
<b>PQ953</b>	Front Wheel Bearing Kit	Jeep Grand Cherokee 2.7CRD ENF, 3.0CRD EXL, 3.6 ERB, 3.7 V6 EKG, 4.7 V8 EVC, EVA, 5.7 EZB (05-12)
<b>PQ954</b>	Rear Wheel Bearing Kit	Jeep Grand Cherokee 2.7CRD ENF, 3.0CRD EXL, 3.6 ERB, 3.7 V6 EKG, 4.7 V8 EVC, EVA, 5.7 EZB (05-12)
<b>PQ955</b>	Front Wheel Bearing Kit	Jeep Grand Cherokee 3.7 V6 EKG (05-12)
<b>PQ956</b>	Rear Wheel Bearing Kit	Jeep Grand Cherokee 3.7 V6 EKG (05-12)
<b>PQ957</b>	Front Wheel Bearing Kit	Jeep Wrangler (JK) 2.8CRD JK ENS, 3.6 JK ERB, 3.8 JK EGT, 4.0 TJ S01 (2002-)
<b>PQ958</b>	Rear Wheel Bearing Kit	Jeep Wrangler (JK) 2.8CRD JK ENS, 3.6 JK ERB, 3.8 JK EGT, 4.0 TJ S01 (2002-)
<b>PQ959</b>	Front Wheel Bearing Kit	Jeep Wrangler (JK) 2.8CRD JK ENS, 3.6 JK ERB, 3.8 JK EGT, 4.0 TJ S01 (2011-)
<b>PQ960</b>	Rear Wheel Bearing Kit	Kia Cerato 1.6 LX G4FC, 2.0 G4KD (2008-)
<b>PQ961</b>	Rear Wheel Bearing Kit	Kia Sedona 2.2 CRDi D4HB, 2.5, 2.9 CRDi J3, 3.8 KV6 (04-13)
<b>PQ962</b>	Rear Wheel Bearing Kit	Kia Picanto 1.0 G3LA (2011-)
<b>PQ963</b>	Front Wheel Bearing Kit	Hyundai Accent RB 1.6 G4FC (2011-), i20 PB/PBT 1.2 G4LA, 1.4 G4FA, 1.6 G4FC (2009-), Kia Rio III 1.2 CVVT G4LA, 1.4 G4FA (2011-)
<b>PQ964</b>	Front Wheel Bearing Kit	Kia Sedona 2.2 CRDi D4HB, 2.5, 2.9 CRDi J3, 3.8 KV6 (04-13)
<b>PQ965</b>	Front Wheel Bearing Kit	Kia Sorento 2.5 CRDi D4CB - 4X2, 4X4 (03-10)
<b>PQ966</b>	Rear Wheel Bearing Kit	Kia Sorento 2.5 CRDi D4CB - 4X2, 4X4 (03-10)
<b>PQ967</b>	Front Wheel Bearing Kit	Land Rover Discovery II 2.5 TD5, 4.0 V8 (99-05)
<b>PQ968</b>	Rear Wheel Bearing Kit	Land Rover Discovery II 2.5 TD5, 4.0 V8 (99-05)
<b>PQ969</b>	Front Wheel Bearing Kit	Land Rover Discovery III 2.5 TD V6, 2.7 TD V6, 4.0 V6, 4.4 V8, Discovery IV 3.0D V6, 3.0SD V6, 3.0TD V6, 5.0 V8, 5.0P V8 (05-09)
<b>PQ970</b>	Rear Wheel Bearing Kit	Land Rover Discovery III 2.5 TD V6, 2.7 TD V6, 4.0 V6, 4.4 V8, Discovery IV 3.0D V6, 3.0SD V6, 3.0TD V6, 5.0 V8, 5.0P V8 (05-09), Range Rover Sport 3.0 D V6, 3.0 TD, 3.6 V8, 3.6 TD V8, 4.2, 4.4 V8, 5.0 V8 (2005-)
<b>PQ971</b>	USE PQ504ASB	
<b>PQ972</b>	Front Wheel Bearing Kit	Land Rover Freelander II 2.0, 2.2 D, 2.2 TD4, 3.2 V6 (2007-)
<b>PQ973</b>	Front & Rear Wheel Bearing Kit	Land Rover Range Rover 3.0TD, 3.6 D V8, 3.6 TD, 4.2 V8, 4.4 V8, 4.4D V8, 5.0 V8 (2002-), Evoque 2.0 Si4, 2.2 Sd4 (2011-)
<b>PQ974</b>	Rear Wheel Bearing Kit	Land Rover Range Rover Evoque 2.0 Si4, 2.2 Sd4 (2011-)
<b>PQ975</b>	Front & Rear Wheel Bearing Kit	Lexus GS, IS 200, 250, 300, 350, 450 (2002-)
<b>PQ976</b>	Front Wheel Bearing Kit	Lexus GS, IS 300 (02-05)
<b>PQ977L</b>	Front Wheel Bearing Kit	Lexus GS, IS 200, 250, 350, 450 (06-13)
<b>PQ977R</b>	Front Wheel Bearing Kit	Lexus GS, IS 200, 250, 350, 450 (06-13)
<b>PQ978</b>	Rear Wheel Bearing Kit	Lexus GS, IS 200, 250, 300, 350, 450 (06-13)
<b>PQ979</b>	Rear Wheel Bearing Kit	Lexus GS, IS 200, 250, 300, 350, 450 (02-05)
<b>PQ980</b>	Rear Wheel Bearing Kit	Lexus RX 300, 350, 400, 450 (2003-)
<b>PQ981</b>	Front Wheel Bearing Kit	Mahindra Bolero 2.5 TD XD3, 2.5 TD NEF - 4X2, 4X4 (2005-), Scorpio 2.0, 2.2, 2.2 CRDE, 2.5 NEF, 2.6 Turbo, 2.6 TD /CRDE - 4X2, 4X4 (2005-), Scorpio P/up 2.2 CRDE, 2.5, 2.5 TD, 2.5 NEF Tci (2006-)



## BUYERS GUIDE - BEARING KITS

<b>PQ982</b>	Front Wheel Bearing Kit	Mazda 6 (GJ) 2.0 PEY5 (14-16), 2.2D SHY1 (14-17), 2.5 PYY1, PYZA, PYY8 (14-16), CX-5 2.0 PEY4 (12-15)
<b>PQ983</b>	Rear Wheel Bearing Kit	Mazda 3 (BL, BK) 1.6 Original, Active, Dynamic B6ZE, Z6, 2.0 Individual LF17, 2.0 BN Series, 2.3, 2.3 MPS L6KG, 2.5 L5-VE (04-14), 3 (BM) 1.6 Z6Y1, 2.0 PEY7, PEX2 (2014-), 6 (GJ) 2.0 PEY5 (14-16), 2.2D SHY1 (14-17), 2.5 PYY1, PYZA, PYY8 (14-16), CX-5 2.0 PEY4 (12-15)
<b>PQ984</b>	Rear Wheel Bearing Kit	Mazda CX-5 2.0 PEY4 - 4X4 (12-15)
<b>PQ985</b>	Front Wheel Bearing Kit	Mercedes-Benz W176 A-Class A180, A180 Cdi, A200, A220 Cdi, A250 (2013-), W246 B-Class B180, B180 Cdi, B200, B200 Cdi, B250 (2012-)
<b>PQ986</b>	Rear Wheel Hub Bearing Kit	Mercedes-Benz W176 A-Class A180, A180 Cdi, A200, A220 Cdi, A250 (2013-), W246 B-Class B180, B180 Cdi, B200, B200 Cdi, B250 (2012-)
<b>PQ987</b>	Front Wheel Bearing Kit	Mercedes-Benz W212 E-Class E200, Cgi, E250, CDi, Cgi, E350, Cdi, E400, E500 (2009-)
<b>PQ988</b>	Front & Rear Wheel Bearing Kit	Mercedes-Benz W164 ML320CDi SUV OM642.940, ML350 SUV OM272.967, ML500 SUV OM273.963, ML63 AMG SUV M156.980 (2006-)
<b>PQ989</b>	Front Wheel Bearing Kit	Mercedes-Benz BM906 Sprinter 309, 311, 315, 318, 509, 511, 515, 518 Bus, P/van (2006-), VW Crafter 2.0 TDi, Bi-TDi "35", 2.0 TDi, Bi-TDi "50" (2012-)
<b>PQ990</b>	Rear Wheel Bearing Kit	Mercedes-Benz BM906 Sprinter 309, 311, 315, 318, 509, 511, 515, 518 Bus, P/van (2006-), VW Crafter 2.5TDi 35 Series SWB P/van, 50 HR Series LWB/ XLWB P/van - 4X4 (07-12)
<b>PQ991</b>	Front Wheel Bearing Kit	Mercedes-Benz Vito / Viano W639 2.2CDi, 3.0CDi, 3.5 V6 (2006-)
<b>PQ992</b>	Rear Wheel Bearing Kit	Mercedes-Benz Vito / Viano W639 2.2CDi, 3.0CDi, 3.5 V6 (2006-)
<b>PQ993</b>	USE PQ577	
<b>PQ993</b>	Rear Wheel Bearing Kit	Dodge Caliber 1.8 SE, SXT, EBE, 2.0 TD, SXT, CVT, ECN, 2.4 RT, SXT, EDA (06-12), Jeep Compass 2.0CRD (2007-), Mitsubishi ASX 2.0 4B11 (2011-), Lancer 1.5 4A91, 2.0 4B11, 2.0 EVO X AWD 4B11 T/C (2007-) - Use PQ577
<b>PQ994</b>	Front Wheel Bearing Kit	Mitsubishi Lancer 2.0 Evo X AWD 4B11 T/C (2007-)
<b>PQ995</b>	Rear Wheel Bearing Kit	Mitsubishi Lancer 2.0 Evo X AWD 4B11 T/C (2007-), Outlander 2.4 4B12 - 4X4 (07-14)
<b>PQ996</b>	Front Wheel Bearing Kit	Nissan Navara D40 Series 2.5DCi, LE, SE, XE D/Cab P/up, 4.0i V6, LE D/Cab P/up (05-17)
<b>PQ997</b>	Front Wheel Bearing Kit	Opel Astra H 1.9 CDTi Enjoy, GTC, CDTi, GTC CDTi Sport, 2.0 Coupe' Turbo, GSi, GTC Turbo, GTC Turbo OPC, GTC Turbo Sport, Turbo Sport, Twin top (04-10)
<b>PQ998</b>	Front Wheel Bearing Kit	Opel Vivaro 1.9CDTi P/Van, 2.0i P/van (06-15)
<b>PQ999</b>	Rear Wheel Bearing Kit	Citroen C4 Aircross 1.6 VTi EP6C, 1.6 e-Hdi, 2.0i Aircross 4B11 (10-15), Peugeot 308 1.6i X-Line, XS, XT, CC, S/W, XS Hdi, 1.6 VTi (10-13), 1.6 GTi (10-14), 2.0 Hdi (2008-), 308CC 1.6THP (10-14), 3008 1.6, 2.0 Hdi (2010), Partner 1.6 , Hdi, 1.9D, 2.0 HDI (03-10)
<b>PQ1000</b>	Rear Wheel Hub Bearing Kit	Citroen Berlingo 1.4 P/van TU3JP Pet., 1.6 TU5JP4B, 1.6Hdi 90LS DV6TED4BU, DV6AUTED4, 1.9D LWB P/van XUD9A Dies. (03-15), Picasso 1.6, 1.6Hdi, 1.8, 2.0, 2.0Hdi (05-06), Peugeot Partner 1.6 , Hdi, 1.9D, 2.0 HDI (03-10)
<b>PQ1001</b>	Front Wheel Bearing Kit	Peugeot Boxer 2.2Hdi P2ZDTE, 3.0Hdi F30DT, F1CE0481D, Boxer 350 2.8 8140.43S/ F28DTCR (01-08)
<b>PQ1002</b>	Front Wheel Bearing Kit	Renault Duster 1.5 DCi K9K, 1.6 K4M - 4X2, 4X4 (2013-), Fluence 1.6, 2.0 (11-16), Megane III 1.4Tce, 1.6, Dci (2010-), Scenic III 1.6, 1.9dCi (11-13)
<b>PQ1003</b>	Rear Wheel Bearing Kit	Renault Duster 1.5 DCi K9K - 4X4 (2013-)
<b>PQ1004</b>	Rear Wheel Bearing Kit	Renault Captur 0.9 Tce H4B400, 1.2 Tce H5F408, 1.5 Dci K9K (2016-), Duster 1.6 K4M - 4X2 (2013-), Kangoo 1.6 (11-13)
<b>PQ1005</b>	Rear Wheel Bearing Kit	Renault Kangoo 1.4 Multix Authentique MPV E7J780, 1.5DCi (03-10)
<b>PQ1006</b>	Rear Wheel Bearing Kit	Renault Kangoo 1.4 Multix Authentique MPV E7J780, 1.5DCi (03-10)
<b>PQ1007</b>	Front Wheel Bearing Kit	Renault Megane III 2.0 RB7, RS 250, RS 265 (2010-), Scenic III 1.6, 1.9dCi (11-13)
<b>PQ1008</b>	Front Wheel Bearing Kit	Renault Clio III 2.0 Sport, R27, Ltd. Edition F4R832/830 (2010-)
<b>PQ1009</b>	Front Wheel Bearing Kit	Subaru Forester2.0 D, X, XT, 2.5 S, X, XS, XT - AWD (2002-), Outback 2.0D, 2.5, 3.0R, 3.6R - AWD (2004-), Toyota 86 2.0 FA20D (2012-)
<b>PQ1010</b>	Rear Wheel Bearing Kit	Subaru Forester2.0 D, X, XT, 2.5 S, X, XS, XT - AWD (2002-), Outback 2.0D, 2.5, 3.0R, 3.6R - AWD (2004-), Toyota 86 2.0 FA20D (2012-)
<b>PQ1011</b>	Rear Wheel Bearing Kit	Toyota Camry II 2.4i Xli, 3.0 GLX 1MZ-FE (01-06)
<b>PQ1012</b>	Rear Wheel Bearing Kit	Toyota Camry II 2.4i Xli, 3.0 GLX 1MZ-FE (01-06)
<b>PQ1013</b>	Rear Wheel Bearing Kit	Toyota Land Cruiser HDJ200 4.5 D-4D, 4.6 V8, 4.7 V8 - 4X4 (2007-)
<b>PQ1014</b>	Rear Wheel Bearing Kit	Toyota Land Cruiser HDJ200 4.5 D-4D, 4.6 V8, 4.7 V8 - 4X4 (2007-)
<b>PQ1015</b>	Front Wheel Bearing Kit	Toyota Land Cruiser HDJ200 4.5 D-4D, 4.6 V8, 4.7 V8 - 4X4 (2007-)



## BUYERS GUIDE - BEARING KITS

<b>PQ1016</b>	Rear Wheel Bearing Kit	Toyota Rav4 III 2.0i 1AZ-FE GX, VX, Fierce SUV, 2.2i D-4D 2AD-FTV GX, VX SUV - 4X4 (06-13), Rav4 IV 2.0, 2.2D 2AD-FTV, 2.5 2AR-FE - 4X4 (2013-)
<b>PQ1017</b>	Rear Wheel Bearing Kit	Toyota Rav4 IV 2.0 - 4X2 (2013-)
<b>PQ1018</b>	Front Wheel Bearing Kit	VW Crafter 2.0 TDi, Bi-TDi "35", 2.0 TDi, Bi-TDi "50" (2012-)
<b>PQ1019</b>	Rear Wheel Bearing Kit	VW Crafter 2.0 TDi, Bi-TDi "35", 2.0 TDi, Bi-TDi "50" (2012-)
<b>PQ1020</b>	Front Wheel Bearing Kit	VW Crafter 2.5TDi 35 Series SWB P/van, 50 HR Series LWB/ XLWB P/van - 4X4 (07-14)
<b>PQ1021</b>	Front Wheel Bearing Kit	Nissan NV350 Impendulo 2.5 QR25DE, 2.5D YD25DDTi (2013-)
<b>PQ1021COMP</b>	Front Wheel Bearing Kit	Nissan NV350 Impendulo 2.5 QR25DE, 2.5D YD25DDTi (2013-)
<b>PQ1022</b>	Rear Wheel Bearing Kit	Nissan NV350 Impendulo 2.5 QR25DE, 2.5D YD25DDTi (2013-)
<b>PQ1023</b>	Front Wheel Bearing Kit	Subaru Forester2.0 D, X, XT, 2.5 S, X, XS, XT - AWD (2002-), Outback 2.0D, 2.5, 3.0R, 3.6R - AWD (2004-)
<b>PQ1024</b>	Rear Wheel Bearing Kit	Subaru Forester2.0 D, X, XT, 2.5 S, X, XS, XT - AWD (2002-), Outback 2.0D, 2.5, 3.0R, 3.6R - AWD (2004-)
<b>PQ1025</b>	Rear Wheel Bearing Kit	Subaru Outback 2.0D, 2.5, 3.0R, 3.6R - AWD (2004-)
<b>PQ1026</b>	Front Wheel Bearing Kit	Subaru Impreza 2.0 GX, R, RS, WRX, WRX STI, 2.5 RS, WRX, WRX STI - AWD (2004-)
<b>PQ1027</b>	Rear Wheel Bearing Kit	Subaru Impreza 2.0 GX, R, RS, WRX, WRX STI, 2.5 RS, WRX, WRX STI - AWD (2004-)
<b>PQ1028</b>	Front Wheel Bearing Kit	Suzuki Alto 1.0 K10B (09-15), Celerio 1.0 K10B (2015-)
<b>PQ1029</b>	Rear Wheel Bearing Kit	Suzuki Alto 1.0 K10B (09-15), Celerio 1.0 K10B (2015-)
<b>PQ1030</b>	Front & Rear Wheel Bearing Kit	Suzuki Grand Vitara 2.0 J2OA, 2.4 J2OA, 2.5 V6 H2S1, 3.2 V6 N32A - 4X4 (2002-)
<b>PQ1031</b>	Front Wheel Bearing Kit	Volvo C30 1.6 Man., 1.8 Man., 2.0, R-Design, Powershift Man., Geartronic, 2.5i T5, R-Design Man., Geartronic (08-13), C70 2.5T T5 (04-13), S40 1.8 Sedan, 2.0 Sedan, 2.0D VS Sedan D4204T, 2.4 VS D5 Sedan D5252 T16/ D5244 T3, 2.4i B5244S4, 2.5i D5 Sedan Man Geartronic (2004-)
<b>PQ1032</b>	Front Wheel Bearing Kit	Volvo V40 1.6 D2, 1.8 D3, 1.6 T3, T4, 2.0 T5, 2.5 T5 (2012-)
<b>PQ1033</b>	Rear Wheel Bearing Kit	Volvo V40 1.6 D2, 1.8 D3, 1.6 T3, T4, 2.0 T5, 2.5 T5 (2012-)
<b>PQ1034</b>	Front Wheel Bearing Kit	Volvo S60 1.6 T3, T4, 2.0 D3, D4, T5, T6, 2.4 D5, V60 1.6 T3, T4, 2.0 D3, D4, T5, T6, 2.4 D5, 3.0 T6 - AWD (2010-), XC60 2.0T B4204T6 (10-11), 2.0 D3/4 D5204T2/3 (11-14), 2.0 D4 B4204T5/14 (2014-), 2.0 T5 B4204T7/11 (11-14), 2.0 T6 B4204T9 (14-16), 2.4 D5244T14 (09-10), XC60 2.0 T5 B4204T11 (2014-), 2.0 T6 B4204T9 (2015-), 2.4 D5 D5244T10/11/15/20/22, 3.0T B6304T2 (09-10), 3.0 T6 B6304T3/4 - 4X4 (10-14)
<b>PQ1035</b>	Rear Wheel Bearing Kit	Volvo S60 1.6 T3, T4, 2.0 D3, D4, T5, T6, 2.4 D5, V60 1.6 T3, T4, 2.0 D3, D4, T5, T6, 2.4 D5, 3.0 T6 - AWD (2010-)
<b>PQ1036</b>	Rear Wheel Bearing Kit	Volvo V60 2.0 D3, D4, T5, T6, 3.0 T6 AWD (2010-)
<b>PQ1037</b>	Rear Wheel Bearing Kit	Volvo XC60 2.0T 4X2 B4204T6 (10-11), XC60 2.4 D5244T14 - 4X2 (09-10), XC60 D3/4 2.0 D5204T2/3 - 4X2 (11-14), XC60 D4 2.0 B4204T5/14 - 4X2 (2014-), XC60 T5 2.0 B4204T7 - 4X2 (11-14), XC60 T5 2.0 B4204T11 - 4X2 (2014-), XC60 T6 2.0 B4204T9 - 4X2 (14-16)
<b>PQ1038</b>	Rear Wheel Bearing Kit	Volvo XC60 3.0T D5 - 4X4 (09-10)
<b>PQ1039</b>	Front Wheel Bearing Kit	Volvo XC90 2.4 D5 (04-06), 3.2 (07-11), 2.4 D5 D5244T4/5, 2.5T B5254T2, 2.9 T6 B6294T, 4.4 V8 B8444S - 4X4 (03-11), 2.4 D5 D5244T18, 2.5 B5254T2 - 4X4 (07-14)
<b>PQ1040</b>	Front Wheel Bearing Kit	Volvo XC60 XC90 3.2 - 4X4 (07-11), 2.4 D5 D5244T4/5 (04-11), 2.5T B5254T2 (03-11), 2.9 T6 B6294T (03-06), 4.4 V8 B8444S - 4X4 (06-11), 2.4 D5 D5244T18 (11-14), 2.5 B5254T2 (12-14), 3.2 B6324S/5 - 4X4 (07-11)
<b>PQ1041</b>	Rear Wheel Hub Bearing Kit	Citroen Berlingo 1.4 P/van TU3JP Pet., 1.6 TU5JP4B, 1.6HDi 90LS DV6TED4BU, DV6AUTED4, 1.9D LWB P/van XUD9A Dies. (03-15), Picasso 1.6, 1.6HDi, 1.8, 2.0, 2.0HDi (03-05), Xsara 1.6 SX TU5JP, 1.8 Picasso Exclusive, EW7J4, 2.0 Picasso HDi, VTS, Exclusive, HDi Exclusive DW10/TD (03-08)
<b>PQ1042</b>	Rear Wheel Bearing Kit	Citroen Xsara 1.6 SX TU5JP, 1.8 Picasso Exclusive, EW7J4, 2.0 Picasso HDi, VTS, Exclusive, HDi Exclusive DW10/TD (03-08)
<b>PQ1043</b>	Rear Wheel Bearing Kit	Citroen Xsara 1.6 SX TU5JP, 1.8 Picasso Exclusive, EW7J4, 2.0 Picasso HDi, VTS, Exclusive, HDi Exclusive DW10/TD (03-08)
<b>PQ1044</b>	Front Wheel Bearing Kit	Volkswagen UP 1.0 CHYB (2015-)
<b>PQ1045</b>	Rear Wheel Bearing Kit	Volkswagen UP 1.0 CHYB (2015-)
<b>PQ1046</b>	Rear Wheel Bearing Kit	Mazda 6 2.0 Active, Original, Elegant, 2.3 Dynamic Individual, Sporty Lux, 2.3 MPS - AWD, 2.5 Dynamic Activematic, Individual (2008-), CX-7 2.5 (07-12)
<b>PQ1047</b>	Front Wheel Bearing Kit	Mercedes-Benz W166 ML250, ML350, ML500 (2012-)
<b>PQ1048</b>	Rear Wheel Bearing Kit	Mercedes-Benz W166 ML250, ML350, ML500 (2012-)

## BUYERS GUIDE - BEARING KITS

<b>PQ1049</b>	Rear Wheel Bearing Kit	Ford Ranger T6 2.2 D HP, MP, 2.5, 3.2 D Wildtrack, 3.2 TDCi - 4X2, 2.2 D HP, MP, 2.2 D MP, 3.2 D Wildtrack, 3.2 TDCi - 4X4 (2012-)
<b>PQ1050</b>	Rear Wheel Bearing Kit	Honda Ballade 1.5i L15A7 (2011-), Jazz 1.3 i-VTEC LX Man., Auto., 1.4i L13Z1, 1.5 i-VTEC EX L15A (07-15)
<b>PQ1051</b>	Rear Wheel Bearing Kit	Ford Kuga 2.5 Turbo - 4X4 (2011-)
<b>PQ1052</b>	Rear Wheel Bearing Kit	Ford Kuga 1.5 Ecoboost, 1.6 Ecoboost JQMA, JQMB, 1.6 Ecoboost Turbo JTMA, 2.0 Ecoboost, 2.0 TDCi, 2.0 TDCi TXDA, TXMA, 2.5 Turbo - 4X2, 4X4 (2011-), Tourneo / Transit Connect/Grand Connect 1.0 EcoBoost Trend MPV SWB B3GA, 1.5 TDCi Ambiente Dsl P-Van LWB XWGA, 1.6 TDCi EcoBoost LWB T1GA (2013-)
<b>PQ1053</b>	Rear Wheel Bearing Kit	Ford Kuga 1.6 Ecoboost JQMA, JQMB, 1.6 Ecoboost Turbo JTMA, 2.0 Ecoboost, 2.0 TDCi, 2.0 TDCi TXDA, TXMA - 4X2 (2011-)
<b>PQ1054</b>	Front Wheel Bearing Kit	Fiat Stilo 1.6 Active, MultiWagon, 182B6, 1.9 JTD Dynamic, MultiWagon JTD Dynamic 192A1.000, 937A7.000 (03-06)
<b>PQ1055L</b>	Rear Wheel Bearing Kit (LHS)	Nissan Hardbody QW/D22 2.7D TD27i, 3.0 i VG30E, 3.0TD ZD30, 3.2 QD32, 3.3i VG33E (04-10), QW/D22 2.4i KA24E, 2.7 TD27, 3.0 VG30E, 3.0TD ZD30, 3.2, 3.2D QD32, 3.3i VG33 - 4X4 (98-10), NP300 D22 2.0i, S, SE KA20, 2.4i, S/C, D/C Highrider KA24 DE, 2.5TDi, S, SE Highrider YD25, 2.5TDi, S, SE YD25 (2008-), NP300 D22 2.4i, S/C, D/C, Highrider KA24 DE, 2.5TDi, S, SE, Highrider YD25 - 4X4 (2008-)
<b>PQ1055R</b>	Rear Wheel Bearing Kit (LHS)	Nissan Hardbody QW/D22 2.7D TD27i, 3.0 i VG30E, 3.0TD ZD30, 3.2 QD32, 3.3i VG33E (04-10), QW/D22 2.4i KA24E, 2.7 TD27, 3.0 VG30E, 3.0TD ZD30, 3.2, 3.2D QD32, 3.3i VG33 - 4X4 (98-10), NP300 D22 2.0i, S, SE KA20, 2.4i, S/C, D/C Highrider KA24 DE, 2.5TDi, S, SE Highrider YD25, 2.5TDi, S, SE YD25 (2008-), NP300 D22 2.4i, S/C, D/C, Highrider KA24 DE, 2.5TDi, S, SE, Highrider YD25 - 4X4 (2008-)
<b>PQ1056</b>	USE PQ467	Nissan Datsun Go/ Go+ 1.2 HR12DE (2014-)
<b>PQ1057</b>	Front Wheel Bearing Kit	Toyota Land Cruiser Prado 90/95 3.0 1KZ-TE GX, GX TDi S/W Dies., VX S/W Pet., 3.4 V6 GX, VX S/W Pet. 5VZ-FE - 4X4 (97-04)
<b>PQ1058</b>	Front Wheel Bearing Kit	Nissan Murano 3.5 V6 SUV - 4X4 (2007-)
<b>PQ1059</b>	USE PQ807	Nissan Murano 3.5 V6 SUV - 4X4 (2007-)
<b>PQ1060</b>	Rear Wheel Bearing Kit	Kia Soul 1.6 G4FC, 1.6 CRDi D4FB, 2.0 G4KD (2009-)
<b>PQ1061</b>	Front Wheel Bearing Kit	Mazda MX-5 2.0 (05-14)
<b>PQ1062</b>	Front Wheel Bearing Kit	Mazda MX-5 1.6 (90-93), 1.8 16V (01-09)
<b>PQ1063</b>	Rear Wheel Bearing Kit ASB	Honda Civic VIII 1.8i VTEC EXi, LXi, VXi, R18A2, 2.0i VTEC Type R, K20Z4, 2.2CTDi Vxi (07-13)
<b>PQ1064</b>	Rear Wheel Bearing Kit	Nissan Maxima CA33 & QX Series 2.0 VQ20E (96-04)
<b>PQ1065</b>	Rear Wheel Bearing Kit	Audi A1 1.0 25 TFSi DKLA, DLAC, 1.0 30 TFSi DKJA, DKRF, 1.5 35 TFSi DADA, DPCA, 2.0 40 TFSi CZPC, DKZC (2018-), VW Golf VI 1.4TSi Comfortline, Trendline, Highline, 1.6i Comfortline, Trendline, 1.6TDi (09-13), Polo 9N 1.6i Comfortline, SE, Classic Comfortline, Tipt Trendline, Classic Lux BTS/ AFV, BAH, 1.9TDi Highline, Classic Highline, Sportline, ATD/ AXR, 2.0i Highline, Classic Highline BBX (02-10), Polo Vivo 1.4 CLPA, CLPB, 1.6 CLSA (2010-), Polo 6C 1.0TSi CHZB, CHYA, CHYB, 1.2TSi CJZC/ CJZD, 1.4 CDDA/ CGGB/ CLPA, 1.4TDi CUTA/ CYZB, 1.5TDi CWXC, CWXB, 1.6TDi CLSA, 1.8TSi GTI DAJA (2014-)
<b>PQ1066</b>	Front Wheel Bearing Kit	Proton Arena 1.5 GL, GLX (2006-)
<b>PQ1067</b>	Rear Wheel Bearing Kit	Proton Arena 1.5 GL, GLX (2006-)
<b>PQ1068</b>	Front Wheel Bearing Kit	Ford Territory 4.0 GLi Exec. Koln, 4.0ST Turbo - 4X4 (05-10)
<b>PQ1069</b>	Rear Wheel Bearing Kit	Ford Territory 4.0 GLi Exec. Koln, 4.0ST Turbo - 4X4 (05-10)
<b>PQ1070</b>	Front Wheel Bearing Kit	Nissan Hardbody NP300 D22 2.4i, S/C, D/C, Highrider KA24 DE, 2.5TDi, S, SE, Highrider YD25 - 4X4 (2008-)
<b>PQ1071</b>	Front Wheel Bearing Kit	Tata Bolt 1.2T XMS, XT (2015-)
<b>PQ1072</b>	USE PQ880	Tata Bolt 1.2T XMS, XT (2015-)
<b>PQ1073</b>	Rear Wheel Bearing Kit	Suzuki Sx4 2.0i Hatch J2OA, J2OB - 4X4 (10-16)
<b>PQ1074</b>	Rear Wheel Bearing Kit	Isuzu KB250Dc 2.5, KB300TDi 3.0 LX (04-09), KB300TDi 3.0 D-TEQ (07-11)
<b>PQ1075</b>	Front Wheel Bearing Kit	Mazda 3 (BL, BK) 2.3 MPS L6KG (04-14)
<b>PQ1076</b>	Rear Wheel Bearing Kit	Mahindra Scorpio 2.0, 2.2, 2.2 CRDE, 2.5 NEF, 2.6 Turbo, 2.6 TD /CRDE - 4X2, 4X4 (2005-), Scorpio Pick/Up 2.2 CRDE, 2.5, 2.5 TD, 2.5 NEF Tc (2006-)
<b>PQ1077</b>	Rear Wheel Bearing Kit	Mitsubishi Pajero 2.5 DI-D 4D56 (2013-), 3.2 DI-D 4M41, 3.2 DI-DC 4M41, 3.8i V6 6G75 - 4X4 (2007-), Pajero 3.2 DI-D V98 BK Series - 4X4 (10-13)
<b>PQ1078</b>	Front Wheel Kit	Mitsubishi Pajero 3.2 DI-D V98 BK Series - 4X4 (10-13)
<b>PQ1079</b>	Rear Wheel Bearing Kit	Suzuki Sx4 2.0i Hatch J2OA, J2OB - 4X2 (08-14)

## BUYERS GUIDE - BEARING KITS





<b>PQ1080</b>	Rear Wheel Bearing Kit	Nissan NV200 1.5 Dci, 1.6 HR16DE (2013-)
<b>PQ1082</b>	Wheel bearing kit	Toyota Fortuner 2.4GD Raised Body 2GD-FTV, 2.7 VVTi Raised Body 2TR-FE, 2.8GD Raised Body 1GD-FTV - 4X2 (2015-), 2.8GD DSi Raised Body 1GD-FTV, 3.0D-4D 1KD-FTV, 4.0 V6 1GR-FE - 4X4 (2015-), Hilux "Revo" 2.0 VVTi 1TR-FE, 2.4 GD-6 Raised Body 2GD-FTV, 2.7 VVTi Raised Body 2TR-FE, 2.8 GD-6 Raised Body 1GD-FTV, 4.0 V6 Raised Body 1GR-FE - 4X2, 2.4 GD-6 2GD-FTV, 2.8 GD-6 Raised Body 1GD-FTV, 4.0 V6 Raised Body 1GR-FE - 4X4 (2016-)
<b>PQ1085</b>	Front Wheel Bearing Kit	Renault Laguna I 1.6 RT, RTE K4M720, 1.8 RN Estate, Authentique, Expression F4P7 RT B568/-9F3P/-P6, 1.9dCi F9Q716, 2.0 RT Estate, RXE, Expression K4M720/724, N7Q700 (96-07)
<b>PQ1086</b>	Rear Wheel Bearing Kit	Chevrolet Sonic 1.3D, 1.4 Pet. Hatch / Sedan, 1.6 Pet. Hatch / Sedan (11-15)
<b>PQ1087</b>	Front Wheel Kit	Mazda 2 (DL) 1.5, 1.5D (2015-)
<b>PQ1088</b>	Rear Wheel Kit	Mazda 2 (DL) 1.5, 1.5D (2015-)
<b>PQ1089</b>	Rear Wheel Bearing Kit	Honda Accord VIII 2.0i V-Tec R20A3, 2.2 i-D-Tec N22B1/2, 2.4i V-Tec K24Z3 (08-15)
<b>PQ1090</b>	Rear Wheel Bearing Kit	Suzuki Swift 1.2 GA, GL K12M, 1.2 AZG12, 1.4 GL, GLS, SE K14B, 1.4 AZG/AZH, 1.6, i M16A (11-18)
<b>PQ1091</b>	Front Wheel Bearing Kit	Ford Ranger T6 2.2 D HP, MP, 2.5, 3.2 D Wildtrack, 3.2 TDCi - 4X2 (2012-)
<b>PQ1092</b>	Front Wheel Bearing Kit	Peugeot 308 1.6 GTi (10-14)
<b>PQ1093</b>	Rear Wheel Bearing Kit	Peugeot 308 1.6 GTi (10-14)
<b>PQ1094</b>	Rear Wheel Bearing Kit	Peugeot Boxer 350 2.8 8140.43S/F28DTCR (01-08)
<b>PQ1095</b>	Rear Wheel Bearing Kit	Renault Laguna I 1.6 RT, RTE K4M720 (96-07)
<b>PQ1096</b>	Rear Wheel Bearing Kit	Renault Laguna I 1.8 RN, RN Estate, Authentique, Expression F4P7 RT B568/-9F3P/-P6 (96-07)
<b>PQ1097</b>	Front Wheel Bearing Kit	Renault Laguna II 1.8 Authentique, Expression, 1.9dCi, Dynamic, 2.0T Dynamic, Expression, 3.0 Privilege, Initial (01-09)
<b>PQ1098</b>	Rear Wheel Bearing Kit	Renault Laguna II 1.8 Authentique, Expression, 1.9dCi, Dynamic, 2.0T Dynamic, Expression, 3.0 Privilege, Initial (01-09)
<b>PQ1099</b>	Rear Wheel Bearing Kit	Renault Laguna I 2.0 RT, RT Estate, RXE, Expression K4M720/724, N7Q700 (96-07)
<b>PQ1101</b>	Rear Wheel Bearing Kit	Toyota Land Cruiser Prado 90/95 3.0 1KZ-TE GX, GX TDi S/W Dies., VX S/W Pet., 3.4 V6 GX, VX S/W Pet. 5VZ-FE - 4X4 (97-04)
<b>PQ1102</b>	USE PQ1101	
<b>PQ1103</b>	Front Wheel Bearing Kit	Mazda 3 1.6 Original, Active, Dynamic B6ZE, Z6, 2.0 BN Series (04-14), 3 (BM, BN) 1.6 Z6Y1, 2.0 PEY7, PEX2 (2014-), CX-3 2.0 PEX3 (2015-)
<b>PQ1104</b>	Rear Wheel Bearing Kit	Mazda CX-7 2.3 L3-VDT AWD (07-12)
<b>PQ1105</b>	Front Wheel Bearing Kit	Chevrolet Trailblazer 2.5D XLD25, LVN, 2.8D LWH, 3.6 LY7 - 4X2, 4X4 (12-14)
<b>PQ1106</b>	Rear Wheel Bearing Kit	Chevrolet Trailblazer 2.5D XLD25, LVN, 2.8D LWH, 3.6 LY7 - 4X2, 4X4 (12-14)
<b>PQ1107</b>	Front Wheel Bearing Kit	Nissan Navara D40 Series 2.5DCi, LE, SE, XE D/Cab P/up, 4.0i V6, LE D/Cab P/up (05-17), Pathfinder D40/ R51 2.5DCi D/Cab P/up, 3.0DCi V6, 4.0i V6, LE D/Cab P/up - 4X4 (2005-)
<b>PQ1108</b>	Front & Rear Wheel Bearing Kit	Volvo XC90 2.0 D5 D4204T11/14/23, 2.0 T5/6 B4204T23/27 - 4X2, 4X4 (2015-)
<b>PQ1109</b>	Rear Wheel Bearing Kit	Volvo XC90 2.0 D5 D4204T11/14/23, 2.0 T5/6 B4204T23/27 - 4X2 (2015-)
<b>PQ1110</b>	Rear Wheel Bearing Kit	Volvo XC90 2.5T B5254T2 - 4X4 (03-11), XC90 2.4 D5 D5244T18 (11-14), 2.5 B5254T2 (12-14), 3.2 B6324S/5 - 4X4 (07-11)
<b>PQ1111</b>	Rear Wheel Bearing Kit	Mazda CX-3 2.0 PEX3 (2015-)
<b>PQ1112</b>	Rear Wheel Bearing Kit	Kia Soul 1.6 CRDi D4FB (2014-)
<b>PQ1113</b>	Front Wheel Bearing Kit	Alfa Romeo 166 3.0 V6 Distinctive AT. 936A11 (04-06)
<b>PQ1114</b>	Rear Wheel Bearing Kit	Alfa Romeo 166 3.0 V6 Distinctive AT. 936A11 (04-06)
<b>PQ1115</b>	Rear Wheel Bearing Kit	Mitsubishi Asx 2.0 4B11 (2011-)
<b>PQ1116</b>	Front Wheel Bearing Kit	Nissan Qashqai 1.2T HR12DDT, HRA2DDT, 1.6DCi R9M, 1.6T MR16DE (2013-), Renault Kadjar 1.2 Tce H5F408, 1.5dCi K9K, 1.6dCi R9M (2015-)
<b>PQ1117</b>	Rear Wheel Bearing Kit	Nissan Qashqai 1.2T HR12DDT, HRA2DDT, 1.6DCi R9M, 1.6T MR16DE (2013-), Renault Kadjar 1.2 Tce H5F408, 1.5dCi K9K, 1.6dCi R9M (2015-)
<b>PQ1118</b>	Front Wheel Bearing Kit	Renault Kwid 1.0 B4D404 (2015-)
<b>PQ1119</b>	Rear Wheel Bearing Kit	Renault Kwid 1.0 B4D404 (2015-)

## BUYERS GUIDE - BEARING KITS

<b>PQ1120</b>	USE PQ912	BMW 3 Series F30 318i 1.5 F30N B38 320i 2.0 B48, 320d 2.0 N47, 330i 2.0 B48, 340i 3.0 Sport B58 (2015-)
<b>PQ1122</b>	Rear Wheel Hub Bearing Kit	Nissan Sentra 1.6 HR16DE (2013-)
<b>PQ1123</b>	Front Wheel Bearing Kit	Chevrolet Captiva 2.2D LTZ 5-dr Dsl AWD AT., 2.2D LT 5-dr Dsl AT. LNQ, 2.4 LT, LS 5-dr LE5, 3.0 LTZ 5-dr AWD AT. - 4X2, 4X4 (11-17)
<b>PQ1124</b>	Rear Wheel Bearing Kit	Citroen C4 Aircross 1.6 VTi EP6C, 1.6 e-Hdi, 2.0i Aircross 4B11 - 4X4 (10-15)
<b>PQ1125</b>	Front Wheel Bearing Kit	Citroen C4 Picasso 1.6 Hdi, THP, Vti (11-16)
<b>PQ1126</b>	Rear Wheel Bearing Kit	Citroen C4 Picasso 1.6 Hdi, THP, Vti (11-16)
<b>PQ1127</b>	Rear Wheel Bearing Kit	Citroen C4 Picasso 1.6 Hdi, THP, Vti (11-16)
<b>PQ1128</b>	Front Wheel Bearing Kit	BMW 2 Series F45 F45 218i 1.5i B38A15A, 220d 2.0i B47C20A, B47C20B, 220i 2.0i B48A20A, B48A20F (15-18)
<b>PQ1129</b>	Rear Wheel Bearing Kit	BMW 2 Series F45 F45 218i 1.5i B38A15A, 220d 2.0i B47C20A, B47C20B, 220i 2.0i B48A20A, B48A20F (15-18)
<b>PQ1130</b>	Front Wheel Bearing Kit	Toyota C-HR 1.2 T 8NR-FTS (2017-)
<b>PQ1131</b>	Rear Wheel Bearing Kit	Toyota C-HR 1.2 T 8NR-FTS (2017-)
<b>PQ1132L</b>	Front Wheel Bearing Kit	Toyota Yaris 1.5 2NR-FE PET. (2018-)
<b>PQ1132R</b>	Front Wheel Bearing Kit	Toyota Yaris 1.5 2NR-FE PET. (2018-)
<b>PQ1133</b>	Rear Wheel Bearing Kit	Toyota Yaris 1.5 2NR-FE PET. (2018-)
<b>PQ1134</b>	Rear Wheel Bearing Kit	Hyundai 'Bakkie' 2.6i, 2.5 TCI (2006-)
<b>PQ1135</b>	Front Wheel Bearing Kit	Kia K2500i 2.5i D4CB (2013-)
<b>PQ1136</b>	Front Wheel Bearing Kit	Subaru XV 2.0 (2012-), Forester 2.0, 2.5 (2013-)
<b>PQ1137</b>	Rear Wheel Bearing Kit	Subaru XV 2.0 (2012-), Forester 2.0, 2.5 (2013-)
<b>PQ1138</b>	Front Wheel Bearing Kit	Nissan NV200 1.5 Dci, 1.6 HR16DE (2013-)
<b>PQ1139</b>	Rear Wheel Bearing Kit	Suzuki Jimny 1.3i SUV M13A, 1.5 K15B - 4X4 (2014-)
<b>PQ1140</b>	Front Wheel Bearing Kit	Nissan X-Trail T32 1.6 Dci R9M, 2.0 CVT 6 Speed MR20DD - 4X2, T32 1.6 Dci R9M, 2.5 CVT AWD QR25DE - 4X4 (2014-)
<b>PQ1141</b>	Rear Wheel Bearing Kit	Hyundai Accent 1.6 G4FG Pet., Kia Rio IV 1.2 G4LA Pet., 1.4 G4LC Pet. ( 2017-)
<b>PQ1142</b>	Rear Wheel Bearing Kit	Nissan Micra (K14) 0.9 H4B 408, 1.0 HR10DDT (2017-)
<b>PQ1143</b>	Front Wheel Bearing Kit	Hyundai Accent 1.6 G4FG Pet., Kia Rio IV 1.2 G4LA Pet., 1.4 G4LC Pet. ( 2017-)
<b>PQ1144</b>	Rear Wheel Bearing Kit	Honda CR-V IV 2.0 i-VTEC R20A5 (2012-)
<b>PQ1145</b>	Front Wheel Bearing Kit	GWM Steed 3 2.2i S/Cab, D/Cab (10-13)
<b>PQ1146</b>	Front Wheel Bearing Kit	Audi A1 1.0 25 TFSi DKLA, DLAC, 1.0 30 TFSi DKJA, DKRF, 1.5 35 TFSi DADA, DPCA, 2.0 40 TFSi CZPC, DKZC (2018-), VW Polo VI (AW1, BZ1) 1.0 TSi CHZL, DKLA, 1.6 TDi DGTC, DGTD, 2.0 GTi CZPC, DKZC (2016-), T-Cross (C11) 1.0 Tsi CHZL, DKLA, DLAC, DKJA, DKRF (2018-)
<b>PQ1147</b>	Front Wheel Bearing Kit	Renault Kwid 1.0 B4D (2015-)
<b>PQ1148</b>	Rear Wheel Bearing Kit	Renault Kwid 1.0 B4D (2015-)
<b>PQ1149</b>	Rear Wheel Bearing Kit	Honda Jazz IV 1.2 Trend L12B4, 1.5 Elegance L15Z2 (2015-)
<b>PQ1150</b>	Rear Wheel Bearing Kit	Nissan Tiida 1.6 HR16DE (06-13), 1.8 MR18DE (07-11)
<b>PQ1151</b>	Front Wheel Bearing Kit	Ford Tourneo Custom Bus 2.2 TDCi, Transit Custom Bus/Van 2.2 TDCi (12-18)
<b>PQ1152</b>	Rear Wheel Bearing Kit	Ford Tourneo Custom Bus 2.2 TDCi, Transit Custom Bus/Van 2.2 TDCi (12-18)
<b>PQ1153</b>	Rear Wheel Bearing Kit	Hyundai Tucson 1.6 Gdi G4FD, 1.6 T-Gdi G4FJ, 2.0 CRDi D4HA (15-20), Kia Sportage IV (QL, QLE) 1.6 Gdi G4FD, 1.6 TGDI AWD G4FJ, 2.0 G4NA (2015-)
<b>PQ1154</b>	Rear Wheel Bearing Kit	Hyundai Tucson 1.6 T-Gdi AWD G4FJ (15-20), Kia Sportage IV (QL, QLE) 1.6 TGDI G4FJ, 2.0 G4NA, 2.0 CRDi G4HA, 2.4 Gdi G4KJ (2015-)
<b>PQ1155</b>	Rear Wheel Bearing Kit	Honda CR-V IV 2.0 R20A6, R20A9 Pet., 2.0 i-DTEC N22B4 Dies., 2.4 K24Z9 Pet. AWD (2012-)
<b>PQ1156</b>	Rear Wheel Bearing Kit	Suzuki Ertiga 1.4 VVT Pet. K14B, 1.5 VVT Pet. K15B (2012-)
<b>PQ1157</b>	Rear Wheel Bearing Kit	Hyundai Grand i10 III 1.0 Mpi G3LA, G3LD Pet. (2019-), Kia Picanto III (JA) 1.0 G3LA, G3LD Pet., 1.2 G4LA Pet. (2017-)



# BUYERS GUIDE - V-BELT TENSIONERS

	<p style="text-align: center;"><b>VBT001</b></p> <p>Audi A3 (AGN, AGU) 1.8, 1.8T (98-04), S3 1.8T Quattro (01-03), (BLX, BVZ) 2.0 FSi, Sportback (03-08), TT (8N3), Roadster (8N9) (APX, ARX) 1.8T, Quattro (00-07); VW Beetle (APH) 1.8T, (AZJ) 2.0 (00-12), Golf IV (AKL) 1.6, (AGN) 1.8, 1.8T, GTI, (APK) 2.0 (98-04), Golf V (BGU) 1.6, (AXW) 2.0, 2.0 FSi (04-09), Golf VI (CCSA) 1.6 (09-13), Jetta IV (AKL) 1.6, (AGU) 1.8T, (APK) 2.0 (99-06), Passat (BLY) 2.0 FSi, 4-Motion (05-08), Polo Classic (AKL) 1.6 (96-03), Polo GTI (9N) (BBU) 1.8 (06-10), Touran (BGU) 1.6 (07-11), (AXW) 2.0 FSi (04-07)</p>
	<p style="text-align: center;"><b>VBT002</b></p> <p>Audi A3 (AHF, ALH) 1.9 TDi (98-04); VW Golf IV (AHF, ALH) 1.9 TDi Highline, DSL (98-04), Jetta IV 1.9 TDi (98-05)</p>
	<p style="text-align: center;"><b>VBT003</b></p> <p>Audi A4 (B5) (ADR) 1.8, (APU) 1.8T, Quattro (95-01); VW Passat (3B2) (ADR) 1.8, (APU) 1.8T, (3B3) (AWL, AWT) 1.8T, (ALT, AZF, BFF) 2.0 (96-07)</p>
	<p style="text-align: center;"><b>VBT004</b></p> <p>Toyota Auris (4ZZ-FE) (2007-), Corolla (4ZZ-FE) 140i GLE, GLS, (3ZZ-FE) 160i GLE, GLS, GXS, (1ZZ-FE) 180i GLE, GLS, GSX (02-08), Corolla 1.4 Advanced (07-10), Quest (4ZZ-FE) 1.4 VVT-i, (3ZZ-FE) 1.6 VVT-i (2007-), Professional (07-09), Corolla Verso (3ZZ-FE) 1.6 VVT-i, (1ZZ-FE) 1.8 VVT-i (04-05), RunX (4ZZ-FE) 1.4i RT, (3ZZ-FE) 1.6i RS, RT, RX, (1ZZ-FE) 1.8 RSi, RX (03-08), RAV4 II (1ZZ-FE) 1.8 (00-05)</p>



# BUYERS GUIDE - V-BELT TENSIONERS



## VBT005

Toyota Avensis (1AZ-FSE) 2.0, (2AZ-FSE) 2.4 (03-09),  
Camry (1AZ-FE) 2.4 (V3) (ACV30, ACV36) (03-06),  
RAV 4 II (1AZ-FE) 2.0 (A2) 4WD (ACA20, ACA21) (03-06),  
RAV 4 III (1AZ-FE) 2.0 (A3) VVT-i 4WD (ACA30) (2006-)



## VBT006

Toyota Hilux "VIGO" (1TR-FE) 2.0, (2TR-FE) 2.7  
Double Cab P/up (05-09), Quantum (2TR-FE) 2.7 (05-09)



## VBT007

Toyota FJ Cruiser 4.0 4WD (2010-), Fortuner (2TR-FE) 2.7, 4WD,  
(1GR-FE) 4.0, 4WD (06-09), Hilux "VIGO" (1TR-FE) 2.0 Pickup (2005-  
) , (2TR-FE) 2.7, 4WD (05-09), (1GR-FE) 4.0, 4WD (04-09), Land  
Cruiser Prado (1GR-FE) 4.0 (J12) (GRJ12) (02-04), (GRJ125) (03-09),  
V6 VVTi (GRJ150) (09-13),  
Quantum (2TR-FE) 2.7 V, V-Box, VVTi (05-09)  
**(Pulley Only)**

ID: 17.0mm OD: 70.0mm W: 33.5mm



## VBT008

Toyota Avanza (SX) (K3-VE) 1.3 (07-09);  
Daihatsu Sirion (K3-VE) 1.3, 4WD (2005-),  
Terios (J1) (K3-VE) 1.3 (2002-)  
**(Pulley Only)**

ID: 10.0mm OD: 88.0mm W: 21.0mm

# BUYERS GUIDE - V-BELT TENSIONERS

	<p style="text-align: center;"><b>VBT009</b></p> <p>Toyota Fortuner (N5, N6) (1/2KD-FTV) 2.5 D-4D 4WD (11-14), (1KD-FTV) 3.0D, 4WD (06-09), 3.0 D-4D (2015-), Hilux "VIGO" (2KD-FTV) Pickup 2.5D, D-4D (N1, N2, N3) 4WD (KUN25) (2005-), (1KD-FTV) 3.0, D-4D (KUN16/26/36) (2005-), Quantum (2KD-FTV) 2.5 D-4D V, V Box (TRH2, KDH2) (06-09)</p>
	<p style="text-align: center;"><b>VBT010</b></p> <p>Toyota FJ Cruiser 4.0 4X4, Sport (11-13), Fortuner (N5, N6) (1GR-FE) 4.0, 4WD (2005-), Hilux "VIGO" (1GR-FE) Raider D-Cab Pickup 4.0 (1GR-FE) (05-09), Land Cruiser Pickup (1GR-FE) 4.0 4X4 Single Cab J7 (09-12)</p>
 <p style="margin-top: 10px;">ID: 10.0mm    OD: 70.0mm    W: 32.0mm</p>	<p style="text-align: center;"><b>VBT011 (LOOSE BEARING - 6302RMX)</b></p> <p style="text-align: center;">Toyota Hilux "VIGO" 2.7i (2005-), Quantum 2.7i (2005-) <b>(Double Bearing Tensioner)</b></p>
	<p style="text-align: center;"><b>VBT012</b></p> <p>Audi A1 (CAXA) 1.4, T, FSi, TFSi, Sportback (11-14), A3 (CMSA) 1.4T, FSi, Sportback (08-13); VW Golf VI (CAXA) 1.4 TSi (09-13), Jetta V (1K2) (CAXA) 1.4 TSi (07-10), Jetta VI 1.4 TSi (11-14), Polo (9N) (BTS) 1.6 16V (02-10), Polo 6R/6C (CDDA, CGGB, CLPA) 1.4, (CLSA) 1.6 (09-14), Polo (CLSA) 1.6 (10-15), Tiguan (CAXA) 1.4 TSi (2011-)</p>

# BUYERS GUIDE - V-BELT TENSIONERS



## VBT013

Nissan NP200 (K7M) 1.6 (2008-);  
 Renault Clio II (K4J/KJ7/E7J634) 1.4, (K4M) 1.6, (F4R) 2.0 (99-03),  
 Kangoo (E7J780) 1.4 (03-10), Laguna (K4M) 1.6,  
 (F4P7) 1.8, (F4R) 2.0 (96-07), Logan (K4M/K7M) 1.6  
 (2004-), Megane I (K4M/K7M) 1.6 16V, (F5R 740) 2.0 16V  
 (96-02), Sandero (K7J7) 1.4, (K7M) 1.6 (2009-), Scenic I (E7J) 1.4,  
 (K4M/K7M) 1.6, (F4R) 2.0 (98-03)



## VBT014

Nissan NP200 (K9K) 1.5dCi (2008-), Juke (K9K)  
 1.5dCi (2013-), Qashqai (K9K) 1.5dCi (2010-);  
 Renault Megane I (K9K) 1.5dCi (02-10)



## VBT015

Toyota Auris (1AD-FTV) 2.0 D-4D (2007-), Avensis (T25)  
 (1AD-FTV) 2.0 D-4D, (2AD-FTV) 2.2 D-4D (06-08),  
 Corolla Quest (1AD-FTV) 2.0 D-4D (2007-), Corolla Verso (2AD-FHV,  
 2AD-FTV) 2.2 D-4D (05-10), (1AD-FTV) 2.0 D-4D (2009-), RAV4 III  
 (2AD-FHV, 2AD-FTV) 2.2D, 4WD (08-13), RAV4 IV (1AD-FTV) 2.0D,  
 (2AD-FHV, 2AD-FTV) 2.2 D-4D (2012-)



## VBT016

Toyota Avanza (3SZ-VE) 1.5 (2007-);  
 Daihatsu Materia (3SZ-VE) 1.5 (2007-),  
 Sirion (3SZ-VE) 1.5, 4X4 (2007-)  
**(Idler Only)**

ID: 10.0mm    OD: 85.0mm    W: 30.0mm

## BUYERS GUIDE - V-BELT TENSIONERS

	<p style="text-align: center;"><b>VBT017</b></p> <p>BMW 3-Series (E36) (M50) 320i, (M52) 323i, (M50) 325i, Coupe, Convertible, (M52) 328i, Coupe, Convertible (92-99), (E46) (M54) 320i, 320Ci, (M52) 323i, (M54) 325i, 325Ci, 325ti Compact, (M52) 328i, 328Ci (98-05), 5-Series (E34) (M50) 520i, (M50) 525i (90-96), (E39) (M52) 523i, (M54) 525i, (M52) 528i (98-05), (E60) (M54) 525i, (M54) 530i (04-07)</p>
	<p style="text-align: center;"><b>VBT018</b></p> <p>BMW 1-Series (E81/87) (N45) 116i, (N46) 118i, (N46) 120i (04-11), 3-Series (E90) (N46) 320i (05-11); (E91/E92) 320i (05-11)</p>
	<p style="text-align: center;"><b>VBT019</b></p> <p>BMW 1-Series (E81 / E87) (M47 / N47) 120d (04-11), 3-Series (E90) (N47) 320d, (N57) 330d (2007-), 5-Series (F07) (N57) 530d (2011-), X1 (E84) (N47) 2.0d, 2.3d (2009-), X5 (E70) (N57) 3.0d, 4.0d (2009-)</p>
	<p style="text-align: center;"><b>VBT020</b></p> <p>BMW 1-Series (E87) (M47 / N47) 120d (04-11), 3-Series (E90) (M57) 325d, (M57 / N57) 330d (06-11)</p>

## BUYERS GUIDE - V-BELT TENSIONERS

	<p style="text-align: center;"><b>VBT021</b></p> <p style="text-align: center;">Nissan Navara (D40) (YD25DDTi) 2.5dCi (2005-), Pathfinder (D40) (YD25DDTi) 2.5dCi (2005-)</p>
	<p style="text-align: center;"><b>VBT022</b></p> <p style="text-align: center;">Nissan NP200 (K7M) 1.6 (2008-); Renault Clio II (K4J/KJ7) 1.4, (K4M) 1.6, (F4R) 2.0 (99-03), Kangoo (E7J780) 1.4 (03-10); Laguna (K4M) 1.6 (06-07), Logan (K4M/K7M) 1.6 (2004-), Megane I (K4M/K7M) 1.6 16V (96- 02), Sandero (K7J) 1.4, (K7M) 1.6 (2009-), Scenic I (E7J) 1.4, (K4M/ K7M) 1.6 (98- 02) <b>(For Vehicles Without Air Conditioning)</b></p>
	<p style="text-align: center;"><b>VBT023</b></p> <p style="text-align: center;">Ford Ranger (T6) (PF2K, QJ2K) 2.2 TDCi, (SA2K) 3.2TDCi (2012-); Mazda BT-50 (PF2K, QJ2K) 2.2 TDCi, (SA2K) 3.2TDCi (2012-)</p>
	<p style="text-align: center;"><b>VBT024</b></p> <p style="text-align: center;">Ford Ranger (T6) (PF2K, QJ2K) 2.2 TDCi, (SA2K) 3.2TDCi (2012-); Mazda BT-50 (PF2K, QJ2K) 2.2 TDCi, (SA2K) 3.2TDCi (2012-) <b>(Pulley Only)</b></p>



# BUYERS GUIDE - V-BELT TENSIONERS

	<p style="text-align: center;"><b>VBT025</b></p> <p>Honda Ballade (L15A7) 1.5 (2011-), Brio (L12B1/L12B3) 1.2 (2011-), Jazz (L15A3/L15A7) 1.5 (2009-)</p>
 <p>ID: 10.0mm    OD: 70.0mm    W: 36.0mm</p>	<p style="text-align: center;"><b>VBT026</b></p> <p>Nissan Juke (HR16DE) 1.6, 1.6 DIG-T (2010-), Livina (HR16DE) 1.6 (2008-), Micra III (K13) (HR12DE) 1.2 (2004-), (HR15DE) 1.5 (2010-), NV200 (HR16DE) 1.6 (2013-), Qashqai I &amp; II (HR16DE) 1.6 (07-13), Tiida (HR16DE) 1.6 Visia, 1.6 Acenta (06-13) <b>(Pulley Only)</b></p>
 <p>ID: 10.0mm    OD: 70.0mm    W: 33.0mm</p>	<p style="text-align: center;"><b>VBT026I</b></p> <p>Nissan Juke (HR16DE) 1.6, 1.6 DIG-T (2010-), Livina (HR16DE) 1.6 (2008-), Micra III (K13) (HR12DE) 1.2 (2004-), (HR15DE) 1.5 (2010-), NV200 (HR16DE) 1.6 (2013-), Qashqai I &amp; II (HR16DE) 1.6 (07-13), Tiida (HR16DE) 1.6 Visia, 1.6 Acenta (06-13) <b>(Idler Only)</b></p>
	<p style="text-align: center;"><b>VBT027</b></p> <p>BMW 1-Series (F20/F21) (N47) 120d (2011-), 3-Series (E90) (N47) 320d (Vehicles with Electric P/S), (E91) (N47) 320d (Vehicles with Electric P/S) (07-11), 5-Series (F07) (N47N) 520d GT, (N47N) 535d GT (2010-), (F10) (N57Z) 520d, (N57Z) 535d (2010-), X1 (E84) (N47D20) sDrive 16d, sDrive 20d (10-15)</p>

# BUYERS GUIDE - V-BELT TENSIONERS

## VBT028



Toyota Auris (1NR-FE) 1.3 (09-12),  
Corolla Professional (1NR-FE) 1.3 (2008-)

## VBT029



Audi A1 (CBZA) 1.2 TFSi, (CAXA) 1.4 TFSi, Sportback (11-14), A3 (CAXC, CMSA) 1.4 TFSi, Sportback (08-13); VW Golf V (BLP) 1.6 FSi (05-09), Golf VI (CAXA) 1.4 TSi (09-13), Jetta VI (CAXA) 1.4 TSi, (CLRA) 1.6 (11-14), Polo (9N) (BTS) 1.6 (06-09), Polo Vivo (CLPA) 1.4, (CLSA) 1.6 (2010-), Polo 6R/6C (CDDA, CGGB, CLPA) 1.4 (11-14)  
**(For Vehicles With Air Conditioning)**

## VBT031



Ford B-Max (M1JE) 1.0 EcoBoost (2012-),  
Focus III (M1DA, M1DC) 1.0 EcoBoost (2012-),  
Tourneo / Transit (B3GA, M2GA) 1.0 EcoBoost (2013-)

## VBT032



Audi A1 (8XK/1) (CHZB, DKLD) 1.0 TFSi, Sportback, (CZCA, CZDD) 1.4 TFSi, Sportback (2014-), A3 (8VK/1) (CHZD) 1.0 TFSi, Sportback, (CJZA, CYVB) 1.2 TFSi, Sportback, (CMBA, CXSA/B, CZCA, CPTA) 1.4 TFSi, Sportback (2013-), A4 (B9) (CVNA) 1.4 TFSi (2015-), Q2 (GAB) (CHZJ) 1.0 TFSi, (CZEA) 1.4 TFSi (2016-); VW Beetle (5C1/2) (CYVD) 1.2 TSi 16V, (CZDA) 1.4 TSi (2014-), Caddy (SAA/H) (CHZG, DKRE) 1.0 TSi (2015-), Golf VI Convertible (517) (CXSB, CZC/DA, CHPB) 1.4 TSi (2013-), Golf VII (5G1) (CMBA, CXSA, CZC/DA, CHPB, CZEA) 1.4 TSi (2016-), Jetta VI (162/3) (CZC/DA, CZTA) 1.4 TSi (2014-), Polo (6R1, 6C1) (CHZB/C) 1.0 TSi, (CJZC/D) 1.2 TSi, (CPTA, CZEA) 1.4 TSi (2014-), Polo (AW1, BZ1) (CHZJ, DKJA, DKRF) 1.0 TSi (2017-), Tiguan (AD1) (CZC/DA, CZEA, DJVA) 1.4 TSi, All-Space (BW2) (CZDA, CZEA) 1.4 TSi (2016-)

# BUYERS GUIDE - V-BELT TENSIONERS

	<b>VBT033</b>
	Chevrolet Utility (LQ5) 1.4, (LJ1) 1.8 (2012-)
	<b>VBT034</b>
	Toyota Corolla (E180) (1ND-FTV) 1.4D Esteem, Prestige (14-19)

Notes:





From humble beginnings to present day, delivering quality guaranteed auto parts at superior levels of service for more than 40 years.



## Guaranteed for your safety and reliability

### Johannesburg

Tel: 011 634 7600  
Fax: 011 493 3132  
61 Trump Street  
Selby  
Johannesburg  
2091  
P O Box 260642  
Excom 2023

### Durban

Tel: 031 531 6000  
Fax: 031 531 6210  
33 Aloefield Crecent  
Springfield Park  
Durban North  
4051  
P O Box 309  
Durban 4000

### Cape Town

Tel: 021 928 3420  
Fax: 021 931 0840  
Unit 16, Dundas Park  
23b Junction Street  
Parow Industria  
P O Box 688  
Maitland 7404